

TA

681

A75

UC-NRLF



\$B 76 280

YC 66712

LIBRARY
OF THE
UNIVERSITY OF CALIFORNIA.

GIFT OF

Atlas Portland cement co.

Class

Alte 31 1906

CONCRETE CONSTRUCTION

ABOUT THE HOME
AND ON THE FARM

PUBLISHED BY
THE ATLAS PORTLAND CEMENT CO.

30 BROAD ST. NEW YORK

CONCRETE
CONSTRUCTION
ABOUT THE HOME
AND ON
THE FARM



PUBLISHED BY
THE ATLAS PORTLAND CEMENT COMPANY
30 BROAD STREET
NEW YORK

TA 681
A 75

Wright

Copyright 1905
by
THE ATLAS PORTLAND CEMENT CO.
30 Broad Street. N. Y.

All rights reserved

INDEX.

	PAGE
Foreword.....	5
Concrete Construction (history)....	6
Atlas Portland Cement (development)	8

Specifications for mixing and handling Atlas Portland Cement.

Cement Mortar.....	9
Concrete.....	9
Broken Stone, Gravel and Cinders (aggregate).....	9
Sand.....	10
Cement.....	10
Water.....	11
Proportions.....	11-12
Measuring	13
Mixing.....	13
Forms (molds).....	14
Putting Concrete into Forms.....	15
Reinforced Concrete.....	16
Table for designing Concrete Beams and Slabs.....	18-19
Cost of Concrete Construction.....	20
Table for material for 1 cubic yard of Concrete	22
Freezing.....	22

Specifications for

Circular Forms.....	23
Sidewalks.....	24
Curbs and Gutters.....	27
Floors.....	28
Cellar.....	28
Barn and Stable.....	30
Feeding	32
Steps and Stairs	32
Flying Steps or Stairs.....	37
Walls.....	38
Foundations (House, Barn).....	43
Piers and Posts.....	44
Windmill Foundations.....	45

SPECIFICATIONS FOR— <i>Continued.</i>	PAGE
Chimney Caps.....	46
Cisterns.....	47
Square Cisterns.....	50
Watering Troughs.....	50
Tanks.....	53
Square, Small.....	54
Round.....	55
Large.....	55
Reinforcement.....	55
Well Curbs.....	56
Horse Block.....	57
Posts.....	
Fence.....	53
Clothes.....	61
Hitching.....	61
Piazza.....	61
Lattice.....	61
Hog Pens.....	63
Hog Troughs.....	65
Chicken House.....	66
Ice House.....	69
Root Cellar.....	70
Mushroom Cellar.....	73
Greenhouses.....	75
Hotbed Frames.....	76
Box Stalls.....	77
Silos.....	78
Culverts.....	83
Table for Coloring Concrete.....	86
Stucco Work.....	
Cement Plastering.....	87
Spatter-dash.....	87
Pebble-dash.....	87
Tools used in mixing and working Concrete.....	91
Description of Building Construction on Gedney Farms White Plains, N. Y., by Edward Burnett and Stanley Cunningham.....	93
Description of buildings on Brookside Farms, Newburg, N. Y., by S. L. Stewart.....	114
Interesting and novel examples of Concrete Construc- tion.....	117-127

FOREWORD.

The development of the American Portland Cement industry during the past decade has been one of the marvels of the age, and while Portland Cement Concrete has come to be recognized as the ideal building material for heavy work, comparatively little attention has been given to its use in the smaller construction about the home and on the farm. That active interest, however, is taken in this important subject by the suburbanite, the villager, and the farmer, is evidenced by the large number of letters of inquiry received by the agricultural and technical journals.

During the past few years the price of lumber has advanced to almost prohibitive figures, and it is therefore only natural that a substitute material which affords the advantages of moderate cost, durability and beauty, should be looked upon with favor.

It is not our purpose to enlarge upon the uses for which Portland Cement is now considered standard, but rather to direct attention to the economy of supplanting wood, brick and cut stone in divers ways by the more durable, sightly, and sanitary Portland Cement construction.

All photographs displayed in this booklet were taken from actual work done with "ATLAS" Portland Cement, and the specifications are those which have been employed in successful construction.

In the following pages we shall endeavor to point out, in language free from technical terms, some of the uses for which Portland Cement Concrete is especially adapted.



CONCRETE CONSTRUCTION.

Concrete construction dates back to the time of the Romans, who secured good results from a mixture of slaked lime, volcanic dust, sand and broken stone. Even this combination, crude in comparison with Portland Cement concrete, produced an artificial stone which has stood the test of nearly two thousand years, as evidenced by many works in Rome which are to-day in a perfect state of preservation.

"Portland Cement" is an invention of modern times—its universal use the matter of a quarter of a century. The honor of its discovery belongs to Joseph Aspdin, of Leeds, England, who took out a patent in 1824 for the manufacture of "Portland Cement," so called because of its resemblance, in color, to a then popular limestone quarried on the Island of Portland. Manufacture was begun in 1825, but progress was slow until about 1850, when, through improved methods and general recognition of its merits as a building material, commercial success was assured. About this time the manufacture of Portland Cement was taken up in earnest by the French and Germans, and, by reason of their more scientific efforts, both the method of manufacture and quality of the finished product were greatly improved. Portland Cement was first brought to the United States in 1865. It was first manufactured in this country in 1872, but not until 1896 did the annual domestic production reach the million-barrel mark.

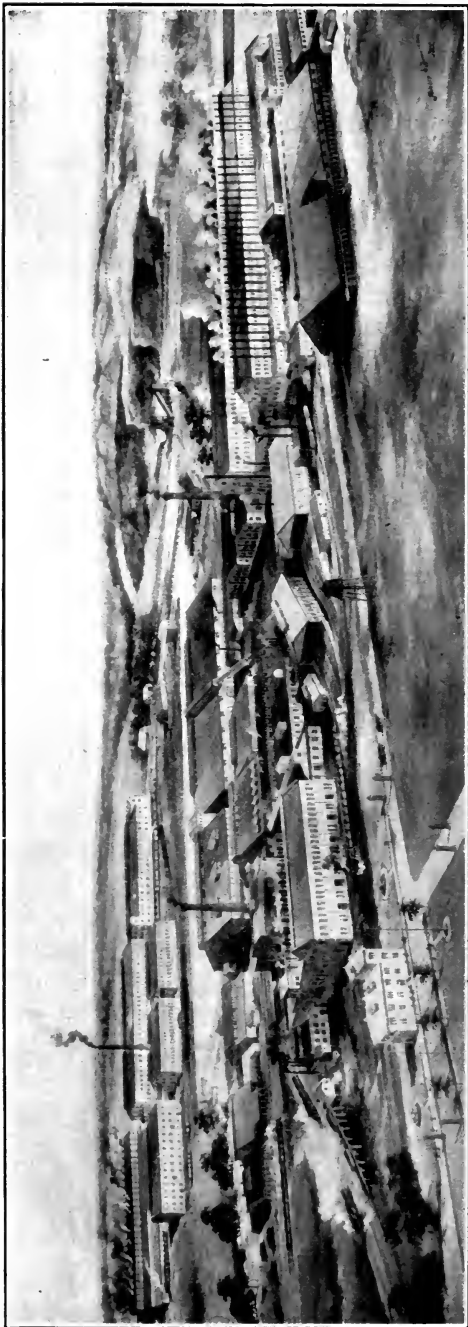

THE ATLAS PORTLAND CEMENT CO. PLANTS Nos. 2, 3 and 4, NORTHAMPTON, PA.

Wonderful as the development of the general industry has been, the growth of the Atlas Portland Cement Company's plants has been even more so. Beginning in 1892 at Coplay, Pa., with the modest capacity of 250 barrels per day, its production has steadily increased through the construction of plants Nos. 2, 3, and 4, at Northampton, Pa., and plants Nos. 5 and 6, at Hannibal, Mo., until now more than 32,000 barrels are manufactured each twenty-four hours, or approximately twelve million barrels per year. This production is greater than the combined capacity of any other four Portland Cement companies in the world. "ATLAS" Portland Cement is manufactured from the finest raw materials, under expert supervision in every department of the works. It is of the highest quality, being guaranteed to pass all usual and customary specifications, such as the specifications of the United States Government and those of the American Society for Testing Materials, which latter specifications have been concurred in by The American Institute of Architects, The American Engineering and Maintenance of Way Association, and The Association of Portland Cement Manufacturers. The quality of eastern and western "ATLAS" is identical. By virtue of its enormous production, The Atlas Portland Cement Company is able to develop and retain in its service the most skilled operating talent in the Portland Cement industry, which insures a thoroughly reliable and uniform product.

"ATLAS" Portland Cement is guaranteed to be
"ALWAYS UNIFORM."

Cement mortar for brick or masonry work, if made in the following proportions, will give a mortar that works greasy under the trowel. Proportions are: One barrel "ATLAS" Portland Cement, four barrels clean sand and two pails of lime putty. Always have your brick thoroughly wet before using.

CEMENT MORTAR

Ideal concrete (artificial stone) is made from a mixture of broken granite, trap rock or clean screened gravel, size varying from a walnut to a hen's egg, clean coarse sand and first-class Portland Cement in such proportions that the voids between the stones will be filled with sand, and the voids between the grains of sand filled with Portland Cement, with Portland Cement slightly in excess of the quantity necessary to fill said voids, in order to furnish additional adhesive properties to thoroughly combine the sand with the broken stone.

CONCRETE

BROKEN STONE, GRAVEL, OR CINDERS form the coarse AGGREGATE, as it is sometimes called. The power of adhesion of a high grade Portland Cement to stone is shown by the fact that when a piece of concrete several months old is broken, the line of fracture usually runs through the stone—therefore, as the ultimate strength of concrete depends largely upon the character of the aggregate, care should be exercised in its selection.

BROKEN STONE, GRAVEL, OR CINDERS

Avoid soft sandstones, soft limestones, soft freestones, slate and shale. Granite, trap, slag, hard limestone or gravel are best. For ordinary construction, gravel is more generally used than any other aggregate, and in some sections is found mixed with sand in nearly correct proportions. The stones in the gravel must be clean, as a coating of clay or loam will prevent the cement from adhering to them.

Cinders, broken hard brick, or terra cotta

BROKEN STONE, GRAVEL, ETC. may be used, but at a sacrifice of strength, which in many cases is permissible. Cinders should be thoroughly screened through a mason's screen to remove the dust.

(Cont'd)

SAND

Sand should be clean and coarse. By clean sand we mean it should be free from clay or loam, as both retard the setting of cement, and, if present in large quantities, destroy its adhesive quality. There are three simple ways of telling whether sand is clean or not:

1.—Rub some between the hands, and if they are badly discolored do not use it.

2.—Drop a handful into a pail of clean water; if the water is clear enough to see the sand at the bottom in two minutes, it is "clean."

3.—Fill a bottle or glass fruit jar one-quarter full of sand, and add clean water until the bottle or jar is three-quarters full. Shake well, and if a layer of mud settles over the sand, do not use it.

If the clay or loam is removed by washing, the sand may be used.

Sand should be coarse. By this we mean that a large proportion of the grains should measure 1-32 to 1-16 inch in diameter, and even if a few of the grains run up to $\frac{1}{8}$ or $\frac{1}{4}$ inch, there is no objection to them. Fine sand, even if clean, makes a poor mortar or concrete, and if its use is unavoidable, an additional proportion of cement must be used with it to thoroughly coat the grains.

CEMENT

Use the best Portland obtainable. Portland Cement is described by the United States Government (Board of Engineers, U. S. A., Professional Papers, No. 28) as follows:

"By a Portland Cement is meant the product obtained from the heating or calcining up to incipient fusion of intimate mixtures, either natural or artificial, of argillaceous with calcareous substances, the calcined product to contain at least 1.7 times as much of lime, by weight, as of the materials which give the lime its hydraulic properties, and to be finely pulverized after said calcination, and thereafter additions or substitutions for the purpose only of regulating certain

properties of technical importance to be allowable to not exceeding two per cent. of the calcined product."

In plain English, "ATLAS" Portland Cement is produced by quarrying, crushing and grinding rock, containing proper ingredients, to an impalpable powder, which powder is conveyed to and fed into rotary kilns, and there burned at a temperature of more than 2,000 degrees Fahrenheit, which burning produces what is known as cement clinker. The clinker, after leaving the kiln, is cooled, crushed and reground to an impalpable powder,* and transferred to storage tanks or stock-houses for seasoning. With the addition of about two per cent. of Plaster of Paris, ground equally fine, to control its setting qualities, the cement becomes a finished product. From the time the rock is taken from the quarry to the placing of the finished product in barrels or bags, all conveying is done by machinery, and in the course of its travels a thorough chemical mixture takes place, it being under absolute control of a corps of experienced chemists day and night. Portland Cement on the job should be stored in a dry place, as dampness is the only element of danger.

"ATLAS" cement is shipped in barrels, cloth and paper bags. The barrels weigh 400 pounds gross, or 380 pounds net. When shipped in bags the weight is 95 pounds per bag, four bags to the barrel.

Water should be clean and free from acid or strong alkalis.

WATER

In estimating, do not make the mistake so often made by the uninitiated, of thinking that six barrels broken stone, three barrels sand, and one barrel cement will make ten barrels concrete. As previously stated, the sand fills the

PROPORTIONS

* We guarantee 95 per cent. to pass through a sieve having 10,000 meshes to the square inch; 80 per cent. through a sieve having 40,000 meshes to the square inch.

THE ATLAS PORTLAND CEMENT COMPANY.

PROPORTIONS
(Cont'd)

voids between the stones, while the cement fills the voids between the grains of sand; therefore the total quantity of concrete will be but slightly in excess of the original quantity of broken stone.

The following quotation from "Concrete, Plain and Reinforced,"* by the well known authorities Taylor & Thompson, is given as a guide to those who wish to construct any building for which specific instructions are not given in the following pages:

"As a rough guide to the selection of materials for various classes of work, we may take four proportions, which differ from each other simply in the relative quantity of cement:

A RICH MIXTURE

"For reinforced engine or machine foundations subject to vibrations; for reinforced floors, beams and columns for heavy loading; tanks and other water-tight work—proportions 1 : 2 : 4, that is, one barrel (4 bags) packed Portland Cement (as it comes from the manufacturer) to 2 barrels (7.6 cubic feet) loose sand, to 4 barrels (15.2 cubic feet) loose gravel or broken stone.

A MEDIUM MIXTURE

"For ordinary machine foundations, thin foundation walls, building walls, arches, ordinary floors, sidewalks and sewers,—proportions 1 : 2½ : 5, that is, 1 barrel (4 bags), packed Portland Cement, to 2½ barrels (9.5 cubic feet) loose sand, to 5 barrels (19 cubic feet) loose gravel or broken stone.

AN ORDINARY MIXTURE

"For heavy walls, retaining walls, piers, and abutments, which are to be subjected to considerable strain,—proportions are 1 : 3 : 6, that is, 1 barrel (4 bags), packed Portland Cement, to 3 barrels (11.4 cubic feet) loose sand, to 6 barrels (22.8 cubic feet) loose gravel or broken stone.

* "Concrete Plain and Reinforced," by Taylor & Thompson; John Wiley & Sons, New York, Publishers.

A LEAN MIXTURE

"For unimportant work in masses where the concrete is subjected to plain compressive strain, as in large foundations supporting a stationary load, or backing for stone masonry,—proportions are 1 : 4 : 8; that is, 1 barrel (4 bags) packed Portland Cement, to 4 barrels (15.2 cubic feet) loose sand, to 8 barrels (30.4 cubic feet) loose gravel or broken stone.

"The above specifications are based upon fair average practice. If the aggregate is carefully graded and the proportions are scientifically fixed, smaller proportions of cement may be used for each class of work."

Too much attention cannot be paid to this important part of concrete making. All parts should be measured. A convenient form of measure for sand and broken stone is a barrel with the bottom out, as it is easily filled, and more easily dumped. A wheelbarrow of known capacity is also a handy unit of measure. Water should be measured by the pail for small jobs.

MEASURING

Concrete should be mixed as near the place it is to be used as practicable, so as to avoid delay in getting it into place. If left standing any length of time, it will set and become useless. To avoid this, mix small batches at a time, using on a small job not more than a half-barrel or two bags of cement to the batch. Should the cement take its initial set, i.e., begin to harden, before being placed in the forms, so that it lumps when retempered, discard it, as the hardening qualities of cement are affected if disturbed after it has begun to set.

Mixing should be done on a flat, water-tight platform in the following manner: Measure the sand and spread it in a layer of even depth. Place the cement on top and turn with shovel at least three times, or until the two are thoroughly mixed, as shown by uniform color. Stone (thoroughly wet) should then

MIXING

MIXING (Cont'd)

be thrown on top of the whole, and turned at least three times, water being added on the second turning, the quantity varying according to the nature of the work. In general, sufficient water should be used to give a "mushy" mixture just too soft to bear the weight of a man when in place. Concrete mixing machines should be used on large jobs as a matter of economy. Water should be added to the mixture of stone, sand and cement, a little at a time, until the proper consistency is reached. A sprinkling pot is handy for adding water, as it does not wash away the cement. Do not use a hose unless you are an experienced hand.

FORMS

Green timber is preferable, for if seasoned, it is likely to swell and warp when brought in contact with moisture from the concrete. Fir, yellow pine, or spruce are suitable. If a smooth surface is desired, the sheathing next to the concrete must be planed. It is usually advisable to grease the inside of forms with soap, linseed oil, or crude oil; otherwise particles of concrete will be detached when the forms are removed, thus giving an unnecessarily rough surface to the face of the concrete. Forms should not be greased when it is intended to plaster the surface of the concrete, but should be thoroughly wet immediately before placing the concrete.

The sheathing, which is usually laid horizontally, may be 1 inch, 1½ inches, or 2 inches thick, the distance apart of the studding being governed by the thickness selected. The studs should not be placed more than 2 feet apart for 1-inch sheathing, nor more than 5 feet apart for 2-inch sheathing. They should be securely braced to withstand the pressure of the soft concrete, also of the ramming and tamping. In building forms, do not drive the nails all the way home. Leave the heads out,

so that it is possible to draw them with a claw hammer. The less hammering done around green concrete the better. Avoid cracks in forms into which the mortar will force itself and form "fins" on the surface of the work.

Forms should be left in place from three to four weeks if there is earth or water pressure against the wall. If, on the other hand, there is no strain upon it, twenty-four hours' setting, or until the concrete will withstand the pressure of the thumb without indentation, is sufficient.

An easy method of preventing the forms from bulging is shown in cut at bottom of page. Two holes are bored in both sides of the form and a wire passed through them and the ends tied together. A piece of wood or large nail is then used to twist the two strands together. The form can thus be drawn together and held securely in place. In removing the forms cut the wire at the sides and trim off even with the wall.

Place concrete in forms in layers of not more than 8 inches deep, and tamp lightly with a rammer, or puddle with a piece of 2-inch x 4-inch joist, until water begins to pool on top and no pockets of stone are left uncovered with mortar. Concrete exposed

**PUTTING INTO
FORMS**

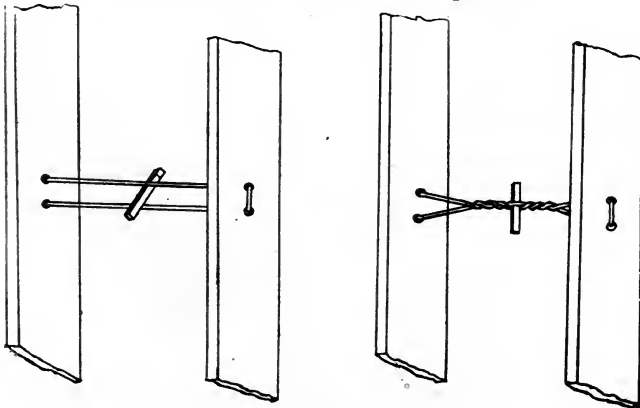

PUTTING INTO FORMS

(Cont'd)

to the sun should be dampened occasionally for two weeks or more at a time when the wall is in a shadow—this will allow the interior of the walls to dry in uniformity with the exterior, thus preventing scaling or cracking.

The method of obtaining a smooth face on concrete frequently adopted is as follows: Thrust a spade or thin paddle between the concrete and the form, moving the handle to and fro, and up and down. This movement forces the broken stone in the concrete away and brings a coating of mortar next to the form, which gives a smooth surface. Care taken in manipulation of concrete along the moulds will be amply repaid by the smooth surface resulting, and the saving in time and expense otherwise made necessary in plastering over cavities and smoothing rough places.

REINFORCED CONCRETE

Reinforced concrete is ordinary concrete in which iron or steel rods or wire are imbedded. Reinforcement is required when the concrete is liable to be pulled or bent, as in beams, floors, posts, walls or tanks, because, while concrete is as strong as stone masonry, neither of these materials has nearly so much strength in tension as in compression. Moreover, concrete alone, like any natural stone, is brittle, but by imbedding in it steel rods or other reinforcement, the cement adheres, and the metal binds the particles together so that the reinforced concrete is better adapted to withstand jar and impact. Even railway bridges are built, not only in arch form, like a stone arch, but in some cases like a steel girder bridge, with a flat reinforced concrete floor supported by horizontal beams of the same material.

For reinforcement, plain round or square rods may be used, or rods with irregular surfaces, many of which are patented, so designed as to adhere more strongly to the concrete in

which they are imbedded. For floor or roof slabs, steel is sometimes formed in sheets like wire lathing, or expanded metal, or woven wire fabric.

An engineer or architect experienced in reinforced concrete design should be employed in preparing the plans for houses, barns, or other large structures, but by carefully following the directions and specifications in this booklet, small reinforced concrete construction may be safely undertaken by the inexperienced. The table which follows gives the thickness and reinforcement of slabs, and the dimensions and reinforcement of reinforced concrete beams for a number of conditions which are liable to be met with in common practice. While the values are as low as should be adopted without knowing the local conditions, complete mathematical calculations of dimensions should be made for large structures, not only from the standpoint of safety, but also because of the saving in cost of material which can be effected by fitting each member in its proper place.

Rules, which are written as foot-notes to the table, give very important directions.

An invariable rule in placing steel is to insert it in the face where the pull will come. Thus, in a beam or slab it must be close to the bottom. In a wall to withstand earth pressure, it must be in the face nearest the earth. If, for example, a beam were designed according to the table, but the steel placed in the middle or top of the beam instead of in the bottom, it would certainly break under a very light load. There must be only enough concrete outside of the steel to protect it from rusting or fire. In floor or roof-slabs of small structures, this thickness should be one-half inch to three-quarters inch below the bottom of the steel, and for beams, from 1 to $1\frac{1}{2}$ inches.

TABLE FOR DESIGNING REINFORCED CONCRETE BEAMS AND SLABS

PROPORTIONS OF CONCRETE 1:2:4. [See important foot-note.]

Length or Span of Beam. Feet	Distance apart of Beams. Feet	Dimension of Beams			Reinforcement of Beams			Thickness of Slabs		Reinforcement of Slabs	
		Width Inches	Depth Inches	Depth below Steel Inches	Number of Rods Required	Diameter of Rods Inches	Diameter Stirrup Rods Inches	Total Thickness Inches	Depth below Steel Inches	Diameter of Rods Inches	Spacing of Rods Inches
<i>Medium Heavy Floor Loading</i>											
8	{	4	13	1 1/2	3	1/2	1/4	2 3/4	3/4	5/16	6
		6	15	1 1/2	3	9/16	5/16	3 3/4	3/4	3/8	6
		8	17	1 1/2	3	5/8	5/16	5	1	1/2	7 1/2
10	{	4	14	1 1/2	3	1/2	5/16	2 3/4	3/4	5/16	6
		6	17	1 1/2	4	9/16	5/16	3 3/4	3/4	3/8	6
		8	20	2	4	5/8	3/8	5	1	1/2	7 1/2
12	{	4	16	1 1/2	4	9/16	5/16	2 3/4	3/4	5/16	6
		6	20	2	4	5/8	3/8	3 3/4	3/4	3/8	6
		8	22	2	4	1 1/16	3/8	5	1	1/2	7 1/2
14	{	4	18	1 1/2	4	5/8	5/16	2 3/4	3/4	5/16	6
		6	24	2	4	3/4	3/8	3 3/4	3/4	3/8	6
		8	24	2	4	1 3/16	3/8	5	1	1/2	7 1/2
<i>Light Floor Loading</i>											
8	{	4	10	1 1/4	3	3/8	1/4	3	3/4	1/4	5 1/2
		6	13	1 1/2	3	7/16	1/4	3 1/2	3/4	5/16	7
		8	13	1 1/2	3	1/2	5/16	4	3/4	3/8	5 1/2
10	{	4	12	1 1/4	3	3/8	1/4	3	3/4	1/4	5 1/2
		6	15	1 1/2	3	9/16	5/16	3 1/2	3/4	5/16	7
		8	16	1 1/2	3	5/8	5/16	4	3/4	3/8	5 1/2

		Roofs										30 Pounds per Square Foot									
12	{	4	7	13	1 1/2	3	1/2	1/4	3	3/4	1/4	3	5 1/2								
		6	8	17	1 1/2	3	5/8	5/16	3 1/2	3/4	5/16	7	5 1/2								
		8	9	18	1 1/2	4	9/16	5/16	4	3/4	3/8	4	5 1/2								
14	{	4	7	15	1 1/2	3	9/16	1/4	3	3/4	1/4	5 1/2									
		6	8	19	2	3	5/8	5/16	3 1/2	3/4	5/16	7	5 1/2								
		8	10	21	2	4	1 1/16	3/8	4	3/4	3/8	4	5 1/2								
8	{	4	5	10	1 1/4	3	3/8	1/4	2 1/4	3/4	3/16	6									
		6	6	11	1 1/4	3	7/16	1/4	3	3/4	1/4	5 1/2									
		8	7	12	1 1/4	3	1/2	5/16	3 1/4	3/4	3/8	7 1/2									
10	{	4	6	12	1 1/4	3	7/16	1/4	2 3/4	3/4	3/16	6									
		6	7	13	1 1/2	3	1/2	1/4	3	3/4	1/4	5 1/2									
		8	8	14	1 1/2	3	9/16	5/16	3 1/4	3/4	3/8	7 1/2									
12	{	4	7	13	1 1/2	3	1/2	1/4	2 1/4	3/4	3/16	6									
		6	7	16	1 1/2	3	9/16	5/16	3	3/4	1/4	5 1/2									
		8	8	17	1 1/2	3	5/8	5/16	3 1/4	3/4	3/8	7 1/2									
14	{	4	7	15	1 1/2	3	9/16	1/4	2 3/4	3/4	3/16	6									
		6	8	17	1 1/2	3	5/8	5/16	3	3/4	1/4	5 1/2									
		8	9	18	1 1/2	3	1 1/16	5/16	3 1/4	3/4	3/8	7 1/2									

1. Bend, diagonally upwards, one rod in three, or two rods in four from 1/3 points in beam to top of beam and over supports. (See Fig. 50.)
 2. Stirrups are made U-shaped with bent ends. (See Fig. 51.)
 3. Use four stirrups in each end of each beam, and place vertically and space by Ransome's rule, viz.:
Place 1st rod distance from end equal to 1/4 depth of beam;
Place 2nd rod distance from 1st equal to 1/2 depth of beam;
Place 3rd rod distance from 2d equal to 3/4 depth of beam;
Place 4th rod distance from 3d equal to full depth of beam.
 4. Slab reinforcement is placed at right angles to supporting beams.
- Cross reinforcement of slightly smaller rods or same rods farther apart is also placed in slabs parallel to beams.
5. Wire fabric or expanded metal mesh may be substituted for rods in the slabs, provided the area of section of metal is kept the same as the rods.
 6. Cinder concrete should not be used for beams.
 7. Cinder concrete may be used for roof slabs.
 8. After setting 30 days, test two of the slabs and one beam by loading two panels with sand to depth of:
18 inches deep for heavy floor loading;
8 inches deep for light floor loading;
5 inches deep for roof loading.



**REINFORCED
CONCRETE**
(Cont'd)

A typical beam with its connecting floor slabs, the concrete of both of which should be laid at the same operation, is shown in Fig. No. 50. It will be seen that the beam reinforcement consists of rods running lengthwise of the beam,—one-half or one-third of these rods being bent up about one-third way from each end and extending over the supports, as shown in Fig. 50,—and U-shaped bars or stirrups, which pass under the longitudinal rods and up on each side of the beam. The horizontal bars withstand the direct pull in the bottom of the beam due to bending when a load is placed upon it; the U-bars or stirrups and the bent-up bars prevent diagonal cracks, which sometimes occur under loading, and the bars passing over the supports prevent the cracking of the beam on top at the ends.

Maximum size of broken stone or gravel should not be over one inch diameter in order to pass between and under the steel rods. Consistency of concrete should be like heavy cream.

**COST OF CON-
CRETE**
U.S.
**OTHER KINDS
OF CONSTRUCTION**

In taking up the question of cost, many things have to be considered. In some sections of the country lumber is scarce and skilled mechanics at a premium, while in other sections timber is comparatively cheap and labor can be had at a nominal figure. It is very difficult, therefore, to give comparative figures. A number of buildings shown herein were originally intended to be built of wood, brick or stone, and the specifications drawn accordingly. The final cost of these buildings when built of concrete was much less than the original estimate, to say nothing of their superior appearance and lasting qualities.

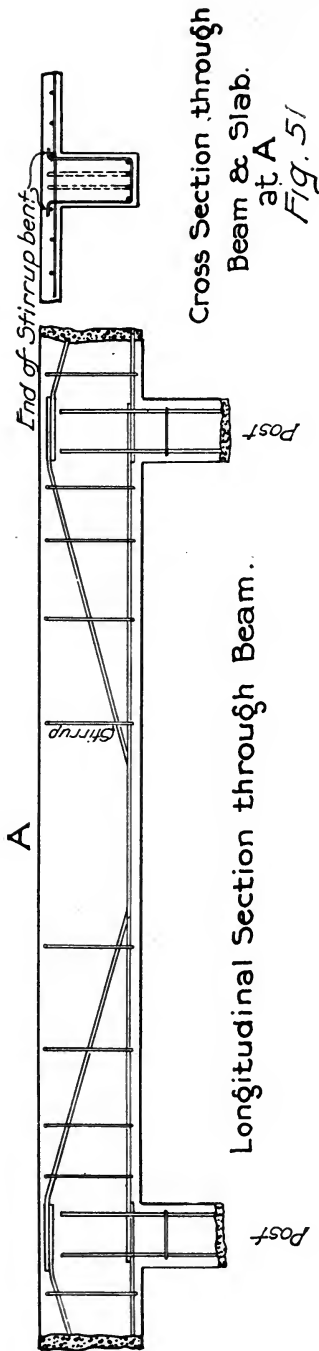

TYPICAL BEAM AND FLOOR SLAB.

Fig. 50

**COST OF CON-
CRETE CON-
STRUCTION**
(Cont'd)

From the table given below the cost of materials for a cubic yard of concrete can be easily figured out.

**MATERIALS FOR ONE CUBIC YARD
OF CONCRETE.**

Proportions	Bbls. Cement in 1 Cubic Yard	Bbls. Sand in 1 Cubic Yard	Bbls. Gravel or Stone in 1 Cubic Yard
1 : 2 : 4	1.57	3.14	6.28
1 : 2½ : 5	1.29	3.23	6.45
1 : 3 : 6	1.10	3.30	6.60
1 : 4 : 8	0.85	3.40	6.80

The cost of labor in concrete construction is small in comparison with other forms of building, as much of the work can be done by unskilled labor under the direction of a skilled foreman.

The lumber for the forms may be used over again, or utilized in building roofs, partitions, etc., as the cement absorbed adds to its strength and durability.

FREEZING

Concrete work should be avoided so far as possible in freezing weather, as the frost will prevent the bonding of different layers, and will cause a thin scale to peel off of the surface of concrete. Salt is frequently used to lower the freezing point of concrete. One method is to add one per cent., by weight, of salt to water used for each degree Fahrenheit below freezing. One cannot tell how low the temperature is going to fall, so ten per cent. by weight, of salt to water or its equivalent, twelve pounds per barrel cement, may be used in the northern portions of the United States.

Another, and perhaps preferable, method is to mix warm sand and stone with the cement and water in such manner as will bring the entire mixture up to about seventy-five degrees Fahrenheit, protecting in the early stages of setting, so far as possible, from cold and currents of air.

In a circular form there are two sides—the inner and the outer—A and B, Fig. No. 20. These may be used together as in building a silo, or, as in a cistern, using the inner form alone; or for a column, using only the outer form. Both sides of the form are made in the same way, but the inner and outer sides cannot be made to the same pattern, as the thickness of the walls comes between the parts, making the radius of each side different.

The simplest way to make a circular form is to draw a circle of the size of the form desired, and lay boards around the circumference of the circle, as shown in Fig. No. 48. These boards should be lightly tacked together in place, and, using the same measure, mark a circle upon them. They should then be knocked apart and sawed out along the lines marked, the pieces being fastened securely together, as shown in Fig. No. 20. After making two or more forms, place them at equal distances apart, and put on the sideboards in the manner shown in Fig. No. 21. These boards are called "Lagging."

A simple method of drawing a large circle is as follows: Take a piece of string, fasten one end in the ground by means of a long nail, marked "A," Fig. No. 48. Measure off one-

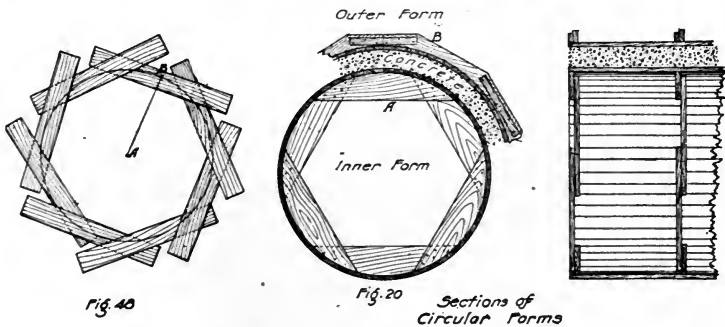

Vertical Section
Fig. 21

half the diameter of the circle desired and tie a knot. Through the knot force a nail (marked "B," Fig. No. 48), and, keeping the string

CIRCULAR FORM

(Cont'd)

stretched taut between these two points, draw a continuous line. After the boards have been put in place as described above, a pencil can be substituted for the nail "B."

A section of a circular form may be figured out from the following formula, should it be more convenient:

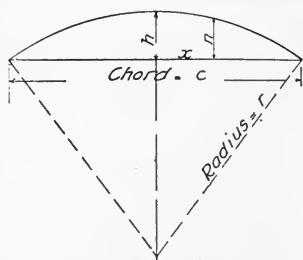

$$c = 2\sqrt{r^2 - (r-h)^2} \quad (1)$$

$$h = r - \sqrt{r^2 - \frac{c^2}{4}} \quad \text{or nearly } \frac{c^2}{8r} \quad (2)$$

$$r = \sqrt{r^2 - x^2} + (r-h) \quad (3)$$

Formula *1 to be used when width of board is given.

" *2 " " " " length " " " " "

SIDEWALKS.

As much care should be taken in laying the foundation as the walk itself. Foundations should generally be 6 inches to 12 inches deep, depending upon the climate and character of the soil. In sections where there is a porous soil and a mild climate, foundations are sometimes omitted entirely. If the soil is clayey, blind drains of coarse gravel or tile pipe should be laid at the lowest points in the excavation, to carry off any water that might accumulate. Walks are frequently ruined by water freezing in the foundations and heaving them out of position.

Excavate to the sub-grade previously determined upon, 3 inches wider on each side than the proposed walk, and fill with broken stone, gravel or cinders to within 4 inches of the proposed finished surface, wetting well and tamping in layers, so that when complete it will be even and firm, but porous. Place 2-inch x 4-inch scantlings (preferably dressed on inside and edge and perfectly straight) on top of the cinder foundation, the proper distance apart to form the inner and outer edges of the walk. The outside or curb strips must be 1 inch to 2 inches lower than the inner edge of the walk. This will give a slight incline to the finished surface, and allow the water to run off. A good rule to follow is to allow $\frac{1}{4}$ -inch slope to every foot of width of walk. For wide walks lay off

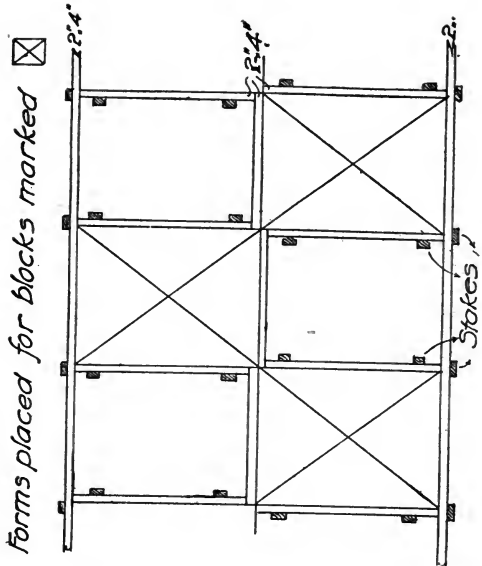
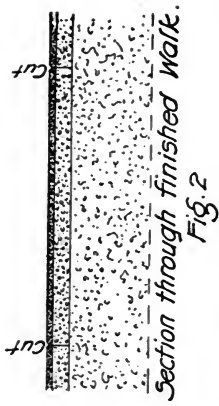

Fig. 1.

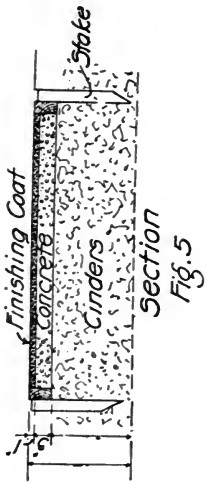

Fig. 5

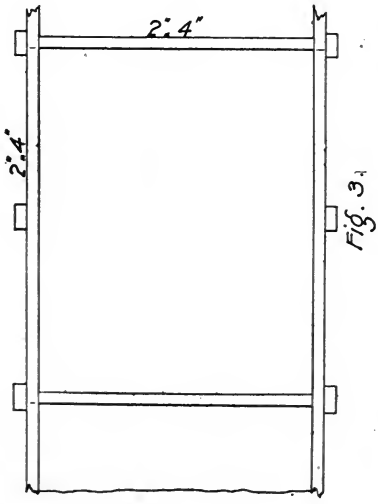

Fig. 3

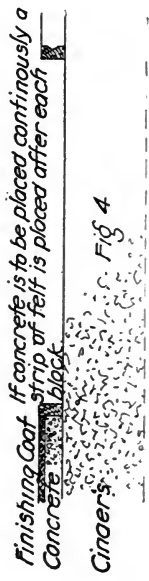

Fig. 4

the space between the scantlings into equal sections not larger than 6 feet square, put 2-inch x 4-inch scantlings crosswise and in the center, as shown in Fig. No. 1—this will make every alternate space, shown in figure by *diagonal line*, the size desired. Fill these spaces with concrete to a depth of 3 inches (this depth should be 4 inches where there is more than ordinary traffic, or where the blocks are 6 feet square)—one part “ATLAS” Portland Cement, two parts clean coarse sand, and four to five parts broken stone or screened gravel, then tamp until water begins to show on top. On the same day, as soon as the concrete has set, remove crosswise and center scantlings, place a sheet of tar paper on the edges to separate them from all other squares (Fig. No. 1), and fill in the spaces thus left with 3-inch concrete as before. Mark the scantling to show where the joints come.

The finishing coat should be 1 inch thick, of one part “ATLAS” Portland Cement and one and one-half parts clean, coarse sand or crushed stone screenings. This coat should be spread on before the concrete has taken its set, and smoothed off with a screed or straight edge run over the 2 x 4 scantlings, the object being to thoroughly bond the finishing coat to the concrete base. If the bond between the finishing coat and the concrete is imperfect, the walk gives a hollow sound under the feet, and is liable to crack after having been down one or two years. Smooth with a wooden float, and groove exactly over the joints between the concrete (Fig. No. 2), so as to bevel the edges of all blocks. Do not trowel the finishing coat too much, nor until it has begun to stiffen, as this tends to separate the cement from the sand, producing hair cracks, and giving a poor wearing surface. Keep the finished walks protected from dust, dirt, currents of air, and the hot sun during the process of setting, and further protect from the sun and traffic for three or four days, and keep moist by sprinkling. The covering may be whatever is most convenient—sand, straw, sawdust, grass, or boards.

Most walks are made the width of a single block, and should be constructed as shown in Fig. No. 3. In a walk the width of a single block, make every alternate block and then go back and fill in the blocks between. Fig. No. 4 shows cross section of same, and Fig. No. 5 is a lengthwise sectional view.

CURB AND GUTTER.

The foundation for curbs and gutters, like sidewalks, should be governed by the soil and climate.

Concrete curbing should be built in advance of the walk in sectional pieces 6 feet to 8 feet long, and separated from each other and from the walk by tar paper or a cut joint, in the same manner as the walk is divided into blocks.

Curbs should be 4 inches to 7 inches wide at the top and 5 inches to 8 inches at the bottom, with a face 6 inches to 7 inches above the gutter. The curb should stand on a concrete base 5 inches to 8 inches thick, which in turn should have a sub-base of porous material at least 12 inches thick. The gutter should be 16 inches to 20 inches broad, and 6 inches to 9 inches thick, and should also have a porous foundation at least 12 inches thick.

Keeping the above dimensions in mind, excavate a trench the combined width of the gutter and curb and put in the sub-base of porous material. On top of this, place forms and fill with a layer of concrete, one part "ATLAS" Portland Cement, three parts clean, coarse sand and six parts broken stone, thick enough to fill the forms to about 3 inches below the street level. As soon as the concrete is sufficiently set to withstand pressure, place forms for the curb, and after carefully cleaning the concrete between the forms and thoroughly wetting, fill with concrete, one part "ATLAS" Portland Cement, two and one-half parts clean, coarse sand and five parts broken stone. When the curb has sufficiently set to withstand its own weight without bulging, remove the $\frac{3}{4}$ -inch board shown in Fig. No. 6, and with the aid of a trowel fill in the space between the concrete and the form with cement mortar, one part "ATLAS" Portland Cement and one part clean, coarse sand. The finishing coat at the top of the curb should be put on at the same time. Trowel thoroughly and smooth with a wooden float, removing face form the following day. Sprinkle often and protect from sun.

In making curbs alone, specifications on following page and illustrated in sectional drawing should be followed.

Excavate 32 inches below the level of the curb and fill with cinders, broken stone, gravel, or broken brick to depth of 12 inches. Build a foundation 8 inches deep by 12 inches broad, one part "ATLAS" Portland Cement, three parts clean, coarse

sand and six parts broken stone, and from the top of this and nearly flush with the rear, build a concrete wall $11\frac{1}{4}$ inches high, $7\frac{1}{4}$ inches broad at the base and $6\frac{1}{4}$ inches at the top, the 1-inch slope to be on the face. Forms should be built as in Fig. No. 6.

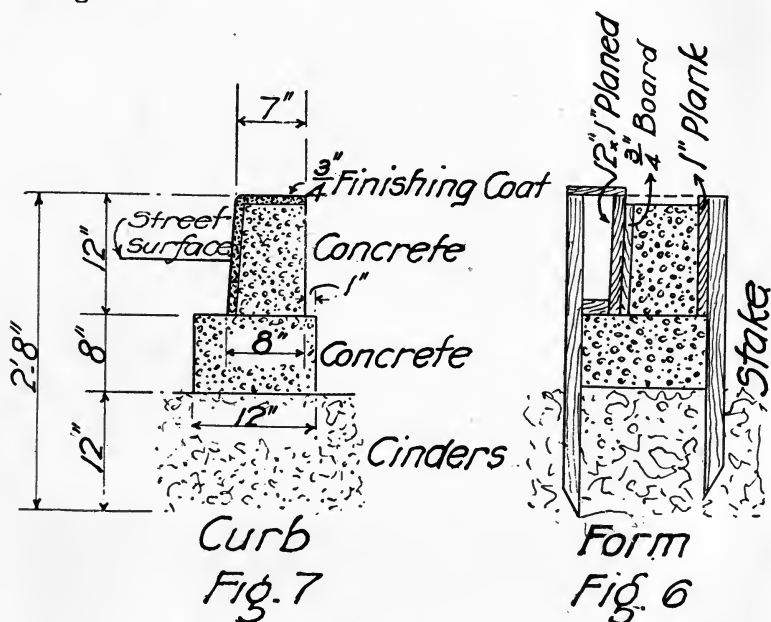

Remove the forms as soon as the concrete will withstand its own weight without bulging, and proceed as per directions given on preceding page (Fig. No. 7). Keep moist for several days and protect from the sun. The above measurements may be varied to suit local conditions.

FLOORS.

CELLAR FLOORS.

Cellar floors may be laid without foundations, except in places where there is danger of frost getting into the ground below the floor. The dirt should be evened off and tamped hard, and the concrete, one part "ATLAS" Portland Cement, two and one-half parts clean, coarse sand and five parts broken stone, spread over the surface in one continuous slab 3 inches to 4 inches thick and lightly tamped to bring the water to the surface, and screeded with a straight edge resting



Photo No. 231.

COW BARN, WASCO, ILL.

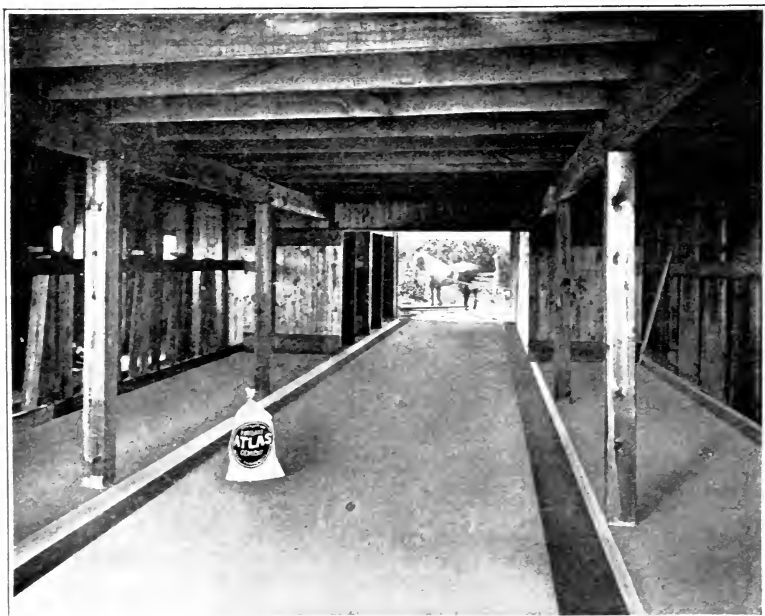

Photo No. 229.

CONCRETE FLOOR IN COW STABLE, ST. CHARLES, ILL.

upon scantlings placed about 12 feet apart. The scantlings are then withdrawn and their places filled with concrete. No finishing coat is needed unless the floor is to have excessive wear. The surface of the concrete, however, should be troweled as soon as it has begun to stiffen. Joints about 12 feet apart should be made if the surface is more than 50 feet long, or if it is to be subjected to extreme temperatures.

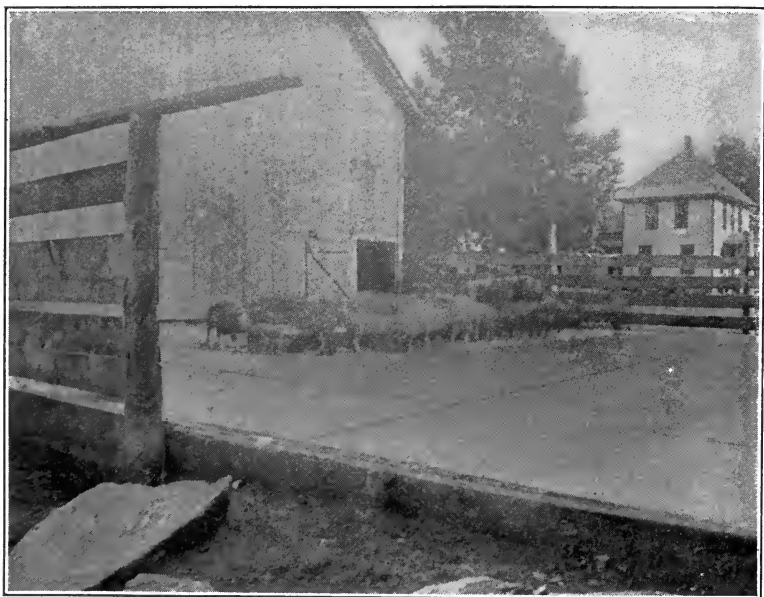

Photo No. 228.

FEEDING FLOOR, KLEMME, IA.

BARN AND STABLE FLOORS.

Barn floors should be laid in the same manner as sidewalks. The thickness of the porous sub-base should be 6 inches to 12 inches, the base 3 inches to 5 inches, finishing with a surface of mortar, one part "ATLAS" Portland Cement and one and one-half parts clean, coarse sand, 1 inch to 1½ inches thick. This may be roughed at time of laying and before it has set, or grooved in blocks about 6 inches square, to prevent the animals slipping. The surface should have sufficient slope to carry liquids to drains placed at convenient intervals. These drains may be either gutters or pipes laid under the floor leading to manure pit. If pipes are used, they should be laid



Photo No. 265.

INTERIOR COW BARN, BABYLON, L. I.

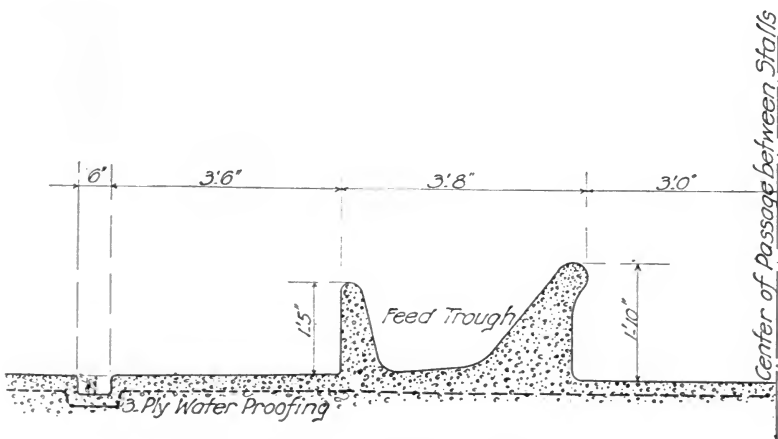

Section of Cow Stable Floor.

Fig. 41



in the sub-base and the joints put together with cement mortar, care being taken to give the pipes enough slope to flush properly. The lids of the drain should be sunk about $\frac{1}{4}$ inch below the level of the floor, and should be loose, so that they can be removed conveniently.

Driveways are made by dividing into 6-inch squares to give foothold.

FEEDING FLOORS.

The immense advantage of concrete feeding floors over the old method of placing fodder on the ground is apparent to all who have given the subject any thought.

Feeding floors should be built the same as sidewalks (see Walks). The finishing coat is optional, although it has the advantage of being much easier to keep clean. Many farmers prefer an unfinished surface on account of its giving cattle a firmer footing in slippery weather.

STEPS AND STAIRS.

Steps and stairs are of two kinds, those made in one piece, monolithic, and those cast in separate moulds and put into place. There are numerous ways of arriving at the same end, and each man in charge of such work must use his ingenuity in the use of the materials at hand, and adopt the method best suited to his requirements. Specifications are given for four ways of making steps and stairs, all of which have proved successful.

The rises on all steps and stairs should not be less than 6 inches nor more than 8 inches, while the tread should be from 10 inches to 14 inches, except where it is intended that more than one step should be taken on the tread, in which case 30 inches should be the minimum width.

Foundations for all steps out of doors should extend below frost line, or have a porous base with a drain situated at the lowest point to allow the water to run off. Steps should be wider than the walk or opening from which they lead, to avoid looking cramped, and, in order to secure an artistic effect, should have some sort of projection, or moulding, at the upper edge. A slight slope to allow the water to run off is also desirable.

All steps and stairs cast separately should be reinforced by iron bars placed about one inch in from the bottom of step,

and flying steps and stairs (stairs having no supports underneath) should be well reinforced as described below.

Let us first consider steps to areas or terraced grounds. Excavate on the slope to the desired depth (see Foundations for Sidewalks) and put in porous foundation with a drain at the lower end to dispose of any water that might accumulate.



Photo No. 323.

STEPS LEADING TO GREENHOUSE, U. S. SOLDIERS' HOME, WASHINGTON, D. C.

Place a plank along each side of the proposed steps, broad enough to house the rise of each step, and brace well. Lay a strip of woven wire fabric, or other reinforcing mesh, of a width nearly corresponding to the width of the steps and the full length of the steps on the slope. Then spread upon this metal a layer of concrete about 3 inches thick, in proportions one part "ATLAS" Portland Cement, three parts clean, coarse sand, and six parts broken stone or gravel, mixed with suffi-

cient water so that it will work through the mesh of the wire cloth and completely surround the metal. After setting 24 hours, start at the top and place boards between the housings to form the rise of each step. These boards should each have a groove at the top to form the projection or moulding above mentioned at the top of each step, and should be firmly fastened to the housings. After wetting the concrete base, fill the top form thus made with mortar, one part "ATLAS" Port-



Photo No. 196.

CELLAR STEPS AND ICE BOX, W. N. WIGHT, WESTWOOD, N. J.

land Cement and one and one-half parts clean, coarse sand, wet until of consistency of jelly, tamp solid and smooth with a wooden float. Continue with the next step below. A saving in material may be made by building the steps of one part "ATLAS" Portland Cement, three parts clean, coarse sand and six parts broken stone, and, before the concrete has set,

coating them $\frac{1}{4}$ inch deep with mortar, one part "ATLAS" Portland Cement and one and one-half parts clean, coarse sand, but unless this is done by skilled workmen it is apt to crack.

Porch steps, etc., can be built as follows: Build two 8-inch walls to a depth below frost, the upper surface conforming to the desired pitch of the steps, but 3 inches below the point where the inner edge of the tread meets the rise. Between the walls build a platform out of 2 x 4 stuff well braced and conforming to the slope of the walls. Over this and over the top edge of the walls, put a 3-inch layer of concrete reinforced every foot by $\frac{1}{4}$ -inch iron bars running from top to bottom. Build up the form on the outside of walls and proceed in the same manner as for area steps. Should the steps be more than 6 feet wide, a wall similar to the two side walls should be built in the center. Forms should not be removed from under the steps for 28 days. If the porch is so high that more than three or four steps are needed, the reinforcing rods must be larger and nearer together. To determine the diameter and spacing of rods, see columns headed "Reinforcement of Slabs" in portion of table referring to "Light Floor Loading," and select the diameter and spacing of rods in accordance with the length of the horizontal projection of the

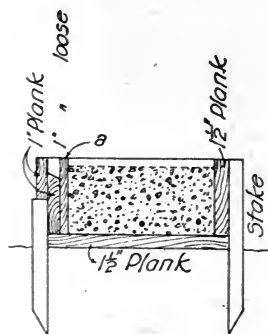

Form
Fig. 8

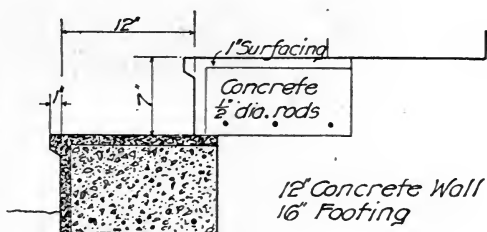

Fig. 10

Walls to be built below frost

Fig. 9

stairs, which corresponds to the column of "Distance Apart of Beams" in table.

Steps cast separate from supporting walls should be made in advance and allowed to season. The sectional drawing illustrates this form of step. To build a single step, make form shown in cut, page 35, Fig. 8, 14 inches x 7 inches inside measurement and 1 inch for projection, and fill as shown to within 1 inch of top with concrete, one part "ATLAS" Portland Cement, three parts clean, coarse sand and six parts broken stone; tamp hard and let set. Remove the board "A" next to the face of the concrete, which should not be fastened to the form, but simply set in and well greased. This will leave a space on the side and top of step, also a small mould for the projection at top of step. Fill this with wet mortar, one part "ATLAS" Portland Cement and one and one-half parts clean, coarse sand, and let set. The side forms may then be removed and used again. In building the two side walls for these steps, build a foundation 12 inches wide and below frost, Fig. No. 9. On this, and at equal distance from each edge, erect 8-inch walls with the top stepped off to conform to the bottom and back of steps, Fig. No. 10. Place the steps on the walls thus made, after covering all joints with cement mortar, so that they overlap one another 2 inches.



PORCH STEPS, GREENPORT, L. I., N. Y.



Photo No. 290.

FLYING STAIRS, DAIRY HOUSE, GEDNEY FARMS, WHITE PLAINS, N. Y.

FLYING STAIRS OR STEPS.

In constructing "flying" steps or stairs, first make the steps as in figure D and allow them to season. The stringers are cast in place and constructed as inclined beams of sufficient length, and with a projection along the lower inside to support the steps as in figure C. Place two $\frac{3}{4}$ -inch bars about $1\frac{1}{2}$ inches in from bottom and one of the same diameter at the top, the three being connected as shown under "Steel reinforcing in stringers." The reinforcing, however, depends upon the depth and pitch of the stairs, also the weight they are to carry. Stairs are put in place with the lower edge resting against the upper corner of the stair below, a small notch being left in each stair for this purpose. A finishing coat of one part "ATLAS" Portland Cement and one part clean, coarse sand is

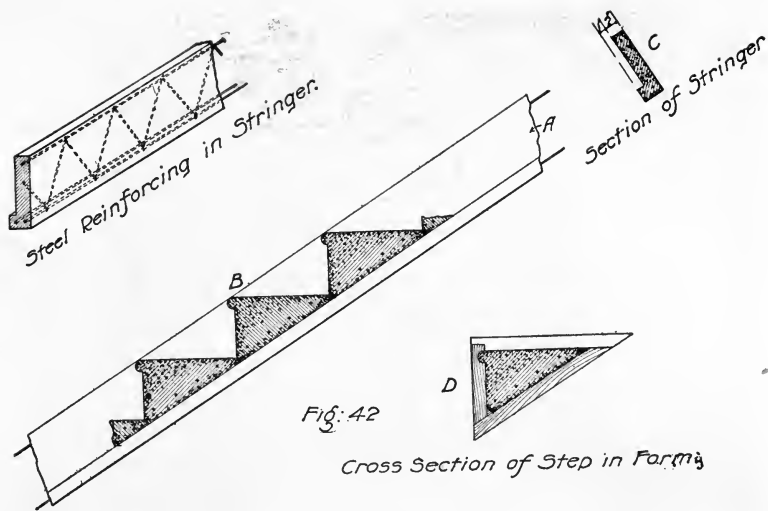

Fig: 42

Cross Section of Step in Form

given to the stairs after all are in place and have been picked with a stone axe. This binds the whole flight together. See Fig. 42.

WALLS.

Concrete walls for every purpose are considered the best by engineers, and such walls may be thinner than if built of any other material. Every wall should have a footing—that is, a base which is wider than the wall it carries. A foundation must extend below the frost line. A foundation must extend through soft or yielding soil.

Walls are of two kinds, solid and hollow, and may be either plumb, the same thickness at top as at bottom, or battered, wide at the bottom and sloped toward the summit. They may be built in two ways; first, cast in blocks and put into place the same as brick or stone; second, cast in place in one piece. Walls must be true, level, and unless battered, plumb.

Hollow walls are usually built with two faces 3 inches to 4 inches thick and are either tied together with galvanized iron strips or have piers of concrete connecting the two faces. These piers are built at the same time as the faces, and the whole is practically one wall with air chambers at regular intervals. Walls should be allowed to season before any super-structure is built upon them, to prevent their being injured by the workmen. In dry, warm weather this will re-

quire from six to eight days. Earth should not be filled in against a concrete wall for three or four weeks unless the form furthest from the earth is kept in place. Where there is no earth or water pressure against the wall, 24 hours, or until

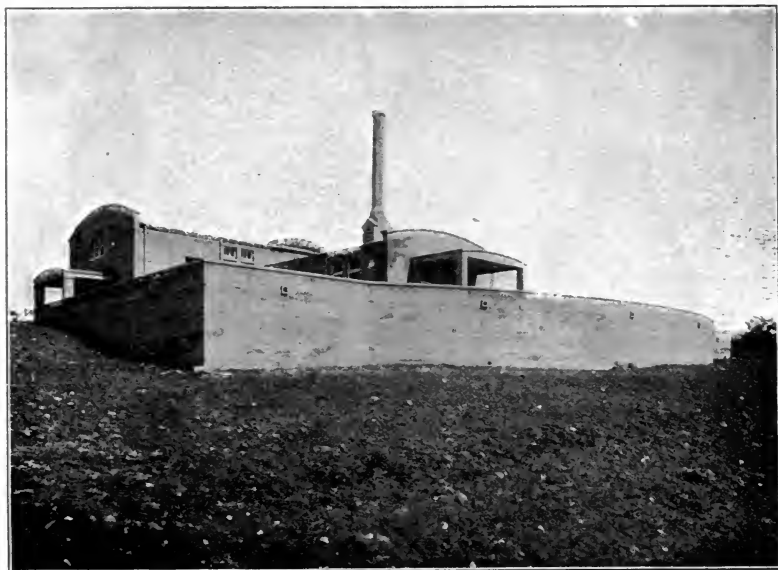

Photo No. 295.

RETAINING WALL, GEDNEY FARMS, WHITE PLAINS, N. Y.

the concrete will withstand the pressure of the thumb, is sufficient length of time to keep forms in place. For this reason it is well to have two or more forms where movable forms are used. In building forms they should be assembled, as far as possible, with bolts so that they may be used again.

Window or door frames should be put in place and the wall built around them. Cellar walls should be from 10 inches to 12 inches thick for frame superstructure and 14 inches to 24 inches thick for brick, or about 2 inches wider than the brick wall for convenience in laying out the brickwork.

Contraction in walls should be provided for by forming joints at intervals to divide the walls into separate sections to prevent cracks, or by reinforcing with sufficient steel to withstand shrinkage. These joints can be provided for in the following manner:

The simplest way is to place a temporary dam between the forms, to remain until a section of concrete has set, when it is removed and the next section filled.

Another way of forming a joint is to insert two or more thicknesses of tarred paper between sections of the wall.

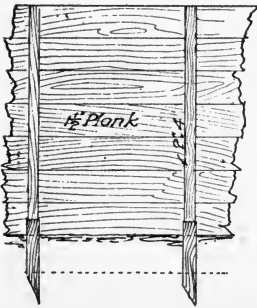

Fig. 10a

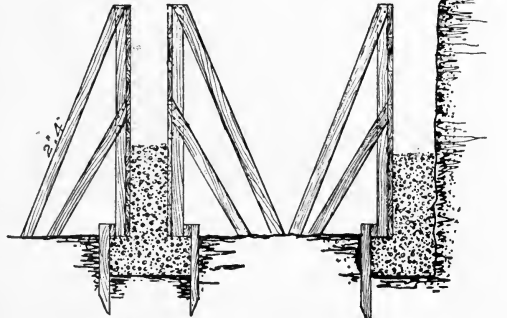

Fig. 11

Fig. 12

Fig. No. 10a represents the side view of an ordinary form. 2-inch x 4-inch braces are placed against the 2-inch x 4-inch studs, as shown in Fig. No. 11.

Fig. No. 11 represents an ordinary low wall in course of construction and shows the way the footing is placed and the forms braced.

Fig. No. 12 represents a wall for which the bank is made to do duty for half the form. In places where there is hard, clayey soil, this form may be used.

Figs. No. 13, No. 14, and No. 15 represent the various sections of a form used in building a solid wall of any height. This form is put in place and filled with concrete. After the concrete has set, the bolts are withdrawn and the form raised so that the bottom set of bolts rests on the completed wall—the lower part of the form overlapping the concrete. This tends to keep the wall plumb. The bolts used should be greased each time, otherwise it will be difficult to remove them after the concrete has set. The holes caused by the bolts can be filled solid with mortar mixed in the same proportion as the sand and cement in the concrete.

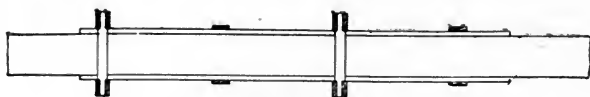

Top View
Fig. 15

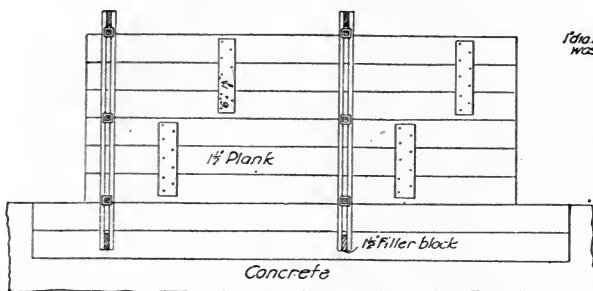
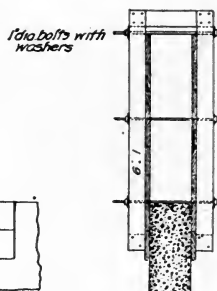

Fig. 13 Elevation

Form for Solid Concrete Wall.



Section
Fig. 14

Figs. No. 16, No. 17, and No. 18 represent a design for a form for hollow reinforced walls. In this form the bolts do not pass through the concrete, the form being raised when the concrete reaches their level. Fig. No. 16 shows the elevation. Fig. No. 17 shows a horizontal section. The core box is seen in the center, and at either end are the concrete piers used to tie the walls together. The core boxes are tapered to prevent them from slipping down, and the rods in the center of the outside faces of form rest on top of these core boxes. (See Fig. No. 18.) Strips of wood are used to fasten the tops of the faces together to stiffen the form.

Fig. No. 19 represents design used in construction of a hollow wall where there is not much strain on the wall, also in low walls. The faces of the form are constructed as in Fig. No. 11. The core is built in sections about two feet high and rests on the galvanized iron straps used to tie the walls together. These straps should be 2 inches broad by $\frac{1}{4}$ inch thick, and should be turned up an inch at each end and be long enough to extend half way through each wall. The distance apart at which these rods should be placed depends upon the strength required in the wall. There should, however, be a layer of them every time the core form is raised. The ends and top of this style of wall should be filled solid the last 6 inches, thereby forming a dead-air space.



Photo No. 293.

DETAIL OF FORMS FOR HOLLOW WALL CONSTRUCTION, GEDNEY FARMS,
WHITE PLAINS, N. Y.

There is still another style of hollow wall, forms for which are shown in the accompanying illustration. In this wall the core boxes are made collapsible and run to the height of the

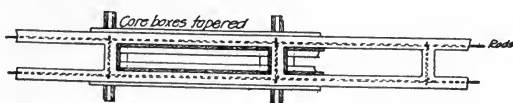

Horizontal Section
Fig. 17.

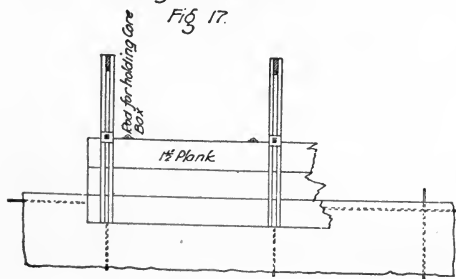

Elevation
Fig. 16
Forms for Hollow Walls.

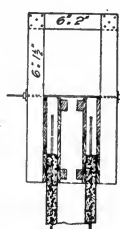

Vertical Section
Fig. 18

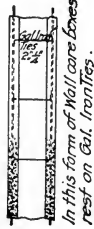

Fig. 19

finished wall. The outside or face forms are made in sections such as are seen in the foreground and are securely fastened with braces similar to those in Fig. No. 11. After the wall has been brought to its full height and set hard, the core boxes are collapsed and lifted out. The outside forms are then removed.

In making a curved hollow wall, both the core and face forms should be curved. (See Circular Forms).

HOUSE FOUNDATION.

To build a house foundation, first excavate to the desired depth of cellar and around the edge dig a trench 18 inches wide and 6 inches deep, and build forms for wall about 12 inches thick, as in Figs. No. 11 or No. 12. Fill with concrete, one part "ATLAS" Portland Cement, two and one-half parts sand, and five parts broken stone or gravel, ramming or puddling carefully, allowing the concrete at the bottom to flow out under the forms the width of the trench, to the desired height. Allow the concrete to set hard before removing the forms. If earth is filled in against back of wall the face forms should be left three or four weeks, but superstructure may be begun in about a week.

Partition walls are constructed in same manner as outside walls, but need not be more than 8 inches thick. If reinforced with $\frac{1}{4}$ inch rods spaced 18 inches apart horizontally and vertically, 4 or 6 inches will be thick enough. In wet ground, to prevent moisture from soaking through, it is well to give the inside a coat of one part "ATLAS" Portland Cement and one part sand, one-quarter inch thick, applied with trowel and wooden float, after picking the wall well with a stone axe and wetting thoroughly. There is little danger, however, of moisture passing through a well-laid wall if a blind drain of coarse gravel is laid just back of the foundation to carry off the water and prevent its rising back of the wall. In gravel or sand, the blind drain is unnecessary. BARN FOUNDATIONS should be built the same way as house foundations, except that the cellar is omitted.

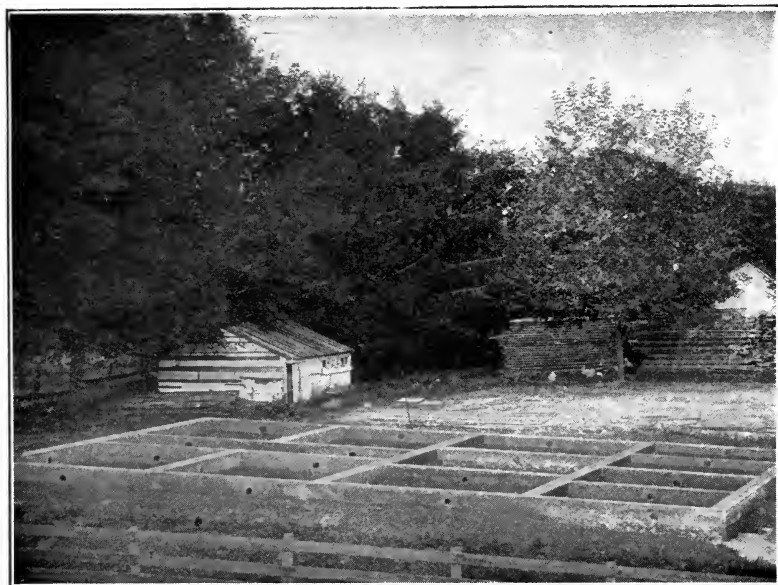

Photo No. 222.

BARN FOUNDATIONS, KIRKWOOD, ILL.

PIERS AND POSTS.

Excavate below frost and build forms 2 feet square to within 6 inches of surface of ground. Fill with concrete, one part "ATLAS" Portland Cement, two and a half parts clean, coarse sand and five parts broken stone or gravel not over one inch in size, and tamp or puddle carefully. From the center of this foundation build a hollow form one foot square and to desired height, and fill with concrete of same mixture. Before the form is filled—in fact, before setting it—four steel bars $\frac{3}{4}$ inch in diameter should be placed vertically so that they are about 2 inches inside the corners, and around them, at intervals of one foot, wind loops of $\frac{1}{8}$ inch or $\frac{1}{4}$ inch wire, tying these to the steel rods with fine wire. Every two feet a short piece of $\frac{1}{8}$ inch or $\frac{1}{4}$ inch wire may be tied to each of the vertical rods (see A) so as to project against the form and hold the steel in place. Make the concrete soft and mushy, so that it will just flow, and, as it is poured into the top of the mold, work a long paddle, made like the oar of a rowboat, against the forms to force the stones away from the

surface and drive out bubbles of air which tend to adhere to the boards and form pockets of stone (see Fig. No. 49).

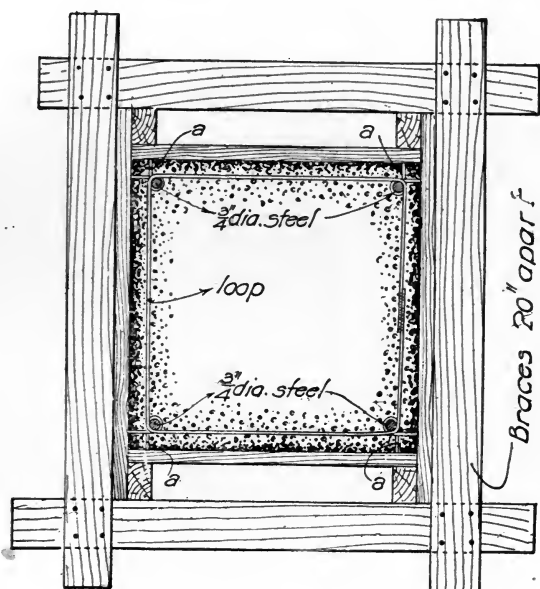

Fig. 49

WINDMILL FOUNDATION.

The great danger caused by the rotting of wooden windmill foundations is obviated by the use of concrete.

Excavate four holes at the proper distance apart, $2\frac{1}{2}$ feet square and 5 feet deep; build forms for the sides and grease properly. Fill forms 2 feet deep with concrete, one part "ATLAS" Portland Cement, three parts clean, coarse sand, six parts broken stone or gravel, of a jelly-like consistency, tamping well every six inches. To insure proper location of holding-down bolts, construct template and hang the bolts from it as shown in Fig. No. 22, and fill in concrete around them until flush with top of form, and allow to set several days before using. This gives a substantial anchorage for a steel tower.

In case a wooden tower is to be used, run projecting bolts up through the timber sills and use large cast iron washers under the nuts. The anchorage in this case should project at least 6 inches above the ground.

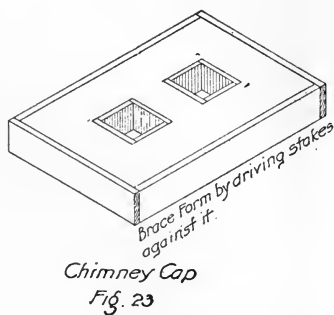
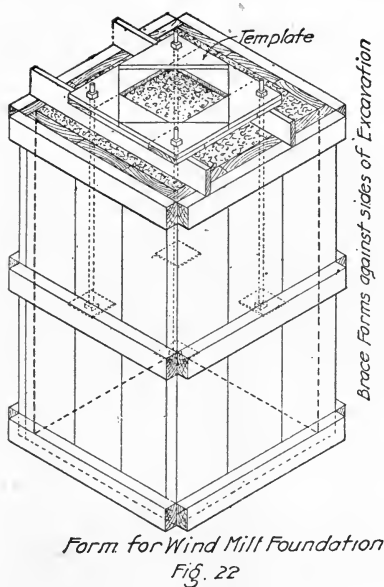

CHIMNEY CAPS.

Chimney caps of concrete are rapidly supplanting stone, brick or iron, as they are not only cheaper and more durable, but protect the top of chimney better.

Make a bottomless box the size of the required cap, and one or more small bottomless boxes to correspond to the flue or flues of the chimney, and $\frac{1}{2}$ inch higher, so that the surface of the concrete can be sloped to allow water to flow off, and set in place (Fig. No. 23). The thickness is usually about 4 inches, but this can be varied to suit convenience. Plaster the inside surface of the large mold with $\frac{1}{2}$ inch of stiff mortar and then immediately fill form one-half full with one part "ATLAS" Portland Cement, three parts clean, coarse sand, and six parts broken stone, and put in reinforcing, either woven wire, expanded metal, or $\frac{1}{4}$ -inch rods, complete, and tamp until water puddles on top. When partly set, trowel smooth.

If it is desired to build the cap in place, the following plan should be adhered to: Place small rods across the chimney between the flues. On these build platform of tongue and

grooved board planed on upper side, and driven snug together, but not nailed. On this platform place the forms previously described and fill with reinforced concrete. After the con-

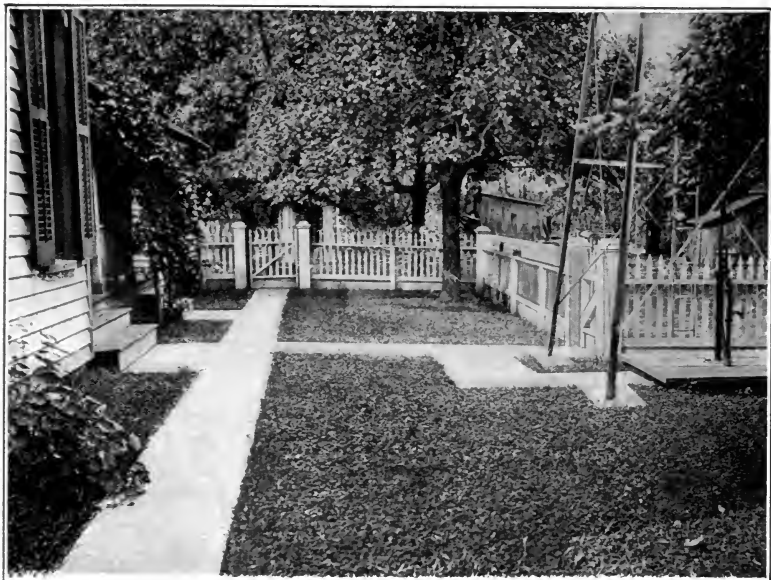

Photo No. 224.
CONCRETE WALK AND WINDMILL FOUNDATION, CLINTON, IA.

crete has set (at least a week is needed) remove platform by raising each side of chimney cap alternately and knocking platform apart. Remove outer and inner forms. Raise one end of slab, cover all accessible surface of top of chimney with mortar, lower cap on bed thus formed and remove rods under end. Repeat process at opposite end.

CISTERN.

Make a circular excavation 16 inches wider than the desired diameter of the cistern, or allow for a wall two-thirds the thickness of a brick wall that would be used for the same purpose, and from 14 feet to 16 feet deep. Make a cylindrical inner form (See Circular Form) the outside diameter of which shall be the diameter of the Cistern. The form should be about 9 feet long for a 14-foot hole, and 11 feet long for one 16 feet deep. Saw the form lengthwise into equal parts for convenience in handling. Lower the sections into the cistern and

there unite them to form a circle (Fig. No. 33), blocking up at intervals six inches above the bottom of excavation. (Withdraw blocking after filling in spaces between with concrete and then fill holes left by blocking with rich mortar.)

Make concrete of one part "ATLAS" Portland Cement, two parts clean, coarse sand, and four parts broken stone or gravel. Mix just soft enough to pour. Fill in space between the form and the earth with concrete, and puddle it to prevent the formation of stone pockets, using a long scantling for the purpose and also a long-handled paddle for working between

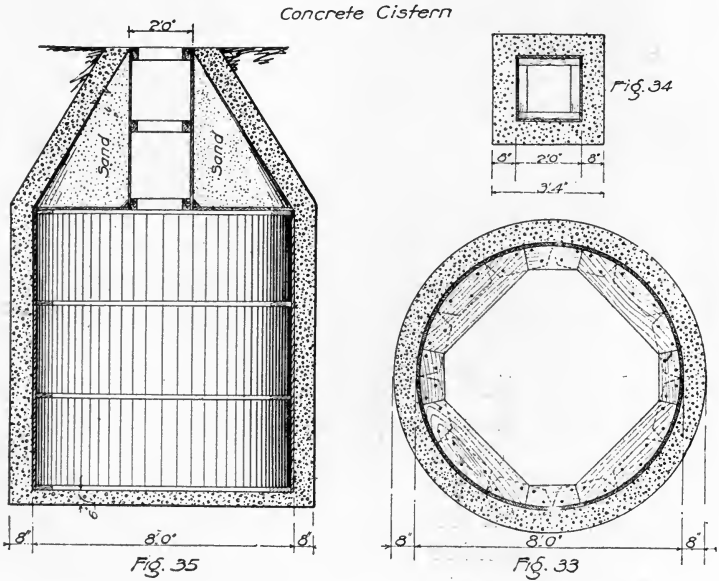

the concrete and the form. To construct the dome without using an expensive form, proceed as follows: Across top of the form build a floor, leaving a hole in the center two feet square. (Fig. No. 34.) Brace this floor well with wooden posts resting on the bottom of the cistern. Around the edges of hole, and resting on the floor described, construct a vertical form extending up to the level of the ground.

Build a cone-shaped mold of very fine wet sand from the outer edge of the flooring to the top of the form around the square hole and smooth with wooden float. Place a layer of

concrete four inches thick over the sand so that the edge will rest on the side wall, Fig. No. 35.

Let concrete set for a week, then remove one of the floor boards and let the sand fall gradually to the bottom of the



Photo No. 232.

CONCRETE CISTERN, ST. CHARLES, ILL.

cistern. When all boards and forms are removed they can be easily passed through the two-foot aperture and the sand taken out of the cistern by means of a pail lowered with a rope. This does away with all expensive forms and is perfectly feasible. The bottom of the cistern should be built at the same time as the side walls and should be of the same mixture, six inches thick.

SQUARE CISTERN.

A square cistern such as is shown in illustration (page 49) is much easier to build, and, in most cases, answers the purpose as well as a round cistern.

Excavate to desired depth and put in 6 inches concrete floor, one part "ATLAS" Portland Cement, two parts sand, and four parts broken stone. As soon as practicable, put up forms for 8-inch walls (See Walls) and build the four walls simultaneously. If more than 8 feet square, walls should be reinforced with a woven wire fabric.



Photo No. 301.

WATERING TANK, BOODY, ILL.

WATERING TROUGHS.

Watering troughs may be made with or without reinforcing, but troughs without reinforcing should have a greater thickness of concrete. Troughs may be built with a solid base or set on bench blocks. One of the sizes in common use is 8 feet long, 2 feet wide at top and $1\frac{1}{2}$ feet at bottom, and $1\frac{1}{2}$ feet deep, all inside measurements, which may be varied to suit convenience.



Photo No. 259.

WATERING TROUGH, BABYLON, L. I.

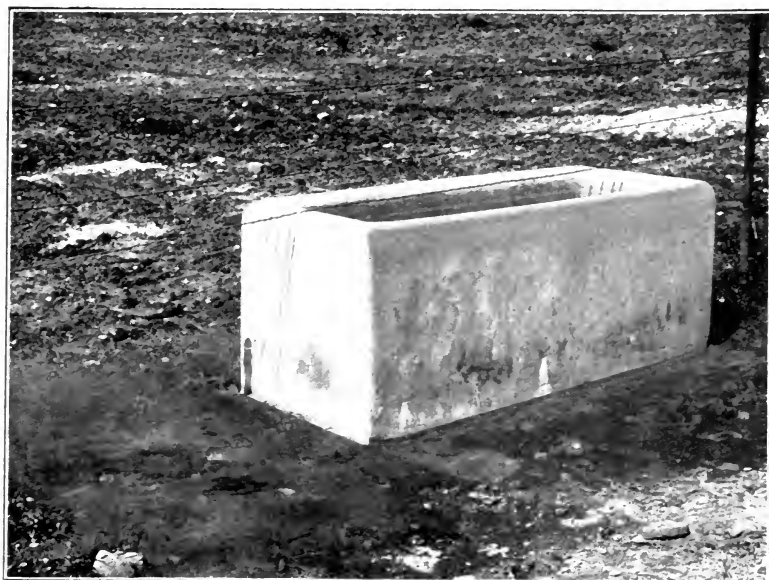

Photo No. 278.

FIELD TROUGH, GEDNEY FARMS, WHITE PLAINS, N. Y.

Select a level piece of ground and build well braced, bottomless box form from 2-inch stuff, the inside measurements being 8 feet 8 inches long, 2 feet 8 inches broad and 2 feet 1 inch deep. Ram the ground hard inside the form. Grease the form well and put in a layer of concrete, one part "ATLAS" Portland Cement, two parts clean, coarse sand and four parts broken stone, mixed to jelly-like consistency, 2½ inches deep,



Photo No. 299.

WATERING TROUGH, DECATUR, ILL.

and tamp well. Place a sheet of woven wire fabric over the concrete, letting it come to within 1 inch of the top of forms at sides and ends. Put in 2½ inches more concrete over the bottom and ram lightly to bring mortar to the surface, and smooth it carefully. As soon as it is laid and before it has begun to set, put the inner form (well greased) in place, taking care to keep it at equal distances from the sides and ends. The inner form should be made of 2-inch stuff and slightly wedge shape. The outside dimensions may be as follows:

Eight feet long, 1½ feet deep, 2 feet broad at top of trough and 1½ feet broad at bottom. Fill in the spaces between the

two forms with soft concrete, tamping lightly or puddling. Remove forms next day, or as soon as concrete will bear pressure of thumb, and smooth off irregularities in surface, then, as soon as hard enough not to crumble, paint with pure cement mixed as thick as cream.

Inlet and outlet holes may be made by putting pieces of pipe in place before filling in the concrete, or a greased, tapering wooden plug to be drawn out when concrete has set.



Photo No. 223. FIELD WATERING TROUGH, KNOXVILLE, IOWA.

A trough with a solid concrete base should be made in the same general way, the forms carried up to the desired height of trough and the reinforcing imbedded in the concrete a few inches from the inside. Troughs should be protected from the sun and currents of air for several days, and kept wet by sprinkling.

TANKS.

Concrete tanks for storing water are in all respects superior to any other kind. They are easy to clean, do not rust, neither do they decay.

DIRECTIONS:—Concrete mixture one part "ATLAS" Portland Cement, two parts clean sand and four parts broken

stone or gravel, not more than three-quarter inch in size, reinforced by woven wire fabric for small tanks, and steel rods for large tanks. The concrete should be wet until of the consistency of jelly.

SQUARE TANKS—Small:—Build inside of form 8 inches wider, 8 inches longer and 4 inches deeper than the inside of



Photo No. 302.

WATER STORAGE TANK, BOODY, ILL.

the finished tank is to be. Set reinforcement, allowing that placed on the sides of the tank to project down into the bottom and that from the bottom to project up into the sides. Place the inner form 4 inches from the outside form. This form can rest on iron pins driven into the ground. Have the bottom of the side walls about 2 inches thicker on the inside, giving a slight slope outward. This is done to prevent ice from cracking the concrete in Winter. Grease inside of forms. Put concrete into forms in one continuous operation, as there must be no joints between courses. The reinforcing at the bottom should be lifted slightly as the concrete is placed, to allow the concrete to get under it. In filling the sides take care to keep the reinforcing in place. After the concrete

has set and the forms are removed, paint the entire tank with pure cement mixed with water until of the consistency of cream and brush well in. This will prevent any leakage.

ROUND TANKS:—Same general idea should be followed, the forms being made as per circular form and the reinforcing worked in the form of a spider web.



Photo No. 328.

FIFTY-FOOT WATERING TROUGH, U. S. SOLDIERS' HOME, WASHINGTON, D. C.

TANKS—Large:—The thickness of concrete and the amount of steel necessary must be figured out accurately for large tanks, and as the dimensions vary in each case, an engineer should be consulted.

Should the tank be desired above ground, remove the sod and loose earth, and build foundation of gravel or crushed stone, and proceed as above. For inlets and outlets, pieces of pipe should be placed in the concrete while same is being deposited.

REINFORCEMENT FOR TANKS.

On following page is given a list of sizes of steel required for tanks of several different dimensions, allowing ample factor

of safety. The entire pressure of the water is assumed, according to the very best practice, to be taken by the steel, as concrete is not reliable in tension unless reinforced. The thickness of concrete is only required to imbed the steel and to make the tank water-tight, and should vary with the height of the tank, but not necessarily with the diameter. A minimum thickness of 4 inches for a 5-foot tank, running up to 15 inches for a tank 15 feet deep, is suggested.

(1) Depth	(2) Diameter	(3) Thickness of Concrete	(4) Diameter Circumfer- ential rods.	(5) Spacing circumfer- ential rods at bottom.	(6) Spacing Circumfer- ential rods at top.	(7) Diameter vertical rods.	(8) Spacing vertical rods.
Ft.	Ft.	Inches	Inches	Inches	Inches	Inches	Ft.
5	by 5	4	$\frac{1}{4}$	6	9	$\frac{3}{8}$	$1\frac{1}{2}$
5	" 10	4	$\frac{5}{16}$	6	9	$\frac{3}{8}$	$2\frac{1}{2}$
10	" 10	8	$\frac{3}{8}$	6	12	$\frac{3}{8}$	$2\frac{1}{2}$
10	" 15	8	$\frac{1}{2}$	6	12	$\frac{1}{2}$	3
15	" 10	12	$\frac{1}{2}$	6	15	$\frac{1}{2}$	$2\frac{1}{2}$
15	" 15	12	$\frac{5}{8}$	6	15	$\frac{5}{8}$	3

NOTE.—Bend circumferential rods in rings, place in center of wall and lap ends 2 ft. Increase, gradually, spacing of circumferential rods from bottom to top.

WELL CURBS.

Concrete makes the best well curb, as it keeps out the surface water, and is easily kept clean.

After the well has been dug to the desired depth, and the sides properly braced in short sections, so that the earth cannot cave in, build a circular form 8 inches smaller than the diameter of the hole, and 4 feet long. (See Circular Form.) Lower to the bottom in sections and adjust so that there are 4 inches between the form and the side of the hole. Place concrete mixture, one part "ATLAS" Portland Cement, two and one-half parts clean, coarse sand, and five parts broken stone or gravel, in this space. To allow the water to get into the well, place a couple of pints of loose, broken stones in "pockets" every few feet until water level is reached. After filling the form to the top and allowing it to set over night, or until the concrete will bear pressure of the thumb, raise it 3 feet, brace securely, and repeat until ground level is reached. A slab 4 inches thick and 8 feet square should be built around

the top of the well, first replacing surface soil with a layer of cinders or clean gravel, well rammed, about 12 inches thick.



Photo No. 185.

HORSE BLOCK, HITCHING POST AND SIDEWALK, WESTWOOD, N. J.

HORSE BLOCK.

Build a box 24 inches long, 10 inches wide and 8 inches deep, outside measure. Turn this bottom up on the floor, or some other smooth surface, and around it build a box or form, without bottom, 36 inches long, 18 inches wide and 12 inches deep, inside measure. Be sure that the smaller box is set at equal distance from both sides and ends of the larger box, and fill the form thus made with concrete, one part "ATLAS" Portland Cement, three parts clean, coarse sand and five parts gravel or broken stone. Scrape with straightedge and smooth with wooden float. Let it stand for at least 48 hours before removing outside form. Keep damp by sprinkling for three weeks, and do not attempt to move it before that time. If finished appearance is desired, a coating one-quarter inch thick, made of one part "ATLAS" Portland Cement and one part clean sand may be plastered over the entire surface of the block, after picking with a stone axe and wetting thoroughly.

FENCE POSTS.

The use of concrete fence posts is becoming more and more general in rural districts, which bespeaks their good qualities. The life of a concrete post is unlimited, as it can never rot.

The farm fence post should be 6 inches square at the bottom and about $3\frac{1}{2}$ inches at top, $6\frac{1}{2}$ feet long (Fig. No. 28), and should be built in the following manner: Select some space where the posts can be left in their original position until dry.

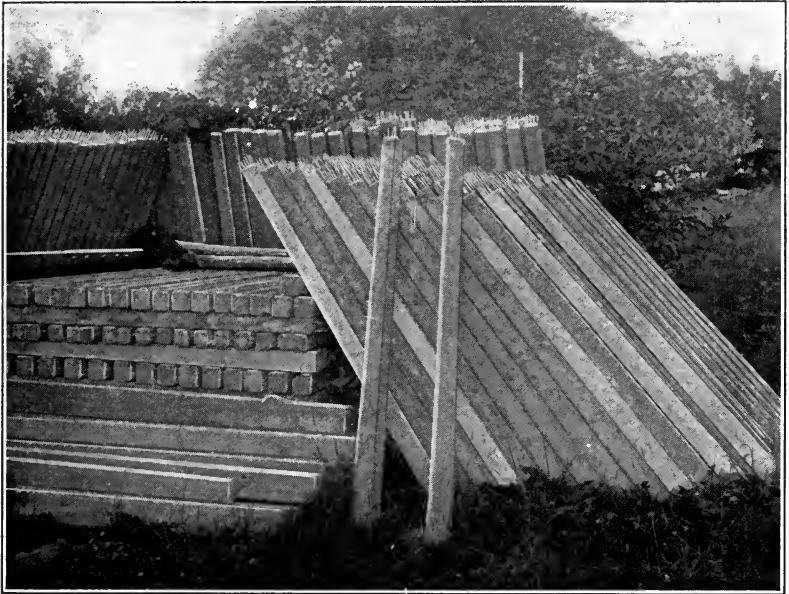
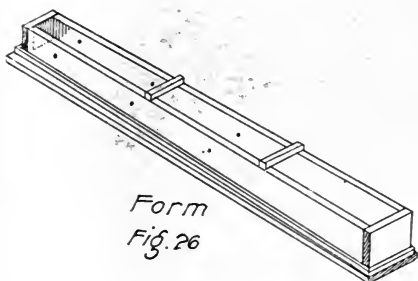
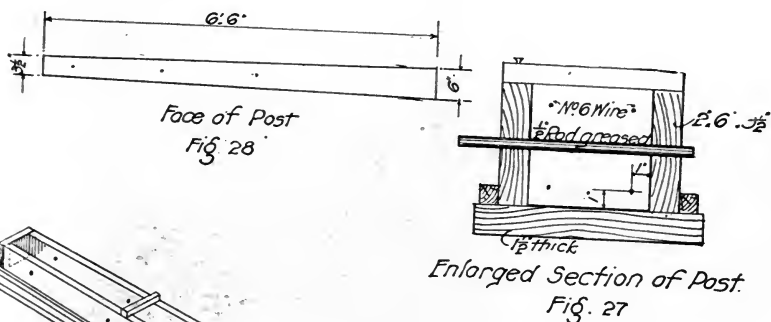

Photo No. 233.

CONCRETE FENCE POSTS, SIOUX RAPIDS, IA.

Place the bottom board, $1\frac{1}{2}$ inches x 10 inches x 7 feet, in a firm position on the ground, supporting it throughout its length. Take two planks, 2 inches thick, 6 feet 6 inches long, and from either edge lay off $3\frac{1}{2}$ inches at one end, and from the same edge 6 inches at the other end. Draw a line between these points and saw along the line. Place them on edge, straight side down, on the bottom board, keeping the 6-inch ends 6 inches apart, and the $3\frac{1}{2}$ -inch ends $3\frac{1}{2}$ inches apart. Nail two or three stiff cross pieces to keep them in

place, and put a solid wooden block at each end (Fig. No. 26). The sides should be further stiffened by pieces of moulding or lath tacked along the bottom board on the outside. Fill the form thus made 1 inch deep with concrete, one part "ATLAS" Portland Cement, two and one-half parts clean sand, and five parts broken stone, wet to consistency of damp soil, and place a piece of strong wire (No. 6) 1 inch



in from each side and running from end to end (Fig. No. 27). Fill to within 1 inch of top with concrete and tamp until water flushes to surface and no air spaces are left. Place two more pieces of wire 1 inch from sides and fill to level of form with concrete; tamp again, and smooth off with a trowel. Let the forms remain on the sides at least ten hours. Do not move the bottom board either away from the post, or with the post on it, for ten days, under penalty of post cracking. Posts should be left for three or four weeks at least before using, and kept damp by sprinkling.

For fastening wire to the posts, the following method is suggested: While the concrete is being put into the forms, put 1/2-inch steel bars (greased) through holes bored in the sides of the form, the proper distance apart for stringing wires, and leave until the concrete takes its final set (approximately four hours); then pull them out. This will leave a hole through which the fence wire can be strung, or a short piece

of wire can be run through and the ends twisted around the running fence wire, or wooden or lead plugs may be inserted in the concrete through holes in the form at the proper distance apart and the wire fence fastened to them with staples.

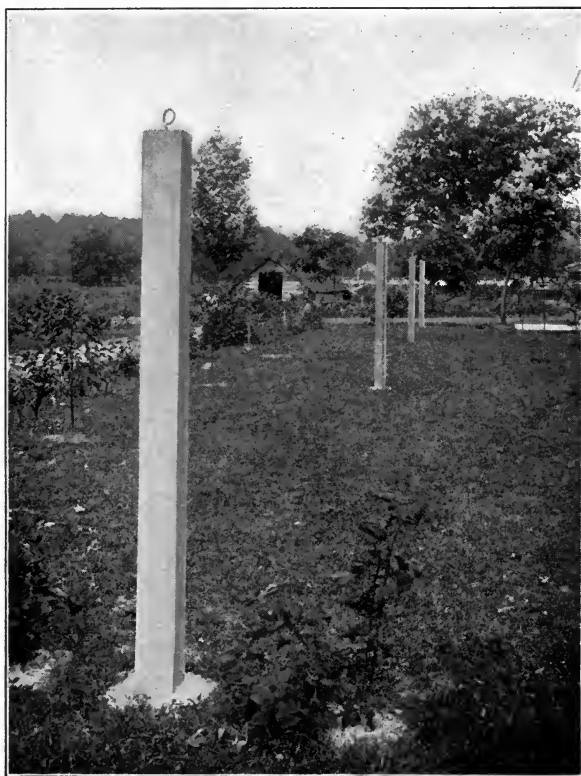

Photo No. 183.

CONCRETE CLOTHES POSTS, WESTWOOD, N. J.

In making a finished fence post, the method of procedure is practically the same as with the field post, except that after the post is removed from the bottom board it should receive a coat of pure cement, of the consistency of thick cream, applied with a brush and well worked in. Fence posts of this description should have holes in them one-half inch in diameter, made in the way already described, to which the wooden runners may be bolted.

Corner posts may be made by enlarging the forms so that

the inside measurements are 10 inches x 10 inches at the bottom and 6 inches x 6 inches at top. For reinforcing, use three-eighths inch rods instead of No. 6 wire.

Clothes posts should be made in the same general way as the finished fence posts, except that the post should be 9 feet long and should have a staple made of iron one-half inch in diameter, imbedded in the top, or a hole may be made near the top to run a clothes line through. For reinforcing, use three-eighths inch rods instead of No. 6 wire.

The posts may be made the same dimensions at the top as at the bottom.

Hitching posts should be made six feet long and should have an iron ring in top; otherwise, the directions are the same as finished fence posts.

PIAZZA.

In building a concrete piazza the first care should be the supports. Unless these are strong and have a foundation that will not be affected by frost, the piazza is liable to prove a failure.

Erect two lines of 4-inch posts, 8-inch bases, 8 feet apart, extending below frost. The outer line of posts should be slightly lower than the inner line, to allow water to flow off the piazza. On top of and connecting these, build concrete cross beams and stringers $2\frac{1}{2}$ inches x 5 inches. Both posts and beams should be reinforced with one-quarter inch steel bars. For a large piazza, refer to dimension of beams and reinforcement in Table for "Designing Reinforced Concrete Beams and Slabs."

After the concrete has set hard, erect forms and build a solid slab of concrete over the entire framework, allowing it to project slightly over the outer edge. This slab should be reinforced with a woven wire fabric or expanded metal.

A finished surface can be obtained by plastering the surface one-quarter inch thick with mortar, one part "ATLAS" Portland cement and one part clean, coarse sand, before the concrete has set.

LATTICE.

In building a lattice, the fact that there are two thicknesses of concrete, i. e., the thickness of the panel or border and the thickness of the lattice itself, should be borne in mind.

Build a form 8 inches higher and 8 inches longer than the

size the finished lattice is to be, using 2-inch stuff. Along the top, bottom, and at either end, nail a 4-inch x 4-inch scantling, and on these nail a 2-inch x 8-inch plank (see Fig. No. 44). On the back of the form, at equal distances apart and equal distances from the edge of the 2-inch x 8-inch plank, nail securely blocks of wood of the shape of the holes desired. (See holes in lattice in accompanying cut.) Lay the form thus made

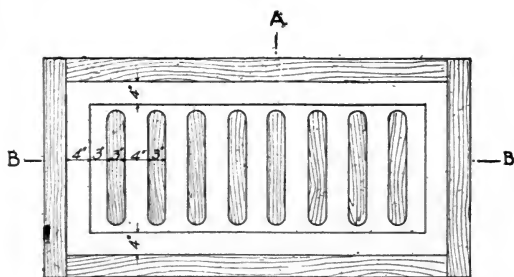

Photo No. 187.

PORCH STEPS AND LATTICE, RESIDENCE W. N. WIGHT, WESTWOOD, N. J.

on the ground, face up, and block securely. Fill with concrete one part "ATLAS" Portland Cement, two parts sand, and four parts fine broken stone or gravel to the level of small blocks for holes, and pack concrete all around under the 2-inch x 8-inch plank to form panel; tamp hard, making sure there are no voids. Smooth off face of concrete and let stand for a week, or until the concrete is thoroughly dry. After it is put in place, a coating of pure cement, mixed as thick as cream, should be applied with a brush. A moderately dry concrete should be used in this form.

The lattice may be built in place by leaving off the 4 inches x 4 inches at the top of form and boarding up the open space



Elevation of Lattice with part of Form removed.
Fig. 43

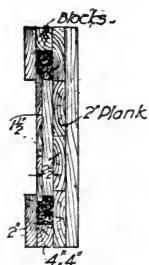

Section A-A
Fig. 44



Section B-B
Fig. 45.

in front of "hole-blocks" with a 1½-inch plank, and pouring the concrete in from the top (Fig. No. 45). A very wet concrete should be used if this plan is followed.

HOG PENS.

To construct a concrete hog pen excavate a trench, the size and shape desired for finished pen, one foot wide and to a depth below frost, and fill with concrete mixture one part "ATLAS" Portland Cement, four parts clean, coarse sand, and eight parts broken stone. On top of this foundation build a wall (See Walls), at equal distance from edge, 4 inches thick and 4 feet high. Proportions of wall, one part "ATLAS" Portland Cement, three parts clean, coarse sand, and six parts broken stone.

Space for a gate should be left, and a trough built similar to the one shown in picture, or described in "Hog Troughs."

A hog house can be added by building another wall in the corner and roofing the space with 2½ inches concrete, one part "ATLAS" Portland Cement, two parts clean, coarse sand, and four parts broken stone. This slab must be reinforced with wire mesh or steel rods. Flooring same as in "Cellar Floors."

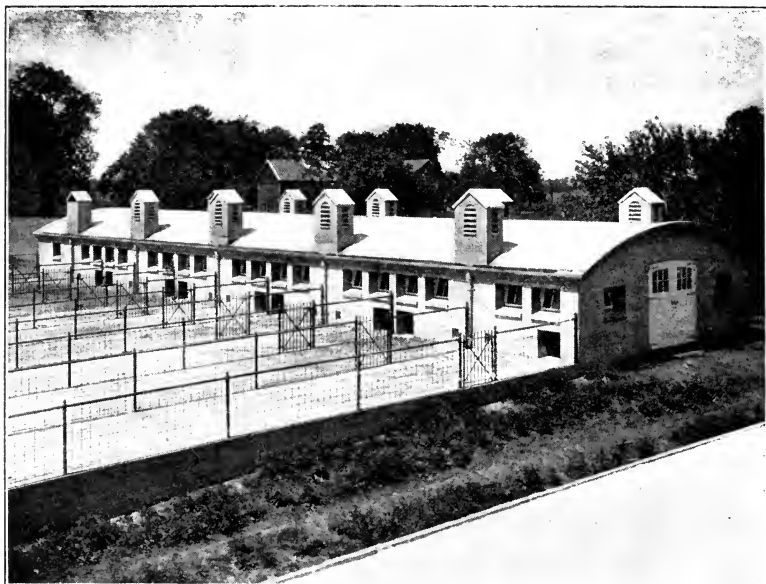

Photo No. 282.
THE PIGGERY, GEDNEY FARMS, WHITE PLAINS, N. Y.



Photo No. 285.
INTERIOR PIGGERY, GEDNEY FARMS, WHITE PLAINS, N. Y.

HOG TROUGHS.

A desirable hog trough can be made by building a bottomless box 6 feet long and 12 inches broad by 12 inches deep. From a 2-inch plank saw out two triangles having a base of 12 inches and a height of 8 inches. Place these 5 feet 6 inches apart and nail a plank 1 inch thick on each side of the



Photo No. 227.

INTERIOR PIGGERY WITH CONCRETE FLOOR, KLIMME, IOWA.

triangle. Place the inverted V-shaped trough thus made inside the bottomless box and put small triangular strips around the edges to make a square edge. (See Fig. No. 24.) Fill the space left with concrete mixture, one part "ATLAS" Portland

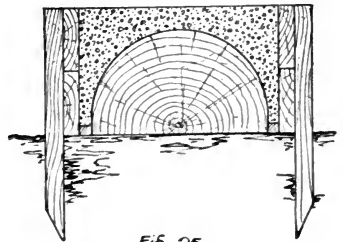
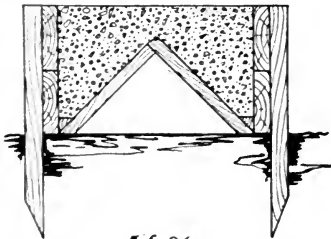

Fig. 24

Forms for Hog Troughs.

Fig. 25

Cement and three parts clean sand or sandy gravel, tamp hard, and smooth off to top of box. Let stand until dry. In one week remove the outer forms and paint with pure cement mixed as thick as cream, turn the block over, remove inner form and paint inside.

Should a trough with a round bottom be desired, an inner form can be made by sawing a log the right length, stripping it of bark, and splitting in half. Put this in the bottomless box described above, flat side down, Fig. No. 25, grease well and proceed as with triangular trough.



STUCCO CHICKEN HOUSE, NORTHAMPTON, PA.

CHICKEN HOUSE.

The protection afforded by a concrete chicken house against rats, weasels, etc., and the ease with which such a structure is kept clean, should be sufficient reason to give it preference over every other kind.

Excavate a trench 12 inches wide, to a depth below frost, and fill with concrete one part "ATLAS" Portland Cement, three parts clean, coarse sand, and six parts cinders. On this foundation, and at equal distance from either edge, build a solid wall 5 inches thick (See Walls), one part "ATLAS" Portland



Photo No. 230.

CARRIAGE HOUSE, WASCO, ILL.

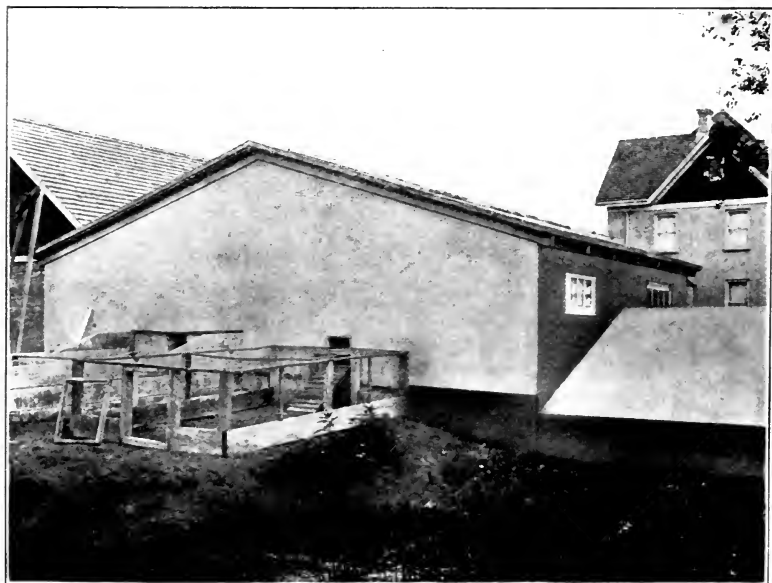

Photo No. 194.

CHICKEN HOUSE, WESTWOOD, N. J.

Cement, two and one-half parts clean, coarse sand, and five parts cinders; or, if cinders are not obtainable, a hollow wall should be built 12 inches thick, consisting of two 3-inch walls and a 6-inch air space. (See Hollow Walls for Small Structures.) If the house is not more than 8 feet wide, a roof with slope in one direction may be made of a 4-inch concrete slab reinforced with steel rods, or heavy wire mesh, of size suggested in the table of Reinforced Beams and Slabs. For a shorter span a less thickness may be adopted. A slope of six inches in eight feet will give sufficient pitch for the water to



Photo No. 266.

ICE HOUSE, BABYLON, L. I.

run off, if the surface is well trowelled, as described under Sidewalks. If the width is more than 8 feet, concrete rafters may be placed, and slabs laid upon them of dimensions to be selected from the table of Reinforced Beams and Slabs.

Concrete shelves and water basins can be put in to suit convenience.

A coat of pure cement, mixed as thick as cream, should be applied with a brush to the outside walls as soon as forms are removed.

The use of cinders is recommended in this construction, as the voids in the cinders take up the moisture which is otherwise liable to collect on the inside of the wall in cold weather.

ICE HOUSE.

There has been considerable discussion as to whether or not concrete ice houses are a success. After thorough investigation the conclusion has been reached that there are none better, if properly built—i. e., with a double wall.



Photo No. 221.

ICE HOUSE, MONMOUTH, ILL.

DIRECTIONS:—Excavate a foot below the desired depth and put in a layer of coarse gravel or broken stone, ramming hard. This makes a good floor and leaves plenty of drainage. Set up forms in shape finished structure is desired, allowing 16 inches for a wall, and build foundation one part "ATLAS" Portland Cement, three parts clean, coarse sand, and six parts broken stone, 16 inches wide by 4 feet deep, or below frost. The wall should be built as shown in Hollow Walls, making two 3-inch walls with a 10-inch space, each reinforced with one-quarter inch rods placed 12 inches apart in both directions.

Mixture:—One part “ATLAS” Portland Cement, two parts clean, coarse sand, and four parts broken stone. The wall should be built in sections about 2 feet high at a time, and the outer and inner walls should be bound together by placing galvanized iron strips, one inch broad by one-sixth inch, and turned up about an inch at each end, between the first and second section, after the first section of the inner form has been removed. These strips will not only strengthen the wall, but will serve as a convenient footing for the second tier of inner forms, etc. The ends and top should be filled in solid to the depth of 6 inches, leaving no openings for the air to circulate.

The roof should be made slanting, and after the lower or inner side is completed, 5 inches of sand may be placed on top and leveled off. The upper or outer surface of the roof can then be laid, with suitable reinforcement, directly upon the sand, and carefully trowelled as soon as it is partly set. The sand is let out at an opening left for the purpose at the sides, when the concrete has dried for a couple of weeks. There should be several square blocks of concrete placed so as to connect the two, and a strong concrete beam should form the ridgepole. All openings between the walls and roof and the two layers of roof should be sealed up solid, so as to give a dead air space between them.

For a small house the dimensions of beams and slabs for roof may be obtained from table of Reinforced Beams and Slabs, but for a large house money will be saved and safety assured by consulting an engineer or architect experienced in concrete design.

ROOT CELLAR.

Root cellars are usually built half below and half above the level of the ground. Excavate 16 inches below the desired level of the floor and around the sides build a foundation 12 inches broad, one part “ATLAS” Portland Cement, three parts clean, coarse sand, and six parts broken stone or gravel. Remove the form and fill between the foundations to a depth of 12 inches with porous material, tamping well. On this build a floor as described in Cellar Floors. On the foundation and at equal distance from either edge, erect a solid wall 8 inches thick (See Walls), one part “ATLAS” Portland Cement, two

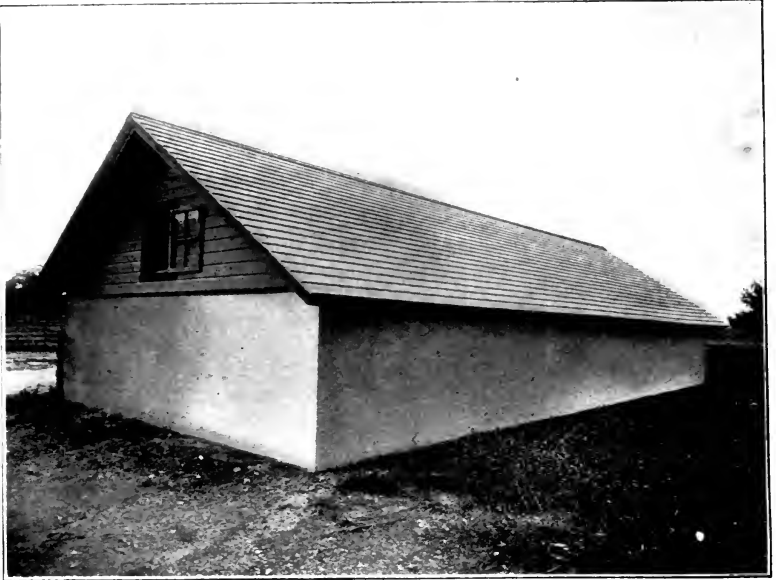

Photo No. 262.

ROOT CELLAR, BABYLON, L. I.

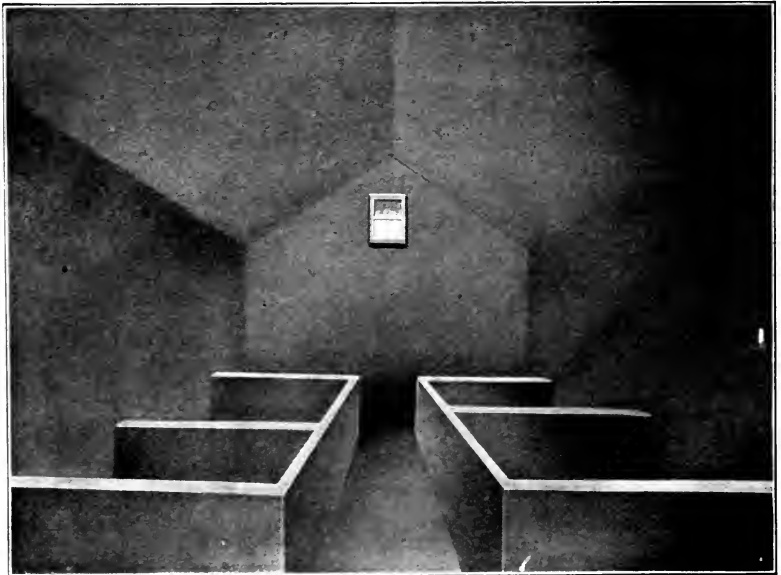

Photo No. 263.

INTERIOR ROOT CELLAR, BABYLON, L. I.

and one-half parts clean, coarse sand, and five parts cinders, broken stone or gravel, leaving an opening at one end for the steps (See Steps.) Build up the end walls so as to form a point in the middle, and high enough to give the roof a sufficient pitch to shed the rain.

Near the top at each end, openings for windows should be left, and the sash fitted and plastered in after the concrete has set and forms have been removed.



Photo No. 317.

ROOT CELLAR, KNOXVILLE, IOWA.

Bins should be built of size and height to suit convenience, with walls 4 inches thick, and reinforced with one-quarter inch rods placed 12 inches apart horizontally and vertically.

If a concrete roof is desired, forms should be erected and a roof $2\frac{1}{2}$ inches thick laid on. On the top of this, and before the concrete is dry, a layer one-quarter inch thick of one part "ATLAS" Portland Cement and one part sand should be placed, trowelled when partially set, and smoothed with a wooden float. Forms should not be removed from roof for at least three weeks.

Should the roof be sufficiently long to require support other than the concrete beam that forms the ridge pole (See section

on Reinforced Concrete), posts can be built in place 8 inches square.

Roof and steps should be reinforced with a woven wire fabric or with steel rods.

MUSHROOM CELLAR.

Mushroom cellars should be built at least two-thirds below the level of the ground to obtain the best results.



Photo No. 198.

INTERIOR OF MUSHROOM CELLAR, WESTWOOD, N. J.

Excavate to the desired depth, and around the edge dig a trench 12 inches deep and 16 inches broad. In this lay a foundation one part "ATLAS" Portland Cement, three parts clean, coarse sand, and six parts broken stone or gravel. On the foundations and at equal distance from either edge build a solid wall (See Walls) 8 inches thick, mixture one part "ATLAS" Portland Cement, two parts clean, coarse sand, and four parts broken stone, gravel or cinders.

Build a concrete roof $2\frac{1}{2}$ inches thick, supported by concrete beams and posts (see Table, Reinforced Concrete Beams and Slabs). An opening should be left at one side for steps

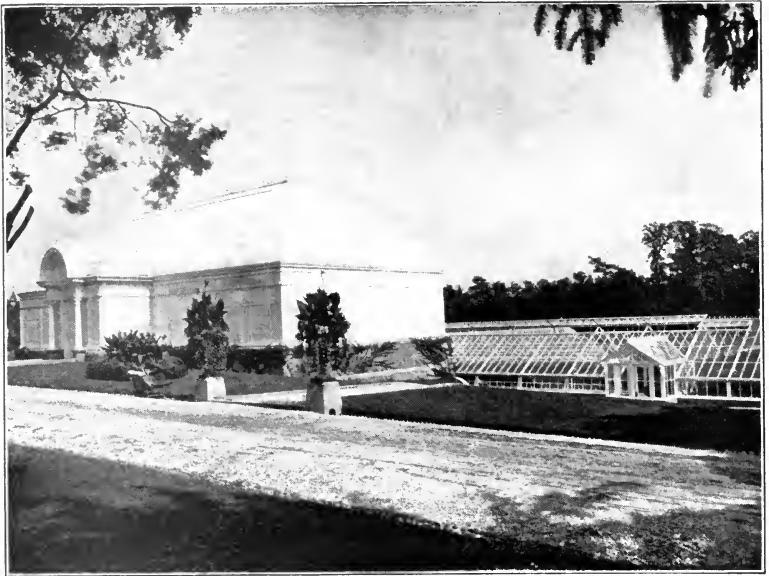

Photo No. 322.

GREENHOUSES, U. S. SOLDIERS' HOME, WASHINGTON, D. C.



Photo No. 319.

INTERIOR GREENHOUSE, U. S. SOLDIERS' HOME, WASHINGTON, D. C.

(see Steps). All walls, posts, beams and roof should be reinforced. A coat of pure cement of the consistency of cream should be applied to the whole exterior.

GREENHOUSES.

A greenhouse built of concrete not only does not require constant repairs, but saves fuel, as it retains heat and keeps out cold air.

Greenhouses should have a foundation 10 inches broad and 16 inches deep, or below frost, composed of mixture one part

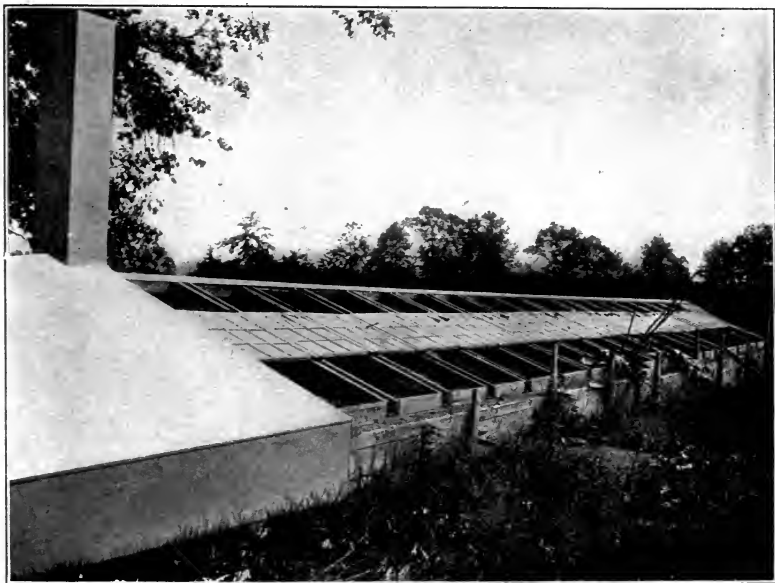

Photo No. 193.

GREENHOUSE, WESTWOOD, N. J.

“ATLAS” Portland Cement, three parts clean, coarse sand, and six parts broken stone. On this and at equal distance from either edge, erect a wall 7 inches thick, mixture one part “ATLAS” Portland Cement, two parts clean, coarse sand, and five parts cinders, to the height required for the walls. A ridge-pole can be erected, 6 inches wide by 8 inches deep, of concrete, one part “ATLAS” Portland Cement, two and one-half parts clean, coarse sand, and five parts broken stone or gravel not over three-quarters inch in size, reinforced with two steel bars each one-half inch in diameter. If total width of

house is not over 16 feet, beams $2\frac{1}{2}$ inches x 5 inches, extending from ridge-pole to side wall, reinforced with a one-half inch bar, will be sufficiently strong to support the sashes.

Reinforced concrete posts 8 inches square should be placed at intervals of 10 feet to support the ridge pole.

Concrete tables $2\frac{1}{2}$ inches thick, mixture one part "ATLAS" Portland Cement, two and one-half parts clean, coarse

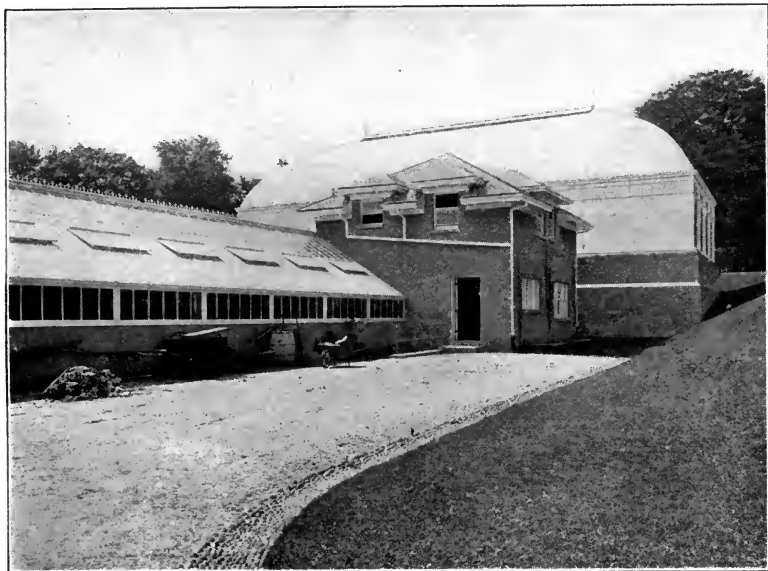

Photo No. 321.

GREENHOUSES, U. S. SOLDIERS' HOME, WASHINGTON, D. C.

sand, and five parts cinders, reinforced with a woven wire fabric, can be built and supported by 4-inch posts of the same concrete.

All concrete should have a coating of one-quarter inch thick of one part "ATLAS" Portland Cement and one part clean sand. This should be put on after the surface to be covered has been picked with a stone axe and thoroughly wet.

HOT-BED FRAMES.

Excavate a trench to a depth below frost and erect forms for a 4-inch wall. Fill with concrete mixture one part "ATLAS" Portland Cement, four parts clean, coarse sand, and eight parts broken stone or gravel, to level of the ground. On

top of these build forms for a 3-inch wall to height desired, and fill with concrete one part "ATLAS" Portland Cement, three parts clean, coarse sand, and six parts of broken stone. Remove the forms in two or three days and keep the walls damp for a couple of weeks.

BOX STALLS.

There is nothing so warm in Winter or cool in Summer as a concrete structure. Concrete box stalls are of immense



Photo No. 181.

BOX STALLS, WESTWOOD, N. J.

advantage on this account, as they prevent a horse becoming restive and ill-tempered. They may be built of concrete one part "ATLAS" Portland Cement, two and one-half parts clean, coarse sand and five parts broken stone. The walls should be 4 inches thick and reinforced with one-quarter inch steel rods 12 inches apart (See Walls). A smooth surface can be secured by plastering the walls one-quarter inch thick with mortar, one part "ATLAS" Portland Cement and one part clean, coarse sand, after they have been picked with a stone axe and thoroughly wet. Concrete water box and manger may be built in with the same mixture as the mortar used in plastering.

SILOS.

Concrete Silos are without question the best, as they are air-tight, too heavy to blow over, will not shrink or collapse when empty, and if properly built will last for ages. They

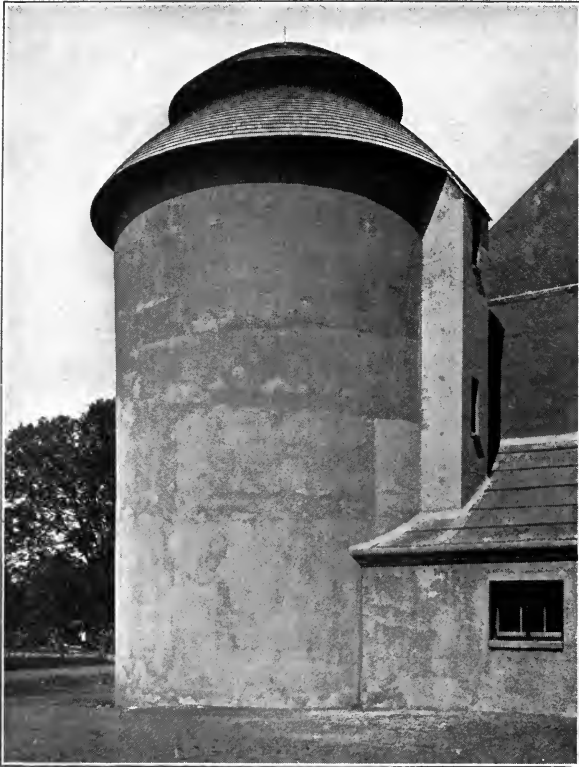

Photo No. 294.

ONE OF THE SILOS, GEDNEY FARMS, WHITE PLAINS, N. Y.

can be built at low cost, provided the walls are not made unnecessarily thick. By using reinforced concrete the thickness of the walls can be reduced to a minimum. Two styles of silos are shown which have proved satisfactory in actual service. The first, a 200-ton silo on the Gedney Farm at White Plains, N. Y., built with a hollow wall, is perhaps preferable in cold climates for the reason that the dead-air chamber between the walls tends to prevent freezing.

Specifications for silos similar to the Gedney Farm silo are as follows:

Excavate to a depth below frost and of the desired diameter, allowing for the thickness of the walls. Erect a 16-inch solid wall, to the level of the ground, with concrete one part "ATLAS" Portland Cement, two and one-half parts clean, coarse sand, and five parts broken stone. After removing the forms fill the excavation inside the walls to within 8 inches of the ground-level, with cinders, gravel or broken stone, and



Photo No. 304.

CONCRETE SILO FOUNDATION, BRICELYN, MINN.

tamp hard. Pick with a stone axe that part of the inside wall that shows above the porous foundation and wet thoroughly. Fill the space on top of the cinders, etc., to within one inch of the foundation, level with concrete, one part "ATLAS" Portland Cement, two and one-half parts clean, coarse sand, and five parts broken stone, tamping well. Erect forms 4 feet high for 3-inch hollow core walls with 10-inch air chamber (See Walls). The details for the necessary forms are shown under "Circular Forms."

Place the forms on the foundation and fill with concrete one part "ATLAS" Portland Cement, two parts clean, coarse sand, and four parts broken stone, tamping thoroughly. Allow concrete to set hard, and after cleaning top of wall with a stiff wire brush, wet thoroughly and raise the forms for the next filling. The raised forms should overlap the walls already built by about 2 inches, which will tend to keep the walls plumb. Continue raising forms until desired height is obtained.

The reinforcing should be one-half inch twisted steel bars placed vertically around the circumference of the outside wall, centered where the walls connect, about every 3 feet. These bars should be set before the first layer of concrete is put into the form and held securely in place by wooden blocks, or tied with wire. Three-eighths inch steel hoops should also be placed in both walls every foot, running entirely around the silo. To prevent moisture soaking through, it would be well to wash the entire outside of the silo with a coat of pure cement mixed as thick as cream and applied with a brush. Spatter-dash may be used if desired. The inside of the silo should be plastered with mortar, one part "ATLAS" Portland Cement and one part clean, coarse sand, one-quarter inch to one-half inch thick, after the walls have been picked with a stone axe and thoroughly wet. The roof can either be made of concrete, or wooden frame and shingles. It should have a ventilator and also a man-hole, which are usually reached by means of a ladder.

Openings for doors should be left about every 3 feet on one side of the silo, for convenience in handling ensilage. A chute running to the full height of the silo should be built around these doors. The chute should be built simultaneously with the wall, and the forms should be so arranged that a perfect bond is obtained. The walls of the chute should be 4 inches thick and reinforced with twisted iron bars running vertically from top to bottom. The size of the chute is optional, 2½ feet at the sides and 4 feet along the face being a convenient size.

The photograph showing the two solid wall silos was taken at the U. S. Soldiers' Home, Washington, D. C., and, through the courtesy of Mr. A. G. Brust, Superintendent of Construction, who built the silos, we are enabled to give specifications prepared by him, as follows:



Photo No. 330.

SILOS, U. S. SOLDIERS' HOME, WASHINGTON, D. C.

Silos, 20 feet diameter, 32 feet high, and walls 12 inches thick.

One part best Portland Cement.

Two parts clean, coarse sand.

Three parts clean, fine gravel.

Four parts clean, broken stone, brick or terra cotta.

The stone to be broken so that it will pass through a 2-inch ring. Any stone may be used, broken cobblestone being excellent for the purpose. If good clean cinders, free from unburned coal, are procurable, they will take the place of stone. If broken brick is used, it must be **HARD BURNED**.

Mix sand and cement together thoroughly, and, when dry, spread out on mixing board and place gravel evenly over same, then on top of the gravel place the stone evenly and spread, after which use sufficient water to make a moderately dry concrete, then throw the whole into a pile in the center of mixing

board and turn over twice, place in the mold and ram thoroughly.

The forms are preferably made about 5 feet long for a 20-foot diameter silo. Take 2 inch x 12 inch joist and saw to the outside diameter, using the inside piece to make the inside diameter form in the manner shown (Fig. No. 36). Make

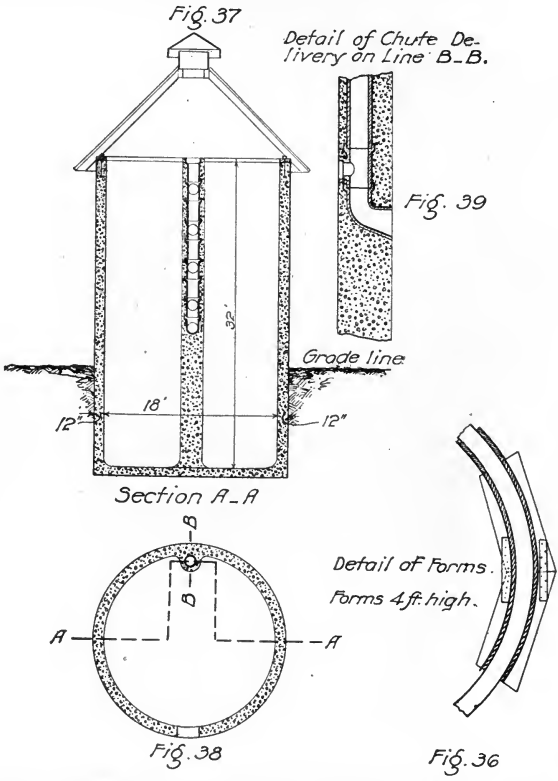

forms about 4 feet high and fill to the top with concrete. The filling of the forms should take about one day, or, in other words, the silo should be brought up 4 feet daily. Set the first form on the foundation, which has been previously put in, see that forms are perfectly plumb, then fill to the top, thoroughly ramming each 6-inch layer of concrete. After concrete has set hard remove the forms and raise them up so as to lap top of wall about 2 inches, then brace in position, and cover top of wall with cement grouting mixed half and half, and fill again, continuing thus to the top. Place anchors in the wall at the top as shown (Fig. No. 37), and make plate of 2-inch x 12-inch

joist cut to form. Make plate of 2-inch thickness lapping one over the other so as to break joints, and spike thoroughly together. Then put on ordinary shingle roof.

The chute is made of 12-inch Terra Cotta Ts and pipe. Use 2-foot lengths and put in as shown in cut (Fig. No. 38). Alternate lengths of plain pipe and Ts are to be used so as to bring the openings 4 feet apart (Fig. No. 39). Use Terra Cotta plugs when filling, which will be removed as the silo is emptied, thus giving access to the chute from the inside.

Put galvanized iron ventilator in apex of roof, as shown. Plaster entire inside of silo with cement and sand in the proportion of two of cement to three of sand, then pebble dash outside.

CULVERTS.

Concrete culverts are coming into general use with the advancement of "Good Roads." They are not only the cheapest, but the most durable, as well as the most artistic. Culverts should be built during the dry season, if possible, and the water diverted during the course of construction. Should this be impracticable, build a dam above the culvert and convey the water past the place where the work is in progress by means of a wooden trough or sewer pipe.

To construct a culvert as shown in the sectional drawing, proceed as follows: (Fig. No. 40.)

Excavate trenches for foundation to a depth below frost and 2 feet 8 inches wide "A A," and at the upper end of culvert connect the two foundations across space E with an 8-inch wall the height of invert B. This is called an apron and will prevent scouring. Build invert B 8 inches thick, having the top on a level with the bed of the stream. Next build forms for part of wall marked CC, with one straight form strong enough to support the arch, and well braced, and the other form as shown on left hand side of cut.

For convenience in keeping the road open for traffic, and the saving in material for forms, we suggest making only nine feet of the culvert at a time. Should this suggestion be accepted, proceed as follows:

Make three semi-circular forms the size required, out of 1½-inch stuff (as shown in Circular Forms), and set them in place three feet apart. Fasten joist 2 inches x 4 inches x 9 feet on them. This is called lagging (See cut). Set the form thus



Photo No. 297.

ROAD CULVERT WITH WING WALLS, NANTIC, ILL.

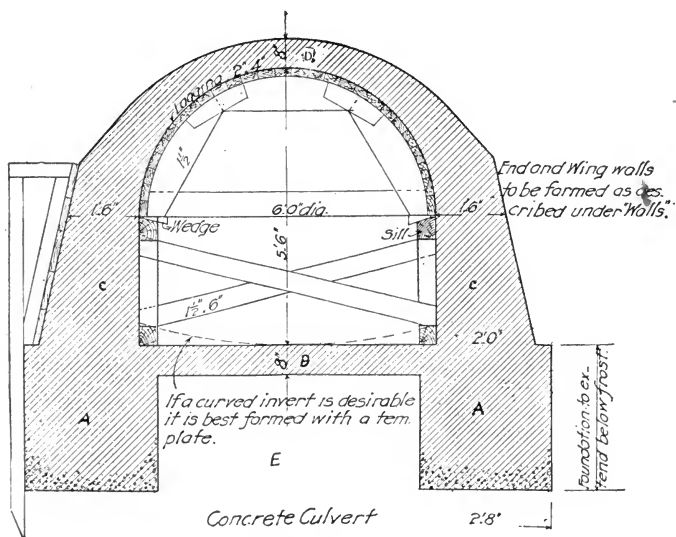

Fig 40

made on large wedges supported by top of form marked "sill." Grease forms well and fill with concrete of a rather wet consistency and tamp thoroughly every 6 inches, taking care not to disturb the form. Let stand until thoroughly dry, about 28 days, and then knock out the wedges, lowering the semi-circular form, which will be easy to remove.

Should the culvert be made all at one time, enough semi-circular forms should be constructed to support the lagging at least every 3 feet.



Photo No. 257.

CULVERT, DES MOINES, IOWA.

Reinforce the concrete with expanded metal, placing it so that it is $2\frac{1}{2}$ inches in from the under side of the arch D and extending down through the walls CC. All concrete should be mixed one part "ATLAS" Portland Cement, three parts sand, six parts broken stone. Should wing walls be required, as shown in accompanying photograph, they should be built at the same time as the foundation, should go to the same depth and be reinforced, the reinforcing connecting with that in walls CC. The width of these walls should be left to the judgment of the man in charge of the work, and built as shown in "Walls."

As an alternative, the top of the arch may be made 10 inches thick, without reinforcing. This method is considered preferable by many engineers for the reason that expanded metal is difficult to handle in an arch, and equally good results can be secured by a slightly thicker arch without reinforcing, and at less cost.

COLORING FOR CONCRETE FINISH.

The use of colored concrete up to the present time has not been general, and the effect of coloring ingredients upon the strength of concrete is not definitely known.

In his book on "Cement and Concrete,"* Mr. L. C. Sabin, an eminent authority, states that the dry mineral colors, mixed with the water in proportions by weight of from two to ten per cent. of the cement, give shades approaching the color used, with no apparent effect on the early hardening of the mortar.

Mr. Sabin also gives the following table, showing the result obtained from a dry mortar (wet mortars give a darker shade):

COLORED MORTARS

COLORS GIVEN TO PORTLAND CEMENT MORTARS CONTAINING TWO PARTS RIVER SAND TO ONE CEMENT.

Dry Material used.	Weight of Dry Coloring Matter to 100 Pounds of Cement				Cost of Coloring Matter per lb. Ct.
	½ Pound	1 Pound	2 Pounds	4 Pounds	
Lamp Black	Light Slate	Light Grey	Blue Grey	Dark Blue Slate	15
Prussian Blue	Light Green Slate	Light Blue Slate	Blue Slate	Bright Blue Slate	50
Ultra Marine Blue	Light Blue Slate	Blue Slate	Bright Blue Slate	20
Yellow Ochre	Light Green	Light Buff	3
Burnt Umber	Light Pinkish Slate	Pinkish Slate	Dull Laven-der Pink	Chocolate	10
Venetian Red	Slate, Pink Tinge	Br'g't Pinkish Slate	Light Dull Pink	Dull Pink	2½
Chattanooga Iron Ore	Light Pinkish Slate	Dull Pink	Light Terra Cotta	Light Brick Red	2
Red Iron Ore	Pinkish Slate	Dull Pink	Terra Cotta	Light Brick Red	2½

* "Cement and Concrete," Louis Carlton Sabin; McGraw Pub. Co., N. Y.

STUCCO.

Stucco-work is cement plastering, and, in one form or another, has been in use for ages. It is durable, artistic, and impervious to weather. For veneering new buildings, or protecting old structures, and wherever the cost of solid concrete is prohibitive, Portland Cement Stucco cannot be equalled.

As a rule, two coats are used—the first, a scratch coat



STUCCO COTTAGE, WOODMERE, L. I., N. Y.

composed of five parts "ATLAS" Portland Cement, twelve parts clean, coarse sand, and three parts lime and a small quantity of hair; the second, a finishing coat composed of one part "ATLAS" Portland Cement, three parts clean, coarse sand, and one part slaked lime paste. Should only one coat be desired, the finishing coat is used. Some masons prefer a mortar in which no lime is used, but this requires more time to apply. In applying Stucco to brick or stone structures, clean the surface of the wall and, after thoroughly wetting, plaster $1\frac{1}{2}$ inches thick. For a finish, either smooth with a wooden float or rough by rubbing with burlap.

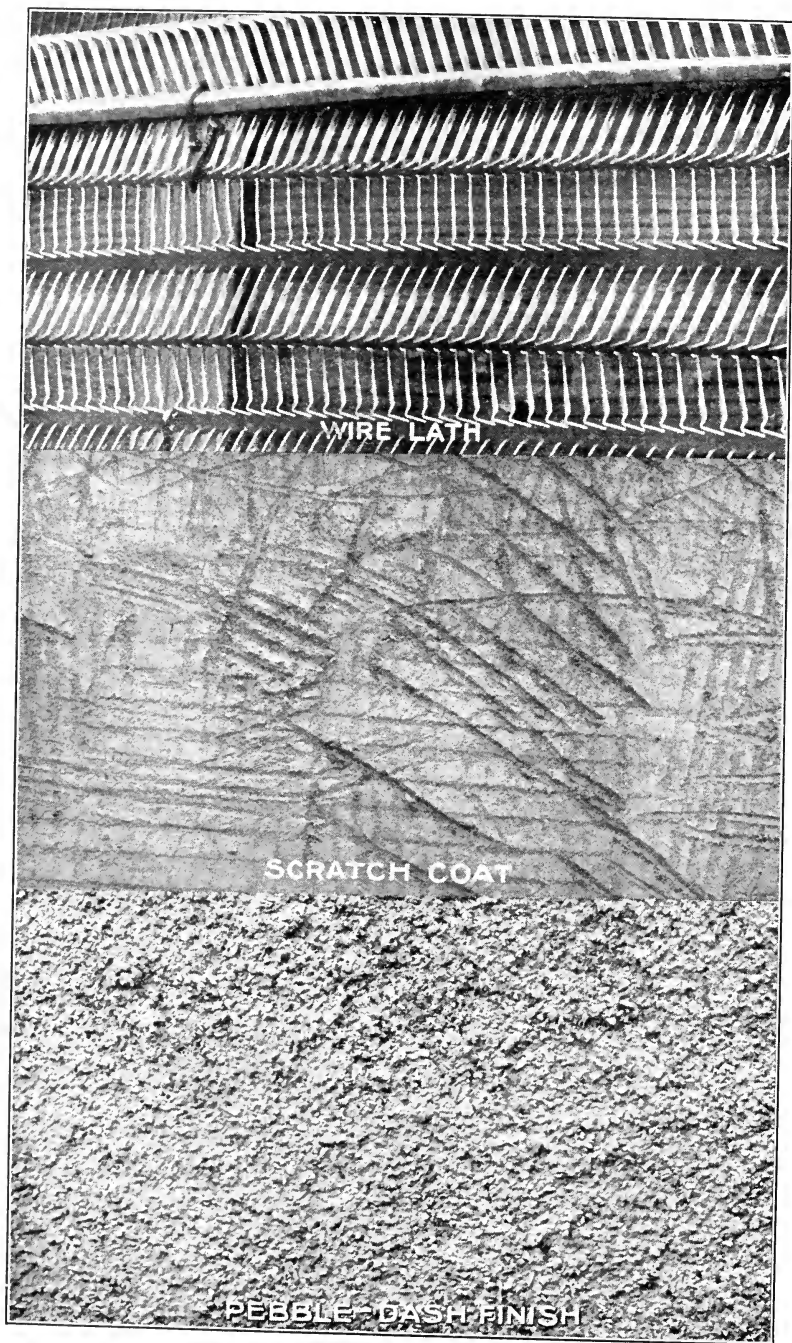

In using Stucco on a frame structure, first cover surface with two thicknesses of roofing paper. Next put on furring strips about one foot apart, and on these fasten wire lathing. (There are several kinds, any of which are good.) Apply the scratch coat $\frac{1}{2}$ inch thick and press it partly through the



STUCCO KITCHEN ON THE ATLAS PORTLAND CEMENT CO.'S FARM,
NORTHAMPTON, PA.

openings in the lath, roughing the surface with a stick or trowel. Allow this to set well, and apply the finishing coat $\frac{1}{2}$ inch to 1 inch thick. This coat can be put on and smoothed with a wooden float, or it can be thrown on with a trowel or large stiff-fibered brush, if a spatter-dash finish is desired. A pebble-dash finish may be obtained with a final coat of one part "ATLAS" Portland Cement, three parts coarse sand and pebbles not over $\frac{1}{4}$ inch in diameter, thrown on with a trowel.



Photo No. 191.

DOG HOUSE, WESTWOOD, N. J.

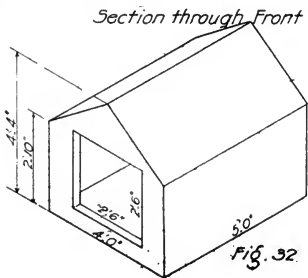
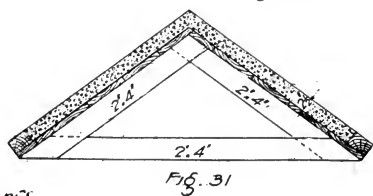
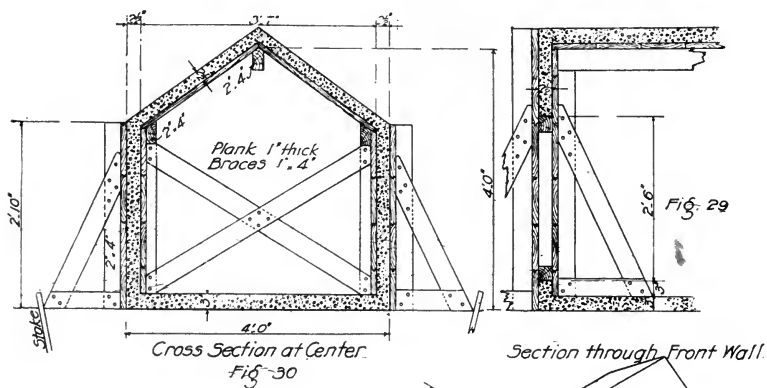



ROTARY JOINTER.
For use in places too small for ordinary style.

Date Stamp



DATE STAMP.
For marking walks, artificial stone, etc.



BRASS JOINTER.
For finishing joints in walks.



JOINTER.
For finishing joints in cement walks, etc.



HAND BRASS JOINTER.
For finishing joints in cement.



FLUTED ROLLER.
For finishing walks, etc.



NAME PLATE.
For stamping names of makers on walks, artificial stone, etc.



TAMP.
For tamping concrete foundations, etc.



CENTRE KNIFE.
For cutting the surface of cement walks into flags.



ROUND CORNER SMOOTHING TROWEL.



ROUND CORNER SMOOTHING TROWEL.
For finishing corners in gutters, etc.



RADIUS TOOL.
For finishing inside or outside edges of circles.



INDENTING ROLLER.
For indenting the surface of walks.



SIDEWALK EDGER.



SQUARE CORNER SMOOTHING TROWELS.



JOINTER.



DRIVEWAY GROVER.



DRIVEWAY IMPRESSION FRAME.
For marking cement driveways.

HAND CONCRETE MIXER.

For sidewalks, foundations artificial stone, etc.

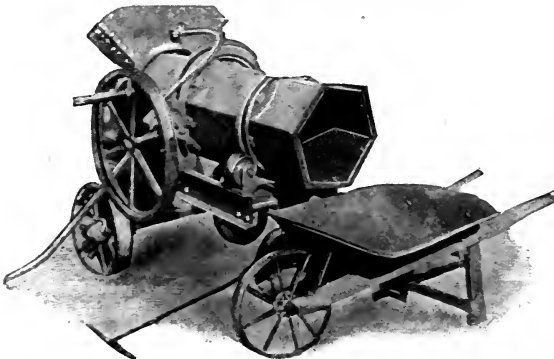

Capacity, 40 cu. yds. per day.

Gives Batch or continuous mix.

Made for hand or power. Portable or stationary. Makes fine or coarse, wet or dry material.



TAMPER.

TOOLS USED IN THE MIXING AND THE WORKING OF CONCRETE,

NOTE.—Cuts loaned by W. H. ANDERSON & SONS, Detroit, Mich.





Photo No. 260.

COW BARN, BABYLON, L. I.



Photo No. 264.

CONCRETE BOX STALLS, BABYLON, L. I.

CONCRETE IN FARM BUILDING.

The following description of the buildings on Gedney Farms was written by Mr. Edward Burnett, the well-known architect, assisted by Mr. Stanley Cunningham. Mr. Burnett planned and executed the entire work, Mr. Cunningham being the engineer in direct charge of the work. Over 7,300 barrels of "ATLAS" Portland Cement was used in these buildings.

"The design and construction of a number of reinforced concrete dairies, barns and other farm buildings has aroused a keen interest in such construction among all progressive farmers and stock breeders. They have seen the great possibilities it possesses for cheap, sanitary and fire-proof buildings, such as the modern requirements for clean milk make advisable, if not imperative. Cleanliness in keeping stock and handling farm products has been made the first essential, and profitable farming requires that the buildings be constructed so that this may be obtained with the least expenditure of labor for the best possible result. It follows directly that stock kept in clean, well-aired barns will thrive better and be less subject to disease than that housed in dirty, ill-smelling, damp buildings, so that it is for both the farmers' and the consumers' interest to take special care of the sanitary conditions on the farm.

A discussion of the possibilities of reinforced concrete construction may best be illustrated by a series of views of what has already been done in this line. Briefly, reinforced concrete, or concrete steel construction is a combination of concrete and steel in structures where each material is relied on to take special strains. Concrete is very strong under compressive stresses, but cannot take tensile stresses of more than small amounts safely. Here the steel comes into play and each material supplements the other in making the structure strong. The combination, properly designed, may be used in floors, walls, columns, beams and roofs, and with the increasing fund of experience with such designs they can be determined with great accuracy and satisfaction.

The farm buildings here shown have been built at Gedney Farm, White Plains, N. Y. Most of them are entirely of concrete, and the plant has been designed with regard to the latest and best ideas in farm building construction and management.

Photo No. 281, page 94, shows a view of the barns. The low wings are the cow barns, each arranged for forty cows. The feed-room and grain storage room is at the junction of the two wings and the hay barn is in the background. The roof of the silo shows to the left of the feed-room roof. The small tower in the centre between the two barns is connected on the back to the milk-room, where the milk is brought after being taken from the cow. Here it is weighed and poured into a large can, which, when full, is hoisted to



Photo No. 281.

SIDE VIEW, MAIN BARNs, GEDNEY FARMS, WHITE PLAINS, N. Y.

a wire rope running from the top of the tower through the upper door and travels on a carrier on this rope to the dairy building, about 200 feet distant.

Photo No. 283, page 95, shows the rear of the barns, etc. The two wings, feed-room and silo are repeated on the other end of the hay-barn, making four wings in all, with two feed-rooms and silos.

Photo No. 261, page 95, shows the interior of one barn wing. Each is laid out either as shown for 40 cows, or in box stalls for bulls and dry stock. The wings are 80 feet

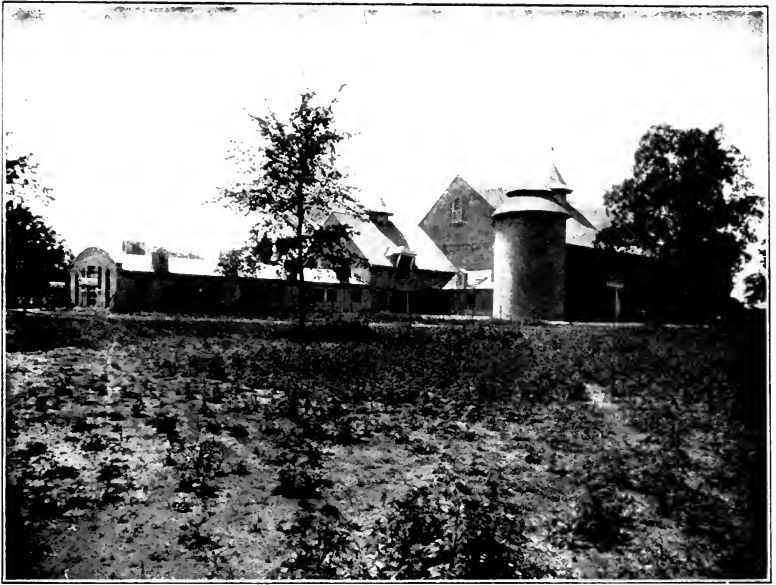

Photo No. 283.

BACK VIEW, BARNS. GEDNEY FARMS, WHITE PLAINS, N. Y.

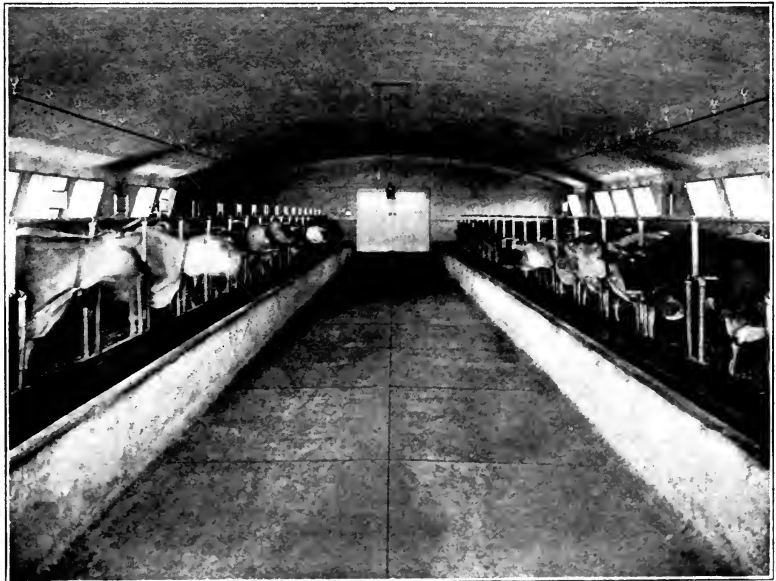

Photo No. 261.

INTERIOR ONE OF THE COW BARNS, GEDNEY FARMS, WHITE PLAINS, N. Y.

long inside and 42 feet wide, with a height of 8 feet at the sides and 11 feet in centre. The walls are of reinforced concrete, two 3-inch walls set 10 inches apart, or 16 inches from outside face to inside face, and joined by a 3-inch web every 3 feet. This forms a hollow wall, except where the columns to support the roof beams occur. The roof is formed with an air space like the walls, a lower slab of 3 inches and a top slab of 4 inches, being separated by 2 feet air space at sides and 2 feet 6 inches at centre. The roof is supported by concrete-steel beams, 5 feet on centers, which are as deep as the roof, 2 feet 7 inches at sides and 3 feet at centre, are 12 inches wide and reinforced with four 1-inch Ransome bars, as well as U bars to take the shearing stresses. The beams have the same curve as the roof, but they are beams and not arches, because they are calculated to have a tensile stress in the lower side and produce no thrust on the side walls. The hollows in the walls make excellent ventilating flues, and in them is installed the "King system of ventilation," the fresh air passing in near the grade level outside, up through the wall and into the barn through ventilators shown in Photo No. 261, page 95, between the windows near the ceiling line, the foul air leaving by ventilators near the floor line inside, and passing up through the roof to the small flues shown in Photo No. 281, page 94. There are also three central air shafts connecting with similar flues along the centre line of the roof. The feed troughs are cast in concrete, with a water inlet at one end and outlet at the other, so that they may be easily flushed out. The stalls are made of 1¼-inch galvanized pipe and fittings bent to shape and set rigid in the concrete. The cows are fastened from each side by chains to a leather collar, instead of by stanchions. The floors are concrete, and the gutter behind the stalls has a double trap which permits of a double system of drainage, the urine draining to a concrete tank built for this purpose near the manure shed, and the wash water running into the rainwater leader drain system. The windows—except for the doors, the only wood in the finished structure—swing on their lower edges and open into iron cheeks which prevent any direct draft on the cattle. The track hung from the roof on either side behind the stalls is for the manure and litter carriers. These are semi-cylindrical hods, hung on rollers from the track, which can be hoisted

and run out through the end doors and dumped into carts. They may be seen outside the barn in Photo No. 281, page 94. The small racks over each stall are for pedigree cards for registered stock and for milk and feed record cards. These barns are warm in Winter and cool in Summer on account of the insulating effect of the dead air space, which makes them very slow to respond to temperature fluctuations. Temperature readings for over a month in Winter showed a maximum variation on the inside face of the wall

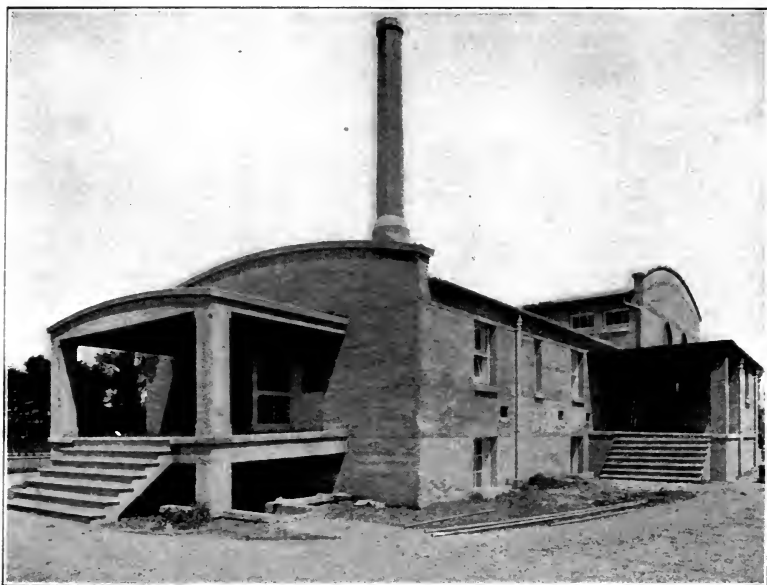

Photo No. 286.

FRONT VIEW, DAIRY HOUSE, GEDNEY FARMS, WHITE PLAINS, N. Y.

of 8 degrees F., when the maximum outside variation of temperature of the air was 25 degrees or 30 degrees. They are finished inside with a hard cement plaster, with all coves and edges rounded off, and can be washed down and scrubbed clean, since there are no cracks in which dirt may lodge.

Photo No. 294, page 78, shows a view of one of the concrete Silos. This is 20 feet in diameter inside, 33 feet high to the eaves, and will hold over 200 tons of ensilage. It is built with two 3-inch walls with 10-inch air space like the barns, reinforced with vertical steel rods and steel hoops

every 3 feet in height. The roof is framed and shingled to correspond with the roof on the main hay-barn, but might easily be built in concrete, as, indeed, the roof of the milk-room is, shown behind the tower in Photo No. 281, page 94. This is a round room 20 feet in diameter, crowned with a dome roof in concrete.

The Silos have proved perfectly satisfactory for keeping ensilage in good condition.

The main hay-barn is built with concrete end walls of the hollow type, as far up as the eaves. These walls continue part

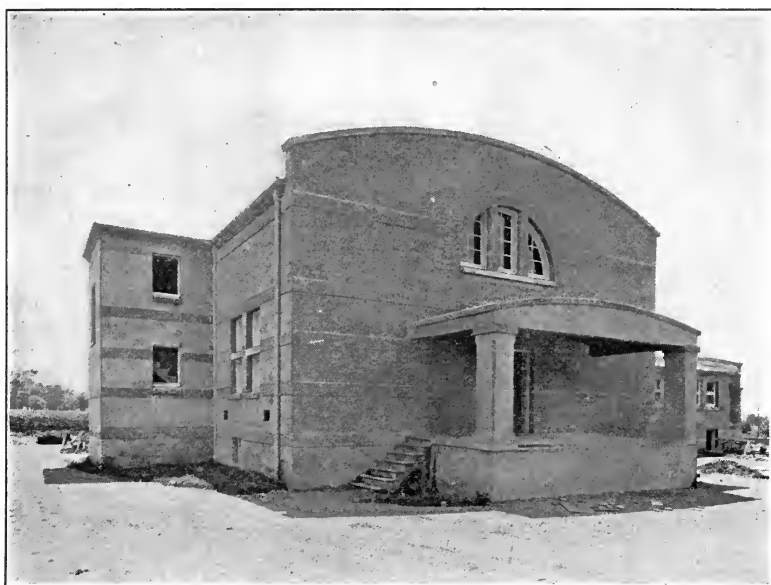

Photo No. 276.

SIDE VIEW, DAIRY HOUSE, GEDNEY FARMS, WHITE PLAINS, N. Y.

way on the sides. The rest of the sides and the gables are sheathed on studs, covered with wire lath and finished in concrete "Spatterdash," making a finish to correspond with the concrete buildings. The roof is shingled. This "Spatterdash" finish is made by first applying a scratch coat of "extra fibre dry mortar" to the wire lath; after this sets, a fine concrete, made of cement, coarse sand and rock splinters not over one-quarter inch, is thrown on with a trowel. The barn is 120 feet x 60 feet inside, and 42 feet 6 inches clear height to the collar beams, which are the lowest cross ties for the roof trusses.

The system of framing is a modification of the "scissors" truss, which is used extensively in the West for barn construction.

The feed-rooms form the junction of the two barn wings on either side of the hay-barn. The first floor, of concrete supported on six columns underneath, is a clear span 42 feet each way, giving plenty of room to handle feed. Above are the grain bins on a concrete floor, with chutes to convey the grain to the room below. The Silos connect with the feed-rooms through the covered passages, and below the feed-rooms are the root cellars, entirely of concrete. This arrangement concentrates the different varieties of feed and makes handling easy. Modern sanitation requires that the cows be kept from under the feed and the manure from under the cows. This makes the modern barn cover a greater area than the old-fashioned type, where the feed, cows and manure formed a descending scale, with very probably a few pigs in the cellar to work over the manure and add to the general smell.

From the barns the milk is sent in cans on a traveller along a wire rope to the dairy building, Photos Nos. 276, page 98, and 286, page 97. Here the main idea is to cool and bottle the milk in perfectly clean bottles as soon as possible after it comes from the cows. This building is entirely of concrete, except for the doors, sash and frames, and is finished inside, like the cow barns, with hard plaster made of one part cement and one part sand, trowelled to a smooth finish. The piping for steam, water and the refrigerating brine is kept as much as possible in the basement. In every room there is a hose bibb outlet, with steam attachment and mixing tee, so that hot water or steam may be drawn from it to wash down and sterilize the building. The usual milk strainers, coolers, bottling tables, separators, cream tempering vats, etc., are set in the dairy. The rest of the equipment consists in part of a churn with butter-worker attachment, to be driven by electric motor, an ice-breaker for crushing ice used in shipping milk, a large sink divided into two parts for washing bottles, etc., with a turbine bottle washer or revolving brush set in its centre, so that two men may use it. This sink is cast in place, of concrete, with the same cement plaster finish as the walls, and it will never crack and lose its glaze, as enamel, earthenware or similar sinks do, nor will it ever work loose in the joints as do those that are built up of soapstone slabs. A view of this is shown in

Photo No. 287, page 100. After the bottles are washed, they are placed in racks on cars and two cars at a time are placed in the pressure steam sterilizer, where the temperature is raised to 240 degees before they are allowed to go into the dairy-room. After the milk is bottled it is placed in the same racks on the cars and run into the refrigerators built on one side of the building. The refrigerators are built with concrete walls, inside which are two walls of plaster blocks separated by an interval of 2 inches for a dead air insulating space, and the inside wall is finished in cement

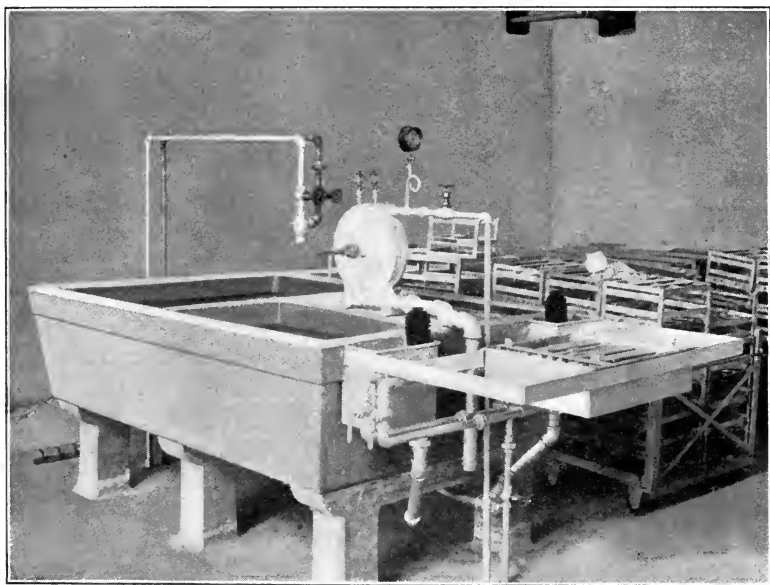

Photo No. 287.

BOTTLE WASHING TROUGH, GEDNEY FARMS, WHITE PLAINS, N. Y.

plastering. They have brine tanks above the cold rooms through which the cold brine circulates to maintain the low temperature. The tanks are supported on a cross slab of concrete, and this has at one side a rising wall, on the other a drop curtain, so that a good circulation and a low temperature may be maintained in the cold room beneath.

Another room in the building contains the refrigerating apparatus, with tank for making can ice. Two rooms near this are arranged for dressing and wash rooms for the dairymen and milkers, in whom personal cleanliness is a primary requi-

site. These rooms, like all the rest, are entirely of concrete, even to the slabs between the shower heads and the clothes lockers. In the basement are the laundry plant, with washing machine, extractor and mangle, with steam engine to run them, a drying room, and the electric lighting and power plant, two 15-kilowatt units to light and supply power for the barns and dairy, etc. The boiler room contains two 30 horse-power

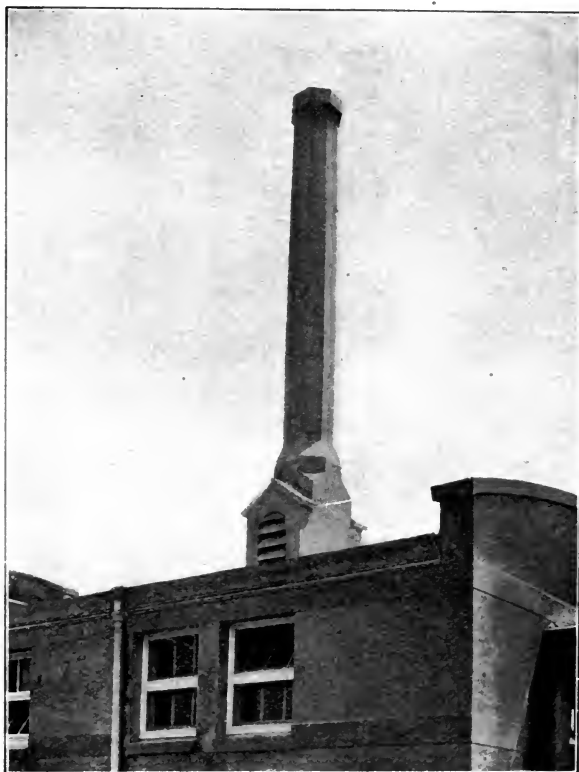

Photo No. 291.

CONCRETE CHIMNEY, DAIRY HOUSE, GEDNEY FARMS, WHITE PLAINS, N. Y.

boilers connected to a reinforced concrete stack about 24 inches diameter inside, of 3 inches concrete wall at the top, with 2-inch batter each way, rising 50 feet above the grates. This chimney is octagonal, inside and out, for greater ease in constructing the forms, as is shown by Photo No. 291, page 101. The end of the building shown in Photo No. 286, page 97, is the general office for the farm, with connection by telephone to every other building.

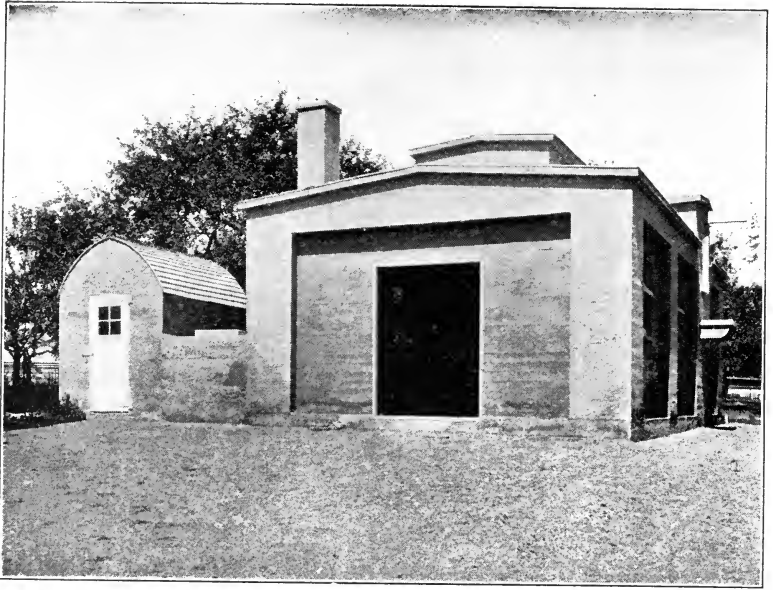

Photo No. 280.

SLAUGHTER AND SMOKE HOUSE, GEDNEY FARMS, WHITE PLAINS, N. Y.

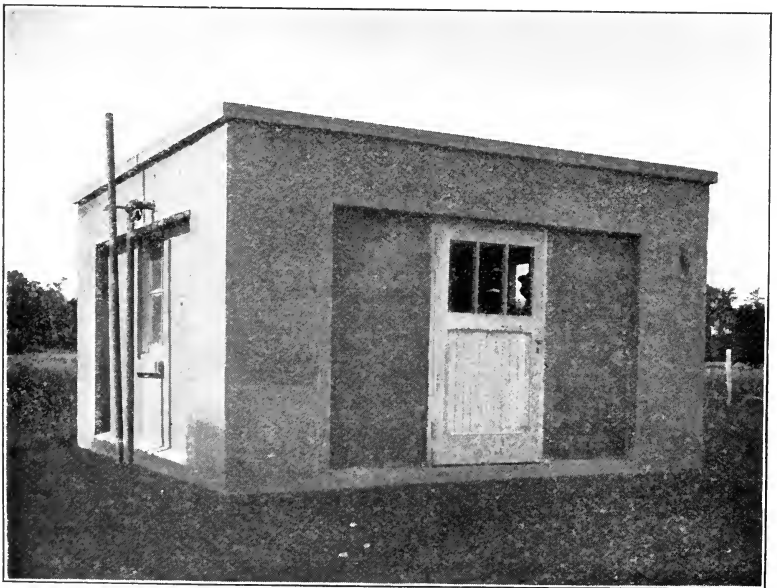

Photo No. 275.

PUMP HOUSE, GEDNEY FARMS, WHITE PLAINS, N. Y.

The manure pit, Photos Nos. 288 and 277, page 104, to which the manure is carted from the barns, is 110 feet x 42 feet, with a roof supported on three columns, which is of the same curve as that of the cow barns inside, the difference being that there is no ceiling slab to conceal the beams. The wall construction here differs from that in the barns. The pilasters were cast first, and then the roof, while the curtain walls between the pilasters were run in later, or might have been left out altogether, as they do not form an integral part of the structure. Near the manure pit is a piggery, Photo No. 282, and Photo No. 285, page 64, of the same type as the barn wings, 106 feet x 28 feet, with a small feed-room at one end. The pen walls are all of concrete, and the picture shows the troughs, with the iron doors swung over them, so that the pigs are kept out of the troughs till they are filled, when the door is swung out and fastened to the outside edge of the troughs by the bolts shown.

The same system of ventilation is installed here, with the same windows and cheeks as in the cow barns. The outside pen doors are iron, and the whole building can be, and is, kept as clean as the barns. It forms the most striking object lesson of any of the buildings on the possibilities of concrete in construction of sanitary buildings, and is justly entitled to the name of "Pig Palace," which it is called in the neighborhood. There is no wood in the building to become offensive after constant use, and there is no lodging for any of the germs of the various pig diseases whose ravages prove so disastrous in unclean piggeries.

Outside are the pig runs, separated by wire fences, with small, shallow concrete basins at the ends, where the hogs may lie in water in hot weather. Behind the piggery are the runs on earth in the orchard, at the end of which is a tunnel under the road, built of concrete, through which the pigs may run to the field beyond without crossing on the road.

Close to the piggery is the slaughter-house, with smoke-house adjoining, shown in Photo No. 280, page 102. The slaughter-house will be seen to be of the same type of pilaster and curtain wall construction as the manure pit, with a difference only in the shape of the roof. It contains a scalding basin and scraping table, both of concrete, for removing the hair from the hogs, and a boiler to supply steam



Photo No. 288.

MANURE PIT, GEDNEY FARMS, WHITE PLAINS, N. Y.

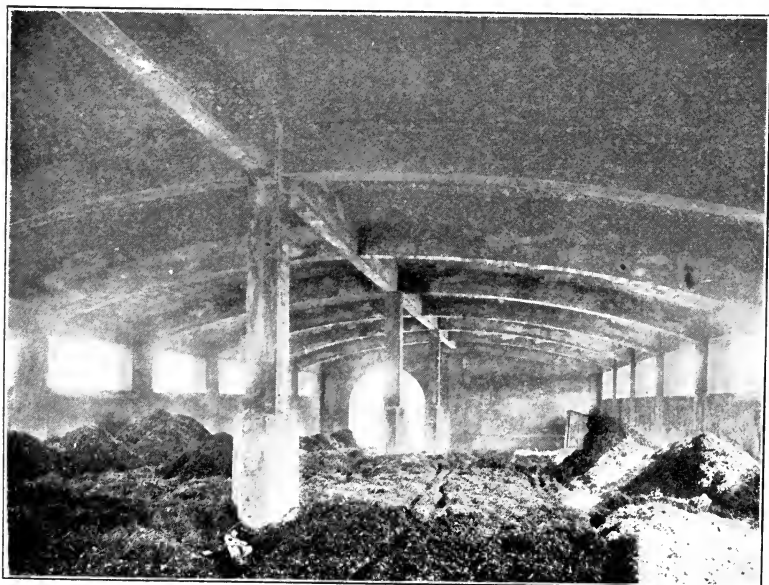

Photo No. 277.

INTERIOR MANURE PIT, GEDNEY FARMS, WHITE PLAINS, N. Y.

for heating the water. A refrigerator of the same type as those in the dairy, of a smaller size, serves for storing pork. This refrigerator is built with triple walls, like that in the dairy, but these walls are all three of concrete, and the result is a stronger refrigerator. The ice bunker is filled from the outside from platform on the extreme right-hand side of Photo No. 280, page 102. The smoke-house is a concrete building, 6 feet x 8 feet inside, with shingle roof to allow the



Photo No. 386.

HORSE BARN, GEDNEY FARMS, WHITE PLAINS, N. Y.

smoke to pass out through cracks in the shingles, as well as through ventilators in the ridge-piece. Between the slaughter-house and smoke-house is the coal bin for the boiler, with chute opening into the slaughter-house, and having storage for about four tons of coal.

The pump-house, of similar construction to the slaughter-house, is built over an artesian well, in a marsh, and contains a gasoline engine connected direct to a pump. Concrete construction recommends itself strongly here on account of the wet character of the soil, which would be likely to rot out in the course of a very few years any building erected on wooden piles or floored with wood.

A farm stable to contain forty-two straight stalls and sixteen box stalls is shown in Photo No. 386, page 105. This, when completed, will be entirely of concrete except the roof, which is framed and shingled in the usual style, and lathed inside with wire lath on furring strips. On the wire lath a scratch-coat plaster is applied, after which the cement plaster is put on and trowelled smooth, giving the same surface as that in the cow-barns. This is an interesting alternative mode of construction where lumber is cheap—it gives about the same sanitary result inside, though it is not so thoroughly fireproof.

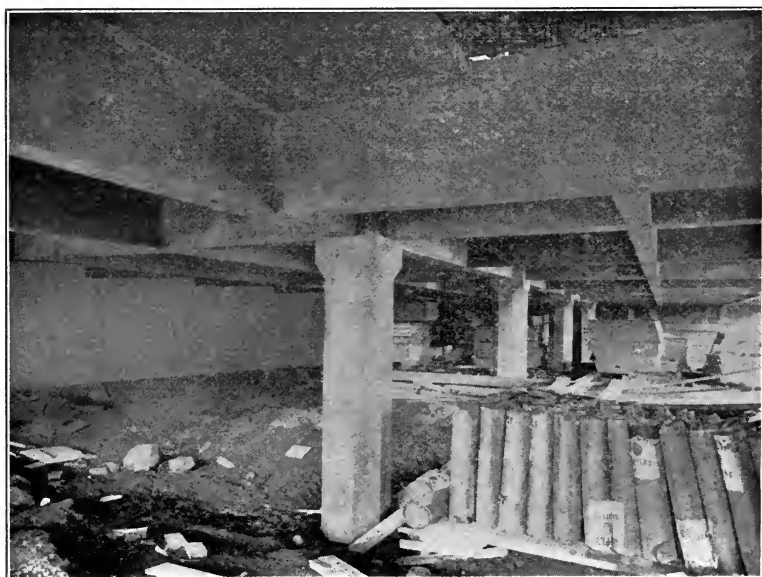

Photo No. 273.
DETAILS OF PIERS AND FLOOR BEAMS UNDER HORSE BARN, GEDNEY FARMS,
WHITE PLAINS, N. Y.

In the basement of the main building will be kept wagons, etc.; on the first floor are the harness and feed-rooms, and on the second, grain and hay storage and three men's rooms. The straight-stall barn and box-stall barn form wings to this building on two sides of a square; the shed for wagons completes the other two sides, forming a courtyard, with entrance at one corner. The concrete floor construction is shown in Photo No. 273, page 106, which is the lower side of the harness room, or first floor. This floor is calculated to sustain

a flood load of 150 pounds per square foot besides its own weight, and the second floor, where the grain and hay are stored, will carry 250 pounds per square foot. Oats weigh on an average 32 pounds per bushel, or about 25 pounds per cubic foot, and baled hay not over 10 pounds per cubic foot. This allows grain to be stored ten feet deep on this floor, which will, therefore, hold many carloads.

Besides its use in the farm buildings, concrete has found its place in a number of other ways on the farm. Photo No.



Photo No. 279.

CONCRETE FENCE, GEDNEY FARMS, WHITE PLAINS, N. Y.

279, page 107, shows a concrete rail fence and posts, with gateway, built to enclose the courtyard on the south side of the cow-barns and hay-barn. The rails are 4 inches x 9 inches, and about 16 feet long, cast in separate forms and put into place between the posts when the concrete has set hard. They have a one-quarter inch rod in each corner for reinforcing, and have a one-quarter inch stirrup every two feet of their length. The fence posts and gate posts were cast in position, with a groove on each side, into which the rails are afterwards dropped, and the space between them in the groove filled with concrete. It is not necessary that the rails

be so large or heavy—they were made that size to correspond to the buildings—2-inch x 6-inch rails would be perfectly feasible to cast.

Another concrete structure is the curved retaining wall which supports the road embankment on the west side of the dairy. This was built of rough concrete by putting up forms

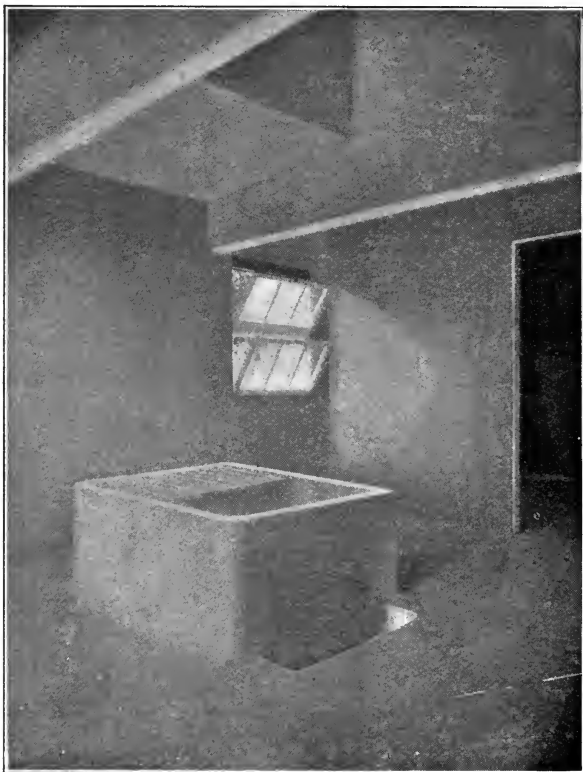

Photo No. 289.

INTERIOR SLAUGHTER HOUSE, GEDNEY FARMS, WHITE PLAINS, N. Y.

for the outside face and banking up the earth on the inside for the inner form. This method is not entirely to be recommended where a strong concrete is desired. Here it did very well, and saved labor of building the inside form, which would have been quite an additional expense. Concrete has also been used in the stairs in various places in the group of buildings. Photo No. 290, page 37, shows a flight of stairs to the basement of the dairy building, and Photo No. 286,

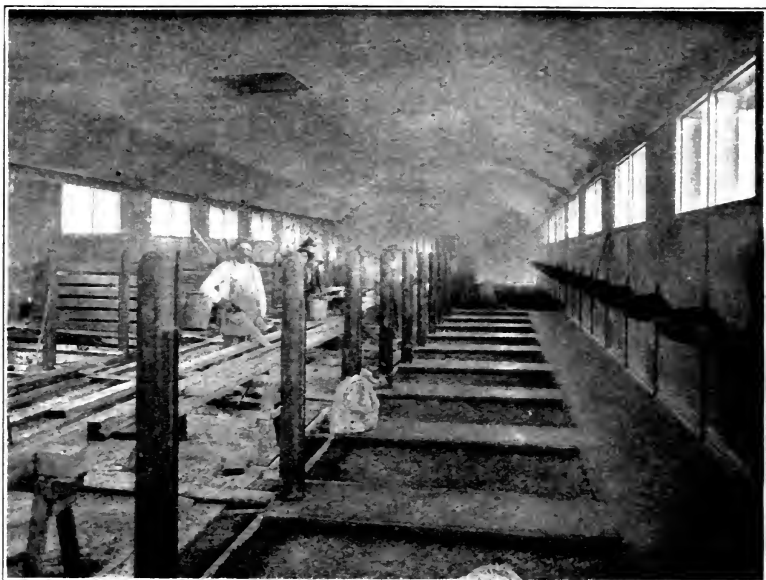

Photo No. 274.

INTERIOR HORSE BARN, GEDNEY FARMS, WHITE PLAINS, N. Y.

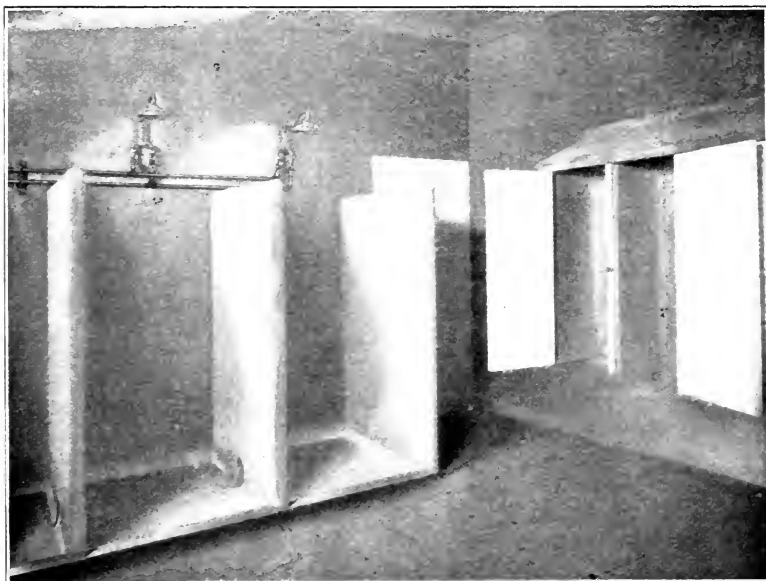

Photo No. 284.

SHOWER BATHS AND LOCKERS, GEDNEY FARMS, WHITE PLAINS, N. Y.

page 97, shows the stairs to the porch outside the office. The interior stairs were made by casting the stringer first, with an offset on the inside to rest the risers on, which were cast separately and set in place on the stringer. The outside stairs were cast all at once, which is cheaper where there are but a small number of steps, or where they are broad.

Photo No. 278, page 51, shows a trough, one of a number that were built in various fields for watering the stock. Some of these have been arranged with a ball-cock, boxed in to prevent derangement, which keeps the water at a constant level. Forms for such troughs were made like two boxes, one inside the other and braced, with just enough steel reinforcing to prevent cracking from shrinkage or cold.

The general method of constructing these concrete buildings, which have hollow walls, is shown very clearly in Photo No. 293, page 42. Here the foundations have been cast, the outside forms are up, the frames for the window and door openings are in place, and the core boxes which form the air spaces in the walls and the flues for the "King system of ventilation" are shown in their proper position. The vertical steel rods are the reinforcing for the wall columns to carry the roof beams, and horizontal steel rods for the wall reinforcing are partly up. These horizontals are fixed to the core boxes on wooden stops or buttons, to maintain their proper distance from the face of the wall. A few of the inside forms are shown ready to be raised in place against the cores and held by stops 16 inches away from the outside form. These outside and inside forms will then be bolted together through 4-inch x 4-inch timbers laid horizontally across the 2-inch x 6-inch verticals. The bolts run through tin sleeves made of 1-inch speaking tube, so that they may be easily withdrawn after the concrete is set. After the walls are set, the centering will be built for the roof, supported strongly by braces and shores. The roof is cast in sections running all the way across, each section representing one day's work. The lower slab is put on first, then core boxes the shape of the roof are placed on it, the steel reinforcing laid on them and between them, and then the top slab and beams cast. The beams are formed by spacing the core boxes about one foot apart. The ventilators

on the roof are built later, when the roof has set. They are entirely of concrete.

Throughout this group of buildings the attempt has been made to develop the possibilities of concrete construction, though by no means to the utmost of its limits. It has proved itself a solid, clean, fairly cheap mode of construction. Carpenters are needed to build and erect the forms. They will have no difficulty in doing this, if they remember that they are building the reverse of a structure. The concreting may be done by a gang of untrained men under the guidance of an experienced foreman. The finishing may be done by ordinary plasterers or masons after a little practice in working with the cement mortar. Buildings which have no special need of this smooth finish may be roughly pointed up and painted with cement and sand grouting. Outside, the buildings are tooled with stone axes to give a rough stone finish. The concrete used on the Farm was made entirely of crushed field stone from the stone walls, etc., which contained much mica, quartz, etc., producing a very pleasing color on the buildings after tooling. This is, incidentally, a very good way to get rid of the aforementioned stone walls, which are irregular, bulky and a harboring place for weeds. If a gravel bank is available, the gravel may be graded by screening to make the proper aggregate for the concrete, or possibly the "run of the bank" may be good enough. This solves the problem of material readily, especially if the cement can be shipped by car-load to a point within easy hauling distance.

The lumber for forms may be used over and over again if used with care, though the loss each time in buildings where the design does not repeat itself is considerable. The concrete roofs are covered with a tar felt, washed over with tar and covered with slag, to make them perfectly water-tight. The buildings also have a layer of felt and tar in the floors for a damp course, to prevent the cold and dampness striking through.

When a concrete building is completed, the owner realizes that he has got something that cannot wear out, burn up or decay. It is there for all time. It may be kept clean and free from vermin. It will stand all shock of wind and weather, and if it is desired to be rid of it later, dynamite alone will destroy it. There will be no depreciation, no repairs, no sink-

ing fund toward replacing it required, no fire insurance to carry—in fact, the first cost is the last cost. As a business proposition, that is attractive. From a sanitary standpoint it proves itself equally good. It can be washed down, scrubbed, disinfected, steamed and sterilized to destroy germs, and may be kept clean with the least expenditure of labor. Concrete proves useful in a thousand ways. Wherever wood decays and requires replacing, concrete will end all trouble. The number of uses to which it may be put are beyond estimate. Each builder will discover its special applications to his own requirements.”

*E. Burnett,
S. Cunningham jr*

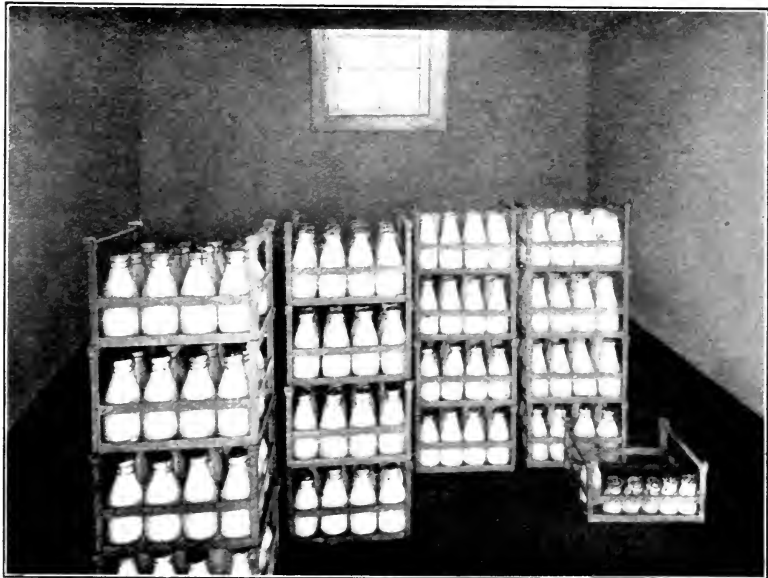

Photo No. 234.

STEPS AND RETAINING WALLS FOR CONCRETE WALK AND GRAPE ARBOR,
ST. CHARLES, ILL.



BOTTLING ROOM, DAIRY HOUSE, BROOKSIDE FARMS, NEWBURG, N. Y.



INTERIOR OF CONCRETE ICE BOX, BROOKSIDE FARMS, NEWBURG, N. Y.

Mr. S. L. Stewart, the well-known expert on certified milk, has written the following description of his place at Newburgh, New York. "ATLAS" Portland Cement was used exclusively in connection with this work:

"Sanitary conditions are as necessary for the welfare of animals as for human beings, and the trend of the up-to-date farmer is to have his buildings hygienic throughout. Cattle thrive better and give better service under such conditions, insuring to the farmer greater returns for the money and labor



Photo No. 380.

DAIRY HOUSE, BROOKSIDE FARM, NEWBURG, N. Y.

invested. Concrete is the only material for strictly sanitary buildings. They are easily kept clean, for the entire absence of cracks makes it impossible for dirt, germs and vermin to collect. The whole interior may be flushed from top to bottom with hot steam or washed with an antiseptic, thereby providing a perfectly clean, sanitary home for the live stock.

"The cow barns and dairy house at Brookside Farms were built with concrete, keeping the above conditions in mind, and the results obtained have more than justified the experiment. The cow barn is built with concrete floors and side walls, the

roof being of the ordinary shingle type. The walls, which are hollow, make the structure warm in winter and cool in summer, the air acting as a non-conductor, and forming an easy means of installing the "King system of ventilation." Concrete feeding floors and gutters are used, as shown in the photograph. A damp-proof course between the layers of concrete on the barn floor does away with all dampness conveyed from the ground, adding to the comfort of the animals. The dairy

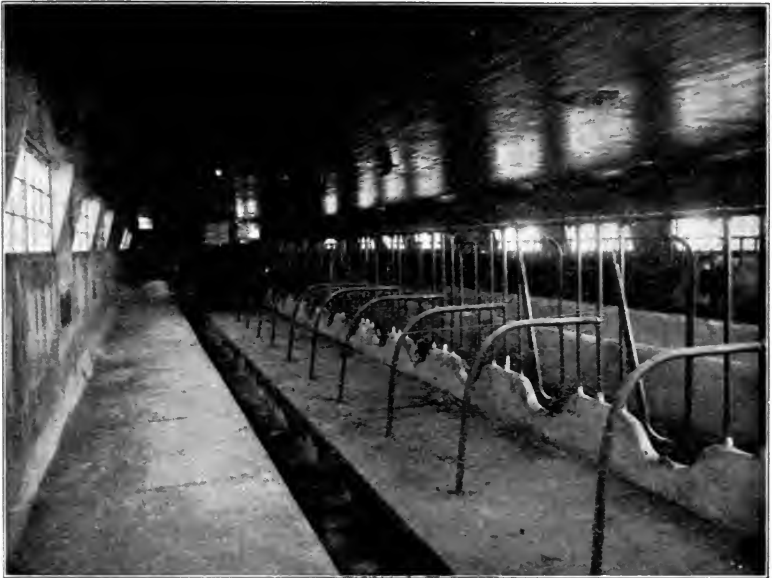

Photo No. 378.

INTERIOR COW BARN, BROOKSIDE FARMS, NEWBURG, N. Y.

house, built in 1903, is concrete throughout, being the first of its kind in the United States. The walls of the dairy house are of the hollow type, two 3-inch walls, with a 10-inch air space. Inside there are five rooms—the receiving room, built above the bottling room (see page 113); the bottle washing room; the men's wash room, which contains a sterilizing closet, shower baths and clothes closet, all of concrete; and the cold storage room or refrigerator (see page 113). The refrigerator is entirely of concrete, having four 2-inch walls with one 10-inch air space and two 4-inch air spaces. (A photograph of the interior of this refrigerator is shown on page 113.) This refrigerator has proved more than satisfactory.

The results obtained from this form of construction are exemplified by the records of the New York County Milk Commission. Samples taken from Brookside Farms show sterile plates during the years 1904 and 1905. These were the only sterile samples submitted to this Commission during those years, and is considered largely due to concrete construction, which makes it possible to apply surgical cleanliness to dairying."

S. L. Stewart.

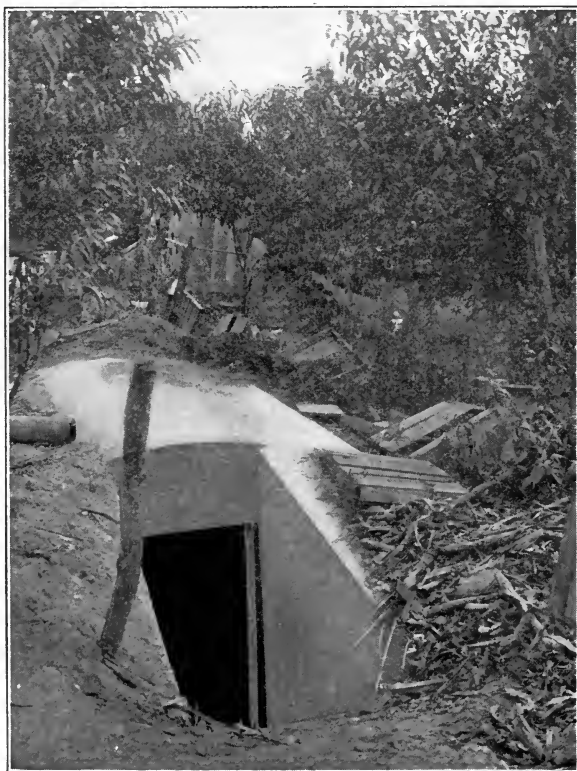

Photo No. 303.

MILK CELLAR, DECATUR, ILL.

We have selected two well-known places where "ATLAS" Portland Cement has been used, that contain some interesting features in concrete construction, for a short general description.

A most interesting place from the suburbanite's point of view is the home of Mr. W. N. Wight, of Westwood, New Jersey.

The photograph shown on page 117 is Mr. Wight's residence. This house is concrete throughout. The foundation is rough field-stone set in cement mortar. The walls to the first floor are concrete 1 : 2 : 5 cinders with pebbles about 2



Photo No. 190.

RESIDENCE OF W. N. WIGHT, CONCRETE THROUGHOUT.

inches in diameter set in by hand after the forms had been removed and before the concrete had taken its final set.

The clapboard effect on the second story was produced by placing 1 : 1 mortar over the concrete and lining it off to represent wood. The shingles under the eaves are also of concrete. They were put on in layers, before the concrete had set so as to form a bond, one layer being placed over the other. The interior of the house is concrete throughout. The photograph on page 62 shows the steps, porch and lat-



Photo No. 186.

REAR VIEW, RESIDENCE OF W. N. WIGHT, WESTWOOD, N. J.

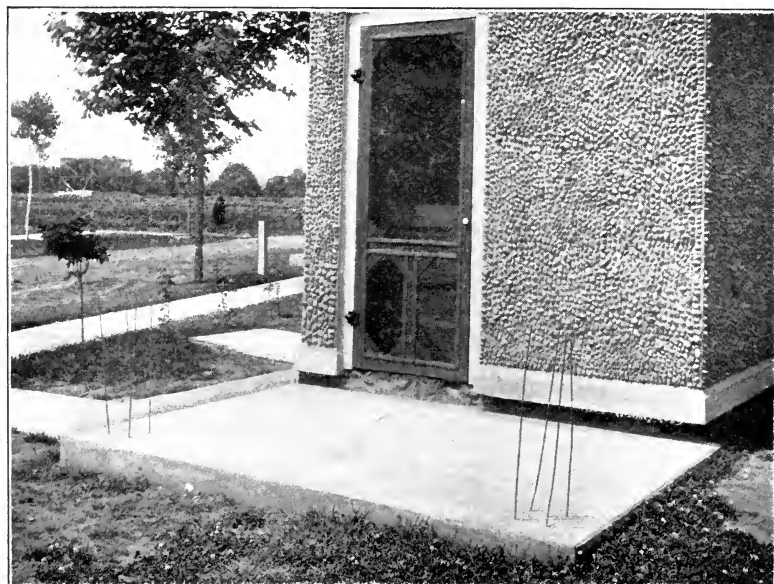

Photo No. 188.

DETAIL OF CONCRETE PEBBLE FINISH RESIDENCE, W. N. WIGHT, WESTWOOD,
N. J.

tice at the front of the house. The photograph on page 118 shows the back entrance and a concrete slab, at the corners of which is the reinforcing for two posts. A preserve closet is shown on page 125. The shelves, it will be noticed, have no support other than that received from the walls. The stairs leading to the cellar are shown on page 35 and are described under "Steps and Stairs." The horse-block, hitch-



Photo No. 184.

DOORWAY, CONCRETE BARN. FORMS SET FOR CEILING, WESTWOOD, N. J.

ing-post, and sidewalk are shown on page 57. Photograph on page 119 shows the interior of barn with the forms for the first floor in place.

The house shown on page 120 is built of solid concrete with wood trimmings. This house cost, complete, including plumbing, \$3,850.00. The barn adjoining has concrete walls



Photo No. 187.

CONCRETE HOUSE, WESTWOOD, N. J.



Photo No. 192.

RUBBLE CONCRETE BARN, WESTWOOD, N. J.

and ordinary shingle roof—inside are concrete box-stalls, see photograph, page 77. The next group of buildings belonging to Mr. Wight are the chicken-house, page 67, greenhouse, page 75, and mushroom cellar, page 73, built entirely of concrete. Throughout the construction cinders were used instead of stone or gravel and for reinforcing “Lock Woven



Photo No. 197.

CONCRETE STOVE, WESTWOOD, N. J.

Steel Fabric” was used. The dryness of these buildings is attributed by their owner to the use of cinders, which he contends take up the moisture, the voids acting as a dead-air space in the wall.

At the United States Soldiers’ Home in Washington, D. C., concrete has almost entirely taken the place of other



Photo No. 324.

WAGON SHED, U. S. SOLDIERS' HOME, WASHINGTON, D. C.

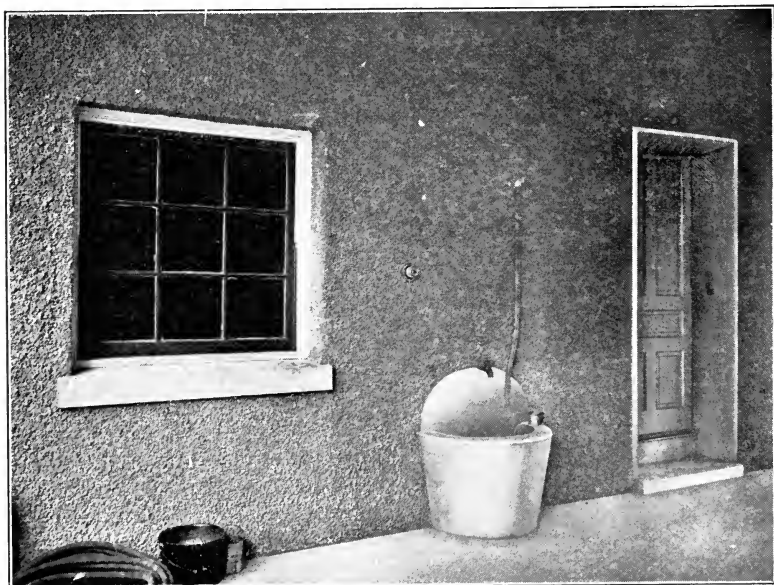

Photo No. 318.

WASH TROUGH, WINDOW AND DOOR SILLS, U. S. SOLDIERS' HOME, WASHINGTON, D. C.

forms of construction on the farm buildings. The cow-barn, page 124, the wagon-shed, page 122, the silos, page 81, the green-houses, pages 74 and 76, all testify to the superiority of concrete construction. These structures were all built with solid walls and lean mixtures of concrete, one part "ATLAS" Portland Cement, two parts clean, coarse sand, three parts clean, fine gravel, four parts broken stone, brick or terra-cotta, being the general rule, although in the cow-barn



Photo No. 320.

ENTRANCE TO ROOT CELLAR, U. S. SOLDIERS' HOME, WASHINGTON, D. C.

as lean a mixture as one part "ATLAS" Portland Cement, 20 parts sand, gravel, and broken stone was used. These mixtures are not recommended by us, but simply go to show the great strength that is attained by "ATLAS" Portland Cement Concrete. The photograph on page 55 shows a fifty-foot watering trough in the field near the cow-barn. On page 124 is shown the feed trough in the cow-barn. Detail of the pebble-



Photo No. 325.

FEED MIXING TROUGH, U. S. SOLDIERS' HOME, WASHINGTON, D. C.



Photo No. 327.

COW BARN, U. S. SOLDIERS' HOME, WASHINGTON, D. C.

dash used on the outside of all the buildings, silos and water basin is shown on page 88. On page 126 are shown two photographs of the interior of the cow-barn; one the individual feed-troughs for the cows, and the other the concrete tank for washing the milk-cans. On page 123 is a photograph of the



Photo No. 195.

FRUIT CELLAR, W. N. WIGHT, WESTWOOD, N. J.

entrance to the root cellar, which is under the wagon-shed. The rear view of the greenhouse, shown on page 76, and the steps leading to it are shown on page 33.

Most of these buildings were built in 1900, and at the present time are in better condition than on the day they were

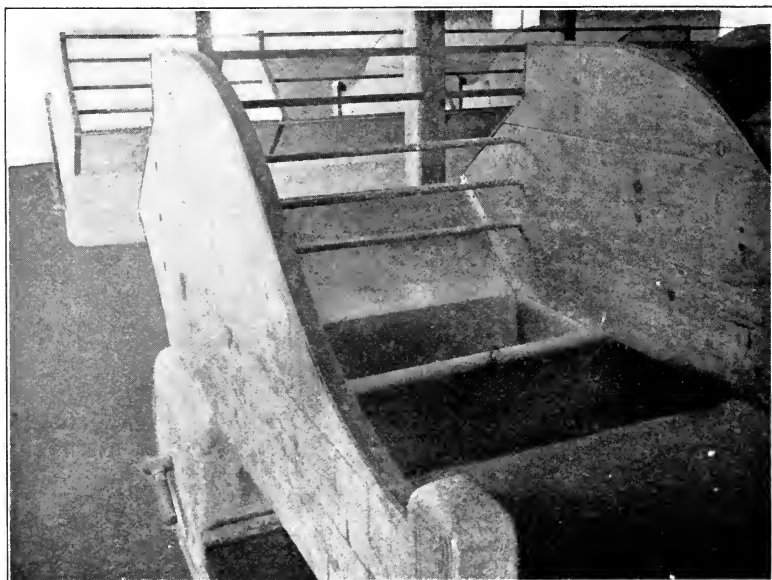

Photo No. 326.
INDIVIDUAL FEED TROUGH, COW BARN, U. S. SOLDIERS' HOME, WASHINGTON, D. C.

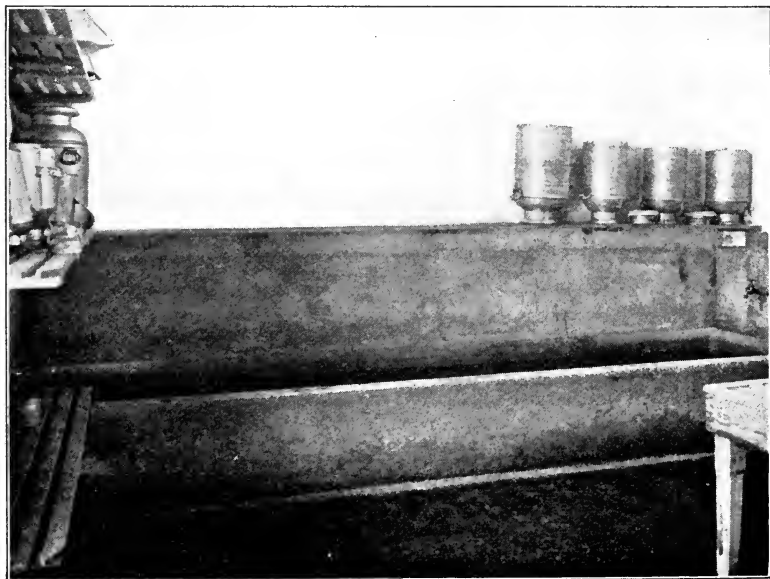
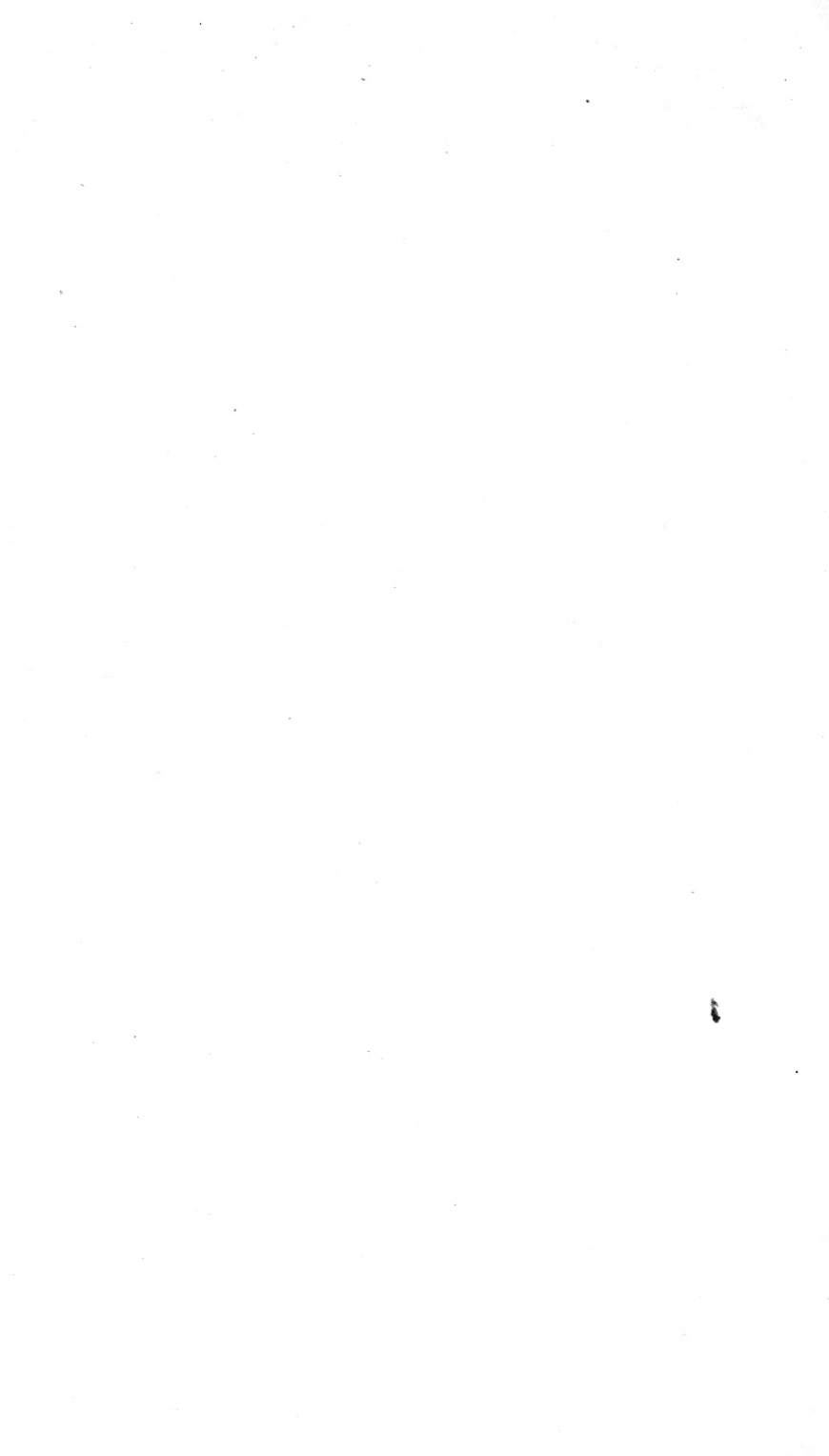

Photo No. 329.
CAN TROUGH, DAIRY HOUSE, U. S. SOLDIERS' HOME, WASHINGTON, D. C.

finished. They were originally designed to be built of stone, brick or wood, and the specifications were drawn accordingly—the final cost when built of concrete was considerably less than the estimated cost of other construction.





**Ask Your Dealer for Price
on "Atlas"—if he does not
carry it in stock, write to
The Atlas Portland Cement Co.,
Sales Department,
30 Broad Street,
New York City.**

THE STANDARD
AMERICAN BRAND

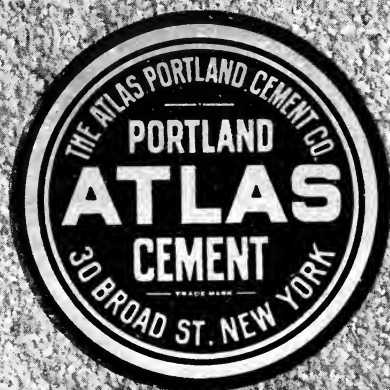

ALWAYS UNIFORM

YC 66712

14 DAY USE
RETURN TO DESK FROM WHICH BORROWED
LOAN DEPT.

This book is due on the last date stamped below, or
on the date to which renewed.

Renewed books are subject to immediate recall.

29Jan'57BC

REC'D LD

FEB 1 1957

D 21-100m-6,'56
9311s10)476

General Library
University of California
Berkeley

