

XA
.M45

vol. 14
1908

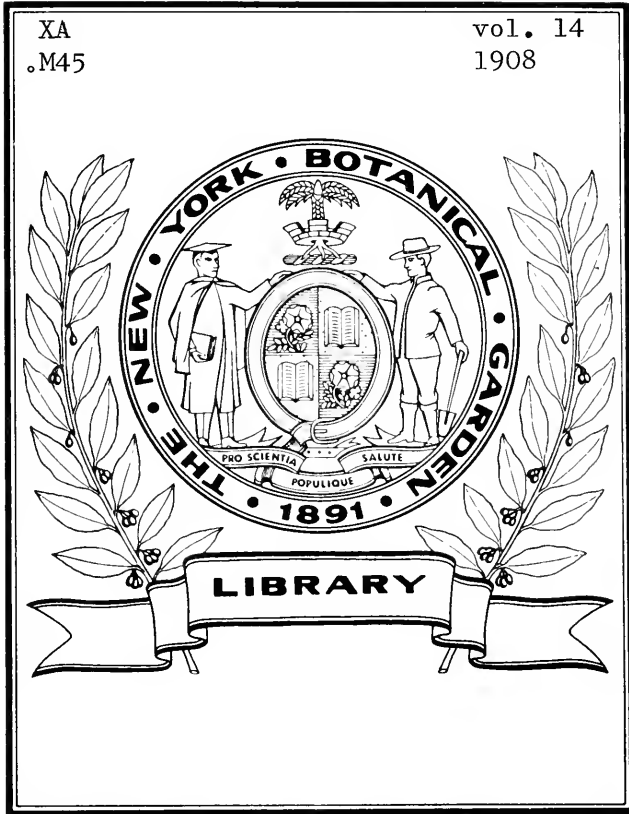

FORESTRY AND IRRIGATION AND CONSERVATION

OFFICIAL ORGAN OF

THE AMERICAN FORESTRY ASSOCIATION

VOLUME XIV—1908

THE AMERICAN FORESTRY ASSOCIATION
PUBLISHERS

WASHINGTON, D. C.

GENERAL CROSS REFERENCES

For names of states, see sub-titles under Forestry Associations, Forestry Schools, Private Irrigation, State Work in Forestry, and Women's Clubs.

For names of separate forestry schools, see list under Forestry Schools.

For names of foreign countries, see Foreign Countries, Forestry in.

For names of different national forests, see National Forests.

For names of separate reclamation projects, see U. S. Reclamation Service.

.M45
vol. 14
1908

CONTENTS OF VOLUME XIV

<i>Page</i>	<i>Page</i>
Acklen, Joseph H.	277
Adams-Williams, Lydia—See Williams, Lydia Adams	
Agitation for Forestry—See Public Opinion.	
Alaska, New Minerals Discovered in... 69	
Allyn, Henry Gregory article by.....	623
American Forest Preservation Society—See Forestry Associations	
American Forestry Association:	
Annual Meeting.....	66.
124, 133, 143, 148, 153, 198, 217, 500, 635	
Directors' Report.....	153
Letter to Members.....	77
President's Address.....	143
Treasurer's Report.....	198
Work and Affairs of.....	62,
63, 77, 173, 193, 254, 392, 449, 493	
See also Conventions, Conservation (magazine), Conservation (movement), Forestry and Irrigation (magazine) and Forestry Associations.	
America's Greatest Irrigation Scheme (article)	258
Appalachian Agitation.....	4,
5, 12, 19, 21, 28, 62, 63, 64, 68, 189, 190,	
191, 342, 357, 546, 554, 555, 558, 643, 644	
Appalachian Bill.....	5,
13, 119, 177, 178, 180, 250, 334, 355	
Constitutionality of the Bill.....	119,
122, 138, 139, 163, 194, 217	
Hearing in Congress....	84, 124, 139, 163
Text of Bill.....	25
Appalachian National Forest Association	19,
21, 504, 546, 643	
See also Conventions.	
Appalachian National Forest, Proposed:	
Bearing on Navigation.....	572, 661
Need of, and Effect on People. 22, 191, 334	
See also Appalachian Agitation, etc., and Symposia.	
Appalachian Resolutions. 17, 18, 67, 129, 137,	
191, 223, 270, 271, 272, 273, 277, 378, 563, 696	
Appalachian Water-sheds, Secretary Wilson's Report on.....	22
Approval of National Forests—See National Forests, Approval of.	
Arbor Day.....	15, 165, 201, 211
Arbor Day, the American Spring Festival (article).....	201
Argentine Republic—See Foreign Countries.	
Arizona:	
Benefit from National Forests.....	508
Mountain Forests in.....	453
Water Conservation in.....	370
As One Forest Ranger Views It (article)	512
Association—See Conventions.	
Atlantic Deeper Waterways Association—See Waterways Associations.	
Aubury, Lewis E., article by.....	212
Beginner in Forestry. A.....	540, 618, 665
Bennett, Claude N.....	506
Boecker, Richard H. Douai, poem by....	372
Book Reviews—See Recent Publications.	
Books on Forestry.....	664
See also the list advertised in each issue.	
Boulger, G. S., book by.....	289
Box Manufacture.....	75
Branding of the Forests, poem.....	425
British Columbia—See Foreign Countries.	
Browne, G. E.....	521
Buffaloes in Oklahoma.....	106
Bryan, William Jennings, Speech at Governors' Conference.....	344
Bunker, H. C., poem by.....	24
Burke, Gov. (N. Dak.), Speech at Governors' Conference.....	342
Burnett, E. A., Speech at Governors' Conference.....	341
Business Side of Conservation.....	548
California Irrigation Needs Forests (article).....	212
Cameron, Agnes Deans, article by.....	258
Canada, Forestry in—See Foreign Countries.	
Canadian Forestry Association—See Forestry Associations.	
Canadian Pacific Railway's Great Irrigation Enterprise, article.....	258
Canals, a Glory of France, article.....	44
Canals—See Waterways.	
Cannon, Joseph G.....	178, 179
Carey Act, Work Under.....	340
Carnegie, Andrew, Speech at Governors' Conference.....	303

<i>Page</i>	<i>Page</i>		
Case, J. B., article by.....	607	Conservation, Women's Work for—See Women's Work and Women's Clubs.	
Cattle—See Grazing.		Conservation—See also Coal; Forest Conservation; Grazing; Metallic Ores; Natural Resources; Soils; Water Powers; Water Supply, and Waterways.	
Cement, Cheap Production.....	287	Conventions—See American Forestry Association; Appalachian National Forest Association; Commercial Congresses; Denver Objectors; Drainage Congress; Forestry Associations (other than above); Irrigation Congress; Lumber Dealers; Mining Congress; Political Conventions; Waterways Associations; and Women's Clubs.	
Municipal Factory.....	16	Cortelyou, George B., Speech at Governors' Conference.....	319
Census of Lumber Production, 1907.....	668	Craft, Quincy R.....	373
Census of Timber—See Timber Supply.		Cry of the Pines, poem.....	278
Census of Water Transportation.....	187	Cult of Conservation, The.....	469
Chamberlain, Thomas C., Speech at Governors' Conference.....	326	Cutler, John C., Speech at Governors' Conference.....	339
Chapman, Arthur, poems by....	242, 348, 452	Dalmatia, Desolation in, article.....	76
Chautauqua Lectures.....	43, 450, 531	See also Foreign Countries.	
Chestnut Trees, Blight on.....	585	Davey, John, article by.....	620
Cheyney, E. G., article by.....	90	Davey, Martin L., article by.....	620
Child Rescue Work.....	392	Davidson, Gov. James O., Speech at Governors' Conference.....	335
China—See Foreign Countries.		Davidson, Lieut.-Gov., Speech at Governors' Conference.....	348
Cities Owning Forests.....	12, 51, 127	Dawson, W. M. O., Speech at Governors' Conference.....	319
City on the Plain, The, poem.....	42	Death of the Forest, poem.....	369
Citizens, Duty of.....	64, 77, 173, 493, 494, 559	Deforestation—See Forest Destruction; Floods, and Foreign Countries, Lessons from.	
Civil Engineers, American Society of, Prizes.....	275	Denver Objectors.....	392, 393, 394
Cleveland, Grover, Memorial to....	432, 450	Desecration, poem.....	79
Cleveland, Treadwell, Jr., book by.....	636	Drainage and Forests.....	10
Coal Supply.....	308, 314, 318, 319, 322, 542	Drainage Congress.....	15, 99, 349
See also Conservation.		Drainage of Southern Marshes, article...	15
Coke Production in New Mexico.....	567	Drain the Swamps? Shall Uncle Sam, article.....	207
Collins, John, article by.....	514	Dodd, Marion Elza, poem by.....	283
Colorado River, Break in.....	195	Dominion of the Lone Cone, The.....	29
Compared with Nile and Susquehanna	403	Droughts and Floods.....	87, 561, 615
Comer, B. B., Speech at Governors' Conference.....	346	See also Floods, and Water-sheds.	
Commercial Congresses:		Dryads' Last Stand, The, poem.....	404
Southern Commercial Congress..	636, 643	Duty of Citizens—See Citizens, Duty of.	
Irrigation Congress.....	589	Duties of States—See States, Duties of.	
Lumber Dealers.....	221	Earth Modified by Human Action, book..	126
Mining Congress.....	14, 454	Eaton, F. M., article by.....	94
Trans-Mississippi Congress.....	15, 607		
See also Waterways Associations.			
Conference of Governors—See Governors' Conference.			
Congressmen, Influence on.....	64, 558		
Constitutionality of the Appalachian Bill—See Appalachian Bill.			
Conservation a World Movement.....	496		
Conservation Commission..	380, 387, 517, 641		
Conservation Conference—See Governors' Conference.			
Conservation, Cult of, The.....	469		
Conservation League.....	562		
Conservation (magazine).....	448, 493, 504		
See also Forestry and Irrigation (magazine), and American Forestry Association.			
Conservation of Human Resources.....	392		
Conservation of Power Resources.....	459		
Conservation, Primer of.....	636		

<i>Page</i>	<i>Page</i>
Editorial..... 3, 61, 119, 177 248, 352, 387, 445, 493, 548, 625	Forest Destruction..... 103, 104, 125, 174, 195, 363, 369
Education, Industrial School Bill..... 192	See also Forest Conservation; Fires; Floods; and Foreign Countries.
Education, School Tree Planting..... 211 See also Arbor Day.	Forest Experiment Stations, International Association of..... 111
Education in Forestry—See Forestry Education; Forestry Schools; Lec- tures, and Appalachian Agitation.	Forest Fires—See Fires.
Edwards, Clarence B., Speech by..... 281	Forest Holocaust, The: Editorial..... 555 Symposium 687
Emerson, Arthur I., book by..... 289	Forest Lesson, The, poem..... 348
Engineering Experiment Stations..... 257	Forest Perpetuation and Water Sup- plies, article..... 87
Everett, Harry Day..... 566 Picture..... 455	Forest Receipts, Shares Paid to States... 696
Eucalyptus Growing..... 624 In Florida..... 125	Forest Taxation—See Taxation of Forest Land.
Excelsior, Production of..... 195	Forest Tree Nurseries..... 373, 377, 378
Fall Web-worm..... 620	Forests a National Necessity..... 10, 621, 623
Farm Forestry..... 74, 126, 173, 187, 399, 560 See also Private Forestry.	Forests and Drainage..... 10
Finney, John H., articles by.... 504, 615, 643	Forests and Floods..... 390
Fire Fighters, The, poem..... 452	Forests and Irrigation..... 10, 212
Fires: Control and Prevention of..... 12, 279, 359, 452, 454, 498, 628 Destruction by.... 498, 555, 625, 626, 627 Statistics 687 Railroads' Responsibility for..... 12	Forests—See also National Forests. Forest Service—See U. S. Forest Service; see also National Forests; National Monuments; and National Parks.
Floods..... 273, 390, 548, 561, 611, 615, 649 See also Appalachian Agitation, etc.; and Water-sheds.	Forestry and Irrigation (magazine)... 125, 177, 193, 230, 257, 265, 270, 279, 280, 288, 349, 352, 448, 449, 493 See also Conservation (magazine) and American Forestry Association.
Folk, Joseph W., Speech at Governors' Conference 338	Forestry as an Investment, article.... 230, 333 See also Private Forestry; and Farm Forestry.
Foreign Countries, Forestry in, or Les- sons from Deforestation in: Argentine Republic..... 277 British Columbia..... 130 Canada 131 China 11, 222 Dalmatia 76 France..... 402 Ireland 131 Japan 508 Korea..... 253 Mexico 123 Siberia 131 South Africa..... 105 Sweden and Norway..... 173 Various Countries..... 496, 569 International Trade in Lumber. 131, 569	Forestry Associations, as follows: American Forest Preservation Society 128 American Forestry Association—See alphabetical position. Appalachian National Forest Associ- ation—See alphabetical position. Canadian Forestry Association..... 215 Connecticut State Forestry Associa- tion 636 Hampden Forestry Association. 132, 193 Iowa Park and Forest Association. 12, 129 Georgia Forest Association..... 18 New Jersey Forest Council..... 13 Paducah Forestry Association... 13, 193 St. Louis Forestry Association..... 194 West Virginia Forestry Association 128, 193
Forest Conservation..... 17, 87, 335, 348, 410, 487, 559 See also Forest Destruction, and Conservation; Foreign Countries, Timber Supply; Water Powers; Waterways, etc.	Periodicals Published by Associa- tions..... 123, 193 Forestry, books on—See Books.

	<i>Page</i>		<i>Page</i>
Forestry Education:		Grant's Pass Map.....	409
General.....	3, 73	Grazing in National Forests.....	225
Study Clubs.....	501	Grazing Lands, Regulation of.....	172, 251
See also Forestry Schools; Lec- tures; Public Opinion; and Ap- palachian Agitation.		Siberian Legumes for.....	255
Forestry Schools, as follows:		Use and Care of.....	338
Colorado Agricultural College.....	192	Grazing—See also Conservation, and Na- tional Forests.	
Colorado College.....	72, 675	Great Lakes, Composition of Water in..	570
Cornell.....	696	Grover, Nathan C., book by.....	115
Harvard.....	128	Gulf Coast Inland Waterway Associa- tion—See Waterways Associations.	
Iowa.....	72	Hadley, Arthur D., Speech at Governors' Conference.....	333
Itasca Park.....	90	Hall, Wm. L.....	194
Kansas Agricultural College.....	128, 192	Hammond, John Hays, Speech at Gov- ernors' Conference.....	318
Massachusetts Agricultural College.....	72, 359	Hampden Forestry Association—See For- estry Associations.	
Nebraska University.....	192	Handbook of American Trees.....	39
Pennsylvania State College.....	674	Hanly, J. Frank, Speech at Governors' Conference.....	347
Powder Point Academy.....	128	Hanna, F. W., article by.....	115
Washington State University.....	275	Hanson, Fred, article by.....	512
Winona Lake.....	192	Harvey, W. S., Speech at Governors' Conference.....	342
Wisconsin University.....	192	Hastings, Ellen M., article by.....	621
Yale.....	12, 14, 73, 223, 333, 672	High School Essays.....	621, 623, 633
See also Forestry Education, general.		Hearing on Appalachian Bill—See Ap- palachian Bill, Hearing on.	
Forestry Work—See also Farm Forestry; Foreign Countries; Private For- estry; State Work in Forestry; U. S. Forest Service; and National Forests.		Heart of a Tree, The, poem.....	24
Fort, John F., Speech at Governors' Con- ference.....	333	Heart of the Woods, In the, poem.....	47
France—See Foreign Countries; also Canals.		Heaton, Frank G.....	291
Fraudulent Homesteader, The, article...	579	Hegira, The, poem.....	503
Freight Rates on Lumber, etc.....	66, 126	Hickory Tree on Arbor Day, A, poem..	165
Fuel Resources, Waste of.....	308, 314	Hill, James J., Speech at Governors' Conference.....	319
See also Coal Supply.		Hill Man's Lament, The, poem.....	242
Game Preserve, Grand Canyon.....	453	Hoch, Edward W., Speech at Governors' Conference.....	347
Gannett, Henry, article by.....	517	Hoover, T. L., poem by.....	27
Garfield, James R., speech at Governors' Conference.....	341	Horses, Concerning.....	473
Geological Survey—See U. S. Geological Survey.		Hough, Romeyn B., book by.....	39
Gifford, John, article by.....	196	Hoyt, John C., book by.....	115
Gittings, Victoria Elisabeth, poem by...	404	Hudson, Millard F., poem by.....	42
Glenn, Robert B., Speech at Governors' Conference.....	334	Hurst, Haver Charles, poem by.....	216
Goetz, C. H., article by.....	35	Indians, Benefit to, by Reclamation Service.....	56
Gooding, Gov., Speech at Governors' Conference.....	340	Indians, Land, and Whisky.....	243
Governors' Conference.....	177, 180, 181, 182, 235, 241, 248, 291, 352, 380, 410, 641	Inland Waterways—See Waterways, In- land.	
Delegates Present.....	293-297	Inland Waterways Commission—See Waterways Commission.	
Resolutions.....	343, 348	Insects Affecting Trees and Timber.....	70,
Governors, House of.....	343		71, 620

<i>Page</i>	<i>Page</i>		
Inspectors' Meeting.....	225	Lee, Wm. Canfield, article by.....	201
In the Departments (department of magazine)—See U. S. Forest Service; U. S. Geological Survey; and U. S. Reclamation Service.		Legislation by States—See State Work in Forestry.	
In the Heart of the Woods, poem.....	47	Leighton, Marshall O., article by.....	649
Ireland—See Foreign Countries.		Lever, Asbury F., Speech at Governors' Conference.....	217
Iron and Related Ores, Supply of.....	303, 314, 315, 316, 318, 322	Lone Cone, the Dominion of the.....	29
See also Conservation.		Long, R. A., Speech at Governors' Conference.....	410
Iron, Pig, Production of.....	565	Los Angeles Aqueduct.....	284
Irrigation and Drainage Investigations, U. S. Office of.....	125, 188, 277	Louden, William, Speech at Governors' Conference.....	348
Irrigation and Forestry.....	10, 212	Lumber Dealers', Wholesale, Convention of.....	221
Irrigation Congress, 16th National.....	589	Lumber, International Trade in.....	131, 569
Irrigation Farming.....	12, 188, 189, 227, 284	Lumber Prices.....	225
In Colorado.....	29	Lumber Production, 1907, Census.....	668
Opportunities in.....	521	Lumber Trust Investigation.....	254
See also Land Openings.		Lumberman Poet, The, poem by.....	86
Irrigation, State Work Under Carey Act	340	Lumbermen and Forestry.....	3, 12, 35, 66, 126, 193, 230, 280
See also Private Irrigation, and U. S. Reclamation Service.		Lumbermen's Views on Reforestation, article.....	35
Itasca Lake, Forest Reservation and School.....	90	MacKisson, Mrs. J. E., article by.....	487
James, Edmund J., Speech at Governors' Conference.....	340	McFarland, J. Horace, article by.....	457
Japan—See Foreign Countries.		McGee, W. J., articles by.....	469, 596, 661
Jastro, H. A., Speech at Governors' Conference.....	338	McKinley, Olive M., article by.....	29
Johnson, Emory R., article by.....	572	McQueen, Anne, poem by.....	278
Johnson, John A., Speeches at Governors' Conference.....	314, 319, 331	Mahogany, Names of, article.....	196
Jones, W. G., Speech at Governors' Conference.....	342	Marsh, George P., book by.....	126
Joyce, John A., poem by.....	663	Mead, Albert E., Speech at Governors' Conference.....	347
Jusserand, J. J., article by.....	44	Mead, Marian, poem by.....	492
Keen, Florence, article by.....	76	Members and Correspondents, With (department of magazine).....	77, 103, 173, 230, 279, 559, 624
Kelsey, F. W.....	173	Membership Campaign.....	449
Kent, William, Dedicates Redwood Canyon.....	97	See also American Forestry Association, Work and Affairs; and Citizens, Duties of.	
Klinge, George, poem by.....	220	Mershon, Wm. B., article by.....	370
Knell of the Forests, poem.....	220	Metallic Ores, Supply of.....	316
Korea—See Foreign Countries.		See also Iron Ore; and Conservation.	
Lakes-to-Gulf Deep Waterway Association—See Waterways Associations.		Mexico—See Foreign Countries.	
Land, Natural Wealth of, and Its Conservation, article.....	319	Mickleborough, John, article by.....	585
See also Soil Conservation and Waste.		Military Reservations, Forestry on.....	106
Land Openings.....	227, 228, 288, 406, 521	Miller, Joaquin, poem by.....	34
See also Irrigation, etc.		Miller, Louise Klein, article by.....	211
Land Stealing.....	189, 579	Millions for Tribute, But Not One Cent for Defense, article.....	94
See also Public Property, Private Use of.		Mills, Enos A.....	74
Lectures... 43, 74, 173, 194, 277, 459, 531, 546		Mining Congress.....	14, 454
		See also Commercial Congresses.	
		Mining Timbers.....	454

	<i>Page</i>	<i>Page</i>
Mississippi-to-Atlantic Deep Waterways Association—See Waterways Associations.		
Mitchell, John, Speech at Governors' Conference.....	314	
Monarch of the Woods, The, poem....	38	
Mother Earth, poem.....	678	
Mountain Forests and Floods.....	390	
Mountains, The, poem.....	216	
Names of Mahogany.....	196	
National Conservation Commission—See Conservation Commission.		
National Conservation League—See Conservation League.		
National Drainage Congress—See Drainage Congress.		
National Forest:		
Appalachian—See Appalachian, etc.		
Aquarius.....	52	
Arkansas.....	52, 53, 106, 514	
Cleveland.....	432, 450	
Garces.....	454	
Garden City.....	360	
Grand Canyon.....	453	
Luquillo.....	225, 286	
Manti.....	17	
Ozark.....	514	
San Jacinto.....	432, 450	
Vegas.....	52	
Verde.....	107	
Washington.....	406	
National Forests:		
Administration... 13, 20, 28, 51, 341, 393		
Benefit to Arizona.....	508	
Approval of.....	212, 393	
Boundaries and Extensions.....	13, 52, 107, 108, 286	
Effect on the People.....	21, 28	
Inspectors' and Rangers' Meetings	20, 225	
Names.....	107, 286, 425, 428, 432	
Not "Reserves".....	3	
Nurseries.....	373, 377	
Opposition to.....	251, 392, 393, 394, 445, 446, 447, 558	
Public Opinion on.....	80	
Receipts in Western Depositories...	695	
Re-districted.....	428	
Tax Payments by.....	696	
National Forests—See also Work in a National Forest (series of articles); U. S. Forest Service; National Monuments; and National Parks.		
National Irrigation Congress—See Irrigation Congress.		
National Monuments:		
Grand Canyon.....	69	
Jewel Cave.....	132	
Pinnacles.....	69	
See also National Parks; and National Forests.		
National Parks:		
In Utah.....	340	
Muir Woods.....	97	
West Point, or Hudson.....	68	
See also National Forests; and National Monuments.		
National Rivers and Harbors Congress—See Waterways Associations.		
Nation's Herculean Task, The.....	506	
Nation's Need of Forestry Work, The..	487	
Natural Movement of Water in Semi-arid Regions, article.....	596	
Natural Resources, Conservation by Federal Action.....	163, 291, 319, 337, 339, 419, 506	
See also Conservation.		
Natural Resources, Waste of.....	12, 62, 63, 266, 308, 314, 337	
Natural Wealth of the Land and Its Conservation, article.....	319	
Navigation, Effect on, of Appalachian Forest Reserve, article.....	661	
Navigation Resources of American Waterways, article.....	572	
Need of Forest Conservation, article....	487	
New Mexico Industrial Exhibition.....	127	
News and Notes (department of magazine).....	12, 66, 124, 187, 270, 359, 395, 453, 508, 561, 636, 691	
Next Generation's Reproach Against Its Ancestors, poem.....	372	
Norris, Gov., Speech at Governors' Conference.....	340	
Nurseries, Forest Tree.....	373, 377, 378	
Oak Defiant, The, poem.....	162	
Obstructionists Retired.....	558	
Ohio Forests, Destruction of.....	363	
Oil Field Investigations.....	567	
Old Mountain Pines, The, poem.....	57	
Onions as Irrigators.....	229	
Opposition to National Forests—See National Forests, Opposition to.		
Oregon Sierra, The, poem.....	34	
Osborn, Gov., Speech at Governors' Conference.....	339	
Our Waning Coal Supply, article.....	542	
Paducah Forestry Association—See Forestry Associations.		
Panama Canal.....	506	

	<i>Page</i>		<i>Page</i>
Paper Pulp Production.....	4, 6, 15, 20,	Public Opinion on Forestry and National Forests.....	77, 80, 333
Pardee, George C., Speech at Governors' Conference.....	337	See also Appalachian Agitation; Citizens, Duty of; Forestry Education, General; Lectures; National Forests, Approval Of and Opposition To; and Symposia.	
Peace of Quiet Aisles, The, poem.....	89	Public Property, Private Use of.....	182-185, 253, 341, 345, 347, 354, 357, 394
Peat Briquettes in New Mexico.....	274	See also Land Stealing.	
Pennsylvania State Forest Policy.....	481	Public vs. Private Interests.....	5, 7
Forest Commission Report.....	57	Publications Received—See Recent Publications.	
Pennsylvania Water Supply Commission Report.....	659	Pulsifer, Harold Trowbridge, poem by..	79
Pennsylvania Railroad.....	12, 426	Putnam, H. S. C.....	459
Philippine Forests.....	455, 667	Railroad Forestry Work.....	12, 17, 426
Pinchot, Gifford, Portrait.....	362	Railroads' Responsibility for Fires.....	12
Speech at Annual Meeting.....	148	Railroad Ties.....	111
Pines, The Cry of the, poem.....	278	Range—See Grazing.	
Pines, The Old Mountain, poem.....	57	Rangers' Meeting.....	20
Plea of the City Elm, The, poem.....	492	Ranger, The Every-day, article.....	383
Plowman, A. B., article by.....	363	Recent Publications (department of magazine).....	57, 115, 232, 289
Poet Lariat, The, poems by.....	425, 503	Reclamation Service—See U. S. Reclamation Service.	
Political Conventions, Parties, and Movements. 64, 180, 392, 393, 456, 558, 634, 635		Redwood Canyon Deeded to United States.....	97
Popular Government.....	393	Reese, Robert M., poem by.....	269
Pound, Thad C., article by.....	679	Reform Press, a Practicable.....	123, 193
Powell, John Wesley.....	638	Reservoir System in U. S., Origin of....	679
Precious Stones in U. S.....	455	Riesenberg, Henry, article by.....	419
Preserve the Soil, poem.....	663	River Control.....	10
Private Forestry.. 65, 75, 128, 132, 173, 230, 333		River Discharge, book review.....	115
See also Farm Forestry; and Railroads.		Rivers and Harbors Congress—See Waterways Associations.	
Projects of Reclamation Service—See U. S. Reclamation Service.		Rivers, Navigable—See Waterways, Inland.	
Propriety and Need of Federal Action, speech.....	163	Roads and Roadside Trees.....	74
Protection for American Industry, speech..	217	Roosevelt, Theodore.....	298, 347, 348
Private Irrigation:		Statesmanship of.....	16
Australia.....	189	Root, Elihu, Speech at Governors' Conference.....	318
British Columbia.....	130	St. Louis Forestry Association—See Forestry Associations.	
Canada	158	Sangster, Margaret E., poem by.....	47
Idaho.....	130, 288, 340	Sargent, Frederick LeRoy, poem by.....	162
Montana.....	340	Scenery, The value of Natural.....	457
Nebraska	284	Schuyler, James D., Wins Engineer Prizes.....	275
Utah.....	189	Sheep—See Grazing.	
Washington.....	129, 130, 188, 277, 395, 396, 397, 398, 637	Sheldon, Gov., Speech at Governors' Conference.....	348
See also Irrigation Farming; and U. S. Reclamation Service.		Shepard, Harvey N., Speech on Constitutionality.....	136
Private Use of Public Property—See Public Property, Private Use of; and Public vs. Private Interest.		Shinn, Charles Howard, articles by....	166, 243, 383, 473
Public Lands—See Land Openings; and Land Stealing.			

	<i>Page</i>		<i>Page</i>
Shuey, Lillian H., poem by.....	369	Symposia—continued:	
Siberia—See Foreign Countries.		The Forest Holocaust.....	687
Siberian Legumes Introduced.....	255	See also Appalachian Agitation, etc., and Public Opinion on For- estry.	
Smith, George Otis, article by.....	652	Taaffe, Janes, poem by.....	89
Smith, Hoke, Speech on Constitution- ality.....	163	Tan Bark.....	105, 363
Soil Conservation by Farming Methods... 16, 255, 330, 341		Oak.....	51
See also Conservation.		Taxation of Forest Land.....	8, 35, 122, 129, 174, 224
Soil Waste.....	320, 320	Teachers' Summer Home in Colorado..	359
See also Land; and Conservation.		Temples East and West, poem.....	86
South Africa—See Foreign Countries.		Thayer, Alford L., article by.....	579
Spendthrift, The, poem.....	260	Ties, Railroad.....	111
Spoilers, The Work of the, article.....	363	Timber Supply.....	18, 61, 67, 125, 131, 225, 249, 255, 279, 549, 559, 668
States, Duties of.....	318, 319, 339, 353	Topographical Maps.....	409, 510, 562
See also State Work in Forestry; and Citizens, Duties of.		Trans-Mississippi Congress—See Com- mercial Congresses.	
State Irrigation Under Carey Act.....	340	Tree Culture, Tree Planting—See For- estry; and Arbor Day.	
See also Irrigation Farming; Pri- vate Irrigation; and U. S. Rec- lamation Service.		Tree Planting in School Yards, article..	211
State Official Reports—See Recent Pub- lications.		Tree Surgery as a Science.....	533
State Tree and Flower, Illinois.....	104	Trees, poem.....	283
Voting on, in Montana.....	127	Trees, American, Illustrated Handbook of	39
State Work in Forestry:		Trees and Their Names, article.....	443, 196
Alabama.....	19, 71	Trees, Our, How to Know Them, book review.....	289
Hawaii.....	15	Trees, Rate of Growth.....	275
Kentucky.....	195, 280, 347	Trees, Roadside.....	74
Louisiana.....	552	Turpentine Production.....	359
Maine.....	127, 553	U. S. Forest Service:	
Minnesota.....	90	Administration.....	224, 695
Missouri.....	339	Approval of.....	280
New Jersey.....	120, 333	Laboratories.....	52, 110, 111
New York.....	120, 194, 331	Organization, Roster.....	691
Ohio.....	67, 104, 363	Study of Tree Growth.....	275
Pennsylvania.....	13, 57, 342, 481	Supply Depot at Ogden.....	409
South Carolina.....	120	Willow Experiments.....	226
Tennessee.....	277	See also National Forests.	
Texas.....	230	U. S. Forest Service (department in magazine).....	51, 106, 172, 224, 284, 406
Utah.....	339	U. S. Geological Survey:	
Washington.....	359	Department in Magazine.....	284, 406
Wisconsin.....	335	Los Angeles Aqueduct.....	284
In General, Expense of.....	132	Publications.....	284, 510, 511
Nurseries, Statistics.....	378	See also Recent Publications.	
See also States, Duties of.		Relation to the Public.....	652
Strobeck, John L., article by.....	481	U. S. Reclamation Service:	
Sweden and Norway—See Foreign Coun- tries.		Department of Magazine.....	54, 112, 170, 227, 284, 405
Symposia:		Review of Year's Work.....	54
Governors' Responses to Conference Invitation.....	241	Y. M. C. A. Working With.....	287
National Forests and Public Opinion	80	See also Irrigation Farming; Land Openings, and Private Irrigation.	
Need of Forest Conservation.....	77		

<i>Page</i>	<i>Page</i>
U. S. Reclamation Service Projects:	Waterways Associations—continued:
Arkansas Valley..... 112	Gulf Coast Inland Waterway Association 694
Carson Sink—See Truckee-Carson.	Lakes-to-Gulf Deep Waterway Association 601
Garden City..... 228	Mississippi to Atlantic Deep Waterway Association..... 646, 694
Payette-Boise..... 288	Ohio Valley Improvement Association 611
Shoshone..... 170, 171, 228, 229	Rivers and Harbors Congress, National..... 8, 48, 636
Sun River..... 288	Rivers and Harbors Congress Women's National..... 568, 636
Truckee-Carson..... 54, 55, 56, 113, 114	Web-worm, Fall..... 620
Van Allen, Eleanor, poem by..... 678	Weed, Clarence M., book by..... 289
Van Hise, Charles R., Speech at Governors' Conference..... 315	West Point National Park..... 68
Wakeley, T. R..... 455	Whipple, James S., Speech at Governors' Conference..... 331
Willows for Basketry..... 226	White, J. C., Speech at Governors' Conference 308
Warner, Aune, articles by..... 540, 618, 665	White House Conference—See Governors' Conference.
Warner, Gen. A. J., article by..... 542	White Mountains, The, poem..... 27
Waste of Natural Resources and Need for Conservation, article..... 266	White Mountains, Proposed National Forest in—See Appalachian National Forest, Agitation, Bill, etc.
See also Conservation; and Natural Resources.	Will, Thomas E..... 43, 153, 450, 531
Water Conservation in Arizona..... 370	Williams, Lydia Adams, articles by..... 48, 80, 133, 221, 266, 270, 350, 435
Water, Movement of, in Semi-arid Regions..... 596	Portrait..... 350
Water Power, article..... 649	Willson, Augustus E., speech at Governors' Conference..... 347
Water Powers.. 127, 183, 408, 459, 551, 630, 649	Wilson, James, Speech at Annual Meeting 143
See also Conservation; and Water Supply.	At Governors' Conference..... 330
Water-sheds, Appalachian, Secretary Wilson's Report on..... 22	Women's Work for Conservation..... 350
See also Appalachian National Forest.	Women's Clubs, Forestry Work, etc.:
Water-sheds, Effects of Forests on... 94, 390	Colorado 231
Water Supply..... 87, 659, 661	District of Columbia..... 270, 350
Los Angeles..... 284	Maine..... 127
Texas..... 348	Montana 127
Arizona 370	Vermont..... 17
Water Supply Affected by Forests..... 565	General Federation..... 57, 277, 351, 435
Water Supply Commission, Pennsylvania, Report..... 659	Women's National Rivers and Harbors Congress..... 568, 636
Water Supply Papers..... 284, 403	Wood, book review..... 289
Water Supply Problem, The, article..... 465	Wood Laboratories—See U. S. Forest Service.
Waterways.... 44, 187, 188, 250, 550, 551, 644	Wood Pulp—See Paper Pulp Production.
Waterways as Affected by Appalachian Forests 661	Wood Substitutes..... 61
Waterways Associations—See below.	Work for Members—See Citizens, Duty of; and American Forestry Association, Work and Affairs.
Waterways, Census of Transportation by 187	Work in a National Forest (series of articles)..... 166, 243, 383, 473, 512
Waterways Commission..... 181, 185, 339	Y. M. C. A. and Reclamation Service.... 287
Waterways, French and German Canal Systems..... 44	
Waterways, Inland..... 44, 281, 572, 601, 661	
See also Conservation.	
Waterways, Inland, A System of, article.. 281	
Waterways Associations:	
Atlantic Deeper Waterways Association..... 644	

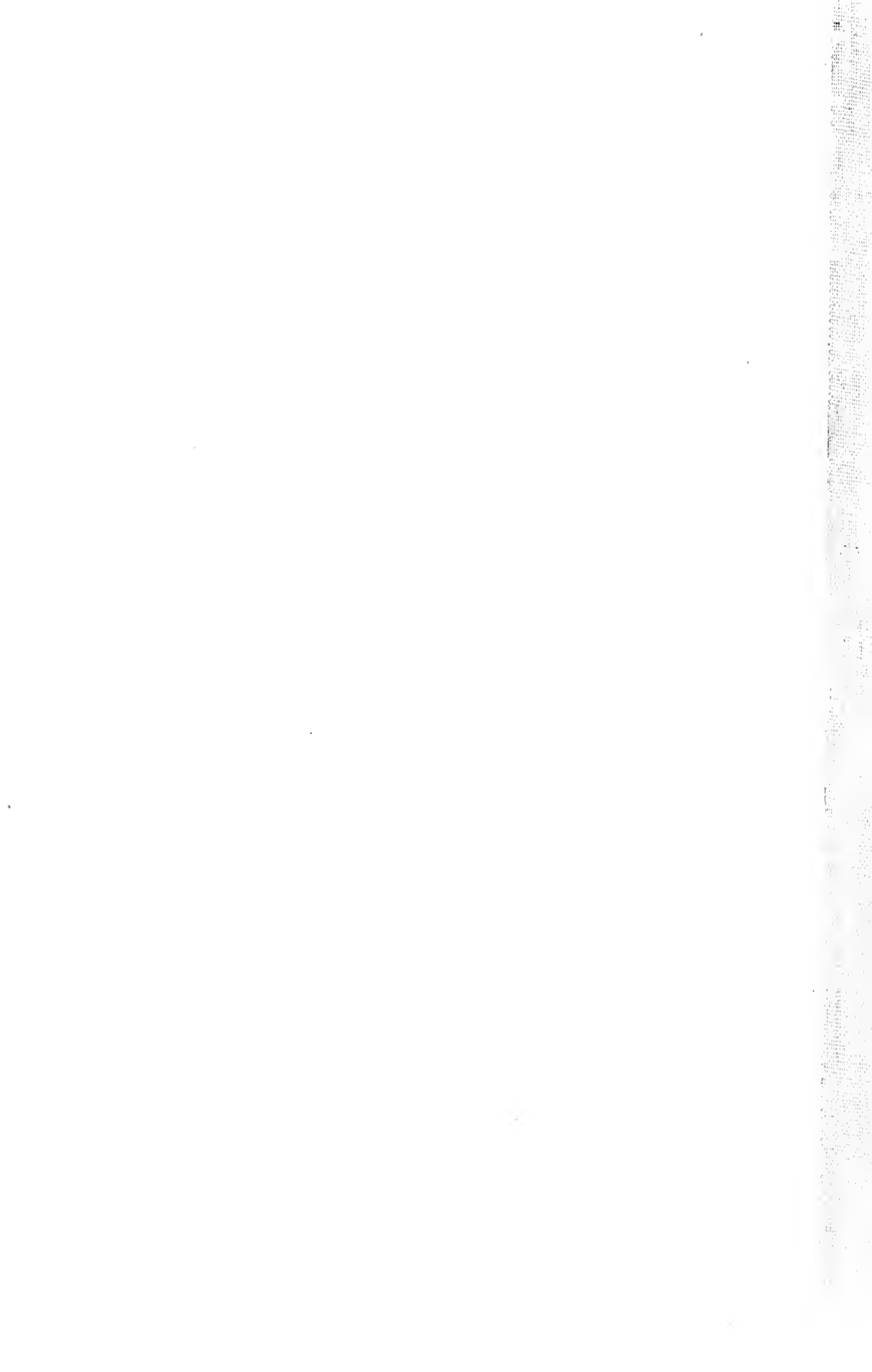

FORESTRY AND IRRIGATION

Appalachian National Forest Association

Report on Appalachian Watersheds

Text of Appalachian-White Mountain Bill

The Dominion of the Lone Cone

Lumbermen's Views on Reforestation

Illustrated Handbook of Trees

Secretary Will's Lecture Tours

The Canals: One Glory of France

The Rivers and Harbors Congress

Thorburn's Seeds

Seed of *Pinus Banksiana* - \$4.00 per lb.
(Northern Jack Pine)

Seed of *Pinus Strobus* - \$1.50 per lb.
(White Pine)

Free by mail or express.

Special prices on large lots on application.
Also large line other tree and shrub seeds.
New crop imported natural grasses.
Send for 1908 catalog, ready about Jan. 1st.

J. M. Thorburn & Co.

33 Barclay Street,
Through to 38 Park Place

Established 1802

NEW YORK

The exacting requirements of modern engineers, necessitating unusually accurate Instruments, are satisfied by our graduations.

Illustrated Catalogue upon application

YOUNG & SONS, PHILADELPHIA

Have You a Hobby?

It does not make any difference to us with what kind of a hobby you are identified, we can furnish you articles from papers and magazines published all over the world upon any subject you may be interested in. The man who wants to be

Up-to-Date

needs the help of a good

Press-Clipping Service

because he cannot read everything himself. It's simply a physical impossibility. Let us read for you—it's our business. Our work saves you much valuable time spent in libraries and reading papers in search for information which can be nowhere definitely obtained. You will be surprised at the results; you will see paragraphs which you would never have been able to find yourself. Drop us a postal and we will point out to you what we can do for you. Price, \$5.00 for 100 clippings.

H. ROMEIKE, Inc.

110-112 West 26th St.

New York City

The Longleaf Pine in Virgin Forest

A Silvical Study.

By G. FREDERICK SCHWARZ,
Author of "Forest Trees and Forest
Scenery."

12mo, x + 135 pages, 23 full-page
half-tone illustrations and 3 dia-
grams. Cloth, \$1.25 net.

CONTENTS.—Introduction. Character of Virgin Longleaf Pine Forests. Natural Rotation: Evolution in the Forest. Tolerance. Fires. The Soil Cover. Injury to Seedlings, caused by Hogs. Rate of Growth in Virgin Forest. Forest Management. The Aesthetics of Forestry.

JOHN WILEY & SONS

43 and 45 E. 19th Street
New York City

IMPORTANT BOOKS ON FORESTRY

PRINCIPLES AND PRACTICE OF FORESTRY

Forest Mensuration. By HENRY SOLON GRAVES, M. A. A complete text book of this important subject and the first written for American Foresters. It deals with the determination of the volume of log, tree, or stand, and with the study of increments and yields. *Price, \$4.60*

Economics of Forestry, The. By B. E. FERNOW. This volume treats of forests and forestry from the standpoint of political economy, and is designed to furnish a trustworthy basis for formulating public policy. *Price, \$1.50*

First Book of Forestry, A. By FILIBERT ROTH. An outline of the general principles of forestry, written in simple, non-technical language, designed particularly for the beginner. *Price, \$1.10*

Practical Forestry, for Beginners in Forestry, Agricultural Students and Woodland Owners. By JOHN GIFFORD. A good general description of the principles of forestry with enough technical information to prepare the beginner. *Price, \$1.40*

History of the Lumber Industry of America. By J. E. DEFEBAUGH. The first authoritative work of its kind yet issued, and one which will commend its self alike to the timber owner, lumberman, lumber manufacturer, or merchant, or student of economics. In four volumes bound in half leather *\$5.00 per volume.*

Forest Planting. By H. NICHOLAS JARCHOW. An illustrated treatise on methods and means of restoring denuded woodland. *Price, \$1.50*

Forestry. (Schwappach.) An English translation of "Forstwissenschaft." *Price, 70c*

Hedges, Windbreaks, Shelters and Live Fences. By E. P. POWELL. A treatise on the planting, growth and management of hedges with information concerning windbreaks and shelters. *Price, 70c.*

North American Forests and Forestry. By ERNEST BRUNCKEN. This volume, expository in its character, is written in a style intended for the general reader, to whom it should convey a good idea of our forests forestry. *Price, \$2.00*

Practical Forestry. By ANDREW S. FULLER. A treatise on the propagation, planting and cultivation, with descriptions and the botanical and popular names of all the indigenous trees of the United States, and notes on a large number of the most valuable exotic species. *Price, \$1.50*

Principles of American Forestry. By SAMUEL B. GREEN. Prepared especially for students in elementary forestry and for the general reader who wishes to secure a general idea of forestry in North America. *Price, \$1.50*

Seaside Planting of Trees and Shrubs. By ALFRED GAUT. Illustrated from photographs by FRANK SUTCLIFFE. This is a new volume in the English Country Life Library. Advice regarding selection and management to get satisfactory effects under adverse influence of closeness to seashore. *Price, \$1.75.*

Profession of Forestry, The. By GIFFORD PINCHOT. A pamphlet containing an address on that subject by Mr. Gifford Pinchot; also an address by Mr. Overton W. Price on "Study in Europe for American Forest Students," and a list of reference publications for students. *Price, 25c.*

FOREIGN IMPORTATIONS

English Estate Forestry. By A. C. FORBES. An authoritative volume on English forest methods from the pen of a well known forester, that should prove of interest to Americans. *Price, \$3.50*

Forstwissenschaft. (Schwappach.) *Price, 60c*

Manual of Forestry. (Schlich.) Five volumes, complete, or separately as follows (*price, complete, \$18.80*);

Vol. I. "Forestry Policy in the British Empire." *Price, \$2.40*

Vol. II. "Sylviculture." *Price, \$3.20*

Vol. III. "Forest Management." *Price, \$3.60*

Vol. IV. "Forest Protection." *Price, \$3.60*

Vol. V. "Forest Utilization." *Price, \$4.80*

Price, \$4.80

This is perhaps the most authoritative work that has been issued on the technical side of forestry, translated from the German.

Wood. By G. S. BOULGER. An important new book for arboriculturists and forestry students. A manual of the natural history and industrial applications of the timbers of commerce. Cloth. 82 illustrations. *Price, \$2.60*

Familiar Trees. By Prof. G. S. BOULGER. Written by an eminent botanical authority, yet couched in language easily understood. The coloured plates are the work of celebrated artists, and are truthful and trustworthy in every respect. A special feature is the series of photomicrographic illustrations of sections of woods. Three volumes. *Price, per volume, \$1.50.*

DENDROLOGY, BOTANY, AND IDENTIFICATION OF SPECIES

Manual of the Trees of North America (exclusive of Mexico). By CHARLES SPRAGUE SARGENT. A volume that presents in convenient form and with excellent illustrations, authoritative information concerning the trees of North America. It is written in a manner that enables the reader to readily find what family or species any particular tree belongs. *Price, \$6.00.*

American Woods. By ROMEYN B. HOUGH. A new departure in the publication of an authoritative work illustrated with actual wood sections of the various species described. Three are given of each, viz., radial, transverse, and tangential. Issued in ten parts, per part *Price, \$5.00*

Flora of the Southern States. CHAPMAN. This is an excellent key to the flora of the south, complete and accurate in its scope. *Price, \$4.00*

Getting Acquainted with the Trees. By J. HORACE MCFARLAND. A handsome volume, copiously illustrated, and with facts accurately presented in an entertaining way. *Price, \$1.75*

How Plants Grow. By ASA GRAY. An understanding of the way in which a tree grows is of prime importance to the forester, and the matter here presented is accurate and authoritative. *Price, \$1.00*

Manual of Botany. By ASA GRAY. A key to the flora of the northeastern states, and the most authoritative publication of its nature. *Price, \$1.62; field edition, \$2.00*

Our Native Trees. By HARRIET L. KEELER. A popular key to the trees of the northeastern United States, presented in manner giving easy access to the text. The book is accurate, and as far as possible is written in a style which would make it interesting to the beginner. *Price, \$2.00*

Our Northern Shrubs. By HARRIET L. KEELER. This volume is planned on the same lines as the foregoing, and describes the shrubs which are native to the region extending from the Atlantic Ocean to the Mississippi River and from Canada to the northern boundaries of our Southern states. The arrangement is by families and each member is given a popular and scientific description. *Price, \$2.00*

Principal Species of Wood; Their Characteristic Properties. By CHARLES HENRY SNOW. No attempt is made to give exhaustive descriptions of species, but the author presents a mass of information designed for the use and instruction of woodworkers, etc., in a popular style. A host of concise information is brought under each head, and the work is a valuable one. *Price, \$3.50.*

Trees of New England. By L. L. DAME and HENRY BROOKS. This book is a small volume which can be easily put in the pocket and carried in the woods, and at the same time is the best guide to the identification of our New England trees of any of the smaller books yet published. *Price, \$1.50*

Trees of Northeastern America. NEW-HALL. A good general check list of the more important trees of the northeastern United States. *Price, \$1.75*

Trees and Shrubs. By C. S. SARGENT. The most thorough and authoritative publication yet issued, and a standard work. The matter is issued in parts, of which there are three already published. *Price, per part, \$5.00*

Trees, Shrubs and Vines of the Northeastern United States. By H. E. PARKHURST. In this book the author describes the trees, shrubs, and vines of the northeastern United States in a popular way, the book being designed especially for persons who have never studied botany. To these it will appeal as a valuable guide to a familiarity with the salient characteristics of trees, shrubs and vines. *Price, \$1.50*

Trees. A handbook of forest botany for the woodlands and the laboratory. By H. MARSHALL WARD. Vol. I, Buds and twigs. Vol. II, Leaves. Vol. III, Flowers and inflorescences. Three volumes to be added, on Fruits and seeds, Seedlings, Habit and conformation of the tree as a whole. *Price, per volume, \$1.50*

DESCRIPTION OF PARTICULAR SPECIES AND LOCALITIES

Mountains of California, The. By JOHN MUIR. No other person is so well fitted to write of the mountains of California as John Muir, and the volume presented here describes not only the mountains themselves but the trees that clothe them and the wild life which they harbor. *Price, \$1.85*

BOOKS ON IRRIGATION AND DRAINAGE

Irrigation in the United States. By F. H. NEWELL. The most authoritative and complete work on the subject which has yet been published, by the head of the Government's irrigation work. *Price, \$2.00*

Irrigation Farming. By L. M. WILCOX. A newly revised edition of one of the standard works on irrigation. The principal chapters treat very fully of irrigation, its application, etc., and the volume is profusely illustrated. *Cloth, \$2.00*

Irrigation for Farm, Garden and Orchard. By HENRY STEWART. This work is offered to those American farmers and other cultivators of the soil who, from painful experience, can readily appreciate the losses which result from the scarcity of water at critical periods. *Price, \$1.00*

Irrigation and Drainage. By F. H. KING. While most of the existing books on these subjects have been written from engineering or legal standpoints, this one presents in a broad yet specific way the fundamental principles which underlie the methods of culture by irrigation and drainage. *Price, \$1.50*

Irrigation Institutions. By ELWOOD MEAD. A discussion of the economic and legal questions created by the growth of irrigated agriculture in the West, by the Chief of Irrigation and Drainage Investigations of the Department of Agriculture. *Price, \$1.25*

Land Draining. By MANLY MILES. A handbook for farmers on the principles and practice of draining, giving the results of his extended experience in laying tile drains. *Price, \$1.00*

Land of Little Rain, The. By MRS. MARY AUSTIN. A nature book of the highest type. The volume is made up of a series of sketches of the human, animal, and plant life found in the region of the Mohave desert, Death Valley, and the Sierras, much of which the average person is likely to consider almost devoid of living things. *Price, \$2.00*

Our National Parks. By JOHN MUIR. If you want to learn about the glaciers, mountain peaks, canyons and great waterfalls of the West; of the habits of animals from the squirrel to the moose; plant life from the big trees to the wild flowers — in fact be brought face with nature's works, this is the book. *Price, \$1.85*

Trees and Shrubs of Massachusetts. EMERSON. Two volumes. Plain cloth edition has 148 plates. The colored edition has 36 of these in colors. *Price, plain, \$12.00. Price, colored, \$18.00.*

The Earth as Modified by Human Action. By G. P. MARSH. A Revision of Man and Nature. Describes changes in the face of the earth caused by man, including desolation of various countries, once thickly inhabited, by removal of forests. Shows importance of maintaining natural balance of forces. *Price, \$3.50*

The Longleaf Pine in Virgin Forest. A Silvical Study. By G. FREDERICK SCHWARZ. This is a study of the life history of this important forest tree. Intended primarily for foresters and forest students; also for owners and managers of pine timber lands. Deals with the preference or dislike of the species for particular conditions of soil, climate, and environment. Illustrations and six tables. *Price, \$1.25*

IMPORTATIONS

Beautiful Rare Trees and Plants. By the EARL OF ANNESLEY. A description of some of the rarer English trees, shrubs and vines, illustrated copiously. *Price, \$12.00*

Forests of Upper India and Their Inhabitants. By THOMAS W. WEBBER. This volume is an account of the author's life in India during the period shortly after 1857. It contains a vivid description of the country, its people, customs, etc., with some description of its forests and timber wealth. *Price, \$5.00*

IRRIGATION ENGINEERING AND CONSTRUCTIVE WORK

Design and Construction of Dams. By EDWARD WEGMANN. This volume includes an authoritative discussion of the constructive work involved and the principal forms of construction. Masonry, rock-fill and timber dams are discussed extensively. *Price, \$6.00*

Improvement of Rivers. By B. F. THOMAS and D. A. WATT. This volume is a treatise on the methods employed for improving streams for open navigation and for navigation by means of locks and dams. *Price, \$6.50*

Irrigation Engineering. By HERBERT M. WILSON. This is the fourth edition of Mr. Wilson's popular work, and the revision and enlargement which it has undergone, places it at the forefront of text books on the subject for American students. *Price, \$4.00*

Engineering for Land Drainage. By C. G. ELLIOTT. A manual for laying out and constructing drains for the improvement of agricultural lands. *Price, \$1.50*

Reservoirs for Irrigation, Water-power, and Domestic Water-supply. By JAMES DIX SCHUYLER. An account of various types of dams and the methods and plans of their construction, together with a discussion of the available water-supply for irrigation in various sections of arid America, distribution, application, and use of water; the rainfall, runoff, and evaporation from reservoirs, and effect of silt, etc. *Price, \$5.00*

Water Supply Engineering. By A. PRESCOTT FOLWELL. A treatise on the designing, construction and maintenance of water-supply systems, both city and irrigation. *Price, \$4.00*

Water Power. By JOSEPH P. FRIZELL. An outline of the development and application of the energy of flowing water. Price, \$5.00

Concrete, Plain and Reinforced. By FREDERICK W. TAYLOR and SANFORD E. THOMPSON. Designed for practicing engineers and contractors; text and reference book for students. Discusses materials, processes, and applications of concrete in construction and specifications. Price, \$5.00

Hydraulics. By MANSFIELD MERRIMAN. Purpose of book is to keep abreast of modern progress, and present subject with conciseness and clearness. Gives general principles and discusses flow of water through various kinds of openings and channels. Historical notes and references. Price, \$5.00

Foundations. By W. M. PATTON. A practical treatise explaining fully the principles involved. Numerous descriptions of important modern structures are given in sufficient detail. Includes articles on use of concrete in foundations. Price, \$5.00

Masonry Construction. By IRA O. BAKER. Contains results of a great number of experiments, and a large amount of practical data on cost of masonry, pile driving, foundations, culverts, etc., and 97 tables to facilitate estimating. Price, \$5.00

Reinforced Concrete. By ALBERT W. BUEL and CHARLES S. HILL. A treatise for designing and constructing engineers, governed by American practice and conditions. Theoretical discussions omitted, and replaced by practical working formulas, examples of representative structures, and records of practice. Price, \$5.00

BOOKS ON RELATED SUBJECTS

Utilization of Wood Waste by Distillation.—By Walter B. Harper. An important treatise on a subject regarding which the interest is great and the information scarce. Is intended to aid in the establishment and conduct of wood distilling enterprises on a business basis. Price, \$5.00

The Garden

Roses and How to Grow Them. By many Experts. In text, practical; in subject and quality of illustrations, beautiful. Price, \$1.20

Ferns and How to Grow Them. By G. A. WOOLSON. The growing of hardy ferns, both in the garden and indoors. Price, \$1.20

Lawns and How to Make Them. By LEONARD BARRON. For the first time the subject of lawn seed mixtures is set forth and explained. 32 photographs. Price, \$1.20

How to Make School Gardens. By H. D. HEMENWAY. This suggestive little book is a practical manual of school gardening for both teacher and pupil, and supplies the first adequate work of the sort in this country. There are to-day a hundred thousand school gardens in Europe, and the progress of the recent movement in America has been most rapid. This volume is based on actual experience (the author is an authority and director of the Hartford School of Horticulture). Illustrations, 10. Price, \$1.10

How to Make a Fruit Garden. By S. W. FLETCHER. An eminently practical work on the subject of fruits for the home. With 182 photographic illustrations by the author. Price \$2.25

How to Make a Flower Garden. A charming and a practical book by experts on every branch of the subject. More than 200 beautiful photographs. Price, \$1.75

How to Make a Vegetable Garden. By EDITH L. FULLERTON. The only adequate book on the home vegetable garden. 250 photographs by H. B. Fullerton. Price, \$2.20

Art and Craft of Garden Making. By THOMAS H. MAWSON. Third edition of this standard; out of print for a year, and now reissued in revised form. Over 100 plans and details of gardens. Methods employed by successful designers carefully analyzed. Characteristic sites in typical districts described and pictured. Price, \$15.00

The Home and Farm

The Country House. By CHARLES EDW. HOOPER. A practical manual of house building, absolutely invaluable to everyone with a country place. It covers every branch of the subject in detail and treats of the garden and its furnishings in connection with the dwelling. 380 photographs and plans. Price, \$3.30

Three Acres and Liberty. By BOLTON HALL. Description of what can be accomplished on a small place in the way of gardening, home-making, and addition to financial resources. Were it not for the unimpeachable authorities quoted, its statements as to the possibilities of the "Little Lands" for a living would seem fanciful. Price, \$1.85.

The Making of a Country Home. By J. P. MOWBRAY ("J. P. M."). This delightful story showed its universal appeal when published serially, and the volume amply carries out the intention of the author. Besides its practical interest for the thousands of city dwellers who have dreamed of having a country home, the story is one of such reality, humor, and interest as to ensure it the widest circulation in book form. Elaborately decorated. Price, \$1.65

The First Book of Farming. By CHARLES L. GOODRICH. No one interested in farming, old or young, can fail to appreciate this book, for it really gives the fundamental knowledge of how to conduct a farm with the least expense and the largest return. There are 63 full pages of helpful illustrations. The price is extremely low for a work of such value. 63 pages of photographs. Price, \$1.10

Nature Books

American Food and Game Fishes. By DAVID STARR JORDAN and B. W. EVERMANN. Fills a long-felt need in popular scientific works, being a full account of the life-histories and methods of capture of North American food and game fishes. The only book in existence which will enable the amateur readily to identify species new to him. With 10 lithographed color plates, 100 photographs of live fish in the water, and 200 text cuts. Price, \$1.40

Nature Biographies. By CLARENCE M. WKEED. This volume is a sort of personal acquaintance with the lives of the more common butterflies, moths, grasshoppers, flies, and so on, the sort of fascinating details of these insect existences which make the reader want to go out and study these every-day marvels for himself. 150 photographic illustrations. Price, \$1.50

The Brook Book. By MARY ROGERS MILLER. A brook is one of the most living and companionable features of the landscape, and few people, even the most ardent nature lovers, realize what an endlessly interesting study its changes and its throbbing life afford. It is a fascinating subject which the author (well known as a teacher, lecturer, and writer connected with the Nature Study Bureau at Cornell) handles with much ability. 16 photographs. Price, \$1.50

Outdoors. A Book of the Woods, Fields and Marshlands. By ERNEST MCGAFFEY. Papers on out of doors, showing a love of nature and keenness of observation and power and beauty of description rarely surpassed. Price, \$1.25

Nature and The Camera. By A. RADCZYFFE DUGMORE. Mr. Dugmore is an expert in the new movement of photographing live birds, animals, fish, flowers, etc. His works brought him so many requests for information, that he has set down here a full and detailed account of his methods. From the choice of a camera to questions of lighting, and to the problem of "snapping" shy birds and animals in their native haunts, every step is explained so simply as to be easily comprehended, even by the beginner. 53 photographic illustrations. Price, \$1.50

THE American Forestry Association

Officers for 1908

President

Hon. JAMES WILSON, Secretary of Agriculture

Vice-Presidents

N. W. McLEOD LEWIS DILL FRANK W. ROLLINS
WILLIAM IRVINE EDWIN A. START

Advisory Board

SILAS W. GARDNER H. H. WHELESS
GEORGE T. CRUFT PHILIP W. AYRES ROBERT C. LIPPINCOTT
GEORGE F. CRAIG C. A. SMITH F. E. WEYERHAEUSER
GELRGE E. STONE ALLEN CHAMBERLAIN D. E. KLINE
E. F. SAWYER KENT SHEPPARD

Vice-Presidents-at-Large

DR. EDWARD EVERETT HALE MR. JAMES W. PINCHOT
DR. B. E. FERNOW MR. JOHN L. KAUL

Secretary, THOMAS ELMER WILL, Washington, D. C.

Assistant Secretary, WILLIAM CANFIELD LEE, Washington, D. C.

Treasurer, OTTO LUEBKERT, Washington, D. C.

Directors

JAMES WILSON HENRY S. GRAVES W. W. FINLEY
WILLIAM L. HALL F. H. NEWELL GEORGE K. SMITH
GEORGE P. WHITTLESEY GIFFORD PINCHOT WILLIAM S. HARVEY
JAMES H. CUTLER N. J. BACHELDER H. A. PRESSEY
RUTHERFORD P. HAYES ALBERT SHAW GEORGE F. PEABODY

Application for Membership

To THOMAS ELMER WILL

Secretary American Forestry Association

1311 G Street, N.W., Washington, D. C.

Dear Sir: I hereby signify my desire to become a member of the American Forestry Association. Two Dollars (\$2.00) for annual dues are enclosed herewith.

Very truly yours,

Name _____

P. O. Address _____

.. T H E ..

AMERICAN FORESTRY ASSOCIATION

President—HON. JAMES WILSON,
Secretary of Agriculture.

The American Forestry Association was organized in 1882, and incorporated in January, 1897. It now has over 6,600 members, residents of every State in the Union, Canada, and foreign countries. From its origin it has been the tireless friend of the forests.

The object of the Association is to promote the preservation, by wise use, and the extension of the forests of the United States; its means are agitation and education; it seeks to encourage the application of forestry by private owners to forest holdings, large or small; and it favors, especially, the establishment and multiplication of National and State forests, to be administered in the highest interests of all.

The Association seeks as members all who sympathize with its object and methods, and who believe that our natural resources constitute a common heritage, to be used without abusing and administered for the common good. Seeking to conserve our supplies of wood and water, the Association appeals especially to wood-producers and users, including owners of wood lands, lumbermen, foresters, railroad men, and engineers; and to those dependent upon equable stream flow, as manufacturers, irrigators, employers of water power, and those engaged in internal commerce.

The Association meets annually in Washington. It publishes, monthly, FORESTRY AND IRRIGATION, the magazine of authority in its special field. The list of contributors to this publication includes practically all persons prominent in forest work in the United States, making it alone worth the cost of Annual Membership in the Association.

The dues, covering a subscription to FORESTRY AND IRRIGATION, are as follows: Annual—For Annual Members, \$2; for Sustaining Members, \$25; Total, with exemption from all other payments—for Life Members, \$100; for Patrons, \$1,000.

THOMAS ELMER WILL, Secretary.

Address: 1311 G Street, N. W., Washington, D. C.

The LAND OF LOVELY DREAMS

WHERE THE KNOTTED
NORTHERN NERVES
MAY RELAX AND REST

THE TAMPA BAY HOTEL,
TAMPA, FLA.



HEDDRA
AGGKER

WHY should one go to Tampa rather than the resorts on the other coast of Florida? Because the climate of the west coast is far more equable, less enervating, more beneficial to nerves and mind than any other. The climate of Tampa is dry and its tropical warmth is tempered agreeably by westerly breezes from the Gulf of Mexico. While the glorious sunshine in the day time reminds one of the close proximity of the tropical Everglades, night brings with it refreshing coolness and fragrant dews, and with them comes, without fail, "Nature's sweet restorer, balmy sleep."

Apply to agents of The Seaboard Air Line Railway, The Atlantic Coast Railway, Southern Railway, and their connecting lines.

Booklet and Tariff sent on application.

DAVID LAUBER, Manager, Tampa, Florida



**100 TREES
FOR \$1.00**

Raise your Forest and Ornamental Trees and Shrubs from Seed.

This is the cheapest and best way to have the finest trees and shrubbery, and affords a great deal of pleasure.

We have a special collection of seed of our five best trees from which you can grow hundreds of hardy plants. This collection, by mail, for \$1.00. When you order state where trees are to grow and we will send the kind that will grow best. Order the collection now, and also—

Get our handsomely illustrated and uniquely descriptive Catalogue of tree and shrub seeds. It gives reasons, "why," "when" and "how."

OTTO KATZENSTEIN & CO.
Atlanta, Ga.

Timber Lands FOR SALE

Tracts of yellow pine, hemlock, etc., in Florida, of 50,000, 150,000, 300,000 and 1,200,000 acres. From 4,000 to 7,000 feet to the acre.

Water and Railroad Facilities.

Summer all the year round; also tracts of yellow pine and hardwood in 25 to 100,000 acre lots in other Southern States. **We want Large Tracts of Gum and Cottonwood.**

Address Nelson, care Forestry and Irrigation.

The celebrated Hungarian and English Partridges and Pheasants, the large Hungarian Hares, all kinds of Deer, Quail, etc., for stocking purposes. Fancy Pheasants, ornamental water fowl and live, wild animals of every description. Write for price list.

Department 5 — **WENZ & MACKENSEN** — Yardley, Penna.

SOUTHERN TIMBER LANDS FOR SALE

Have some exceptionally attractive propositions in Southern timber lands, pines, cypress and hardwood. If you have money for such investments, write me. JOHN C. ENGLAND, Missouri Trust Bldg., St. Louis, Mo.

TO BUY OR SELL LAND FARM OR TIMBER

WRITE TO **FRED HAYSSEN, ANTIGO, WIS.**

FORESTRY AND IRRIGATION

THOMAS ELMER WILL
WM. CANFIELD LEE

Editor
Associate Editor

CONTENTS FOR JANUARY, 1908

PERSONS PRESENT AT THE RANGERS' MEETING, ROSEBURG, OREGON, OCTOBER 18-21, 1907. *Frontispiece*

EDITORIAL:

National Forests Not "Reserves"	3	Paducah Forestry Association	13
A Lumberman's Testimony	3	New Jersey Forest Council	13
Funds for Teaching Forestry	3	Pennsylvania National Forests	13
"Prosperity" That Means Adversity	4	Do Not Stop with Appalachians	13
We Must Use the Law	5	Yale Forest School Notes	14
Wasteful Saving	5	Yale Seniors to Alabama	14
The Wood Pulp Situation	6	Miners and Trans-Mississippians	14
The Rights of Others	7	Arbor Day in Hawaii	15
Forcing Destruction of Forests	8	Newspapers Raising Prices	15
The Rivers and Harbors Convention	8	The Drainage of Southern Marshes	15
Forests Fundamental	10	Practical and Useful Statesmanship	16
Irrigation	10	A Third Kind of Reclamation	16
Drainage	10	A Municipal Cement Plant	16
Inland Water	10	Utilize Whatever Is Cut	17
Utopia vs. China	11	Wish to Share Their Blessings	17
		Vermont Women Promote Trees	17
		What Timber Land Sales Indicate	18
		Georgia Shows Live Interest	18
		Electrical Engineers Resolve	18
		Appalachian National Forest Ass'n	19
		New Forest Legislation in Alabama	19
		Ranger Meeting at Roseburg, Oregon	20
		Ontario's Monopoly of Spruce	20

NEWS AND NOTES:

Miscellaneous News	12		
Keep Pounding Away	12		
Intensive Farming in California	12		
Looting Our Inheritance	12		
State Commission Sues Railroad	12		
Endowing a Chair of Lumbering	12		

APPEALING TO THE SOUTH	21
REPORT OF SECRETARY OF AGRICULTURE ON THE APPALACHIAN WATERSHEDS	22
THE HEART OF A TREE. By H. C. Bunner. (<i>Poem</i>)	24
SOUTHERN APPALACHIAN-WHITE MOUNTAIN NATIONAL FOREST BILL	25
THE WHITE MOUNTAINS. By T. L. Hoover. (<i>Poem</i>)	27
HOW NATIONAL FORESTS WOULD AFFECT THE PEOPLE	28
THE DOMINION OF THE LONE CONE. By Olive M. McKinley (<i>Illustrated</i>)	29
THE OREGON SIERRA. By Joaquin Miller. (<i>Poem</i>)	34
LUMBERMEN'S VIEWS ON REFORESTATION. By C. H. Goetz. (<i>Illustrated</i>)	35
THE MONARCH OF THE WOODS. (<i>Poem</i>)	38
HOUGH'S BOOK OF AMERICAN TREES. (<i>Illustrated</i>)	39
THE CITY ON THE PLAIN. By Millard F. Hudson. (<i>Poem</i>)	42
SECRETARY WILL'S LECTURE TOURS	43
THE CANALS: A GLORY OF FRANCE. By J. J. Jusserand	44
IN THE HEART OF THE WOODS. By Margaret E. Sangster. (<i>Poem</i>)	47
THE NATIONAL RIVERS AND HARBORS CONGRESS. By Lydia Adams-Williams	48
UNITED STATES FOREST SERVICE	51
UNITED STATES RECLAMATION SERVICE	54
RECENT PUBLICATIONS	57

FORESTRY AND IRRIGATION is the official organ of the American Forestry Association. Price, \$2.00 per year, including Annual Membership in the Association. Copyright, 1907, by The American Forestry Association. Entered at the Postoffice at Washington, D. C., as second-class mail matter.

Published Monthly at
1311 G STREET, N.W. WASHINGTON, D. C.

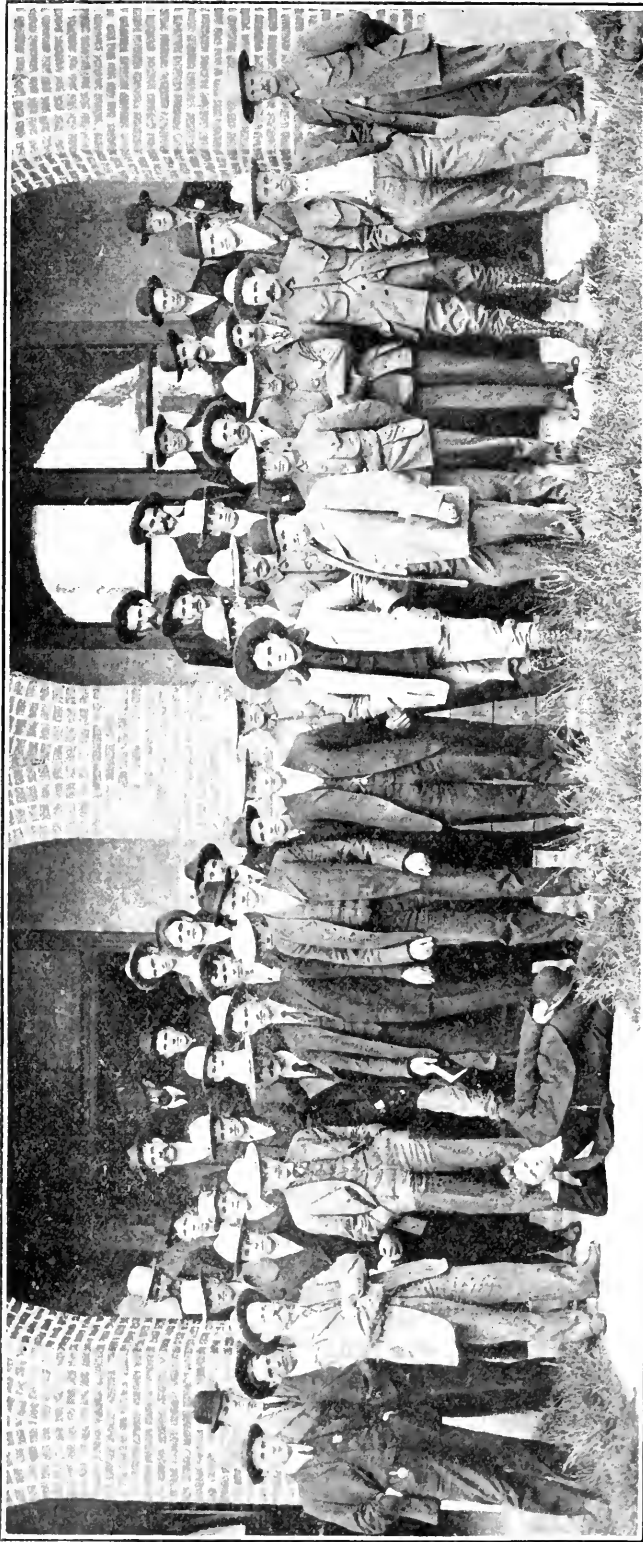

Persons present at Rangers' Meeting, Roseburg, Oregon



FORESTRY AND IRRIGATION

Vol. XIV

JANUARY, 1908

No. 1

EDITORIAL

"National Forests" Not "Reserves"

Old names stick. Prior to the last session of Congress our Governmental forest holdings were styled "reserves." At the last session of Congress, happily, this name was changed to "National Forests." In our April issue (page 168) this change was discussed and strongly approved by FORESTRY AND IRRIGATION. Let the old name die as quickly as possible, and the new take its place.

A Lumber Man's Testimony

Among Secretary Will's auditors at Eau Claire, Wis., on November 12, was one of the leading lumbermen of the State. Following the address, he arose to second the resolution urging the passage of the Appalachian Bill. Among other things, he said in substance:

"You have been shown a slide representing a forest under proper management. You note that the brush was piled to be burned under supervision. Some years since, our company applied to the Government for a piece of forest land. We were told that we could have it only on condition that we handled the brush in this manner.

We hesitated for some time, regarding the proposal as impractical and unduly expensive. However, having no alternative, we finally accepted the terms.

"Since then we have tested the matter thoroughly. We are prepared to state that the policy is thoroughly practical and but moderately expensive; and, further, that if, during all the years in which we have been denuding this valley, we had operated upon the same plan, piling the brush and burning it so as to prevent forest fires, we should now have growing upon the same land three times as much timber as we took out."

From a hard-headed, practical, money-making lumberman, such a testimony is noteworthy. It should be heard and heeded by all who regard forestry principles as "impractical," and by those who still insist that our National Forests should be thrown open to be looted in the good, old, orthodox way.

Funds for Teaching Forestry

A plan to be urged upon Congress at the present session is very commendable in its promise of beneficial

NEW
KIT
GARD

effect. It is to secure instruction in forestry in the State Agricultural Colleges throughout the Union, and experiments in forestry to be made by the State Experiment Stations. The proposal is to add to the Morrill and Hatch funds, by which the colleges and stations are endowed, \$2,500 for each of these purposes—so much for forestry instruction to students, and the same amount for research, making a total of \$5,000.

The Davis bill, aiming at this end in a previous Congress, has been re-drafted, and it is to be hoped that it will receive earnest support from the country. The income derived from the National Forests has been used for several years to put the United States Forest Service on a good footing. At its last session Congress directed that the income should no longer be used for this purpose, but covered into the Treasury. What could be more appropriate than to use a portion of it for adding to the people's knowledge of methods of preserving and economizing the woodland resources which they possess outside the National Forests? Four-fifths of the woods of the country are in private hands; and a large share of these are in the shape of farm woodlots. The farmers, at their colleges, should be taught to improve their timber crop as well as other crops.

**"Prosperity" In *Forest and Stream*
That Means Adversity** for November 2d appears a letter from Dr. C. P. Ambler, of Asheville, N. C., sketching the history of the Appalachian movement, reporting the Asheville meeting addressed by Secretary Will, giving the resolution adopted and saying: "There has been established in the heart of the section under consideration (the Southern Appalachian region) one of the largest tanneries in the world; there is now being built at Canton, thirty miles west of Asheville, what is expected to

be the largest paper pulp mill in the world. Haywood County has welcomed this pulp mill, and many talk of the great progress the county is now making toward prosperity. They look upon the million dollar building which is being put up as the greatest thing that has ever happened in the county. True, there is more money in circulation in the county to-day than ever before, but when those of us who have traveled over the counties of New Hampshire, Vermont and Michigan, where nothing but fire-blackened stumps are to be seen, look forward, it does not require a very vivid imagination to see that Haywood County in thirty years from now will be the most desolate section of Western North Carolina. If the Government does not take a hand and regulate the cutting of the forests of our steep mountain sides, places like Haywood County with to-day their million dollar paper pulp plants, will in another generation, in all probability, be abandoned wastes and desolate lands."

Truer words were never spoken. If the people of Haywood County, North Carolina, want to learn in advance what their great million dollar pulp mill will mean to the community, let them get into touch with some of the communities referred to by Dr. Ambler. They should have heard, for example, the words spoken to Secretary Will on the occasion of his recent meeting (November 27) at Bay City, Mich., by some representative citizens of that place. In terms well weighed but weighty and blistering they described the bygone reign of the lumbermen in their city and region, the crisis which followed the abrupt ending of the lumber business, the long, slow period of recuperation and their wholesome dread lest the policy of reforestation, now so actively urged in Michigan, might result in a repetition of the old-time experiences. The burnt children fear the fire, and the citizens of Haywood County may profitably learn from their experience.

**We Must
Use the Law**

A correspondent of this office tells, in a despairing manner, of havoc wrought by cutting down young forests in the South in order to construct a railroad trestle, with resultant danger of landslides on the mountain; and this in spite of the fact that the railroad officials were supposed to appreciate the dangers attending deforestation. Yet notwithstanding his feeling of hopelessness, he joins The American Forestry Association in order to help the creation of a public sentiment to correct the evil.

The forest destruction in progress in the United States is tragic; if continued, the results will be grave.

That business men, nominally in sympathy with the forestry movement, are in some cases active in aiding and abetting this destruction, is indisputable. Had we no other recourse than to appeal to them to desist, we might feel the cause to be hopeless. Business is conducted for private profit; and, this being the case, public interest must, as a rule, be brushed aside in the world-wide struggle for gain.

But we have other recourse. We have, in this country, a government—in fact, a number of governments. The ostensible object of government is to safeguard the interests of the entire people. It is the business of government, therefore, to protect the forests—certainly such of them as, because of their size, position, and relation to large and varied interests, are of public concern.

Several of the State governments in this country are taking steps to protect the forests within their jurisdictions. The greatest work, however, is being conducted by the National Government through the Forest Service.

Experience shows that the Forest Service is, actually and appreciably, improving the forest situation in the areas committed to its charge. The work of this arm of the National

Government is notable, and is big with promise.

Situations such as that described by our correspondent are doubtless to be saved, if saved at all, through control by the Forest Service.

Here is the field for associated and individual activity. The American Forestry Association seeks to instruct the public as to the principles of forest preservation and extension, not only by private activity but by pushing the system of National Forests.

One of the great objects now before it is the establishment of National Forests in the Southern Appalachian and White Mountains. For some years, a bill for this purpose has been aggressively pushed by the Association.

Moses, in his journey toward the Promised Land, came to the very border, only to perish there. Such was the fate of this bill in the 59th Congress. Friends of the forests must highly resolve that in the 60th Congress the bill shall, without fail, be inscribed on the Federal statute book.

Here is an opportunity for all to unite in promoting the end which is so vital to the public well-being. All citizens who are mindful of their duty should use their influence with their fellow citizens and with members of Congress to secure the passage of this bill.

**Wasteful
Saving**

Some, upon whom is beginning to dawn some faint appreciation of the manner in which we are destroying the very planet upon which we live, and laying up for our children an inheritance comparable to that of the famine-stricken nations of the Old World, are beginning to admit that the establishment of National Forests in the Appalachian and White Mountains is desirable, but are holding off for fear some species of "graft" may be concealed in the measure.

Graft is bad enough, unquestionably. And that it has entered into leg-

isolation and administration, municipal, State and National, there can be no doubt. Indeed, even now, its sinister features may, to the seeing eye, be perceived protruding, in countless places, from measures long lauded as of the highest utility and public necessity. Cut out the graft, by all means. As Carlyle said of the lie, it exists only to be killed. Wherever it rears its foul head aloft, it cries unto all men, "Come and slay me!"

Fortunately, the Appalachian bill has been so drawn that it seems incredible that graft can find in it a hiding place. Let it, however, be inspected with a microscope and, in the interests of safety, subjected to every form of germicide known to the political laboratory. But, when all is said and done, remember this: the waste now attending the failure to enact this legislation is, to the expense attending its enactment, plus any graft which may still linger in the shadow, as the mountain to the mole-hill. Dr. C. P. Ambler, who has known the Appalachian movement from its first inception, says that if the Government had bought the Appalachian lands in 1899, when first asked to do so, it would have saved from twelve millions to fifteen millions of dollars simply in the value of the land and timber purchased. Compare this with the petty three million dollars which the last Congress was asked to appropriate to buy this land, or with the trifling five million dollars which it is now asked to appropriate! And then compare, if possible, the appropriation asked, plus any possible "graft," with the inconceivable waste of natural resources daily accompanying the cutting and burning of the woods, the erosion of fertile fields, the deposit of soil in rivers and harbors on which, to remove it, multiplied millions must be expended, the washing away of houses, railways, bridges, mills, and factories, the eighteen-million dollar item of flood destruction in a single section of the South in 1901-'02, and then tell us how long should Congress

withhold action for fear of possible "graft." By such a course, is it not wasting at the bung-hole while saving at the spigot? Is it now swallowing camels while straining out gnats? Is it not leaving fertile fields to grow up in weeds for fear of spending money on seed corn? Is it not permitting the ceaseless, relentless, day and night, year in and year out, undermining of our National edifice to save the wages requisite for the prevention of such a calamity?

**The
Wood Pulp
Situation**

On November 23, a leading Western daily newspaper, in announcing an increase in its price, used the following language:

"Production of newspapers in the United States has caused such an enormous consumption of wood pulp that the forests of spruce and other pulp woods are nearly swept away. No substitute material has been discovered and, in the face of the diminishing supply, paper manufacturers have felt compelled to rapidly advance their prices.

"This advance is threatening to end the day of one-cent newspapers. They have grown to such size that even a fractional advance in the cost of paper necessitates either a revolution in business methods or an advance in the price of newspapers. The market price of print paper has advanced from \$1.90 and \$2 per hundred pounds to as high as \$2.50 and upward. Manufacturers believe that in the near future they will be compelled to again advance the price. The situation has grown more and more acute with each advance. The mills have been turning to Canada for their supply of spruce, but, remembering the effect of their export duty on pine logs when the lumbermen were bringing them across the border, Canadians are now agitating strongly the policy of putting an export duty on spruce. This has made the American mills more apprehensive for the future. The result is that publishers are practically bound hand and

foot; so much so that they are not getting the cost of the white paper for many editions that are sent out."

Another straw is found in the following bit of information furnished directly to this office:

A New England paper, owned by three men, has been paying an annual dividend of from fifteen thousand to twenty thousand dollars. Print paper has been costing this firm \$1.85 per hundred pounds. Within recent months the price of paper began to rise. When the increase began to look serious the leading owner sought out a friend in the paper company and expostulated. He was told that, for friendship's sake, he would be given some inside information in advance, namely, that the price would soon go still higher and that he would do well to make a one-year contract at the existing price, namely, \$2.50. This he did, and the price afterward ascended to \$3 and \$3.25, settling later at \$3.

The increase, however, from \$1.85 to \$2.50 which alone, "for friendship's sake," this firm was required to endure, cut the annual dividend of its paper fifteen thousand dollars. Where the paper would have been, but for its "inside information," may be inferred.

That newspaper men should be interested in the removal of the duty on wood-pulp is easily understood. The suggestion, however, that Canadians may put an export duty on spruce is by no means reassuring.

But, duty or no duty, it must never be forgotten that Canadian wood supplies, like American wood supplies, are far from inexhaustible. The complete levelling of the tariff wall between Canada and the United States, while it would undoubtedly relieve, in a measure, the wood situation on this side the line, could relieve it but temporarily. Under present policies of timber slaughter, the Canadian supply would but disappear the more rapidly, and the evil day, for a brief space deferred, would again dawn. Whatever may or may not be done with the tar-

iff, one thing is certain: the United States must adopt, and that speedily, a rational policy for the conservation and use of her timber supplies.

The Rights of Others

We find the following in The Baltimore *World*.

It is not only New Englanders who can appreciate the pity of ruining the beautiful White Mountains:

"The destruction of forests in the White Mountains goes on apace. One of the last acts of forest vandalism is the cutting of the woods on one of the most delightful drives near North Conway, N. H. It is not isolated, but typical of many acts of scenic spoliation. In this instance not merely was the wood cut off, but the brush was thrown into the stream, so that it was almost impossible to approach it, and when one struggled through the rubbish he found a brook wholly stripped of its beauty. In many other parts of the mountains the forests that have been the glory of the great ranges are rapidly disappearing.

"There does not seem to be the slightest evidence that the forest vandals intend to cut the lumber again, when a new growth is ready for the ax. Everything is swept clean. A man has a right to do what he will with his own, so long as he does not infringe on the rights of others, and consequently scenic attractions are in constant danger. But the rapid devastation of our mountains, which is sheer vandalism, due to ignorance of forestry, is a menace to the surrounding property.

"The streams are diminishing, the spring freshets are more disastrous, the accumulation of inflammable brush makes fires more frequent. The time must come when the Government will take over as National or State parks such points of attraction as the White Mountains, which even from a pecuniary point of view are worth incomparably more to the people of New Hampshire as objects of beauty than they possibly can be to any lum-

ber company as rather indifferent wood lots."

Speaking of the rights of others, does any one really have the right to ruin for all men the mountain landscape? Is this not a moral infringement on the rights of others? If the law allows it, then the "others" have need of more legal rights to make good their moral rights.

But, on the other hand, have the "others," represented by the State, the moral right to confiscate, through unjustly heavy taxation, the property rights of the owners of *standing* timber, thus forcing them to cut their woods, and cut them clean, or else lose them?

Forcing Destruction of Forests

A huge obstacle to the preservation of privately owned forests is the system of taxation in vogue which, year after year, taxes the full timber value of the trees, whether used or not, as though timber were a series of crops, whereas, under present policies, it is only one crop. The taxation applies even before the trees are mature, hence they are often cut when they should be allowed to grow much longer.

This system is found in most of the States, and is often buttressed by constitutional provisions. Amendments must be made wherever necessary; for it is imperative that the immense amount of privately owned woodland shall be saved from forced destruction. With citizens and States, as well as the Federal Government, anxiously asserting themselves to extend the forest area, it is preposterous to compel the cutting of that which exists, and which the owners might be glad to leave standing.

That difficulties attend the question of forest taxation will be evident on reflection. The lumberman's contention that he is not a sinner above all others, but simply a business man, seeking, like other business men, to realize on his investment, is unassailable. If attacked with the weapon of taxation the average business man, in

whatever line, will seek to protect himself, though at the expense of the public interest. The evidence in support of this point is overwhelming.

When, however, it is proposed materially to reduce the tax on timber in order to prevent the cutting of the forests, the objection is raised that this act involves discrimination against other property owners in favor of the big lumber companies and the rich lumbermen, and that such discrimination is both unfair and impolitic.

In an article of this issue by Mr. C. H. Goetz the proposal is made that the tax be laid not on standing, but on cut, timber. Such a tax would surely operate toward saving the forests. If it is argued that the tax on cut timber would be evaded because the logs would be quickly removed, the answer is that the fresh stumps would testify clearly to the cutting.

In his recent trip through Wisconsin and Michigan, the editor of this publication heard the forest taxation question discussed from various viewpoints with energy, not to say feeling. FORESTRY AND IRRIGATION has no desire to be dogmatic on the question of methods. It sees clearly the end, and earnestly desires to subserve it. Realizing the importance of the taxation question it cordially invites the expression, through its columns, of individual views on this question, whether such expression takes the form of an article, or of a mere paragraph. Let us have all the light which can be gotten.

And, meanwhile, let it be remembered that one solution of the problem stands out clearly: that, namely, of public ownership, National, State, or municipal, as the case may be. With the return, as on our National Forests, of 10 per cent of the proceeds to the local community, the forest is saved and the tax question is solved.

The Rivers and Harbors Convention

Inland waterways is an inspiring theme. The proposals to unite the Potomac to the Ohio, Lake Michigan

to the Gulf, and Pittsburg to Lake Erie, by water, lift one into the realm of large conceptions. Yet the first was advocated by Washington, the second by Madison, and the third by Calhoun; hence, at the dawn of the twentieth century, they should not be regarded as novel.

With these proposals go others; the union of Toledo with Cincinnati by a deep waterway, of Toledo with Chicago by means of a barge canal, of Chicago with New York by way of the Great Lakes, the Erie Canal and the Hudson, and even of New York with Puget Sound. The connection of the Mississippi, Ohio and Tennessee Rivers with the Coosa, Ocmulgee and Altamaha, thus uniting the Ohio-Mississippi systems with our South-eastern coast waters by Mobile and Brunswick, respectively, and a continuous inland waterways route from Boston to Beaufort, and beyond, are other of the projects.

Our attention is called to our eighteen thousand miles of navigable inland waterways, to the presence of deep water upon three of the four sides of our country, and to the mighty Mississippi almost bisecting her from North to South, thus opening up possibilities which led Napoleon, a century ago, to declare that the nation which controlled the Mississippi would become the mightiest on the globe.

Men are already dreaming of a time when the waters of a country may be controlled much as are the waters of a city; and when, instead of being forces of wrath and destruction, they will have been transformed into the obedient and potent servants of man. They are recognizing that, to attain an end so great, statesmanship must rise above the level of service to mere local interests, must fix its gaze earnestly upon the physical map of the entire United States, and must realize that the inland waterways problem is primarily a National problem. Following this, they must devise a comprehensive scheme of waterways development and improvement and must largely intrust the administration of

this to a permanent body which, with the minimum of interruptions from swings of the political pendulum, may pursue, year by year and decade by decade, a constructive policy whose fruits will endure as the pyramids have endured and will unceasingly bless the Nation and the race.

Elsewhere will be found a detailed account of the National River and Harbors Congress Convention, which assembled in Washington December 4th, 5th, and 6th, last. In this connection, attention may be called to the great size and representative character of the body, and to the breadth of its platform, which stands "not for a project but for a policy." In view of the fact that inland waters, in the opinion of some, have been deemed objects of jealousy or even of hostility by railways, it is noteworthy that two eminent railway presidents, James J. Hill, of the Great Northern, and W. W. Finley, of the Southern, appeared before the Convention and, in carefully prepared papers, strongly urged the fullest development of this means of transportation. President Hill again called attention to the fact that the growth of commerce has far outrun the growth of railway facilities, and that inland waterways are absolutely indispensable to the handling of the traffic of the country.

The intimate connection between inland waterways and forests was clearly pointed out, former Gov. George E. Pardee, of California, showing that "rivers and harbors begin in the mountains," and Ambassador Jusserand declaring that "if the Mississippi is 'the father of waters,' the forest is the father of the Mississippi."

Substantial encouragement was extended to the program of the Convention by Congressman Burton, Chairman of the Rivers and Harbors Committee of the House, and by President Roosevelt.

The financial end of a policy like this is, necessarily, of fundamental importance. The Convention asked for \$500,000,000 for river and harbor improvement. This they would have appropriated by the National Con-

gress in ten equal, annual installments. To raise this fund, a bond issue is suggested. Even at such a price, the work if wisely, promptly and honestly done would, from a National standpoint, be cheap. An examination, however, of the President's message will disclose other sources of revenue, notably taxes on incomes and inheritances. A policy so vast and beneficent, so long considered, and designed for a Nation so great, powerful and wealthy as the United States, should not halt for lack of means. The names of its promoters should live in our National history as the names of builders of the Republic.

Forests

Fundamental

Not all who are awakening to the gravity of the forest situation appreciate the fundamental character of the forest in our National economy. That it has to do with wood and all wood materials and products is evident. With forest destruction, it is clear that the lumber business must go, that the building industry must suffer and rents rise. The dependence of railroads upon wood, notably for ties and structural timbers, means that wood failure must raise the cost of transportation.

Irrigation

Readers of FORESTRY AND IRRIGATION also appreciate some of the causal relations between wood and water. They are aware, for example, that deforestation is a prolific source of floods. They should note, in addition, the connection between forests and irrigation. That the great Western desert may be converted into a fruitful field, it is but necessary that water be turned upon the sand. Within six years, Government irrigation has reclaimed a quarter of a million acres, now sustaining twenty thousand people. Director Newell estimates that, in another decade, two million more acres may be reclaimed, upon which a quarter of a million more human beings may maintain themselves. The water, however, for this

work comes from mountain streams, absolutely dependent upon mountain forests.

Drainage

Again, the great drainage question is involved. Vast areas of swamp land, notably on the lower Mississippi and the southeastern Atlantic Coast, still exist, constituting a negative, rather than a positive economic factor—a source of evil rather than of good. President George E. Barstow, of the National Drainage Association, estimates that our swamp lands, if drained, would afford homes of eighty acres each to one million families or five million people. The value of eighty million acres of land thus reclaimed, estimated at only \$50 per acre, would equal \$4,000,000,000. The annual earning power of this land, estimated at \$25 per acre, is \$2,000,000,000.

But, in many cases, to attempt merely to drain the swamps is to begin at the wrong end of the problem. It is to repeat the futile method of clearing river channels by simply removing silt and soil without preventing its re-entrance. Swamps are frequently the result of river overflows. To get rid of them, we must first stop the overflows. To this end we must store the floods: and, hence, must maintain forests on the slopes.

Inland Water

As noted, our greatest resource is our inland water. Mr. M. O. Leighton, Chief Hydrographer of the United States Geological Survey, puts the value of the water flowing down our Western mountains far beyond the fabulous wealth represented by the metals and minerals lying between the Rockies and the Pacific. Most of this resource is now wasted. Water running idly over Government dams might be made to yield, he estimates, \$32,000,000 per year which, capitalized at 3 per cent, represents an investment of \$1,066,000,000.

Again, our annual flood damage he

puts at more than \$100,000,000. Controlling and utilizing our waters would enable us to save this sum and produce annually a five-fold greater value.

Rivers, instead of running wild, may be controlled almost like city water. Such control, however, necessitates National action and a comprehensive plan in which the conservation of forests upon slopes is essential.

Thus the forest question underlies and largely dominates not only the question of wood, in all its forms, but the questions of irrigation, drainage, soil conservation and the control and utilization of our inland waters.

To say that the logical end of this policy of destruction is public disaster is to speak within bounds. A philosopher has declared that "No nation ever outlived its religion." However this may be, it is self evident that no nation can outlive its natural resources. Again, it is a matter of history and observation that some nations have sadly depleted their resources, with serious consequences to themselves. The Mediterranean lands are cases in point. The governor of a Roman province was expected to amass a fortune in a few, brief years. His method involved the most barefaced and brutal exploitation of both the people and the lands which were thrown to him as so much spoil of conquest. With him, the present was everything; the future, nothing.

Utopia vs. China

The lesson taught by China should be learned and never forgotten. In these days of evolution philosophy we are prone to assume that time only, coupled with industry, will bear us, as a Nation, forward irresistibly toward a state closely approximating the ideal. We habitually look at the past through the large end of the telescope and at the future, through the small end. We do not reflect that a crescendo movement may be followed by a diminuendo.

But look at China. Unquestionably, she has been great and powerful;

otherwise she could not, as an undivided nation, have survived to her present prodigious age. Yet few would argue that her progress has brought her to approximate national perfection, and the hope that she may even yet approach such a state is dampened by inquiry into the facts of her economic life.

In northern China, especially, the mountains, from base to summit, have been swept as bare of forests as are our city pavements. In consequence, they have been gashed and gullied by fierce torrents. Floods have devastated the valleys. Wood has become so rare as to be confined largely to the making of coffins, for which purpose it is borne on human backs down rugged slopes and defiles in journeys of sometimes ten days or two weeks. Fagots for fuel are a luxury of the rich. Grass, dug up by the roots from remote mountains, and stubble raked clean from harvested fields, constitute the chief forms of fuel. Farming is done on mountain sides on which soil, brought by flood waters or human hands, is held in terraces by stone walls, laboriously constructed. Rivers go dry in summer. Areas of their empty beds are then fenced in. Soil is caught in these when the river is full again and, on the recession of the water, is tilled.

Little wonder that such a land is the prey of famine, that the traveler passes through successive villages absolutely destitute of human inhabitants; and that, even in the more favored regions, the parent, upon the birth of a female child, frequently debates whether to drown it outright, or leave it to be carried away by the next famine.

Let those who have hugged to themselves the delusion that time alone, combined with industrial activity on present lines, will inevitably convert our land into an earthly paradise; and that such earnest warnings as those, for example, of the President, in his last message, are but the wailings of Cassandra, look at China—and think.

NEWS AND NOTES

Miscellaneous News Mr. E. A. Sterling, chief forester of the Pennsylvania Railroad, is on a six months' tour examining treating plants for tie and timber preservation. The Pennsylvania Railroad now has three trained foresters in its employ. The other two are Messrs. Bond and Sheppard.

The Iowa Park and Forestry Association held its seventh annual meeting in the horticultural rooms of the State House at Des Moines, on December 10th and 11th.

Salt Lake City, like Helena and Los Angeles, is going into forest culture. The city council has memorialized the Government to have more trees planted on the city lands, and to put the supervision of the lands in Parley's Canyon under the supervision of the Forest Service.

Keep Pounding Away The *Leader* has talked of forestry before. It will talk of it again. The subject is one that cannot be discussed too often. Besides, the attitude of the general public is such an indifferent one that those who seek to make a dent in its opinion must keep on pounding away.—*Cleveland Leader*.

Good for the *Leader*. The same method will make the needed dents in State and Federal statute books.

Intensive Farming in California There is no land on earth where intensive farming is more profitable than in California. The area that one man can care for and supervise to its fullest advantage must, of necessity, be small. Hence it is that intensive farming requires a small farm. With intensive farming, irrigation and diversity of crops go hand in hand, and the small farmer of California so regulates his crops and output that there is not a month in the year without its special income. The small farm, intensively cultivated with diversified crops, is a boon to the farmer.—*Pacific Monthly*.

Looting Our Inheritance The discoverers of America found themselves chin deep in a reservoir of rich natural resources. Your grandfather was in it up to his shoulders. Your father waded around waist deep in God's reserve of material mercy. You are standing in it knee deep. Your boy will find some of the rich original mud on his shoe soles, and your grandson will be raking over the dump for some of the old, abandoned scraps of the gone-by Golden Age. It will be but about five hundred years from the discovery of America to the final looting of her fat inheritance.—*Exchange*.

State Ccmmission Sues Railrad The complaint of the New York State Forest, Fish and Game Commission, which is suing the Long Island Railroad for \$200,000 for damage done by forest fires caused through lack of proper preventive measures on the part of the road, was sustained by Judge Jaycox, of the Supreme Court, sitting in Brooklyn.

The action was brought by the Commission upon the petition of many residents who declare that their property was being destroyed, and that the law gave the Commission the right to bring suit for the protection of the property under its care.

The railroad company filed a demurrer on the ground that the Commission had no jurisdiction outside of State preserves and parks, but Judge Jaycox decided that there was a just cause of action.

Endowing a Professorship of Lumbering The Yale Corporation has just received \$50,000 in lumber company bonds, which are for the endowment of a Chair of Applied Forestry and Practical Lumbering. This endowment is made by the National Lumber Manufacturers' Association; and the securities were conveyed by F. E. Weyerhaeuser, chairman, and William Car-

son, treasurer, of a committee for this purpose. Thus lumbermen, who have been most active in slaughtering the forests in the past, are joining with other citizens in the attempt to stay the slaughter now. The New York *American* urges others who wish to aid education to apply their money to similar endowments.

Paducah Forestry Association A local forestry association was recently organized at Paducah, Ky., at the instance of Mrs. Robert Becker Phillips, of the Forestry Committee of the Kentucky Federation of Women's Clubs. The Women's Club, The Magazine Club, The Delphic Club, the D. A. R., the U. D. C., the Alumni Association of the Paducah High School and the Commercial Club were represented. Mr. John S. Bleecker, of the Commercial Club, was made president, and Miss Aldine Morton, chairman of the civics department of the Women's Clubs, Secretary. A constitution and by-laws have been prepared.

Superintendent John A. Carnegie, of the Public Schools, plans to form a children's auxiliary to study the subjects of forestry and bird life. The D. A. R. and U. D. C. chapters will have charge of the preservation and marking of historical trees.

It was the Paducah Forestry Association that arranged for the lecture given by Secretary Will on September 29th. A very representative audience of Paducah citizens attended the meeting, deep interest was manifested and a strong set of resolutions, urging the passage of the Appalachian Bill, was adopted. One and one-half and two-column reports, respectively, of the meetings were published in two of the Paducah papers.

New Jersey Forest Council Forestry work in New Jersey is becoming more popular. Although the forest law is not wholly brought into execution, yet the moral effect of it is accomplishing the work of forest protection. The New Jersey State Forest

Council is an association of citizens. It is an outgrowth from the West Vineland Farm Club. Forty years ago a committee on forestry was appointed by that club which grew into the present State Forest Council. The Farm Club still keeps up its forestry work and will hold its 42d anniversary meeting and dinner on February 1st, 1908.

The Secretary of the Council is authorized to visit the county schools and talk to the children. The work is well done in Cumberland County, and a new generation is growing up who know of forestry and its value to human life. The aim is to have cards hung up in glass frames in every school in the State with short lessons on forest protection. Such cards are now posted in English, Jewish, and Italian, in all public places, so as to keep the subject continually before the pupils, and the results are already to be seen.

Pennsylvania National Forests According to the *Inquirer*, the Congressmen from Philadelphia will be strong in their support of the bill to create an Appalachian National Forest, at the present session of the National legislature. They will also urge in determined fashion the claims of Pennsylvania forests to be protected. Pennsylvania did not enter into Secretary Wilson's calculations, but Pennsylvania's Congressmen intend that the Keystone State shall be taken care of in whatever is done.

Do Not Stop with Appalachians The *Chicago Journal* would go much further than any one else has as yet proposed in the way of Government forests. It holds that not only the Appalachian ridges, and not only mountain lands of any sort, but all sorts of forest lands procurable, should become subject to the ownership of Uncle Sam. The language of the editorial referred to is as follows:

"Mr. Roosevelt recommends that the Government should acquire in the

Appalachian and White Mountain regions all the forest lands that are available. This is a wise suggestion. But it might be extended to include other forest lands in the West, which are just as necessary as those mentioned. The Government should become the owner of all forest lands that can be procured in the entire country, for the sake of preserving as much timber as possible for the use of our descendants.

"Congress should take this matter up at the earliest possible moment and appropriate whatever funds may be necessary to put the project into execution. Such action would be approved by every patriotic American."

Yale Forest School Notes The enrollment of the Yale Forest School this year is 61; of which 32 are in the Senior class, and 29 in the Junior class, besides 9 undergraduates in the Sheffield Scientific School of Yale who are beginning the regular forest school course. This is a slight increase over last year.

In the series of special lectures on lumbering in the Yale Forest School, made possible by the gift of the National Lumber Manufacturers' Association, there have been three lecturers this fall, each of which talked to the Senior class two or three times—Mr. J. P. Hughes, lumberman in the United States Forest Service; Mr. Robert H. Munson of Bay Mills, Mich.; and Mr. Robert C. Lippincott, a wholesale lumber merchant of Philadelphia.

Mr. Gifford Pinchot also spoke to the students of the Forest School on November 15th and 16th.

Yale Seniors to Alabama The senior class of the Yale Forest School this year, as in the past four years, will spend the spring term in practical field work on a large tract of forest land. The classes of 1904 and 1905 were at Milford, Pa., on the estate of Mr. James W. Pinchot; the class of 1906 was at Waterville, N. H., on the land of the International Paper

Company; and last year the seniors spent three months in camp in the Ozark Mountains near Grandin, Mo., on the Missouri Mining and Lumber Company tract. The forest map and estimates which the class of 1907 made for this company proved so valuable that this year several companies have applied to Professor Graves to have the senior class come and camp on their land. From among these offers the tract of the Kaul Lumber Company in Coosa County, Alabama, has been chosen as the location of the camp for the spring of 1906.

The region is midway between the coastal plains and the mountains, in a rolling country where the forests of longleaf pine and many other trees make a delightful field for forestry work. The students will live in a camp located at an elevation of about 800 feet above the sea, 20 miles from the town of Hollins, and near a spur of the logging railroad. The work will be similar to that done last spring, including the making of a topographic map of the whole tract, estimating and describing all the stands of timber, and preparing a working plan for the tract. There will also be abundant facilities for the study of land surveying, comparison of different methods of estimating standing timber, and detailed instruction in logging and construction of roads. Part of the term will be spent in the mill and lumber yards at Hollins, where the students will become familiar with sawmill operations, grading and handling lumber, and office management.

Miners and Trans-Mississippians At the American Mining Congress, held recently in Joplin, Mo., it was found that the members of the congress were unanimous in their support of the Federal administration's forest policy. A resolution was passed, commending the President's efforts in behalf of the wise disposition of the public lands in the interests of the actual home-seeker, and in the interests of the bona fide miner. The same

resolution further urged the Federal Congress to adopt such changes in the coal-land laws as would authorize the Government to hold and lease the mining rights separate and independent of the surface rights, the latter being sold or leased independently for homesteads or other agricultural or grazing purposes.

The Trans-Mississippi Congress, which was in session November 19th to 22d, inclusive, at Muskogee, I. Ter., passed resolutions similar to the above, and also resolutions commending the administration's forest policy, and urging the leasing of the grazing lands under Government supervision.

Arbor Day in Hawaii The Governor of Hawaii proclaimed the 15th of November as Arbor

Day for that island Territory. Trees are important to the life of the people there, as elsewhere, and since lumber is growing high-priced elsewhere, there is all the more reason why they should, as they can, supply their needs from home material. In fact, the islands are now exporting lumber in considerable quantities. The Honolulu *Commercial Advertiser* mentions some of the elements of commerce affected: "Leaving out the raising of tree fruits we already have companies incorporated with a large amount of capital to develop three distinctly new exports—namely, lumber, rubber and copra; all from different species of trees. There are millions for the future to be derived from the systematic forestation now being conducted. Arbor Day has a distinctive value also in the cause of city beautification. For a country where tree growth is so rapid as here, it ought to be the greatest day for public observance in the calendar.

Newspapers Raising Prices Elsewhere, editorial mention is made of newspapers raising prices.

Additional items come to the editorial desk. The Indianapolis *Morning Star*, the Terre Haute *Star*, and the Muncie *Star*, the three comprising the Star League, have raised their prices,

their manager declaring, "The best way we knew of meeting the increase in white paper by the press was to increase the price of the paper. * * * Publishers have got to do something, and I understand that they are raising prices all over the country."

Joliet daily newspapers have recently advanced their prices from five cents to ten cents per week. A Perth Amboy paper has increased its price, its manager stating that "the present cost in the production of a daily paper has doubled that of five years ago," and that "its only salvation was the increase in price." Its editor added, that "he did not believe that the reduction of the tariff on wood pulp would help, because he believed that as soon as it is done Canada will put an export duty on the product."

The Drainage of Southern Marshes The plan of the National Drainage Association to convert more than 65 million acres of Southern swamps into agricultural lands is part of the general project to conserve and develop the natural resources of the country with economy and foresight entirely unknown in the past.

Not long ago Mr. James J. Hill pointed out the distinction between our lasting and our transitory sources of prosperity. Mines are destined to be exhausted. Agriculture, grazing, and lumbering, on the other hand, are permanent industries. The prosperity which is based upon them is the only prosperity of which the future is assured. But farm crops, pasture, and forest products, though constantly renewed by nature, are threatened by excessive use—the hasty, shortsighted sort of use which is termed "exploitation," as distinguished from development.

President Roosevelt has clearly formulated the general public policy of conserving the natural resources of the country. Lasting general prosperity will depend in the long run upon putting to its best use every acre of farm, pasture, and forest land.

That the country realizes this, and has supported the Government in its provisions for the future of the people, shows conclusively that the old ways of haste and waste are fast being discarded.

The swamps of the United States, mainly in the South, cover an area as large as Illinois, Indiana and Ohio—a vast sheet of stagnant water and coarse rushes. All this land is now useless, or practically so. If drained, the soil is fabulously rich; and what now is waste, a home for mosquitoes, and a haunt for creeping things, may be changed into agricultural districts capable of supporting 16,000,000 people, with one family on each twenty acres. The engineering difficulties are not greater than others already mastered.

Practical and Useful Statesmanship The Buffalo *News* speaks admiringly of President Roosevelt's practical statesmanship:

"For the first time in the history of the United States a President represents the American idea of peace, industry and production in the fullest sense. While inferior to no predecessor in martial spirit, Mr. Roosevelt has the good fortune to be the greatest soldier of industry the world ever saw. Is the West for Roosevelt, because he has lived in the West, and wrote the story of its winning, and shares the superb Western spirit? Only in part is that the explanation. The watchwords of Roosevelt men in the West to-day are Irrigation and Forest Preservation. And both irrigation and forestry are business propositions of the first rank in the United States.

"At heart the South is for Roosevelt. Why? In addition to lesser things the South knows that he is the man who is making the dirt fly on the Isthmus as it never flew before and is thus opening the Pacific to the commercial conquest of the South. It followed his journey recently all the way down the Mississippi from Keo-

kuk to Vicksburg and learned that for the first time in our history a President had completely grasped all the immense significance of the internal waterways of the Union when they are developed as they should be, and set himself the mighty task of getting that project going actively while in office. That is another business proposition."

A Third Kind of Reclamation There is a form of reclamation that is not applied to new land, whether arid or swamp. Land which has been worn out by bad methods of cultivation and abandoned as useless can be reclaimed by the introduction of wise methods of cultivation. Large areas of land in the Southern States have been abandoned because they were cultivated so long in one crop, usually cotton, that they became unproductive. The Office of Farm Management of the Department of Agriculture is doing a most interesting and valuable work in teaching farmers, who have long been used to putting all their efforts into one crop, to diversify, and thereby get better returns and increase the fertility of their land. This increase in fertility is as good as a large increase in the amount of land available.

The annual report of the Board of Agriculture in Jamaica describes similar efforts in that island. Many farmers there have been induced to buy live stock in order to have the manure to apply to the soil. Live stock is generally an important element in the cropping plans recommended by the Office of Farm Management.

A Municipal Cement Plant A municipal cement plant of the capacity of 1,000 barrels per day is proposed for making the cement required for the construction of the Los Angeles aqueduct and accompanying works.

The plant will be located at Tehachapi, Cal., and so far as we know,

will be the first cement plant ever built by a city, and the second one built at public expense. The other publicly-owned plant is supplying cement for the great Roosevelt Dam, some miles from Phoenix, Ariz., and was built by the U. S. Reclamation Service.

Utilize Whatever Is Cut In Dr. Herman von Schrenk's address before the New England Railroad Club at Boston, he remarked that planting and the selective operation of forest tracts would naturally remain in the hands of a few people; but all are interested in the economical utilization of whatever wood is cut. There are two different phases of this; one is the use of each species of wood for the purposes to which it is best adapted, and the other is making a better adaptation of sizes of logs to the uses for which they are destined.

It is on just such elements of right use as this, no doubt, that Dr. Von Schrenk has been engaged to advise the Southern cypress manufacturers, as noted in our September issue.

Wish to Share Their Blessings Those on the ground know the value of the National Forest system. The citizens of Utah who are connected with the Manti Forest, knowing the benefits to their own region, are desirous that the same be extended to the people of the East, and have so expressed themselves in the following resolutions, adopted a short time since:

MANTI NATIONAL FOREST,
EPHRAIM, UTAH.

We, the officers of the Manti National Forest in Annual Officers' Meeting assembled, observe and resolve as follows:

Whereas, we have observed that an effort is being made to create a National Forest within the Appalachian and White Mountains; and

Whereas, from our experience and personal observation, we believe that

immeasurable benefits are derived from a or any National Forest, as administered by the Bureau of Forestry; and

Whereas, we are confident of the good that will be done not only to the people adjacent but to the people throughout the country at large by the creation of such Forests;

Therefore Be It Resolved, That we the officers of the Manti National Forest commend the efforts being made to accomplish this end, that we pledge ourselves individually and collectively to this effort, and that we will appeal to all people to employ every honorable measure to insure the creation of these Forests by the United States; and be it further

Resolved, That copies of this resolution be sent to the Hon. Forester, Gifford Pinchot, and to Senators Reed Smoot and George Sutherland, and to Congressman Joseph Howell, and Inspector R. E. Benedict.

A. W. JENSEN,
ERNEST WINKLER,
J. F. ANDERSON,
J. N. CHRISTIANSEN,
PARLEY CHRISTIANSEN,
J. W. HUMPHREY,
J. P. BROCKBANK,
B. E. MATTSSON,
D. H. WILLIAMS,
CHARLES THORPE.

Vermont Women Promote Trees At the annual meeting of the Vermont Federation of Women's Clubs held in Windsor, October 2d and 3d, very encouraging reports were made from the twenty-six federated clubs in the State.

In one town where a tree warden has been appointed, the Women's Club has been appointed a committee from its members to take note of the roads leading to the neighboring towns and report to the tree warden any needs which may come to their notice.

The club women are also studying the laws of Vermont, in regard to the care of its forests and the protection of

shade trees, and are encouraging the school children to become familiar with the names and characteristics of the trees in their own towns.

One club of only fifteen members has furnished material for a forestry column in its weekly local paper.

The letter addressed by Mrs. P. S. Peterson, chairman of forestry in the General Federation, to the club women, was given publication throughout the State, and practical work has been undertaken for the present year.

What Timber Land Sales Indicate The appreciation of timber properties in recent years, and perhaps more pronounced within the last two years, is strikingly illustrated, says the *Mantel, Tile and Grate Monthly*, by the transfers of large tracts which are detailed every month in the columns of the lumber trade press, and each succeeding year must witness a still greater value attached to our forests from a commercial viewpoint alone. The buying of timber to-day is largely for the sake of investment. The speculative feature is minimized in a measure by the absolute certainty that each year the property so held must increase in value.

Georgia Shows Live Interest The Georgia Forest Association met at Athens on October 25th. The meeting was small as regards numbers, but boundless as regards enthusiasm and determination to do something towards the perpetuation of Georgia's forests. Dr. H. C. White presided. After considerable discussion of plans the following officers for the coming year were elected: President, Judge E. H. Callaway, of Augusta; first vice-president, Mr. E. M. Mallette, of Thomasville; second vice president, Hon. James M. Smith, of Smithsonia; secretary, Alfred Akerman, of Athens; treasurer, Prof. Andrew H. Patterson, of Athens.

On November 8th the Georgia Fed-

eration of Women's Clubs, in a public meeting at Tifton, considered the forest problem. Mr. Enos A. Mills, of the United States Forest Service, addressed the meeting. Mr. Mills was introduced by Prof. Alfred Akerman, of the State University.

On November 29th the Atlanta section of the American Institute of Electrical engineers, in open meeting, discussed the relation of forest cover to water flow, as affecting electrical power plants. Mr. R. S. Kellogg of the Forest Service, Prof. Akerman, and Mr. Lee of Charlotte, N. C., addressed the meeting. Former Governor Pardee, of California, who happened to be visiting Atlanta, was present; and when called upon for a few remarks made a short but stirring talk.

Electrical Engineers Resolve Following a comprehensive preamble these resolutions were adopted:

Resolved, That it is the opinion of the Southern Section of the Institute of Electrical Engineers:

"That where forest reserves already exist, whether State or National, their area should not be reduced unless the land therein included is more valuable for agriculture than for forestry.

"That additional forest reserves should be promptly created on regions adapted by nature for the growth of hardwoods.

"That the headwaters of important streams should be protected by forest reserves; and

"That where, as in the case of New England and the southern Appalachians, the rivers are of an interstate character, it is most desirable that the Federal Government establish National Forests without delay; and be it further

Resolved, That the chairman and secretary of the Southern section be instructed to communicate these resolutions to all members of Congress

from the Southern States and to the Governors of the same States."

The *Daily Bulletin* of the *Manufacturers' Record*, of Baltimore, gives nearly two columns to the report of this meeting.

Another factor in the Appalachian campaign has appeared: it is the **The Appalachian National Forest Association** recently organized Appalachian National Forest Association. Its headquarters is 1331 Candler Building, Atlanta, Ga. Its president is Mr. Ligon Johnson, who represented the State of Georgia in the famous case against the Ducktown copper mine, in connection with which he made an extensive study of forest conditions.

The organization includes the following officers: President (as above), Secretary and Treasurer, John H. Finney, president of the local section of the American Institute of Electrical Engineers; Executive Committee, Dr. Roy Harris, Asst. Commissioner of Agriculture; R. F. Wright, State Geologist; W. S. Yeates, Capt. R. J. Lowry, Capt. J. W. English, J. H. McCord, Forrest Adair, R. F. Shedden, Albert Howell and J. Willie Pope. The Appalachian States are provided with vice presidents as follows: Georgia, Allen M. Schoen; Alabama, Robert J. Chambers; Tennessee, H. M. Suter; Kentucky, G. W. Hubley; West Virginia, W. T. Williamson; Virginia, Jos. Bryan; North Carolina, D. A. Tompkins; South Carolina, J. E. Serrine. Each of these vice presidents is expected to name a member of the general executive committee. Further, a local committee is expected to operate in each of the Appalachian States.

The object of the Appalachian National Forest Association is to conduct a vigorous campaign of education and publicity throughout the Appalachian States, with a view to securing the passage of the Appalachian bill. Leaders in every business and profession are reported as rallying to its

cause with an enthusiasm that ensures success. Its work is already calling forth a large degree of newspaper publicity in the form both of news "stories" and editorials. Several of the prominent papers in States adjoining Georgia have already promised their aid. President Johnson is confidently expecting the support of practically every influential paper in the South.

The American Forestry Association cordially welcomes this new organization to the field of Appalachian endeavor and trusts that it may prove a potent factor in still further developing and crystallizing the Appalachian sentiment of the South and thus of aiding in the passage of the Appalachian bill.

New Forest Legislation in Alabama That the people of Alabama are ready to take a decided step in advance so far as regards the creation of a proper forest policy, is shown by the provisions of a bill which was enacted by the Legislature at its recent special session.

When Governor Comer issued his call for an extra session, he inserted a clause which permitted the discussion and enactment of measures designed to protect the rapidly disappearing forest resources of the State. A committee was appointed to study the subject, and to suggest the provisions for the proposed bill. This committee requested the assistance of the Forest Service, and as a result of their deliberations a bill was put through which provides for the appointment of a non-partisan State Commission of Forestry, which shall oversee all forest matters of the State, and take all possible measures to promote a proper appreciation of the benefits to be derived from forest preservation. Provision is made for the future creation of State forest reserves. Forest plantations, under certain conditions, are to be exempted from taxation for a period of ten years. A fairly complete fire law is included in the bill, and the county game and fish wardens, and other

State and County officials, are declared Forest Wardens as well. The Governor, also, under certain conditions, has the power to appoint forest wardens, and provision is made for their remuneration. A small appropriation is made for carrying out the provisions of the bill, and a Forest Reserve Fund is created into which all fines, forfeitures, and penalties, arising from violations of the law, are to be paid. There are, in addition, several other provisions of less general interest. It is especially to be regretted that constitutional restrictions prevented the enactment of measures for the relief of the present heavy taxation on cut-over lands. This is one of the most serious problems which the proposed commission will be called upon to solve. Denuded land, however, which is properly cared for during a period of ten years, will be exempted from taxation.

The Commission will consist of the Governor; a member of the Tax Commission; the Game and Fish Commissioner; the Commissioner of Agriculture and Industries; a practical lumberman; a member of the U. S. Forest Service; and the Professor of Forestry in the Alabama Polytechnic Institute. This Commission is to elect one of its own number as secretary.

The bill is reported to have passed the House by a large majority, almost unanimously; and was then accepted by the Senate.

Ranger Meeting

A very interesting and successful Ranger Meeting was held at Roseburg, Oregon, from October 18 to 21, 1907. The supervisors and rangers from eight National Forests in southern Oregon were in attendance.

The following are some of the points upon which the meeting passed resolutions expressing their views: The co-operation with settlers in the building of telephone lines; timber sales; construction of fire lines; a filing system for rangers' use; the establishment

of game refuges within the National Forests; that it is not advisable for rangers to serve as State game wardens; that rangers should be supplied with U. S. Geological Survey quadrangles, where such are available; that the wives of supervisors, rangers and guards be invited to attend the annual ranger meetings; that the proper time for holding the examination for forest ranger is in the fall; the proper width for trails; the forest atlas; that more elementary books be supplied for the ranger library; that a working uniform be adopted, to be made on similar lines to the present one, but of khaki or some washable material, and not to cost over \$5.00; burning brush; grazing regulations; herders' identification cards; special uses, etc.

Mrs. Martin S. Durbin, wife of Ranger Durbin, of the Umpqua National Forest, was chairman of a committee on the preparation of plans for a ranger cabin. Hon. C. S. Jackson, member of the Oregon legislature, who was largely responsible for the passage of the Oregon fire law at the last session, was present at one of the meetings and gave a short talk. Mr. G. S. Marshall, of Weyerhaeuser Lumber Company, was present at a meeting and gave a short account of brush piling and burning as practised by his company.

Ontario's Monopoly of Spruce

The discovery that spruce is the best wood for conversion into pulp and paper has altered economically the whole situation. Henceforth the Canadian spruce will take rank with the Canadian white pine as one of the most valuable trees that nature has produced. Of spruce timber Ontario has now a larger supply than any other country, and if reckless vandalism continues to prevail elsewhere this Province may, under an enlightened policy, secure and retain a virtual monopoly. What this would mean in relation to the prosperity of the Province is easier to imagine than foretell. —*Toronto Globe.*

APPEALING TO THE SOUTH

IN THE Atlanta, Ga., *Constitution* for Sunday, December 1. Mr. Ligon Johnson, President of the Appalachian National Forest Association, devotes a half page with illustrations to a discussion of "the vast importance to the South of forest reserves." He states that the vast importance and imperative necessity of these forests are but dimly realized by people most directly concerned. He emphasizes the importance of the water question from the standpoint of power and floods, shows that preservation of the timber supply alone affords ample reason for establishing National Forests, and points to the successful work of Western National Forests under the administration of Forester Pinchot. He shows how foreign interests and corporations not identified or connected with the prosperity of the South are acquiring the timberlands and exploiting them, purely in the interest of dividends, points out that Appalachian land more appropriate for farms than for forests can still be privately owned and farmed, shows how, through lack of knowledge permitting forest destruction, conditions have been created in Northern Georgia whereby farm after farm has been left abandoned and as desolate as Goldsmith's "deserted village;" and how, through proper management, such conditions could be permanently prevented. He points to the multiplication of fields eroded by floods and calls attention to the change in climatic conditions following deforestation. He next shows that the alleged loss in taxation by the establishment of National Forests is imaginary, rather than real; that taxes from timberlands are ordinarily but temporary returns, the land being soon robbed, laid waste, and rendered valueless, and

the timber shipped away; whereas, under the National Forest plan, not only are local industries encouraged and taxable property retained, but 10 per cent of the gross receipts from the sales of timber and all other resources is paid to the counties in which the National Forests lie, affording an income which quickly overshadows the highest expectations under the most liberal tax returns. He shows that the Southern States have each and all approved the Appalachian forest plan, ceded the necessary lands to the United States, reserving only jurisdiction for their civil and criminal process, and pledged their aid and cooperation to every effort seeking the establishment of the National Forests. He closes with this pointed paragraph:

"The establishing of a National Forest, instead of taking the region and its products from the public, converts the territory into public domain of such a character that the surrounding States directly or indirectly reap every advantage. Timber suitable for lumbering is annually disposed of; where the land is fitted for pasturage, grazing permits are issued; if there be mineral wealth, the mines may be developed by any citizen; hotels, resorts, residences, stores, power plants and mills may be built; the streams may be fished, the lands hunted, and campers may take their holidays in the forest solitude at will. In short, a great national park, self-supporting, fostering home industries, preserving our highways of commerce, our water power and supply, the fertility of our soil, the salubriousness of our climate and the general welfare of our section and giving to our mountain counties a steady source of income, is the purpose of the proposed Appalachian National Forest."

REPORT OF SECRETARY OF AGRICULTURE ON THE APPALACHIAN WATERSHEDS

AS A result of one of the most extensive and thoroughgoing field investigations which the Government has ever conducted, Secretary of Agriculture Wilson, in his special report transmitted to Congress on December 11, recommends that the Government acquire an area not to exceed 600,000 acres in the White Mountains and areas aggregating not more than 5,000,000 acres in the Southern Appalachians for the establishment of National Forests. The average price to be paid per acre is put at \$6 for the White Mountains and at \$3.50 for the Southern Appalachians. The lands which it is recommended that the Government take over lie in the Blue Ridge and Great Smoky Mountains of North Carolina and Tennessee, South Carolina and Georgia, in the Allegheny Mountains of eastern and southern West Virginia and western Virginia, in the Cumberland Mountains of eastern Kentucky, Tennessee, and northern Alabama, and in the four main ranges of the White Mountains, mostly in New Hampshire. Immediate action is urged by the Secretary, since the natural resources of both regions are being seriously impaired by reckless lumbering and wasteful use.

Congress, at its last session, appropriated \$25,000 to make this investigation, and the Secretary of Agriculture, in order to present the most complete and conclusive report possible, saw to it that each of the several problems involved was handled by the most competent man whose services could be secured. The Forest Service detailed to the work several of its most experienced experts, the Bureau of Soils made a careful study of the soils and agricultural possibilities of the Southern Appalachian Region, the Geolog-

ical Survey gave the results of a seven years' investigation of water power and navigation in the Southern Appalachians, from Prof. L. C. Glenn of Vanderbilt University were secured the results of a three years' study of soil erosion, and from Mr. Philip W. Ayres a report on the commercial importance of the White Mountains. In charge of the work as a whole was Mr. William L. Hall, Assistant Forester in the Forest Service.

The report of the Secretary contains the first complete study of conditions in the Southern Appalachians and White Mountains, and gives some startling facts concerning the amount of water power available, the dependence of the Nation upon the Southern Appalachians for its future hardwood supply, and the enormous reduction in the value of the streams for water-power and navigation which would result from the removal of the forests from the mountains. The Secretary emphasizes the fact that the two regions under consideration are advancing rapidly toward a condition of barrenness and sterility. It is estimated that in the upland country south of Pennsylvania not less than 100 square miles of arable and forestable land are absolutely lost each year through the complete removal of the woods and the consequent washing of the soil.

That part of the report which deals with the production of timber brings out strikingly the fact that the Nation's future hardwood supply rests in the control of the Southern Appalachians. In the last seven years the hardwood lumber cut has fallen off over 15 per cent and this in the face of an unprecedented demand. During the same period the wholesale prices of hardwood lumber advanced from 25

to 65 per cent. A liberal estimate gives the remaining stand of hardwoods of the country at 400 billion feet, enough to last only sixteen years. The report then points out that it is the Appalachian region, where 75,000,000 acres are primarily adapted to the production of hardwood timber, to which the hardwood-using industries must look for future supplies. It shows also that under right management these 75,000,000 acres can produce each year three billion cubic feet of wood, about equal to the present consumption of hardwood timber for all purposes. If the Appalachians are taken soon enough, the Secretary points out, and are rightly handled, they can be made to produce continuously three-fourths of the hardwood supply of the country, and this without exhausting the forests, but, in fact, improving them.

Concerning water power, the report brings out some entirely new facts. Based on the lowest two weeks in the year, it states that under present conditions the streams of the Southern Appalachians afford a minimum of 2,740,000 horse power. Development of the storage facilities of streams would increase this from three to thirty times. At least fifty per cent of the minimum horse power is available for economic development. On this basis, the report says, the rental of 1,350,000 horse power at \$20 per annum is worth \$27,000,000 per year. In the same way, if there is added the possible revenue from the fifty per cent of power which is present for only half the year, the total is brought to \$38,000,000. After pointing out what a tremendous factor this vast water power is in the future industrial development of the United States and how much New England depends upon the power given by the streams which rise in the White Mountains, Secretary Wilson goes on to show what a vital relation the forest bears to successful utilization of water power and artificial storage. He shows that no matter what the purpose or design, any reservoir

system developed in the Southern Appalachians is foredoomed to failure unless the watersheds which feed it are kept under forest. If the forest is removed, vast accumulations of silt and gravel will be carried down to the reservoirs and render them worthless. Moreover, the floods in many of the streams are due to the extent to which the forest has been cut away or burnt, and if the reckless cutting and carelessness with regard to fire continues, most of the great water power now available will be lost.

The Appalachian Mountains are also important to navigation, since all the water gathered by them flows to the sea in navigable rivers. The forest is the one natural factor which tends to equalize the flow of streams, and with the forest supplemented by a system of reservoirs the depth of many streams could be materially increased. With thirty-five per cent of the Monongahela water subject to storage, the flood damage at Pittsburg and Wheeling would be almost eliminated. With the minimum stage of the Ohio at Wheeling increased by three feet, the coveted stage between Pittsburg and Cincinnati would all but be secured. As the report points out, however, this will never be accomplished unless steps are taken to preserve the forest cover of the watersheds and so prevent the filling up of both reservoirs and streams with sand and silt washed from the mountain sides.

The report shows graphically the condition of the two regions to-day, the slopes stripped of their forest cover, the resulting erosion of the soil, the danger to agricultural lands and waterways, and the total destruction of scenic beauty, a large asset in many sections. Although only a very small portion of the 75,000,000 acres of forest land is recommended for acquisition by the Government, the report suggests a plan whereby, with the aid of the several States and the co-operation of private owners, proper management of most of the forest land might be secured. The creation of

National Forests, as is pointed out, will not interfere with local industries, but rather it will aid them. Government protection of the forests would solve the fire problem of the region. It would not hinder mining and prospecting, and to farming and fruit growing it would give a material stimulus, since protection of the higher mountain slopes would greatly increase the safety of these industries in the valleys below. Nor would National Forests interfere in the slightest degree with settlers who own and cultivate small farms along the mountain streams, nor would it stop the use of the mountains for grazing. The many other uses of the mountains

would be furthered rather than hindered, and ten per cent of all revenues which the Government received from the Forests would be given to the counties in which the Forests are situated. The great industries, such as the furniture, cooperage, wagon, etc., which depend upon a supply of hardwoods, would be benefitted incalculably, and the vast capital which depends upon water power would be made secure.

Taken as a whole, the report marks a distinct step forward by outlining a definite program for preserving for continuous use one of the Nation's greatest resources.

THE HEART OF A TREE

By H. C. Bunner

What does he plant who plants a tree?
 He plants the friend of sun and sky;
 He plants the flag of breezes free;
 The shaft of beauty, towering high;
 He plants a home to heaven anigh
 For song and mother-croon of bird
 In hushed and happy twilight heard,
 The treble of heaven's harmony—
 These things he plants who plants a
 tree.

What does he plant who plants a tree?
 He plants cool shade and tender rain,
 And seed and bud of days to be,
 And years that fade and flush again;
 He plants the glory of the plain;
 He plants the forest's heritage;
 The harvest of a coming age;
 The joy that unborn eyes shall see—
 These things he plants who plants a
 tree.

What does he plant who plants a tree?
 He plants, in sap and leaf and wood,
 In love of home and loyalty
 And far-cast thought of civic good—
 His blessing on the neighborhood
 Who in the hollow of His hand
 Holds all the growth of all our land,
 A nation's growth from sea to sea
 Stirs in his heart who plants a tree.

SOUTHERN APPALACHIAN-WHITE MOUNTAIN FOREST BILL

FOLLOWING the special report of the Secretary of Agriculture on Southern Appalachian and White Mountain Watersheds, which went to Congress December 11, the bill for the purchase of National Forests in the two regions was introduced in the House of Representatives on December 19. Identical bills were introduced by Representatives Lever, of South Carolina, and Currier, of New Hampshire. Both were referred to the Committee on Agriculture, of which Representative Chas. F. Scott, of Kansas, is Chairman.

An effort is being made to secure a public hearing on these bills on December 30th, the day following the meeting of the American Forestry Association. The bill is modified considerably from the form in which it passed the Senate in the last Congress. In its present form it is simpler and much better. Before its introduction it was carefully criticized by representatives of the Society for the Protection of New Hampshire Forests, the Massachusetts Forestry Association, and the American Civic Association, as well as by members of the American Forestry Association and the Forest Service, and we understand that its present form is approved by all of these organizations. The text of the bill follows:

A BILL

For acquiring National Forests in the Southern Appalachian Mountains and White Mountains.

Be it enacted by the Senate and House of Representatives of the United States of America in Congress assembled. That the Secretary of Agriculture is hereby authorized and directed, in his discretion, to acquire for National Forest purposes by purchase or gift lands more valuable for the regulation of stream flow

than for other purposes and situated on the watersheds of navigable streams in the Southern Appalachian Mountains within the States of Maryland, Virginia, West Virginia, North Carolina, South Carolina, Georgia, Alabama, Kentucky, and Tennessee, and in the White Mountains within the States of New Hampshire and Maine. Such acquisition may in any case be conditioned upon the exception and reservation to the owner from whom title passes to the United States of the minerals and of the merchantable timber, or either or any part of them, within or upon such lands at the date of the conveyance, but in every such case such exception and reservation and the time within which such timber shall be removed and the rules and regulations under which the cutting and removal of such timber, and the mining and removal of such minerals shall be done, shall be expressed in the written instrument of conveyance, and thereafter the mining, cutting and removal of the minerals and timber so excepted and reserved shall be done only under and in obedience to the rules and regulations so expressed.

Sec. 2. That the Secretary of Agriculture shall advertise in the several States named in section one for lands to be acquired under the provisions hereof; and as between lands of equal value, the lowest bids shall be accepted: *Provided*, That the Secretary of Agriculture shall have the right to reject any or all bids.

Sec. 3. That no deed or other instrument of conveyance shall be accepted or approved by the Secretary of Agriculture under this act until the legislature of the State in which the land lies shall have consented to the acquisition of such land by the United States for National Forest purposes.

Sec. 4. That the Secretary of Agri-

culture may do all things necessary to secure the safe title in the United States to the lands to be acquired under this act; but no payment shall be made for any such land until the title shall be satisfactory to the Attorney-General and shall be vested in the United States.

Sec. 5. That the sum of five million dollars is hereby appropriated to carry out the provisions of this act, out of any moneys in the Treasury not otherwise appropriated, and said sum shall be available immediately and until expended for said purpose. *Provided*, that the Secretary of Agriculture shall each year make a detailed report to Congress on the lands acquired under this act and the cost thereof.

Sec. 6. That, whereas small areas of land chiefly valuable for agriculture may of necessity or by inadvertence be included in tracts acquired under this act, the Secretary of Agriculture may in his discretion and he is hereby authorized, upon application or otherwise, to examine and ascertain the location and extent of such areas as, in his opinion, may be occupied for agricultural purposes without injury to the forests and which are not needed for public purposes, and may list and describe the same by metes and bounds, or otherwise, and offer them for sale as homesteads, at their true value to be fixed by him, to actual settlers in tracts not exceeding eighty acres in area, under such joint rules and regulations as the Secretary of Agriculture and the Secretary of the Interior may prescribe. And no right, title, interest, or claim in or to any lands acquired under this act or the waters thereon, or the products, resources or use thereof after such lands shall have been so acquired, shall be initiated or perfected except as in this section provided. And the Secretary of Agriculture may, under rules and regulations to be prescribed by him, authorize the sale of any products of the lands acquired under this act and the use of any such land or the resources thereof

consistent with its reservation for forest purposes.

Sec. 7. That, subject to the provisions of the last preceding section the lands acquired under this act shall be permanently reserved, held and administered as National Forest lands under the provisions of Section 24 of the Act approved March 3, 1891 (Volume 26 Statutes at Large, page 1103), and acts supplemental to and amendatory thereof. And the Secretary of Agriculture may from time to time divide the lands acquired under this act into such specific National Forests and so designate the same, as he may deem best for administrative purposes.

Sec. 8. That the jurisdiction, both civil and criminal, over persons upon the lands acquired under this act, shall not be affected or changed by their permanent reservation and administration as National Forest lands, except so far as the punishment of offenses against the United States is concerned; the intent and meaning of this section being that the State wherein any such land is situated shall not, by reason of such reservation and administration, lose its jurisdiction, nor the inhabitants thereof their rights and privileges as citizens, or be absolved from their duties as citizens of the State.

Sec. 9. That ten per centum of all money received during any fiscal year from each National Forest into which the lands acquired under this act may from time to time be divided, shall be paid at the end of such year by the Secretary of the Treasury to the State in which such National Forest is situated, to be expended as the State legislature may prescribe for the benefit of the county or counties in which such National Forest is situated: *Provided*, that when any National Forest is in more than one State or county the distributive share to each from the proceeds of such Forest shall be proportional to its area therein: *Provided further*, that there shall not be paid to any State for any county an amount equal to more than 40 per centum of

the total income of such county from all other sources.

Sec. 10. That the Secretary of Agriculture may, for the further protection of the watersheds of said navigable streams, in his discretion, and he is hereby authorized, on such conditions as he deems wise, to stipulate and agree to administer and protect, for a definite term of years, any private forest lands situated upon any watershed whereon lands may be permanently reserved, held and administered as National Forest lands under the provisions of this act; but such stipulation or agreement shall provide that the owner of such private lands shall

cut and remove the timber thereon only under rules and regulations to be expressed in the stipulation or agreement, for the protection and conservation of the forest thereon; and such stipulation or agreement may in any case provide that the private lands so administered and protected shall during such term be subject to all the provisions of this act and of the laws, rules and regulations governing National Forests so far as the same may be applicable, and in that case the said private lands shall, during such term, be so subject to all such provisions, laws, rules and regulations.

THE WHITE MOUNTAINS

BY

T. L. Hoover, Brooklyn, N. Y.

Stern of visage, gaunt of form,
Monarchs grim in realm of storm—
All the fleet of nebulous boats;
Every craft-of-cloud that floats,
Heaped high with vaporous cargo,
Renders toll to your embargo.

Stern of visage, gaunt of form,
Spinners clad in cloaks of storm—
From your distaves wrapped with mist,
Tirelessly ye twine and twist,
Winding out in glistening skein,
Slender filaments of rain.

Stern of visage, gaunt of form,
Weavers on the looms of storm—
Dashing streamlets now ye braid,
From silvery strands so deftly made;
Binding all these fluid fibers
Into power-producing rivers.

Stern of visage, gaunt of form,
Wresting strength from out the storm;
Pouring wealth on plains below,
Where your cloud-wrought rivers flow,
Turning mill-wheels as they glide
To meet the ocean's brimming tide—

Pause ye not from toil, we pray,
Ere our race has lived its day!
Masters of the wind which rages,
Reign ye on through endless ages;
Enthroned eternal midst the storm,
Stern of visage, gaunt of form!

HOW NATIONAL FORESTS WOULD AFFECT THE PEOPLE

THE establishment of the proposed National Forests in the Southern Appalachians is intended like those in the Western States to be for the benefit of the people.

Since the Federal Government owns no land in the Eastern States which it can set aside for forests, as has been done in the West, it is proposed to purchase the land. The way it is intended to purchase is to buy rough land or cut-over land suitable only for forest purposes wherever it can be bought cheaply, giving due regard for difference in value of the soil and the amount of merchantable timber on the land. The bill it is proposed to ask Congress to pass for the establishment of the Forests provides for securing land by direct purchase from the owners. No person could be forced to give up either his land or his home, but should he wish to sell at a reasonable price, and should the land be forest land of the character desired by the Government, it would be bought for cash in the same manner as if by a lumber company. The object of the National Forests is to make homes more valuable, not to destroy them.

There are several very important motives for the establishment of these Forests, none of which will operate to the detriment of the people in the region where it is proposed to locate them; and most of which will be for their benefit.

In the first place it is intended to buy only the highest, steepest, and roughest of the mountain land which is not suitable for farming, and wherever there are small areas within the Forest which are suitable for farming they will be used for this purpose.

It is expected that retaining this mountain land in timber and reserving a deep leaf mold on it by preventing fires will lessen river floods which are becoming higher and more danger-

ous every year, damaging farm lands, buildings, and mills, and washing away roads and railroads. This regulation of the streams will add to the value of water power, and promote the building of factories which are so much needed in the mountains.

The timber in the forests will be so managed that the valuable trees like poplar and oak will not become exhausted, but that the supply of lumber for building purposes, and furniture factories, and of wood for paper-pulp, and tanning will be perpetuated. Local industries and local users of wood will be given preference in securing this timber over outside buyers. Good roads will be built into the forests to enable timber to be gotten out at all times, and these roads will always be open to the people. In the National Forests of the West cattle and sheep are grazed in the forests upon the payment of a small fee for each head, and the same would probably be done in the East.

A number of people would be employed in building roads, getting out timber, and protecting the forest, while in some places men would be employed to plant such trees as poplar and oak, which are becoming scarce.

Since the Government pays no taxes, a provision is made to reimburse the counties by giving them for school and road purposes ten per cent of the gross receipts from the sale of timber or other income of the forest.

The object is to create the forests for the benefit of all the people and not for the benefit of any one class. In compensation for this, the Government would probably wish the States in which the forests lie to assist in protecting them from fire, and to aid private timber-land owners who do not wish to sell to the Government in so managing their timber holdings as to secure the highest returns from them.

THE DOMINION OF THE LONE CONE

BY

Olive M. McKinley, Pueblo, Colorado

DOWN in the southwestern part of Colorado, with one foot firmly planted in San Miguel County and the other in Dolores, rearing his oft-times cloud-capped head 12,635 feet into the air, and trailing his ermine garments of snow far beyond his feet along the mesas that form his footstool, stands a beautiful, majestic mountain, fitly named, the Lone Cone.

If the aborigines, in the long-past golden age, did not crown and deify him, it was because their instinct for once failed to recognize a natural force which lavishly sustained them; for the Lone Cone gives in abundance of that most exquisite of treasures—pure, cold, snow-water—to all who will partake.

Be that as it may, the modern man, with his modern form of worship, has placed himself in harmony with the laws of this god of treasures. He has pleaded intelligently for a share of his blessing, and through it gained richly in material substances; so that where only thirty years ago the red man roamed through acres of sage brush, or lounged in groves of pinion, or hunted higher up among the spruce and quaking aspen, there now appear rich farm lands, set with beautiful homes; and thousands of head of cattle graze on the uplands.

The red man has gone. The wild creatures have shrunk deeper into forest fastnesses. The sawmill has appeared and, as a consequence, the attendants of this haughty monarch—the magnificent trees—are lying prone in the dust.

Very recently, the National Forest placed a restriction on the slaughter, but not until some of the finest specimens were gone. Now the ranchmen may not haul their annual supply of fuel without a permit.

The rural free delivery serves this community, which so short a time ago was one of remote pioneers. Only steam and electricity have delayed their coming.

From the lofty summit of this sovereign among mountains, the spectator may behold the kingdom over which he reigns, even to its boundaries, and the profiles of his neighbor kings, with a little of their kingdoms.

So far to the west that distance dissolves them into a seeming dream, lie the La Salles and Blue Mountains of Utah. Between them and the Cone stretches the beautiful hilly country known as Disappointment. To the south, may be seen the hills of New Mexico. Still south, but nearer and a little east, rises Dolores Mountain on the south side of the town of Rico. Yet nearer, more eastward, and north of Rico, Mt. Wilson rears his head. A trifle further east may be seen the very trails leading from Telluride to her mines. Still on, almost straight east, rises the snowy Sneffles Range, guarding the beautiful town of Ouray from view.

But away to the north, stretches the true "Lone Cone Country." By a strange telepathy, the mountain communicates his thoughts to the intruder, so that, for the moment, he entertains majestic notions. For miles and miles, the level mesas extend, cut here and there by a canon from five hundred to a thousand feet deep—only a trifle when the point of observation is nearly 13,000 feet high. Down yonder are two immense reservoirs, one covering 300 and the other 200 acres, approximately, each with an average depth of fifteen feet of water; tiny pools they seem, glistening in the sunlight, with the narrowest silver ribbon leading from them; yet they irrigate a hundred thousand acres of land below them.

But what, after all, is a thousand acres? The eye, sweeping across those level mesas, comprehends a million acres; and beholds just occasionally a bright green patch of alfalfa, or a golden yellow one of grain, carved out of the universal gray green of the sage-brush, or the black green of pinion trees.

How small, how slow, how insignificant, is human endeavor! As for man, there are to be seen, here and there,

west and always down, 3,000 feet, until it reaches the ground. He watches the electrical display—Nature's fireworks—and listens to the terrific cannonade of thunder, all below his feet. Yes, man is small indeed; simply one force in the Universal Grand Plan—is his lofty verdict.

But very soon his brain reels with the tremendous thoughts of the mountain, and he welcomes a descent into the world of man, and contemplation



Wright's Spring

tiny white dots to indicate his domicile; but he himself is too minute to catch the eye. Yet for so insignificant a creature the mountain gathers, from the mysterious ether above, a blessing that spells the difference between life and death.

The spectator, intoxicated by the rarefied air of such an altitude, forgets wee man for awhile, and stands wrapt in wonder at a sight below him; for a king not of earth has taken the stage of nature's endeavor before his eyes, and demands his marveling attention. It is the king of rain, stalking from the clouds below, east and

of the history of man's smaller achievements.

Descending to Wright's Mesa, which is typical of all the mesas, and better developed than the rest, he seeks to fathom the beginnings of things. Here runs an old Indian trail, well beaten in the last century between the Uncompahgre and Los Penos reservations; but also well beaten back into the vague mists of forgotten history. How many thousand red feet trod this crude highway; what thoughts of sweet romance or cruel war sped them on; what loves and hates, hopes and despairs, inspired

their masters, no one knows. There are no records to tell; only a few mute relics speak of their homes, hearth-stones, art, and weapons.

From a few scattering tepee poles, still lying across patches of unclaimed land, the imagination may reconstruct their wigwams, picturing them draped in blankets or skins. By digging a little beneath the surface, one may see the flat stones regularly placed, blackened and ready to crumble, which served them for fireplaces. A few

but most of them carried guns.

There are no traces of basketry or pottery to be found; there are no monuments, and almost no sign of any burials; so that the questioner is puzzled as to the disposal of their dead.

The early white settlers found a race-track near the spring, and it is known that they met here annually for their races and games.

These are the relics left to link us to that long ago. There are a thousand thousand days of deeds on which the



First Home on Wright's Mesa

beads woven into armlets or necklaces tell of their love of adornment. A knife of petrified wood, perfectly formed and highly polished, a single specimen of its kind, was found here. But this particular spot is richest in arrow- and spear-head of flint, quartz, or smoky topaz, which are wonders of beauty and symmetry. How were they made? Some say, by heating the stone and pouring water on it; others, by chipping with another stone. At any rate, they are very old, for the later Indians tipped their arrows with iron when they used them;

sun set in gorgeous or delicate grandeur as it sets nowhere else in the world; there are as many nights of repose on which the moon shed her weird radiance; sunk in the darkness of oblivion, with no known history on which to ponder, until the advent of the white man, as late as the 70's.

Then the intrepid cowboy began driving his herds in this direction. One named Wright settled at the mouth of a draw, close by a spring. His was not the pioneer soul, and he soon returned to more settled lands, not, however, without leaving his

name; and to-day, this favored spot is known as Wright's Draw, Wright's Spring, and Wright's Mesa.

In 1879, a young man, Edwin Joseph, in search of a place to establish a home, wintered here. In '81 he returned and preempted a ranch. Then he, alone, with the help of a faithful horse and a saddle-cinch, dragged the logs down the hill-side, and built the first cabin on the mesa. At great expense, he had a door packed over the mountain trails from Telluride. Before it could be hung in the precious home, it was destroyed by vandals dur-

land. Between '80 and '90 the cattle could be numbered by hundreds of thousands. They were owned by half a dozen companies and a few individuals. A hundred cowboys continually rode the range. In '87, seventy cowboys assembled at one round-up. At that time, with such a force of men, the round-up usually occupied a month, averaging over a thousand head of cattle a day.

But in time the cowboy relinquished some of his picturesqueness and barbarity. He sold some of his cattle, took a wife and a quarter section of



Captain of the round-up

ing a temporary absence. Not until '82 could a second door be procured, and the house completed. Observing the incident from his point of view, the trite old saying, "Such is life in the wild and woolly West," comes to have a deeper significance. This pioneer is simply a type of about a score of men who began life in this place, whose fortunes, all good, have varied only in individuality.

In the decade following the settling of this home, the cowboy, brave in chapereros, six-shooter, high-heeled boots, and sombrero, placed his stamp on this

land, and settled down to responsibility. By '90 the choicest bits of land were taken, and each section contained about four small, dirt-roofed cabins, indicating the foundation of a home. To-day, there are yet cattle and cowboys: but the cattle are fewer, and the cowboys more prosaic. He has lost his chaps and six-shooter, the heels on his boots are not so high, and even his sombrero wears a more neutral tint.

Late in the fall of '88, a young cowboy, Guy Hurlburt, returning to the mesa from Boulder County, found himself stalled in Montrose, with sev-

enty miles of his journey unaccomplished. He carried a bundle of silver-leaved poplars to adorn the new home he had just secured, where large hopes were already planted. Buoyed by eagerness, he decided he could walk. The road lay over a mountain top, down through the San Miguel Valley, across the river, and up the hill to the mesa. The snow came and blinded him. He lost his way and nearly froze, yet he never faltered nor dropped his burden. In the end, he reached the waiting welcome. The trees were duly set out, and grew. This is only an in-

are vigorous vitality, and the means of its sustenance.

The first crop was planted in '88. It was oats, forty acres of them, and they yielded eight hundred bushels, which was threshed with flails. This was followed by alfalfa, which is still the main crop, though timothy is being introduced now. Then came other grains, and they thrive in abundance. Potatoes also form a great crop, rivaling in excellence the output at Greeley. Experiments in fruit have begun. Strawberries, gooseberries, raspberries, and currants are raised in quantities. Sev-



A typical round-up dinner

cident in pioneering; but to-day a number of fine, tall trees, their silver leaves whispering hopeful secrets in the air, on his own and neighbors' ranches, stand as monuments to the influence of endurance.

The resources of this, as of many another spot in Colorado, have been barely touched. It is not the lure of gold that attracts. The products, though more commonplace, are more substantial. The toiler, instead of delving deep, digs on the surface, under the gold of sunshine; and his returns

eral orchards have already yielded a harvest of the finest of apples. Some of the ranchmen just now are beginning to realize the possibilities in raising honey.

The most up-to-date machinery is to be found on nearly every ranch: the manure-spreader, disk-harrow, mower, reaper, binder, and thresher, the latest cream separator, and even washing-machine, are all here.

In 1886 the first schoolhouse was built, though not used for that purpose till the following year. In 1888

the post-office was established and named Norwood. The first reservoir was constructed in 1889.

In 1891 a spinster school-ma'am, like the one in "The Virginian," rode up into this broad and breezy country. It rained as she came. The landscape looked gray, and so did the cabins. The mud was very deep, and the people seemed to have been wading in it. Out of the loneliness of her heart, she wrote back to Denver: "I have passed the portal of oblivion, and entered the land of nowhere."

In 1901 she came again. Rain, as ever, greeted her ascent of the hill; and the picture in her mind was of a gray tone. But she had not reckoned on the magic of industry. Dirt-roofed cabins had disappeared. In their places rose handsome, commodious houses. Field after field was fenced, sagebrush was replaced by alfalfa, and

groves of transplanted trees surrounded the homes.

If she comes again in 1911, she will doubtless ride up the hill in a trolley car. Electric lights will twinkle in a fair-sized, prosperous town, and telephones will connect all the ranches.

Should she climb The Cone, she will see more of those seemingly tiny pools of water; for a third reservoir is already begun; and a fourth, the largest of all, is under survey.

The cattle will be fewer, but without horns and of finer blood. The cowboy's manner and dress will have become cosmopolitan.

But the beautiful Lone Cone, like the Blue Alsatian Mountains of long ago, will continue to look down with a serene, steadfast gaze, smiling to think of the futility of these efforts of man, should he only withhold his single but omnipotent gift.

THE OREGON SIERRA

Sierra Madre, mother peaks,
That keep companion with the sun!
Sierra de Nevada, streaks
Of snow and sun inwound as one—
Ye be but babes! Behold, behold
My peaks of snow and sun and gold
That gild the crimson, cobalt dawn;
That ward the em'rald Oregon;
That lift to God, in changeless white
Above the bastion walls of night—
Inspiring more to look upon
That golden dolphins of Nippon.

What shapely pyramids of snow,
Set here, set there, set anywhere;
White as white flocks that feed below;
As if old Egypt planted there
And left proud pyramids to grow,
Ten million tall and multiplied
Until they pushed the stars aside!
And yet, what man hath seen or said
In song or tale, how grandly fair
This nameless glory overhead;
This unnamed New Jerusalem
White as God's trailing garment's hem?

The pioneer, content to teach
Christ's holy lessons and to rest,
To preach content and ever preach
That rest, sweet rest, in reckoned best—
This buckskin prophet drove the plow;
For he was worn, as worn with years.
Two thousand miles of thirst and tears,
Two thousand miles of bated breath,
Two thousand miles of dust and death,
When lo, yon gleaming hemisphere!
But now the world shall know, yea now
His son's face lifteth from the plow!
—Joaquin Miller.

LUMBERMEN'S VIEWS ON REFORESTATION

BY

C. H. Goetz, Forester for H. M. Cloud & Sons Lumber Co., Au Sable, Michigan

IT is all a mistaken idea that lumbermen are simply looking towards deforesting the land, or that they simply buy land for the timber there is on it.

While I admit that there is one now and then, who looks only to the present

money getting, yet the majority of them look ahead far enough to get a continuous supply of timber; and I am sure if the States and our National Government would give some encouragement to these lumbermen in the way of relief from taxation of de-



White pine timber on the Chippewa Indian Reservation, in Minnesota, four miles east of the village of Cass Lake

forested land, 90 per cent of the lumbermen and lumber companies would reforest their land and would be glad to do so.

But who can blame the lumbermen and lumber companies of to-day for not reforesting their cut over land? The lumberman is first and last a business man, who looks towards a legitimate return for capital invested. It does not take him long to figure out

a small increase of land tax is causing such a quick deforestation as to influence the market price of all lumber. This, as can be plainly seen, will continue until all timber is cut. Then the price of timber will naturally jump up to prohibitive prices.

The land if not fit for agriculture will return to the State for taxes and the State will have to nearly double the taxes on land remaining, having



Virgin forest of white and Norway pine adjoining the Michigan State Forest Reserve

that under the present system of taxation of land, he could never hold the reforested land until the crops were half ripe. He can clearly see that the taxes would eat up his land capital and all invested in them.

At the present I know of several States like the State of Maine in which

killed the goose that laid the golden eggs.

Take the State of Michigan to-day. Where have the millions of dollars gone that have been made from lumber from the once beautiful white and red pine forest? Have they remained in the State? I dare say not one-half



A Michigan white pine forest in winter

of it has remained. And again, where are the companies and the men that once operated the mills in Michigan? Gone they are to new fields to conquer; gone are they, and their wealth with them. To-day many of them who still lumber the hardwoods remaining, speak of going to Washington and British Columbia, where virgin forests still stand. If they go, their wealth goes with them.

What would have induced the others to stay? What would cause those here to remain? A different law as to taxing forest land and forest products. If we could only learn from European states, things would be different.

I have always contended and still stand for a tax on logs, or cut timber only, those being the product of the soil—accumulated through generations, and in this respect different from all other products of the soil. No land producing forests or planted to forests should ever come into the schedule of agricultural land.

The tax on logs or forest products should be a State tax and used as

such. The forests of a State or States should be looked upon as a blessing to the whole community, and its destruction as a curse to all. Why then have a tax as at present, that drives men to cutting all the forest they own as quickly as possible in order to escape the ruinous taxation?

What use to talk to a lumber man or lumber company about reforestation, about starting nurseries, or employing a competent forester to look after the land? What use have they for a working plan for selection cutting? Do you wonder that to-day they make a clean cut and then go to new fields? It is just because they are driven to it.

Time and time again I have heard it said that the present laws of taxation are what have destroyed our forests so quickly, and that the only party to look to for reforestation is the Government, which is exempt from taxation.

These are the views of a lumberman on the question of reforestation and taxation of forest land.

THE MONARCH OF THE WOODS

Behold the monarch of the woods!
 The mighty old oak tree;
 He braves the raging of the storm,
 On land or rolling sea;
 He waves his branches decked with green
 In summer's golden glow,
 And ivy clothes his leafless form
 Through winter's frost and snow.
 King Time, the conqueror of all,
 He boldly does defy:
 For green and hearty will he stand
 When ages have gone by.

How oft the monarch of the woods,
 Upon a summer's day,
 Has seen the merry children sport,
 And 'neath his shadows play:
 From youth to manhood they spring up,
 And old age comes at last—
 Then green grass waves upon their
 graves,
 And all life's dreams are past.
 Yet stronger grows the mighty oak
 In hale and hearty prime,
 And stands the monarch of the woods,
 Defying age and time.

—Anonymous.

ILLUSTRATED HANDBOOK OF AMERICAN TREES

HANDBOOK of the Trees of the Northern United States and Canada East of the Rocky Mountains, by Romeyn Beck Hough. Published at Lowville, N. Y., by the author, 1907.

The American forester cannot complain of a dearth of popular books on forestry and forest trees. He could even occasionally wish that the number might be smaller, and the contents better, with greater claim of originality, if not of facts, at least of form. Popular books, as a rule, are not expected to contribute to the actual wealth of knowledge; but by spreading the already acquired knowledge among the masses, they prepare the ground for the assimilation of new ideas, and thus make scientific progress easy. It is a mistaken notion that popular or elementary books can be written by persons who have themselves acquired a merely elementary knowledge of things. The best popularizers of science are those who know most. The well known English physicist, Tyndall, was the most famous popularizer of physics; and so in their respective lines were Huxley, Haeckel, and a score of other scientists.

Mr. Hough's book is unquestionably a popular book in the sense that the facts about our forest trees are presented in a simple, plain, comprehensive manner—so comprehensive, in fact, that one can dispense almost entirely with the text, and merely by studying the photographs form a very clear idea of the characteristic features of each species. It is really an herbarium, composed not of dried specimens, but of photographs which show the essential organs of the trees in their most natural condition. This book, therefore is really a tool, a ready means for comparing the characteristics of the different species without re-

sorting to herbarium collections, which are not always available, and which always consume a great deal of time.

The book covers only the trees of the Northern and Eastern United States; to each species is devoted two pages—one consists of a full-page plate showing the buds, leaves, and fruit; and the other contains in part text, and in part photographs of the bark and of the anatomic structure of the wood, together with a map showing in shaded lines the distribution of the species. The leaves and the fruits of the trees are shown on a background marked into squares, each side of which is one inch. Such a background enables one to determine at a glance the relative size of the different organs of the tree, and there is no need of lengthy and tedious descriptions of the size of the buds, cones, etc.; facts which merely tax the memory without leaving a vivid picture of the proportion of the organs. The photographs and the maps really tell everything one would like to know about the tree, and there is very little room left for description. This graphic representation of the facts by means of photographs leaves a more lasting impression than the most accurate word description could do.

The reproduction of the parts of trees are not imitations of nature, but Nature herself looks out from each page of the book, so true are the photographs and so clearly do they show the characteristic features of each species. The photographs are taken from the trees in the forest, and any one who has ever attempted to secure good reproductions of forest trees will appreciate the amount of labor, patience, and skill that were required to bring together such an enormous number of most excellent photographs, not only of the trunks, but what is far more

important, of the leaves, fruit, and buds.

Mr. Hough vividly tells in the pre-

face to the book about the vicissitudes and ordeals through which he passed in procuring specimens from lofty

GREEN ASH.

Fraxinus lanceolata Borek.¹



Fig. 469. Branchlet with mature leaves and fruit, 1; branchlet in winter, 2.
470. Trunk of isolated tree. Meramec River valley, Mo.

The Black Ash is distinctly a northern species, and in forests, under most favorable conditions, attains the height of 80-90 ft., with straight columnar trunk 3-4 ft. in diameter. When isolated it develops a rounded ovoid top, which may be recognized when leafless by its stout straight branchlets (those of the staminate tree being larger than of the pistillate) and the gray scaly bark of trunk.

It inhabits the low banks of streams and cold swamps, in company with the Arbor-Vita, Balsam, Tamarack, Silver Maple, Black Spruce, etc., sometimes forming a considerable portion of forest tracts.

Its wood is rather heavy, a cubic foot when dry weighing 28.37 lbs., moderately hard and strong, and is valued in the manufacture of furniture and lumber for interior finishing, for barrel hoops, etc. It is extensively used in the manufacture of splints for baskets, owing to the facility with which it splits between the layers of annual growth. The "Ash Burl" veneering is a product of this tree, being sliced from the "knots" or burls which form on its trunk and larger branches. Their cause or origin is not well understood.²

Leaves 10-16 in. long, with 7-11 oblong to oblong-lanceolate sessile leaflets, the terminal one petiolulate, rounded or emcate and unequal at base, long-acuminate at apex, sharply serrate, tomentose at first but at maturity glabrous dark green above, somewhat paler and glabrous with rufous hairs along the midrib beneath. *Flowers* polygamo-dioecious, calyx none; petals none; stamens 2 sometimes rudimentary in the pistillate flowers. *Fruit* samara, linear-oblong, 1-1½ in. long, ½ in. broad, winged all around and with flattened faintly-veined body and thin wing emarginate at apex.³

1. Syn. *Fraxinus sambucifolia* Lam.
2. A. W., III, 62.
3. For genus see pp. 454-455.

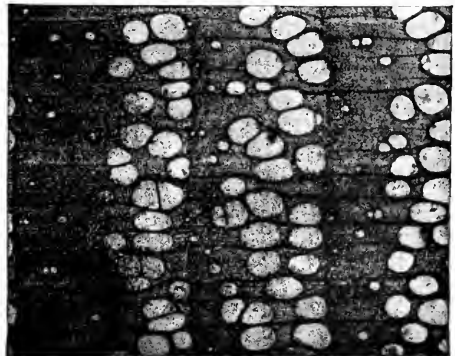

One page from the Handbook of American Trees—The tree represented here is Black Ash

tree tops, and in hunting several seasons for male or female flowers of some of the species which do not bear fruit every year. We do not know of any book, Sargent's *Silva* not excepted, which contains such a wealth of good and true reproductions of trees, as Mr. Hough's book does. It is not

only a popular book which affords the easiest and most pleasant way of getting acquainted with our forest trees, but is at the same time a necessary tool, which takes the place of an herbarium, for all who have to refer constantly to the different species of trees.

THE CITY ON THE PLAIN

BY

Millard F. Hudson, Washington, D. C.

Strange, indeed, were the sounds I heard
 One day, on the side of the mountain;
 Hushed was the stream and silent the
 bird,
 The restless wind seemed to hold its
 breath,
 And all things there were as still as death
 Save the hoarse-voiced god of the
 mountain.

Through the tangled growth, with a hurried
 stride,
 I saw him pass on the mountain,
 Thrusting the briars and bushes aside,
 Crackling the sticks and spurning the
 stones,
 And talking in loud and angry tones
 On the side of the ancient mountain.

The tips of his goat-like ears were red,
 Though the day was cool on the
 mountain,
 And they lay close drawn to his horned
 head;
 His bushy brows o'er his small eyes
 curled,
 And he stamped his hoofs—for all the
 world
 Like Pan in a rage on the mountain.

"Where are my beautiful trees," he cried,
 "That grew on the side of the moun-
 tain?
 The stately pines which were once my
 pride,
 My shadowy, droop-limbed junipers;
 And my dewy, softly whispering firs,
 'Mid their emerald glooms on the
 mountain?"

"They all are ravished away," he said,
 "And torn from the arms of the
 mountain,
 Away from the haunts of cooling shade,
 From the cloisters green which flourish-
 ed here—
 My lodging for many a joyous year
 On the side of the pleasant mountain.

"The song-bird is bereft of its nest,
 And voiceless now is the mountain.
 My murmurous bees once took their rest,
 At shut of day, and knew no fear,
 In the trees whose trunks lie rotting here
 On the side of the ruined mountain.

"Man has let in the passionate sun
 To suck the life-blood of the mountain,
 And drink up its fountains one by one;
 And out of immortal freshness made
 A thing of barter, and sold in trade
 The sons of the mother-mountain.

"Down in the valley I see a town,
 Built of his spoils from my mountain—
 A jewel torn from a monarch's crown,
 A grave for the lordly groves of Pan;
 And for this, on the head of vandal man,
 I hurl a curse from the mountain:

"His palpitant streams shall all go dry
 Henceforth, on the side of the moun-
 tain,
 And his verdant plains as a desert lie
 Till he plants again the forest fold
 And restores to me my kingdom old,
 As in former days on the mountain."

Long shall the spirit of silence brood
 On the side of the wasted mountain,
 E'er out of the sylvan solitude,
 To lift the curse from off the plain,
 The crystal streams pour forth again
 From the gladdened heart of the
 mountain.

SECRETARY WILL'S LECTURE TOURS

ON DECEMBER 4th, Secretary Will returned from his lecture tours in the South and West. In the South he spoke at the following points on the dates named:

Raleigh, N. C., September 26; Durham, N. C., 27; Winston-Salem, N. C., 28; Charlotte, N. C., October 1; Spartanburg, S. C., 3; Savannah, Ga., 4; Columbia, S. C., 8; Greenville, S. C., 9; Charleston, S. C., 11; Augusta, Ga., 15; Columbus, Ga., 17; Montgomery, Ala., 18, and Asheville, N. C., 21.

The second trip covered middle Western and neighboring States. It included Philadelphia, November 1; Madison, Wis., November 5 and 6; La Crosse, 6; Wausau, 7; Grand Rapids, 9; Eau Claire, 12; Milwaukee, 13; Alma, Mich., 15; Muskegon, 18; Grand Rapids, 19; Ypsilanti, 20; Ann Arbor, 20; Jackson, 21; Detroit, 22; Toledo, Ohio, 23; Kalamazoo, Mich., 25; East Lansing, 26; Bay City, 27; Paducah, Ky., 29; Columbus, Ohio, December 2, and Parkersburg, W. Va., 3.

The majority of these meetings were held under the auspices of boards of trade, chambers of commerce, and similar bodies. Some were arranged by women's clubs, while still others occurred in colleges, normal schools, and universities. The average attendance was about three hundred. Some of the best meetings contained audiences of from seven hundred to a thousand.

At almost every meeting strong resolutions were adopted endorsing the National Forest policy and urging the enactment of the Appalachian-

White Mountain bill. In numerous instances earnest speeches were made from the floor in the offering and seconding of these resolutions. In not a single instance was there a "no" vote.

The attitude of the newspapers was stimulating. Practically without exception they gave freely of their space to announce meetings in advance and to report them afterwards. Column reports in both morning and evening papers were common; while the reports at times covered about two columns. Again and again, representatives of the press assured the Secretary of their readiness and eagerness to aid, in every practical way, in promoting the work. In numerous instances, the Secretary was entertained at the homes of citizens interested in the cause. To some extent, the meetings showed the lack, by some, of clear knowledge of the meaning of the forestry movement. The almost complete absence of opposition, in both South and West, was very encouraging; and much more so was the deep and substantial interest of many, including the strongest people in almost every community, who had informed themselves on the subject.

In addition to the educational work done in the campaign, the trip was valuable in affording opportunity to the Secretary to make many helpful acquaintances, to observe forest conditions, waterways, power-plants, saw-mills, paper mills, and various industries. It has carried the knowledge of the Association, its work and cause into regions where these were unknown. Seed, it is believed, has been sown which will bear fruit.



THE CANALS: A GLORY OF FRANCE*

BY

J. J. Jusserand, French Ambassador at Washington

SOME nineteen hundred years ago, a small town existed in a small island of a little known river. The town being surrounded by water, its principal corporation was that of the boatmen; they had placed themselves under the protection of Jupiter and dedicated an altar to him. The altar still exists; it was discovered in the eighteenth century under the choir of Notre Dame; for the little town I speak of was soon to outgrow its island and was to become Paris, the capital of France; and now, I venture to say, a "city of renown."

After a good many centuries, when the fashion came for armorial bearings and emblems, Paris, continuing the same traditions, chose for emblem a ship, with the famous motto, "*Fluctuat nec mergitur.*" Tempests may toss but shall never sink her; which has proven true, throughout ages, of the ship, of the town, and of the country too. What tempests, what hard days, what dangers! And yet the ship is afloat; very much so.

In these facts can be detected, as it were, an omen of what was to follow. The patient, hard-working, careful French people, believed by some to spend all their time in reading novels, singing songs and amusing themselves, could not fail to do for waterways what they did for roadways, and so it is that the development given by them to their inland harbors and canals has secured for me the honor of addressing this brilliant assembly of conscientious, painstaking and patriotic Americans. And I owe it also, perhaps, to the remembrance that the biggest canal in the world, one dreamt of by Greek, Roman and Moslem, one which Marlowe's Tamburlaine, dying, regretted not to have opened, the Suez Canal, was planned by a Frenchman, executed by Frenchmen, and built in ten years, from 1859 to 1869. At the entrance of

it stands a characteristic statue of that model of energy, Lesseps, who points to the canal and seems to say: "The canal an impossibility? Be so good as to look: there it is!"

We hold the record for the present; you will hold it in your turn when the great Panama Canal is finished; we turned the first sod; you will turn the last; and no one will applaud more heartily than your predecessors.

Apart from these great attempts benefiting mankind at large rather than any single country, France has done good work indeed on her own soil. From the Renaissance, when the use of locks was first invented, the great plan was started which was to connect, through mountains and valleys, all the rivers of France and all the oceans and seas washing her shores. First it was the canal of Briare, connecting the Seine and the Loire, begun by Henry the Fourth's great minister, Sully, in 1605; then it was the great canal of Languedoc, connecting the Atlantic Ocean and the Mediterranean, built in eighteen years by Riquet, under Louis the Fourteenth, and one of the glories of the reign. It long remained a model one, and caused the admiration of travelers. Visiting France more than a century later, Arthur Young, the famous English economist, wrote: "The canal of Languedoc is the capital feature of all the country. * * * It is a noble and stupendous work; goes through the hill about the breadth of three toises (19.18 ft.) * * * Nine sluice-gates let the water down the hill to join the river at Beziers. A noble work! * * * Many vessels were at the quay, some in motion, and every sign of animated business. This is the best sight I have seen in France. Here, Louis XIV, thou art truly great! Here with a generous and benignant hand thou dispensest ease and wealth to thy people." And as Young was writing

*Address before the National Rivers and Harbors Congress, at Washington, D. C., December 4, 1907.

on French soil, two years before the French Revolution, you will not wonder that he adds the following expression of his sentiments: "Such an employment of the revenues of a great kingdom is the only laudable way of a monarch's acquiring immortality." This in any case may be noted by you all who are interested in waterways: you see from this trustworthy authority that canal-digging is the best way to immortality.

When the Revolution came we had about 1,000 kilometers of canals. Napoleon had great plans for this as for everything else, but they were not fulfilled, the reason being that, as you know, he had so many things to do. He built only 200 kilometers. Since then there have been two palmy periods for canals in France, first during the Restoration and the reign of Louis-Phillippe, and then the present time. The canals learnt in the interval what a crisis was. The Second Empire was the period when an immense impetus was given to railroad building. Canals and railroads do not like each other; their manners are too different. People who go quickly have a tendency to scorn people who go slowly; and yet both kinds are useful, and we know besides, by the fable of the hare and the tortoise, that it is sometimes the fastest who arrives last. Anyhow, the craze for railroads rose so high at one time that there were petitions for the drying out of a canal, in order to use its bed as a railroad track; but the canal survived and is still in use.

The greatest era of canal building in France has been the present period. One of the first things the present Republic did was to turn her attention to the problem; and the system now in force, started in 1874, was fully organized by the great law of 1879. The aim has been a thoroughly practical and logical one: to complete, to unify, to cheapen. Most of the older canals had been built by contractors who recouped themselves by levying a tax on shipping. All those conces-

sions have been purchased back by the State and now, on the immense majority of our waterways, there are no payments. Some new creations, which were considered urgent, have been made of late years by the State with the help of the chambers of commerce, the towns and the departments who wanted them. These had to issue loans, and they levy taxes to be able to pay the interests; but this is merely a temporary shift bearing on one-eighteenth only of the whole, and the rule is to have throughout the country free canals as we have free roads.

Another great work done by the Republic has been the unifying of all the waterways: depth, breadth of the canals, distance between the locks, have been made uniform throughout the country, so that our thirty or forty canals, built at different periods, in the course of centuries, are now as one single canal conveying goods to all parts of France and to all her principal seaports.

Owing to the recent great effort made by the Republic, our canals' total length is now 4,675 kilometers; the total expense has been about two billion francs, and far from considering that it is too much we know quite well that it is not enough, and we add new sums from time to time. Many improvements were decided upon in 1903 and our parliament voted over two hundred million francs to provide for them. To which sums should be added others supplied by local municipalities or other bodies, the Douai Chamber of Commerce, for example, contributing thirty million francs above what the State is giving for the Canal du Nord.

Our canals are under State supervision; they are built and kept up by State engineers, taught in our special high schools, and forming part of the personnel of the Ministry of Public Works.

The happy effect of the laws voted since the establishment of the Republic was not long in making itself felt; during the twenty-five years between

1875 and 1900 the traffic on canals increased 112 per cent; it amounts now to over thirty million tons, being so active in certain inland towns that Paris, for example, has a larger navigation than any of our seaports, Marseilles included. The "nautae Parisiaci" of Gallo-Roman times may look with satisfaction upon their descendants. In the regions producing in greater quantities the sort of goods fit for canal transportation (coal, grain, stone, mineral products, etc.), that is, the northeast of France, existing canals, although constantly improved and increased in number, are still inadequate, for traffic increases even more. You would often find in those parts the water covered as far as the eye can see with flat-bottomed boats of three hundred tons (the normal dimension) loaded with goods to the brim. The sums spent have been large, to be sure, but we consider them well spent, and the investment a good investment.

That investment is valuable because of what it yields, of what it helps, and also of what it prevents. The best thing it prevents is the railroads raising their tariffs too high. As soon as the railroad companies raise their tariff, quantities of goods find that they can very well afford to travel at a slower pace and take the water route. Our canals act, in a way, as a kind of rate bill, a self-regulating one.

Another great question with which we have had to cope is that of rivers. We have a number in France; but mostly shallow and irregular. We have done much to improve their course, and have yet much to do; plans are being laid for ample improvements. Here a consideration comes in of paramount interest for you, as for every country—the question of forests.

It is an absolute principle: no forests, no waterways. Without forests regulating the distribution of waters, rainfalls are at once hurried to the sea; hurried sometimes, alas! across country. After having devastated the

neighboring fields, the rivers find themselves again with little water and much sand; and with such rivers, how will you fill your canals in all seasons? Since our forests suffered damages which we are now bent upon repairing at considerable pains and cost, a river like the Loire has been entirely transformed; it used to be the best of our waterways, and it is now the river whose inundations are most destructive. I do not know what damage those of the present year have done, but in 1856 the loss amounted to forty-six million francs. The question is as plain as can be: do you want to have navigable rivers, or do you prefer to have torrents that will destroy your crops and never bear a boat? If you prefer the first, then mind your forests. We can tell you, for we know.

In the time of Louis XIV that same river Loire was the principal means of communication between the center and the west, and even between Paris and Brittany. To go to Brittany the famous Marquise de Sevigne went to Orleans, put her coach on a flat-bottomed boat, navigated twelve or thirteen hours a day, had her food cooked on a little stove in the boat, she herself remaining in the coach; she never tired of admiring the landscape, listening to the birds, laughing at untoward incidents, writing to her daughter, and reading a work she had taken with her to enliven the journey; not a naughty novel, nor one of those heroic romances she was fond of, but a history of the events in Portugal, in two large octavo volumes.

Such pleasant journeys are no longer possible on that same river; but the former state of things is going to be re-established and we hope even improved upon. Special studies have been made and, for the Loire in particular, the researches of M. Bureau have shown beyond doubt what parts of the country should be reforested to make that river again navigable to the same extent as before. Those parts are being reforested, and we shall have once more a navigable Loire from

Roanne to the sea. The personnel who have the care of canals have also the supervision of rivers, and the number of navigable kilometers increases from year to year; it has now reached eight thousand.

Thus are we working in order to turn to the best possible use the natural resources of our country, those resources which the rashness of isolated individuals would often destroy, if Parliament did not interfere in the interest of the many. As the meeting of this very congress shows, you are bent on doing the same, on a scale proportionate to the immensity of your territory and of your resources. The importance of the general plan which

will coordinate the efforts made throughout the country, so that the result will be a harmonious whole and that prosperity reaches every part of this land, is proportionately great. The principles which govern the question are happily familiar to you, and you well know that if the Mississippi is the "father of waters," the forest is the father of the Mississippi. We watch with friendly interest what you are doing in this line, and we are confident that your ship of state will ride the waves as ours has done for so many centuries, a ship that may know storms, but shall never founder. "*Fluctuat nec mergitur.*"

IN THE HEART OF THE WOODS

Such beautiful things in the heart of the
woods!

Flowers and ferns and the soft green
moss;

Such love of the birds in the solitudes,
Where the swift winds glance and the
tree tops toss;

Spaces of silence swept with song,
Which nobody hears but the God
above;

Spaces where myriad creatures throng,
Sunning themselves in his guarding
love.

Such safety and peace in the heart of the
woods,

Far from the city's dust and din,
Where passion nor hate nor man in-
trudes,

Nor fashion nor folly has entered in.
Deeper than hunter's trail hath gone
Glimmers the tarn where the wild
deer drink;

And fearless and free comes the gentle
fawn,
To peep at herself o'er the grassy
brink.

Such pledges of love in the heart of the
woods!

For the Maker of all things keeps the
feast,

And over the tiny flowers broods
With care that for ages has never
ceased.

If he cares for this, will he not for thee—
Thee, wherever thou art to-day?

Child of an infinite Father, see;
And safe in such gentlest keeping stay.

—Margaret E. Sangster.

THE NATIONAL RIVERS AND HARBORS CONGRESS

Washington, D. C., December 3, 4 and 5, 1907

BY

Mrs. Lydia Adams-Williams, of Women's National Press Association, and International League of Press Clubs

Special Report for FORESTRY AND IRRIGATION

THE large ball room of the New Willard Hotel, all in white and gold, with the National emblem in evidence, was the scene of a brilliant and representative gathering of the foremost and most substantial men of the Nation, when the important Rivers and Harbors Congress held its sessions there on December 3, 4, and 5, 1907.

Cabinet members and other representatives of the great Government departments, foreign Ambassadors, United States Senators and Congressmen, the Governors of many States and other notables of State and National distinction, and representatives of the most important financial and commercial industries from every part of the Union, with a sprinkling of earnest and interested women, combined to make a gathering, the personnel of which is seldom, if ever, equalled.

In attendance there were, not counting many spectators, 2,000 delegates from 463 cities and towns in 43 States. These were appointed by 23 governors, 51 mayors and 183 waterway and commercial organizations.

Congressman Joseph E. Ransdell, of Louisiana, President of the Rivers and Harbors Congress—he whose untiring energy and unswerving devotion to the one fixed policy of “fifty millions annually for river and harbor improvements.” bid fair to be

crowned with success—called the meeting to order and presided in an able and impartial manner over its deliberations.

The Congress was opened with a prayer by Rev. Earl Cranston, of Washington, D. C., bishop of the M. E. Church.

The able Secretary of State, Elihu Root, was the first and principal speaker, of the opening session. After commending the efficient work of Chairman Burton, of the Rivers and Harbors Committee, and referring to the Panama and Erie canals, Secretary Root said: “We have reached the bridge. It is now a question of whether we shall have our products carried or not.

“There is no greater achievement than the transportation of articles from one point where they are valueless to another where they are valuable. The railroads of the country no longer are able, physically, to carry the traffic of America, and the one avenue open to such traffic is water transportation. We must move forward or we will go backward. I see American production handicapped by two things: first, the cost of getting the goods to the seaboard, and, second, the absence of an American merchant marine.”

The Ambassador from France, M. Jusserand, delivered an entertaining and characteristic address.*

*NOTE.—Found elsewhere in this issue.—Ed.

Senator F. G. Newlands delivered a strong address and advocated especially unionization or nationalization in the development of all natural resources. He said the people form public opinion; Congress records public opinion. We must, therefore, educate the people. Senator Newlands explained the provisions of his bill before Congress, which provides for the expenditure of fifty million dollars annually for the next ten years for the improvement of the country's waterways.

J. C. Welliver, of Iowa, a bright newspaper correspondent, who investigated the waterways of Europe for the Government, gave an interesting comparison of European railways and waterways.

Albert Bettinger, of Cincinnati, emphasized the necessity of a five hundred million dollar bond issue.

The Governor of West Virginia, W. M. O. Dawson, said that we should improve our rivers and harbors, so as to be ready for the Panama Canal when it is ready for us.

A notable ovation was given the United States Forester, Mr. Gifford Pinchot, who delighted and interested the large audience with a masterly exposition of not only the need of utilizing the waters and forests, and the public lands for homes, but of conserving all the country's natural resources for the benefit of the public. He said that the range had been depleted and the coal wasted, and that a timber famine was now at hand. Heretofore, each individual interest had been working and fighting alone; these interests had not yet stood together. They all should now unite in the conservation of the whole; they should all move forward together. "Nothing can stop our progress," said Mr. Pinchot, "if we all unite. The future of our country lies in our hands now; shall we hand on our prosperity or discount it and use it now?"

Chairman of the Interstate Com-

merce Commission Martin A. Knapp spoke of the enormous increase in freight traffic and said that the United States must improve the inland water transportation if we wish to compete with the other nations of the world in foreign commerce.

Ex-Governor Dr. Geo. C. Pardee of California who, with Mrs. Pardee and a delegation of thirty-three Californians, came 3,000 miles to attend the Congress, spoke very entertainingly of the necessity of preserving the forests. He said we should preserve the rivers and harbors where they begin—in the mountains of the country.

The improvement of the waterways by an expenditure of five hundred million dollars, paid in sums of fifty million dollars every year, was further advocated by Governor Glenn of North Carolina, who also depreciated the spending of "millions for battleships that can't enter our harbors."

Dr. N. G. Blalock of the State of Washington, a prominent figure at all irrigation and similar congresses, spoke interestingly of the Columbia River and what its development means to the people of his enterprising State.

Continued cheers greeted Congressman Theodore E. Burton, chairman of the Rivers and Harbors Committee, when he arose to address the Congress. He spoke of the inadequacy of railway transportation, and said: "I can stand by your platform of \$50,000,000 a year."

Mrs. Lydia Adams-Williams also addressed the Congress and emphasized the statements, previously made, that the forest is the father of the river, and that without forests there would be no rivers.

The interest of the convention was centered in the address by James J. Hill, the railroad magnate and wizard of transportation. Mr. Hill spoke of the necessity of deepening the lower Mississippi from St. Louis to the Gulf to a depth of eighteen to twenty

feet. He said that it would take 75,000 miles of new trackage, costing, with terminals, \$5,500,000,000, to accommodate existing traffic.

Governor Johnson of Minnesota, mentioned as a possible Democratic candidate for the Presidency, spoke of the Mississippi valley as one of the biggest and most powerful facts of God's footstool; he gave many figures to support his contention that relief from the present railway freight congestion can be obtained only by improving and utilizing the waterways of the country.

Many other notable people gave excellent and highly appreciated addresses before the Congress, among them, John Barrett, Director of the Bureau of American Republics; John M. Stahl, former president of the Farmers' National Congress; Cyrus P. Walbridge of St. Louis; Gustav Schwab of New York; Congressman J. Hampton Moore; and President Finley of the Southern Railway; Governor Cummins of Iowa; Governor Comer of Alabama; Governor Hoke Smith of Georgia; Lieutenant-Governor Davidson of Texas; Leroy Percy of Mississippi; and Lloyd E. Chamberlain of Boston, president of the Massachusetts State Board of Trade.

Notable addresses were also made by Special Director John A. Fox, who visited twenty-six States and ninety-nine cities and who was cheered as the "Arkansas traveler;" and Col. J. F. Ellison, secretary of the Congress, who gave a very encouraging summary of the work done; President Joseph E. Ransdell gave his report and an address outlining the principal objects of the convention.

Others who favored the Congress with excellent addresses were John M. Parker of New Orleans; Henry M. Beardsly, mayor of Kansas City; and Capt. Alex McDougall, for forty years a captain of the Great Lakes, and who

has seen the traffic on those inland seas grow from practically nothing to the enormous total of twelve million net tons, as reported in the government figures for October of this year. Also George Clinton of Buffalo, a grandson of DeWitt Clinton, who said that the Japanese are reaching out to get the trade of South America; also Chas. Emory Smith of Philadelphia, and Arthur Knox of New York City; and Governor Vardaman of Mississippi.

Two very interesting and much appreciated stereopticon and moving picture lectures were delivered, one by Thos. S. Anderson of Boston, on Europe's Great Seaports; and one by O. P. Austin of the Department of Commerce and Labor, showing old ways and new ways of travel, in a trip around the world.

The resolutions as presented by Congressman J. Hampton Moore, pledge the Congress to the adoption of a policy calling for a five hundred million dollar bond issue for river and harbor improvement; they conclude with a resolution presented by Hon. Joseph N. Teal of Oregon, conveying approbation and commendation for the loyal and unfaltering devotion to the cause of waterway improvement by the president, Hon. Joseph E. Ransdell; by the secretary-treasurer, Capt. J. F. Ellison, and by the special director, John A. Fox, all of whom were unanimously re-elected to their respective offices.

The deliberations of the Congress were accorded a successful and brilliant conclusion by a reception tendered the delegates by President Roosevelt and by the presentation of the resolutions to Vice President Fairbanks and Speaker Cannon, all of whom made notable addresses expressing their appreciation of the work done by the Congress, and offering every encouragement for the future progress of the work.

UNITED STATES FOREST SERVICE



The Month in Government Forest Work.

Cleaning Out the Springs In its investigations for the improvement of grazing lands within the National Forests carried on during the past year, the Forest Service has found that the ranges on some of the forests can not be fully utilized by stock because of a lack of a proper water supply. Plans have been made for bettering these conditions.

Work to improve the water supply will be started this year in two forests, and before the coming of another grazing season a number of ranges will be improved very materially.

In the Leadville National Forest, in Colorado, the men in charge will clean out and protect twelve different springs and pipe the water into troughs. The work on the Tumacacori National Forest, in Arizona, will be somewhat more extensive, although only half as many springs will be affected as in the Leadville Forest. This method of cleaning out and protecting springs and other watering places will result in much benefit to stockmen grazing on the strips of ranges within the forests. Improvement work along the same general lines will also be begun on other National Forests.

Utilization of Tan Bark Oak For many years the tan bark oak in California (*Quercus densiflora*, Hook.) has been exploited in a very wasteful manner. The lumbermen have gone into the forests, cut down the trees, stripped them of their bark, and after cutting up a small per cent of the body of the tree for cordwood, have left the remainder to rot or to

be burned up in the redwood logging operations which follow.

The wood of tanbark oak has heretofore been regarded as unsuitable for anything but fuel, but this prejudice has been mainly due to the difficulty of seasoning it. The Forest Service, in cooperation with the Northwestern Redwood Company, are studying on this problem. If it is found that seasoning can be done as well with trees cut in the spring as in the fall, this will be preferable, because it is easier to peel the bark from trees cut in the spring.

Other experiments will be made in the way of flexure, end compression, side compression and sheer tests on small specimens. Strength determinations will also be made on larger pieces suitable for wagon stock, coo- perage, etc.

The tan bark oak grows in the California Coast Range from the Santa Cruz Mountains north into Southern Oregon. The tree is tall and often spreading. Its average diameter is about twenty-four inches.

Despite the inroads of the tan bark industry on the stand, there is estimated to be about 1,000,000,000 feet yet uncut. To utilize the tree for lumber would result in the annual saving of many thousands of dollars.

A City Forest, Griffith Park The city of Los Angeles is planting a forest which should be self-supporting and profitable, on a three-thousand acre tract of waste land, known as Griffith Park. The Forest Service has, at the request of the city, made planting plans.

Laboratory of Wood Chemistry The laboratories of the Office of Wood Chemistry have heretofore been located at Boston and New Haven. They are now being consolidated in Washington, quarters having been found at 1530 Pennsylvania Avenue Southeast. The one hitherto at Boston has dealt with paper pulp questions largely; and the one at New Haven with wood distillation.

Nevada and Utah The President has just signed proclamations creating the new Vegas National Forest in Nevada, and making an addition to the Aquarius National Forest in Utah.

The Vegas National Forest includes the area known locally as the Sheep Mountains and is situated in southwestern Lincoln County, Nevada, and has an area of approximately 195,840 acres. Nevada will now have eight National Forests, with an aggregate area of 2,528,479 acres. The State's timber resources are light and the creation of this forest will help materially to insure a permanent timber supply. The creation was requested in petitions and letters sent to the Forest Service by Nevada citizens.

Commercial species of trees in the forest include yellow pine, juniper, mountain mahogany, and pinion. The best of the yellow pine averages about 5,000 feet per acre. Under administration the land will be protected from forest fires, theft and wasteful exploitation. The new forest will be in charge of Harry E. Matthews, who is also Acting Supervisor of the Charleston Forest, with headquarters at Las Vegas. So far as is possible Nevada men will be chosen to assist him.

The land added to the Aquarius Forest, in south central Utah, is known as the Table Cliffs addition, and is located in the southwestern part of Garfield County. This territory is a portion of the rim of Salt Lake basin, separating the drainage of the Colorado River from that which flows

northerly into the Great Basin. The commercial forest consists of pure yellow pine at the lower elevations, while higher up is found this species mixed with Engelmann spruce, Alpine fir, foxtail pine and limber pines.

Part of the land in the addition is covered with forest growth of a non-commercial type, which is chiefly valuable for conserving the flow of streams used for irrigation of the fertile lands along the Sevier Valley. The village of Escalante receives one-third of its water for municipal purposes from this area. It is estimated that 400 acres of land in Upper Potato Valley and 600 acres around Escalante are irrigated by water from the Table Cliffs country. The Aquarius Forist is in charge of Supervisor Geo. H. Barney, with headquarters at Escalante.

Farthest East National Forest President Roosevelt has just signed a proclamation creating a National Forest in the west central part of the State of Arkansas. This timbered area, which covers more than 1,000,000 acres, will have the distinction of being the farthest east of all of the Government forests. This new forest, which will be called the Arkansas, brings the total area of the National Forests up to 161,233,985 acres, a little more than one-fifth of the country's total forested area.

The Arkansas National Forest is located in the counties of Scott, Polk, Montgomery, Yell, Logan, Perry, Salline, and Garland. The most valuable stands of timber in the forest are made up of short leaf pine, red, white and post oak, and a little black walnut and cherry. The commercial timber varies from 1,000 to 15,000 feet an acre. A conservative estimate places the commercial timber in the forest at one billion board feet, but it is thought probable that the actual amount will overrun this estimate by several hundred million feet.

Samuel J. Record, formerly of the Office of Forest Management in the

Forest Service, will be the supervisor in charge of the new forest; he has left Washington for Fort Smith, where he will establish headquarters. Mr. Record is a trained forester, and has practical knowledge of the forest conditions in the West by reason of four years' field work in the Ozark region of Missouri, in Montana, Michigan, several States of the middle West, and finally in Arkansas, where he made a working plan in 1906, for 70,000 acres of pine forest, and later made examination of the land and recommendation for the withdrawal of the area now included in the new Arkansas forest.

Arkansas Forest Resources Arkansas has always been rich in forest resources. Originally the entire State was clothed with forests with the exception of about 900 square miles. The entire area of the State is 53,850 square miles. Fully 80 per cent of its area remains in woodland, of which two-thirds are commercial forest. This places Arkansas among the most heavily timbered States, and makes it the center of unusual activity in the lumber business.

The total amount of standing timber in the State is approximately 100 billion feet, of which pine comprises 20 billion. The total cut for the year 1906 was nearly 2 billion feet, the largest in the history of the State. At this rate fifty years will be required to cut off all the timber, assuming that the factor of growth will be offset by deterioration and waste. In all probability the rate of cutting will increase so materially that the available supply will be largely exhausted in less than twenty years. If present methods are continued, most of this forest land will become barren and unproductive; if properly managed, it will play an important part in the future prosperity of the State.

A particularly favorable fact in con-

nection with the Arkansas National Forest is found in the hearty spirit of co-operation manifested by the Arkansas people, who apparently recognizing the immense benefits which are to be conferred in the conservation of the timber supplies there, have accepted the incoming of the Forest Service as a salutary event and assisted the Government officials with helpful suggestions.

Mississippi Valley Conditions Fires are very common throughout the region in which the Arkansas Forest is located. The forest will be put under administration at once, and with a competent ranger force and proper co-operation on the part of the settlers living within the boundaries of the forest, the fires can be soon be brought under control. In the West, where practically all of the National Forests are located, it has been shown that fire can be reduced to a point where the loss is utterly insignificant, through the system of patrol which is an important part of the forest administration.

The creation of the Arkansas National Forest has brought a relatively small area of the immense forest area of the Mississippi Valley under practical forest administration. As an object-lesson as to what can be done in the way of conservative lumbering, the forest will be of great interest to lumbermen in the Mississippi Valley, and it is hoped that the large areas in private hands will be managed on strict forestry principles when the practical results of government administration of this forest are seen.

The recent additions in California, Arizona, Nevada, and Arkansas bring the total area of the National Forests of the country, including Alaska and Porto Rico, up to about 161,000,000 acres. The Alaska forests are over 12,000,000, and the one in Porto Rico about 66,000.





UNITED STATES RECLAMATION SERVICE



Government Irrigation Work During the Month.

Round-Up of the Year's Work

A summation of the work of the Reclamation Service for 1907 shows that it has dug 1,815 miles of canals, or nearly the distance from Washington, D. C. to Idaho. Some of these canals carry whole rivers, like the Truckee River in Nevada and the North Platte in Wyoming. The tunnels excavated are 56 in number, and have an aggregate length of 103 1/4 miles. The Service has erected 214 large structures, including the great dams in Nevada and the Minidoka dam in Idaho, 80 feet high and 650 feet long. It has completed 670 headworks, flumes, etc.

It has built 611 miles of wagon road in mountainous country and into heretofore inaccessible regions. It has erected and has in operation 830 miles of telephones. Its own cement mill has manufactured 80,000 barrels of cement, and the purchased amount is 403,000 barrels. Its own saw mills have cut 3,036,000 feet B. M. of lumber, and 23,685,000 feet have been purchased. The surveying parties of the Service have completed topographic surveys covering 10,970 square miles, an area greater than the combined areas of Massachusetts and Rhode Island. The transit lines had a length of 18,900 linear miles, while the level lines run amount to 24,218 miles, or nearly sufficient to go around the earth.

The diamond drillings for dam sites and canals amount to 66,749 feet, or more than twelve miles. To-day the Service owns and has at work 1,500 horses and mules. It operates 9 locomotives, 611 cars and 23 miles of rail-

road, 84 gasoline engines and 70 steam engines. It has constructed and is operating five electric light plants. There have been excavated 33,419,222 cubic yards of earth and 4,745,000 cubic yards of rock. The equipment now operated by the Service on force account work represents an investment of a million dollars.

This work has been carried on with the following force: Classified and registered service, including Washington office, 1,126; laborers employed directly by the Government, 4,448; laborers employed by contractors, 10,789, total of all forces, 16,363. The expenditures now total nearly \$1,000,000 per month. As a result of the operations of the Reclamation Service eight new towns have been established, 100 miles of branch railroads have been constructed, and 14,000 people have taken up their residence in the desert.

Truckee-Carson Project Complete

Amongst the points of information given out by the Reclamation Service for the benefit of home-seekers are the following facts:

The Truckee-Carson project is now practically completed. Four million dollars have been spent in the construction of dams, ditches and drains and over 100,000 acres of land are now open to settlement. Some of the ditches have been operated for two years. During the season of 1906, 21,000 acres were cultivated, and during 1907 practically 25,000 acres were cultivated. There are now about one thousand farms awaiting settlement.

The project is located in Western Nevada, in what is known as the Carson Sink Valley. This valley is the bed of an ancient lake long since dried up, and the soils are composed of the sediments deposited in this lake and are rich in all the elements of plant food. The valley is surrounded by mountains; those on the east, north and south are barren desert hills with but few trees except the hardy pinion pine of the desert ranges. On the west, mountain range after mountain range is piled up, culminating in the snow-clad peaks of the Sierra Nevada on the California border line.

A River Shifted

The average elevation of the valley is about four thousand feet above sea-level; or two hundred feet lower than Salt Lake City; twelve hundred feet lower than Denver. The valley is barren of all tree growth except a few cottonwoods along the streams, and greasewood, sagebrush, rabbit-brush and other desert vegetation upon the plains outside of the river bottoms. The Carson River enters the valley from the west, flows through the entire length of the basin and deposits its waters in Carson Sink; which, by the way, is not a sink as generally known, but is a large bare mud flat which becomes a lake in spring during the floods, but which during the late summer and fall months is a shining alkali flat, devoid of all life. The water escapes only by evaporation.

The Truckee River, fed by the eternal snows of the Sierra Nevada and regulated in its flow by beautiful mountain lakes, such as Tahoe, Donner, Independence and others, does not enter the Carson Sink Valley; but after leaving the mountains at Wadsworth, turns north and flows into Pyramid and Winnemucca lakes, and is there lost by evaporation. The Government has, however, dug a large ditch to convey the Truckee River water over into the Carson River, and irrigate the fertile lands in the Carson Sink Valley. Through this ditch we

have the full benefit of the waters of the Truckee River, thus uniting the two streams for the benefit of the lands around Fallon.

Another Irrigated Garden Land

The valley is a desert; it needs but water and settlers to make it a veritable paradise. It has all of the potential resources of such a country as that which now surrounds North Yakima, Wash., Boise, Idaho, or Greeley, Colo., and the same class of energetic citizens as have made those districts so beautiful, will, in the course of time, make the country around Fallon as famous and as fertile as any irrigated district in the West. To the men from the humid countries, the Nevada landscape seems at first barren, cheerless and even forbidding; but to the man who can enjoy sunshine, and who has sufficient imagination and acquaintance with desert countries, the landscape is full of hope and promise; it needs but the intelligent work of the farmer to make it beautiful and productive.

Railroads

The main trans-continental line of the Southern Pacific Railroad passes along the northern border of the valley, but it is not possible to see many of the irrigable lands from this railroad. At Hazen two branches leave the main line, one going seventeen miles in a southeasterly direction to Fallon; the other running south to Goldfield, Tonopah and the great mining districts of Southern Nevada. These two lines of railroad give communication with the outside world, afford a means of distributing products to the mining market, and, as the country builds up it is likely that further extensions of these branches will be made so that farmers in outlying districts will have railroad facilities.

Towns: Fallon

Fallon is the county seat of Churchill County, has a resident population of about one thousand people, is the

largest town in the valley, and is growing rapidly. It has many beautiful homes, is favorably located, and some of the streets are well shaded and beautiful, for trees were planted in this district thirty years ago. It does a very extensive business among the mining camps in the neighboring mountains, and is practically the distributing point for territory within a radius of fifty miles. In 1902 Fallon had a population of 1,000, and has more than doubled its numbers within the last year. It promises to be a town of 3,000 people within another year, and eventually should have five to ten thousand inhabitants. There are openings for many lines of business in Fallon, and he who enters the town now will find every opportunity to build up a good business. It is the geographical center of the irrigable lands of the Truckee-Carson project and can never have a competitor as a distributing point.

Hazen and Stillwater

Hazen, the junction point of the Southern Pacific, is a town of possibly 300 inhabitants, and is destined to become an important railroad center and the local distributing point for 25,000 acres of irrigable land. Hazen has a hotel, stores, etc., and offers an excellent opening for small business ventures.

Stillwater is a small town fourteen miles northeast of Fallon and was settled in the early days when travel through Nevada was going on over the old overland trail. Stillwater has a population of perhaps fifty, but is so favorably situated that it undoubtedly will become an important agricultural distribution point, and will be the town from which miners in the mountains near by will secure their supplies.

Postoffices are conveniently located at other points in the valley. The agricultural possibilities of the valley will

be considered in next month's issue of FORESTRY AND IRRIGATION.

What Reclamation Does for the Indians

Not the least interesting of the projects planned by the Reclamation Service are those which relate to the irrigation of the Indian reservations of the West. For the present fiscal year there is available for this purpose an appropriation of \$1,200,000. The plan under which Secretary Garfield and Indian Commissioner Leupp are proceeding is to make the Indians economically independent. Small farms outside the reservations will be given to individual Indians who are sufficiently capable to look out for themselves. The majority, however, will continue to live on the reservations, where in the past agriculture has been hampered or made impossible by lack of water. Now it is the intention that the water rights of the Indians shall be protected, and canal systems are to be constructed for the proper irrigation of their allotments.

The labor on the big dam across the Zuni River in New Mexico has been done chiefly by the Navajo, Zuni, and Pueblo tribes. These Indians have been taught to work with derricks and hoisting engines, and to operate steam drills and perform concrete mixing and trench excavation. They have done this work, of course, under the supervision of a competent engineer and assisted by a sprinkling of skilled white labor.

It is hardly to be supposed that all of the Indians can be prevented from alienating their lands when they are officially allotted to them in severalty; but enough has been accomplished in educating them to independence to make it reasonably certain that a large number will become industrious and contented tillers of the soil.





RECENT PUBLICATIONS



Pennsylvania Department of Forestry, Biennial Report. Lack of space prevented the notice which should have been given earlier of the Report of the Pennsylvania Department of Forestry for 1905-1906, which appeared a few weeks ago. The Commissioner of Forestry, Robert S. Conklin, is also president of the State Forest Reservation Commission.

The report is a comprehensive summary of the work in preserving and developing the forests of the State and the care of the vast areas of woodlands now under its charge.

The Forestry Commission now holds 701,297 acres of forest land in twenty-three counties of the State. At the time of the filing of the report, there was under contract to be purchased an additional area of 100,000 acres. The price paid is about \$2.50 per acre.

As these lands are purchased from all who care to sell at the price offered, they are located in many parts of the State.

The various details of the management of the forest areas are interesting and instructive to private owners of forest lands. The result of the Commission's experiments in reforestation is clearly set forth and must be of great value to the owners of timber lands.

The Old Mountain Pines. The beautiful poem under this title in our November issue, by Andrew Sherwood, of Portland, Oregon, was intended by the author to appear with a dedication to one of his friends who doubtless shares his feeling toward the pine trees. Both Mr. Sherwood and Mr. Elliott are members of the American Forestry Association. The poem is dedicated as follows:

"To my friend, Hon. S. B. Elliott, Reynoldsville, Pennsylvania; member of the Pennsylvania State Forest Reservation Commission, and author of "The Timber Trees of Our Country."

American Industries for November 15th has an illustrated article describing the Cape Cod canal, now under construction by public-spirited citizens, and to form part of the seacoast canal line between Massachusetts and North Carolina.

A Successful Southern Hay Farm.

The monthly publication list of the Department of Agriculture for November (issued December first) contains A Successful Hay Farm, by Harmon Benton, of the Office of Farm Management. This is a part of the reclamation work by that office, mentioned in the News and Notes of this issue of Forestry and Irrigation. The bulletin gives the details of the management, cultural methods, equipment, cost, etc., of a twenty-five acre hay farm in Cherokee County, South Carolina, with some general suggestions for hay growers in the South.

In the Railway Critic recently appeared an article by one of the directors of the American Forestry Association, viz.: W. W. Finley, president of the Southern Railway, on The Correction of Railway Abuses.

In the Federation Bulletin for December, the official organ of the General Federation of the Women's Clubs, we find a communication by Mrs. Peterson, chairman of the Forestry Committee. She urges effort to the end that every State in the Union be brought into the movement to save the trees, by means of the enlightenment of public sentiment. Suggestions are given for forestry work by the clubs.

In the same issue the report of the Colorado State Federation mentions the many activities of the Forestry Committee in that State, and the wonderful growth of interest among the clubs.

An editorial in the Outlook says the success of the National Forests, both financially and in beneficial results, is a satisfaction to economists and right-minded citizens.

The Engineer, published at Chicago, tells of a proposed enterprise in Maine for obtaining power from the tides. A profile is shown of the plant to be erected at South Thomaston. The power is to come from air compression, and the compressor part does not involve machinery, hence is expected to be cheap.

FOR SALE

SET OF

SARGENT'S SILVA OF NORTH AMERICA

Fourteen volumes in original boxes Cost \$350 net; offered at \$265 net. Also a number of books on FORESTRY and BOTANY. Address

W. W. ASHE

Forest Service Washington, D. C.

HARVARD UNIVERSITY

The Graduate School of Applied Science and

The Lawrence Scientific School

offer graduate and undergraduate courses in Civil, Mechanical, Electrical, Mining and Metallurgical Engineering, Architecture, Landscape Architecture, Forestry, Physics, Chemistry, Biology and Geology.

For further information, address W.C. SABINE, 15 University Hall, Cambridge, Mass.

THE PINES

Tallulah Falls, Ga.

MISS A. G. STONE, Prop.

Summer season from June to October. At other seasons by special appointment.

Rates: \$2 to \$2.50 per day
\$10 to \$15 per week

THE Pennsylvania State College

A thorough and practical undergraduate course in technical forestry, preparing men for all lines of professional and applied forestry.

Special attention is paid to practical field work in surveying, mapping and forest measurements. One of the largest of the State Forest Reserves is within a short walk of the college.

For information regarding entrance requirements, expenses, etc., address

Department of Forestry

State College, Penna.

THE Continuing Garden

with its enclosure of Amoor River Privet and its borders of **Hardy Perennial Phloxes**, planted for a long season of bloom, will require a clump of transient-leaved shrubs on the lawn to properly set off its beauty. The group should contain shrubs in contrast, which, in flower, foliage and fruit will follow each other through the season. For this purpose we have selected



A Dozen HARDY SHRUBS

as follows: Mezereum, Drooping Golden Bell, Persian White Lilac, Spirea, Van Houtte; Japanese Snowball,

Mock Orange, Dentzia, Pride of Rochester; Weigela, Variegated; Althea; Hydrangea, Plumel; Spirea, Anthony Waterer; Barbary. The dozen shrubs, carriage charges prepaid, only \$2; larger specimens, \$3. Book, "Peter's Plants," FREE! The most modern and most helpful catalogue sorted. Be sure to get a copy. **Peter's Nursery Co., Box 1207, Knoxville, Tenn.**



**Evergreens,
Forest Trees
and Seeds.**

Three Millions of White Pine Seedlings and nearly one ton of Seeds.

Red Oaks, Linden, Black Locust

ALSO SEEDS

For forest planting on sandy soil I offer several millions Ponderosa and Jack Pines and Northern Red Cedar, and Seeds of same.

Northern Grown Trees and Seeds a Specialty

Mention this paper when you write.

D. HILL, Evergreen Specialist

DUNDEE, ILL.

SEEDS THAT GROW

Best quality Garden, Flower and Farm Seeds, Alfalfa, Clover, Grass Seeds, Seed Potatoes. We send free with catalog a pkt of "New Globe" Tomatoes, biggest yielder, finest flavored of all.

GERMAN NURSERIES & SEED HOUSE
CARL SONDEREGGER, Prop.
 You ask for it. Write us to-day. Also have full line of Nursery Stock, Roses, Plants and Bulbs.

**GERMAN NURSERIES,
BEATRICE,
Nebraska.**

Box 106,

ORCHIDS

ORCHIDS

We are the largest Orchid Growers in the United States Our Illustrated and Descriptive Catalogue of Orchids is now ready and may be had on application

Orchid Growers and Importers

LAGER & HURRELL,
Summit, N. J.

BE A RAILWAY MAIL CLERK

Earn \$83 to \$130 a Month—Work Only Half the Time. We prepare you by mail to pass a successful



U.S. MAIL

Civil Service Examination. Most complete course. Uncle Sam wants Mail Clerks. Write today for free catalog and special offer. The Wenthe Correspondence School, Box 90, Freeport, Illinois

Read "Irrigation in the United States," by Frederick Haynes Newell, Director of the Reclamation Service. Price, \$2, postpaid to any address. Address "Forestry and Irrigation," Washington, D. C.



Rife Hydraulic Ram

(Pumps Water by Water Power)

Town Water Works,

**Railroad Tanks, Irrigation,
Country Homes, Greenhouses.**

No Attention—No Expense—Runs Continuously.

Operates under 18 inches to 50 feet fall. Elevates water 30 feet each foot of fall. 5000 in successful operation. Sold on 30 days trial. Catalog and estimate free.

RIFE HYDRAULIC RAM COMPANY,
217 1/2 Trinity Bldg., New York.

FOREST PLANTS

Millions in stock, very cheap, also Thorn for Hedges and **Fruit Stocks** a specialty. The Largest Nurseries in Germany. Shipments of 150 millions of plants annually. Catalogues and references Free on application.

J. HEINS' SONS,

Halstenbek, nr. Hambu. Germany.

The . . **PAPER** . . that this publication is printed on is furnished by

R. P. Andrews Paper Co., Inc., Washington,

Sole Agents in the District of Columbia for the **West Virginia Pulp and Paper Company,** the Largest Manufacturers of Book Paper in the world.

IF IN NEED, DROP THEM A LINE

Biltmore Forest School

Biltmore, N. C.



Theoretical and practical instruction in all branches of applied forestry.

Course comprising twelve consecutive months can be entered at any time of the year—no vacations.

Object lessons within the mountain estate of George W. Vanderbilt, comprising 120,000 acres, where forestry has been practiced since 1895



For further information apply to

C. A. Schenck, Director

COLORADO SCHOOL OF FORESTRY...

Colorado Springs, Colo.

Three years' course in
**TECHNICAL AND
APPLIED FORESTRY**

Winter Term at Colorado College, Colorado Springs.
Summer Term at Manitou Park on the borders of the Pike's Peak Forest Reserve.

**TUITION, SIXTY DOLLARS
A YEAR**

For further particulars apply to
WM. C. STURGIS, Dean

Colorado Springs - - - Colo.

YALE FOREST SCHOOL NEW HAVEN, . . CONNECTICUT

The course of study in THE YALE FOREST SCHOOL covers a period of two years. Graduates of collegiate institutions of high standing are admitted as candidates for the degree of Master of Forestry.

The Summer School of Forestry is conducted at Milford, Pike County, Fenna.

For further information address

Henry S. Graves, Director, New Haven, Conn.

FORESTRY AND IRRIGATION

Annual Meeting of American Forestry Association

Letter to the Members

Hearing on the Appalachian Bill

Dalmatia—A Country Without Soil

Public Opinion on the National Forests

Itasca Summer School of Forestry

Millions for Tribute, Nothing for Defense

Forest Perpetuation and Water Supplies

Redwood Forest a Gift to the Nation

National Drainage Congress

Thorburn's Seeds

Seed of *Pinus Banksiana* - \$4.00 per lb.
(Northern Jack Pine)

Seed of *Pinus Strobus* - \$1.50 per lb.
(White Pine)

Free by mail or express.

Special prices on large lots on application.
Also large line other tree and shrub seeds.
New crop imported natural grasses.
Send for 1908 catalog, ready about Jan. 1st.

J. M. Thorburn & Co.

33 Barclay Street,
Through to 38 Park Place

Established 1802

NEW YORK

This Solar can be used in hazy weather, when other Solars are useless. Used by the U. S. General Land Office.



Specifications:

Needle $3\frac{1}{2}$ inches long. Graduations $4\frac{1}{2}$ inches long reading minutes. Power of telescope 20 (with splendid definition, good light, and large field). Variation plate. Level to telescope, clamp and opposing screws. Vertical arc. Fixed Stadia-hairs. Extension side of standards.

Tripod. Solar Attachment on

Price, complete \$300

Telegraph and Code Word, Mountsolar

Illustrated Catalogue upon application

YOUNG & SONS, PHILADELPHIA

Have You a Hobby?

It does not make any difference to us with what kind of a hobby you are identified, we can furnish you articles from papers and magazines published all over the world upon any subject you may be interested in. The man who wants to be

Up-to-Date

needs the help of a good

Press-Clipping Service

because he cannot read everything himself. It's simply a physical impossibility. Let us read for you—it's our business. Our work saves you much valuable time spent in libraries and reading papers in search for information which can be nowhere definitely obtained. You will be surprised at the results; you will see paragraphs which you would never have been able to find yourself. Drop us a postal and we will point out to you what we can do for you. Price, \$5.00 for 100 clippings.

H. ROMEIKE, Inc.

110-112 West 26th St.

New York City

PLANE SURVEYING

A Textbook and Pocket Manual

By JOHN CLAYTON TRACY, C. E.

*Ass't Professor of Structural Engineering
Sheffield Scientific School of Yale University*

16 mo, xxvii + 792 pages, illustrated with line cuts. Morocco, \$3.00

Used in the Yale Forestry School and just adopted in Pennsylvania Department of Forestry :: ::

Descriptive Circular on Application

JOHN WILEY & SONS

43 and 45 E. 19th St. New York City

THE American Forestry Association

Officers for 1908

President

HON. JAMES WILSON, Secretary of Agriculture

Vice-Presidents-at-Large

DR. EDWARD EVERETT HALE
DR. B. E. FERNOW

JAMES W. PINCHOT
F. E. WEYERHAEUSER
JOHN L. KAUL

Advisory Board Selected by Affiliated Organizations

SILAS W. GARDNER
GEORGE T. CRUFT
GEORGE E. STONE
E. F. SAWYER

PHILIP W. AYRES
GEORGE F. CRAIG
ALLEN CHAMBERLAIN
F. E. WEYERHAEUSER

H. H. WHELESS
ROBERT C. LIPPINCOTT
C. A. SMITH
D. E. KLINE
KENT SHEPPARD

Members of Board Designated as Vice-Presidents of Association

N. W. McLEOD
WILLIAM IRVINE

LEWIS DILL
EDWIN A. START

FRANK W. ROLLINS
D. E. KLINE

Secretary, THOMAS ELMER WILL, Washington, D. C.

Assistant Secretary, WILLIAM CANFIELD LEE, Washington, D. C.

Treasurer, OTTO LUEBKERT, Washington, D. C.

Directors

JAMES WILSON
WILLIAM L. HALL
GEORGE P. WHITTLESEY
JAMES H. CUTLER
RUTHERFORD P. HAYES

HENRY S. GRAVES
F. H. NEWELL
GIFFORD PINCHOT
N. J. BACHELDER
ALBERT SHAW

W. W. FINLEY
GEORGE K. SMITH
WILLIAM S. HARVEY
H. A. PRESSEY
GEORGE F. PEABODY

Application for Membership

To THOMAS ELMER WILL,

Secretary American Forestry Association

1311 G Street, N.W., Washington, D. C.

Dear Sir: I hereby signify my desire to become a member of the American Forestry Association. Two Dollars (\$2.00) for annual dues are enclosed herewith.

Very truly yours,

Name.....

P. O. Address.....

. . T H E . .
AMERICAN FORESTRY ASSOCIATION

President—**HON. JAMES WILSON,**
Secretary of Agriculture.

The American Forestry Association was organized in 1882, and incorporated in January, 1897. It now has over 6,600 members, residents of every State in the Union, Canada, and foreign countries. From its origin it has been the tireless friend of the forests.

The object of the Association is to promote the preservation, by wise use, and the extension of the forests of the United States; its means are agitation and education; it seeks to encourage the application of forestry by private owners to forest holdings, large or small; and it favors, especially, the establishment and multiplication of National and State forests, to be administered in the highest interests of all.

The Association seeks as members all who sympathize with its object and methods, and who believe that our natural resources constitute a common heritage, to be used without abusing and administered for the common good. Seeking to conserve our supplies of wood and water, the Association appeals especially to wood-producers and users, including owners of wood lands, lumbermen, foresters, railroad men, and engineers; and to those dependent upon equable stream flow, as manufacturers, irrigators, employers of water power, and those engaged in internal commerce.

The Association meets annually in Washington. It publishes, monthly, **FORESTRY AND IRRIGATION**, the magazine of authority in its special field. The list of contributors to this publication includes practically all persons prominent in forest work in the United States, making it alone worth the cost of Annual Membership in the Association.

The dues, covering a subscription to **FORESTRY AND IRRIGATION**, are as follows: Annual—For Annual Members, \$2; for Sustaining Members, \$25; Total, with exemption from all other payments—for Life Members, \$100; for Patrons, \$1,000.

THOMAS ELMER WILL, Secretary.
Address: 1311 G Street, N. W., Washington, D. C.

Nominations for Membership

The activities of the National Office of The American Forestry Association are limited chiefly by its resources. These are derived almost wholly from its members in the form of dues. Every member is urged to aid in increasing the membership. Kindly fill out the enclosed blank form and send it to

THOMAS E. WILL
Secretary, American Forestry Association
1311 G Street, Northwest, Washington, D. C.

I hereby nominate the following persons for membership in The American Forestry Association:

Name

Address

Signed

THE Pennsylvania State College

A thorough and practical undergraduate course in technical forestry, preparing men for all lines of professional and applied forestry.

Special attention is paid to practical field work in surveying, mapping and forest measurements. One of the largest of the State Forest Reserves is within a short walk of the college.

For information regarding entrance requirements, expenses, etc., address

Department of Forestry
State College, Penna.

FOREST PLANTS

Millions in stock, very cheap, also Thorn for Hedges and **Fruit Stocks** a specialty. The Largest Nurseries in Germany. Shipments of 150 millions of plants annually. Catalogues and references Free on application.

J. HEINS' SONS,

FOR SALE

SET OF

SARGENT'S SILVA OF NORTH AMERICA

Fourteen volumes in original boxes. Cost \$350 net; offered at \$265 net. Also a number of books on FORESTRY and BOTANY. Address

W. W. ASHE

Forest Service Washington, D. C.

Read "Irrigation in the United States," by Frederick Haynes Newell, Director of the Reclamation Service. Price, \$2, postpaid to any address. Address "Forestry and Irrigation," Washington, D. C.

HARVARD UNIVERSITY

The Graduate School of Applied Science and
The Lawrence Scientific School

offer graduate and undergraduate courses in Civil, Mechanical, Electrical, Mining and Metallurgical Engineering, Architecture, Landscape Architecture, Forestry, Physics, Chemistry, Biology and Geology.

For further information, address W.C. SABINE, 15 University Hall, Cambridge, Mass.

"TREE SEEDS"

Pine, Larch, Spruce,
Catalpa, Ash, Locust,
Etc.

Let us send you our DESCRIPTIVE CATALOGUE of TREE SEEDS. It will meet all your requirements

OUR NEW SEEDS ARE NOW IN STOCK AND ARE READY FOR PROMPT DELIVERY

Estimates on large quantities promptly submitted

Write today. The catalogue is free, of course

OTTO KATZENSTEIN & CO.
Tree Seedsmen

35 W. Alabama St. Atlanta, Ga.

SEEDS THAT GROW

Best quality Garden, Flower and Farm Seeds, Alfalfa, Clover, Grass Seeds, Seed Potatoes. We send free with catalog a pkt of "New Globe" Tomato, to highest yield, or, finest flavored of all.

you ask for it. Write us to-day. Also have full line of Nursery Stock, Roses, Plants and Bulbs.

GERMAN NURSERIES & SEED HOUSE
CARL SONDEREGGER, Prop.
GERMAN NURSERIES,
BEATRICE, Nebraska.
Box 106.

Timber Lands FOR SALE

Tracts of yellow pine, hemlock, etc., in Florida, of 50,000, 150,000, 300,000 and 1,200,000 acres. From 4,000 to 7,000 feet to the acre.

Water and Railroad Facilities.

Summer all the year round; also tracts of yellow pine and hardwood in 25 to 100,000 acre lots in other Southern States. We want Large Tracts of Gum and Cottonwood.

Address Nelson, care Forestry and Irrigation.

TO BUY OR SELL **LAND** FARM OR TIMBER

WRITE TO FRED HAYSEN, ANTIGO, WIS.



The LAND OF LOVELY DREAMS

WHERE THE KNOTTED
NORTHERN NERVES
MAY RELAX AND REST

THE TAMPA BAY HOTEL,
TAMPA, FLA.

WHY should one go to Tampa rather than the resorts on the other coast of Florida? Because the climate of the west coast is far more equable, less enervating, more beneficial to nerves and mind than any other. The climate of Tampa is dry and its tropical warmth is tempered agreeably by westerly breezes from the Gulf of Mexico. While the glorious sunshine in the day time reminds one of the close proximity of the tropical Everglades, night brings with it refreshing coolness and fragrant dews, and with them comes, without fail, "Nature's sweet restorer, balmy sleep."

Apply to agents of The Seaboard Air Line Railway, The Atlantic Coast Railway, Southern Railway, and their connecting lines.

Booklet and Tariff sent on application.

DAVID LAUBER, Manager, Tampa, Florida

FORESTRY AND IRRIGATION

THOMAS ELMER WILL
WM. CANFIELD LEE

Editor
Associate Editor

CONTENTS FOR FEBRUARY, 1908

EDITORIAL

Ostriches vs. Wise Men.....	61
The Pressing Need.....	62
What Shall We Do?.....	63
The Task and the Tools.....	63
Equip the Association.....	63
Brace Up Your Congressman.....	64
Practical Forestry.....	65

Pinnacles Made National Monument.....	66
New Mineral Found in Alaska.....	69
Fungus Checks Bark Beetle.....	70
Insects Are Rivals of Fire.....	70
Shipworms Ruin Northwest Lumber.....	71
Organization of Alabama Forestry Commission.....	71
Professor Winkenwerder of Colorado.....	72
Professor Scott of Iowa.....	72
Antioch Summer School of Forestry.....	72
Massachusetts Agricultural College.....	72
Class in National Forest Management.....	73
Children and Civic Betterment.....	73
Mr. Mills's Splendid Work.....	74
Good Roads Urged by the Grange.....	74
Finances of Roadside Trees.....	74
Paying Crop for Swamp Lands.....	75
Immense Number of Boxes.....	75
Planting Thousands of Pine Seeds.....	75

NEWS AND NOTES

The Annual Meeting.....	66
Freight Rates and Tree Cutting.....	66
What the Governor of Ohio Says.....	67
Stay the Axe, Then Guide It.....	67
Roosevelt Pleased at New Organization.....	68
An Exasperating Anomaly.....	68
National Park on the Hudson.....	68
The Grand Canyon Set Aside.....	69

DESOLATION IN DALMATIA. By Florence Keen	76
A LETTER TO OUR MEMBERS	77
DESECRATION. (<i>Poem.</i>) By Harold Trowbridge Pulsifer	79
NATIONAL FORESTS AND PUBLIC OPINION. By Lydia Adams-Williams	80
HEARING ON THE APPALACHIAN BILL	84
What New England is Doing	84
Great Activity in the South	85
Help from Other Sources	85
THE TEMPLES EAST AND WEST. (<i>Poem.</i>) By the Lumberman Poet	86
FOREST PERPETUATION AND WATER SUPPLIES. (<i>Illustrated.</i>)	87
THE PEACE OF QUIET AISLES. (<i>Poem.</i>) By Jane Taaffe	89
THE MINNESOTA FOREST SCHOOL AT ITASCA PARK. By E. G. Cheyney. (<i>Illustrated.</i>)	90
MILLIONS FOR TRIBUTE, BUT NOT ONE CENT FOR DEFENSE. By F. M. Eaton. (<i>Illustrated.</i>)	94
REDWOOD CANYON DREDED TO UNITED STATES. (<i>Illustrated</i>)	97
NATIONAL DRAINAGE CONGRESS. (<i>Illustrated</i>)	99
WITH MEMBERS AND CORRESPONDENTS	103
U. S. FOREST SERVICE	106
U. S. RECLAMATION SERVICE	112
RECENT PUBLICATIONS	115

FORESTRY AND IRRIGATION is the official organ of the American Forestry Association. Price, \$2.00 per year, including Annual Membership in the Association. Copyright, 1907, by The American Forestry Association. Entered at the Postoffice at Washington, D. C., as second-class mail matter.

Published Monthly at
1311 G STREET, N.W. WASHINGTON, D. C.

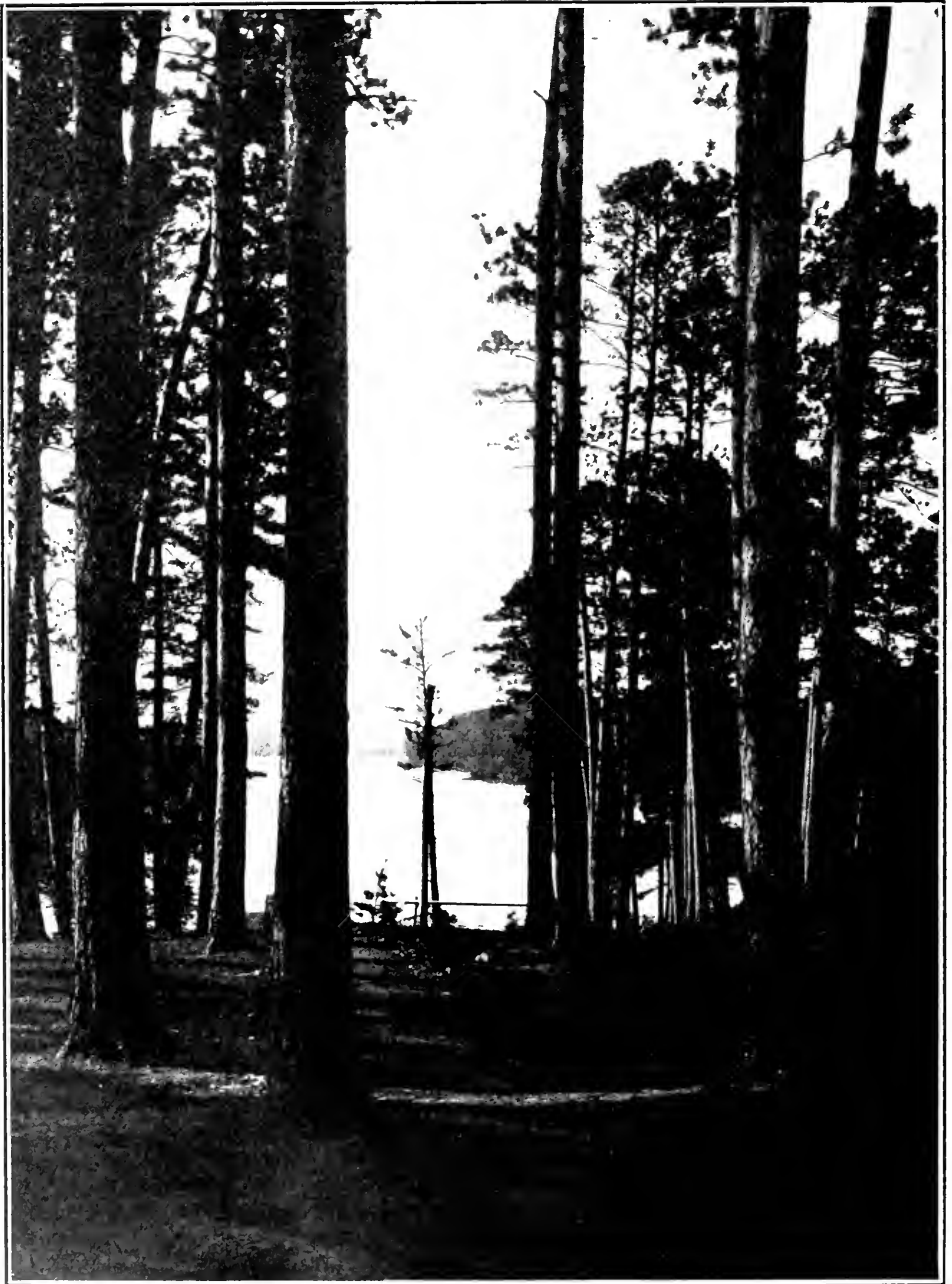

View of Lake Itasca from Douglas Lodge, Minnesota State Park



FORESTRY AND IRRIGATION

VOL. XIV

FEBRUARY, 1908

No. 2

EDITORIAL

Ostriches vs. Wise Men

Despite the havoc which has been wrought in the United States by the wreck of our forests, there is less reason for alarm concerning the future than some people fear. There are new ways of doing things. With the use of steel and cement a great deal of the necessity for wood as a building material is disappearing. There is strong ground for hope that the dearth of timber in the United States in 1925 will not be as dire as some writers fear.—*Milwaukee Wisconsin.*

This is the kind of writing that does mischief. It blindfolds the eyes to the facts, and lulls to sleep with baseless assurances. It fittingly typifies the ostrich which, by hiding its head in the sand and thus shutting off from its own view all danger, assumes that danger does not exist.

Look at a few facts. Here is a Forest Service bulletin: "The Drain Upon the Forests," dated November 30, 1907. Speaking on this very question of substitutes, it says: "The many substitutes for wood that have been proposed, and to some extent used, have not lessened the demand for timber, as is shown by the fact that the per capita consumption was 360

board feet in 1880 and 440 feet in 1906."

How, pray, in the face of such facts, are substitutes to solve the problem? Take the case of cross-ties alone. Of these we use one hundred millions annually. To maintain each one of these ties in the track we must keep two trees growing in the forest. Substitutes have been tried here. In this country, at least, they have signally failed. At the American Forest Congress of 1905, Gen. Charles F. Manderson, general solicitor of the Chicago, Burlington & Quincy Railroad, discussing this point, said:

"As yet no substitute has been devised for wood ties that is either economical or desirable. They maintain the alignment of the railroad tracks, which is so essential to safety, better than any metal substitute, and give an elasticity to the road bed most important for the preservation and maintenance of the rolling stock. With metal ties, or a stone base, the rails would be speedily injured, and the heavy Mogul engines used to-day, drawing the heavy trains of large cars needed for the traffic, would pound themselves quickly into decrepitude and uselessness."

Wood substitutes are deceptive. In Germany, a hundred years ago, coal began to take the place of wood, but the consumption of wood in that country has increased in the same ratio as the consumption of coal. From a superficial view point, one might imagine that the iron ship would be a wood saver. In fact, however, more wood goes into shipbuilding to-day than ever before; for all ships require some wood, and more ships are now built than in any former year. The metal used at the top of the mine shaft is as nothing compared with the quantities of wood used below. Steel sky-scrapers are to-day the vogue; but more wood is used in the construction of houses than ever before. The old wooden paving block has gone, but another is taking its place, which, it is claimed, is superior to any other form of paving.

And so on to the end of the chapter. Optimism may be a good thing; but the optimism that "indulges in the illusions of hope and listens to the song of the siren," while hastening toward peril, instead of bravely meeting the situation and substituting security for danger, is a public menace. Of such "optimism" America has had an overdose. The time for intelligent, deliberate and vigorous action is at hand.

**The
Pressing
Need**

Before the American Forestry Association lies a work than which, perhaps, none more stupendous ever faced a voluntary organization. It is nothing less than the arousing of eighty million people to a problem whose solution is vital to their well-being, showing them the remedy and leading them to apply it.

Look at such facts as, in condensed form, are brought together in the letter to our members, published in this issue. We have the President of the United States warning the people of the progressive and rapid destruction of the very sources of their physical lives—the raw materials from which must be provided, in large

part, their food, shelter, and means of transportation. We have him announcing this as the greatest issue before the American people, and convening an assembly of notables to discuss with him the problem.

We have the United States Forester declaring that, under present policies of use and waste, our timber supply will probably not last more than from one-fifth to one-third of a century—a period which, in the life of a Nation, is but the infinitesimal fraction of the diameter of a hair; and indicating the calamitous results which inevitably follow in the train of forest destruction.

We have the Director of the Reclamation Service pointing to the vast and beneficent work now in progress under Government auspices in the way of redeeming the desert and providing homes for the people; but averring, at the same time, that the continuance and success of this work are absolutely dependent upon the retention of forests upon the mountain sides, which, in turn, is dependent upon National action.

We have a representative of the Waterways Commission and Bureau of Soils asserting that we are permitting the sweeping each year into the sea of enough soil to fertilize our whole Atlantic coast area as far west as Ohio and as far south as Georgia, the annual value of this loss being at least one billion dollars, and constituting the heaviest tax upon the American farmer. Such loss, furthermore, is practically permanent, for the process of soil formation requires not years or decades, but centuries and even ages. And he adds that this "soil wash and river ravage are largely to be traced to the absence of forests upon slopes in which rivers rise."

In the case of our inland waters we have another billion dollars annually going to waste in the form of unutilized power, and an annual damage, in addition, of one hundred million dollars from floods. And here again forest conservation is essential to the solution of the problem.

But let the reader turn to the letter and read it in its entirety, and then let him consider the question, "What are we going to do about it?"

What Shall We Do? We can take one of two courses: First, we can do nothing; we can follow in the footsteps of China and Syria and the several Mediterranean lands that have destroyed their birthright and are now, through the centuries, paying the grim penalty. We can continue to create conditions that will cause posterity to look back upon the present era as the golden era in American history; and to curse the short-sighted, brutal selfishness of sires who, for the brief, temporary gratification of industrial ambition, destroyed the land upon which, for all time, their children must live, and bequeathed to them an inheritance of slavery and want. Or we can grapple with the conditions like men. We can appeal to the splendid intelligence and the great heart of the American people. We can bring home to them the facts and the inevitable consequence. We can make clear to them the solution and lead them to apply it while yet there is time. Which horn of the dilemma shall we choose?

Suppose we discard the policy of inertia and adopt that of action? The task before us, as stated, is great. We must remember that the average man is largely absorbed in the immediate problem of procuring his daily bread. Days of toil, followed by nights of recuperation, make up the lives of most. To rouse them is no small task. No one medium of communication reaches more than a fraction. A multitude of media must be utilized. Further, no single lesson will suffice. What is required is the line upon line, and precept upon precept; the constant dropping that wears the stone: the appeal to the eye through book and picture, and to the ear through the human voice until the mind has been convinced and the will enlisted.

But, when this has been done, there yet remain the tasks, first, of indicating the kind of action required, of distinguishing real remedies from spurious and deceptive ones, and, second, of writing the necessary legislation upon the statutes and seeing that, amidst the whirligig of political changes, the legislation is enforced and the interests of the people are safeguarded.

Here is a work which may well appeal to the noblest, and claim the service of the greatest.

The Task and The Tools And to cope with this situation, what have we? An organization of some six thousand people, largely absorbed in their private affairs, and paying for the most part annual dues of two dollars each; an office with a half-dozen helpers swamped with work, a magazine reaching seven or eight thousands out of eighty millions, and, more recently, a press bulletin reaching fifteen hundred newspapers per week.

This, it is true, is something; it means a far greater efficiency than the Association has ever before known; it is a wheat grain which may ultimately yield a crop.

But, as compared with the actual, daily need of the Nation, this is nothing at all; it is a drop in the ocean, a single lighted match in the darkness of Egypt; an ant seeking to tunnel a mountain. When, by the side of the task, we place the tools for performing it, we are still, obviously, in the day of small things.

This work imperatively demands adequate equipment. Its activities should be multiplied a hundred-fold. It should become a power, inspiring the forces of destruction with concern and the forces of construction with hope and confidence.

Equip the Association The great need of this organization is funds. Whence shall they come? Of necessity, they must come from private sources. Membership

fees yield something, yet their total is slight in comparison with the revenues which such an organization should command. To secure even these is a serious undertaking; and for the association to devote its energies chiefly to soliciting funds, whether through membership campaigns or otherwise, is obviously a perversion of effort. Its main activities should be devoted, not simply to maintaining its own existence, but to agitation, education and the quest for legislation; to serving the ends for which it was created. Otherwise, what right has it to exist at all?

There is wealth in this country beyond the dreams of the Arabian Nights. Every dollar of it has come from the sources which are now menaced. Furthermore, considerable portions of it are devoted to works of philanthropy and public service. Millions are constantly being poured forth to establishing and maintaining schools, churches, libraries, charities and benefactions of various types. Why are not such funds available for this work? Men talk of "prosperity." Whence will come the prosperity when, as in China, our mountain sides are picked bare as a bone, and the soils of our valleys have largely been washed into our rivers and harbors? They ask us to look on the bright side. Why not make sure that it shall continue bright? They call "America another name for opportunity." Why not see that the opportunity is perpetuated rather than destroyed?

What greater cause could appeal to philanthropy than that of preserving our heritage? What weightier obligation can be laid upon the conscience of one who has accumulated millions from "our boundless resources" than to aid in perpetuating these resources? Men give to the transitory; why not to the permanent? They contribute to small causes, why not to great? They build libraries; why not maintain the supply of material from which books and buildings must be made? They multiply colleges; why not recognize that, whether schooled or un-

schooled, people must draw their supplies from the earth? They scatter alms; why not provide against the persistence and the intensification of poverty?

Here is a field for the activity of our members. Many of them are in close touch with men or women who could put the Association on its feet, and make it a mighty factor in the affairs of this Nation. Will they not exert themselves to this end? What higher service could they render the race?

**Brace Up
Your Con-
gressman** "Many farmers imagine that the member of Congress whom they have elected will voice their convictions in laws without constant bracing up. We rise to explain to them that they are gravely mistaken. The average Congressman will, as far as possible, legislate for the interests of his constituents; but he must be informed, and sometimes peremptorily, what these interests are. This is what we mean by 'bracing up' a Congressman.

"Just now the members of Congress are particularly sensitive to public opinion, because nearly all of them want to be re-elected. Congressmen seldom resign, and are always found with an ear to the ground, particularly in election years."

The above is from *Wallace's Farmer*, a paper that has done good work in persuading Iowa farmers to give heed to what their Representatives do.

Considering the relations of constituents to Congressmen, we should remember who is principal and who is agent. It must never be forgotten that the United States is a republic; that laws, constitution and administrative acts find their sole validity in popular approval or acquiescence. The old monarchical doctrine that the king is the fountain of justice and the source of law has absolutely no place in the United States. Exactly the reverse is true; it is the people who are the fountain of justice and the source of law, and it is the people

from whom all officials, high or low, and of whatever character, take, or should take, directly or indirectly, their orders. To speak, as some text-book makers have done, of men in public life as "our rulers" is an anachronism, preposterous and offensive. If any doubt, let him turn to his Declaration of Independence and read that all "governments derive their just powers from the consent of the governed."

The people have exactly as much right to instruct their representatives and to control the course of their public officials in general as an employer has to instruct and control his employees. The constituent who imagines his Congressman to be master and himself servant has gotten the relations of the two exactly reversed. He should learn to live up to the limits of his privilege, and, if he observes his Congressman pursuing a course contrary to the dominant sentiment of his district he should realize that it is the constituents who are chiefly at fault. By all means let them see that their representative does the work of those upon whom he depends for his political breath of life.

Practical Forestry

One of the largest paper companies in the country, the International Paper Company, is cutting on forest principles. In their logging operations in Maine no spruce under 10 inches in diameter on the stump is being cut. And what a contrast their cut-over land offers to that of other large companies logging in the same region! On their lands, after logging, there is a large amount of

small stuff left; the forest remaining is of great value, and in a few years will be ready for another cut of spruce. On the lands of other companies in the same region every stick of merchantable material is taken, spruce being cut down to as small as six or seven inches. There is absolutely nothing left after logging but a barren waste of stumps and debris, forming a veritable fire-trap that lasts for years. The land is too often burned over and made of no value whatsoever for years to come. All chance of a present, and often all hope of a future, growth of spruce is destroyed.

The value of conservative logging has been repeatedly illustrated. Even before forestry was much talked of in this country a few far-sighted lumbermen were logging conservatively. Notable among them is Mr. Daniel W. Saunders, in Livermore, New Hampshire. Mr. Saunders has cut the same land over twice for spruce sawlogs, and it is still in good condition, with a large amount of small spruce which will soon be merchantable. Only trees over about 16 inches in diameter were cut the first time. The second time he cut down to about 14 inches in diameter, and, as he was also able to cut trees that were considered as cull or of no value the first time, he obtained a larger cut the second time. There is still a great deal of valuable timber on this cut-over land, and in a comparatively short time it will be ready for a third cut. And the value of stumpage is still increasing. This is a striking example of what careful, conservative logging and protection from fire can accomplish.



NEWS AND NOTES

The Annual Meeting

Members and friends will remember that the Annual Meeting of the American Forestry Association occurs on Wednesday, January 29, at the New Willard Hotel in Washington, D. C. The sessions begin at 10 o'clock in the morning and continue through the afternoon and evening. The reception, earlier announced to be held at the residence of Mr. and Mrs. J. W. Pinchot and Mr. Gifford Pinchot, the Forester, has, on account of the severe illness of Mr. J. W. Pinchot, been cancelled. The evening of Wednesday will, however, be packed full of important business.

The program for the meeting is far advanced in point of preparation, but cannot as yet be definitely announced. Much attention will be given to the Appalachian-White Mountain question, and, in an important sense, the meeting will constitute a preparation for the hearing before the Committee on Agriculture of the House of Representatives to begin on the following day at 10 o'clock a. m. Distinguished and able speakers are expected to handle such topics as the following: The situation regarding our natural resources, forestry as a National and State problem, co-operation between Government and timberland owners, forests and the health of the Nation, the interest of the South in the Appalachian National Forests, the interest of the North in the White Mountain National Forests, the need of forest conservation in West Virginia, flood damage from Appalachian rivers, erosion in the Southern Appalachian Mountains and its effect on navigable rivers, need of Southern Appalachian forests for protection of waterpowers, relation of mountain forests to water navigation, and the question, Is the Appalachian-White Mountain bill constitutional?

The meeting of the Board of Di-

rectors of the Association will be held at 4 o'clock p. m. on Tuesday, January 28th, at the office of the Secretary of Agriculture.

On arriving in Washington, members of the Association are requested to register at room 305, Epiphany Building, 1311 G street northwest, the office of the American Forestry Association.

Every member of the Association who can possibly attend is earnestly urged to be present to make this the greatest and most representative meeting of the Association ever held, and to aid in the most effective way in securing the enactment of the Appalachian-White Mountain bill.

Freight Rates And Tree Cutting

The Pacific Coast Lumber Manufacturers' Association, the Northwestern Lumber Association, and other lumbermen, are endeavoring to secure from Congress a law that new freight rates, higher than the old, shall not go into force, if protested against by shippers, until their reasonableness has been approved by the Interstate Commerce Commission. They claim that when the shipper is dissatisfied with an already existing rate, as being too high, he cannot reduce it without the delay and trouble of a hearing before the Commission; and that it would, therefore, be only fair if the railroad, when dissatisfied with a rate, as being too low, should be subject to the same restraint in securing a change.

In its application to lumber shipments this proposition has an important bearing on the forest situation on the Pacific coast. Mr. A. B. Wastell, secretary of the association, writes that a raise of freight rates will greatly reduce the thoroughness with which the trees cut in the Pacific Northwest are utilized. The rates heretofore paid have been so high that any higher rates will render it unprofitable to ship the cheaper grades of lumber and tim-

ber across the continent. These grades, which form a considerable part of the tree, will therefore be wasted, since they cannot be utilized if they are cut off from the Eastern market.

What the Governor of Ohio Says The Governor of Ohio urges on the Legislature the encouragement of forestry in the State. He says in his message: "The forests of Ohio are disappearing. Unless some protection is given, they will soon pass away. If our State Constitution would permit a low valuation or a rebate of taxes on woodland dedicated for a period of years to reforestry, it would give encouragement. Iowa, Pennsylvania, Connecticut, New Hampshire, Colorado, Indiana, Maine, Rhode Island and Wisconsin have enacted laws reducing taxation to encourage the growing of forests.

"I suggest that article 12, section 2, of our Constitution be amended so the Legislature can give encouragement to reforesting our denuded lands and protecting existing forests by reducing or omitting the taxes thereon.

"In many parts of the State the growing of trees, as the growing of corn and wheat, would have a commercial value.

"The Experiment Station at Wooster has commenced the encouragement of planting along this line. Since 1904 it has sent out more than half a million seedling trees to 466 farmers in 84 of the counties of the State. The Station has also taken up the work on lands of the State occupied by the Boys' Industrial School near Lancaster, where it found several hundred acres of second growth forest now in good condition for the experiment.

"I highly approve of the interest the Board of Control of the Experiment Station has taken in this work, and recommend further encouragement to the people in forest growing."

Stay the Axe, Then Guide It The Board of Trade of Grand Rapids, Mich., is working for the Appalachian National Forests, and adopt-

ed some days ago the following resolution:

"Resolved, that the Congress of the United States be, and it hereby is, strongly urged to enact into law the Appalachian Bill, providing for the establishment of National Forests in the White Mountains of New Hampshire and in the Southern Appalachians."

In discussing the resolution, Mr. Charles W. Garfield, one of the directors of the Board, and President of the Forest Investigating Commission, spoke as follows:

"The principal contention for making a permanent Government reservation of a considerable portion of the Appalachian Mountain region lies in the fact that it is the principal region from which we must secure our hardwoods to meet the demands of wood-working industries in our country.

"In the last decade quarter-sawed oak went from \$52 to \$80 per thousand; hickory from \$30 to \$65; yellow poplar, or white wood, from \$30 to \$53; hard maple from \$20 to \$32.50. This appreciation in values has not come so much from the greater demand as from the diminished supply, and although we are slow to recognize it we are on the border of a hardwood famine. In support of this fact we have only to note the great reduction in the output of hardwood lumber from the States which have produced the largest supply of this important raw material. The supply from Indiana and Ohio, which was at one time the center of the hardwood industry, is practically exhausted. The supply from Michigan is rapidly dribbling away.

"The region best adapted to the growth of hardwoods, and which, if properly handled, can produce a continuous supply, is the elevation of land known as the Appalachian range of mountains. The region extends from Maine to Georgia, including New Hampshire, Vermont, Massachusetts, New York, Pennsylvania, Maryland, West Virginia, Virginia, Kentucky, Tennessee, North Carolina, South Car-

olina, Georgia and Alabama. In 1906 this region produced about half of the hardwood used in this country. It is safe to say that fully one-half of the present supply is within this area. It is a non-agricultural region. The rainfall is such that the growth per acre per year is the largest to be found anywhere in the hardwood areas of America. It is an accessible region. A large part of it has already been cut off and the best removed, with plenty yet remaining upon the ground. Lumbermen are already engaged in cleaning up the second time, leaving nothing behind.

"A Grand Rapids lumberman said the other day that he was cutting timber perfectly clean from the mountains, and very soon erosion would clear off nearly all of the soil and nothing would be left but rock. A thousand years of the most persistent and careful work in reforestation would not again rehabilitate the region which he is devastating. His excuse for doing it was that if he didn't the other fellow would and he wanted the dollar. In the same conversation he remarked there was only one way in which this destruction could be prevented, and that was for the strong hand of the Government to stay the axe and afterward guide it in its work of gathering in the timber."

Roosevelt Pleased at Organization President Ligon Johnson, of the Appalachian National Forest Association, has received a letter from President Roosevelt, warmly indorsing the work of the association relative to the preservation of the Appalachian forests. The President's letter quotes a speech he delivered at Raleigh, N. C., in October, 1905, and then says further:

"We know also that these forests are of the utmost importance to navigation on the streams to which they give rise. All the water which falls in the Southern Appalachians goes to the sea through navigable channels, which it has cost the Government over \$30,000,000 to keep clear from sand,

silt and gravel. This detritus is increasing every year as the mountains are denuded of their cover.

"The task of cleaning out the Southern streams and harbors grows heavier each year. Until we remove the cause by protecting these mountain forests from fire and reckless cutting, we shall inevitably expend increasing sums without permanent results.

"Eight years ago the movement for the purchase of these forests took definite shape. While it has grown, and is stronger now than ever, its merits should make it far stronger than it is. Therefore I am pleased at the organization of your association with the definite purpose of getting these forests established. As I said in my last message to Congress, 'we should acquire in the Appalachian and White Mountain region the forest lands that it is possible to acquire for the use of the Nation.'"

Exasperating President Roosevelt's admirable letter to the Appalachian National Forest Association eloquently confirms what was formerly believed, and indeed known, concerning his attitude toward the proposed Appalachian and White Mountain National Forests—namely, that he is strongly in favor of acquiring in those regions all the forest lands which it is possible to acquire for the use of the Nation. It is one of the exasperating anomalies of our governmental system that a policy of inestimable importance, earnestly approved and desired by the President, his Cabinet, a majority of both houses of Congress, the governors and governments of the States concerned, and the great majority of intelligent and thoughtful people throughout the Nation, may be arbitrarily and capriciously "held up" and postponed, if not permanently defeated.—*New York Tribune.*

National Park on the Hudson There are ten or more National Parks west of the Mississippi River, set aside for their scenic beauty. There

are several military parks east of the Mississippi, marking battlefields of the Civil War; besides military reservations about posts.

Mr. H. K. Bush-Brown, of Newburgh, N. Y., has proposed a National Park on the Hudson, enclosing West Point, which will be for all the purposes mentioned above, protecting the forests and other elements of beauty, and opening the area to military maneuvers, "while diminishing as little as possible the value of land for villa, private park, or small farm purposes."

An article in the *Outlook*, accompanied by a map, has the following editorial note: "The plan proposed in the following article for the creation of a National Preserve in the highlands of the Hudson deserves the serious consideration of the entire country. It would be in a peculiar sense a National undertaking, because it would commemorate the War of the American Revolution, the military operations of which were carried on to so large an extent in the Hudson Highlands. It would protect the natural beauties of one of the most picturesque regions of the United States, for the Hudson is to America what the Rhine is to Germany. It would provide the opportunity for an inland protected navy-yard in Newburgh Bay, accessible to the largest battleships and closely allied with the army and naval stations at West Point and Iona Island. It would give Government protection to the beautiful forests, lakes, and streams of the region, which are too little known to the people at large, and at the same time would make the territory included more desirable for private residence. For these reasons it is to be hoped that the Patriotic, Historical, Forestry, and Scenic Societies of the country will give the plan their active attention."

famed canyon has been a part of the Grand Canyon National Forest, and its establishment as a National Monument is made by virtue of the Act of June 8, 1906, which provides that objects of scientific interest may be declared National Monuments if such action is deemed necessary for their preservation and protection. The President says in his proclamation: "It is an object of unusual scientific interest, being the greatest eroded canyon within the United States."

It has long been realized that it was highly desirable to have this wonderful gorge, hewn out by the Colorado River, set apart as a National Monument. This assures the area of exclusion from all kinds of entry, and means that the Government will have power to prevent the marring of the scenic beauty by unsightly exploitation of any kind. The area put in the National Monument constitutes approximately 825,280 acres. In determining the boundary of the National Monument an effort was made to draw the line approximately one mile back from the rim of the canyon.

Pinnacles Made National Monument The President has made a National Monument of the jagged peaks known as the Pinnacles, in the western part of San Benito County, California. The area of the Monument is about 2,080 acres. This natural wonder is nine miles due east from the Southern Pacific station, at Soldad, and is reached by two roads. The Pinnacles are located within the Pinnacles National Forest, which has an area of 14,108 acres. The movement to give the peaks special protection and preserve them for their scientific interest was started by Hon. J. C. Needham and other influential Californians, in 1904.

The Grand Canyon Set Aside President Roosevelt has just signed a proclamation making a National Monument of the Grand Canyon of the Colorado, in Arizona. This world-

New Mineral Found in Alaska A report from Seattle is that a recent discovery 125 miles below Rampart, on the Yukon River in Alaska, has aroused deep interest in the North.

James Langford, a Rampart pioneer, has found a vein of mineral of the consistency of chalk and of an indigo blue in color. It can be used as ordinary chalk. None of the Alaskan mineralogists can identify it and it is being sent to Seattle for analysis.

There are said to be in Alaska probably a dozen unindented varieties of minerals, and one of the many benefits to Alaska from the Alaska-Yukon-Pacific Exposition, which will be held at Seattle in 1909, will be the assembling and classifying of these now unknown minerals, any of which may be some hitherto undiscovered combination. As original research work will go on all the time the exposition is in progress, one of the first duties of the savants in charge will be the identifying of these unknown elements or combinations, and the adapting of them to some commercial purpose.

Fungus Checks Bark Beetle The bark beetle, which for several years has been working havoc in the valuable pine timber of the Black Hills, S. Dak., has apparently been given a check by a fungus which finds in the dying trees a congenial place of lodgement, and at the same time kills the beetles in the bark. There is hope that the worst of the scourge in that region has passed.

For ten years this beetle has been sweeping through the Black Hills forests, every year invading fresh areas. Its maximum destructiveness was reached about two weeks ago, and it is now on the decline.

The fungus is a "bark peeler." Experts have claimed all the time that the beetles could be checked if some way could be found to peel the trees in which the young broods are harboring. They live in the inner bark and next to the wood. When the bark is separated from the wood their galleries are laid open and they die. Efforts have been made in the affected districts to peel standing trees. Machinery has been made for that express

purpose, and trunks were stripped to a height of 20 feet. But so large are the affected areas that the few trees peeled were not a drop in the bucket.

Efforts were made at different times to cut the dying timber. Tracts were sold to mill men, and large quantities were cut, but not enough to have any appreciable effect on the beetle invasion. Woodpeckers helped the work along. They flocked to the dying trees by hundreds and stripped them of their bark and devoured the young beetles by the million. But that was not enough. The pest had gained such headway that it was beyond the power of barkpeelers, log cutters, and woodpeckers.

Meanwhile the peculiar fungus was gaining headway and getting in its work. It appears in the form of a grayish slime between the bark and the wood. It makes the bark loose and it falls, leaving the trees bare, and bringing down the multitudes of young beetles to their certain death. Even if the bark still hangs on the trunks, the effect on the beetles is equally fatal, for they die in their galleries and larval mines.

In normal conditions the bark beetle attacks storm-thrown or other dead timber, but it is not numerous enough to kill trees, and its invasion can not gain headway. But when some unusual condition—such as a hurricane sweeping over a large timber area—gives them a start, the beetles may increase in numbers until they are able to attack vigorous trees and kill them. The invasion continues until some enemy reduces the beetles below the point where they are able to kill timber. That puts an end to the invasion. This, apparently, is what the fungus is accomplishing in the Black Hills at this time.

Insects Are Rivals of Fire Most people do not realize the immense loss occasioned to forest trees and to wood in its various forms by insects. It is estimated by competent authorities that the finan-

cial loss through insect work is as great as that by fire; at least, as regards mature trees. Fire sweeps away the reproduction, and in this is not rivaled by the insects; but on grown trees their injuriousness is manifold. In the first place, they often kill single trees; and when bad outbreaks of single species of insects occur, as is often the case, they may even sweep away the living tree growth of considerable areas, as thoroughly as would a fire. The trees thus killed may, it is true, be used for many purposes, though not always for lumber. On the other hand, borers often penetrate far into the interior of the most valuable woods, reducing their value so largely that this must be taken into account as part of the loss above mentioned. Other insects consume wood even after it has been put to use.

A notable feature of pine woods where fires have swept through is the trees that have what are called fire wounds—that is, a portion of the base burned away. These are primarily due to insect attack. Certain insects bore in the bark or outer part of the tree, producing a gathering of resin, which is readily inflammable when the fire comes, while portions of the tree not thus prepared go uninjured.

The Bureau of Entomology has for several years been engaged in studying forest insects, and has found means to combat most of them with effectiveness.

Shipworms Advices from the Gray's
Ruin North- Harbor country on the
west Lumber Puget Sound and from various sections in the Puget Sound lumber districts report that logging operations may have to be suspended indefinitely because of the ravages of the teredo, or ship worm. The worms have attacked all the logs in the water and bored them full of holes.

In British Columbia, in the Clayoquot lumber district, operations have entirely ceased, owing to the ravages of the teredos. The worms have ruined all the year's cut of timber in the

water, and the big Sutton Company has reported a loss of over 16,000,000 feet. Hundreds of lumbermen have been forced into idleness until the winter's work in the woods begins.

Organization of Alabama Forestry Commission The State Forestry Commission, of Alabama, held its first meeting on January 8th, at Montgomery, and organized in accordance with the act providing for the advancement of forestry, passed by the Legislature last fall.

Governor Comer, who is a member of the Commission, called the meeting and acted as chairman ex-officio. Mr. John Wallace, Jr., whose record as State Game and Fish Commissioner makes him well fitted for the place, was elected secretary. The other members of the commission are J. A. Wilkinson, State Commissioner of Agriculture and Industries; J. B. Powell, of the State Tax Commission; Prof. R. S. Mackintosh, of the Alabama Polytechnic Institute; John L. Kaul, of Birmingham, Ala., the lumberman of the commission; and E. E. Carter, of the United States Forest Service. All were present except Mr. Kaul, who was unavoidably absent.

After some discussion of the bill, it was decided that a campaign of publicity, to instruct the people of the State in the benefits allowed them by the bill, should be undertaken, and a committee consisting of Mr. Wallace, Mr. Powell, and Mr. Wilkinson was appointed by the Governor, to collect data for distribution and to report to the Commission ways and means for conducting the campaign to the best possible advantage.

This meeting of the commission was chiefly for the purpose of organization, but sufficient was accomplished to show that the State Government is actively alive to the necessity for the conservation and improvement of forests within the State, and that much good may be done under the present bill. The result will undoubtedly be the awakening of the people of the

State to the value of forestry, and the ultimate appointment of a State Forester, in accordance with the practice already established in Georgia, Maryland, and many other States.

Professor of Forestry Colorado College has called Hugo A. Winkenwerder, of the Forest Service, to take the chair of forestry, formerly held by Prof. J. Fred Baker, and vacated by his removal to the Agricultural College of Michigan. Mr. Winkenwerder has accepted the position. Mr. Winkenwerder is a graduate of the Yale Forest School, and has been in charge of the section of education in the Forest Service. He is the author of the recently published circular on forestry in the public schools.

Professor Scott of Iowa At a recent meeting of the Board of Trustees of the Iowa State College, Mr. C. A. Scott of the United States Forest Service was elected to the chair of forestry to fill the vacancy caused by the resignation of Professor H. P. Baker. Mr. Scott is a graduate of the Kansas State Agricultural College and was a student of the Yale Forest School. Mr. Scott has been continuously in the employment of the Forest Service since graduation, and during this period of seven years has gradually advanced through all stages from student assistant to forest supervisor.

His work has been largely confined to the Middle West and the Rocky Mountain States; hence he has the advantage of being familiar with the forestry conditions of the Upper Mississippi Valley. Since their origin he has had charge of the extensive forest nurseries and plantings of the Dismal River National Forest. During the past three years he has given a special course of lectures before the Nebraska University forestry students.

Summer School of Forestry As a suggestion which may be helpful to other colleges in planning for the summer school work for next year,

the following account of work at Antioch College is given. The work is conducted by Prof. J. J. Crumley. It is outside of his regular department, which is Latin, but he is an enthusiastic forestry student, and is a collaborator of the State Experiment Station.

At the opening of the summer school at Antioch College, Yellow Springs, Ohio, Professor Crumley noticed an interest manifested in the subject of forestry, and organized a class, in which the interest increased as time went on.

They began with an external study of the trees on the college campus, about fifty varieties. Neighboring groves of catalpa and black locust gave opportunity for practical study; also a nursery of several thousand seedlings on the college grounds. The course ended with a minute examination of fences in the vicinity, bringing out the comparative durability of post timbers. They also studied the relative value of posts taken from different parts of the tree, the manner of setting, and the like. To the outdoor excursions visitors were invited. These were largely attended and were a very interesting feature.

Some of the members of the class said at the close of the term that they were going to continue the work in their home vicinities. The time has come when the teachers who attend summer schools are anxious to know more about trees, and this kind of work is a very practical method of awakening public interest in the subject of forestry.

Massachusetts Agricultural College The Massachusetts Agricultural College, at Amherst, has arranged a four years' undergraduate course in forestry. The work includes the following sections:

1. Nursery practice, dealing with the propagation, growing and transplanting of all sorts of trees.
2. Pruning.

3. Arboriculture, dealing with the identification and culture of trees and shrubs, including soil requirements, climatic adaptations, etc.

4. Tree diseases and tree surgery. An extensive and thorough course in modern methods.

5. Tree insects, their identification, habits and methods of control.

6. Forestry, covering the fundamental principles of forest management, taught by the Massachusetts State forester, Prof. F. William Rane.

7. Landscape gardening, teaching the proper use of trees, shrubs, etc.; for the most artistic effects. This is a thorough course, covering two full years, and includes surveying, mapping, contracting, etc.

To assist the students in their work the equipment of the college includes large nurseries, a fine arboretum, natural forest, drafting rooms, surveying instruments, and all necessary implements. There is no charge for tuition.

A Class in National Forest Management

A new and valuable addition to the curriculum of the Yale Forest School is a course of lectures to the senior class during the winter term on the National Forests, which is given by Mr. W. B. Greely, a graduate of the Yale Forest School in the class of 1904, and now Supervisor of the Sierra (South) National Forest. Mr. Greely is a Californian, and since graduating from the Forest School has been in the Government service, being one of the first technically trained men to be appointed supervisor of a forest.

The course will deal almost entirely with the actual administration of the National holdings of timber and range. Its aim will be to give the students of the school the point of view of the administration officer on the ground, and a grasp of the principles and methods followed in handling all of the more important kinds of National Forest business. Four lectures will be given weekly on the

policy of the National Forest administration, the organization of the administrative force, the construction of rangers' headquarters, roads, trails, bridges, and telephone lines, the protection of National Forests from fire, the sale and cutting of national timber, including a discussion of the forestry methods which have been found applicable, the administration of grazing lands and use of stock ranges within the National Forests, special uses of National Forest land for home building and commercial enterprises, tree planting on the National Forests, the handling of claims and entries under the public land laws, and the preparation of National Forest records and accounts.

Supplementary to the lectures there will be two hours a week of consultation between small groups of students and the instructor, by which the student will be given first-hand acquaintance with typical administrative cases and methods as in a forest supervisor's office.

In January Dr. Hermann von Schrenk, consulting timber engineer for the Atchison, Topeka and Santa Fe Railroad, and supervisor of timber preservation for the Chicago, Burlington and Quincy Railroad, gave, as in former years, a course of seven lectures on wood preservation at the Yale Forest School.

Children And Civic Betterment

Addressing the American Civic Association upon the progress of the civic betterment movement among the school children, Mrs. Edwin F. Moulton, of Warren, Ohio, president of the Woman's Outdoor Art League of the Association, said:

"Our public schools are doing effective work in raising the standard of manhood and womanhood, but we must look to them to educate the child more effectually in the ways of good citizenship. Junior civic leagues are a means to increased training in good citizenship. Lessons should be given in citizenship so that when the present-day boys and girls are become the

leading men and women of their community they will be qualified to stand for all that is best in civic righteousness.

"It is through the home and the school that the youth of our land shall be taught to promote and enlarge the cause for which this organization was initiated."

The forestry cause likewise can be advanced by the instruction of children. The nature and usefulness of trees can be brought in as a part of the nature study in schools, and also as geography.

Mr. Mills's Splendid Work Mr. Enos A. Mills, lecturer on forestry, has recently spent a few hours in Washington. His habitual modesty renders it difficult to secure from him adequate reports of his work. On earnest solicitation, however, he prepared, on the train, the following brief statement of the magnificent campaign he has been making in recent months. It will be read with interest by all friends of the great movement for the conservation of our resources:

MY DEAR DR. WILL:

During October, November, and December, 1907, and the first ten days of January, 1908, I visited sixteen States and made eighty-one forestry addresses. Among the States visited were Oregon, Georgia, Minnesota, and Missouri. Never have I found the interest in trees so general; the average attendance at the public meetings was 500, and the greater number of those attending were public-spirited people. One State fair was made, and it was a satisfaction to be able to address seven State Federations of Women's Clubs and the entire student bodies of seven State Colleges. I also addressed the high schools in St. Louis, St. Paul and Minneapolis. At Topeka, Kas., the city donated the use of the largest auditorium in the State, and enthusiastic members of the Forestry Association there almost

filled the building. At Louisville, Ky., I had one of my best audiences. The audiences in North Dakota, Oregon and Georgia were irrepressibly enthusiastic. There is a good and rapidly growing interest in Forestry. Never before, to me, has the hope for forestry been one half so encouraging.

Yours always,

ENOS A. MILLS.

Good Roads Urged by the Grange The National Grange, with nearly one million members, representing the agricultural interests of the Nation, has undertaken to secure recognition of the necessity for a comprehensive policy of public road improvements. The Grange favors a general policy of good road construction by municipalities, counties and states, and liberal appropriations by Congress to promote improvement. The Grange asserts that no argument can be advanced in favor of appropriations by Congress on behalf of river and harbor improvements that does not apply even more strongly to the improvement of our public roads. Mr. N. J. Bachelder, master of the National Grange, is a director of the American Forestry Association.

Finances of Roadside Trees Trees along the fences add to the beauty of a road, and furnish considerable wood; but objection is made to them because of the soil space that they take up, to the detriment of farm crops. They may be considered, however, as a valuable crop in themselves.

There is a stretch of five or six miles of the public road west of Downs, Kans., lined with trees on either side. Naturally, travelers, who can do so without going out of their way, select this road, and the trees lend additional value to the farms on which they stand.

Tall cottonwoods line the south side of Morris B. Thompson's farm. For one-half of the distance along a field a quarter of a mile long the trees are scattered. For the rest of the way

they stand close together and here, where thus sheltered from the south winds, corn yields six bushels more per acre than in the rest of the field. A county officer, who quotes Mr. Thompson on the figures of the increased yield, says that the different appearance of the sheltered portion of this field, compared with the other, is very noticeable. Six bushels per acre on fifteen acres increases the yield of the field by ninety bushels. This at 25 cents per bushel, amounting to \$22.50, much more than compensates for the loss of ground occupied by the trees, which are now approaching a size suitable for box boards and other purposes.

Paying Crop Found for Swamp Land The American Bottoms are a tract of low land on the Mississippi River, near St. Louis. The soil is rich, but the land is often flooded by the river. It is found, however, that the American Bottoms can be made to pay large profits, other than from crops of corn and wheat, and that in spite of floods. The crop for such a location is timber.

Mr. Frank Weber, Secretary of Forestry for the Argentine Republic, is in this country, and visited St. Louis a few days ago, says the *Globe Democrat*, to inquire about the American Bottoms experiment. Messrs. W. F. and F. G. Niedringhaus took him to Gabaret Island, just north of the city, where they have 100 acres planted in cottonwood trees, averaging 25 feet in height and 5 inches in diameter, and valued at \$20,000.

In 1903, just after the big flood had destroyed \$10,000 worth of crops on the island, they concluded to experiment in forestry; they planted 20,000 seedlings in three-foot squares, and have cultivated them since, with the result that the trees are now valued at \$20,000, and in three years more will double in value, despite any floods.

Cottonwood is very adaptable to

this sandy soil, and will grow better than willows, and at the rate of one inch per year.

Mr. Weber stated that vast plains in the Argentine Republic are similar in soil to Gabaret Island, and that he will report and recommend the planting of cottonwood on a vast scale, as he is satisfied from the experiment of the St. Louis parties that it will pay better in many places than farming.

Gabaret Island in the future will probably be given over to tree growth. J. C. Reintges is head forester.

Immense Number of Boxes The secretary of the National Box Manufacturers' Association has made the following estimate: Annual consumption of boxes in the United States, 600,000,000. Net feet of lumber in same, 3,000,000,000; selling value of boxes, \$75,000,000.

Mr. Wm. B. Mershon, of the Michigan Forest Investigation Commission, estimates that the waste in making boxes would raise the feet of lumber used to nearly half a million more. He adds that the immense demand for boxes made the fortunes of several manufacturers in the Saginaw valley of Michigan.

Planting Thousands of Pine Seeds Mr. Mershon is giving practical application to his position as a promoter of reforestation in Michigan. He and some associates have acquired 1,600 acres of land along the Au Sable River, which is being prepared for planting to pines next spring. They have purchased 65,000 pine seedlings for delivery prior to May 1 next; also 250 pounds of white pine seed and 25 pounds of Norway pine seed. There are 70,000 seeds to a pound of Norway pine, and it is calculated it will require thirty to forty years to grow trees large enough to be utilized for timber.

DESOLATION IN DALMATIA

A Letter from Europe

BY

Florence Keen, of Philadelphia, Pa.

MY interest in forests was first awakened by meeting some foresters in Germany, many years ago, and since then it has continually increased.

If you could see the desolation I have lately seen, you would be heart sick for poor Dalmatia. That country was once one of the richest of the Roman provinces, and during the reign of Diocletian, who had an immense palace there, it supported a large population.

When it came into the hands of the Venetian Republic the trees on its fine mountain slopes were ruthlessly sacrificed for the ships of the conquerors, the soil washed away, the springs and rivers dried up; and even Syria in its desolation does not compare with it.

The attempts at cultivation by the peasants are pitiful. As far as possible they collect the rocks and stones in great mounds on the least desirable ground of the tiny field, and where they can find among the remaining rocks earth enough for the roots of one olive tree or even one grape vine, it is planted. The chief impression, even then, is of a most successful crop of rocks and stones. One of the best fields of grape vines I saw has the appearance of a pebbly beach. In that neighborhood a whole family may live for a year on the product of only one olive tree—so poor are they.

After the loss of the trees arose a terrible wind called the "bora," which

blows a cutting blast for many months of the year, and renders reforestation almost impossible. Stories are told of its overturning railroad trains, and I was even told that women had to creep to market on all fours. When I looked incredulous my informant insisted it was actually true. Having experienced a *mild* bora, I think I can believe it. You can drive for miles in any direction and not see ten trees naturally grown. These statements apply to the northern portion of Dalmatia; further south, the bora is not so strong, and cultivation is a trifle easier—but there is no substantial difference.

Montenegro is about the same. There the country is such a mass of mountains, and the hills are so steep, that the earth washed down the hill sides seems to have settled in little potholes and gradually formed a space large enough to cultivate—that is, the size of an ordinary dining-table. The livelihood and existence of the poor peasant can be better imagined than described.

From my observation in Italy, I should say that country is well on the road to the same ruin as Dalmatia; but they are trying now to rescue it. They have a State Director of Forestry. At present anyone's eyes can see the bareness of the Appenines, and the muddy rivers, the small size and high price of firewood, the total absence of wooden houses, and the various makeshifts employed in place of wood.



A LETTER TO OUR MEMBERS

On December 18th the following letter was addressed to the members of the American Forestry Association by the Secretary:

The year just closing has been one of great activity for the Association. The magazine, FORESTRY AND IRRIGATION, has been purchased and materially improved. Weekly press bulletins have, since July 1st, gone to fifteen hundred newspapers; 118,937 circular letters and 125,437 folders have been distributed. The Secretary has delivered 37 addresses in 12 States, and 1,647 new members have been added to our rolls.

The forest problem is far-reaching. Through timber supply alone it affects the welfare of the whole Nation. As the following testimonies show, it underlies the problems of irrigation, drainage, soil conservation, control and use of rivers and the safeguarding of the public health.

The Message

We have made a beginning in forest preservation, but . . . only a beginning . . . The country is unquestionably on the verge of a timber famine . . . The only trouble with the movement for the preservation of our forests is that it has not gone nearly far enough, and was not begun soon enough. It is a most fortunate thing, however, that we began it when we did. We should acquire in the Appalachian and White Mountain regions all the forest lands that it is possible to acquire for the use of the Nation. These lands, because they form a National asset, are as emphatically National as the rivers which they feed, and which flow through so many States before they reach the ocean.

THEODORE ROOSEVELT,

President.

Forest Destruction

Under present policies of use and waste, the timber supply of the

United States will last probably from twenty to thirty-three years.

When the forests fail, the lumber business, now the fourth greatest industry in the country, will, of course, disappear. Suffering among all building industries will immediately follow; mining will become greatly more expensive; then naturally the price of coal, iron, and all other minerals will rise; by this the railroads will be directly affected and the cost of transportation and water power for lighting, manufacturing and transportation will immediately increase. All goods made from products of the mines will increase in price, which will hamper, not only agriculture, but the cost of production generally. In fine, when the forests fail, every man, woman and child in the United States will feel the pinch. And through misuse the forests are failing rapidly.

GIFFORD PINCHOT, *Forester.*

Redeeming the Desert

In six years the Government has reclaimed 250,000 acres, upon which are now living 20,000 people, representing 4,000 families. It is a reasonable estimate that, in another decade, 2,000,000 more acres may be reclaimed, upon which 250,000 more human beings may maintain themselves in reasonable comfort.

The water for this work comes chiefly from streams rising in mountains. To maintain the supply of this water, it is essential that forests be maintained upon these mountains. To this end, National Forests are indispensable.

F. H. NEWELL, *Director,*
U. S. Reclamation Service.

Saving the Soil

The waterways of the United States annually sweep from land to sea a billion tons of earth. Of this, ninety per cent. is chiefly soil matter. In weight it is comparable with the total tonnage of all our railroads and river and lake vessels. Its bulk is one-fifth of a cubic mile; it equals a

block one mile square and over a thousand feet high. Applied as a fertilizer it would cover, to the depth of a quarter of an inch, an area of about 340,000 square miles, or the land surface of all the Atlantic States from Maine to South Carolina inclusive, with Vermont, New York, Pennsylvania, West Virginia and one-third of Georgia thrown in. Its value may be estimated as at least a billion dollars. Its loss is the heaviest impost borne by the American farmer.

This soil waste is sapping a resource richer than all others combined save one, namely, our inland waters. These, immeasurably our richest resource, are, in great measure, perverted from a blessing into a curse. And both soil wash and river ravage are largely to be traced to the absence of forests from slopes on which rivers rise.

W. J. M'GEE,

*U. S. Inland Waterways Commission
and Bureau of Soils.*

Utilizing the Rivers

Our inland waters are our greatest natural resource. The water flowing down our Western mountains far exceeds in value the fabulous wealth represented by all the metals and minerals lying between the Rockies and the Pacific.

To-day most of this resource is wasted. Each year, at least 1,600,000 h. p. runs over Federal Government dams. Rented at twenty dollars per h. p. this would yield \$32,000,000. Capitalized at three per cent., it represents an investment of \$1,066,000,000, now wholly wasted.

Further, uncontrolled water is a curse. Flood damage in the United States exceeds \$100,000,000 per year. With our water controlled and utilized, this sum might be saved and a five-fold greater value produced.

From lack of plan present efforts toward control are largely futile and wasteful.

Our rivers should be controlled in much the same manner that we con-

trol city water. A plan is essential. It must provide for Federal action, and it must infallibly include the conservation of forests upon the slopes on which rise important streams.

M. O. LEIGHTON,
*Chief Hydrographer, U. S. Geological
Survey.*

Where streams are subject to severe droughts or great floods, commercial development is practically impossible. Nature has provided for the uniformity of flow by covering the watersheds at the headwaters of these streams with forests. . . . When these forests are cut off, conditions are entirely changed, and great freshets result.

CHARLES A. STONE,
*Of Stone and Webster, Electrical En-
gineers.*

I have known the Connecticut for over thirty-six years. It drains an area of over four thousand square miles. Until recently the wooded hills kept the flow of the river even. Now, in the spring, we have floods, while in the summer the water sometimes will not run our mills.

THEOPHILUS PARSONS,
New England Manufacturer.

French Experience

It is an absolute principle: no forests, no waterways. Without forests regulating the distribution of waters, rainfalls are at once carried to the sea, hurried sometimes, alas! across the country. After having devastated the neighboring fields, the rivers find themselves again, with little water and much sand; and with such rivers, how will you fill your canals? . . . The question is as clear as can be: Do you want to have navigable rivers, or do you prefer to have torrents that will destroy your crops and never bear a boat? If you prefer the first, then mind your forests. We can tell you, for we know. . . .

If the Mississippi is the "Father

of Waters," the forest is the father of the Mississippi.

J. J. JUSSEKAND,
Ambassador from France.

**Public
Health**

The destruction of our forests . . . robs our people of a great health-giving influence. The heavily-timbered White Mountains have long been a resort in which the tired and jaded might obtain rest and refreshment. . . . These regions will become increasingly a resort for the growing population of the great Middle West as well as New England, unless despoiled by the selfish, short-sighted spirit of commercialism now so rampant.

VINCENT Y. BOWDITCH,
Boston Physician.

**China's
Woe**

Large areas of northern China have been rendered uninhabitable in consequence of deforestation, the hills being reduced to rocky skeletons and the valleys being filled with coarse sand and gravel.

Throughout northern China the

floods which have caused the Yellow River to receive the name "The Grief of China" are an immediate result of the deforested condition of the hills and the consequent rapid run-off of the spring and summer rains.

The conditions resulting from deforestation cited in the two preceding statements add greatly to the severity of famines, since they very greatly reduce the productive area and occasion the failure of crops in flooded regions.

BAILEY WILLIS,
U. S. Geological Survey, and Carnegie Institute.

Let every member of the Association continue his membership and if possible, advance it to a higher rank. Let him enlist at least one new member, or present a membership to a friend as a Christmas gift. Let him write to his Congressman to press the Appalachian Bill, and let him attend, if possible, the annual meeting and aid, by presence and voice, in promoting the work of conserving, for the highest use of all the people for all time, our forests and the vital interests with which they are so intimately joined.

DESECRATION

By Harold Trowbridge Pulsifer

The solitary stillness of the wood,
The long deep silence of the morning calm,
The melody that nature understood
When all the world lay cradled in His arm;
The solemn incense of the fragrant pine,
The half-heard music of a hidden choir,
The rhythm of a chant almost divine,
Sung underneath the starry altar-fire—
Has ended in the sullen sounding blows
Of crashing steel along the wooded aisle,
In blackened stumps above the winter snows,
In land that has forgotten how to smile;
A desert where the north wind sighing sweeps
Above the tomb in which the forest sleeps.

From *The Outlook* of April 6, 1907

NATIONAL FORESTS AND PUBLIC OPINION*

BY

Lydia Adams-Williams, of Washington, D. C.

THE policy of President Roosevelt is to give to all questions, national and international, the fullest measure of publicity.

Any project, public or private, which will not bear discussion is not worthy of the earnest consideration of the thoughtful and conservative.

During the last, the 59th, term of our National Congress, the searchlight of thorough investigation and of public opinion was turned upon all the branches and operations of the National Forest policy of the Government, as exemplified in the Forest Service.

What was the result? Was this policy of the Government injured, impaired, or crippled in any way by the fierce attack and by the publicity given all its motives and workings?

On the contrary, the Government forest policy rose triumphant and unscathed from the fierce onslaught made upon it.

The contest raised unexpected friends. Unlooked-for and powerful influences developed from unthought-of sources; old and valued adherents and advocates redoubled their zeal in its defense.

So far from injuring the National Forest policy, the debate and the publicity resulted in educating the reading public to the wisdom, value and necessity of the present policy, and its beneficent workings.

As the logical result, \$500,000 was granted the Service for permanent improvements; \$1,900,000 for administrative expenditures; and the balance of the special fund, \$600,000, was left at the disposal of the Service; thus making the available resources of the Forest Service for the year ending

June 30, 1908, over \$3,000,000.

Feeling that a further expression of public opinion would be helpful to the far-reaching and incalculably valuable forest policy of the Government and the proposed Appalachian and White Mountain National Forests, and that it would further tend to educate on these important subjects, the writer endeavored, by letter, to get an expression of opinion from people of prominence whose ideas mold public sentiment.

I regret to say that there was not time to reach many whose opinions would have been most valuable; also that many to whom I wrote were away; and that replies from many others could not reach me in time for incorporation in this paper.

Still I was able to get opinions from several, and will submit them here.

The attitude of President Roosevelt on the broad questions of forestry and irrigation is well known, as he has proclaimed his views again and again in messages and addresses. He recently said:

"If ever the time should come when the Western forests are destroyed, there will disappear with them the prosperity of the stockman, the miner, the lumberman, and the railroads, and, most important of all, the small ranchman, who cultivates his own land."

Vice-President Fairbanks has repeatedly affirmed his life-long belief in the feasibility of the irrigation and forest policies as now carried on by the Government, and he recently said:

"The rapid increase of population

*Address before the Fifteenth National Irrigation Congress, at Sacramento, California.

and the pre-emption and settlement of the arable portions of the public lands have rendered it important that we should reclaim the waste places and make them productive through a wise irrigation system which lies beyond the capacity of individual effort."

Ex-Gov. Geo. C. Pardee, of California, sums up the problem of reforestation as follows:

"The natural storage reservoirs, from which the now arid country once received its moisture, lay beneath the forests that once covered the now naked mountains. These forests should be restored."

Continuing, he adds: "Thanks to President Roosevelt and Gifford Pinchot, the head of the U. S. Forest Service, both of whom are true and loyal friends to California, the Government of the United States is doing much to solve these problems that confront us."

J. O. Davidson, Governor of Wisconsin, is heartily in favor of National Forests, and testifies as follows:

"I am pleased to advise you that I am always glad to do what I can to assist the cause of forestry, both State and National, believing that the protection and proper use of the forests is one of the most important questions which confront us to-day. I am heartily in favor of the President's policy in creating National Forests, as they mean timber for the settlers now and in the future, and the protection of those streams which are all-important to the people of the West. The remaining forests in the Appalachian and White Mountains should be conserved, and I trust that Congress will appropriate the money for their purchase."

To President Benjamin Ide Wheeler, the distinguished head of the University of California, we are indebted for this splendid and convincing testimony:

"In my opinion, the present forest

policy of the Government represents, in the highest degree, beneficence toward all interests, and peculiarly to the rights of the American people as a whole. We are having an example of the excellent influence of the present rules of our Forestry Bureau in the treatment of the forests in the northern portion of this State. There we have learned that the purpose of forestry is not crudely to preserve forests by forbidding the cutting of trees, but to encourage the proper cutting of trees so that forests may renew themselves. The McCloud Lumber Company, of McCloud, near Mt. Shasta, is now doing all of its cutting under the direction of the Bureau of Forestry, with results satisfactory to it and highly beneficial to the country. None of the good things that have come to pass under President Roosevelt's administration will redound more to his credit than the development of the Bureau of Forestry and the extension of its influence and authority. With this will rank, I am satisfied, when the years unfold their result, the beneficent workings of the National Irrigation Law."

The Governor of Utah, John C. Cutler, endorses the National Forest policy of the Government in the following convincing statement:

"I am strongly in favor of the National Forest policy of the Government. The preservation of the forests, the conservation of water, and the transmission of an adequate timber supply and consequent wealth to coming generations demand the enforcement of this policy. Opposition to it is usually based on short sighted misunderstanding, or selfishness. In the interest of the bona fide settler and honest home-maker, the Government should maintain the National Forests already created and establish others where necessary."

From Charleston, South Carolina, comes the following from Attorney Augustine T. Smythe, which is especially interesting in that it gives a

phase of the National Forest question, with which Western debaters of this question are often unfamiliar. Mr. Smythe says:

"In the Carolinas and Georgia, there is invested in cotton mills, run by water power alone, over \$40,000,000. The horse-power utilized is almost 106,000. The spindles turned number approximately 2,800,000. They consume annually nearly 900,000 bales of cotton, worth when manufactured over \$70,000,000. The hands employed number 60,000. Counting families, 240,000 people are dependent upon these mills. This vast industry faces destruction. The cutting of the Appalachian forest means its end. A National Forest Reserve in the Appalachian is the only salvation."

From Mrs. Sarah S. Platt Decker, president of the General Federation of Women's Clubs, with its thousands of active working women members, in every State in the Union, comes this cheering message:

"I hope the Appalachian and White Mountain Reserve Bill will be mentioned at every forestry meeting all over the country, in every woman's club and at every State Federation, and that interest will be aroused to such an extent that its passage will be assured. From my observation, the preservation of the forests, the streams and the agricultural interests can be successfully accomplished, only by the purchase and creation of National Forests."

Senator Beveridge, who made an eloquent and impassioned defense of the National Forest Service, during the Senate debate, says:

"Unless the forests in those mountains are conserved irrigation is impossible. Because if the forests are felled, the rain which falls in equal abundance sweeps down in torrential floods and either takes away the reservoirs or fills them up with silt. So the basis of the whole irrigation sys-

tem, which means so much to the Western country, and therefore, to the whole country, rests upon the foundation of the National Forest system."

Mr. F. H. Newell, Director of the Reclamation Service, has repeatedly emphasized the very great importance of National Forests in connection with the Government's irrigation work. He says:

"The future of these reclamation projects is dependent largely upon the keeping of the forest areas in good condition. All of these rivers whose waters are to be utilized issue from forests. We are vitally interested in the preservation and proper control of the National Forests."

Governor E. W. Hoch, of Kansas, sends this pleasing message:

"I am in hearty sympathy, as every one must be who gives the subject thought, with the awakening interest in the forestry question. The rapidity with which our timber lands are being denuded purely for speculative purposes threatens to become a National calamity, if it is not already one. In older countries, the value of trees is recognized in laws for their protection, but with that prodigality which ever characterizes those richly endowed, we have seemingly had no care concerning the future of our forests. It is an omen of great good, however, that we are awakening to a realization of the great importance of this subject, that people are wisely discussing it, and that the National Government is taking a hand in the solution of the problem."

Governor E. C. Stokes, of New Jersey, gives his opinion as follows:

"The advantage of forest reserves, both State and National, needs no defense. The distribution of rainfall, the necessity for additional timber, and the need of grounds for recreation purposes, all demand careful and scientific development of our forests."

I am authorized to state that Governor Harris, of Ohio, is in favor of any practical method of restoring and preserving our forests, whether by private enterprise or Government appropriation.

Governor James H. Higgins, of Rhode Island, gives this endorsement:

"Under present conditions, I am heartily in favor of a bill substantially similar, or looking to the same end, as that presented in the last Congress, concerning the Appalachian and White Mountain Reserves."

From Senator F. E. Warren, of Wyoming, I am pleased to present the following:

"The forests of our country form one of its valuable assets. It is good business and governmental policy to conserve this asset by providing as far as possible against all forms of depreciation, whether by fire, reckless use for commercial purposes, or acquisition by speculators. At the same time the people should not be deprived of the necessary and reasonable use of the products of the public forests for home-building, fencing, mining, road-making, and all similar beneficial uses incidental to the growth and settlement of a new country. Intelligent supervision of the use and care of forests by Federal or State officers, or both acting in co-operation, working under legislative authority, with a view to the fullest utilization and proper conservation of their products, in my opinion, would be an ideal condition. To aid in bringing this about would be a worthy act on the part of every citizen desirous of promoting the general welfare of the country."

Governor F. M. Ausel, of South Carolina, says:

"I feel very great interest in the Appalachian National Forest, which is the one nearest to us; and I am also interested in the White Mountain National Forest. I hope Congress may soon pass an act providing for these forest reserves, and that the will of

the people may be carried out. They will be of great benefit to the entire country. The old song I used to hear when a boy, "Woodman, spare that tree, touch not a single bough," does not seem to be the order of the day, and unless we can get these reservations it will not be a great many years before our great forests will be things of the past."

Mrs. Ellen S. Cromwell, president of the Women's National Press Association, and secretary of the Federation of Women's Clubs for the District of Columbia, says:

"There is no subject of more vital importance and interest to the present and coming generation than those of irrigation and the preservation of the forests."

The following "straight from the shoulder" statement is from Curtis Guild, Jr., Governor of the great Commonwealth of Massachusetts:

"I have steadily urged with all the strength that is in me National protection of the Appalachian and White Mountain Forest Reserves. Massachusetts has been officially represented in every delegation that has waited upon Congress on this subject. We do not grudge the Western States their much needed irrigation system. Indeed, though not a conspicuous feature of the Roosevelt Administration, I believe that the reclamation of the alkali deserts of the West is likely to remain with the Panama Canal as the two most durable monuments left for the increase of human happiness.

"We in the East believe that we should in similar fashion receive the support of the West in our attempt for the protection and preservation of the Eastern water powers and water supply. This is not a sectional question, but a National question, and should be treated in the National spirit, in which Nevada and Massachusetts should strive, not for their own advantage at the expense of each other, but for the common advantage by mutual help."

HEARING ON THE APPALACHIAN BILL

The Committee on Agriculture of the House of Representatives has granted a hearing on the Appalachian-White Mountain bill, to take place at the rooms of the committee, at ten o'clock A. M., Thursday, January 30, and to continue, if desired, on the 31st.

The importance of this hearing can hardly be over-estimated. The Appalachian bill has repeatedly passed the Senate, and will, undoubtedly, again pass that body at this session. The failure of the bill has uniformly occurred in the House; and this, not from an adverse vote in that body, for a safe majority of the House is believed to have been favorable to it, but from the failure of the bill to reach a vote.

Late in the first session of the 59th Congress, the Appalachian bill was granted a hearing before the Committee on Agriculture of the House of Representatives. A strong presentation was made, and the bill was unanimously recommended by the Committee for passage. It was not reached in the first session and the brevity of the second session prevented its reaching a vote unless "the extraordinary powers of the House should be invoked." Such action the Committee on Rules did not see fit to take.

With an early and favorable report, however, from the Committee on Agriculture, it seems probable that the bill can be brought to a vote in the House in the present long session. And again, as heretofore, there is good ground to hope that, if reached, it will pass. In the circumstances, an early and favorable report by the Committee becomes of transcendent importance.

The friends of the measure are sparing no effort to secure a strong and representative delegation to attend the hearing and present to the Committee every aspect of the case for the bill. Numerous Governors of States, North

and South, together with the foremost citizens in public and private life, are expected to be present and to furnish infallible proofs of the constitutionality, wisdom, and necessity of the legislation. There will undoubtedly be representatives from all Eastern and Southern States, and the indications are that the attendance will run into the hundreds.

Experience has shown that the press of the country is practically a unit for this legislation. It can now render a notable service by widely announcing this hearing, and urging the importance of such a representation as shall not fail to be heard and heeded.

What New England Is Doing

The interest of New England in the Appalachian bill has been keen from the start. Everything that could be done to secure the passage of the bill in the last Congress was done. The result was that when the matter came to a vote, last spring, near the close of the session, not a single New England Congressman voted against the proposition for a survey. Within a month after the adjournment of Congress a meeting had been called in Boston to lay plans for furthering the campaign. Definite plans were made for co-operation between the Massachusetts Forestry Association, the Society for the Protection of New Hampshire Forests, the Appalachian Mountain Club, and the American Forestry Association. During the past season's investigations these organizations have helped in every way possible.

As soon as the Committee on Agriculture announced that a hearing would be given on the 30th, meetings were immediately arranged in Boston to plan a campaign. The several organizations are working with might and main, and with good prospects of success, to secure the attendance of all the New England Governors and of

the leading business men. On January 10th a notable conference was held by representatives of the great textile mills of New England for the purpose of taking some effective action with regard to the bill now in Congress. Ex-Governor Rollins, of New Hampshire, presided, and the meeting was attended by the ablest business men among the textile manufacturers. The result was the appointment of committees to work in the most effective way to secure a proper representation of business men at the conference on the 30th.

Great Activity in the South Never before has such profound and widespread interest in this measure existed in the South. From the organization of the Appalachian National Forest Association, early in the winter, not a day has passed but that many Southern papers have given large attention to the need of preserving the forests of the Southern Mountains. No subject of general National interest is to-day receiving more intelligent consideration in the South than that of the proposed National Forest. Many strong articles have appeared by writers who speak with authority on the various phases of the question. Hundreds of editorials have been published in Southern papers during the past month. At this writing, January 16th, there is being held in Atlanta, Ga., under the auspices of the above-named association, the American Institute of Electrical Engineers, and the Georgia Federation of Women's Clubs, a great forestry mass meeting. This meeting is presided over by Governor Smith, and has as one of its representatives Governor Glenn, of North Carolina. All phases of the National Forest question are being discussed, and one result will be to secure the attendance of the Governors of various Southern States and of the leading business men of the South at the hearing in Washington on the 30th. As a result of this meeting it is expected that the ablest men of the South will

be in attendance, and that the number coming will reach into the hundreds.

Help From Other Sources During the fight in the last Congress New England and the South stood side by side, but now help is coming from other sources. First among the new sources of aid is the American Civic Association, which has called an executive meeting in Washington on the 30th, to aid in connection with the hearing. A large representation of the members of the Civic Association will be here. The magnificent and effective fight made by this organization to save Niagara from total devastation by water power companies will be remembered. This Association expects during the coming year to make the Appalachian-White Mountain National Forest Bill one of its main objects of attention. But other help is coming as well. The American Institute of Electrical Engineers will be represented. The members of the Institute know well the damage resulting to water power from clearing away the forests on the mountain slopes.

Within the last year it has been found how terrible is the effect of clearing the forests from the high watershed of the Monongahela River. The city of Pittsburg and other cities on the river have suffered disastrous floods, sustaining losses of almost ten million dollars. On the recommendation of the Pittsburg Chamber of Commerce the Secretary of Agriculture has included in his recommendation of the area receiving attention, the Monongahela watershed. The Chamber of Commerce will be well represented at the hearing. In addition, it is likely that other cities, afflicted by this river, will have delegates at the hearing.

The American Association for the Advancement of Science, the organization which worked with the American Forestry Association for the bill providing for the first forest reserves in the West, will likewise be represented by a special committee, headed

by Dr. R. S. Woodward, of the Carnegie Institution. The Association of State University Presidents has, during the past few months, been doing notable service in corresponding with Congressmen of their respective States on the vital importance of extending the National Forest system to the Eastern States. It is probable that a

special committee will represent this Association. The list of organizations which in one way or another are aiding in the movement is too long to mention. Many of them will have representatives present on the 30th to help emphasize before the Committee the great importance of the bill.

THE TEMPLES EAST AND WEST

By The Lumberman Poet

The temples of the East arise upon her ancient shores,
But hunger, gaunt and haggard, lies beside their open doors.
The bells of even call to prayer when torrid day is done,
But paupers pray for regions where death comes not with the sun.

The temples of the Eastland gleam with gilded peak and spire
Until the polished structures seem great monuments of fire.
But they who madly stretch to Buddh their supplicating hands
Leave naked footprints, done in blood, imprinted on the sands.

The artisans have builded well the temples of the East—
With sign, design and capital their mystery increased.
The arching doorways are engraved with names of gods divine,
And yet the god-forgotten slaved to rear the godly shrine.

The temples of the West look down upon the azure seas;
No sick and weary famine town looks sadly up to these.
No gilded dome reflects the sun on eyes with sunlight blind,
Or sinks from sight, when day is done, while death steals up behind.

The temples of the Westland gleam as gleam the Eastern spires
But wear the colors of a dream, the sunset's tender fires.
The gilt upon their shining towers is like the rainbow's glow;
It changes with the changing hours, while sunsets come and go.

And never in the Orient such pillars rise as these;
Such beauties never there are blent in wall and roof and frieze—
For never by the ancient shore where gilt pagodas rise
Upon emblazoned temples pour such lights of paradise.

The temples of the Westland lift their pillars to the sky
While ships of vapor slowly drift in stately splendor by.
The temples of the Westland rise from out the Westland soil.
Reared not by skill of weeping eyes or hopeless hands of toil.

O, temples of the East, your gods much tribute have required—
The birth and life and death of clods, to rear you many-spined.
The temples of the West were made by neither toil nor pelf—
The God who dwells within their shade has builded them Himself.

Ring out, you bells of temples East; you call me less than these
That spread their sweet communion feast beneath the Westward trees.
Ring forth upon the sultry air when dying day is dim;
I hear another call to prayer—the forest's mighty hymn.

I stand before an open door, a temple in the West.
I hear the music on the shore of waves that sink to rest.
Above me mount the Westland firs; their incense rises pure.
O gilded Eastward sepulchers, my soul you cannot lure.

—The American Lumberman.

FOREST PERPETUATION AND WATER SUPPLIES

IN an article in the *Manufacturers' Record* for January 2, on Forest Perpetuation in its Relation to Southern Water Powers. Mr. John H. Finney, associate member of the American Institute of Electrical Engineers, says:

"A prominent Southern engineer, Mr. W. S. Lee, estimates that deforestation already done has cut down the capacity of our streams not less than 40 per cent. This is entirely due to the longer and more damaging flood periods, which have necessitated excessive costs for dams sufficiently heavy to withstand them, besides giving longer drought periods, decreasing enormously at such times the minimum flow of the river, on which without artificial reservoir capacity, the power development must be based

"When one considers the splendid contribution to the industrial South that has been made by its power plants and the economic value which they mean to our mills and manufacturing interests, which value grows more important and far-reaching each year, as coal becomes scarcer and dearer, one can get some idea of the importance of forests to these industries, and, through them, to the entire South.

"Apart from the menace to our water powers, there exists, through the same causes, a very real danger to the water supply of our cities and towns, from the standpoint of both quantity and quality; our streams are not naturally silt-bearing, but their condition and appearance now, contrasted with their condition a short ten



Dam filled with silt, in the Tonto Basin, Arizona—Tonto National Forest will prevent such occurrences in future

See Forest Service Department in this magazine

years ago, presents a marked change. Ten years ago they were clear, and remarkably free from sand and debris; now they are full of sand, silt, detritus, and washings, which have filled up the channels, and which increase enormously the expense and dif-

ficulty of purification, so that many cities now face not only a shortage of water during the rapidly lengthening drought periods, but unknown dangers in what they do get. As an example, the City Engineer of Augusta, Ga., states that their power canal



Forest scene in the Southern Appalachians—Little opportunity for swift rush of water

has received more silt and sand in the past eighteen months than in all the thirty years previously.

"If this is the case with 20 per cent. of the forests gone, what will be the plight of Augusta and other cities similarly situated when the remaining 80 per cent. of forests are cut?"

"This sand and debris, after filling the upper portions of our streams, finally washes to the slower waters of the navigable portions, and is swiftly filling them up, making navigation dangerous, if not impossible, and making dredging operations necessary on a large, and ever-growing larger, scale each year.

"It can be safely stated that the amount which will in the near future have to be paid in one year for dredging, jetties, harbor work, etc., in our Southern States, would pay the total cost of a National Forest area that would remedy the trouble for all time. Surely, at this time, when our transportation facilities are manifestly inadequate; when our entire country is calling for and insisting on the relief that canals and improved waterways only can afford; when large appropriations for these purposes must be made; it is well to call attention to the only effective remedy for curing the disease

by going direct to the seat of the trouble.

"This is not a sectional matter, but is of National importance, the necessity for action on which has been seen and urged by clear headed men in all sections of our country. The baneful effects are too apparent to be longer ignored. The increased flood damage each year at important points, such as Cincinnati, Pittsburg and other Northern cities, is as directly traceable to deforestation as are our flood damages here, and self-interest on the part of ourselves and our statesmen, if no stronger or more patriotic motive exists, should demand that the remedy be applied.

"This remedy is forest preservation, or, as better expressed, forest perpetuation, under the care and guidance of the National Government."

Mr. Finney estimates the amount of power that could be developed on the streams having their source in the Southern Appalachian region, at between 3,000,000 and 4,000,000 horse-power. Three million horse-power, if developed, would mean an investment in hydro-electric plants of upwards of \$300,000,000, earning annually \$60,000,000, at a conservative estimate, and saving the South on its coal bill alone over \$15,000,000.

THE PEACE OF QUIET AISLES

By Jane Taaffe

Fell on my soul the calm of twilight woods,
 The peace of quiet aisles
 Where ancient trees in solemn, cloistered files,
 Muse on dim ages past—
 Eternity of silence, dreamless, deep!
 Roses of mornings fled!
 Vistas of evenings gay, with roses dead!

When comes for me the call
 At eventide, may folding shadows fall!
 The calm of twilight woods!
 The peace of quiet aisles!

From *Appleton's Magazine* for December, 1907

WORK OF THE MINNESOTA FOREST SCHOOL AT ITASCA PARK

BY

E. G. Cheyney, Assistant Professor of Forestry, University of Minnesota

THE 1907 legislature of Minnesota showed its belief in the usefulness and the future development of forestry by providing the State Forestry School with an ideal tract of forest as a demonstration ground. This was accomplished by transferring Itasca State Park from the control of a special committee to that of the State Forestry Board, where it naturally belonged, and at the same time granting to the board of regents of the University permission to establish thereon a demonstration school of forestry.

Itasca Park, situated in the beautiful lake region of Minnesota, and enclosing the headwaters of the Mississippi, is about as nearly an ideal spot for such a purpose as could be found—still perfectly wild, with the forest and all its denizens in the primeval state, and yet near enough to civilization to be fairly accessible. These are the natural factors necessary to success.

The general shape of the park is a rectangle, stretching five miles east and west, and seven miles from north to south. Within this area are included something like three hundred lakes, of all sizes and descriptions. Most of them are too small to deserve the name, but there are a few good sized and beautiful lakes.

The largest and most important of these is Itasca itself, with its three arms spreading north, east and west; the shore in many places running up abruptly into high, heavily timbered hills, in others sinking away into waving grass marshes, or bright tamarac swamps. Countless springs pour their waters into this lake and from the end of the North Arm, through a screen of reeds, which renders the opening almost invisible, flows the modest beginning of the Father of Waters.

Ascending a narrow creek at the

south end of the West Arm for a few rods, one gets a beautiful view of Elk Lake, the great pike lake of the park, and more especially noted for the beautiful springs which flow into it—a stream three inches in diameter, charged heavily with bicarbonate of iron. This, together with Itasca, is the only lake easily accessible from the Lodge, and consequently is the best known and most frequently visited. There are, however, several others back further in the woods quite as large and even more attractive.

Along the shores of these numerous lakes, on the ridges and in the valleys between them, are found every type of forest peculiar to the northern woods of the Lake States—white and Norway pine mixtures on the ridges, jack pine on the pure sand patches, spruce and balsam in the drier swamps, tamarac and cedar in the moister locations, hardwoods where the quality of the soil will support them. The opportunities for the study of all kinds of silvicultural and managerial problems are almost unlimited.

Besides these natural advantages, man has put in some improvements which will help in the establishment of a school. At the south end of the East Arm of Lake Itasca the State has built a large, two-story log structure, forty by eighty feet, of peeled and oiled Norways, which is known as Douglas Lodge and is used as a summer hotel. It stands in a thick grove of five log Norways on the edge of a steep bank some fifty feet above the Lake. This offers an opportunity of comfortably housing the students engaged in seeding and planting work, before the summer season opens and before camp life in this neighborhood is very pleasant.

Three miles north of the Lodge, on



Good stand of Norway pine, Itasca State Park

the east shore of the East Arm, is an eleven room frame house, formerly the home of the Park Commission, which is now the home of the forest school. It is to be used as a general assembly hall, the students being quartered in tents entirely.

The park was transferred to the control of the Forestry Board in April and made a forest reserve. Active measures were immediately started for its care and management, and

parts of the park were cleaned, and roads repaired; boats were built, a nursery site cleared, and many other minor details put through. The most important work of the summer was the making of a firebreak around the boundaries of the park. This break consists of a strip two rods wide from which all the brush has been cleared and all the trees below four inches in diameter taken out. The brush was carefully piled in the centre of the



Douglas Lodge, Itasca State Park, Minnesota

in June a party of sixteen students, from the State Forestry School, were sent to the park to work out a scheme of protection. They made their headquarters in the frame building, and put in temporary camps in different parts of the park, where they would be most conveniently located for their work.

The grounds and lake shore near the house were worked over and put in good condition; trails to different

strip and burned, under suitable weather conditions. Nine and a half miles of this line were cleared during the summer. Lack of time and labor prevented the completion of the work. It is planned to ditch this firebreak with a shallow three-foot ditch—just exposing the mineral soil—the dirt from which is to be spread over a three foot border just outside the ditch. In some places a plow can be used for this work, but much of the ground is such

that it will be impossible to use a team. In such places shovels and grub hoes can be used. When the ditches are complete, favorable weather will be chosen to burn the intervening space of stubble; thus making a two rod strip absolutely free from combustible material and bordered on each side by a six foot strip of bare mineral soil. Some of the roads and trails, also, were cleared out to a width of six or eight feet, that they might serve as secondary fire breaks within the park.

ducing a little forestry and nature study into their school work, those of the general public who are sufficiently interested in the great movements of the country to desire a little definite knowledge of forestry, and also those desiring an introduction to technical study, will take advantage of this course. There will also be advanced classes for those who have had more or less experience and training in the technical work.

This gives Minnesota a splendid op-



Minnesota State Forest School, in Itasca Park

All this work of the past summer was but preparatory to the work of next year, when it is expected to establish a summer school of forestry, as a part of the course now offered at the State University. There will be an elementary course, which may or may not lead to the further study of forestry, consisting approximately of the following subjects: silviculture, mensuration, taxonomy, geology, entomology, and surveying. It is expected that teachers, who are intro-

portunity of demonstrating what can be done in the application of practical forestry in the great pineries of the Lake States. Every type and condition of forest is represented in the park, and the combination of the school work with the application of the working plans offers many advantages to both. It is an ideal situation for a forest school. Extensive preparations are being made for next year's work and it is believed that they are justified.

MILLIONS FOR TRIBUTE, BUT NOT ONE CENT FOR DEFENSE

BY

F. M. Eaton, Richwood, West Virginia

SOMEWHERE among the dead bills presented to the last Congress of the United States lies a bill—the White Mountain-Appalachian Bill.

Does the ordinary reader and voter of this country know that it has been there, and is there? Or, if he knows it, does he know what it is for?

I doubt that very many can say yes to either question.

Down here in the West Virginia mountains, where the water goes in a

terrible hurry on its way to the Atlantic Ocean and the Gulf of Mexico, if one knows the purpose of the bill, one gets an idea of its value.

Down these mountain sides, where the angle of 45 degrees is a common occurrence, and “up and down” pretty common, the rain water slides as though it were an express train making up lost time. In the original forest it has its beaten track of one large or small ravine bottom, full of large

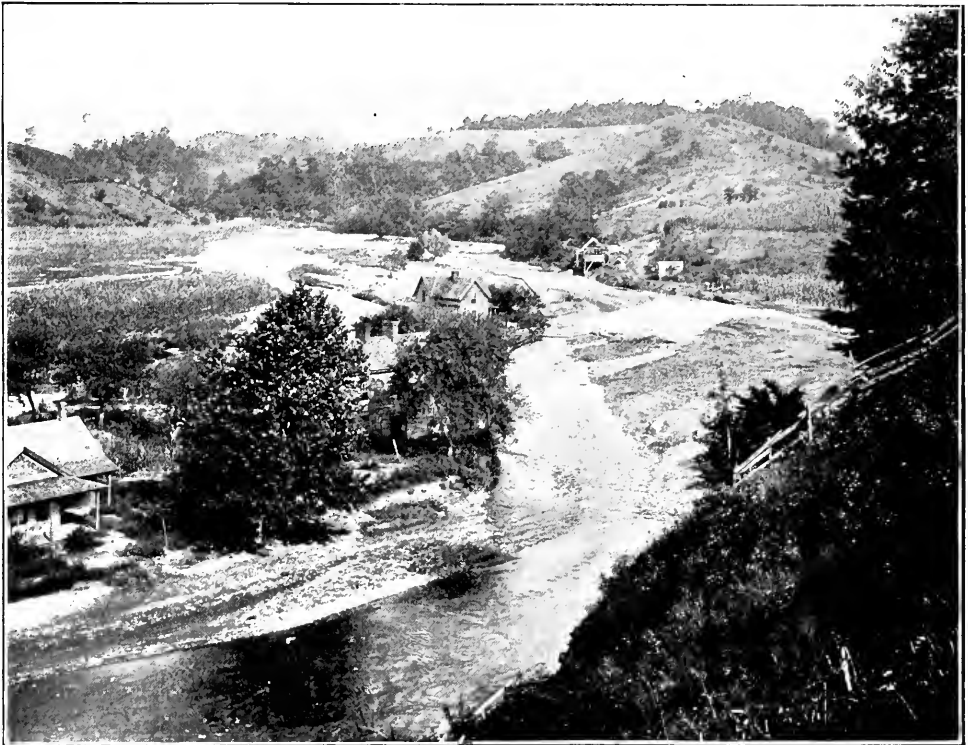

Badly washed mountain valley lands, Bakersville, N. C.—The lower slopes bordering this valley are largely cleared

and small boulders, fallen tree trunks, and debris from the trees above, with the banks held by fern roots and roots of bushes, checking, in a large meas-

the dead trunks of former trees. These all tend to moderate the flow of the water and dissipate it.

Now go on the tract that has been

Beech growth on uplands near Yazoo delta—Though not in Appalachians, this is a good illustration of bad erosion checked by tree cover



ure, the rush of the water. On the adjacent hillsides are the trees, whose foliage breaks the force of the rainfall. On the ground are the bushes, ferns, and dead branches, and now and then

lumbered over and then burned. There your ravine bottoms are the same, all but the bushes and ferns on the banks, but up on the hillsides are furrows by the dozen; and the deeper and

broader they get—why, the deeper and broader still they get; and they are continually multiplying themselves. Now, there is nothing but the bare earth to check the force of the water, and small streams gather in every little depression, to dig it deeper and broader, week by week, and month by month. In union there is strength, for water as well as anything else, and it tells its story here.

Every little drop of water gets a little soil. Lots of little drops of water, get a pebble. Lots more of little drops of water, with their multiplying amount of soil, get a stone; and still more of the little drops of water get a small boulder. Down they go, merrily, to the stream, down goes the stream to the river, then to the ocean or gulf; and with them, eventually, the soil, the pebble, the stone, and the small boulder.

The stone and small boulder may go in pieces, yet they go; and on the way they fill the streams and rivers. The White Mountain-Appalachian Bill was drawn up for the express purpose of preventing this destruction, by cutting the forest in such a way that the soil will always be protected from this erosion, and a plentiful supply of trees will be kept for the use of our children and our children's children.

I see by a local paper that one of our Congressional representatives has secured a much-coveted place on the Committee on Rivers and Harbors. What should a man do when he has secured a position on the Committee on Rivers and Harbors?

Now, a man from this State, and a great many other States along the line,

will wish to get a good, big Appropriation (capital A) for the dredging of the Ohio, and also the Mississippi. One complements the other.

Well, that is all right; they need dredging, but where on this earth are we going to stop dredging? By neglecting the problem, what causes the necessity of dredging, and sticking to the dredging itself, to the exclusion of all else, our representatives lead one to think that they consider the leak at the bung-hole a small matter compared with the leak at the spigot.

Man dredges; and from her waste and wasted lands, old Nature is filling in. Man dredges; and old Nature, from those ever-increasing furrows, continues to fill in. Faster and faster, she fills in; and in the meantime, she takes a little spare time to have floods, which destroy not only the houses and the manufactories on the banks of the river, but also the farms, depositing on the fertile land the pebbles and stones which she has left over from her fight with the dredgers.

Silly, isn't it? Not on Nature's part, for she is only getting revenge for our misuse of her. But it is silly of man.

Why not ally ourselves with her? Why not save ourselves the loss of lives, goods, and lands? Why do so much dredging to no purpose?

Poor, old Uncle Sam! There he is being plundered right before our eyes; and the man who puts in his vote for large sums for dredging and lets the bill die in committee feels very complacent and thinks he has done a big thing for his country. Millions for tribute, but not one cent for defense! Queer, isn't it?

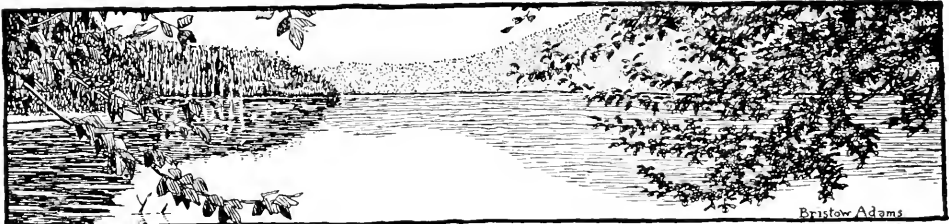

REDWOOD CANYON DEEDED TO UNITED STATES

A MOST public-spirited gift to the Nation has come from William Kent, of Chicago, who has just deeded to the United States 295 acres of primeval redwood forest on the southern slope of Mount Tamalpais, about six miles from the city of San Francisco. The land was deeded to the Government with the approval of Mr. Pinchot, Chief of the Forest Service. The papers have now gone to the Secretary of the Interior, and a proclamation declaring the canyon a National Mon-

ument of redwood timber alone is now valued at more than \$150,000 on the market, besides other timber worth \$50,000.

The canyons of Tamalpais which drain into San Francisco Bay were cut clean years ago, and the redwood obtained from them went into the construction of the old San Francisco. The giants on this tract escaped the axe, however, chiefly because the outlet is on the ocean side, instead of the bay side, and also because the various



Redwood sprouts six or eight years old

ument will be signed at an early date.

This means that more of California's redwood giants will be saved for the scientific study and pleasure of the whole country, in fact, the whole world, for the great sequoias are found nowhere except in the Golden State. This grove given to the Government by Mr. Kent is one of the few tracts of redwood forest to be found in the natural state in California to-day. The land is said to have cost Mr. Kent \$47,000 some years ago, but its stand

owners of the land have, for sentimental reasons, jealously guarded the timber from harm or destruction. Modern methods of logging would make short work of the timber, and would, besides, put a handsome profit in the hands of the owners.

It is the intention to name this National Monument the Muir Woods, after John Muir, the noted naturalist. Redwood, or Big Tree, is the dominating species, towering high above everything else, and forming fully three-

fourths of the whole forest. Douglas fir is next in importance, and scattered over the entire tract are various hardwoods, the numerous oaks, madrone, alder, maple and mountain laurel, all of which form a kind of dwarf undergrowth to the lofty redwood and fir. The largest redwoods are eighteen feet in diameter at the butt, and will ap-

bering has been so rapid that it looks as though before many years the original growth, where unprotected, will have wholly disappeared.

This 295-acre tract will be a pleasure ground as well as a place of scientific study for the people of practically the whole of California, for within a radius of 52 miles of the



Virgin redwood in California—The tree at its best

proach three hundred feet in height, rising with perfectly straight and clean stems. As none of the big trees have been cut, their age is, of course, somewhat problematical, but it is safe to say that the veterans have stood from one thousand to fifteen hundred years.

The destruction of redwood by lum-

canyon two-thirds of the population of the entire State are centered. There is no other redwood grove in the whole world more accessible to so many people. The canyon is in absolutely primeval condition, not so much as scratched by the hands of man.

NATIONAL DRAINAGE CONGRESS

THE second Annual Meeting of the National Drainage Association was held in Baltimore November 25, 26, and 27 last. Its object was to promote National reclamation of lands in all the States, now worthless or worse, because partly or wholly covered by water.

Mr. J. S. Mundy, of Newark, New Jersey, spoke of the great value of swamp mud as a fertilizer. "One thing," he said, "which keeps the farmers of North Carolina poor is their bills for fertilizer, one man having paid last year \$2,800 for fertilizer." Said he: "You don't have to fertilize swamp lands. Up in New Jersey there are two plants that dish off the soil from the swamps and, after drying, it is put in machines, from which it comes like powder. It is shipped away and sold at from \$16 to \$20 a ton, and it costs \$5 an acre. The best lands in the United States are under water, or partially so. The hills have been cultivated until there is nothing more to them. Near the farmers, for a cost of about \$100 for drainage, are lands where they can raise more corn to one acre than to twenty in the hills. Look at the Mississippi river bottoms, which are practically inexhaustible! The swamp lands, when they are drained, are the same way."

Col. James Cosgrove, member of the South Carolina legislature, and the "Apostle of Drainage in the South," spoke on the vast benefits resulting to the public health from drainage. He said, "For centuries it has been believed that no white man could live in the summer months in the swamp lands of Carolina, without contracting malaria. So firm was this belief that, on the first approach of hot weather, the farms were abandoned by most of the owners, who did not return until frost. Those who remained were bound to 'catch the fever' * * * with the result that they and their families became invalids for a great part of the year, and their off-

spring grew to manhood and womanhood handicapped with disease that unfitted them to become industrious and useful citizens. You have had the same experience wherever wet lands are located, and New Jersey, Illinois, and North Dakota have no advantage over North Carolina in this respect. Some five years ago we commenced to work for drainage for health in Charleston County, and I have the honor of directing that work."

The speaker then told of the millions of mosquitoes which infested the swamps and bore malarial germs, and how drainage of the swamps enormously lessened the numbers of mosquitoes, and replaced the dark marshes with green fields and firm ground, and made homes for thousands. This work, he insisted, was the duty of the National Government. Professor A. E. Ayres, of New York, a leader in the movement for exterminating mosquitoes, gave an illustrated lecture on this subject. He named five diseases, particularly yellow fever and malaria, which are transmitted by mosquitoes. He said, "The extermination of the disease-breeding mosquito is not now a sanitary problem but a political issue." Col. C. P. Goodyear, of Brunswick, Georgia, declared that "a war against the mosquito should enlist every patriotic American citizen."

New Jersey mosquitoes are commonly supposed to hold the record. Professor John B. Smith, Entomologist of the New Jersey Agricultural Experiment Station, lectured on the drainage of the salt marshes of that State, using stereopticon slides. He said that in New Jersey there are more than 296,000 acres of tidal marsh, a large percentage of it being waste land, producing nothing, much of it untaxed, and some townships largely made up of salt marsh, so slimly settled that it is difficult to find men to fill public offices. He said, "We started in to exterminate the salt marsh mosquito, but incidentally we are in-



A channel in the swamp country.—The general aspect of the wide, shallow currents of water that connect the different swamp areas along the Atlantic coast line—There are nearly 100,000,000 acres of swamp lands in the United States.

creasing the value of the salt marsh that comes under our operations several times the amount of money expended, and this will prove the best investment ever made by New Jersey."

Mr. H. N. Wilson, Chief Engineer of the United States Geological Survey, spoke of swamp peat as a fuel. He said, "Peat is used extensively in Europe and in Canada as a power generator, and experiments are being made with it in this country. A ton of peat, when put into a gas producer and converted into gas for that sort of engine, makes nearly as much power as a ton of bituminous coal under a boiler. This peat could be found and gathered in great quantities from swamps in this country; when made into briquettes it provides good fuel."

Senator Asbury C. Latimer, of South Carolina, declared that the National policy of drainage was in line with the broad, National policy of conserving the undeveloped resources of the country. Mr. Robert E. Lee, a Baltimore attorney and member of the Baltimore Federation of Labor, spoke on "Drainage from a Labor Standpoint," showing that "the clearing of this land will necessitate the employment of thousands of laboring people, both skilled and unskilled." Professor William Bullock Clark, State Geologist of Maryland, described the swamps of that State, showing their area to be 328,768 acres. Of draining these swamps he said, "The resulting soil will prove to be very rich. Putting the value at about \$30 an acre, which would be reasonable for land of this quality, it would add ten million dollars to the taxable property of the State. Further, adjacent lands would be improved."

Senator Francis G. Newlands, of Nevada, criticized the granting of public swamp lands by the Nation to States or corporations. He said:

"These swamp lands constitute, for the most part, the alluvial deposits made by the great rivers. No proper reclamation of them can be made with-

out taking up in some comprehensive way the treatment of the rivers of the country and the control of their waters, with a view to flood prevention, stream control and the maintenance of an equal and sustained flow of such rivers. These rivers, for the most part are interstate, and all bear important relations to interstate and foreign commerce.

"These rivers bear an important relation to interstate and foreign commerce, and are subject to the regulation and control of the National Government. It is important in the interest of interstate commerce that the waters of these rivers should not be permitted to waste themselves over vast areas of lowlands, making swamps and bayous useless for any purpose. It is important that these waters should be controlled by the construction of levees and by a system of bank protection that will restrain the erratic courses of rivers and hold their waters in a permanent channel, thoroughly secured, and kept open by a strong current, and thus made useful for navigation.

"The swamp land question, therefore, is a part of the inland waterway question now before the American people, and that question necessarily involves the preservation and replacing of forests, as conservators of moisture; the construction of reservoirs which can hold the flood waters above and make them useful for irrigation, and the watering of great plains by irrigation which can absorb the flood waters and gradually give them back to the stream by percolation when they are most needed during periods of drouth. Irrigation is the antithesis of drainage, and while possibly neither can be engaged in under the National powers, except with reference to Government lands, there can be no question about the power of the Government to engage in both as a part of the stream control so essential to navigation."

Mr. Gifford Pinchot, Forester, spoke of deforestation as one cause of

flooded lands. He mentioned the rice plantations of the Carolinas which, he said, were disappearing because of floods resulting from deforestation. He said, "According to official statements of the Census Bureau, 'thousands of acres of rice in the Carolinas have been destroyed in a single night, and many planters have been forced to abandon the industry.' Thus has a richly productive industry which has existed for 200 years been injured to an extent from which it probably cannot recover for many years.

"In former days, before the mountains were stripped of their timber, floods, as a rule, rose slowly and, instead of being a menace to the planter, were of benefit, for he made use of them by opening and closing his levees at proper times, flooding and draining his rice fields in such a way as to produce the best results."

Mr. F. H. Newell, Director of the United States Reclamation Service, speaking of Government reclamation, said: "It is of the greatest importance to the future development of the Commonwealth that these vast areas of exceedingly fertile land be reclaimed, not to form princely estates for a few men, but to be divided and subdivided into the smallest practicable area upon which, in accordance with the terms of the Reclamation Act, a family can make a comfortable living.

"There is no higher use to which the powers of the Federal Government can be put than in bringing about such a condition as to promote the creation of homes. The stability of our institutions rests directly upon the prosperity of the individual farm and home. That this result can be brought about is no longer a theory, but is a demonstrated fact. The effects of the

operation of the Reclamation Act have been not only to reclaim public lands, but to break up large holdings, regulate the water supply to these and put upon the lands which otherwise are unproductive through excess or deficiency of moisture a dense population of landowners and producers."

Governor N. B. Broward, of Florida, said, "We have dredges at work reclaiming the Everglades, but as the Everglades are as big in acreage as Connecticut, Rhode Island and Delaware, we feel that if Uncle Sam did a little reclaiming he would not get in our way."

Colonel Goodyear, above quoted, urged the simultaneous improvement of inland waterways and draining of swamps. He said, "Do both of these great works at the same time. Let them go together under the command of the United States Government. Let rivers be improved and swamps be reclaimed simultaneously, and you will find it much cheaper. These eighty million acres of land that are under water will be needed by this country some day, and I think the United States should meet the expense. Let one billion dollars worth of bonds be issued to do the work.

The following officers were elected:

Hon. N. B. Broward, Governor of Florida, President; Dr. James Bosley, Health Commissioner of Baltimore, First Vice-President; W. S. Braddock, Wisconsin, Second Vice-President; Colonel A. G. Bernard, 1420 New York Avenue, Washington, D.C., Secretary; B. Howell Griswold, Baltimore, Treasurer; C. B. Brown, California, Colonel James Cosgrove, South Carolina, and Frank J. Bock, New Jersey, Executive Committee-men.



WITH MEMBERS AND CORRESPONDENTS

Wants to Be Sustaining Member Mr. Newton Garner, Beaumont, California, remits his dues to become an annual member, and says: "I hope to become a sustaining member or a life member when I renew."

We, too, hope that Mr. Garner will have his wish.

Sends in Three More Mr. W. A. Firstbrook, a Canadian member of the American Forestry Association, living at Toronto, when he sent in his annual dues the other day sent also the dues of three other gentlemen, new members, whom he had induced to join. This is good work.

Exile Loves White Mountains An agent of the Forest Service in Guam, New Mexico, earnestly desires to see his old home in New England receive the benefit of the National Forest system. He writes:

Enclosed find application for membership in the American Forestry Association. It has been my intention for some time to become a member, and when I found your letter and pamphlet this morning I decided not to wait another day.

The object of the association in doing all in its power to have the White Mountains and Appalachian Reserve created is a most worthy one, and I will be only too glad to help it along in my small way.

I spent six of the most enjoyable years of my life in the White Mountains, and am acquainted with them from north to south, and from east to west, having ridden through them on railways and carriages and made a tramp with a friend through them of 250 miles. I also worked in the mountains for the International Paper Company and for the Publishers' Paper Company, and had ample opportunity to witness the devastation going on.

A year ago last summer (in 1906) I worked in a surveying party which laid out the line for eighteen miles of railroad from Conway, N. H., into

Albany Township. It seemed to me, at the time, that it was a shame Congress had not allowed for the creation of a National Forest before that time, and bought the land which the new road was going to drain of its beautiful forest cover, estimated at 400,000,000 of feet of the finest spruce, besides various other species.

In many places the woods were so dense that the sun hardly penetrated; and yet in those same places, even this early, is a bare waste of ground, covered with stumps and brush, left where it was cut, a constant invitation to fire. How much better it would be if the Government, through the Forest Service, directed the cutting of timber there, the piling and burning of brush, etc.

If a National Forest should be created I will immediately apply for a transfer to it, as no place has the spot in my heart which the White Mountains occupy; and, while I have seen a large portion of this country, no part of it compares with them for beauty.

Will Soon Be Too Late

Continuing, he tells us: If Congress delays much longer it will be too late to save the denuding of many of the fine old mountains. The Tripyramids, in Waterville, have already been visited along their base by the lumberman's axe, on the western side; and the new railroad, of which I spoke, will tap the eastern slopes of these three sister peaks, also the east slope of Kaucamaugus. Black Mountain, between Waterville and Sandwich, has had its northern slope well cut over to within 1,000 feet of the summit. The south slope, in Sandwich, will probably remain untouched for some time, as there are no mills on that side of the mountain.

Mount Osceola has been logged on by the International Paper Company on the south slope; and at present the Publishers' Paper Company are cutting on the north side (where grows one of the finest, if not the very finest

stand of spruce I know of in the whole region) to supply a new mill of 100,000 feet capacity a day, located in Woodstock, N. H.

Almost every Forest Service man has heard of J. E. Henry & Sons' plant in Lincoln, N. H. Mr. Henry, Sr., told me they used between forty and fifty millions of feet per year of spruce.

I could continue north, citing similar instances of large concerns who are laying waste the beautiful forest. The only hope is that a bill will soon be passed creating the National Forests; and I hope I will have the pleasure of working on the one located in the White Mountains. To be back among those old peaks is my desire and before long at that. Then I will be content, and not till then. If there is anything I can do to be of direct assistance to you in furthering the cause do not hesitate to call on me.

With a rousing cheer for the efforts and aims of the association, I am very truly yours,

NELSON L. LEGRAND.

Out of the Woods of Shortsightedness

Mr. A. W. Frederick, Northfork, California, writes these encouraging words:

"It seems to me that your views of forestry find the true highways and byways of right government in a republic. You certainly see the way out of the private woods of shortsightedness into a beautiful vista of liberal public forestry. Your statement of the difference between paternalism and popular government can never be gainsaid.

"I will inclose list of names of my teacher friends and will personally or by letter address them and call for volunteers."

No Appropriation Will Do More Good

An electrical engineer, whose profession makes him appreciate the need of the work, writes:

"I have been all along a thorough believer in the work of the American Forestry Association, but I desire to become a member at this time because

it is striving to secure a Federal Forest Reserve in the White Mountains of New Hampshire and in the Southern Appalachians. I do not believe that any appropriation of equal amount which passes Congress at this session will accomplish more of permanent good to the community than will this, if it is passed."

The Situation In Ohio

The following letter from W. A. Russell, of Beaver, Ohio, to the Secretary of Agriculture has been referred to this office by the Forest Service as valuable information:

"I received the circular on The Waning Hardwood Supply, by William L. Hall, Assistant Forester. The circular is all too true, as the forests in this part of the country are disappearing very rapidly. It is alarming, in the last year, the number of tracts of timber that have been cut away, more than 60 per cent. of what was standing at January 1st, 1907. Every station along the railway is glutted with ties made of all kinds of hard and soft woods, a great many of them made of poles that are not really more than one-half the dimensions of a first-class tie.

"Most of such ties come from timber land that was cut over years ago. Such cutting of the second growth is setting the future timber supply farther away. There is a great deal of rough, stony, hilly land in southern Ohio that would be better for the country if it had never been cleared. The lumbermen are trying to buy every piece of timber left, and if it were not for a few level-headed men, who look at things differently, they would exhaust this country of the still remaining timber in the next twelve months. At the present rate of cutting, we will in three years from now have none, or very little, left.

"The forest is dying off so much faster than it did twenty years ago. It is all more or less dying and going back, causing a great many people to sell their timber. The country here has had, and still has, some of the

finest hard timber to be found anywhere.

"The people who have always made a living by making ties cannot give up tie making. We see hundreds of thousands of ties made and hauled to each station every year. Some land owners claim the land is worth more to them when cleared, even if rough in its lay, and that they receive very little or nothing from the land if they let the timber stand, and have to pay taxes on it, and timber land is generally appraised higher, making the tax higher than that on cultivated land.

"I have been studying the matter for some time, and believe that the Government should not tax timber land. If the tax was taken off such land it would induce a great many farmers to let their timber stand."

The Governor of Ohio, in his message to the Legislature, reported in News and Notes of this issue, recommends of the tax evil, and other steps to encourage tree culture.

The Federal Government, of course, does not tax any lands; and its power to do anything for the forests in a State is very limited. It is all the more important that the States do their part, and work out their own salvation.

Another Source of Tan Bark A member of the American Forestry Association, Mr. E. S. Collins, of Ostrander, Wash., writes:

"I notice in the November issue, page 567, that a famine in tan bark oak on the Pacific Coast is threatened. I believe this statement to be substantially true, from investigations made in the tan-bark oak region of California. However, you might call the attention of your readers to a practically untouched source of tannin in western Oregon and Washington. I refer to the western hemlock, a fine forest tree, which exists in quite large quantities in the region referred to.

"The meat of the bark of the west-

ern hemlock is thicker, and the ross or dry part thinner, than the bark of eastern hemlock. It is quite rich in tannin. The bark of the western hemlock has been used at various times for tanning, but at present it is largely wasted.

"Owing to the wetness of the season when the bark is peeled, and the rough ground on which the forests are found, together with the cost of transporting the bark to market, it could not be produced cheaply; but at a fair price the output would be very large. It is safe to say the supply of western hemlock is many times greater than that of tan-bark oak."

Are Americans Very Intelligent? Mr. Charles Welsh writes from Winthrop, Mass.:

"To any one who has lived in Germany, and who knows with what system the welfare of woods and forests are looked after, some of the sights in this country are positively a disgrace to the intelligence of its people."

An Eminent European Member This office recently had the pleasure of receiving through a New York agent the application for membership and the annual dues of Mr. William Forbes, who is vice-president of the Royal English Arboricultural Society, gold, silver and bronze medalist, and forestry expert of the Estates Gazette, London. Mr. Forbes' residence is at Blairgowrie, Scotland.

In South Africa This office recently had a call from Mr. Bertram D'Alton, of the Forest Department of South Africa. Mr. D'Alton says forest conservation and extension is given large attention there. It is necessary, for the southern country is lacking in timber. Further north in the interior there are large forests, but these are not available on account of their distance and the lack of transportation facilities.



The Month in Government Forest Work.

Buffaloes Thrive in Oklahoma

Uncle Sam's herd of fifteen buffaloes which were taken from the New York Zoological Garden to the Wichita National Forest, Oklahoma, in the early fall, are doing well in their new home (the old home of their race), according to advices from the supervisor's headquarters at Cache. Since leaving New York the herd has celebrated the birth of two fine buffalo calves, one of which has been named Hornaday, after the name of the director of the New York garden which gave them to the Government; and the other is called Oklahoma, after the new State, which likewise was just born after the herd's arrival.

Keeper Frank Rush, an old Western cow-puncher and experienced buffalo man, who has handled the herd since it was removed from New York, says that alfalfa hay has put his charges in fine shape, and that the big prairie beasts are thriving as did their ancestors. The buffaloes have 8,000 acres in which to charge and snort. During the winter they will be fed alfalfa hay and protected from the weather and from disease in a number of large shelter sheds. In the spring they will be let out to roam over the Wichita range, and gradually they will be encouraged to rustle for themselves, an instinct they have partially lost through years of domestication in city parks.

Uncle Sam Saves Trees Everywhere

The earnestness of the present Federal Administration in saving trees is shown not only in the Nation-

al Forests, but wherever the Government has any opportunity to apply scientific forestry.

Besides co-operating with private owners of woodland, in showing them how to use conservative management, and with various States in a study of their forest conditions, the United State Forest Service co-operates also with the other branches of the Federal Government. Chief among these branches is the War Department. The Military Reservations which so far have been examined and reported upon are those at West Point, N. Y.; Fort Wingate, N. M.; the Rock Island Arsenal, Ill., and the Picatinny Arsenal in New Jersey. At West Point the forest consists of second-growth hardwoods, and for some time has, in part, supplied the post with cordwood, lumber, hurdle poles, tan bark and other forest products. The Forest Service made a working plan for this forest in 1903, and since then cutting has been along conservative lines, with a view of perpetuating the Forest, and at the same time supplying the post with a definite amount of wood each year. Similar plans are in preparation for the forests of the Rock Island and Picatinny Arsenals.

Arkansas Men for Guards

The Forest Service has just announced the appointment of the first three forest guards who are to assist Supervisor Samuel J. Record in the administration of the new Arkansas National Forest. It is the rule of the Forest Service to select the guards

from the State in which a forest is located. The Arkansas men who are to take up this duty are Anderson T. Wright, Will A. Gardner and James B. Cassada. The latter two have already entered upon their work, and Mr. Wright's appointment takes effect January 20. The National Forest headquarters are at Fort Smith.

Idaho Forests Re-Divided Some important changes in the administration of the National Forests in central Idaho have been made since the first of the year. The Eastern Division of the Sawtooth National Forest, embracing the Wood River watershed, the headquarters of the Middle Fork of the Salmon River, and the South Fork of the Boise River, has been established. This will be known as the Sawtooth (East) National Forest, and will be in charge of Supervisor C. N. Woods, with headquarters at Hailey.

The Payette National Forest, which has been in charge of Supervisor E. Grandjean, at Boise, will be placed in charge of Supervisor Guy B. Mains, with headquarters at Meadows. Mr. Mains has been in charge of the Lemhi National Forest since its creation. Forest Ranger Charles L. Smith, from the Henry's Lake Forest, will assume charge of the Lemhi Forest. Mr. Grandjean will continue in charge of the Sawtooth (West) National Forest, with headquarters at Boise.

Forest Ranger William McCoy, of the Sawtooth National Forest, has recently been placed in charge of the Cassia and Raft River Forests, with headquarters at Oakley, Idaho.

This division of the larger forests into smaller administrative units, with headquarters located near the forests, not only allows the supervisor a better chance to give personal supervision to the work of his entire forest, but will make it much more convenient for the users of the forest by placing the supervisor's office in easier reach for a majority of them.

New National Forest in Arizona The President has just signed a proclamation creating the Verde National Forest in Arizona. This new National Forest has an area of 721,730 acres, and is located in Maricopa and Yavapai counties. It lies on the west side of the Verde River and includes a large portion of the watershed of this stream. Jerome, the headquarters of the United Verde Copper Mine, is located in the northern part of this Forest. West and southwest of Jerome are the Mingus Mountains. There is a small area of commercial forest, which has been badly abused in the past, but which under proper management will furnish a small local supply of timber to the mining camp for many years.

The greater part of the area of this forest is covered with a growth of brush, without commercial value. The protection of this, however, is just as important as heavily-forested land, for, as in the case in Southern California, this scrubby growth is the only thing that conserves the water supply and protects the watershed of the Verde River from serious erosion.

The creation of this new National Forest is considered necessary by the Reclamation Service for the best administration of the Reclamation Act, and the watershed has an important relation to the full development of the irrigable lands of Salt River Valley. In order that the rich lands in this part of Arizona may be brought to their highest development the watershed of the Verde River must be protected. Many parts of the Forest have suffered from overgrazing by large bands of goats. The Forest Service will by no means prohibit future grazing on this new forest, but will endeavor so to regulate it that the watershed of the Verde River will not be injured.

Enlargement of Tonto Forest An addition of 1,288,320 acres has just been made to the Tonto National Forest in Arizona, situated in Maricopa, Gila and Pinal Counties.

That part of the addition lying on the west side of the forest is given National Forest protection, because it includes the watershed of the Verde River, above the proposed McDowell Reservoir site, which is located on the Verde just above its junction with Salt River. It seems probable that this McDowell Reservoir will be built by the Reclamation Service at some future time, and when this project is completed, something over 100,000 acres of land will be irrigated in the Salt River Valley, in addition to the land irrigated by the Salt River project at Roosevelt.

The eastern portion of the addition includes the headwaters of the Pinal and Pinto creeks. Both of these streams empty into Salt River above the Roosevelt Dam. Their watersheds have been damaged by overgrazing, mainly by goats. It is of the utmost importance that these watersheds be protected. They are already carrying large quantities of silt into Salt River, and since they both empty near what will be the upper end of the reservoir, they could do enormous damage by filling it with silt.

The most southern portion of the addition, lying directly west of the Pinal Mountains Forest, and which has, by this proclamation, been made a part of the Tonto National Forest, protects the watershed of Queen Creek, which the Reclamation Service has determined some day to impound.

The Pinal Mountain National Forest of 45,760 acres has been thrown into the Tonto Forest, giving a total area, including the new addition, of 2,449,280 acres. In the large addition there is very little commercial forest, but in most of the canyons and draws there are stands of oak and chapparal species, and in limited areas very dense stands of Arizona cypress. This limited amount of wood is of great importance, both for water conservation and for prolonging the fuel supply in a country in which the supply is very short.

Additions to California Forests The President has just signed a proclamation creating three additions to the San Bernardino National Forest in Southern California. The total area of the tracts added to the forest is 33,680 acres. This land includes a small area on the northwest corner and two small additions to the southern part of the forest.

The northwest tract adds some valuable woodlands, those on the south are important from the standpoint of water supply, since they include part of the watersheds of the City, Plunge, Santa Ana, Noble and Little San Geronio creeks. These five creeks supply water for 25,000 acres of valuable irrigated citrus land. Three important power plants are located on the Santa Ana Creek. The cities of Redlands, Grafton, Highlands, Menton, Del Rosa and Beaumont depend upon these creeks for water supply. The chaparral growth on the southern additions has an important influence in conserving the water. The area will be put under patrol and protected from fire. Fire lines along the ridges and hogbacks of the foot hills will be opened as soon as possible.

Twenty-five thousand acres have been added to the Monterey National Forest, in Monterey County, California. Of these, 14,080 acres are on the eastern side of the forest. This addition covers the headwaters of a branch of the Salinas River. Within the area are two proposed reservoir sites, and it is very important that this watershed be protected. The balance of the area is added to the west side of the forest, and includes public land that has a stand of about 30,000,000 board feet of merchantable timber.

Elimination From Oregon Forest In Oregon, on the other hand, 131,643 acres have been eliminated from the Blue Mountain National Forest. This elimination was recommended by the Forest Service after a very careful examination of the boundary of the Forest. The greater



Coppice reproduction, two years' growth, Pinal County, Arizona

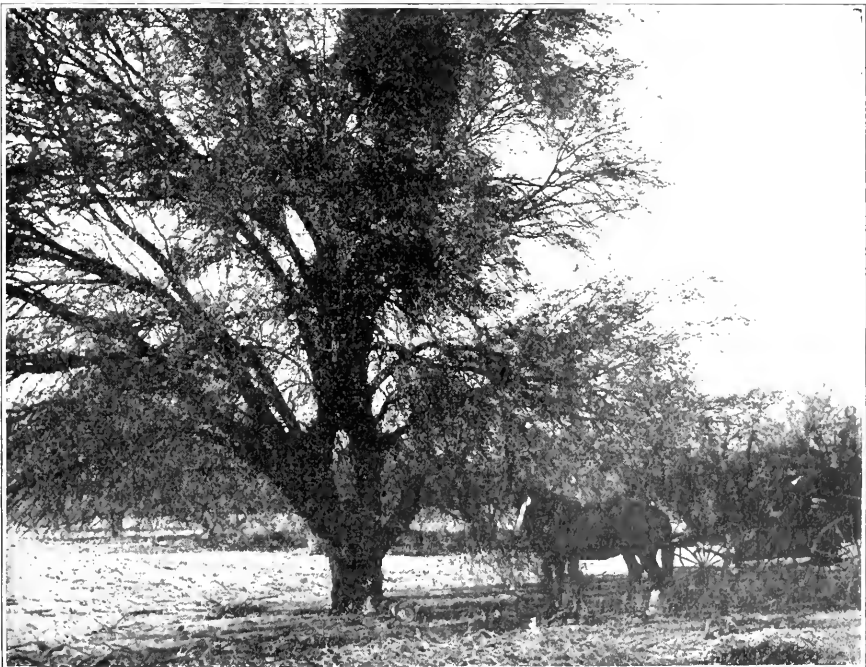

Mature mesquite tree on Verde River, Maricopa County, Arizona

part of the area taken out consists of open grass lands, and there is also some heavily timbered land, the title to which has passed from the Government.

The elimination of this large tract from the Blue Mountain National Forest carries out the established policy of the Forest Service that no land shall be included within the National Forests unless it is chiefly valuable for forest purposes. It is distinctly the policy of the Forest Service to exclude open grass lands, unless such are capable of supporting a forest growth or necessary for the protection of water supply.

To Tell The Kinds of Wood Apart A scientific laboratory unique in character, and bearing promise of important results, is the one which has just been established by the Forest Service for investigating the structure of commercial woods. In these days of growing scarcity of the more valuable woods, architects, builders and manufacturers are often seriously perplexed in identifying substitutes. Mistakes in identification have sometimes cost thousands of dollars and embarrassing lawsuits.

Wood users are already sending in samples for identification and asking if science cannot formulate ways by which specific woods can be readily and accurately distinguished from others which have similar appearance, but have greater or less value for particular uses. For instance, is a given stick gum or elm? Is it sugar maple or red maple? There are thirty or more important species of oak.

The laboratory will investigate in a practical way. The structure of the woods, sections lengthwise and crosswise, will be studied so as to separate by structure alone the various species of a genus. Analytical keys to the trees of each group will be worked out. These will be based on the arrangement and character of the pores discernible to the naked eye or by a hand lens. The results will be published from time to time with good

illustrations and placed at the disposal of lumber users. A work of this character has long been in demand.

Extensive Timber Tests Arrangements have just been completed by the United States Forest Service, in co-operation with a number of railroads and treating companies, for the most extensive series of tests on structural timber ever undertaken in this or any other country. The tests, as now planned, will be carried on at Lafayette, Indiana, and at Seattle, Washington, and the object of the investigations is to determine the effect of commercial processes of treating with creosote on the strength and stiffness of structural timber in such forms as car sills, bridge stringers, deck beams, posts, and other forms in which wood is used for commercial purposes.

There is serious lack of information at the present time as to how various commercial treating processes affect the strength of timber, and valuable new knowledge is expected from these experiments. The species of wood to be investigated will include longleaf and loblolly pine from the pine regions of the South.

Co-operating in Wood Preservation A number of important and interesting experiments are being carried on by the Forest Service jointly with private concerns and State institutions, in regard to preservative treatment.

In the Coeur d' Alene country of Idaho, experiments in preservation of the wood from dead trees are being conducted in co-operation with the Bunker Hill and Sullivan Mining and Concentrating Company.

In the Bitter Root Valley, in co-operation with the Bitter Root Stock Farm, a project is under way in the preservation of fence posts, so as to utilize the cheap and abundant species of trees, as well as dead trees, and make them into satisfactory and durable posts.

The Service is co-operating with the Louisiana State Experiment Sta-

tion in preserving fence posts and shingles, with a view to rendering available the plentiful growth in that State of such woods as upland cypress and old field pine, which have not hitherto been considered suitable for such purposes.

Does It Pay to Steam the Wood Other experiments are being undertaken to learn the value of artificial seasoning. It has not been the custom in this country to cut timber in advance and allow it to dry out naturally before giving it preservative treatment; on the contrary, the common saying is that when a large contract for such treatment is made, the wood is still standing in the forest. It is essential, however, for profitable results, that the wood be seasoned by some means; and to avoid the time consumed by air drying, it is usual to give it a steam bath, which is supposed to volatilize all the moist substances in the wood, and follow this by drying in a vacuum, when the volatilized matters are supposed to be drawn out. The expense of this process is considerable, and there is danger of injury to the timber. Moreover, the benefit is doubtful; in fact, preliminary experiments at the Forest Service have shown that at the end of the steam and vacuum process there was often more moisture in the wood than before. Observations will be made, therefore, on heartwood and sapwood of both hard and soft varieties, under varying periods of the seasoning treatment, and upon check specimens which have not been seasoned.

Wooden Tie Plates One of the ways railroad ties wear out is by the cutting in of the rails at the point where the rail lies upon the surface of the tie. The pressure of the steel rail, under the weight of locomotives and heavily laden cars, cuts down into the tie until the track becomes unsteady. This forces the discarding of the tie even though it may not be decayed. It has been found that a strip of hardwood placed between the

rail and the tie, and held in place by the same spike that holds the rail, diminishes this action. Railroads throughout the country are giving a good deal of consideration to this device; and the Forest Service has in operation two pieces of experimental track, one near Plains, Montana, and the other near Janesville, Wisconsin, in which wooden tie plates treated with creosote are being tried. They have not been down long enough to give definite results, but are doing well up to the present time. It is probable that screw spikes may give better results than the ordinary kind. Mr. Julian Ranger, of Houston, Texas, has put in a manufacturing plant at that place for these plates.

Exhibition of Humus For the first time in its history the United States Forest Service will be represented at a meeting of the International Association of Forest Experiment Stations, the next session of which will be held in Belgium, in 1910. The Forest Service was this year elected to membership in that association, which includes forest workers from nearly all the nations where scientific forestry is practiced.

One of the chief features of the meeting will be a unique exhibition of humus—the top layer of forest soils, composed of decaying organic matter. No similar exhibition has ever been held. The humus exhibit will be broad in its scope and will have to do with the soils which produce forests, protect land from erosion, store surplus water, and provide fertility, without which all other conditions of soil and climate would be in vain.

Twenty-five hundred samples of forest humus are already on hand for the exhibit, and scientific men expect valuable results from the study which this collection from many lands will make possible. Among the countries which will be represented are Germany, Belgium, Denmark, France, England, Japan, Russia, Austria, Sweden, Switzerland, and the United States.

UNITED STATES RECLAMATION SERVICE



Government Irrigation Work During the Month.

Steam Pumps For Kansas Irrigation Contract has been awarded the Buffalo Steam Pump Company, of Buffalo, New York, for furnishing pumping apparatus for the Garden City irrigation project, in Kansas. The apparatus consists of thirteen motor-driven centrifugal pumps of five second-feet capacity. These pumps are to be installed and ready to operate in the early spring. The contract price is \$20,230.

Owing to the magnitude of the pumping project at Garden City, the engineering methods which are being devised to raise the underground waters, and the important bearing this National work will have upon the ultimate development of a vast area of very fertile land in the broad river valleys of the Great Plains, the plans of the Government are of general public interest. The operations are being watched not only by those residing in that part of the West, but by many citizens of the East.

Where the Rainfall Failed In the early boom days of western Kansas and Nebraska large sums of Eastern money, principally from New England and New York, were invested in farm mortgages. A succession of dry years caused many foreclosures, and Eastern investors found themselves possessed of large areas of land of doubtful value, and for which there was no demand. A not unnatural feeling of resentment toward western Kansas prevailed the East for years; but the settlers were

no more to blame than the investors, and the settlers likewise were heavy losers. Many of them had put all their resources into the effort to establish farms in this new country, and when it was demonstrated that the region was unfit for farming they had to move back poverty stricken to older communities, in a period of hard times.

But, though the climate was at fault, the soil was rich. Much of this land lacks only water to make it productive and valuable. The Plains rivers are apt to be undependable for irrigation, as they go dry in the summer, when water is most needed, and the rainfall is uncertain and insufficient. In all the valleys, however, and at no great depth below the surface, there is an inexhaustible supply of underground water, which has a decided though slow movement through the underlying gravels.

Water From Deep in the Ground The Reclamation Service has devised a plan to utilize some of this water in the Arkansas Valley, which is unique and unusual. To bring the water to the surface a series of wells have been bored, the aggregate length of which is more than four miles, and a series of pumps which have just been purchased from Buffalo, New York, are to be installed. The project will have 230 wells, varying in depth from 40 to 300 feet, and sunk in groups of ten wells, with one pump for each group. These wells vary from 12 to 15 inches in diameter, and it is estimated that each group

will yield 6,580 gallons per minute under a 15-foot head. Each pumping station is connected by suction pipes to a No. 9 vertical centrifugal pump, driven by a 23-horse power vertical motor. The 23 stations will be operated from a central power plant, run by electricity generated by steam power.

During the irrigation season this Leviathan pumping system will lift 30,000 acre-feet, or 10,775,000,000 gallons.

The work of the Government has already given a decided impetus to private enterprise in that section, and if successful will greatly stimulate the development of similar projects in other valleys of the Great Plains where conditions are similar to those of the valley of the Arkansas.

There has been an increase in land values since the initiation of the work, and Easterners who have not disposed of their holdings may yet obtain a fair return from their investments.

Carson Sink Needs Water And Has It In the Carson Sink, Nevada, is another country where an artificial water supply is necessary for agriculture. There also the Federal Government has brought the water to the land. This is the project which, as noted in our last issue, has just reached completion.

The climate of the Carson Sink Valley is dry; it is perhaps one of the driest places in the United States. The rainfall varies from two to four inches a year, and on the average is perhaps nearer two than four. There is practically no rainy season, though the greater part of the rain comes during the winter and spring months. Occasionally snow storms occur during the winter, but there is seldom more than an inch or two of snow at a time, and this does not remain on the ground more than two days in succession.

Dry and Hot, Yet Pleasant The summers are hot and dry. The thermometer seldom goes above

100 degrees, yet it has been known to register 105. Even with the thermometer at 105, the heat is not oppressive, as the extreme dryness of the atmosphere makes the sensible temperature closer to 70 degrees. A temperature of 105 in Fallon feels cooler than 90 in St. Louis, Chicago or New York.

During the winter the thermometer occasionally drops to zero or a few degrees lower, but as a rule the winter days are cloudless and the temperature is so high that a person can drive around without needing an overcoat. There are almost no days that are cold, raw and unpleasant. The sun shines practically every day in the year, and probably three hundred days are cloudless. This abundance of sunshine makes plant growth rapid and healthful, and produces a cheerful frame of mind in the farmer.

The valley is singularly free from severe storms. There are almost no thunder storms, cyclones are unknown, and the winds which do occur are infrequent and not severe. There are no earthquakes.

Alfalfa Grows in Winter This regularity of the climate is one of its most agreeable characteristics. Untimely frosts are rare. Between May 10th and October 1st there is seldom a frost, and after May 1st all tender garden vegetables are safe. On March 1st the weather grows sufficiently warm to start alfalfa, and by May 1st the alfalfa is a foot or eighteen inches high. The growth will continue until the 1st of November, and during many winters the alfalfa is never entirely checked in growth.

The climate of the valley is very healthful. It is essentially an outdoor climate, mild in its extremes, favorable to persons with a tendency toward lung diseases, and in all of its characteristics one of the most desirable climates of the West.

All Farm Crops Grow Here The crops that can be grown under the conditions of soil and climate found in the Truckee-Carson project are too numerous to recount. Up to the present alfalfa and grain have been the staple products, and no attention has been given to fruit and vegetable growing. Very few of the old ranchers raised gardens. All this, however, has been changed within the two years in which the Government has been irrigating the country. Gardening is possible and very profitable. Many kinds of crops have been tested and grown with success, and while the farmers of the valley have not yet learned all about growing these crops, it is assured that any crop that can be grown in the north temperate zone can be raised here.

Alfalfa is yet the staple crop. It yields from five to seven tons of hay per acre, and at this time is selling for from \$10 to \$12 per ton in the stack. Wheat yields 35 bushels, barley 50 bushels, and oats 75 bushels per acre. Oats and barley are now wholesaling at from \$35 to \$40 per ton. Corn has not been grown except in an experimental way, but promises to become an important crop; it will yield from 30 to 60 bushels per acre. Kaffir corn, milo, millet, and many other forage crops of this kind have been tried, and promise to become useful to the farmers.

Garden Vegetables and Fruit Every kind of garden vegetable has proven successful. Melons of excellent quality have been raised and bring high prices in the mining camps close by, while all kinds of green stuff which can stand one or two days' shipment to the mines have been a most important source of revenue to the settlers.

Apples, pears, peaches, plums, apricots and cherries all do well, though only a few trees of these have been planted, and none have been cared

for as fruit trees should be. It is clearly evident, however, that the fruit-growing possibilities are excellent. There is a good fruit-growing climate, and a local market, in which to dispose of fruit; and those farmers who understand fruit growing will be able to produce first-class fruit of any of the deciduous varieties, which will stand competition with other valleys of the West.

The Carson Sink Valley is perhaps one of the best potato-growing regions in the West. It, last year, produced potatoes of the best quality, and where they have been handled intelligently the yields have been as great as they generally are in the Greeley country or in California. The mines of Nevada pay high prices for potatoes, and outside districts cannot compete in shipping to these mines. Furthermore, Carson Sink potatoes on the San Francisco market sell at a premium, for California people appreciate good potatoes, and realize that Nevada can produce them better than their own farms can.

Sugar beets grown experimentally have done well. Onions have been grown on a large scale, and the good market will lead many farmers to cultivate this crop.

In the way of live stock, hog raising promises best. Feed is too high priced for fattening cattle; but dairies are needed, there being but one in the valley. Eggs are high priced, and bee-keeping has been carried on successfully.

Experimenting With Crops and Methods The United States Department of Agriculture has established an experiment farm one mile south of Fallon, and as soon as this farm is put in shape it will be a source of much valuable information, for all kinds of crops will be tried, and scientific experiments will be carried on regarding methods of irrigation and farming.



RECENT PUBLICATIONS

River Discharge. Prepared for the use of engineers and students by John C. Hoyt, Assoc. M. Am. Soc. C. E., Engineer in Charge of Hydraulic Computations, U. S. Geological Survey, and Nathan C. Grover, Assoc. M. Am. Soc. C. E., Assistant Chief Hydrographer in Charge of Stream Measurements, U. S. Geological Survey. New York: John Wiley and Sons. London, England: Chapman and Hall, Ltd. Cloth, 6x9 $\frac{3}{4}$ inches; pp. 137; 24 illustrations in text.

The book covered by this review contains seven chapters and seventeen tables. Each chapter contains a definite and logical portion of the whole subject matter, the titles of the successive chapters being as follows: Introduction, Conditions affecting stream flow, Instruments and equipment, Velocity-area stations, Weir stations, and Discussion and use of data. The title of each chapter indicates clearly the substance thereof and plays an important part in the development of the whole subject. Chapters IV and VI, however, contain the most valuable and essential portions of the work. Chapter IV describes minutely the selection, establishment and operation of a velocity-area gaging station, setting forth clearly the theory and practice of making stream measurements and methods of reducing field notes. Chapter VII handles the subject from the office point of view. In this chapter, the subject of the discharge rating curves and rating tables is gone into thoroughly and scientifically, and the useful application of hydrographic data is briefly treated.

The seventeen tables referred to are placed at the close of the book, and pertain to the computation of river discharge and to the reduction of these data from one standard unit to another. Tables 1, 2, 3, and 4 give the discharges in second-foot for the most common types of weirs. Tables 5, 6, 7, and 8 contain multipliers to be applied to the discharges given in table 4, based on Bazin's formula for sharp-crested weirs, for the purpose of obtaining discharges over broad-crested weirs of compound cross section. These tables are valuable labor savers in deter-

mining the discharge over the weirs to which they are applicable.

The material brought together in *River Discharge* is for the most part a collection of information on that subject from various Government publications and current engineering periodicals. This condition is to be expected, as its authors are closely allied with much of the work that has been done by the Government in hydrography. The writers are likely to receive but little credit for originality on this account, yet they deserve the gratitude of the engineering profession for making a neat, systematic compilation of valuable data not heretofore brought together.

It is to be regretted that the book has been made so elementary, and, consequently, so small. The subject is one of large possibilities, and the authors have fallen beneath these possibilities by limiting the treatment to non-mathematical discussion of the practice of obtaining and reducing river discharge data. Much more of the technical, fundamental principles of stream flow and the purpose and usefulness of stream gaging could well have been made a part of such a work. This could have been done without danger of making the work a mathematical gymnasium. This criticism, however, is not of the quality of the material but of the quantity. The usefulness of a book does not depend so much on the possibilities of its subject as on the inherent and comparative value of its contents. Judging the work on this basis it is highly commendable.

Engineers have, ever since the recent development of river hydraulics, felt the need of a good reference book on the subject of river discharge. This is especially true of the young engineer who has not grown up with this development and of the college professor who has needed a text book for his classes. The engineer conversant with the current literature on this subject will also be pleased and benefited by the collection of information in *River Discharge*. The engineering profession will, therefore, receive and judge this work on its merits rather than on its deficiencies, and the reviewer predicts that it will have a ready and wide sale.

F. W. Hanna.

IMPORTANT BOOKS ON FORESTRY

PRINCIPLES AND PRACTICE OF FORESTRY

Forest Mensuration. By HENRY SOLON GRAVES, M. A. A complete text book of this important subject and the first written for American Foresters. It deals with the determination of the volume of log, tree, or stand, and with the study of increments and yields. *Price, \$4.00*

Economics of Forestry, The. By B. E. FERNOW. This volume treats of forests and forestry from the standpoint of political economy, and is designed to furnish a trustworthy basis for formulating public policy. *Price, \$1.50*

First Book of Forestry, A. By FILIBERT ROTH. An outline of the general principles of forestry, written in simple, non-technical language, designed particularly for the beginner. *Price, \$1.10*

Practical Forestry, for Beginners in Forestry, Agricultural Students and Woodland Owners. By JOHN GIFFORD. A good general description of the principles of forestry with enough technical information to prepare the beginner. *Price, \$1.40*

History of the Lumber Industry of America. By J. E. DEFEBAUGH. The first authoritative work of its kind yet issued, and one which will commend its self alike to the timber owner, lumberman, lumber manufacturer, or merchant, or student of economics. In four volumes bound in half leather. *\$5.00 per volume.*

Forest Planting. By H. NICHOLAS JARCHOW. An illustrated treatise on methods and means of restoring denuded woodland. *Price, \$1.50*

Forestry. (Schwappach.) An English translation of "Forstwissenschaft." *Price, 70c.*

Hedges, Windbreaks, Shelters and Live Fences. By E. P. POWELL. A treatise on the planting, growth and management of hedges with information concerning windbreaks and shelters. *Price, 70c.*

North American Forests and Forestry. By ERNEST BRUNCKEN. This volume, expository in its character, is written in a style intended for the general reader, to whom it should convey a good idea of our forests forestry. *Price, \$2.00*

Practical Forestry. By ANDREW S. FULLER. A treatise on the propagation, planting and cultivation, with descriptions and the botanical and popular names of all the indigenous trees of the United States, and notes on a large number of the most valuable exotic species. *Price, \$1.50*

Principles of American Forestry. By SAMUEL B. GREEN. Prepared especially for students in elementary forestry and for the general reader who wishes to secure a general idea of forestry in North America. *Price, \$1.50*

Seaside Planting of Trees and Shrubs. By ALFRED GAUT. Illustrated from photographs by FRANK SUTCLIFFE. This is a new volume in the English Country Life Library. Advice regarding selection and management to get satisfactory effects under adverse influence of closeness to seashore. *Price, \$1.75.*

Profession of Forestry, The. By GIFFORD PINCHOT. A pamphlet containing an address on that subject by Mr. Gifford Pinchot; also an address by Mr. Overton W. Price on "Study in Europe for American Forest Students," and a list of reference publications for students. *Price, 25c.*

FOREIGN IMPORTATIONS

English Estate Forestry. By A. C. FORBES. An authoritative volume on English forest methods from the pen of a well known forester, that should prove of interest to Americans. *Price, \$3.50*

Forstwissenschaft. (Schwappach.) *Price, 60c*

Manual of Forestry. (Schlich.) Five volumes, complete, or separately as follows (price, complete, \$18.30):

Vol. I. "Forestry Policy in the British Empire." *Price, \$2.40*

Vol. II. "Silviculture." *Price, \$3.20*

Vol. III. "Forest Management." *Price, \$3.60*

Vol. IV. "Forest Protection." *Price, \$1.80*

Vol. V. "Forest Utilization." *Price, \$4.80*

This is perhaps the most authoritative work that has been issued on the technical side of forestry, translated from the German.

Wood. By G. S. BOULGER. An important new book for arboriculturists and forestry students. A manual of the natural history and industrial applications of the timbers of commerce. Cloth. 82 Illustrations. *Price, \$2.60*

Familiar Trees. By Prof. G. S. BOULGER. Written by an eminent botanical authority, yet couched in language easily understood. The coloured plates are the work of celebrated artists, and are truthful and trustworthy in every respect. A special feature is the series of photomicrographic illustrations of sections of woods. Three volumes. *Price, per volume, \$1.50.*

DENDROLOGY, BOTANY, AND IDENTIFICATION OF SPECIES

Manual of the Trees of North America (exclusive of Mexico). By CHARLES SPRAGUE SARGENT. A volume that presents in convenient form and with excellent illustrations, authoritative information concerning the trees of North America. It is written in a manner that enables the reader to readily find what family or species any particular tree belongs. *Price, \$6.00.*

American Woods. By ROMEYN B. HOUGH. A new departure in the publication of an authoritative work illustrated with actual wood sections of the various species described. Three are given of each, viz., radial, transverse, and tangential. Issued in ten parts, per part *Price, \$5.00*

Flora of the Southern States. CHAPMAN. This is an excellent key to the flora of the south, complete and accurate in its scope. *Price, \$4.00*

Getting Acquainted with the Trees. By J. HORACE McFARLAND. A handsome volume, copiously illustrated, and with facts accurately presented in an entertaining way. *Price, \$1.75*

How Plants Grow. By ASA GRAY. An understanding of the way in which a tree grows is of prime importance to the forester, and the matter here presented is accurate and authoritative. *Price, \$1.00*

Manual of Botany. By ASA GRAY. A key to the flora of the northeastern states, and the most authoritative publication of its nature. *Price, \$1.62; field edition, \$2.00*

Our Native Trees. By HARRIET L. KEELER. A popular key to the trees of the northeastern United States, presented in manner giving easy access to the text. The book is accurate, and as far as possible is written in a style which would make it interesting to the beginner. *Price, \$2.00*

Our Northern Shrubs. By HARRIET L. KEELER. This volume is planned on the same lines as the foregoing, and describes the shrubs which are native to the region extending from the Atlantic Ocean to the Mississippi River and from Canada to the northern boundaries of our Southern states. The arrangement is by families and each member is given a popular and scientific description. *Price, \$2.00*

Principal Species of Wood; Their Characteristic Properties. By CHARLES HENRY SNOW. No attempt is made to give exhaustive descriptions of species, but the author presents a mass of information designed for the use and instruction of woodworkers, etc., in a popular style. A host of concise information is brought under each head, and the work is a valuable one. *Price, \$5.50.*

These books sent prepaid upon receipt of price indicated, by FORESTRY AND IRRIGATION, 1311 G Street, N. W., Washington, D. C.

Trees of New England. By L. L. DAME and HENRY BROOKS. This book is a small volume which can be easily put in the pocket and carried in the woods, and at the same time is the best guide to the identification of our New England trees of any of the smaller books yet published. *Price, \$1.50*

Trees of Northeastern America. NEW-HALL. A good general check list of the more important trees of the northeastern United States. *Price, \$1.75*

Trees and Shrubs. By C. S. SARGENT. The most thorough and authoritative publication yet issued, and a standard work. The matter is issued in parts, of which there are three already published. *Price, per part, \$5.00*

Trees, Shrubs and Vines of the Northeastern United States. By H. E. PARKHURST. In this book the author describes the trees, shrubs, and vines of the northeastern United States in a popular way, the book being designed especially for persons who have never studied botany. To these it will appeal as a valuable guide to a familiarity with the salient characteristics of trees, shrubs and vines. *Price, \$1.50*

Trees. A handbook of forest botany for the woodlands and the laboratory. By H. MARSHALL WARD. Vol. I, Buds and twigs. Vol. II, Leaves. Vol. III, Flowers and inflorescences. Three volumes to be added, on Fruits and seeds, Seedlings, Habit and conformation of the tree as a whole. *Price, per volume, \$1.50*

DESCRIPTION OF PARTICULAR SPECIES AND LOCALITIES

Mountains of California, The. By JOHN MUIR. No other person is so well fitted to write of the mountains of California as John Muir, and the volume presented here describes not only the mountains themselves but the trees that clothe them and the wild life which they harbor. *Price, \$1.35*

BOOKS ON IRRIGATION AND DRAINAGE

Irrigation in the United States. By F. H. NEWELL. The most authoritative and complete work on the subject which has yet been published, by the head of the Government's irrigation work. *Price, \$2.00*

Irrigation Farming. By L. M. WILCOX. A newly revised edition of one of the standard works on irrigation. The principal chapters treat very fully of irrigation, its application, etc., and the volume is profusely illustrated. *Cloth, \$2.00*

Irrigation for Farm, Garden and Orchard. By HENRY STEWART. This work is offered to those American farmers and other cultivators of the soil who, from painful experience, can readily appreciate the losses which result from the scarcity of water at critical periods. *Price, \$1.00*

Irrigation and Drainage. By F. H. KING. While most of the existing books on these subjects have been written from engineering or legal standpoints, this one presents in a broad yet specific way the fundamental principles which underlie the methods of culture by irrigation and drainage. *Price, \$1.50*

Irrigation Institutions. By ELWOOD MEAD. A discussion of the economic and legal questions created by the growth of irrigated agriculture in the West, by the Chief of Irrigation and Drainage Investigations of the Department of Agriculture. *Price, \$1.25*

Land Draining. By MANLY MILES. A handbook for farmers on the principles and practise of draining, giving the results of his extended experience in laying tile drains. *Price, \$1.00*

Land of Little Rain, The. By MRS. MARY AUSTIN. A nature book of the highest type. The volume is made up of a series of sketches of the human, animal, and plant life found in the region of the Mohave desert, Death Valley, and the Sierras, much of which the average person is likely to consider almost devoid of living things. *Price, \$2.00*

Our National Parks. By JOHN MUIR. If you want to learn about the glaciers, mountain peaks, canyons and great waterfalls of the West; of the habits of animals from the squirrel to the moose; plant life from the big trees to the wild flowers — in fact be brought face with nature's works, this is the book. *Price, \$1.85*

Trees and Shrubs of Massachusetts. EMERSON. Two volumes. Plain cloth edition has 148 plates. The colored edition has 36 of these in colors. *Price, plain, \$12.00. Price, colored, \$18.00.*

The Earth as Modified by Human Action. By G. P. MARSH. A Revision of Man and Nature. Describes changes in the face of the earth caused by man, including desolation of various countries, once thickly inhabited, by removal of forests. Shows importance of maintaining natural balance of forces. *Price, \$3.50*

The Longleaf Pine in Virgin Forest. A Silvical Study. By G. FREDERICK SCHWARZ. This is a study of the life history of this important forest tree. Intended primarily for foresters and forest students; also for owners and managers of pine timber lands. Deals with the preference or dislike of the species for particular conditions of soil, climate, and environment. Illustrations and six tables. *Price, \$1.25*

IMPORTATIONS

Beautiful Rare Trees and Plants. By the EARL OF ANNESLEY. A description of some of the rarer English trees, shrubs and vines, illustrated copiously. *Price, \$13.00*

Forests of Upper India and Their Inhabitants. By THOMAS W. WEBBER. This volume is an account of the author's life in India during the period shortly after 1857. It contains a vivid description of the country, its people, customs, etc., with some description of its forests and timber wealth. *Price, \$6.00*

IRRIGATION ENGINEERING AND CONSTRUCTIVE WORK

Design and Construction of Dams. By EDWARD WEGMANN. This volume includes an authoritative discussion of the constructive work involved and the principal forms of construction. Masonry, rock-fill and timber dams are discussed extensively. *Price, \$6.00*

Improvement of Rivers. By B. F. THOMAS and D. A. WATT. This volume is a treatise on the methods employed for improving streams for open navigation and for navigation by means of locks and dams. *Price, \$6.50*

Engineering Engineering. By HERBERT M. WILSON. This is the fourth edition of Mr. Wilson's popular work, and the revision and enlargement which it has undergone, places it at the forefront of text books on the subject for American students. *Price, \$4.00*

Engineering for Land Drainage. By C. G. ELLIOTT. A manual for laying out and constructing drains for the improvement of agricultural lands. *Price, \$1.50*

Reservoirs for Irrigation, Water-power, and Domestic Water-supply. By JAMES DIX SCHUYLER. An account of various types of dams and the methods and plans of their construction, together with a discussion of the available water-supply for irrigation in various sections of arid America, distribution, application, and use of water; the rainfall, runoff, and evaporation from reservoirs, and effect of silt, etc. *Price, \$5.00*

Water Supply Engineering. By A. PRESCOTT FOLWELL. A treatise on the designing, construction and maintenance of water-supply systems, both city and irrigation. *Price, \$4.00*

Water Power. By JOSEPH P. FRIZELL. An outline of the development and application of the energy of flowing water. *Price, \$5.00*

Concrete, Plain and Reinforced. By FREDERICK W. TAYLOR and SANFORD E. THOMPSON. Designed for practicing engineers and contractors; text and reference book for students. Discusses materials, processes, and applications of concrete in construction and specifications. *Price, \$5.00*

Hydraulics. By MANSFIELD MERRIMAN. Purpose of book is to keep abreast of modern progress, and present subject with conciseness and clearness. Gives general principles and discusses flow of water through various kinds of openings and channels. Historical notes and references. *Price, \$5.00*

Foundations. By W. M. PATTON. A practical treatise explaining fully the principles involved. Numerous descriptions of important modern structures are given in sufficient detail. Includes articles on use of concrete in foundations. *Price, \$5.00*

Masonry Construction. By IRA O. BAKER. Contains results of a great number of experiments, and a large amount of practical data on cost of masonry, pile driving, foundations, culverts, etc., and 97 tables to facilitate estimating. *Price, \$5.00*

Reinforced Concrete. By ALBERT W. BUEL and CHARLES S. HILL. A treatise for designing and constructing engineers, governed by American practice and conditions. Theoretical discussions omitted, and replaced by practical working formulas, examples of representative structures, and records of practice. *Price, \$5.00*

BOOKS ON RELATED SUBJECTS

Utilization of Wood Waste by Distillation.—By Walter B. Harper. An important treatise on a subject regarding which the interest is great and the information scarce. Is intended to aid in the establishment and conduct of wood distilling enterprises on a business basis. *Price, \$3.00*

The Garden

Roses and How to Grow Them. By many Experts. In text, practical; in subject and quality of illustrations, beautiful. *Price, \$1.20*

Ferns and How to Grow Them. By G. A. WOOLSON. The growing of hardy ferns, both in the garden and indoors. *Price, \$1.20*

Lawns and How to Make Them. By LEONARD BARRON. For the first time the subject of lawn seed mixtures is set forth and explained. 32 photographs. *Price, \$1.20*

How to Make School Gardens. By H. D. HEMENWAY. This suggestive little book is a practical manual of school gardening for both teacher and pupil, and supplies the first adequate work of the sort in this country. There are to-day a hundred thousand school gardens in Europe, and the progress of the recent movement in America has been most rapid. This volume is based on actual experience (the author is an authority and director of the Hartford School of Horticulture), illustrations, 10. *Price, \$1.10*

How to Make a Fruit Garden. By S. W. FLETCHER. An eminently practical work on the subject of fruits for the home. With 182 photographic illustrations by the author. *Price \$2.25*

How to Make a Flower Garden. A charming and a practical book by experts on every branch of the subject. More than 200 beautiful photographs. *Price, \$1.75*

How to Make a Vegetable Garden. By EDITH L. FULLERTON. The only adequate book on the home vegetable garden. 250 photographs by H. B. Fullerton. *Price, \$2.20*

Art and Craft of Garden Making. By THOMAS H. MAWSON. Third edition of this standard; out of print for a year, and now reissued in revised form. Over 100 plans and details of gardens. Methods employed by successful designers carefully analyzed. Characteristic sites in typical districts described and pictured. *Price, \$15.00*

The Home and Farm

The Country House. By CHARLES EDW. HOOPER. A practical manual of house building, absolutely invaluable to everyone with a country place. It covers every branch of the subject in detail and treats of the garden and its furnishings in connection with the dwelling. 380 photographs and plans. *Price, \$3.30*

Three Acres and Liberty. By BOLTON HALL. Description of what can be accomplished on a small place in the way of gardening, home-making, and addition to financial resources. Were it not for the unimpeachable authorities quoted, its statements as to the possibilities of the "Little Lands" for a living would seem fanciful. *Price, \$1.85.*

The Making of a Country Home. By J. P. MOWBRAY ("J. P. M."). This delightful story showed its universal appeal when published serially, and the volume amply carries out the intention of the author. Besides its practical interest for the thousands of city dwellers who have dreamed of having a country home, the story is one of such reality, humor, and interest as to ensure it the widest circulation in book form. Elaborately decorated. *\$1.65*

The First Book of Farming. By CHARLES L. GOODRICH. No one interested in farming, old or young, can fail to appreciate this book, for it really gives the fundamental knowledge of how to conduct a farm with the least expense and the largest return. There are 63 full pages of helpful illustrations. The price is extremely low for a work of such value. 63 pages of photographs. *Price, \$1.10*

Nature Books

American Food and Game Fishes. By DAVID STARR JORDAN and B. W. EVERMANN. Fills a long-felt need in popular scientific works, being a full account of the life-histories and methods of capture of North American food and game fishes. The only book in existence which will enable the amateur readily to identify species new to him. With 10 lithographed color plates, 100 photographs of live fish in the water, and 200 text cuts. *Price, \$4.40*

Nature Biographies. By CLARENCE M. WEED. This volume is a sort of personal acquaintance with the lives of the more common butterflies, moths, grasshoppers, flies, and so on, the sort of fascinating details of these insect existences which make the reader want to go out and study these every-day marvels for himself. 150 photographic illustrations. *Price, \$1.50*

The Brook Book. By MARY ROGERS MILLER. A brook is one of the most living and companionable features of the landscape, and few people, even the most ardent nature lovers, realize what an endlessly interesting study its changes and its throbbing life afford. It is a fascinating subject which the author (well known as a teacher, lecturer, and writer connected with the Nature Study Bureau at Cornell) handles with much ability. 16 photographs. *Price, \$1.50*

Outdoors. A Book of the Woods, Fields and Marshlands. By ERNEST MCGAFFEY. Papers on out of doors, showing a love of nature and keenness of observation and power and beauty of description rarely surpassed. *Price, \$1.25*

Nature and The Camera. By A. RADCLIFFE DUGMORE. Mr. Dugmore is an expert in the new movement of photographing live birds, animals, fish, flowers, etc. His works brought him so many requests for information, that he has set down here a full and detailed account of his methods. From the choice of a camera to questions of lighting, and to the problem of "snapping" shy birds and animals in their native haunts, every step is explained so simply as to be easily comprehended, even by the beginner. 53 photographic illustrations. *Price, \$1.50*



**Evergreens,
Forest Trees
and Seeds.**

*Three Millions of White Pine Seedlings and
nearly one ton of Seeds.*

Red Oaks, Linden, Black Locust

ALSO SEEDS

For forest planting on sandy soil I offer several millions Ponderosa and Jack Pines and Northern Red Cedar, and Seeds of same.

Northern Grown Trees and Seeds a Specialty
Mention this paper when you write.

D. HILL, Evergreen Specialist
DUNDEE, ILL.

BE A RAILROAD MAN

Firemen and Brakemen
Earn from \$100 to \$185
a month. Graduates of
this school in great de-
mand. Actual railway
officials teach you by
mail during your spare time,
at small cost. Free catalog, etc.
The Wenatche Railway Corres. School,
Box 89, Freeseport, Ill.

ORCHIDS

ORCHIDS

We are the largest Orchid Growers
in the United States
Our Illustrated and Descriptive
Catalogue of Orchids is now ready
and may be had on application

Orchid Growers and Importers **LAGER & HURRELL,**
Summit, N. J.

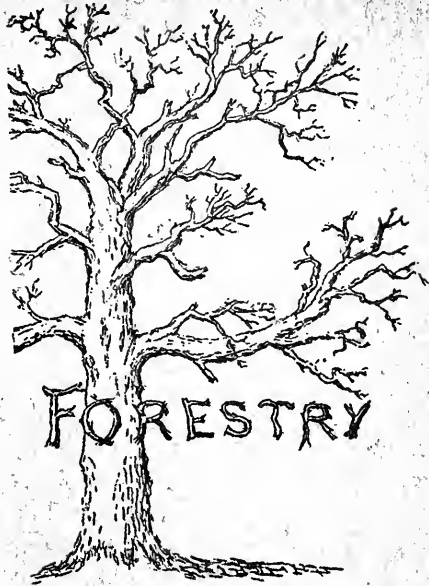

POWDER POINT SCHOOL, Duxbury, Mass.

In addition to the present work of the school, a new preparatory course in *Forestry* is being started, leading to the college courses in the subject. It requires hard, earnest application, and develops an appreciation of nature and power of leadership.

F. B. KNAPP, S. B.

Rife Hydraulic Ram

(Pumps Water by Water Power)

**Town Water Works,
Railroad Tanks, Irrigation,
Country Homes, Greenhouses.**

No Attention—No Expense—Runs Continuously.

Operates under 18 inches to 50 feet fall. Elevates water 30 feet each foot of fall. 5000 in successful operation. Sold on 30 days trial. Catalog and estimate free.

RIFE HYDRAULIC RAM COMPANY,
217 1/2 Trinity Bldg., New York

The . . **PAPER** . . that this publication is printed
on is furnished by

R. P. Andrews Paper Co., Inc., Washington,

Sole Agents in the District of Columbia for the
West Virginia Pulp and Paper Company,
the Largest Manufacturers of Book Paper in
the world.

IF IN NEED, DROP THEM A LINE

In writing advertisers kindly mention **FORESTRY AND IRRIGATION**

Biltmore Forest School

Biltmore, N. C.



Theoretical and practical instruction in all branches of applied forestry.

Course comprising twelve consecutive months can be entered at any time of the year—no vacations.

Object lessons within the mountain estate of George W. Vanderbilt, comprising 120,000 acres, where forestry has been practiced since 1895



For further information apply to

C. A. Schenck, Director

COLORADO SCHOOL OF FORESTRY...

Colorado Springs, Colo.

Three years' course in
**TECHNICAL AND
APPLIED FORESTRY**

Winter Term at Colorado College, Colorado Springs.
Summer Term at Manitou Park on the borders of the Pike's Peak Forest Reserve.

**TUITION, SIXTY DOLLARS
A YEAR**

For further particulars apply to
WM. C. STURGIS, Dean

Colorado Springs - - - Colo.

YALE FOREST SCHOOL NEW HAVEN. . . CONNECTICUT

The course of study in THE YALE FOREST SCHOOL covers a period of two years. Graduates of collegiate institutions of high standing are admitted as candidates for the degree of Master Forestry.

The Summer School of Forestry is conducted at Milford, Pike County, Fenna.

For further information address

Henry S. Graves, Director, New Haven, Conn.

FORESTRY AND IRRIGATION

Constitutional Basis of the Appalachian Bill

Annual Meeting of the Association

Presidential Address by Mr. Wilson

Forester Pinchot's Speech

Arguments of Governor Smith and Mr. Shepard

Annual Report of the Directors

Christmas in the Sierra North

Thorburn's Seeds

Seed of Pinus Bankiana - \$4.00 per lb.
(Northern Jack Pine)

Seed of Pinus Strobus - \$1.50 per lb.
(White Pine)

Free by mail or express.

Special prices on large lots on application.
Also large line other tree and shrub seeds.
New crop imported natural grasses.
Send for 1908 catalog, ready about Jan. 1st.

J. M. Thorburn & Co.

33 Barclay Street,
Through to 38 Park Place

Established 1802

NEW YORK

This Solar can be used in hazy weather, when other Solars are useless. Used by the U. S. General Land Office.

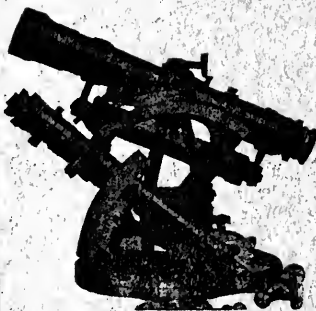

Specifications:

Needle $8\frac{1}{2}$ inches long. Graduations $4\frac{1}{2}$ inches long reading minutes. Power of telescope 20 (with splendid definition, good light, and large field). Variation plate. Level to telescope, clamp and opposing screws. Fixed arc. Stadia hairs. Extension bars.

Tripod. Solar Attachment on side of standards.

Price, complete \$300

Telegraph and Code Word, Mountsolar

Illustrated Catalogue upon application

YOUNG & SONS, PHILADELPHIA

Have You a Hobby?

It does not make any difference to us with what kind of a hobby you are identified, we can furnish you articles from papers and magazines published all over the world upon any subject you may be interested in. The man who wants to be

Up-to-Date

needs the help of a good

Press-Clipping Service

because he cannot read everything himself. It's simply a physical impossibility. Let us read for you—it's our business. Our work saves you much valuable time spent in libraries and reading papers in search for information which can be nowhere definitely obtained. You will be surprised at the results; you will see paragraphs which you would never have been able to find yourself. Drop us a postal and we will point out to you what we can do for you. Price, \$5.00 for 100 clippings.

H. ROMEIKE, Inc.

110-112 West 26th St.

New York City

PLANE SURVEYING

A Text-book and Pocket Manual

By JOHN CLAYTON TRACY, C. E.

*Ass't Professor of Structural Engineering
Sheffield Scientific School of Yale University*

16 mo, xxvii + 792 pages, illustrated with line cuts. Morocco, \$3.00

Used in the Yale Forestry School and just adopted in Pennsylvania Department of Forestry :: ::

Descriptive Circular on Application

JOHN WILEY & SONS

43 and 45 E. 19th St. New York City

IMPORTANT BOOKS ON FORESTRY

PRINCIPLES AND PRACTICE OF FORESTRY

Forest Mensuration. By HENRY SOLON GRAVES, M. A. A complete text book of this important subject and the first written for American Foresters. It deals with the determination of the volume of log, tree, or strand, and with the study of increments and yields. *Price, \$4.00*

Economics of Forestry, The. By B. E. FERNOW. This volume treats of forests and forestry from the standpoint of political economy, and is designed to furnish a trustworthy basis for formulating public policy. *Price, \$1.50*

First Book of Forestry, A. By FILIBERT ROTH. An outline of the general principles of forestry, written in simple, non-technical language, designed particularly for the beginner. *Price, \$1.10*

Practical Forestry, for Beginners in Forestry, Agricultural Students and Woodland Owners. By JOHN GIFFORD. A good general description of the principles of forestry with enough technical information to prepare the beginner. *Price, \$1.40*

History of the Lumber Industry of America. By J. E. DEFEBAUGH. The first authoritative work of its kind yet issued, and one which will commend its self alike to the timber owner, lumberman, lumber manufacturer, or merchant, or student of economics. In four volumes bound in half leather. *\$5 00 per volume.*

Forest Planting. By H. NICHOLAS JARCHOW. An illustrated treatise on methods and means of restoring denuded woodland. *Price, \$1.50*

Forestry. (Schwappach.) An English translation of "Forstwissenschaft." *Price, 70c*

Hedges, Windbreaks, Shelters and Live Fences. By E. P. POWELL. A treatise on the planting, growth and management of hedges with information concerning windbreaks and shelters. *Price, 70c.*

North American Forests and Forestry. By ERNEST BRUNCKEN. This volume, expository in its character, is written in a style intended for the general reader, to whom it should convey a good idea of our forests for the future. *Price, \$2.00*

Practical Forestry. By ANDREW S. FULLER. A treatise on the propagation, planting and cultivation, with descriptions and the botanical and popular names of all the indigenous trees of the United States, and notes on a large number of the most valuable exotic species. *Price, \$1 50*

Principles of American Forestry. By SAMUEL B. GREEN. Prepared especially for students in elementary forestry and for the general reader who wishes to secure a general idea of forestry in North America. *Price, \$1 50*

Seaside Planting of Trees and Shrubs. By ALFRED GAUT. Illustrated from photographs by FRANK SUTCLIFFE. This is a new volume in the English Country Life Library. Advice regarding selection and management to get satisfactory effects under adverse influence of closeness to seashore. *Price, \$1.75.*

Profession of Forestry, The. By GIFFORD PINCHOT. A pamphlet containing an address on that subject by Mr. Gifford Pinchot; also an address by Mr. Overton W. Price on "Study in Europe for American Forest Students," and a list of reference publications for students. *Price, 25c*

FOREIGN IMPORTATIONS

English Estate Forestry. By A. C. FORBES. An authoritative volume on English forest methods from the pen of a well known forester, that should prove of interest to Americans. *Price, \$3.50*

Forstwissenschaft. (Schwappach.) *Price, 60c*

Manual of Forestry. (Schlich.) Five volumes, complete, or separately as follows (*price, complete, \$18.80*);

Vol. I. "Forestry Policy in the British Empire." *Price, \$2.40*

Vol. II. "Sylviculture." *Price, \$3.20*

Vol. III. "Forest Management." *Price, \$3.60*

Vol. IV. "Forest Protection." *Price, \$4.80*

Vol. V. "Forest Utilization." *Price, \$4.80*

This is perhaps the most authoritative work that has been issued on the technical side of forestry, translated from the German.

Wood. By G. S. BOULGER. An important new book for arboriculturists and forestry students. A manual of the natural history and industrial applications of the timbers of common trees. Cloth. 82 Illustrations. *Price, \$2.80*

Familiar Trees. By Prof. G. S. BOULGER. Written by an eminent botanical authority, yet couched in language easily understood. The coloured plates are the work of celebrated artists, and are truthful and trustworthy in every respect. A special feature is the series of photomicrographic illustrations of sections of woods. Three volumes. *Price, per volume, \$1.50.*

DENDROLOGY, BOTANY, AND IDENTIFICATION OF SPECIES

Manual of the Trees of North America (exclusive of Mexico). By CHARLES SPRAGUE SARGENT. A volume that presents in convenient form and with excellent illustrations, authoritative information concerning the trees of North America. It is written in a manner that enables the reader to readily find what family or species any particular tree belongs. *Price, \$6.00.*

American Woods. By ROMEYN B. HOUGH. A new departure in the publication of an authoritative work illustrated with actual wood sections of the various species described. Three are given of each, viz., radial, transverse, and tangential. Issued in ten parts, per part *Price, \$5.00*

Flora of the Southern States. CHAPMAN. This is an excellent key to the flora of the south, complete and accurate in its scope. *Price, \$4.00*

Getting Acquainted with the Trees. By J. HORACE McFARLAND. A handsome volume, copiously illustrated, and with facts accurately presented in an entertaining way. *Price, \$1.75*

How Plants Grow. By ASA GRAY. An understanding of the way in which a tree grows is of prime importance to the forester, and the matter here presented is accurate and authoritative. *Price, \$1.00*

Manual of Botany. By ASA GRAY. A key to the flora of the northeastern states, and the most authoritative publication of its nature. *Price, \$1.62; field edition, \$2.00*

Our Native Trees. By HARRIET L. KEELER. A popular key to the trees of the northeastern United States, presented in manner giving easy access to the text. The book is accurate, and as far as possible is written in a style which would make it interesting to the beginner. *Price, \$2.00*

Our Northern Shrubs. By HARRIET L. KEELER. This volume is planned on the same lines as the foregoing, and describes the shrubs which are native to the region extending from the Atlantic Ocean to the Mississippi River and from Canada to the northern boundaries of our Southern states. The arrangement is by families and each member is given a popular and scientific description. *Price, \$2.00*

Principal Species of Wood; Their Characteristic Properties. By CHARLES HENRY SNOW. No attempt is made to give exhaustive descriptions of species, but the author presents a mass of information designed for the use and instruction of woodworkers, etc., in a popular style. A host of concise information is brought under each head, and the work is a valuable one. *Price, \$3.50.*

Trees of New England. By L. L. DAME and HENRY BROOKS. This book is a small volume which can be easily put in the pocket and carried in the woods, and at the same time is the best guide to the identification of our New England trees of any of the smaller books yet published. *Price, \$1.50*

Trees of Northeastern America. NEW-HALL. A good general check list of the more important trees of the northeastern United States. *Price, \$1.75*

Trees and Shrubs. By C. S. SARGENT. The most thorough and authoritative publication yet issued, and a standard work. The matter is issued in parts, of which there are three already published. *Price, per part, \$5.00*

Trees, Shrubs and Vines of the Northeastern United States. By H. E. PARKHURST. In this book the author describes the trees, shrubs, and vines of the northeastern United States in a popular way, the book being designed especially for persons who have never studied botany. To these it will appeal as a valuable guide to a familiarity with the salient characteristics of trees, shrubs and vines. *Price, \$1.50*

Trees. A handbook of forest botany for the woodlands and the laboratory. By H. MARSHALL WARD. Vol. I, Buds and twigs. Vol. II, Leaves. Vol. III, Flowers and inflorescences. Three volumes to be added, on Fruits and seeds, Seedlings, Habit and conformation of the tree as a whole. *Price, per volume, \$1.50*

DESCRIPTION OF PARTICULAR SPECIES AND LOCALITIES

Mountains of California, The. By JOHN MUIR. No other person is so well fitted to write of the mountains of California as John Muir, and the volume presented here describes not only the mountains themselves but the trees that clothe them and the wild life which they harbor. *Price, \$1.85*

BOOKS ON IRRIGATION AND DRAINAGE

Irrigation in the United States. By F. H. NEWELL. The most authoritative and complete work on the subject which has yet been published, by the head of the Government's irrigation work. *Price, \$2.00*

Irrigation Farming. By L. M. WILCOX. A newly revised edition of one of the standard works on irrigation. The principal chapters treat very fully of irrigation, its application, etc., and the volume is profusely illustrated. *Cloth, \$2.00*

Irrigation for Farm, Garden and Orchard. By HENRY STEWART. This work is offered to those American farmers and other cultivators of the soil who, from painful experience, can readily appreciate the losses which result from the scarcity of water at critical periods. *Price, \$1.00*

Irrigation and Drainage. By F. H. KING. While most of the existing books on these subjects have been written from engineering or legal standpoints, this one presents in a broad yet specific way the fundamental principles which underlie the methods of culture by irrigation and drainage. *Price, \$1.50*

Irrigation Institutions. By ELWOOD MEAD. A discussion of the economic and legal questions created by the growth of irrigated agriculture in the West, by the Chief of Irrigation and Drainage Investigations of the Department of Agriculture. *Price, \$1.25*

Land Draining. By MANLY MILES. A handbook for farmers on the principles and practise of draining, giving the results of his extended experience in laying tile drains. *Price, \$1.00*

Land of Little Rain, The. By MRS. MARY AUSTIN. A nature book of the highest type. The volume is made up of a series of sketches of the human, animal, and plant life found in the region of the Mohave desert, Death Valley, and the Sierras, much of which the average person is likely to consider almost devoid of living things. *Price, \$2.00*

Our National Parks. By JOHN MUIR. If you want to learn about the glaciers, mountain peaks, canyons and great waterfalls of the West; of the habits of animals from the squirrel to the moose; plant life from the big trees to the wild flowers—in fact be brought face with nature's works, this is the book. *Price, \$1.85*

Trees and Shrubs of Massachusetts. EMERSON. Two volumes. Plain cloth edition has 148 plates. The colored edition has 36 of these in colors. *Price, plain, \$12.00. Price, colored, \$18.00.*

The Earth as Modified by Human Action. By G. P. MARSH. A Revision of Man and Nature. Describes changes in the face of the earth caused by man, including desolation of various countries, once thickly inhabited, by removal of forests. Shows importance of maintaining natural balance of forces. *Price, \$3.50*

The Longleaf Pine in Virgin Forest. A Silvical Study. By G. FREDERICK SCHWARZ. This is a study of the life history of this important forest tree. Intended primarily for foresters and forest students; also for owners and managers of pine timber lands. Deals with the preference or dislike of the species for particular conditions of soil, climate, and environment. Illustrations and six tables. *Price, \$1.25*

IMPORTATIONS

Beautiful Rare Trees and Plants. By the EARL OF ANNESLEY. A description of some of the rarer English trees, shrubs and vines, illustrated copiously. *Price, \$12.00*

Forests of Upper India and Their Inhabitants. By THOMAS W. WEBBER. This volume is an account of the author's life in India during the period shortly after 1857. It contains a vivid description of the country, its people, customs, etc., with some description of its forests and timber wealth. *Price, \$5.00*

IRRIGATION ENGINEERING AND CONSTRUCTIVE WORK

Design and Construction of Dams. By EDWARD WEGMANN. This volume includes an authoritative discussion of the constructive work involved and the principal forms of construction. Masonry, rock-fill and timber dams are discussed extensively. *Price, \$6.00*

Improvement of Rivers. By B. F. THOMAS and D. A. WATT. This volume is a treatise on the methods employed for improving streams for open navigation and for navigation by means of locks and dams. *Price, \$6.50*

Irrigation Engineering. By HERBERT M. WILSON. This is the fourth edition of Mr. Wilson's popular work, and the revision and enlargement which it has undergone, places it at the forefront of text books on the subject for American students. *Price, \$4.00*

Engineering for Land Drainage. By C. G. ELLIOTT. A manual for laying out and constructing drains for the improvement of agricultural lands. *Price, \$1.50*

Reservoirs for Irrigation, Water-power, and Domestic Water-supply. By JAMES DIX SCHUYLER. An account of various types of dams and the methods and plans of their construction, together with a discussion of the available water-supply for irrigation in various sections of arid America, distribution, application, and use of water; the rainfall, runoff, and evaporation from reservoirs, and effect of silt, etc. *Price, \$5.00*

Water Supply Engineering. By A. PRESCOTT FOLWELL. A treatise on the designing, construction and maintenance of water-supply systems, both city and irrigation. *Price, \$4.00*

Water Power. By JOSEPH P. FRIZZELL. An outline of the development and application of the energy of flowing water. Price, \$5.00

Concrete, Plain and Reinforced. By FREDERICK W. TAYLOR and SANFORD E. THOMPSON. Designed for practicing engineers and contractors; text and reference book for students. Discusses materials, processes, and applications of concrete in construction and specifications. Price, \$5.00

Hydraulics. By MANSFIELD MERRIMAN. Purpose of book is to keep abreast of modern progress, and present subject with conciseness and clearness. Gives general principles and discusses flow of water through various kinds of openings and channels. Historical notes and references. Price, \$5.00

Foundations. By W. M. PATTON. A practical treatise explaining fully the principles involved. Numerous descriptions of important modern structures are given in sufficient detail. Includes articles on use of concrete in foundations. Price, \$5.00

Masonry Construction. By IRA O. BAKER. Contains results of a great number of experiments, and a large amount of practical data on cost of masonry, pile driving, foundations, culverts, etc., and 97 tables to facilitate estimating. Price, \$5.00

Reinforced Concrete. By ALBERT W. BUEL and CHARLES S. HILL. A treatise for designing and constructing engineers, governed by American practice and conditions. Theoretical discussions omitted, and replaced by practical working formulas, examples of representative structures, and records of practice. Price, \$5.00

BOOKS ON RELATED SUBJECTS

Utilization of Wood Waste by Distillation.—By Walter B. Harper. An important treatise on a subject regarding which the interest is great and the information scarce. Is intended to aid in the establishment and conduct of wood distilling enterprises on a business basis. Price, \$3.00

The Garden

Roses and How to Grow Them. By many Experts. In text, practical; in subject and quality of illustrations, beautiful. Price, \$1.20

Ferns and How to Grow Them. By G. A. WOOLSON. The growing of hardy ferns, both in the garden and indoors. Price, \$1.20

Lawns and How to Make Them. By LEONARD BARRON. For the first time the subject of lawn seed mixtures is set forth and explained. 32 photographs. Price, \$1.20

How to Make School Gardens. By H. D. HEMENWAY. This suggestive little book is a practical manual of school gardening for both teacher and pupil, and supplies the first adequate work of the sort in this country. There are to-day a hundred thousand school gardens in Europe, and the progress of the recent movement in America has been most rapid. This volume is based on actual experience (the author is an authority and director of the Hartford School of Horticulture). Illustrations, 10. Price, \$1.10

How to Make a Fruit Garden. By S. W. FLETCHER. An eminently practical work on the subject of fruits for the home. With 182 photographic illustrations by the author. Price \$2.25

How to Make a Flower Garden. A charming and a practical book by experts on every branch of the subject. More than 200 beautiful photographs. Price, \$1.75

How to Make a Vegetable Garden. By EDITH L. FULLERTON. The only adequate book on the home vegetable garden. 250 photographs by H. B. Fullerton. Price, \$2.20

Art and Craft of Garden Making. By THOMAS H. MAWSON. Third edition of this standard; out of print for a year, and now reissued in revised form. Over 100 plans and details of gardens. Methods employed by successful designers carefully analyzed. Characteristic sites in typical districts described and pictured. Price, \$15.00

The Home and Farm

The Country House. By CHARLES EDW. HOOPER. A practical manual of house building, absolutely invaluable to everyone with a country place. It covers every branch of the subject in detail and treats of the garden and its furnishings in connection with the dwelling. 380 photographs and plans. Price, \$3.30

Three Acres and Liberty. By BOLTON HALL. Description of what can be accomplished on a small place in the way of gardening, home-making, and addition to financial resources. Were it not for the unimpeachable authorities quoted, its statements as to the possibilities of the "Little Lands" for a living would seem fanciful. Price, \$1.85.

The Making of a Country Home. By J. P. MOWERAY ("J. P. M."). This delightful story showed its universal appeal when published serially, and the volume amply carries out the intention of the author. Besides its practical interest for the thousands of city dwellers who have dreamed of having a country home, the story is one of such reality, humor, and interest as to ensure it the widest circulation in book form. Elaborately decorated. Price, \$1.65

The First Book of Farming. By CHARLES L. GOODRICH. No one interested in farming, old or young, can fail to appreciate this book, for it really gives the fundamental knowledge of how to conduct a farm with the least expense and the largest return. There are 63 full pages of helpful illustrations. The price is extremely low for a work of such value. 63 pages of photographs. Price, \$1.10

Nature Books

American Food and Game Fishes. By DAVID STARR JORDAN and B. W. EVERMANN. Fills a long-felt need in popular scientific works, being a full account of the life-histories and methods of capture of North American food and game fishes. The only book in existence which will enable the amateur readily to identify species new to him. With 10 lithographed color plates, 100 photographs of live fish in the water, and 200 text cuts. Price, \$4.40

Nature Biographies. By CLARENCE M. WEED. This volume is a sort of personal acquaintance with the lives of the more common butterflies, moths, grasshoppers, flies, and so on, the sort of fascinating details of these insect existences which make the reader want to go out and study these every-day marvels for himself. 150 photographic illustrations. Price, \$1.50

The Brook Book. By MARY ROGERS MILLER. A brook is one of the most living and companionable features of the landscape, and few people, even the most ardent nature lovers, realize what an endlessly interesting study its changes and its throbbing life afford. It is a fascinating subject which the author (well known as a teacher, lecturer, and writer connected with the Nature Study Bureau at Cornell) handles with much ability. 16 photographs. Price, \$1.50

Outdoors. A Book of the Woods, Fields and Marshlands. By ERNEST MCGAFFEY. Papers on out of doors, showing a love of nature and keenness of observation and power and beauty of description rarely surpassed. Price, \$1.25

Nature and The Camera. By A. RADCLYFFE DUGMORE. Mr. Dugmore is an expert in the new movement of photographing live birds, animals, fish, flowers, etc. His works brought him so many requests for information, that he has set down here a full and detailed account of his methods. From the choice of a camera to questions of lighting, and to the problem of "snapping" shy birds and animals in their native haunts, every step is explained so simply as to be easily comprehended, even by the beginner. 53 photographic illustrations. Price, \$1.50

THE American Forestry Association

Officers for 1908

President

HON. JAMES WILSON, Secretary of Agriculture

Vice-Presidents-at-Large

DR. EDWARD EVERETT HALE	DR. B. E. FERNOW	
N. J. BACHELDER	GEO. FOSTER PEABODY	GEO. C. PARDEE
RUTHERFORD P. HAYES	ALBERT SHAW	
W. W. FINLEY	J. T. ROTHROCK	
GEO. T. OLIVER	CHARLES R. VAN HISE	

Advisory Board Selected by Affiliated Organizations

SILAS W. GARDNER	H. H. WHELESS	
GEORGE T. CRUFT	PHILIP W. AYRES	ROBERT C. LIPPINCOTT
GEORGE F. CRAIG	C. A. SMITH	
GEORGE E. STONE	ALLEN CHAMBERLAIN	D. E. KLINE
E. F. SAWYER	F. E. WEYERHAEUSER	KENT SHEPPARD

Members of Board Designated as Vice-Presidents of Association

N. W. McLEOD	LEWIS DILL	FRANK W. ROLLINS
WILLIAM IRVINE	EDWIN A. START	D. E. KLINE

Secretary, THOMAS ELMER WILL, Washington, D. C.

Assistant Secretary, WILLIAM CANFIELD LEE, Washington, D. C.

Treasurer, OTTO LUEBKERT, Washington, D. C.

Directors

JAMES WILSON	WILLIAM L. HALL	W. J. MCGEE
GEO. P. WHITTLESEY	GEORGE K. SMITH	PHILIP W. AYRES
JAMES H. CUTLER	WILLIAM S. HARVEY	ROBERT GARRETT
HENRY S. GRAVES	H. A. PRESSEY	LIGON JOHNSON
F. H. NEWELL	ASBURY F. LEVER	FILIBERT ROTH

Application for Membership

To THOMAS ELMER WILL

Secretary American Forestry Association

1311 G Street, N.W., Washington, D. C.

Dear Sir: I hereby signify my desire to become a member of the American Forestry Association. Two Dollars (\$2.00) for annual dues are enclosed herewith. Very truly yours,

Name _____

P. O. Address _____

. . T H E . .
AMERICAN FORESTRY ASSOCIATION

President—**HON. JAMES WILSON,**
Secretary of Agriculture.

The American Forestry Association was organized in 1882, and incorporated in January, 1897. It now has over 6,600 members, residents of every State in the Union, Canada, and foreign countries. From its origin it has been the tireless friend of the forests.

The object of the Association is to promote the preservation, by wise use, and the extension of the forests of the United States; its means are agitation and education; it seeks to encourage the application of forestry by private owners to forest holdings, large or small; and it favors, especially, the establishment and multiplication of National and State forests, to be administered in the highest interests of all.

The Association seeks as members all who sympathize with its object and methods, and who believe that our natural resources constitute a common heritage, to be used without abusing and administered for the common good. Seeking to conserve our supplies of wood and water, the Association appeals especially to wood-producers and users, including owners of wood lands, lumbermen, foresters, railroad men, and engineers; and to those dependent upon equable stream flow, as manufacturers, irrigators, employers of water power, and those engaged in internal commerce.

The Association meets annually in Washington. It publishes, monthly, **FORESTRY AND IRRIGATION**, the magazine of authority in its special field. The list of contributors to this publication includes practically all persons prominent in forest work in the United States, making it alone worth the cost of Annual Membership in the Association.

The dues, covering a subscription to **FORESTRY AND IRRIGATION**, are as follows: Annual—For Annual Members, \$2; for Sustaining Members, \$25; Total, with exemption from all other payments—for Life Members, \$100; for Patrons, \$1,000.

THOMAS ELMER WILL, Secretary.

Address: 1311 G Street, N. W., Washington, D. C.

HARVARD UNIVERSITY

The Graduate School of Applied Science and
The Lawrence Scientific School

offer graduate and undergraduate courses in Civil, Mechanical, Electrical, Mining and Metallurgical Engineering, Architecture, Landscape Architecture, **Forestry**, Physics, Chemistry, Biology and Geology.

For further information, address W. C. SABINE, 15 University Hall, Cambridge, Mass.

FOR SALE

SET OF

SARGENT'S SILVA OF NORTH AMERICA

Fourteen volumes in original boxes. Cost \$350 net; offered at \$265 net. Also a number of books on FORESTRY and BOTANY. Address

W. W. ASHE

Forest Service Washington, D. C.

TREES THAT GROW

Apples 5c, Peach 5c, Plums 12c, Cherries 17c. Best quality, good bearers, grafted stock, not seedlings. Concord Grapes \$2.50 per 100, Forest Tree Seedlings \$1.00 per 1,000 up. We pay the freight.

GERMAN NURSERIES & SEED HOUSE
CARL SONDEREGGER, Prop.

We have a complete line of Vegetable and Flower Farm Seeds. Our large illustrated catalog free.

GERMAN NURSERIES,
Box 105, BEATRICE, Neb.

Philippine Bureau of Forestry

WANTED—Two foresters with field experience. Minimum salary \$1600. Travel expenses allowed, also liberal leave privileges.

At least seven months interesting field work per year.

For information concerning travel allowances to Manila, Civil Service rules, health conditions, in fact any information in regard to the Islands, apply to the **Bureau of Insular Affairs**, War Department, Washington, D. C.

Make Your Unproductive Land Profitable

Don't let a part of your land be idle because of a lack of water. Irrigate it. If there's a running stream or spring on any part of your farm the water can be delivered just where it will do the most good. Simply install a

NIAGARA HYDRAULIC RAM

and start it going. Then it works day and night without attention or cost. Better than a gasoline engine or windmill. Write for booklet B, and guaranteed estimate.

NIAGARA HYDRAULIC ENGINE CO., 140 Nassau St., New York. Factory: Chester, Pa.



"TREE SEEDS"

Pine, Larch, Spruce,
Catalpa, Ash, Locust,
Etc.

Let us send you our DESCRIPTIVE CATALOGUE of TREE SEEDS. It will meet all your requirements

OUR NEW SEEDS ARE NOW IN STOCK AND ARE READY FOR PROMPT DELIVERY

Estimates on large quantities promptly submitted

Write today. The catalogue is free, of course

OTTO KATZENSTEIN & CO.

Tree Seedsmen

35 W. Alabama St.

Atlanta, Ga.

THE Pennsylvania State College

A thorough and practical undergraduate course in technical forestry, preparing men for all lines of professional and applied forestry.

Special attention is paid to practical field work in surveying, mapping and forest measurements. One of the largest of the State Forest Reserves is within a short walk of the college.

For information regarding entrance requirements, expenses, etc., address

Department of Forestry

State College, Penna.

FORESTRY AND IRRIGATION

THOMAS ELMER WILL
WM. CANFIELD LEE

Editor
Associate Editor

CONTENTS FOR MARCH, 1908

VIEW IN INTERIOR OF A EUCALYPTUS GROVE *Frontispiece*

EDITORIAL:

The Constitutional Question.....	119	New Mexico Industry.....	127
Individual or State Action.....	120	Another Municipal Forest.....	127
If the Nation is Impotent.....	120	Immense Southern Water Powers.....	127
Express Powers.....	121	Harvard Men in Maine Woods.....	128
What Are Constitutions For.....	122	Kansas Agricultural College.....	128
Take Off the Taxes.....	122	Iowa Agricultural College.....	128
A Practicable Reform Press.....	123	An Academy Teaches Forestry.....	128
Mexico's Opportunity.....	123	Abrasive Materials in United States.....	128
		A New Forestry Society.....	128
		West Virginia Forestry Association.....	128
		Colorado Forestry Meeting.....	129
		Commission in South Carolina.....	129
		New Jersey Legislation.....	129
		Tax Reform in New York.....	129
		New York Board of Trade.....	129
		Irrigation and Bridging.....	129
		Irrigation Around Spokane.....	130
		New Irrigation on Kootenai.....	130
		Every Acre of Forest Reserved.....	130
		Banking and Forestry.....	131
		Forest Extension in Ireland.....	131
		Siberian Timber Shipped 8,000 Miles..	131
		Jewel Cave National Monument.....	132
		A Business Forestry Association.....	132
		Not So Costly After All.....	132

NEWS AND NOTES:

Annual Meeting of American Forestry Association.....	124		
Congressional Hearing on Appalachian Bill.....	124		
Appalachian Bill Necessary.....	124		
Index for 1907, Vol. XIII.....	125		
Eucalyptus Trees in Florida.....	125		
Destruction of Lowland Forests.....	125		
The Earth Modified by Man.....	126		
Pioneer Farmers Hear About Trees.....	126		
Lumbermen and Railroads.....	126		
Voting on State Tree.....	127		
Maine Women's Clubs.....	127		

ANNUAL MEETING OF THE AMERICAN FORESTRY ASSOCIATION.

Reported by Mrs. Lydia Adams-Williams.....	133
CONSTITUTIONALITY OF THE APPALACHIAN BILL. By Harvey N. Shepard.....	139
THE PRESIDENT'S ANNUAL ADDRESS. By Hon. James Wilson. (<i>Illustrated</i>).....	143
IMPROVEMENT OF OUR HERITAGE. By Gifford Pinchot. (<i>Illustrated</i>).....	148
ANNUAL REPORT OF THE BOARD OF DIRECTORS FOR THE YEAR 1907. (<i>Illustrated</i>).....	153
THE OAK DEFIANT. (<i>Poem</i>). By Frederick Le Roy Sargent.....	162
PROPRIETY AND NEED OF FEDERAL ACTION. By Hon. Hoke Smith.....	163
A HICKORY TREE ON ARBOR DAY. (<i>Poem</i>).....	165
WORK IN A NATIONAL FOREST. By Charles H. Shinn. No. 6: CHRISTMAS IN SIERRA NORTH.....	166
U. S. RECLAMATION SERVICE.....	170
U. S. FOREST SERVICE.....	172
WITH MEMBERS AND CORRESPONDENTS.....	173

FORESTRY AND IRRIGATION is the official organ of the American Forestry Association. Price, \$2.00 per year, including Annual Membership in the Association. Copyright, 1907, by The American Forestry Association. Entered at the Postoffice at Washington, D. C., as second-class mail matter.

Published Monthly at
1311 G STREET, N.W. WASHINGTON, D. C.

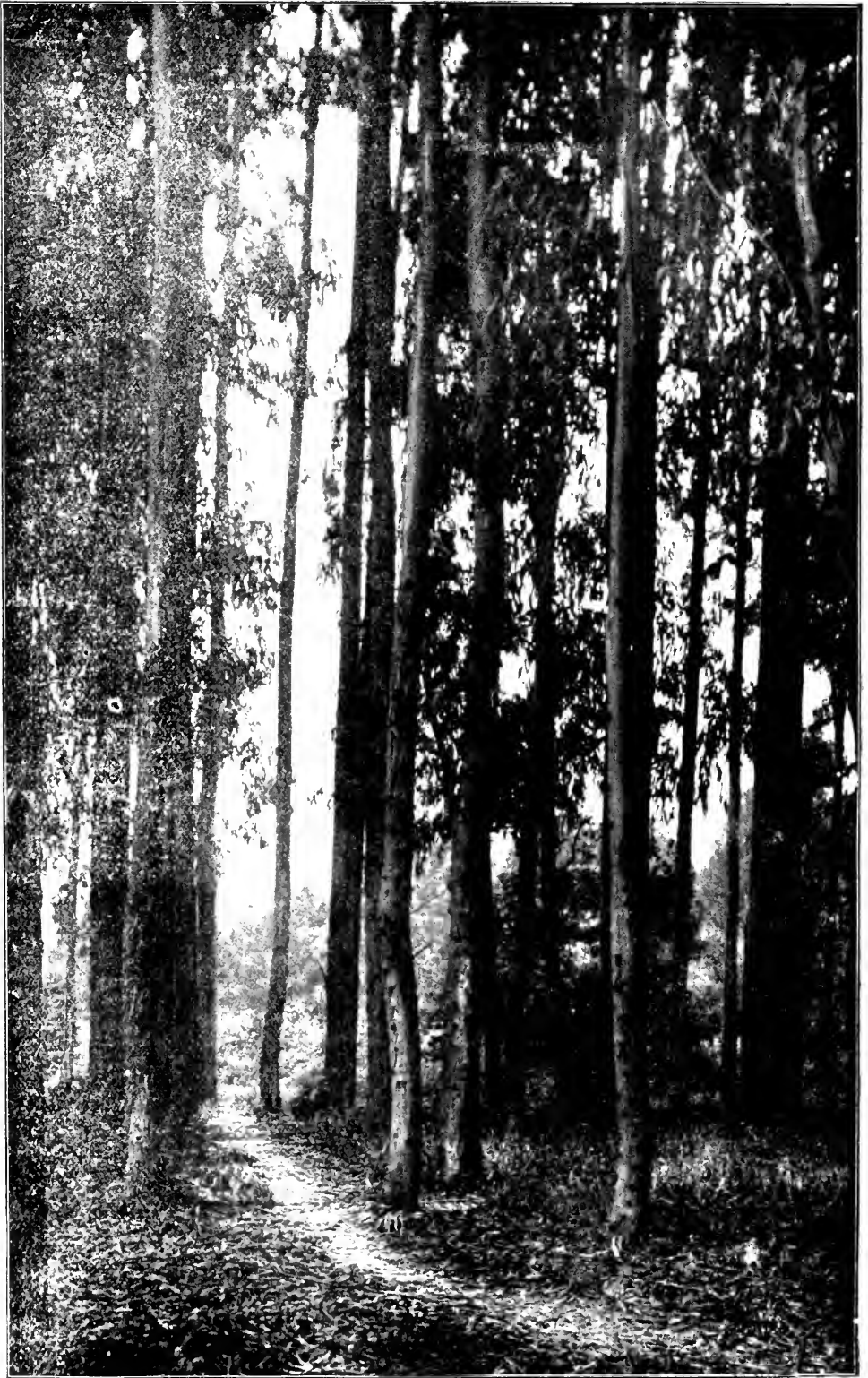

View in interior of a eucalyptus grove



FORESTRY AND IRRIGATION

VOL. XIV

MARCH, 1908

No. 3

EDITORIAL

The Constitutional Question

As might have been expected to occur in due course, the Appalachian-White Mountain Bill is, at this writing, facing the legal sphinx. The question is, Is such legislation constitutional?

At the Annual Meeting this question was argued by Mr. Harvey N. Shepard and also by Congressman Lever. On the following day, at the hearing before the Committee on Agriculture of the House of Representatives, Mr. Shepard again and, also, Hon. Hoke Smith, Governor of Georgia, spoke to the same question. Since then, the House has referred the bill to its Committee on Judiciary, before which a hearing has been announced for Thursday, February 27th.

Dr. Samuel Johnson once declared that "'Patriotism' is the last refuge of a scoundrel." Likewise, since the beginning of our constitutional era, constitutionalism, though sometimes in order, has usually proved the last refuge of the obstructionist. In his Constitutional History of the United States Dr. Von Holst has commented pointedly on this fact. When all other

arguments against a genuinely good thing have failed, its opponents seek to prove it "unconstitutional."

Consider the situation. As is well known to the readers of this publication, it includes such facts as the following: Our forests are going at a rate which will consume them in about a third of a century; the beginnings of a timber famine are already with us. The reclamation of our Western deserts depends upon the existence of forests in the mountains adjacent to the deserts. Largely through deforestation, one billion dollars worth or more of fertile soil is annually being swept into our rivers and harbors; thus, at one and the same time, impoverishing our fields, impairing our commerce, and occasioning disastrous floods, costing the Nation annually some hundred million dollars. Our inland waters, our greatest natural resource, are largely running to waste, an amount representing an investment of more than one billion dollars running idly over Government dams. To the conservation of these waters, forests are essential. The question, again, of draining our swamps is closely connected with that

LIBRARY
NEW YORK
BOTANICAL
GARDEN

of conserving our forests. In a word, we are, by the power of steam, pursuing the course travelled on foot and in ox-cart by the ancient nations—the course that leads directly to national impoverishment, decay and senility.

Individual or State Action Now the question arises. What can we do about it? Shall we look to individuals for salvation? If so, we are met by the current political economy which teaches that "business is business," that "sentiment" has no place in it, and that each must look out for his own interests, whatever happens to the interests of his neighbor or the public. And business, of course, with rare exceptions, is quick to take this cue. The result is forest slaughter, with the desolation that follows in its train.

Suppose, next, we look to the States: Can they solve the problem? As frequently brought out, the individual State is helpless; the cause frequently occurring in one State and the effect in another. If, as has been suggested occasionally, groups of States endeavor to solve such a problem we encounter, first, the fact that groups of States have no central, coordinating head: no legislative, no executive, and no judicial powers. Groups as groups are helpless. Again, groups of States are forbidden to take action. The National constitution, in clause 1, of Section X, of Article 1, declares, in terms, "No State shall enter into any treaty, alliance, or confederation;" while clause 3 of the same section provides: "No State shall, without the consent of Congress * * * enter into any agreement or compact with another State." In the face of language like this, will the man with an acute constitutional conscience ask the States to act jointly in such a matter?

Further, as Governor Glenn reminded Speaker Cannon in the hearing before the latter official last winter, certain States once attempted

group action in a matter which they conceived to be of common concern to themselves. Since that time, this method of action has been even less popular than before.

If this were a case in which the States were jealous of their powers and were insisting that such action as is taken should be taken by themselves, the matter would be different. On the other hand, almost all the States involved have, through their legislatures, already acted, conceding to the Government full powers in the premises.

If the Nation is Impotent

Suppose, now, the National Congress is constitutionally inhibited from proceeding; where do we stand? With individuals injuring, rather than improving the situation; with States individually helpless and, in groups, destitute of organized agencies and twice-over specifically forbidden by the National constitution to proceed, the American people are helpless. They may sit idly and watch the foundations dug from under their National structure, their resources dissipated and their Eden gradually transformed into a desert, but they cannot act in their own defense. That "self-defense" which is "the first law of nature" they may not even attempt. The "public safety" which, in Rome, was "the supreme law" counts for nothing with them. Can it be believed, for a moment, that an intelligent people ever intended thus to bind themselves, hand and foot, with a bit of writing, and, in fact, actually did so?

On the contrary, it was precisely that the American people might escape the condition of impotence and helplessness in which they found themselves under the Articles of Confederation that they authorized the calling of the constitutional convention of 1787. And this body, itself, that it might deliver the country from this same condition of constitutional bondage, deliberately violated its own instructions, namely to amend the Arti-

cles, and proceeded, purely of its own motion, with no authority whatever so to do, and behind closed doors, to formulate an entirely new constitution. And are we to believe, now, that this document, fifteen times amended, still leaves the people in a straitjacket, and incapable of safeguarding their most fundamentally important material interests?

"Express Powers That the constitutional question should be raised on the Appalachian-

White Mountain Bill implies that those who raise it still hold to the old doctrine of "express" powers. As some make the Scripture text to read, "The poor ye *shall* have always with you," so some make the tenth article of the constitution read, "The powers not *expressly* delegated to the United States * * * are reserved," etc. But the word "expressly" has no more place in the second quotation than the word "shall" has in the first. It was long since discovered that to confine the powers of the National Government to those "expressly" delegated to it would be to leave that Government in a position but a degree in advance of the intolerable one under which it was left by the articles; and that any one in this year of grace imagines the National Government to be operating only under such limited powers seems incredible. In what article, section and clause are we to look, for example, for express powers to do the several things which Congressman Lever, at the Annual Meeting, reminded constitutional inquirers the Government had already done; to appropriate annually five hundred thousand dollars to control the cotton boll weevil, to appropriate another half million to stamp out the foot and mouth disease, and still other money to destroy the green-bug? Where shall we look for the express power of Congress to enact a tariff law, to charter national banks, to authorize such banks to issue notes, or to aid in building privately owned railroads, Western or other? Upon what ex-

press grant of power is built up the tremendous work of the Geological and Coast surveys, and of the Agricultural Department? Under which of its eighteen specific powers was Congress authorized to empower the President to proclaim National Forests on the public domain, or to establish the work of National irrigation? Which clause gave Congress power to authorize the laying of a Government cable in Alaskan waters, the digging of a Panama canal, and the ownership and operation of a railroad in connection therewith? And will some legislator, with a constitutional conscience, point to the chapter and verse in the constitution declaring that the Congress shall have power to dredge out the Mississippi river and provide its channel with jetties? As a matter of fact, if the National Government undertook to run on the basis of "express" powers only it might as well shut up shop, once for all, and go out of business. Thomas Jefferson discovered this when, as President, there came to the Nation, through him, the unparalleled opportunity to obtain possession, for a trifle, of the imperial domain known as the "Louisiana Purchase." As a strict constructionist, President Jefferson could find in the constitution no power to buy the territory; but as an American citizen and National executive, he saw in his hand an opportunity that it would be unpardonable to cast aside; and although, as he declared, "the Constitution had to be stretched until it cracked," he bought Louisiana. What would we think of him to-day had he, through a constitutional quibble, turned the opportunity down? And what will future generations think of the Sixtieth Congress if, by a similar quibble, it permits the abomination of desolation to continue in the field of our indispensable natural resources?

Some, otherwise "confused and doubtful," admit that the third of the specific powers of Congress, that namely "to regulate commerce among the several States" settles the case affirmatively; and the constitutional

arguments thus far made have been based primarily on this clause. Obviously, the question of interstate commerce is clearly involved, for the Appalachian-White Mountain rivers are interstate rivers and carry commerce which the destruction of the forests is gravely imperiling.

What Are Constitutions For? But suppose there were no interstate rivers and interstate commerce involved, are we to concede the validity of the constitutional objection? As the Great Teacher asked regarding the Sabbath, so we may ask regarding the constitution: "What is its reason for existence? Is it to help men, or to hinder them? Is it to build up, or to pull down; to save life, or to destroy? Is it designed to stand as a barrier in the way of National progress and well-being, or as a vehicle to bear our people on to the realization of their possibilities and the fulfillment of their destinies?"

The answer to this question is found in the preamble, which gives six reasons why this constitution was ordained and established. Of these, the last three bear directly upon the proposition in hand. The constitution was designed to "provide for the common defence, promote the general welfare, and secure the blessings of liberty" to the generation then living and to posterity. Congress is specifically authorized (Clause 15 of Section VIII) to "repel invasions." But suppose, by oversight, these two words had been omitted. Shall we believe that, with an invading army landing upon our coast, the two houses of Congress would sit mute and impotent in their seats and permit the land to be desolated by flame and sword? In case constitutional phraseology were desired as a warrant, would they not quickly seize upon the language of the preamble and "provide for the common defence" by contriving appropriate means for repelling the enemy?

And what difference can it make to

the American people, present or to come, whether their land is desolated by a military or an industrial army; whether they be impoverished for the enrichment of kings, or of millionaires; whether their wealth be drained away from them in the form of tribute to conquerors, or through the erosion of their fields and the flooding of their homes and hives of industry?

What do we mean by "the blessings of liberty," unless we include in the list of such blessings the liberty to supply our material wants? And if the "general welfare" be not involved in this question, in what question, pray, may we expect to find it?

And if the general welfare is indeed involved, and specific constitutional warrant is still desired, let the anxious, hesitating legislator read the first of the enumerated powers of Congress (Clause 1 of Section VIII): "The Congress shall have power to lay and collect taxes, duties, imposts and excises, to pay the debts and provide for the common defence and general welfare of the United States." What more can he ask than this? At the hearing, on January 30th, it was demonstrated beyond all question or doubt, to the Committee on Agriculture, as it had been demonstrated to the same committee some two years ago, and is being constantly proved to the public, that the general welfare is vitally concerned in this question. Let Congress now proceed to exercise its specific and "expressly delegated" power and "provide for the general welfare" by passing the Appalachian Bill.

Take Off the Taxes The menace to that great amount of forest land which belongs to private owners from unjustly high taxation is recognized. This menace is most dangerous. If it is worth while for the United States to establish National Forests and for the States to plant trees and encourage the planting of trees, it is preposter-

ous to leave the system of taxation in such condition that trees which are already growing must be cut.

The *Chicago Journal*, in an editorial quoted in FORESTRY AND IRRIGATION for January, urged that all available forest land everywhere should be taken in hand by the United States Government. While constitutional reasons may perhaps prevent the widest application of this policy, there is nothing to hinder State Governments from establishing State forests, or from changing their tax laws.

In the present critical condition of the country bounties for the planting of forests might not be out of place. These, of course, should be on such terms that the young plantings will be properly cared for until they are well grown. The bounty from increased value, however, may be ample inducement, if protection and technical advice are given by the State.

Lands sold for taxes ought to be bought up by the State, as in Wisconsin, and planted to woods; or exchanged for other lands to be planted; or sold, and the proceeds used to buy compact bodies of land for forest planting. Here is a course that is open to every State. Constitutional limitation upon tax reductions will not apply here, because the State forests will not be subject to taxation. Citizens should besiege their legislatures for this.

A Practicable Reform Press The *Western World* has a forestry department conducted by Mr. W. G. M. Stone, president of the Colorado State Forestry Association. Here is a good suggestion for State societies devoted to various kinds of public improvement work. Instead of starting a paper of its own, such a society may often with advantage select a suitable and favorably disposed paper of general circulation, already in existence, and arrange for a special department in it representing the movement for which the society is working. The society might obtain the

privilege of naming the editor of the department, and would give support to the paper in return. A general paper has the vast advantage that it circulates amongst many people who are outside of the movement; yet at the same time this arrangement will cost less than the maintenance of a separate periodical. It would be desirable to make this arrangement with a moderately low-priced paper, so that the society could get its friends to promote the circulation of the paper.

Mexico's Opportunity A correspondent and subscriber of FORESTRY AND IRRIGATION living in the State of Chihuahua, in Mexico, writes:

"There is much timber land in this State and there are no restrictions as to cutting down trees, so that the same mistake is being made of promiscuously cutting down forests that was made in our own country some years ago, before there were regulations in this matter."

This is a great pity. If the States of Mexico would see their opportunity they would regulate the cutting of their forests so that they would have, for years to come, the opportunity of supplying the markets of the United States; and most certainly would this be true if the States and the Mexican Federal Government would take the forests in hand as public property; whereas, if lumber companies are allowed to cut without restrictions, the timber crop will last but a few years and most of the profits will go into the hands of foreign investors.

Financial and lumber papers in this country constantly report fresh movements in the way of building railroads and saw mills for the purpose of developing the lumbering resources of Mexico. The financial stringency in the United States, however, has caused temporary suspension of a number of deals pending for the purchase of large tracts of timber lands by Americans in different parts of Mexico.

NEWS AND NOTES

Annual Meeting of the American Forestry Association The Twenty-Seventh Annual Meeting of the American Forestry Association, at Washington, D. C., January 29th, was memorable. Secretary of Agriculture James Wilson presided.

A full report will be found on another page of this magazine.

Congressional Hearing on Appalachian Bill The annual meeting of the Association was followed the next day by a notable hearing on the Appalachian National Forest bill before the House committee on Agriculture. It was attended by some 200 representatives, from twenty States. These came as representatives of business and professional associations and citizens' organizations which recognize the immense importance to the country of this proposition. They were headed by Gov. Hoke Smith of Georgia. Among them were, from New England and the East:

Philip W. Ayres, Forester, Society Protection of New Hampshire Forests, Forester, Dartmouth College Grant. Henry A. Barker, Department Vice-President "Public Reservations" Committee American Civic Association, Representing Mayor of Providence, Providence Board of Trade, and League of Improvement Societies in Rhode Island. Robert P. Bass, New Hampshire Forestry Commissioner. Thomas H. Dearborn, Concord, N. H.; State Entomologist. C. F. De Forest, New Haven, Conn.; Representing Connecticut Lumber Association. F. C. Dumaine, Treasurer, Amoskeag Manufacturing Company of Boston. Chas. L. Elwell, Concord, N. H.; recently Speaker House of Representatives. R. E. Faulkner, Keene, N. H.; New Hampshire Forestry Commissioner. G. W. Field, Chairman, Commission on Fisheries and Game, Boston. Chas. M. Floyd, Manchester, N. H., Governor of New Hampshire. C. C. Goodrich, Hartford, Conn., Manager Hartford and New York Transportation Company. H. S. Graves, Director, Yale Forest School. James P. Gray, Boston. Hydrographic Enquirer, President Boston Manufacturers' Insurance Company. M. J. Hapgood, Peru, Vt.; representing the Governor and State Forestry Association. William S. Harvey, Philadelphia. Pennsylvania Forestry Association, National Board of Trade. Henry R. Hayes, representing Stone & Webster, Electrical Engineers, 147 Milk street, Boston. E. F. Hitchins, Waterville, Maine. State Entomologist. J. Blakeley Hoar, Brookline, Mass. Appointed by Governor of Mass. Mr. John G. Jack, Forest Department, Harvard University. Lieut.-Governor Lake, Hartford, Conn. Geo. P. Leighton, Vice-President American Civic Ass'n., Monadnock Farms. Arthur Low, Fitchburg, Mass., Pres. Park Hill and Lancaster Manufacturing Companies. J. Horace McFarland, Harrisburg, Pa., President American Civic Association. Hon. John McLane, Governor of New

Hampshire, Milford, N. H. Frank W. Rollins, ex-Governor of New Hampshire, President Society Protection of New Hampshire Forests. Dr. J. T. Rothrock, Harrisburg, Pa., Member Pennsylvania Forestry Commission. Harvey N. Shepard, Boston, representing Commonwealth of Massachusetts. Mass. State Board of Trade, Appalachian Mountain Club. Edwin A. Start, Secretary, Massachusetts Forestry Association, representing that Association and Commonwealth of Massachusetts. Dr. Geo. F. Swain, Prof. of Civil Engineering, Mass. Institute of Technology, Member Boston Transit Commission, representing State of Massachusetts. C. J. H. Woodbury, Boston, Sec'y National Cotton Manufacturers' Association. Clinton Rogers Woodruff, Philadelphia, Pa., Sec'y American Civic Association. Chas. T. Woods, Director, Maine Agricultural Experiment Station, Orono, Maine.

From the South came a distinguished delegation, including:

Mr. E. J. Watson, Commissioner of Agriculture, Commerce and Immigration, S. C.; Prof. L. C. Glenn, Vanderbilt University, Tenn.; W. S. Lee, Jr., Electrical Engineer, Charlotte, N. C.; John Wallace, Jr., Secretary Alabama Forestry Commission and State Game Commissioner; Rutherford P. Hayes, President Appalachian Park Association, Asheville, N. C.; Mark Packard, large owner of coal lands in Eastern Tennessee; Geo. K. Smith, St. Louis, Secretary National Lumber Manufacturers Association; S. B. Smith, lawyer, Chattanooga, Tennessee; Allen M. Schoen, member American Institute of Electrical Engineers, and others.

Appalachian Bill Necessary The day was devoted largely to the hearing of expert testimony, chiefly on the relations of the forests to wood, power and navigation. Mr. Gifford Pinchot, forester, showed that a wood famine is but twenty or thirty years distant. Messrs. Lee, Schoen, Swain, and others, showed the vast significance of water and electric power, and the dependence of both upon forests. The filling of the streams, the loss to navigation, and the cost to Government to remove the sediment was brought out.

Mr. Harvey N. Shepard, an eminent attorney of Boston, gave a convincing argument on the constitutionality of the bill. Governor Smith's last speech also treated this question. Both these addresses will be found in full elsewhere in this issue.

Governor Smith closed the presentation with a powerful argument and appeal for the bill. Chairman Scott, of Kansas, declared that not a single dull moment had marred the entire day's

hearing; and that every member of the committee was convinced of the importance of the measure.

Index For 1907, Vol. XIII Owing to the annual meeting and the work with Congress in connection with the Appalachian Bill, it has been impossible to prepare the index to FORESTRY AND IRRIGATION for the year 1907, or Volume XIII, so soon as would otherwise have been done. Now, however, it will be ready within a few days; and any members or others who preserve their annual files and wish the index can have it on application to this office.

Eucalyptus Trees in Florida During the past few years the blue gum tree, one of the Australian eucalypts, has been planted in parts of southern Florida, and has thrived to such a degree as to assure good results from plantings of that species in the southern section of the peninsula. The successful plantings were made in low sandy soils near Cape Canaveral, about Fort Myers, and elsewhere. The water level is usually less than six feet below the surface, and the trees find no difficulty in obtaining all the moisture needed.

The blue gum and other eucalypts were brought to California from Australia many years ago, and have shown remarkable growth in the warm climate and friendly soils of the Pacific Coast. The eucalyptus becomes a trunk in a few years when conditions are favorable, but it can not withstand severe frost, and for that reason it can be grown with profit only in limited areas of the United States. Much attention is being given to it in California, and hundreds of thousands of trees were planted the past year. Railroads use it for ties and are planting large tracts for that purpose. It has many uses—fuel, posts, poles, and lumber. No tree grows with greater rapidity.

The success which has attended the introduction of this valuable tree in southern Florida proves that it will

prosper there. Although much of the soil is stony, the underground water lies near the surface and the roots of the eucalypt easily reach it. If they can obtain sufficient anchorage to hold the trunks against the force of the wind, success is reasonably sure even in the stony ground, while many situations are available where the soil is deep and is free from stones, and in such places the eucalypts find ideal conditions for rapid growth.

The frontispiece in this magazine illustrates the splendid growth of the eucalyptus in California.

Destruction of Lowland Forests From the Office of Drainage Investigations of the United States

Department of Agriculture comes a note in regard to the forestry situation in the lowlands of the Carolinas and of the Mississippi Valley. It says: "A considerable portion of these lands is heavily timbered and has been purchased by companies and syndicates who are removing the merchantable timber as rapidly as possible, and are placing the lands upon the market for the uses of agriculture. Before they can be made useful for such a purpose they must be adequately drained. The soil is exceedingly fertile and productive when put in proper condition, and yields a far greater return for crop growing than for forestry. It would seem that some restriction should be placed upon this work for the future good of these areas. Within the last few years much valuable timber has been removed and burned in the process of clearing the land for cotton plantations. Since this will not probably be done in the future to any great extent, as the timber is saleable and will yield a revenue, no care is evidently given to the preservation of any timber upon land which can be used for other purposes." It is added that the people of the sections in question apparently think that no shortage of timber will ever result from the course they are pursuing, and that they very much doubt the trustworthiness of the figures

given by various forestry promoters regarding the length of time when the timber supply will be exhausted."

The Earth Modified by Man The *Century Magazine* says editorially: "In view of the prediction by so careful an authority as Mr. Pinchot, that at the present rate of destruction there will be a timber famine in the United States within twenty-five years, it behooves all executives and legislators charged with the affairs of either Nation or State to study this question thoroughly. To such we confidently recommend the famous and interesting volume by the late George P. Marsh, formerly American minister in Rome, entitled "The Earth as Modified by Human Action," the recent reissue of which by the Scribners is a public service. We challenge any one to read the chapters relating to the dire effects of forest destruction in the Mediterranean countries without becoming an ardent champion of a prompt and radical policy, to the end that our own country may escape the same fate."

Pioneer Farmers Hear About Trees Fully seven hundred farmers from Minnesota and the two Dakotas were present at the recent meeting of the Tri-State Grain and Stock Growers' Association, at Fargo, North Dakota. Though interested in everything which could add to their success in making fruitful the windswept prairies, these pioneer farmers were especially eager to learn the secrets of successful tree planting. One entire day was given over to horticulture and its various branches. The importance of the subject of forestry was brought out by four different speakers. These were G. H. Whiting, a pioneer nurseryman, Prof. E. G. Cheyney, of Minnesota Agricultural College, Prof. C. B. Waldron, of North Dakota Agricultural College, and C. A. Kupfer, of the United States Forest Service.

One of the speakers at the convention made a brief synopsis of the

points emphasized in the discussion on tree planting, as follows:

"There is no question regarding the need for tree planting on the northern prairies. Every attempt should be made to protect the farm buildings, animals and orchards from the severe winds which are so hot and dry during the summer and so terribly cold and dry during the winter months. Comfort in the home, complete success in stock raising, and the avoidance of complete failure in orcharding, demand this. Farmers should grow their own fence posts, poles, fuel, repair material, and where waste lands permit, their lumber for barns, sheds, and other uses.

"While the demand for fence posts in these three States is not very great at the present time, it will continue to grow as the country develops and farming becomes more intensive. When agricultural development becomes as great here as in Iowa, where over \$1,000,000 worth of posts are used annually, the annual outlay for such material in these three States will be enormous. It is frequently worth more than the price of the lumber to have a piece of repair material close at hand. All these things the farmers of these States can provide for themselves at a great profit."

Lumbermen and Railroads The lumbermen of the Northwest are working for an amendment to the Interstate Commerce Law that will allow a hearing on all changes in interstate tariffs issued by transportation companies, previous to their taking effect. The publisher of the *Pacific Northwest* states that the railroads have practically confiscated the lumber industry of the Northwest by an arbitrary rate, and the manufacturers have at present no recourse but to let their plants remain idle. For over three months, it is said, fifteen thousand men, with an average daily payroll of nearly \$60,000, have been out of employment in that section.

Voting on State Tree Mrs. W. I. Higgins, Chairman of Forestry Committee, Montana Federation of Women's Clubs, writes that Arbor Day in that State has been changed this year to the third Tuesday in April, which is an improvement on the former date, being more suitable to planting conditions and school work.

She says that this spring the school children are going to vote on a State tree. This vote will take place on Arbor Day.

The literature which they expect to receive from the Forest Service will be distributed by the County Superintendents to the teachers; then the children will make an investigation of the trees and vote for their choice. This is one way of teaching the oncoming generation about trees.

Maine Women's Clubs The Forestry Committee of the Maine Federation of Women's Clubs urges that every club in Maine give this year one program, or at least a part of a program, to that most important subject, forestry. It urges them to arrange a forestry exhibit, to observe Arbor Day, and otherwise promote public sentiment in favor of forestry, and to call attention to the White Mountain-Appalachian forest proposition. It asks also that the club women join the Maine Forestry Association.

At the midwinter meeting of the federation at Lewiston it was unanimously voted to support a movement to make Mt. Katahdin and the adjoining region a State forest reserve.

New Mexico Industry Concurrently with the Sixteenth National Irrigation Congress, to be held at Albuquerque, N. M., September 29 to October 3, 1908, the people of New Mexico will hold a State Industrial Exposition. The congress alone would furnish a large attendance for an exposition if all the delegates should attend the show.

Another Municipal Forest At Prineville, Illinois, a wealthy citizen has given forty acres of woodland to the town, and it is to be used in nature study for the school children. It will be developed and administered as a public property.

Immense Southern Water Powers The streams whose headwaters lie among the peaks of the Southern Appalachians, flowing westward to the Mississippi or eastward to the Atlantic, furnish opportunities for the development of water power so wonderful that the meagerness of their present use for this purpose is little less than marvelous.

Engineers of the United States Geological Survey, after making a careful study of the streams, the quantity of water they carry, and their fall in various portions of their courses, have estimated that they afford a minimum of about 2,800,000 horsepower; at least 50 per cent of which, or 1,400,000 horsepower, is available for economic development. These figures, it should be noted, represent the minimum horsepower. If the flood waters could be stored and the flow of the streams properly regulated, the minimum power available for economic development might be increased from three to fifteen times.

The estimates of the engineers of the Survey are based on the present condition of the drainage area, but if the abuse of the upland area is continued, the available power will be largely reduced. Not the height of the floods; but the length and depression of the low-water season, govern the power that any stream will yield. The more uniform the flow of a river, the greater its value for power, as for all other purposes; and this uniformity is dependent solely on the condition of the land surfaces. An upland bared of forests discharges its rain so quickly that in dry seasons there is no water left in the ground to supply a flow.

Harvard Men in Maine Woods The Senior class in Forestry at Harvard University spent the month of January in a study of lumbering in the Maine woods, under Prof. Austin Cary. Spending a few days about Bangor in manufacturing plants, they examined the logging work of the Great Northern Paper Company and others in the region of Moosehead Lake, and the west branch of the Penobscot; and then, taking the Canadian Pacific Railway to Lake Megantic, worked their way down through the Androscoggin Valley to Rumford Falls. Professor Cary has long been familiar with this region, and going under his guidance the students get not only a clear idea of the method and costs of lumbering and the changes gradually being introduced in the interest of better forestry, but an insight into the controlling business and financial conditions as well.

Mr. J. J. Dearborn, of the class of 1907, on February 1st begins an engagement with the Diamond Match Company. His work will have to do with the company's land holdings in Massachusetts.

Kansas Agricultural College It is expected that before long there will be a forestry course in the Kansas Agricultural College. There are already twenty students enrolled in forestry studies; one class in dendrology, one in silviculture, and one in general forestry. Professor Eastman is planning to organize a tree planting club in the college in the spring term. The interest in these subjects among the students is increasing.

Iowa Agricultural College There are forty-eight students enrolled in the forestry course at Iowa Agricultural College. This number includes senior and junior men in horticulture and forestry, and one class of civil engineers in technology. Several of the students are planning to make forestry their profession. It is interesting, however, to see how

many study forestry who do not plan to make it their special occupation. This implies that the fundamental importance of this factor in our industrial life is coming to be realized.

An Academy Teaches Forestry Not only in collegiate institutions is there room for teaching of forestry; but as technological colleges have their counterparts in industrial high schools, so with forest schools.

Powder Point School, Duxbury, Mass., has just established a preparatory course in forestry. Its announcement will be found in the advertising pages of this magazine.

Abrasive Materials in United States Among the less prominent natural resources of the country are abrasive materials. Over \$2,000,000 worth of abrasives were produced last year, two-thirds of them being natural minerals. The list includes the following: Oilstones and scythestones; grindstones and pulpstones; buhrstones, and millstones; pumice; infusorial earth and tripoli; crystalline quartz; garnet, corundum and emery; carborundum; crushed steel; and alundum (artificial corundum).

A New Forestry Society The American Forest Preservation Society has recently been organized, with the Secretary's office at Corfu, N. Y.

They intend to incorporate under the laws of New York as an educational association; to conduct aggressive propaganda for a large membership, including a junior class for school children; to encourage the organization of tree-planting clubs in every town and hamlet; and to attempt to secure whatever legislation their advisory board deems advisable in the various States and at Washington.

West Virginia Forestry Association On February 11th this office was notified of the organization of a West Virginia Forestry Association, with A.

W. Nolan, Professor of Forestry and Horticulture in West Virginia University, at Morgantown, as secretary. The American Forestry Association welcomes this new organization to the ranks of workers for the preservation of the Nation's resources.

Colorado Forestry Meeting The Colorado State Forestry Association held its 23rd annual meeting on January 22d, with three sessions, morning, afternoon, and evening. This was the most successful annual meeting they have ever held. There was not a weak place in the program. Methods in forestry, forestry education, forestry propaganda, and the Government forest policy, were amongst the subjects discussed.

Commission in South Carolina A resolution has been introduced in the South Carolina Legislature by Hartwell M. Ayer, of Florence, to create a commission to investigate forest conditions in that State and report to the Legislature next year. The proposed commission would include a forestry professor from the State University, one practical lumberman of the State, and two other experts on the subject, together with the Commissioner of Agriculture and Commerce. Though it may not pass this session, it will be brought up again at the next session, and the effort will doubtless improve public sentiment. The plan will also be brought to the attention of the proposed consolidation of waterways interests in that State.

New Jersey Legislation Three forestry bills have just been introduced in the New Jersey Legislature by Senator Minch. One is to amend the law relating to fire wardens and the prevention of forest fires. It makes some radical departures, from which good results are expected. Another amends the forest park reservation law by compensating the townships for the taxes they lose when

land becomes State property. The third provides definite means for controlling fires when they start along railroads.

Tax Reform in New York State Senator Cobb, of New York, has introduced in the New York Legislature a bill embodying the principles of tax reform for woodlands which have been urged in FORESTRY AND IRRIGATION. The bill provides that land devoted to wood, timber and forest products shall be assessed at a rate no higher than the rate on barren land in the same tax district. It is also provided that upon application, the Forest, Fish, and Game Commissioner shall send a forester to inspect such woodlands and recommend measures to promote the growth of trees. Mr. J. S. Whipple, who holds this office, spoke before the Assembly at Albany recently in favor of the bill.

New York Board of Trade The New York Board of Trade and Transportation received from its Forestry Committee a report upon the creation of a forest reserve in the Southern Appalachian Mountains and one in the White Mountains of New Hampshire. The report favored the creation of these reserves, and was unanimously adopted by the Board; and in accordance with a resolution adopted, the secretary of the Board will convey to the Senators and Representatives from New York State a request of the Board that they support the bill in favor of these National Forests.

Irrigation and Bridging William T. Clark, of Spokane, president of the Wenatchee Canal Company, operating at Wenatchee, Wash., announces that when the present irrigation plant is completed, at a cost of \$1,300,000, 21,000 acres of high-grade fruit lands in Chelan County will be brought under the ditch. Five thousand acres are already under the water system, 8,000

acres will be opened this spring, and 8,000 acres more will be made ready before 1910. The lands served by this plant will be devoted exclusively to orcharding. It will be cut off into five and ten-acre tracts for the cultivation of apples, peaches, pears, apricots, walnuts and almonds.

It is now proposed to replace the overhanging flumes in the mountains by tunnels and ditches in the rock. Two miles of tunneling and the filling of twenty-three gulches, ranging from 40 to 300 feet in width and from 30 to 100 feet in depth, will be necessary.

The bridge just completed by Mr. Clark's company to carry the water pipes and afford connection for the people of East Wenatchee, Southside, and Columbia Valley, is the first highway bridge to span the Columbia River in its 2,000 miles of meandering. It was opened to traffic a few days ago. The length of the bridge is more than a third of a mile. The highest point, which is over the piers at anchor arms, is 180 feet from low-water mark.

Irrigation Around Spokane Seven hundred acres of land in five and ten-acre tracts midway between Spokane and Coeur d'Alene, known as East Farms, will be brought under the ditch by the Corbin interests of Spokane early in April, when special trains will be run from Spokane and Coeur d'Alene the day the canal is formally opened. It is expected to put in the first crop this year. The main canal taps the Spokane River at Post Falls, Idaho, just below the "bear-trap" dam recently constructed by the Washington Water Power Company.

Other important irrigation enterprises to be carried out in the vicinity of Spokane next spring are projected by the White Bluffs Irrigation Company and the Hanford Irrigation and Power Company.

New Irrigation on Kootenai Ten thousand acres of land in the Kootenai River Valley, in British Columbia, north of Spokane, will be

put under irrigation next spring, and opened as a fruit-growing district, by a party of Spokane men. J. W. Morrison has been appointed manager.

The tract is thirty miles north of Fernie, near Bayne's Lake, in a district which won prizes at the fruit expositions in England and Scotland. To water the land, the Kootenai River will be tapped at Elko, four and a half miles above the property. Most of this ditch, it is reported, has already been dug, and all the laterals will be constructed, ready for watering the land, by spring. All of the irrigating will be done by gravity.

Soil in the Kootenai Valley is a rich black loam, which is not only productive of fruit, but grows grains and hay of all kinds in abundance. The Great Northern station of Baynes is located on the tract, which is also within six miles of the Canadian Pacific Railroad. The land has been platted into five and ten acre tracts, which will be disposed of to actual settlers at a little more than cost and interest on the capital invested.

Every Acre of Forest Reserved At one stroke of the Lieutenant - Governor's pen 150,000,000 acres of forest land in British Columbia have been placed in reserves. This includes every acre of the province's timber lands, except what has been leased. This is as much land as was put in the National Forests of this country between the years 1891 and 1907.

The action was taken to check wasteful exploitation of timber resources and to bring the care and cutting of timber more effectually under Government control.

The province has been leasing timber land instead of selling it. The most of the leasing has been done in the past three or four years, and Americans hold the largest part of the 10,000 leases now in force. The lease is, in its effect, a long-term option at low rate. It runs twenty-one years, and may be renewed at the end of the

first term. The lessee pays twenty-five cents a year until he is ready to cut the timber, when he pays a royalty of fifty cents per 1,000 feet, board measure, for the timber removed. The income of the province from leases was about \$1,275,000 last year.

British Columbia is the latest of the great soft-wood timber regions to be invaded by lumbermen. The Puget Sound region is still at top notch; but holdings are hard to get, and buyers and speculators have crossed into British Columbia. While there are many rich stands of timber in the province, it is doubtful if the forest woods furnish a cut of more than 100,000,000,000 to 150,000,000,000 feet of lumber—less than this country uses in eighteen months.

A recent issue of this magazine reported the new forest laws of Colombia in South America. That country's northern namesake is not to be outdone in gripping the treasure while it is in hand.

British Columbia does not permit the export of logs cut on provincial land. They must be sawed by mills in the province, which evidently intends not only to take care of its timber, but to make the most out of it. An export duty has been seriously considered by the Dominion Government for all the provinces of Canada. It is apparent that British Columbia will not be slow to take any advantage which the further diminishing of the timber supply of the United States may afford her in the lumber trade.

Banking and Forestry In the annual report of Molson's Bank, mention is made of the forest situation as a factor in the business equation in Canada. Molson's Bank is one of those which, according to the Canadian custom, has many branches, fifty or sixty, scattered throughout the Dominion. At the annual meeting the president of the bank said: "Our forests, which have done so much to enrich the country in the past, are not receiving the pro-

tection necessary to ensure their continuance. Greater exertions should be made, not only to protect the timber limits of the country, but also to replenish the rapidly disappearing timber."

Forest Extension in Ireland

The people of Ireland pay \$5,000,000 a year for the timber which is imported from other countries. This is the penalty of failure to protect its forests. Ireland has only 1½ per cent of its land in timber and much of that small area is covered with scrub growth of little value. At the same time 23 per cent of the island is uncultivated. Few inhabited countries have been so extensively deforested.

The work of changing conditions for the better has been entered upon, however, and scientific forestry will be applied. Consul General Alfred Alfred K. Moe, of Dublin, reports the progress that has been made looking to the preservation of the few remaining forests and the reforestation of vast areas. The Irish Department of Agriculture maintains a forest school at Avondale, which will have charge of the tree planting.

A special study has been made of Lord Fitzwilliam's estate which was planted to timber fifty years ago. A popular objection to reforestation in Ireland has been that forest plantations offer less employment to labor than equal areas of agricultural land. It was shown, however, that Lord Fitzwilliam's forest, although planted on poor soil not valuable for agriculture, had employed four times as much labor as has been employed upon the agricultural land, and was more profitable to the owner. Within the past year timber to the value of \$50,000 has been sold from the plantation, and much remains to be cut.

Siberian Timber Shipped 8,000 Miles

An Australian corporation has just received a concession from the Russian Government to take out 30,000,000 feet of timber a year from a

forest in Siberia, 900 miles from Vladivostok, to be delivered in Melbourne, Australia, approximately 8,000 miles away, and nearly three times the distance from New York to San Francisco.

It is likely that no lumbering operation of recent years more strongly illustrates the pinch in the timber supply in all parts of the world. In the news of the concession, told in an American lumber journal, is the suggestion of the difficulty that all countries may have to encounter in getting the wood which they need in the future. Every year timber cruisers are going further and further afield and cutting trees which in former times of abundance they passed because of the inaccessibility of the forest.

In taking out the Siberian timber the Melbourne lumbermen will have to ship the entire year's cut in July, August, September, and October, for during the remainder of the year there is no open water at the point of shipment.

What makes this unusual feature of transporting bulky logs 8,000 miles quite feasible is that such unmanufactured stock is admitted free, while there is a heavy duty on all manufactured wood brought into Australia, the duty on lumber, for instance, being nearly five dollars a thousand board feet. At Melbourne a new mill is being erected to manufacture these logs into dressed stock, such as flooring, ceiling, and other products, as well as into lumber.

In this country it is customary to have new mills conveniently near the place of production, though, with the continually decreasing supply, the larger mills often find it profitable to haul their timber by trams and railroads many miles to their saws. The hope of the United States for a steady supply of timber lies in the application of forestry to all timber lands, private and public.

Jewel Cave National Monument The President has just signed a proclamation creating the Jewel Cave National Monument within the Black

Hills National Forest, South Dakota. This remarkable cave, which is located thirteen miles west and south of Custer, the county seat of Custer County, in a limestone formation, is believed by geologists to be an extinct geyser channel. The national monument will embrace an area of 1,280 acres.

This cave, which was explored as late as 1900, has been found to consist of a series of chambers connected by narrow passages with numerous galleries, the walls of which are encrusted with a magnificent layer of calcite crystal. The opening of the cave is situated in Hell Canyon, the walls of which are high and precipitous.

The surface of the country in which the cave is located consists of a high rolling limestone plateau about 6,000 feet above sea level.

A Business Forestry Association The Hampden Forestry Association has been started in New York, not for propaganda purposes, but as a business enterprise. It intends to buy and deal in forest properties and water rights on such properties; to start a nursery and plant trees; and to conduct any business, such as farming, that is necessary in connection with the administration of its forest property.

If the taxation problem could only be solved, forest development would offer an attractive field for investments; and it may do so anyway.

Not So Costly After All Miss Mira Lloyd Dock, of Fayetteville, Pa., member of the Pennsylvania State Forestry Commission, said at the recent yearly meeting of the American Civic Association:

"The cost of establishing a forest reserve and even of maintaining it for some time without expectation of revenue is not only relatively but absolutely less than the loss from forest fires and from the devastating character of floods originating from waste lands. The work of restoring the forest takes time, but not so much time as is commonly supposed."

ANNUAL MEETING OF THE AMERICAN FORESTRY ASSOCIATION

REPORTED BY

Mrs. Lydia Adams-Williams

In animation and inspiration, in oneness of purpose, in sanguine and unquainted faith for ultimate success, in breadth of technical and expert testimony introduced, in scope and weight of argument advanced, in eloquence and logic, and, lastly, in the splendid and unsurpassed personnel of those in attendance, the twenty-seventh annual meeting of the American Forestry Association, which was held in the red room of the New Willard, in Washington, D. C., on January 29, 1908, in three sessions, forenoon, afternoon, and night, outshone and totally eclipsed any previous meeting of the Association.

Noticeable among the audience were several earnest and interested women, among them Mrs. Grace M. Stoddart and Mrs. Josephine A. Rich, nearly all of whom took notes of the proceedings, some for the newspapers and journals they represented, and others that they might make reports to the clubs which sent them as delegates.

The meeting was opened by the Secretary of Agriculture, James Wilson, President of the American Forestry Association, who gave his annual address, and whose cordial, true-ringing words of welcome expressed the kind and genuine personality of the man, and sank deep into the hearts of his hearers, to be remembered and cherished long after many incidents of the meeting have been forgotten.

Undivided attention and enthusiastic applause marked the reading, by Secretary Thomas Elmer Will, of the comprehensive annual report of the board of directors. Every phase of the broad scope of the work of the American Forestry Association, in-

cluding the publishing of the magazine FORESTRY AND IRRIGATION, and Secretary Will's lecture tours, was covered; and complete details proved the encouraging success of the year's progress and furnished inspiration and incentive to the workers throughout the country to continue their noble efforts.

It was with genuine regret that his hearers saw Secretary Wilson relinquish the chair, on account of other duties; but they congratulated themselves on the excellent substitute, Col. William S. Harvey, director of the Philadelphia Commercial Museum, whose close attention to details, humorous appreciation, and impartial rulings won the admiration and approbation of all, and helped to promote the spirit of harmony and concerted action which permeated the proceedings.

The chairman appointed the following persons on committees:

Committee on Nominations—Messrs. H. S. Graves, H. A. Pressey, and F. W. Rane.

Committee on Resolutions—Messrs. G. K. Smith, L. Johnson, H. A. Barker, E. A. Start, and C. L. Pack.

Committee on By-Laws—Messrs. W. S. Harvey, J. H. Cutler, and T. E. Will.

Committee on Audit—Messrs. G. P. Whittlesey and J. B. Adams.

A Committee on Co-operation was named to prepare data and program for the hearing before the House Committee on Agriculture, with Gov. Hoke Smith as chairman, and including Messrs. W. S. Harvey, P. W. Ayres, E. A. Start, and others.

The excellent report of the financial condition of the American Forestry

Association, as read by Treasurer Otto Luebker, was unanimously received, approved, and filed.

MR. PINCHOT'S ADDRESS.

Continued applause greeted Mr. Gifford Pinchot, the forester of the U. S. Department of Agriculture, who was introduced by Colonel Harvey as "the custodian and trustee of the largest and most valuable asset of any single corporation in the world—162,000,000 acres of land, of which it is almost impossible to compute the present value, in billions, and of which the future value is beyond estimate."

Mr. Pinchot traced the progress of forestry in the United States from the earliest times, and guided his hearers step by step through all the successive stages of its growth and retrogression in the uncertain and precarious conditions of the past, to the successful and promising awakening of the present, and to the outlook for a future whose scope, whose power for good, and whose far-reaching, all-embracing magnitude not even the wisest is as yet fully able to comprehend.

In his address, Mr. Pinchot gave great credit to President Roosevelt for his farsighted policy of preserving all the country's natural resources, which moved Colonel Harvey to remark that Mr. Pinchot, in his modesty had neglected to mention "the power behind the throne." President Roosevelt, in his address before the National Editorial Association, at Jamestown, June 10, 1907, described the plans for preserving the water, the forage, the coal, and the timber, and said, "In all four movements my chief adviser, and the man first to suggest to me the courses which have actually proved so beneficial, was Mr. Gifford Pinchot, the Chief of the National Forest Service."

OTHER ADDRESSES SUMMARIZED.

Dr. J. T. Rothrock, of West Chester, Pa., secretary of the Pennsylvania For-

estry Reservation Commission, gave figures to prove that timber lands are daily increasing in value; he made a plea for the immediate purchase of the proposed Appalachian National Forests, saying that the longer we wait the more we will have to pay.

Gen. John W. Noble, of St. Louis, who was Secretary of the Interior under President Harrison, and who in that capacity issued the first order for the preserving of National Forests, and who set apart the Yellowstone and Yosemite National Parks, urged the continuance of the present National Forest policy.

Hon. W. A. Reeder, of Kansas, chairman of the House Committee on Irrigation of Arid Lands, declared himself an ardent advocate of forest preservation; he emphasized Forester Pinchot's contention that the electrical power of the future, for heating and lighting homes and for culinary purposes, depends upon the water power which is conserved by the forests.

Mr. J. A. Pack, of Cleveland, Ohio, and of Lakewood, N. J., a timber land owner, spoke against high taxation of timber lands.

Along the line of educational work undertaken by the American Forestry Association, Colonel Harvey here mentioned the weekly press bulletins, which are sent to 1,500 newspapers throughout the United States.

He also spoke of the Washington newspaper correspondents, members of the Gridiron Club, representing newspapers and news syndicates in Boston, Philadelphia, New York, Detroit, and other cities, who were sent in a special car on a seven weeks' tour of the West, where they visited irrigation works and the Irrigation Congress and viewed the timber, the grazing lands, and the water power, and became familiar with land conditions and land laws.

Ex-Governor Rollins of New Hampshire was called upon, but on account of illness was not present, much to the regret of the Association.

Chairman Harvey read a letter from

Governor Comer of Alabama, introducing and endorsing John Wallace, Jr., secretary of the Alabama Forestry Commission, and State Game and Fish Commissioner, who made an enthusiastic address in which he spoke of the progress of the South, and stated that the Alabama delegation was pledged, to a man, for the Appalachian bill and that Alabama is not only making wise laws for the preservation of forests, but that she is enforcing those laws, with the assistance of the 7,000 game wardens of the State.

James S. Whipple, Forest, Fish and Game Commissioner of New York, said that his State is the pioneer in the forestry movement, and has planted within 100,000 of as many trees as all the other States and the Federal Government together. He made a plea for reforestation, citing the history of China, France, Italy, and Spain, and saying that New York can reforest at \$6.50 an acre, whereas in France the cost (even with cheap labor) is in some instances as high as \$35.00 an acre. The high cost is because they must remake the soil, which floods have washed away. By beginning now and saving the forests and soils, the United States will be spared that heavy expense.

A very interesting address was given by Rutherford P. Hayes, of Asheville, N. C., president of the Appalachian Park Association, in which he told of conditions in his State, saying that his section of country was entirely denuded of trees.

A strong plea for the establishment of the Appalachian National Forests, as demanded by the people of his section, was made by George Ward Cook, of Haverhill, Mass., who represented the business interests of the Merrimac Valley.

Prof. F. W. Rane, State Forester of Massachusetts, delivered an excellent address in which he spoke especially of the great destruction and damage of forests by fire; he explained the definite plans to control forest fires which are practiced in his State.

Mr. Frederick S. Underhill, of Philadelphia, vice-president of the Lumbermen's Exchange, gave the position of the lumbermen on the Appalachian bill, saying that nearly all the lumber companies of the country favor the bill. He said we cannot depend upon coal for motive power, and we must depend upon the rivers, which have their sources in the forests.

Samuel B. Green, professor of Horticulture and Forestry in the University of Minnesota, emphasized the need of popular education along forestry lines. He said the young men should be educated. He spoke of his resolution asking Congress to enlarge the Hatch Fund law so that, out of the proceeds of the sale of forest products, an addition would be made to that fund to be expended for forestry education and forestry experiments. Professor Green's resolution was ably seconded by Mr. Frederick W. Kelsey, of New York.

The leasing of coal lands by the United States Government was advocated in an able paper on Co-operation Between the Government and Timberland Owners, by Mr. Mark Packard, of Buffalo, who is the owner of large coal and timber lands in Tennessee. Mr. Packard gave the price at which the Government might lease lands for a number of years.

Philip W. Ayres, forester of the Society for the Protection of New Hampshire Forests, said we should get rid of sectionalism, and he appealed to the patriotism of the people to support the Appalachian forest bill.

"Forests and the Health of the Nation" was the subject of an exceptionally interesting address by Mr. J. Horace McFarland, of Harrisburg, Pa., president of the American Civic Association. Mr. McFarland said that the health of the people is the beginning of happiness; he commended the interest taken by cities, States and the Federal Government in the health of the people. He emphasized especially the health of the people as affected by the forests and said that

forests act as a filter and purifier of the air. We pollute the air by manufacturing; forests regenerate the air and make it pure.

Mr. MacFarland also spoke on the connection between floods and typhoid fever. Floods wash into a stream the debris and refuse from a wide belt along the banks which normally are not reached by the waters of the stream; and such diseases as typhoid fever are thus disseminated. The fewer forests, the more floods, and the greater the danger of epidemics.

He also referred to the beneficial influence of forests in stamping out the great white plague, and spoke of the restoring influence of the forest on the mind of man.

Dr. Rothrock, of Pennsylvania, was enthusiastically called to the platform for the second time, and said that we should utilize the forests for the people. We should invite them to the forest and let them call it theirs. We should open the reservations to the sick for health and recreation.

Prof. George F. Swain, of the Massachusetts Institute of Technology, Boston, said that he had left his paper at home, and consequently was in the predicament of the missionary who stated that because of a similar mischance he could use only the words God would put in his mouth, but hoped next time he would come better prepared. Professor Swain said that the timber question was of more importance than the Panama Canal, and he spoke of the influence of forests in regulating the stream supply. He said that by reason of the denudation of the forests on the White Mountain watershed, the water power in the New England streams had become insufficient to run the mills; and that 95 per cent. of the water-power factories and manufacturing plants have to use steam at certain times of the year or quit running. With proper forest protection the stream flow would be sufficient all the year round. Professor Swain also spoke of the loss of soil by washing away after the trees are removed.

The statements of Professor Swain regarding the loss of water power by reason of forest denudation were ably corroborated by Mr. Allen M. Schoen, an electrical engineer, whose experience has been in the South along the rivers which have their source in the Appalachian watershed. Protection of forests is especially needed there, since there are no lakes to hold the water for use during the dry season.

Lively interest marked the able address of George K. Smith, of St. Louis, secretary of the National Lumber Manufacturers' Association, and a director of the American Forestry Association. Mr. Smith advocated taking a census of the timber cut and of the standing timber, and he further said that lumber operations will be curtailed this year as compared with the last two years.

In the absence of Governor Hoke Smith, of Georgia, Mr. S. B. Smith, of Chattanooga, told of the legal difficulties which made it impossible for the State of Tennessee to control forest destruction, so that the work must necessarily be done by the Federal Government.

An enthusiastic reception was accorded Mr. William L. Hall, assistant forester of the Department of Agriculture, who had charge, for the department, of the heavy work of surveying the proposed Appalachian and White Mountain National Forests, as authorized by the last session of Congress, with regard to their commercial importance, their area and condition, the advisability of their purchase, and their probable cost. Mr. Hall gave a very interesting account of the work he has accomplished, and of its bearing upon the proposed legislation. At the conclusion of Mr. Hall's remarks there was great applause.

Prof. Henry S. Graves, director of the Yale Forest School, made an interesting address and called attention to the growing need of education along forestry lines.

The Association was favored with an entertaining talk by Clinton Rog-

ers Woodruff, of Philadelphia, who represented the American Civic Association, and who made a plea for the establishment of the Appalachian National Forests.

Mr. Ligon Johnson, president of the Appalachian National Forest Association, with headquarters at Atlanta, Ga., gave an interesting talk in regard to the work of his association, whose effective efforts in giving publicity to the Appalachian movement and securing the active interest of the population of the South, are notable.

The evening session was largely attended and was especially interesting. A number of handsomely gowned ladies were among the audience.

The Committee on By-Laws reported with recommendation of certain changes. These were adopted, and will appear in the complete by-laws, which will be republished in FORESTRY AND IRRIGATION in a later issue.

RESOLUTIONS.

The resolutions adopted recommend the passage at this session of Congress of the bill providing for National Forests in the Southern Appalachian and White Mountain regions; that a timber census of the United States be taken; and that Congress be asked to enlarge the Hatch Fund law, so that part of the receipts from National Forests may be expended for forestry education and forestry experiments.

NEW OFFICERS ELECTED.

The report of the Committee on Nominations was as follows:

For President—Hon. James Wilson, Secretary of Agriculture. For Vice-Presidents—Edward Everett Hale, chaplain of the U. S. Senate; B. E. Fernow, dean of the Faculty of Forestry, University of Toronto; James W. Pinchot, Washington (since deceased); N. J. Bachelder, master of the National Grange, Concord, N. H.; George Foster Peabody, banker, New York; George C. Pardee, late Gov-

ernor of California, Sacramento; Rutherford P. Hayes, Asheville, N. C., president of the Appalachian National Park Association; Albert Shaw, editor of the *Review of Reviews*, New York; W. W. Finley, president of the Southern Railway, Washington; J. T. Rothrock, secretary of the Pennsylvania Forestry Reservation Commission, West Chester, Pa.; George T. Oliver, newspaper publisher, Philadelphia; Charles R. Van Hise, president of the University of Wisconsin, Madison. For Treasurer—Otto Luebker, manager of the American Audit Company, Washington. For Directors—James Wilson, Secretary of Agriculture; George P. Whittlesey, patent attorney, Washington; James H. Cutler, retired manufacturer, Washington; Henry S. Graves, director of the Yale Forest School, New Haven, Conn.; F. H. Newell, director of the U. S. Reclamation Service, Washington; William L. Hall, assistant forester, U. S. Forest Service, Washington; George K. Smith, secretary of the National Lumber Manufacturers' Association, St. Louis; William S. Harvey, president of the board of trustees, Philadelphia Commercial Museum; H. A. Pressey, hydraulic engineer, Washington; Asbury F. Lever, Representative in Congress from South Carolina; W. J. McGee, Bureau of Soils, Washington; Philip W. Ayres, forester of the Society for the Protection of New Hampshire Forests, Concord, N. H.; Robert Garrett, capitalist, Baltimore, Md.; Ligon Johnson, attorney, New York, late of Atlanta, and president of the Appalachian National Forest Association; Filibert Roth, dean of the Forestry School, University of Michigan, Ann Arbor.

This report was unanimously adopted, and the secretary was requested to cast a ballot for the unanimous election of each of the above.

THE UNDERLYING IDEA.

The principle underlying the meetings and the one to which all the addresses reverted was that of educat-

ing public sentiment to the importance of the Appalachian National Forest Bill, introduced in the House by Mr. Currier, of New Hampshire, and Mr. Lever, of South Carolina. The bill asks for an appropriation of \$5,000,000 and provides that 5,000,000 acres in the Southern Appalachian Mountains and 600,000 acres in the White Mountains be set aside as National Forests for the purpose of preserving the timber and protecting the watersheds of great rivers.

CONSTITUTIONALITY OF THE BILL.

One of the strongest and most valuable papers of the session, from the standpoint of influence on legislation, was that of Harvey N. Shepard, of Boston, Mass., on the constitutionality of the Appalachian-White Mountain Bill. Mr. Shepard said that if the authority of Congress to legislate for any particular end is undisputed, then the means to be used cannot be questioned, but is wholly within the discretion of Congress.

It is conceded that Congress has the power to control and regulate commerce; then, as a means to that end, it has the power to establish National Forests in the Appalachian Mountains, so that the flow of the streams, upon which commercial activity depends, may be regulated and preserved. If Congress can make dams to control the flow of rivers, it can create and buy forest reserves also for the same purpose.

At the conclusion of Mr. Shepard's unanswerable arguments he was accorded a great ovation.

Representative A. F. Lever, of South Carolina, a member of the House Committee on Agriculture, was most hopeful of the success of the

Appalachian bill, and spoke very eloquently in its favor, citing many instances of similar legislation to prove the constitutionality of the bill. He said we could save millions by acting now.

Mr. W. J. McGee, a member of the new and important Inland Waterways Commission, gave many convincing arguments in favor of preserving the forests at the headwaters of navigable streams. He said that every year 1,000,000,000 tons of soil are washed by the rivers into the sea, which, at the least value that can be put upon it, fifty cents a ton for fertilizer, is worth \$500,000,000. Also that the muddy water filled with silt from the mountains and valleys eats away and erodes the banks of streams, thus widening the channel and lowering the water, and interfering with navigation. Clear water does not erode. The difference between clear water and muddy water is the same as that between a jet of air and a sand blast. Mr. McGee further said that when forests were once destroyed, restoration was slow, and that where the soil is washed away, it would be centuries before the land would return to its original fertility. Mr. McGee, a physicist in the Bureau of Soils, speaks as one who has given special attention to this matter of soil erosion.

The last address of the evening was by Mr. W. S. Lee, Jr., of Charlotte, N. C., who spoke very interestingly on the vital question. Need of Southern Appalachian Forests for Protection of Water Power, saying particularly if you save the silt from coming down, by preserving the forests on the mountains, you have solved one of the great problems relating to navigation and water power.

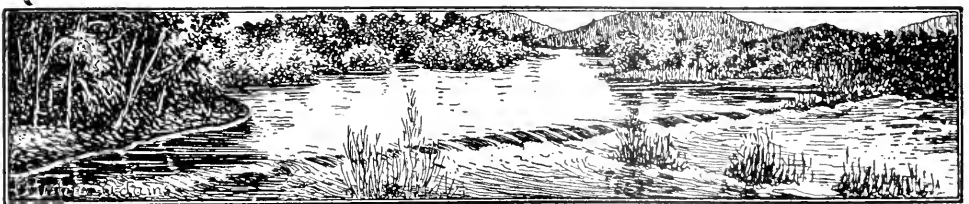

CONSTITUTIONALITY OF THE APPALACHIAN BILL *

BY

Harvey N. Shepard, Attorney-at-Law, Boston, Mass.

MR. CHAIRMAN AND GENTLEMEN :

The Supreme Court of the United States gave a decision May 13, 1907, in a cause brought by the State of Kansas against the State of Colorado which some people fear may affect the constitutional position of the pending bill for acquiring National Forests in the Southern Appalachian Mountains and White Mountains. The charge made by Kansas is that Colorado is depleting the flow of water in the Arkansas River, a river which flows through both these States. The United States of America filed its petition of intervention, and alleged that within the watershed of the Arkansas River are 1,000,000 acres of public lands, uninhabitable and unsalable unless rendered so by the impounding of waters in this watershed to reclaim this land, that legislation of Congress has sanctioned the use of these waters in this arid region, and that under the Reclamation Act of June 17, 1902, \$1,000,000 have been expended in procuring sites for reservoirs and dams.

This contention brought directly to the court the question whether the amount of the flow of the waters of the Arkansas River is subject to the authority and control of the United States. The United States claimed that in and near the river, as it runs through Kansas and Colorado, are large tracts of arid lands; that the National Government itself is the owner of many thousands of acres; and that it has the right to make such legislative provision as in its judgment is needed for the reclamation of all these arid lands and for that purpose to appropriate the accessible waters.

This claim, says the Supreme Court, involves the question whether the reclamation of arid lands is one of the powers granted to the General Government. Certainly it is not, for, in the enumeration of the powers granted to Congress by the eighth section of the first article of the Constitution, we can not find one which by any implication refers to the reclamation of arid lands.

The pending bill authorizes the Secretary of Agriculture to acquire for National Forest purposes lands more valuable for the regulation of stream flow than for other purposes and situated on the watersheds of navigable streams. Herein is the sharp distinction from the Kansas-Colorado cause. In that cause the United States alleged that the Arkansas River is not navigable in the States of Colorado and Kansas. But here the only lands which can be acquired are those on the watersheds of navigable rivers; and it is for the protection of these navigable rivers that these forest areas are to be acquired.

No one questions the authority of the United States over navigable rivers. Congress may prevent or remove obstructions in these rivers, and it may take all needed measures to secure their uninterrupted navigability. What these measures shall be depends entirely upon the discretion of Congress, and there is no other authority whatever which can question them. Since the days of Chief Justice Marshall this has been the settled rule of construction.

It is conceded by all that the Government of the United States is one of limited powers and that it can wield only such attributes as are conferred

*Remarks Made at the Hearing before the House Committee on Agriculture, Washington, D. C., January 30, 1908.

upon it by the Constitution. These are expressed in the most general language; they do not descend to details; and they do not point out the means and methods by which the various powers are to be made operative.

Two schools of interpretation have existed among the statesmen and politicians of the country. The one has taught that a strict and close construction is to be placed upon all grants of power contained in the organic law, so as to limit the Government to those acts and means which absolutely are necessary to give force and operation to the grant. The other has maintained that the instrument is to be construed liberally, so as to enable the Government to adopt any means which would conduce fairly and reasonably to make the grant operative; and that among such means the Government has an unrestricted choice, which cannot be limited by the courts. Those who thus read the Constitution, assert that the powers of the Government are full, complete, and absolute, within the range of the subjects committed to its care; that it may adopt whatever means it prefers which may tend to give effect to the general provisions of the fundamental law; and that among such means the selection is entirely a matter of policy and expediency.

The practice of the Government has been in accordance with the latter more liberal theory of construction. The Supreme Court of the United States has affirmed this view with the greatest emphasis, and applied it to cases of the highest importance. The tribunals of most of the States have followed the lead of the National judiciary, although some of them have adopted the opposing theory, and enforced it with great earnestness.

In *McCulloch vs. Maryland*, 4 Wheaton 316, the Supreme Court says:

"It must have been the intention of those who gave these powers, to insure, as far as human prudence could insure, their beneficial execution. This could not be done by confining the

choice of means to such narrow limits as not to leave it in the power of Congress to adopt any which might be appropriate, and which were conducive to the end. This provision is made in a Constitution intended to endure for ages to come, and, consequently, to be adapted to the various crises of human affairs. To have prescribed the means by which Government should, in all future time, execute its powers, would have been to change, entirely, the character of the instrument, and give it the properties of a legal code. It would have been an unwise attempt to provide, by immutable rules, for exigencies which, if foreseen at all, must have been seen dimly and which can be best provided for as they occur. To have declared that the best means shall not be used, but those alone without which the power given would be nugatory, would have been to deprive the legislature of the capacity to avail itself of experience, to exercise its reason, and to accommodate its legislation to circumstances.

"Take, for example, the power to establish post-offices and post-roads. This power is executed by the single act of making the establishment. But, from this has been inferred the power and duty of carrying the mail along the post-road, from one post-office to another. And, from this implied power, has again been inferred the right to punish those who steal letters from the post-office or rob the mail."

In *Kohl vs. United States*, 91 U. S. 367, the Supreme Court says:

"The powers vested by the Constitution in the General Government demand for their exercise the acquisition of lands in all the States. These are needed for forts, armories and arsenals, for navy-yards and light-houses, for custom-houses, post-offices, and court-houses, and for other public uses.

"When the power to establish post-offices and to create courts within the States was conferred upon the Federal Government, included in it was authority to obtain sites for such offices and for court-houses, and to obtain them

by such means as were known and appropriate."

In *Cooley's Constitutional Limitations* it is said:

"So far as the General Government may deem it important to appropriate lands or other property for its own purposes, and to enable it to perform its functions—as must sometimes be necessary in the case of forts, light-houses and military posts or roads, and other conveniences and necessities of government—the General Government may exercise the authority as well within the States as within the territory under its exclusive jurisdiction; and its right to do so may be supported by the same reasons which support the right in any case; that is to say, the absolute necessity that the means in the Government for performing its functions and perpetuating its existence should not be liable to be controlled or defeated by the want of consent of private parties or of any other authority."

As Congress has the power to declare war and to create and equip armies and navies, it has, the Supreme Court says, in *U. S. vs. Gettysburg El. Rwy. Co.*, 160 U. S. 681, such other and implied powers as are necessary and appropriate for the purpose of carrying the powers expressly given into effect; and therefore it may take by right of eminent domain the land whereon was fought the battle of Gettysburg, because this "tends to enhance the respect and love of the citizen for the institutions of his country and to quicken and strengthen his motives to defend them."

The Constitution gives to the Government the power to regulate commerce. Under this grant Congress has enacted laws for the improvement of harbors, the construction of piers, the dredging of rivers, the erection of an astronomical observatory, and the conduct of a coast survey. It has invaded the common law by limiting the liability of carriers upon the oceans and the great lakes; and it has sent out expeditions to observe an eclipse, and to explore the topography of the

Dead Sea. Congress has full power to build or repair the levees of the Mississippi River, and to maintain a bridge erected over a navigable stream running between several States; and if it may maintain, it also may cause to be erected. Indeed, it has exercised this authority several times by authorizing the construction of bridges over the Mississippi River.

Wilson vs. Blackbird Creek Company, 27 U. S. 245, is in relation to a dam which was built under State authority upon a creek into which the tide ebbed and flowed, and the question before the court was whether the dam had been built in violation of the power given in the Constitution of the United States to Congress to regulate commerce, and the Supreme Court of the United States decided in favor of the State upon the ground that Congress had not passed any act in execution of this power to regulate this creek, and intimates clearly that if Congress had passed such an act the State law authorizing a dam to be built across the creek would be void. It is clear that, if Congress under the power to regulate commerce may prevent damming of the creek on the ground that such a dam would destroy the navigability of the stream, it also could authorize the building of a dam in order to improve such navigability; and, if it has this right, it certainly can have no less right to guard against destruction of a navigable river by protecting the headwaters and to insure a continual supply of water in the river by the preservation of the forest areas about these headwaters.

Mr. Justice Strong says in *South Carolina vs. Georgia*, 93 U. S. 4: "That the power to regulate commerce, conferred by the Constitution upon Congress, extends to the control of navigable rivers between States—rivers that are accessible from other States, at least to the extent of improving their navigability—has not been questioned during the argument nor could it be with any show of reason. From an early period in the history of the Government, it has been so under-

stood and determined. The power to regulate commerce comprehends the control for that purpose, and to the extent necessary, of all the navigable rivers which are accessible in a State other than that in which they lie.

"For this purpose they are the public property of the Nation and subject to all the requisite legislation by Congress. This includes the power to keep these open and free from any obstruction to their navigation interposed by the States or otherwise; to remove such obstructions where they exist; and to provide, by such sanctions as they deem proper, against the recurrence of the evil and for the punishment of offenders."

In this case money was appropriated by Congress to improve Savannah harbor by improving the navigability of the river, and to that end this dam was built. Would an appropriation to buy forest lands, which protect and provide a continued water-storing area on the watersheds of the Connecticut, Merrimac, and other rivers, be anything else than a direct and necessary means for the improvement of the navigability of these interstate streams?

In *Monongahela Co. vs. U. S.*, 148 U. S. 312, Congress passed an act to purchase the dam and locks of the plaintiff, or, in event of failure to purchase, to condemn and take over the property, and the right of the United States to dam the river, or to take over the dam already built, was not questioned.

As Congress has power under the

Constitution to dredge navigable rivers, it would seem to follow necessarily that it has power to take such measures as will prevent the necessity of dredging. It is evident that the wasteful cutting of mountain slopes allows the soil to wash into the rivers; that navigation is threatened by the filling up of the channels; that this can be prevented to a large extent by the reforestation of the mountain slopes. If so, then the means to be taken for this purpose—for example, the purchase of lands on the watershed of these rivers—will be wholly within the discretion of Congress and not open to legal objection. A lighthouse is not an active part of the Government, but only an instrument which it uses under the power given it by the commerce clause of the Constitution. The holding of forest lands for the protection of the water supply of navigable rivers is an instrument also under this same clause of the Constitution.

The Kansas-Colorado cause is not inconsistent with these principles. That cause only decides that the reclamation of arid lands is not one of the powers granted to the General Government, and it was not claimed to be a means by which an express power was to be carried into execution. It was the very end sought for. The Supreme Court decides that this end is not legitimate; but it is careful not to say that, if this reclamation were a means appropriate to a legitimate end, then it would be unconstitutional.

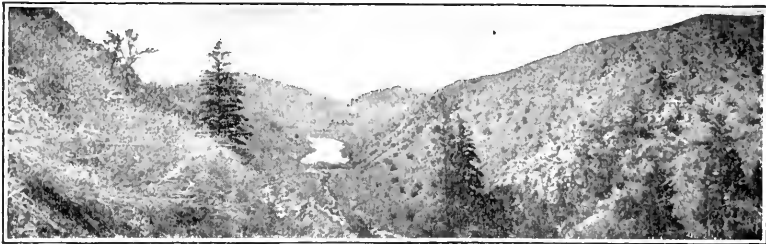

THE PRESIDENT'S ANNUAL ADDRESS*

HON. JAMES WILSON, President of the American Forestry Association, called the annual meeting to order and addressed the members as follows:

GENTLEMEN OF THE ASSOCIATION: I am glad to welcome you to this meeting, to the city of Washington, and to congratulate you upon the progress that is being made along so many lines in the direction of forestry. There are some gentlemen here, one in particular, who helped begin the National forestry system—Mr. Noble, of St. Louis. And he no doubt will be quite as much interested as anyone here in knowing the progress that has been made in the great work that he had so much to do with inaugurating.

The American people are learning the actual conditions concerning the forests of the country. It has been a work of years, and will be a work of years, before everything is done that should be done along these lines. Our country is a forested country by nature. When the Pilgrims founded New England and the Cavaliers founded Jamestown there were forests; and for hundreds of years it has been considered the proper thing to be a good axman, cutting down trees and destroying woods. And in that direction our forerunners have been eminently successful. They have succeeded in cutting down trees and destroying woods until it has become a question with us now what we are to see in the future, and what those who follow us shall see, with regard to the woods.

You will pardon my saying a single word about the National Forests. They number over 162,000,000 acres, scattered throughout the great Northwest. The people there are learning that the foresters of the United States are their servants; that the forester has no selfish aim to serve; that all his aims are for the good of the people who are to

be benefited by the American forests; that the forest is to be something for the benefit of those who live now and for the benefit of succeeding generations, on and on toward all future times. They are dealing with the great trees of five hundred years' growth; they are dealing with the fires that have been destroying so many acres every year, and they are steadily reducing the number of fires; they are studying the great problems of reforestation, something that is new to us.

Anybody can take a spade and plant a tree, if he can get a young tree. It does not take a very great deal of research to ascertain how to germinate a seed, but all the American army and all the American navy and everybody in Washington in the Government service combined could not reforest the bare lands in the forests of the United States if they were all set to work at it with a spade. It cannot be done. We have to get a new plan of doing things. Instead of planting as many trees as a man can plant in a day in the ordinary way—a few hundred—the time of one man must result in replanting four or five hundred acres in a day. Machinery must be adapted to the planting of tree seed. The problem how tree seed can be planted by machinery must be wrought out; and it will be wrought out. The question is not where to get enough of cheap labor to do this work—the question is how to encourage the intelligent laborer to do it. The American problem is not so much getting hold of cheap labor as the making of intelligent labor.

I recollect some years ago, when I was trying to encourage rice growing, some patriotic citizens asked if I did not know that I was wasting the public money, because labor was so cheap in the Orient that we could never compete; that we never could grow rice in the United States, and we never could

*Delivered at the Annual Meeting of the American Forestry Association, Washington, January 29, 1908.

grow tobacco and could not make sugar in the United States, because labor was so cheap in the Orient. I said: "That is worth inquiring into; I must see into that. Maybe I am going too fast in asking Congress to give money to do things that can be better done by other people." And so I said to my people: "Ascertain how much an American citizen with his improved machinery can grow in a year, and how much rice an Oriental with his

or forty years ago and settled in the woods resented the idea that it did not belong to him. When the forestry people, working for the Government, began to show him better ways of stopping fires and reforesting and all that, for a long time he could not get rid of the idea that those forests belonged to him and nobody else.

I recollect asking a man I met up in Montana (I had known him way back in Iowa, in the early days), "How do

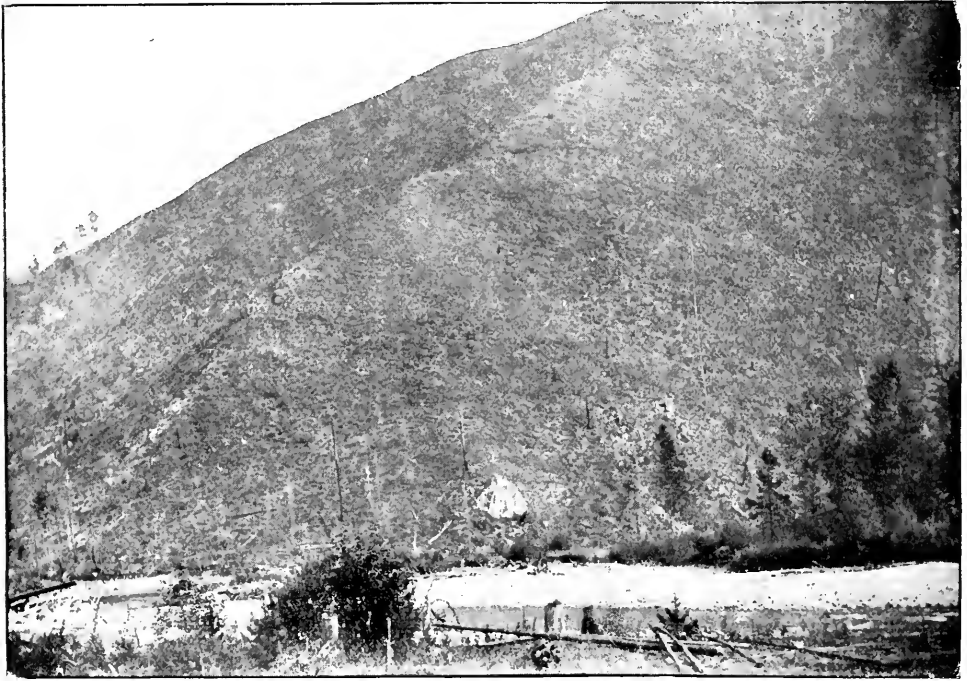

Burnt hillside now in Bitter Root National Forest, Montana, burned off 25 years ago—Lacks protection for snow and rainfall—Here is where tree planting on a large scale is needed

old-fashioned machinery and old-fashioned ways can grow in a year." And I discovered, when I got all the reports, that the one American could do as much as four hundred Orientals. We do not need such a crowd of Orientals to come here to do cheap work. We want to educate the American—and let the world look out for the educated American.

In all directions we are making progress in these lines. In the first place, the man who went West thirty

you like the forest policy of the United States?" He said, "I don't like to have to go to a forest office and tell them I want so many loads of wood." "Don't you always get it?" "Oh, yes. But, hang it! I used to go and take it." "Yes, but we want you now to take what will do no harm. We want to save the young growth, the trees that will make good wood hereafter." They are gradually getting out of that old idea. They are gradually learning that the Federal Government is not

pushing reforestation for anybody's benefit, but for the benefit of the American people, and particularly for the benefit of the people who live nearest to the forests. We have come to the time, gentlemen of the Association, and ladies, when broad-minded men with great hearts in them are taking

quity will go on and on and on, toward the development of the great natural resources of the United States of America, until the Federal Government and the State governments and the individuals, all working together, will prepare this great republic of ours for its great future and for the sup-



Digging white pine seedlings

comprehensive views of the United States of America.

They are not only thinking of the forests, but they are thinking of the rivers, they are thinking of the unproductive lands, they are thinking of the streams that flow idly to the oceans, they are thinking of the destructive cutting on the mountain tops, where Nature's covering is taken away; and this thought and this in-

port of the millions that will inhabit it.

The States are doing a good deal. The report of the Directors, that will be read this morning, will show you in detail what the several States are doing. It is quite encouraging, and it is time they were doing things. I happened to be in Pittsburg last year after they had had a great flood. The people in Pittsburg are very hospitable; they took me up their great

ivers and down them. You do not see Pittsburg when you ride through it. It is a great city. You know the United States in the last century did four things. It built the Capitol, the Library, the Washington Monument, and Pittsburg. Some people sneer because a few Pittsburgers have not behaved very well; but they are a great people. They showed me that those rivers rose up to the second stories of the buildings, and Pittsburg

mation regarding what they should do; and they are taking steps, because there are no brighter people on the continent. I give you this as an illustration of what must happen if we go on destroying our woods.

Now, take the headwaters of the New England rivers, take the headwaters of the great rivers of the South; I have been seeing those places and looking them over. The people are cutting woods away up to the top

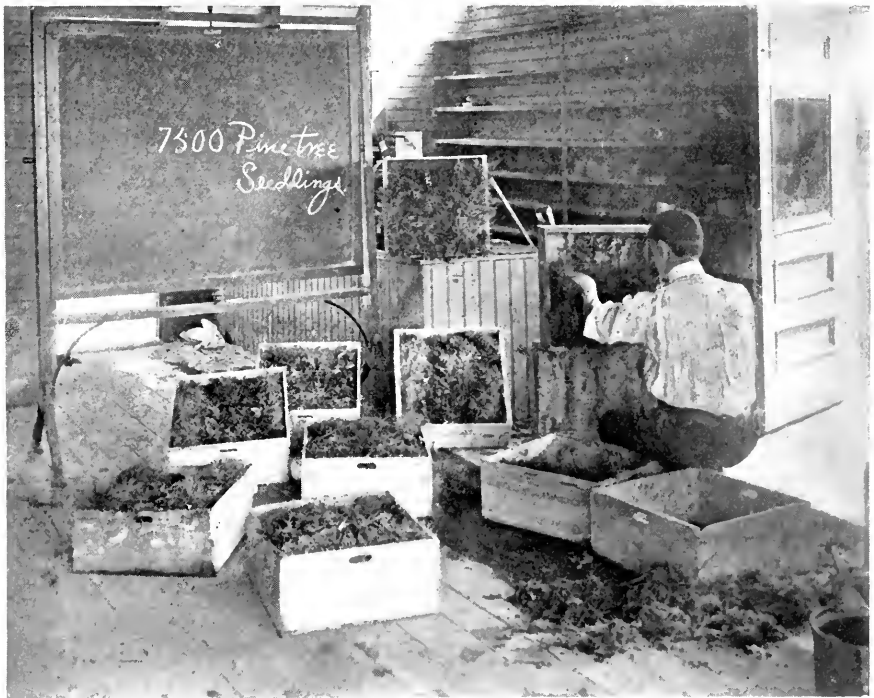

Packing white pine seedlings in boxes for shipment

runs up the river as far as they took me—for ten or fifteen miles it is still Pittsburg. I said: "Gentlemen, if you don't stop destroying the forests on the headwaters of those two great rivers of yours, the time will come—it may be next year, it may not be for ten years—but the time will come—when those rivers will rise over the tops of your buildings and sweep them all away." I think I alarmed them. They wrote and asked me to send a forester there to give them some infor-

there. There are only four or five inches of soil up there, and just as soon as the people get the wood cut, the soil begins to wash away, and this destroys the limited belt upon the mountains; and that goes on and on and on, and the water that melts from the snows of winter, and the rains that fall in the spring, will not find their first natural receptacle, which is the mountain soil, but they will run at once into the valley; and then in summer time there will be no rivers.

It is high time that this Association and the Congress of the United States were considering these great problems. Are we to lose the use of our great rivers in the East? In the South? We are taking care of things measurably well in the great West. I do hope our representatives will very carefully consider the wisdom of making beginnings along the line of stopping the cutting of the woods on the

for the present generation, but you are doing it for all future generations. Forests are something that should go on and on and become historic for thousands of years. There is no reason why they should not do so. The hope of the future forests is in the work of this Association; and so I say, keep up your courage, no matter what difficulties you meet with. The day will come when you will impress



Private land within San Bernardino National Forest, lumbered and burned in 1903

mountain tops, both in New England and on the Southern Appalachian range.

Gentlemen, I have many duties to perform, but I could not keep away this morning. I had to come and bid you welcome, bid you Godspeed. Go on with your work. There is nothing more noble than the rehabilitation of the forests and the preservation of the forests. You are not only doing it

yourselves on the people of this great republic, and the representatives of the people will sooner or later take care of the forests of the country and the headwaters of the rivers.

I thank you very much, and hope you will all have a pleasant time. I have asked Colonel Harvey to come and take the chair, and permit me to take care of some other duties. Good morning, gentlemen.

IMPROVEMENT OF OUR HERITAGE *

BY

Gifford Pinchot, Forester of the U. S. Department of Agriculture

MR. CHAIRMAN, LADIES AND GENTLEMEN:

I WANT to talk to you for just a few moments this morning about a movement which arose from the forest movement naturally and inevitably, and which now envelops the forest movement and makes it part of a far larger and more important piece of work than any of us anticipated at the beginning. The central idea of forestry, I need not tell you, is the intelligent and foresighted use of a great natural resource. It has often been said that the forest policy of the National Government is the longest look ahead that the United States has ever taken in any direction. And I think this is true. Foresight is the key of the forest movement. And once the Nation had begun to look forward vigorously and intelligently at the use of a single natural resource, it was naturally only a question of time until the same point of view should be taken in considering all other natural resources. The result was inevitable and has just now come about. During the past year the President of the United States has launched a movement for the conservation of all natural resources, which he himself speaks of as the most important problem now before the people of the United States, and which is going to have consequences and results in our economic and financial and sociological conditions which perhaps none of us are now able fully to realize.

I mean to speak to you for just a moment about the present condition of our natural resources, and to forecast a little what the results are likely to be. Those of us who now have charge of the area of the United

States (and I mean by that all the people of the United States) are exactly in the situation of a young man who has just come into his inheritance. He has one of two things to do. He may ascertain the business condition of the property, its physical nature, and seek out and apply the best policy for the handling of its resources under the circumstances; or he may do as many young men do, have his fling, have a good time out of it while it lasts and let the future take care of itself.

Now, in private life we have come really to understand that that second course is unwise, but private morality and private intelligence are always a long way ahead, in the best examples, of national morality and national intelligence. And the result is that a course which we would deprecate and condemn in the case of any man who was our friend, we are as a nation following step by step. In other words, we have not adopted the point of view that this is a valuable property which ought to be conserved and which ought to be transmitted unimpaired to our children. But we have said in substance, we have said through carelessness and thoughtlessness, much more than by intention: I will do what I like with my own; after me the deluge.

What was the condition which we found when we came to this continent? Three million square miles of the richest, most diversified, most fertile and usable country that ever the sun shone on. Not alike all over, not all usable, but so combined and constructed as to make the best field that has ever been offered for the development of a great civilization. Every nation that has found itself in any-

*Address before the Annual Meeting of the American Forestry Association, Washington, January 29, 1908.

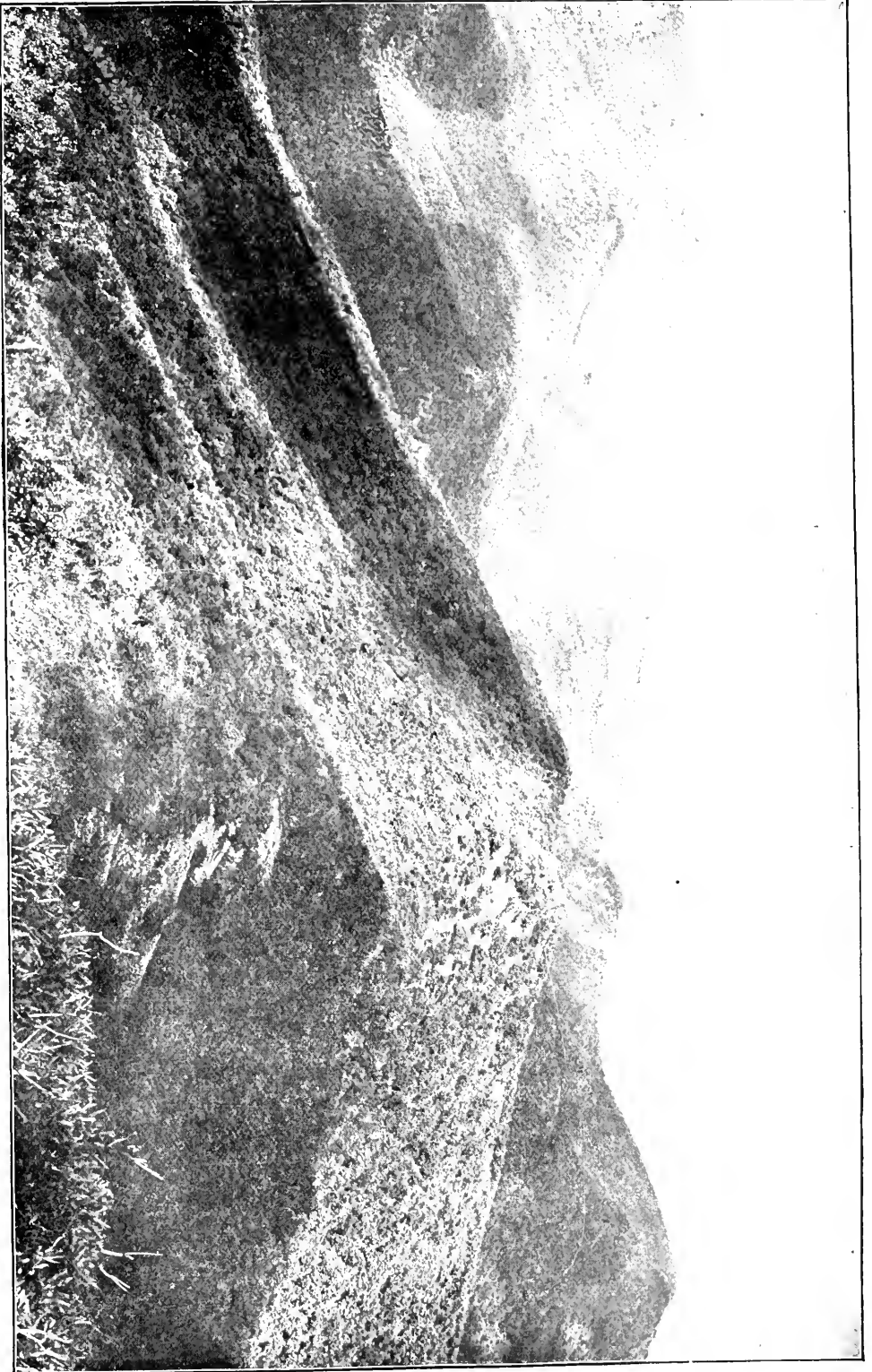

Panorama of the Blue Ridge, Mount Mitchell, and southern end of the Black Mountains—The center of the proposed Southern Appalachian National Forest

thing like a similar situation hitherto has always adopted a single course, that of a spendthrift. And we did the same. We have reached a point now where it is fair for us to take account of what has happened.

But one point before I proceed—we must remember that the life of a nation represents at least centuries, where the life of a man is measured in decades. Now, what have we done with the physical basis for our future prosperity from that point of view?

seen iron mines in full swing where now they are gone; and the same is true of the coal. At our present rate of increase of consumption, our anthracite coal is good for only about 50 years, and our bituminous for only 100 years. That is, within a period of the Nation's life which is equivalent to only a single decade in the life of an individual, the Nation's supply of fuel, that most essential of all products for our present form of civilization, is likely to be exhausted.



Wasteful methods of lumbering on land now in Black Hills National Forest, South Dakota—Such waste is averted under scientific management

There are two kinds of resources, renewable and non-renewable resources. Resources which come out of the interior of the earth are non-renewable. Those which come from the surface are most of them renewable. We have treated our mineral resources as if of those there was no end. Many of you here have seen natural gas pouring day and night out of great torches in the States of Indiana and Pennsylvania, from fields now exhausted. Many of you have

We have treated our soils in precisely the same way. The figures are familiar to most of you. I will simply say that a billion tons of the most fertile soil on the most fertile land of the United States goes annually into the ocean. It is the largest of all taxes paid by the farmer, and one of the largest losses that the Nation suffers. Hundreds of square miles a year are made practically uninhabitable, or at least unsuitable for the support of a dense population. The surface of the soil is

renewable; the coal, the iron, the oil, the gas, once gone, can never be renewed.

Our timber, even at the present rate of consumption, so far as we can measure it, and giving every opportunity for covering mistakes by large estimates, is likely to last us between twenty and thirty years. And our timber is scarcely less necessary for us than our coal. Our forests, from which the timber comes, are vastly more necessary for us than our coal, for from the

present, that the forests were absolutely essential to our welfare; that our industries could not be prosecuted; that transportation, mining, manufacturing, and all the varied occupations which give our people bread and shelter, were necessarily related to the forest, and in its absence would be impossible. That is true. But the intimacy of the relation of the forest to the daily life of the individual now, is as nothing to what it will be when the coal, oil, and gas are exhausted; when

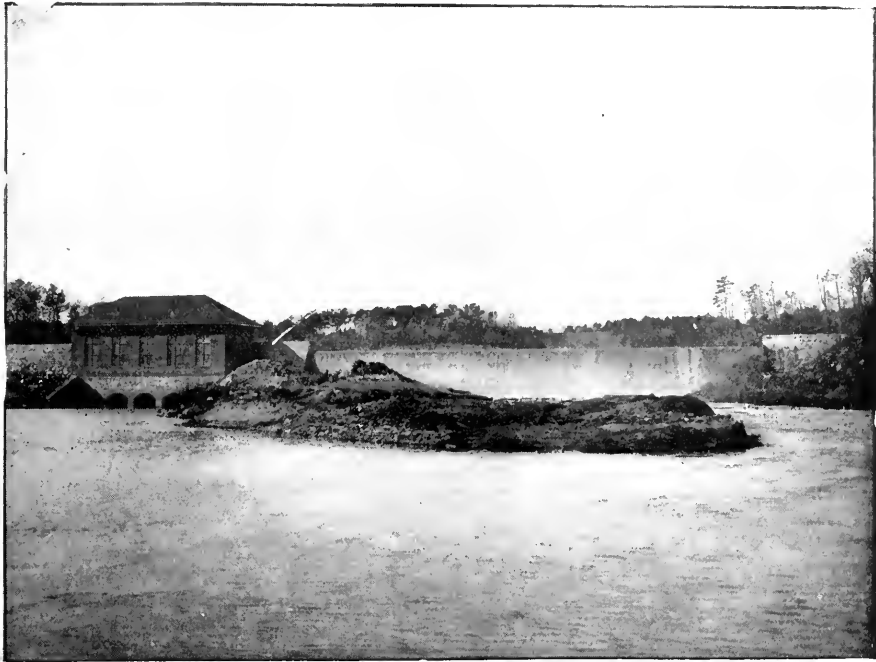

Water Power on Saluda River at Pelzer, South Carolina

forests will ultimately come the one great source of power which is renewable, and the only one of any great amount—that is, water power. And in our forests, through our water power, we shall find the great support of our future civilization. After a while, when coal is exhausted, and oil and gas are gone, the only great source of power, so far as our knowledge of the physical universe now goes, will be water power; and the water power is absolutely and completely dependent upon the forests.

We have been in the habit of saying, as things stand in the country at

our great source of power and heat comes, all of it instead of part of it, out of the forest; and when the daily life of every man is intimately affected by the resources, the revenues, the utilities, produced from water powers originally in the forests, when a man's house is lighted and heated, and his food is cooked, and he himself and the freight upon which he depends are transported, and the goods that he uses are manufactured, and the paper that he reads is printed, all by electricity derived from water flowing out of the forests. I tell you that however close the relation of the forest to our

present civilization may be (and it certainly is close) it is destined to be vastly closer in the comparatively near future.

Now all this as a Nation we have consistently and steadily overlooked. We are very much in the position of a man adrift in an open boat on the ocean. He has provisions and water for ten days. He does not know whether he will get any more. He does not know whether he will be picked up or not. The average man with his individual intelligence conserves his water and his food, eats and drinks as little as he can, making it last to the very ultimate point, stinting himself to the verge or over the verge of weakness. This is for the sake of coming through alive. As a Nation we have adopted the other policy. It is as though the man in the open boat had said: "All my life I have had three square meals a day; all my life I have had everything I needed to eat and drink; I have no experience of the other condition; my one way of judging the future is by the past; I have always had three meals a day in the past and I always will have in the future. I will eat my provisions as fast as I want, and let the future take care of itself." That is the exact and unexaggerated condition of the public mind on all these questions until a very recent time.

Now we are about to turn over a new leaf. Under the foresighted and wonderfully intelligent leadership of the President this Nation is about to say to itself: We have an inheritance. Let us talk about it. What shall we do about it? We have no right to destroy the prosperity of our children by the way we make our own prosperity now. Let us consider the three million square miles that we have, and let us make the best, the most intelligent, the most farsighted use of it that is possible. That is statesmanship. That is community intelligence, national intelligence, and that is the only point of view which will save us from the fate that has overtaken so many other nations.

We find ourselves in America in a new situation. Many of the old laws

which applied to the nations of Europe no longer apply to us; many of the conditions which surrounded them are different from those that surround us; and it is quite natural that we should have said to ourselves, in substance, (mind you I mean by thoughtlessness as well as by direct intention) the fate that has overtaken the other nations that have destroyed their resources will not apply to us, we are more intelligent, we are more effective, we handle ourselves better, we know better how to make use of the things that we have. That is true; but natural laws apply to us as they do to North Africa, and just as surely as this new point of view fails (if it should fail) to determine the attitude of the American people toward the continent on which they live, just so surely the same result will follow.

I myself believe confidently that no such result will follow. I believe the change has been made. In my experience in public life, which is not long, there has been no single subject taken up so rapidly and so vigorously as the combined subjects of waterway improvement and the conservation of natural resources. And as we move forward to the use of our streams, the use of our soils, of our minerals, our lands, our forests, approaching the combined subject along different lines, we are gradually getting together a body of intelligent public sentiment which is beginning to develop, and which ultimately will develop a power that cannot be withstood. Many things we are now on the verge of getting, which have seemed hopeless for a long time; but the great essential fact, the fact that this Association ought to rejoice in more than in any other single thing, is that the policy of foresight for which the American Forestry Association has stood for years, with regard to forest resources, and which is the center of its work, has gone over into the fields of other resources as well, and we are now about to see a new sight in the world—a Nation intelligently, foresightedly, and determinedly making the best possible use, both for the present and the future, of all its natural resources.

REPORT OF BOARD OF DIRECTORS OF THE AMERICAN FORESTRY ASSOCIATION FOR THE YEAR 1907*

FOR the American Forestry Association, the year 1907 has been, in some respects, a notable one. In January the magazine, FORESTRY AND IRRIGATION, was purchased from the Forestry and Irrigation Publishing Company, for the sum of \$1,650; the Association paying, at the same time, to the Forestry and Irrigation Publishing Company, the sum of \$1,458.60 to cancel its indebtedness to that organization.

In the eleven and one-half months intervening between the purchase of the magazine and the close of the calendar year thirteen issues were published; the magazine thus being made to appear, since February, on time. Special effort has been made to improve the general character and appearance of the publication. The issue for January, 1908, included 9,200 copies, 6,645 of these being for members, and the others for subscribers, exchanges, advertisers, and general propaganda. On July 1 a press bulletin service was instituted. Since that time copies have been issued weekly to some 1,500 newspapers. Clippings and marked copies returned show that these bulletins were widely used.

Circular letters to the number of 125,000, and folders to the number of 138,143 have been issued.

During the greater part of the year the membership campaign was pursued with vigor. Though measurably affected by the industrial depression, the following results were obtained:

The membership for December 31, 1906, which was 5,543, was reduced as follows: Resignations (three advancing to Life, four to Sustaining, and one Sustaining changed to Annual), 547; deaths, 42; dropped, 110; not

found, 24; total, 723; leaving of the former members, 4,820.

To these, new members have been added as follows: Patron, 1; Life, 45; Sustaining, 27; Annual, 1,662; making a total of 1,735. The sum of the former members retained and of the new members added was, therefore, 6,555.

The total receipts from these new members were \$9,499. The cost of this membership campaign, including the printing and mailing of 122,078 invitations, postage on the same, and such portion of the office pay-roll as was estimated to be properly chargeable with this work, was \$6,350.86; leaving an excess of receipts over expenditures amounting to \$3,145.97.

To the fullest extent of its capacity, the office of the Association has promoted the Appalachian campaign. In this work it has fully utilized its magazine, circular letters, folders, and press bulletins. Its Secretary has also lectured extensively, speaking thirteen times in four Southern States, and twenty-two times in six Western and Middle States, these lectures being fully reported by the press. Following all of these addresses save three, resolutions endorsing the Appalachian Bill were passed. He has also addressed the annual meetings of the National Slack Cooperage Manufacturers' Association, the National Association of Box Manufacturers, and the Green-acre Summer Conference, and has attended other important meetings, promoting the passage of Appalachian resolutions; and has published in the press articles in advocacy of the Appalachian Bill and the general cause of forestry.

Attention is called to the broaden-

*Read by the Secretary of the Association, Thomas Elmer Will, at the Annual Meeting, Washington, January 29, 1908.

ing of the scope of the forestry movement, to the recognition of the fact that it includes the questions of irrigation, drainage, inland waterways, and power conservation, this group of

questions constituting but a part of the momentous question of the conservation and right use of all our natural resources. The significance of these facts is increased by the President's



Part of Connecticut State Forest after thinning—The cost of this land to the State was two dollars an acre

call of a conference to consider this question; the greatest issue, in his judgment, before the American people.

The year has witnessed strenuous attacks upon the National Forest policy, notably at the close of the last session of Congress by Senators from certain Western mountain States, and by the convention held in Denver, Colorado, June 18 to 20, to discuss the National Forest policy and related questions. Vigorous expressions, however, from individuals, associations, and newspapers in the same States make clear that the critics of the forestry principle and of its administration by the National Government represent neither the people of the whole United States, whose property the National Forests are, nor even the communities in which they reside. Extraordinary publicity to the forestry question has been given by these discussions, the net result being decidedly advantageous to the forestry movement. Legislation, it is true, forbidding the extension by presidential proclamation of the National Forest area in the States of Washington, Oregon, Idaho, Montana, Wyoming, and Colorado, was passed. Practically all the land, however, materially necessary for National Forests in the States named was set aside for that purpose before the enactment of this legislation. Furthermore, National Forests have since been established, by proclamation, in other States, as California and Arkansas. The National Forest area has grown from 127,154,371 acres on December 31, 1906, to 162,023,190 acres on January 1, 1908; an addition of 34,868,819 acres. The conspicuous success accompanying the administration of this imperial domain is well set forth in the reports of the Secretary of Agriculture and of the Forester.

A bird's-eye view of the forest situation and of forestry work in the States, aside from the work of associations and schools, follows:

Maine is still cutting timber, the

cut of last winter being estimated at 800,000,000 feet of spruce, and 100,000,000 of pine. Diligent efforts are made to prevent fires, and the State's record as regards fire prevention is better than for many years. A joint State and Federal investigation has been securing data on the lakes and rivers with a view to conserving waterpowers. An act has been passed permitting local officers to take, by eminent domain, five-rod strips along public ways for park purposes.

New Hampshire has reorganized her forestry commission, and is contemplating a law for establishing a forest office.

Vermont has established in the Agricultural Experiment Station, at Burlington, a State nursery for growing forest tree seedlings, to be furnished for planting in the State at cost.

Massachusetts seeks to assist land owners to convert practically idle land areas into profitable woodlots. The State Forester distributes literature regarding white pine seed and also a limited number of white pine and white ash trees for planting. The State requires spark arrestors on locomotives, the keeping of railroad rights-of-way clear of dead leaves and brush, and authorizes railroads to clear adjacent, unoccupied land. Railroad employees are also required to fight fires. Newly established town officials are held responsible for fighting all fires started by railways, hunters, or careless or malicious persons.

Connecticut's new fire warden service is proving effective. This fact is encouraging planting, 350,000 seedlings having been planted last spring. The State Agricultural Experiment Station, through its Forester, offers advice and aid to owners of woodlands.

New York State owns 1,347,280 acres out of 3,313,564 acres of the Adirondack reserve; and 92,708 in the Catskill reserve, as against 483,412 acres privately owned. The so-called Merritt resolution, looking to a constitutional amendment to permit private owners to enter the State forests and construct dams for

the storage of water, called out a vigorous protest. The new Forest Land Purchasing Board is preparing to resume the work of buying additional lands in the Adirondaeks and Catskills. A new National Park on the Hudson,

to include West Point, is proposed. Efficient fire patrol is maintained in the State preserves, and three large nurseries for conifers are maintained in Franklin County, and one for hardwoods in Ulster County.

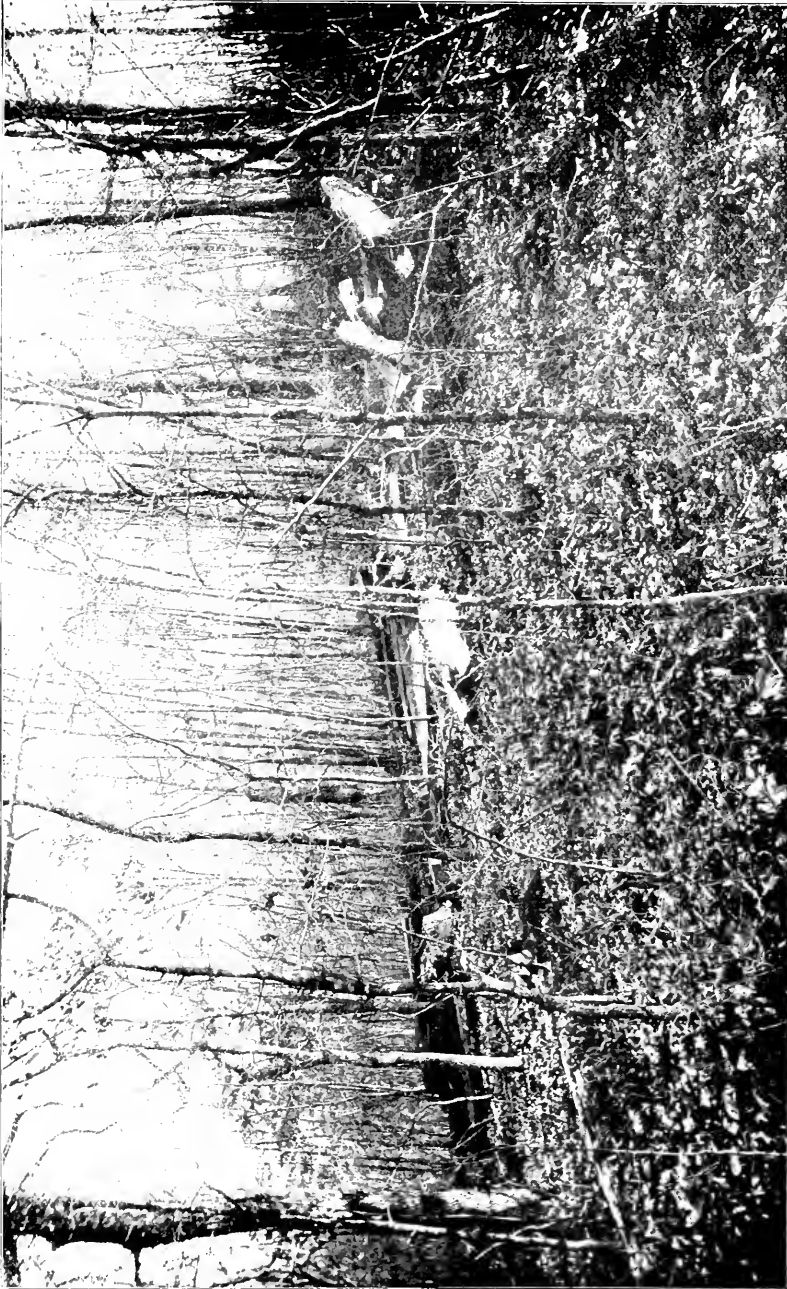

Conservative lumbering—A large ccedrwood without injury to the saplings about it—
Biltmore, North Carolina

New Jersey has appointed a State Forester who assists private land owners, instructs teachers and farmers, and co-operates with the State fire warden and with the Forest Park Reservation Commission. The Forester is also planting extensively. Last summer the Forest Commission bought 5,400 acres of forest on the Kittatinny Mountains to add to the State reserves. The Commission has established the policy of employing the State forests to produce lumber, as well as to be used for parks. Subsequent additions in Warren, Burlington, and Atlantic Counties have been made. The State now has 7,438 acres set apart for State forest purposes. The State is struggling with the problem of so taxing forest lands as to encourage their permanent holding for repeated crops. The State Forest Council, the outgrowth of a committee on forestry appointed forty years ago by the West Vineland Farm Club, assists in forestry propaganda and education.

Pennsylvania is planting industriously. The last legislature passed a law to provide for the planting and care of shade trees on all the highways of the Commonwealth, in town or country. An important fire prevention law was also enacted. The State is endeavoring to protect its forests by a rational taxation method; its tax exemption law, however, designed to equalize taxes for owners of timberlands, has been declared unconstitutional. The State reserves now amount to about 830,000 acres.

Delaware's Agricultural Experiment Station has requested the Forest Service to make a study of forest conditions in the State, and to work out a State forest policy.

Maryland's forester lectures and does field work. The Governor appoints forest wardens to work under the forester. In co-operation with the Maryland Experiment Station, the forester has established a nursery at College Park. The State is building up a system of reserves; these are being enlarged by private gifts.

West Virginia is contemplating the enactment of a forestry law. In October the State Board of Trade called together an important meeting at Elkins to consider the forest resources and interests of the State.

In Kentucky the State Board of Agriculture, Forestry and Immigration, in co-operation with the Forest Service, is investigating the forest resources of the State. A comprehensive report has been submitted to the State Board concerning all the territory drained by the Big Sandy and Little Sandy Rivers and Tagert Creek. The work will be resumed next spring.

Mississippi, like Kentucky, is co-operating with the Forest Service in a study of the forest conditions of the State. A preliminary report regarding the long leaf pine region and a proposed fire law will be laid before the Legislature at its present session.

Alabama is co-operating with the Forest Service in testing timbers. The State has recently enacted a comprehensive and noteworthy forestry law, providing for a State Forestry Commission, which has held its first meeting and organized.

Indiana's Forest Commission is studying the natural and planted forests of the State, and publishing the results. Tree planting is in progress. The question of relieving young timber from taxation is also under discussion.

In Ohio the forestry department of the State Agricultural Experiment Station co-operates in tree planting with the farmers. The Governor of the State warns the Legislature of the disappearance of the forests and urges appropriate legislation.

Michigan is becoming thoroughly aroused to the importance of reforestation. Great good was accomplished by the recent meeting at Saginaw. A commission of inquiry has recently been appointed to report to the Legislature of 1908 a definite forest and land policy for Michigan. The Constitutional Convention appointed a committee on forestry and sent it to the meeting at Saginaw.

Wisconsin's Legislature has provided for the purchase of tax sale lands by the Forestry Commission, to be used as State forest and for storing waters upon Wisconsin rivers to maintain equable stream flow. Some 320 fire wardens are maintained by the State. The Nebagamon Lumber Company has given 4,000 acres of land to the State as a forest reserve.

Minnesota's excellent fire law is made effective through the efforts of a volunteer patrol. The Governor strongly urged upon the last Legislature the importance of forestry legislation, but with little effect.

In Iowa the State Experiment Station is conducting an educational propaganda through the use of bulletins.

Nebraska leads in tree planting.

In Kansas the Commissioner of Forestry gathers statistics of forest planting through annual reports from those to whom stock has been furnished.

Arkansas has recently been provided with a National Forest of over a million acres, the easternmost of all our National Forests.

In Colorado the Agricultural Experiment Station is experimenting extensively in tree planting. Convincing evidence exists of strongly improving sentiment in favor of forestry and the National Forest policy.

In Arizona, the Grand Canyon of the Colorado, a part of the Grand Canyon National Forest, has recently been proclaimed by the President, under the act of June 8, 1906, as a National Monument.

The newly established Oregon Forestry Commission has organized, and arranged for the appointment of about 400 fire wardens and the distribution of 500 copies of the new forest fire law.

In California the State Forester is experimenting with the planting of eucalyptus, and the regents of the State University contemplate reforesting the slopes east of the university. The State convention at Petaluma took advanced ground, among other things recommending that the expense of extinguishing forest fires be shared

equally by the State and the county involved. The State Forester has organized fire patrols in ten counties; 367 fire wardens have been appointed, and thirty miles of fire lines, encircling redwood parks, have been cleared. In southern California the co-operation of ranchers, water companies, and towns along the foothills with the National Forest supervisor has been secured in the building of fire-breaks for the better protection of the National Forest. The State Forester is utilizing the State police powers to protect the watersheds against devastation by private owners. The National Forests have been enlarged, one extension including the famous Calaveras grove of big trees. More recently, the President has made a National Monument of the Pinnacles, one of the natural wonders of the State.

Until recently Hawaii has had reserves of 300,000 acres, the Territory owning nearly half, but all managed under plans prepared by the Superintendent of Forestry. An addition of 23,000 acres has recently been made on the Island of Maui by the provision that the government lands within reserve limits now leased to private parties shall, at the expiration of the present leases, become part of the forest reserve. The private lands are sometimes administered by the Territorial Board of Agriculture and Forestry. Private owners show a general disposition to turn over their lands to the Government for administration under forestry principles. They have also agreed to reforest government lands at private expense. The Governor has proclaimed November 15th as Arbor Day.

Interstate action is now being discussed. At the Saginaw, Mich., meeting a conference of the foresters of Minnesota, Wisconsin, Michigan, Illinois, Ontario, and Quebec was held to devise suitable uniform legislation on the taxation of growing forests and the burning of slash by lumbermen.

On the whole, a decided improvement in the forestry situation in the States is evident.

Again, evidence of increased interest in tree planting and forest conservation on the part of cities, business concerns, and individuals daily multiplies.

A multitude of business organizations, municipal, state, and national, are putting themselves on record in favor of the general forestry movement, and especially the Appalachian Bill. The Carriage Builders' National Association, the National Lumber Manufacturers' Association, the National Association of Manufacturers, the American Mutual Newspaper Association, the Convention for the Extension of Foreign Commerce, the National Box Manufacturers' Association, the Slack Coöperation Manufacturers' Association, the National Board of Trade, the American Cotton Manufacturers' Association, and many others have emphatically declared for the preservation of the forests and streams of the Appalachian and White Mountains. Boards of Trade and Chambers of Commerce, South and West, extended a cordial welcome to the Association's secretary during his Appalachian campaign, assumed the responsibility for many of his meetings, and unanimously passed Appalachian resolutions. The National Irrigation Congress at Sacramento took strong ground in favor of the forestry movement, and earnest words were spoken for forestry at the Rivers and Harbors Congress in Washington, and at the Drainage Convention in Baltimore. The sportsmen's shows in Boston and New York gave good space for forestry exhibits.

The year has witnessed the organization of the Tri-Counties Reforestation Committee (on January 9), representing San Bernardino, Orange and Riverside Counties, for the purpose of carrying on reforestation work in the San Bernardino National Forest; of the Georgia Forestry Association, on March 11; of the Maine Forestry Association, March 14-15; and of the Paducah (Ky.) Forest Association, inaugurated October 17.

The older organizations of the Eastern States have continued their activity. The newer Michigan Forestry Association is especially interested in reforestation and rational taxation of growing timber. Its meeting at Saginaw in November was one of the most notable forestry events of the year. The Iowa Park and Forestry Association held its seventh annual meeting on December 10-11 at Des Moines.

The Nebraska Park and Forest Association is agitating for the transformation of the Wet Mountain Valley Reserve into a park, to constitute a retreat for Kansas, Nebraska, Missouri, and Iowa.

The Appalachian-White Mountain Bill has been actively promoted by the Massachusetts Forestry Association, the Society for the Protection of New Hampshire Forests, the Appalachian Mountain Club, and the newly organized National Forest Association, with headquarters in Atlanta, Ga. The work of the latter has been materially aided by the American Institute of Electrical Engineers and the Georgia Federation of Women's Clubs. The American Civic Association, the American Association for the Advancement of Science, and the Association of State University Presidents have also aided. The Society of American Foresters meets monthly in Washington in the winter season, and continues its scientific work; while the splendid educational and propaganda work of the General Federation of Women's Clubs is worthy of the highest commendation.

The advancement in educational work in forestry is most encouraging. In the University of Maine the class in forestry studied forest conditions on a tract of over 24,000 acres of State land, and secured data for a map and estimates of stand of lumber, together with other important material.

In Massachusetts, forestry instruction is given in both Harvard University and the State Agricultural Col-

lege. Harvard has been given 2,000 acres of timber land to serve as an adjunct to the department of forestry. The Agricultural College gives a four years' undergraduate course in forestry, and provides large nurseries, an arboretum, a natural forest, and other equipment.

At Yale the new course in practical lumbering endowed by the National Lumber Manufacturers' Association is a pronounced success. The senior class has spent three and a half months studying in the short-leaf pine forests of Missouri.

In Pennsylvania, forestry instruction is given in the State College and at Mount Alto. The forestry department in the State College was established this year. A four years' course, leading to the degree of bachelor of science, is given. The students work in the adjacent State forest. Mount Alto gives a three years' course, and provides practical work in the summer on the Mount Alto reservation.

Newark, N. J., has given a successful forestry exhibition in its Free Public Library.

The Maryland Forester gives lectures in the State Agricultural College and before granges and farmers' institutes and clubs.

Berea College, Kentucky, gives a preparatory course in forestry. The college has 4,000 acres of woodland in which forest problems are investigated. Some practical lumbering is also done by the college.

In the Biltmore Forest School, near Asheville, N. C., all summer work is done in the woods; logging and milling operations are studied at first hand, while the Biltmore nurseries and plantation progress are inspected from time to time.

Michigan teaches forestry in her State University, which maintains a flourishing department, and in her Agricultural College. The latter institution has given forestry instruction for fifteen years. The course is four years long. The Legislature set aside 40,000 acres of land in Iosco and Alcona counties for a forest reserve,

to be managed by the State Board of Agriculture, and the income to be applied to the college. The reserve is to be utilized by students for purposes of practical study. The college forest nursery includes five acres.

Minnesota's State Forestry Board has provided for a summer school of forestry at the Itasca State Park. Twenty thousand acres surrounding the lake have been given by the Legislature to the Forestry Board with permission to establish a demonstration school of forestry under the management of the State University regents. A four years' course is provided. The attempt will be made to manage the tract as a model forest. A forestry experiment station is to be established. Students are expected to spend ten months of the year in practical work in the woods.

The Legislature of North Dakota has appropriated \$25,000 for a new building for the School of Forestry.

The University of Nebraska maintains a well-patronized department of forestry. The students have organized a forestry club, meeting twice a month.

In Colorado, forestry is taught in Colorado College (Colorado Springs) and in the State Agricultural College (Fort Collins). At the latter institution a short course in technical forestry has been given, almost half of the students being forest supervisors, rangers, or guards, some of whom had come hundreds of miles and forfeited pay in order to attend.

The State of Washington has recently established forestry departments in both its University and Agricultural College.

Other agencies contribute to educational work. Arbor Day, proclaimed by the President, is becoming a potent factor in the education of school children; in its observance, increasing emphasis is laid upon the practical rather than upon the purely sentimental side.

A number of States provide forestry lectures before farmers' institutes. The lecture campaign by Mr.

Enos A. Mills has brought forestry truth and inspiration to thousands. In Portland, Oregon, an evening school of practical forestry has been conducted under the auspices of the Young Men's Christian Association, and is now regarded as a permanent institution; while the press, that mightiest of educational factors, may now be regarded as practically a unit in favor of forestry.

Outside the areas of State and National control, forest fires have again raged, much as in the past. Among those recorded in FORESTRY AND IRRIGATION may be mentioned one at Cape May, N. J., covering fifty acres; one at Bellingham, Wash., calling out 500 men for its extinguishment; one at Amagansett, L. I., destroying a half million dollars' worth of timber; one at Strawn, Tex., which ran over three square miles; one in Venango County, Pa., covering over ten square miles, and destroying \$75,000 worth of timber; one near Plymouth, Mass., burning over from 5,000 to 6,000 acres, and destroying old and fine estates, including historical landmarks antedating the Revolution; one at Visalia, Cal., devastating 75 square miles; one at San Raphael, Cal., burning over 1,000 acres; and, finally, fires in the White Mountains which, following in the wake of the lumberman, have scoured 35,000 acres. Mt. Bond has been swept clean, the easterly slope of Mt. Garfield burned over, the southerly slope of Mt. Guyot was seriously damaged, and Mt. Lafayette was also affected. In States maintaining fire warden systems, however, the ravages of fire are materially diminished, while in the National Forests the fire damage has been reduced to \$26,000—a negligible quantity.

The question of forest taxation is more and more coming to the front, and increasing numbers are realizing the unwisdom of taxing growing forests out of existence. Connecticut, New Hampshire, Colorado, Indiana, Maine, Rhode Island, and Wisconsin have enacted laws reducing or ex-

empting from taxation to encourage the growing of forests. In Iowa, forest reservations (in private ownership) are assessed for taxation at one dollar an acre. The disposition is growing to tax not the growing timber, but only the land upon which it grows, taxing, finally, the timber when it is cut. Some State constitutions expressly exempt growing crops. By treating forests as growing crops they may be permitted this exemption.

Notable addresses on the taxation question were made at the Saginaw meeting, above mentioned.

The Appalachian bill, unanimously passed by the Senate, unanimously recommended for passage by the House Committee on Agriculture, and strongly urged by the President, failed again to reach a vote in the House. The brevity of the last session and the lack of an adequate survey of the areas proposed to be purchased were urged as reasons. We are now in the midst of the long session; a complete survey has been made and the report of the Secretary of Agriculture, accompanied by maps, is before Congress. Within the last twelve months the tide of Appalachian sentiment has mightily risen. A flood of articles, editorials, resolutions and petitions demanding this measure has been poured forth. The time at last has come when this legislation should, without fail, be written upon our National statutes.

A final word. Viewed from one standpoint, the progress made within the last year is most encouraging. Viewed from another, however, the situation is serious. Four-fifths of the forests of the United States still remain in private hands or are likely to pass into private hands. Experience infallibly teaches that forests thus owned and controlled are, in the majority of instances, in danger of destruction. The work of destruction is now in progress. While we wait, our resources are disappearing, many of them never to be restored. If these

are to be conserved for the use of all the people for all time, every citizen should be aroused to do his full duty.

But thus to arouse a population so vast as that of the United States necessitates a far-reaching educational campaign. In this the Association should vigorously engage on a scale far larger than has hitherto been found practicable. Its efforts are now strictly limited by the means at its disposal. That it may rightly do the work that it should do, and desires to do, its arms should be materially strengthened and its resources greatly increased. How to secure this added strength is to-day our chief problem. Membership dues are helpful in so far as available. But to secure them through solicitations by the office itself requires effort which should be expended directly in the work of arousing and educating the people. In the enlistment of new members, present members can materially aid; and they are earnestly urged to use their utmost endeavor to this end. But

membership dues,* alone, should no longer be looked upon as our chief resource. Substantial contributions, such as constantly pour into the treasuries of schools, colleges, and various other private institutions, should be earnestly sought. And here again is a field for the interest and activity of our members. Some of them are personally well able to aid in the work of properly equipping the Association. Others can aid by interesting friends, themselves able to contribute to our treasury. The time has come when our work should no longer halt through lack of means. That this organization may rise to the full measure of its responsibility, we appeal to our members, one and all, to assist, each in his own way and to the full extent of his ability, in so equipping it as to make it a mighty power for the conservation of our forests, together with all our natural resources, and the vast human interests dependent thereupon.

THE OAK DEFIANT

BY

Frederick Le Roy Sargent, Cambridge, Massachusetts

Upon the stormward bastion of the hill
Standeth the oak, defiant;
A warrior of indomitable will,
Dauntless, a grisly giant.

He laugheth loud to scorn the lowering
host
Whose onset thundereth in the north;
And matching menace with a valiant
boast,
His leaves a challenge rattle forth.

Lightnings reply! The tree with Titan
reach
Seizeth the bolt descending:
Wrenched from his trunk his arm, with
grewsome breach,
Shattered, falleth defending.

Yet louder than the severed fibers' crack,
Above the reverberating rage

Of baffled foes, roareth the oak, "Come
back!
Behold, I've flung you down my gage!

"Fear not if ye return to find me weak;
For though your strength grow vaster,
This arm of mine again shall make you
shriek,
Owning me still your master."

Muttering, the vanquished hordes that
could not slay
The oak with all their maniac might,
In huddled rout, cloud hid, have slunk
away
Into the deepest caves of night.

Steadfast, exulting in the battle-thrill
Of prowess proved, reliant,
Upon the silent bastion of the hill
Standeth the oak, defiant.

THE PROPRIETY AND NEED OF FEDERAL ACTION*

BY

Hon. Hoke Smith, Governor of Georgia

MR. CHAIRMAN AND GENTLEMEN:

I desire, on behalf of those who are here, from Maine to Georgia, and from as far west as Ohio, to thank you for the courteous hearing that you have given us. We believe that we come in support of a measure that has great National importance—one that we believe it is impossible to carry out except, first, by National action. It has been suggested by members of the committee that the States should handle the problem. That is an impossibility. The forest experts who have come before you have shown how impossible it is for South Carolina to handle her problem; and it is as impossible for North Carolina to handle hers. How impossible it is to expect West Virginia to handle the problem. The beneficial results would reach away over into Kentucky and into Indiana and into Illinois. How unreasonable it would be to ask North Carolina to handle the problem, when the streams there rising flow on down through Tennessee and Alabama, and back up through Tennessee, and even to Paducah, Ky., and then down the Mississippi. The beneficial effects of this bill are so National in their character that it is utterly impossible to apportion the responsibility between the States where the land lies. I wish, however, to say to you in behalf of the Governors of the States of the Southern Appalachian Range, of West Virginia, of Kentucky, of Tennessee, of Alabama, of South Carolina, of North Carolina, and of Virginia, that they have asked me to be here to speak for them, as well as for myself. All of them, except two, have Legislatures on hand, and found it impossible to be here;

and the other two had meetings fixed weeks ago of such importance that they could not leave. I have received letters from a number of them in the last three weeks; and I come to say to you from them, as well as from my own State, that when the Nation takes hold of this great problem and does its part, then I believe you can readily expect to see the States follow in the line of your action and help handle nobly all that part of the responsibility which should properly fall upon the States. And, furthermore, with the inspiration of the service that will come from the National work, and with the further stimulant of the local forestry work done by the States, we may well expect to see the people along the lines of these streams themselves inspired to make efforts that heretofore they would have been discouraged from making; we may well expect to see them inspired by National and State effort, responding, with their small pieces of land, to carry on the good work to preserve the streams, so important to the welfare of our glorious country.

Mr. Chairman and gentlemen, the last speaker has called your attention to the important problem of health. We have piled testimony from experts before you, upon the problem of the timber. They have shown you that in these two ranges of mountains is now the last hope for that part of the country east of the Mississippi to preserve timber for the future use of the people. We have lived so fast here, our resources have been so great, that we have been careless about them. Piling up wealth easily, we forget to conserve the natural resources of our country for those who are to come af-

*Remarks at the hearing on the Appalachian Bill, before the House Committee on Agriculture, January 30, 1908.

ter us. I hold here in my hand pictures of what it has cost France. She is now spending fifty dollars an acre to try and stop the wash on the sides of the mountains, that she may plant trees; and we come to ask you to spend a dollar an acre and buy the mountain sides before they are washed away, that the trees may continue to grow.

The lumber problem, gentlemen, is sufficient by itself to appeal to you as a National problem, but I pass at once to one of greater importance, perhaps, the problem of power. We consume our lumber, we consume our coal; then what are we to depend upon for power, what are we to depend upon for heat? The flow of our streams! The power to create electricity from our streams, if we will conserve them and preserve the source, must largely protect us from the waste of our coal and the waste of our lumber. The great manufacturing possibilities of the future of the country depend upon your action. I do not, gentlemen, urge at this time the reservoir system presented by your Government expert who spoke a few moments ago. That may be a question in the future. It may be one for consideration fifty years hence; but if you allow these forests to go, then, as your expert told us at this hearing, you have taken away from the future the possibility of creating the enormous amount of additional power and creative force that could come from reservoirs, as the result of the streams, which the forest must preserve.

Mr. Chairman and gentlemen, I come to the proposition of navigation. It has been absolutely demonstrated before you that if we are to have inland waterways, we must preserve the trees on the mountain sides, on both these ranges. Testimony comes to you from your employed experts. It comes to you from practical business men, who have seen and who know. If this were a trial before a court, the testimony presented would require a verdict and the entry of a judgment

that the navigable streams of this whole section rest for their future upon the preservation of the trees upon these mountain sides. It is hardly necessary for me to add a word to the clear, simple, powerful presentation of the constitutional right. If you have the power to take the sand and the debris out of the stream, how can it be possible that you have not the constitutional power to keep it from getting into the streams? Is it possible that our Constitution is one that gives you the right to dredge harbors and dredge navigable streams, and spend your millions on this, and yet does not give you the power to buy a piece of land with a single expenditure that will save you the yearly expenditure? Is it possible that under the Constitution you cannot buy the land to stop the wash, although you can spend the money to clean out the dirt that the wash produces. The proposition shocks me.

I have read the Kansas *vs.* Colorado decision. Not only does it fail to touch this case, for the reason given by the gentleman who just spoke, but it fails to touch it for another reason. In that case the proposition was to consume the water belonging to the riparian holders in Kansas for the use of irrigation in Colorado. Here, instead of taking something that belongs to somebody else, instead of the Government undertaking in one State to take something in the shape of water away from another State, you are proposing to help the people, on every bank, in every State, through which the stream flows.

Mr. Chairman and gentlemen, I would not consume your time upon that subject or upon this case. I believe, and I dare state it, although I am a strict constructionist, that where there is a great National purpose to be subserved, a great National benefit to be done, without interfering with the rights of a State or the rights of an individual, the general welfare clause of our Constitution means something. I would not stretch it to in-

vade the right of a State or the right of an individual, but where it is appealed to in order to serve the welfare of the people of the whole country, I would be willing to plant myself upon it and say it means something.

Mr. Chairman and gentlemen, we thank you for this hearing. We come to you not only from all these States, but we come to you from perhaps more organizations of people who are disinterested, except as moved by the desire to serve their country, than any gathering that has ever appeared before a Congressional Committee. Business organizations, woman's organizations, patriotic organizations all over your land are represented here. They are not here to sell any land; not a man before you has a foot of land to sell; not a man before you has a thing to put off on the Nation as a job; not a dollar is to be made by anybody who is here. They come as volunteers, moved by the love they have of their States and their country, because they feel that their section and their States and their Nation have come in to lay the case before you.

Two years ago this cause was strong. I ask you, Mr. Chairman, if it is not ten times as strong to-day?

We know that each year which slips by jeopardizes the cause we are urging. We know that if you delay, you wreck, with unspeakable damage, the cause for which we plead; that the woodsman's axe is destroying that which we would save; and we beg you, gentlemen, do not postpone it. You have heard us early in the session, in time to present this bill at the present Congress. It is not the next Congress we want to do it; it is this Congress, Mr. Chairman.

It is not a committee of men to think about it, that we are begging for; it is for authority for somebody to go and begin buying the ground, buying the stuff, and doing the work, that we are asking you to report favorably upon. Gentlemen, we leave it with you. We believe that we represent the interests of the whole section of people east of the Mississippi. We believe that every day it is presented to them it will grow stronger and stronger. We believe there will become one swelling throb of thanks from every voice—except from some who have some constitutional doubts, and we do not think there are very many of them. We believe that you will render a service to your country, and we plead with you to do it now.

A HICKORY TREE ON ARBOR DAY

I am going to plant a hickory tree,
And then, when I'm a man,
My boys and girls may come and eat
Just all the nuts they can!

And I shall say "My children dear,
This tree that you enjoy
I set for you one Arbor Day,
When I was but a boy."

And they will answer, "Oh, how kind
To plant for us this tree!"
And then they'll crack the fattest nuts
And give them all to me!

WORK IN A NATIONAL FOREST

BY

Charles Howard Shinn, Supervisor of Sierra (North) National Forest

No. 6: Christmas in Sierra North

THE holiday season away up here among the oaks and pines has had a charm all its own. I cannot do better than to leave for a little my stories of toil and war, to give you, my readers, a glimpse of how forest people pass happy winters in their cabins.

This will be printed in February, I suppose, but you are to think of it as written the last day of the old year, on a hilltop, in the midst of brown acres just beginning to color with the green of future hay-fields and under the pulses of a soft, warm rain.

Some of the rangers are away on their leaves of absence. They get fifteen days a year, you know, and if ill, can have fifteen days of sick leave. Most of them, however, think sick leave is more or less disgraceful, and a man who asked for it regularly would be laughed out of camp. The total of sick leave taken by thirty men in a year has been eighty-eight days, or an average of less than three each. Rheumatism, due to exposure, and the malarial and typhoidal fevers due to the bad sanitary conditions of some of the mills where the rangers who scale lumber have to stay, were responsible for forty-five days out of the eighty-eight, which reduces the incidentals to less than one and a half days' average loss per man.

There is no doubt that we are a healthy lot, and love our work too well to moon over a fire, even in winter. Unless a ranger is really sick enough to stay in bed, he does not want sick leave. To take it otherwise seems to him exactly what it is—trying to swindle the Service.

Leave of absence is quite a different thing. All the men have friends in

town. They like to think that when Christmas holidays approach they can "blow into" some vast place on the railroad—some county seat with stores and hotels and electric lights and theatres—and live in the midst of excitements. Most of them will solemnly take out their fifteen days, or all that is coming to them. Then they drift away with great splendor of cowboy attire. In a few days one hears of them as back again, chopping wood, putting shelves in their cabins, or otherwise making themselves comfortable for the winter. The thirty men on record here have averaged about ten days of actual time off. Some "have no use for it;" some find their time hangs heavy and come laughing back, re-married to their life and work. And they come back sober, strong, anxious to learn more, eager to do better work. The Service has gotten hold of them; it is in no wise the result of individual enthusiasm, of my daily word, or an inspector's visit, or the occasional man from Washington; it is merely an atmosphere which they have learned to love. Everywhere else they miss its sharp, cold ozone.

We begin to prepare for our holidays in midsummer at Ellis Meadow, in the Sugar Pines. There is a forest there which seems to us as if it were finer and more wonderful than anything else on earth. Some of us live there, open to the heavens for the most part, and we look out over the burning valleys across miles of foothills and see the far-off twinkle of the lights of Fresno, sixty miles away as the crow flies. It happens that we have a house for headquarters, and a fire-place, but we do not need it at all. In fact most of us prefer to slap down

our blankets under a tree, or pitch camp by a mountain stream. Up there in the great pine forest we gather up sacks full of cones and split out fragrant chunks of pitch-pine for the holiday fires.

In September the rangers' wives and children go about the rocky slopes in the sun and gather wild gooseberries and elderberries for jams and jellies to take to their lower camps. The mountain elderberry (*Sambucus glauca*) of California has all the flavor of wild blackberries. It seems as if it bore no relation to the mawkish berries of the bottom lands. The red and spiny wild gooseberry is equally superior to the whole company of cultivated varieties from Houghton to the Roaring Lion and Crown Bobs of English cottage gardens.

In the course of time, I think that the Forest Service will establish at their high mountain camps little gardens of hardy small fruits, and orchards of the hardier apples, pears, plums, Russian cherries, chestnuts, black walnuts, and eastern persimmons. Then one will see the rangers moving home to their camps in the lower mountains attended by a wagon-load or so of fruits, nuts and garden truck for the holidays and the long winter. But they will still gather the wild berries, taking what they can get (as now) in the struggle with birds, squirrels and Indians.

After we come down from the mountain camps away up in the pines, there is a long pause of preparation. Winter does not descend suddenly upon us. We make trips back and forth and move our belongings, fasten up our cabins, let down the wires on our fences so that the snow will not break them. Sometimes we find time to sow rye and clover in order that there shall be some early feed for the horses.

Most of these highland camps, you know, are six and seven thousand feet up in the air. Away back are still higher camps, which the grazing rangers visit; some of these are eight and ten thousand feet up, and no one will ever have much of a garden there. I

used to try radishes and lettuce in such places, but not with any success. Watercress and rhubarb are about the limit.

So you see all the young rangers of the highest Sierras come out to our forest camps, such as Ellis Meadow, and when we have bearing orchards of old-fashioned russets, pippins, greenings and spizenbergs, each one of these mountain lads will get a share and pack them down to his cabin. As it is, they share in the berries and vegetables.

Somehow the spirit of the service, which is "All for each and each for all," centers wonderfully in our rough mountain camps, and is nowhere more evident than as we begin to gather in and move down to the lower camps.

By the middle of October the work is in the lower country, not in the highlands. We find time to start gardens a little, to rake in some flower seeds, to dig and cultivate some. Mostly, however, aside from the regular work, we "get in supplies" while the long, hard roads to the valley are still passable. No one who does not know this country, year in and year out, can imagine how the bottom sometimes falls out of these roads and travel stops, no matter what you happen to want. The mails pull through, but at what cost in time, money, horseflesh and risk of life and limb no one is able to estimate.

But all winter long the work of the forest goes on. There are bridges to build, old trails and roads to repair and "brush out," new trails to hang along canyon edges. People have business with us—cattle men must be met and small timber sales carried on. So the rangers put on waterproofs in bad weather and keep coming and going. Sometimes the weather is simply heavenly for weeks at a time; clear airs move perpetually through the forest; clear skies bend overhead; the new grass grows and the buds swell, and the whole earth is wonderful to dwell on. Sometimes, on the other hand, rangers are sent out on forest business

to fight their way against storm and snow and mountain torrents.

Toward the end of December the rangers, without any fuss about it, begin to feel Christmassy. They have accumulated, by dint of letters to dealers and the United States postal-order system, something for everybody they know, including themselves. To the sophisticated mind of a townsman it might seem both amusing and pathetic to see a couple of big, hearty young mountaineers sitting in their winter cabin after their dishes are washed up, poring over the fascinating pages of one of the huge Chicago mail-order catalogues. They have been there before; they know the uncertainties of the game; but still it is exciting, and so every year they take a "Christmas flier," much to the disgust of the local storekeeper, who says to himself: "I can hold them boys on flour and canned truck, but every December the big catalogue gets away with them."

It is a rather sad fact that very few rangers can make their Christmas gifts themselves. They hardly know how, and they think that what they make would not be good enough for the occasion. I often wish that we had a "Wood Carver of 'Lympus'" up here. If one of our boys is ever brought back to us a cripple for life we will build him a cabin and teach him to carve greatly and to put the soul of things into his work, forgetting self and illuminating all our lives with his work. We have a genial old whittler who makes penholders and paper-knives, match boxes and all sorts of useful things from manzanita and dogwood and mountain mahogany. But our wood carver, to shape great paneled mantelpieces and historic chairs and mighty oaken doors for our assembly hall, has not yet risen above the horizon.

But rangers are remarkably handy in lots of ways, and I expect to see them more and more give each other home-made gifts—quirts, braided reins, hand-forged knives, picture frames, and furniture.

The Christmas dinner up here in the mountains is all our own—no flavor of the caterer or the restaurant or the French chef is about it. This year I happened to visit one of the older rangers, who owns a little farm twenty miles away. When I started back a box with a large live turkey in it was put into the buckboard.

"That's for the ranger boys, you know."

"Bless me, but I have already ordered a goose."

"You an' the boys can eat that, too."

When the goose came, which had been ordered through a ranger, it was delivered with the remark: "All paid for by the rangers at the northern camps for the boys at headquarters."

Then another lot of rangers gathered up some apples one Sunday, went off to a neighbor's and made cider for everybody. The technical assistant took his cart and horse and climbed away up to the fir belt for a Christmas tree.

Up at the little Indian mission we had Christmas Day services, but the rangers' wives and daughters were cooking dinners, and they had "divided up the work" so thoroughly that every unattached ranger and all the temporary men were provided for when the hour came.

After dark the entire available forest force—men, women and children—came together for a Christmas tree that a committee of rangers' wives had arranged for, with one ranger as Santa Claus—simple little gifts, each with its own cheerful "josh" or separate charm of forethought, each hailed with shouts from young and old. Then we read Christmas stories and sang Christmas songs, and refreshments galore were passed and re-passed, and the hours slipped away.

In this connection let me mention a pleasant thing. The lady of the nice little family hotel at Southfork sent up an extra large and choice cake as a gift to the "U. S. boys."

It was nearly midnight, and we began to think of breaking up. Sud-

denly one of our Sierra rainstorms swept down on us, which seemed the best joke of all. In the midst of it the horses were brought out of the sheds, the rangers gathered up the babies, tucked them under their "slickers," and mounted in hot haste; the wives and elder children spring to saddle. Everyone laughed and shouted together while the rain poured, and off they went, up the ridges, down the trails, across the creeks in the pitchy darkness! Some had to go a mile and some four or five miles in wind and rain, but it was the most amusing event of the season.

As I think it over and consider the possibilities of the rangers' holiday season I am afraid that to write it all down will sound foolish. But let it at least be said that in the course of time we ought to be able to develop many customs and usages all our own, and to keep alive many of the better sort of the old American traditions of mountain hospitality. Besides and beyond this I think it likely that the fellowship will widen, taking in, to some extent, the other forests and offices and departments; that by and by the Government scaler on Sale 12-1-08 in

Pike's Peak will be sending homemade Christmas cards to other scalers away up in the Siskiyou or the Olympics; that all the inspectors will be writing Christmas letters to the rangers they have camped with; that supervisors from Tongass to Taos will be gathering red apples in October and cutting great Yule logs of oak in November, and picking autumn berries and bringing in Christmas trees, and killing well-fatted holiday birds, and sitting at the heads of long and most festive tables where at least half the toasts will have to do with the Forest Service and its leaders.

Does any man or woman desire to know the price of the forest fellowship? Coming into it, one must learn to give and to take—"From each to all, from all to each." When mind and body are merged in the service, one is again as a child to whom all things seem new and wonderful and each day a gift from the high gods themselves. Then such homely little celebrations as ours, where we give a little wooden horse and a poem, half tease, half sorrow, to the ranger who has lately lost his saddle horse, become things greatly to enjoy and lastingly to remember.





UNITED STATES RECLAMATION SERVICE



Government Irrigation Work During the Month.

Another Opening— Shoshone

Another one of the splendid undertakings of the United States Reclamation Service is completed—to the extent of the opening of a portion of the land to settlement, namely, about 50,000 acres. This is the Shoshone project in northern Wyoming. The general location of the project is seventy-five miles east of the Yellowstone National Park. The total area to be irrigated is 250,000 acres.

The Shoshone project is notable for the size of its dam, constructed in a narrow pass between towering walls of rock. This dam encloses an impounding reservoir whose use is to store the water and let it out into the channel of the river as needed.

Further down the stream are two diversion dams. One of these, at the village of Corbett, turns the water aside into a tunnel running parallel with the river three and a half miles. This is necessary in order to obtain the water at a sufficient height to deliver it into the Garland Canal, which then carries the water to 50,000 acres of irrigable land lying north of the Shoshone River between Balston and Garland. This land is unusually level and well surfaced for irrigation.

The Canyon Reservoir

The impounding dam, in the narrowest portion of the canyon above the irrigated tract, will outstrip in height every other structure of this kind. It will have the form of a narrow wedge, 85 feet across the bottom,

200 feet long on top, and 310 feet high. The reservoir formed will flood 6,600 acres to an average depth of 69 feet. The walls of the canyon are solid granite; it was therefore believed at first glance that no trouble would be experienced in finding a foundation for the mammoth structure. The diamond drill, however, revealed an entirely different state of affairs. It pierced boulders many feet in thickness, but these rested on beds of gravel. At the point finally selected for the dam site bed rock was encountered 88 feet below the river bed.

A Tunnel Spillway

On account of the steep canyon walls it was necessary, in order to provide for a spillway by which the excessive floods might pass the dam, to dig a tunnel from the surface of the proposed reservoir around the dam, through the solid granite of the mountain, to discharge into the canyon several hundred feet below the dam. This tunnel will have a capacity of about 25,000 cubic feet per second, or sufficient to carry the largest floods of the stream.

To reach the dam site it was necessary to construct a road through an almost inaccessible gorge. On this road there are several tunnels through rock cliffs, and for several miles the road is in rock cuts. Incidentally this road is a scenic route of great beauty, and constitutes a new approach to the Yellowstone National Park.

Get Ahead of High Water The dam is not completed, but excavation of the channel is finished down to bed rock throughout the entire length of the structure up and down the stream. The rock walls and bottom of the foundation consist of the hardest of granite, absolutely without seams. The canyon walls are saw-tooth in shape, protruding into what will be the masonry foundation of the dam. The conditions developed make the dam site one of the most favorable that has ever been discovered. Construction will begin on the masonry at once. It is expected the contractors will have the base of the dam up to the original level of the stream well in advance of high water, which usually occurs in July. This is only one of the construction features involved in the Shoshone project.

The Diversion Dams The Corbett tunnel was completed November 29. This tunnel has a capacity of 1,000 cubic feet of water per second. The Corbett diverting dam was finished January 4. The portion of the project now completed includes this diversion dam and the canal which it supplies. The natural flow of the river, without the regulation supplied by the reservoir, will be more than ample for several years to meet the requirements of the land first irrigated.

Another diversion dam at Willwood, six miles below the Corbett dam, will conduct water through another tunnel, on the south side of the river, to irrigate the Willwood division, containing 25,000 acres.

The Land Open for Settlement The land to be irrigated is from 4,000 to 5,000 feet in elevation. Its quality is all that could be desired.

The 50,000-acre tract is bisected for its entire length by the C., B. & Q. Railway. Railroad stations are only five miles apart, affording most satisfactory transportation facilities for the settlers and their farm products. The first tract of 13,000 acres is already open to entry. The farm unit area has been fixed at eighty acres for most of the lands. A few of the farms immediately adjacent to the towns have been given forty-acre units. With a number of the units, however, is included a tract of eighty acres of grazing land.

For the 50,000 acres of land on the Garland Canal, the complete irrigation system will be completed during the calendar year 1908. Water will be supplied May 1 to 13,000 acres. There are already about 125 entrymen on the 50,000-acre tract; but this does not exhaust the land available, since 50,000 acres are equal to over 600 eighty-acre farms.

Costs to Be Met The total cost of constructing the irrigation system, including the lateral distributory ditches and turn-outs to each individual farm unit, amounts to an average of \$45 per acre, which is payable in ten annual instalments without interest. The total charge, with deferred payments not bearing interest, is equivalent to \$30 paid down at the time of purchase, or \$30 payable by instalments drawing interest.

It should be very carefully noted that the Government's charges are all based on deferred payments without interest, which makes the cost very easy for the settler.

Further description of this project and opening will be given in next month's magazine.





The Month in Government Forest Work.

Decision Against Drifting Cattle

The United States Circuit Court of Appeals at San Francisco has affirmed the decision of Judge Hunt in the grazing trespass case of the United States *vs.* Thomas Shannon. In December, 1904, Shannon allowed his cattle to drift upon the Little Belt National Forest in Montana. An injunction was issued perpetually restraining him from this. But Montana has a fence law, under which land owners must fence their lands before they can obtain redress from stockmen whose cattle on the public domain range upon private lands. Shannon's counsel argued that this law would apply against the United States; but the court held the contrary, Congress having unlimited jurisdiction over the public domain. This probably means that stockmen will have to restrain their cattle from drifting, and it will not be necessary to fence the National Forests.

Usefulness of Tupelo Gum

One of the latest discoveries of valuable qualities in a formerly neglected species has resulted from the investigation of tupelo gum, which finds its home in the Southern swamps. The facts brought out are perhaps as important as those regarding loblolly pine, another species which was neglected for many years, but is now put to valuable use. When the Forest Service took up this investigation two years ago tupelo was little known and seldom used, even where most plentiful. In the logging off of cypress in

the Gulf States the tupelo trees were entirely disregarded; but this lack of appreciation was due to ignorance of the properties of the wood and lack of care in handling it. The investigations have proved the value of tupelo, and in a short time the demand for the wood has rapidly increased. It is now widely used, not only where it grows, but in various sections of the country, for wooden pumps, musical sounding boards, and interior house furnishing; in the form of flooring it even competes successfully in California with Douglas fir.

To Re-Seed National Forest Ranges

Reseeding experiments are planned for next spring and summer on several of the National Forest ranges, to determine how those portions of the range which have been seriously damaged by overgrazing may be restored to their former productivity.

The plan is to establish experimental stations in several parts of the country. About six will be tried at first, so located as to secure typical conditions. The experiments will be begun on a small scale, on five or six acre tracts. Both native and wild grasses will be tried, but it is believed that the plan of encouraging native grasses will meet with greater success than the introduction of cultivated species, at least in the Rocky Mountain region. In the Coast Ranges, with their greater rainfall, cultivated grasses are more likely to play an important part in range development.

WITH MEMBERS AND CORRESPONDENTS

An Active Professor

Prof. E. S. Babcock, of Hamilton College, is a member of the American Forestry Association, and an active forestry worker. He last year planted seven acres to black walnuts, and is raising 50,000 white ash seedlings, and 8,000 hardy catalpa, besides preparing to plant 3,000 two-year-old white pine trees.

Professor Babcock a few weeks ago gave an address on forestry at the Central New York Farmers' Club, at Utica. He emphasized the value and necessity of forests to farmers. A motion was unanimously adopted by the club approving the recommendation of Governor Hughes to the Legislature that the State furnish seedlings to land owners at cost.

It is a good thing that farmers should be considering forestry in their meetings, and it is much to be hoped that the subject will be made a part of the program of such meetings generally.

Nursery Consolidation

The nursery businesses of Frederick W. Kelsey and others have been consolidated into the American Nursery Company, with Mr. Kelsey as the president. His nursery in the past has furnished large numbers of trees for woodland planting. He himself is an active member of the American Forestry Association.

The Letter to Members

Mr. Henry A. Barker, Chairman of the Committee on Parks and Public Reservations of the American Civic Association, writes:

"I wish to extend hearty congratulations for the most concise, convincing, and effective circular or letter, of date December 18, 1907. It is so short that he who runs may read. It is unanswerable. The facts are beyond question. It astounds me that any man worthy of a seat in Congress,

or even a vote in his own little village, can fail to be impressed with the gravity of a situation that demands Government aid to avert an irreparable National disaster."

Sweden and Norway

A member of the Association, travelling in Europe and writing from London to FORESTRY AND IRRIGATION says: "In Stockholm I went to see the Director of Forestry, and he said they had no trouble from large fires on account of their innumerable lakes. The forests there seem to be cultivated purely for the lumber interests, and they had never thought of cultivation to preserve their stream supply. Forests are largely held as Crown lands, but the country is transferring these to its own possession by purchase—though pretty slowly, I should think.

"Norway seems to have done almost nothing to preserve her immense forests, but I was told they 'would now begin.'"

Patriotic Service During Peace

Mr. George W. Dithridge, of Vencedora, Chihuahua, Mexico, writes these encouraging words:

"I am in receipt of your letter respecting subscription to FORESTRY AND IRRIGATION, and containing an invitation to become a member of the American Forestry Association, which invitation is accepted and will be followed by a remittance shortly.

"I am greatly interested in FORESTRY AND IRRIGATION, and read it through without flagging interest. Its editorial columns are first class, and have all the enthusiasm and vigor of a lover of forest, stream, and mountain. Yours is a congenial task, lovingly borne, and if any word of mine can warm your heart or nerve your purpose to even more determined service I would be a churl to withhold it. The advanced sentiments, so well

advocated, in favor of a large public service in the interest of the community as a unit, rather than a larger development of the scramble of individuals to appropriate the general heritage of national wealth, meet with my fullest approbation, and you and your allies will win out on that line.

"You have won a place in my esteem on the same plane with James Wilson, Gifford Pinchot, and Harvey W. Wiley, alike noble exponents of American national life, regardless of place of birth or race. And in naming these illustrious champions I do not fail to remember their loyal and faithful allies who show their spirit and labors and help maintain the standard of a devoted and disinterested public service.

"Count me as a follower in the ranks, willing to help a little somewhere along in the line of action."

Such appreciation is very gratifying, and the magazine and association are glad to welcome the co-operation of public-spirited men who believe in serving their country in time of peace. Some are willing to serve in time of war, who have no thought but of selfishness in peace. Peace tries the quality of patriotism.

Drives the Owner to Skinning A letter from Mr. Frank A. Cutting, dealer in hemlock bark, Boston, Mass., reads:

Enclosed you will find check for renewal subscription for the American Forestry Association. I am a thorough believer, as outlined by the Association. I think all important water sheds where the water flows through several States should be controlled by the National Government. The White Mountains and the Adirondacks should be added to the present holdings of the Government at an early date. Forestry can be managed by the United States Government in such a manner that there will be a perpetual source of income to the Government, and the streams and forest will be safeguarded better than they can be any other way.

Forests can be safeguarded by the individuals if there is co-operation on the part of the public in the way of taxes. The present method of taxing is unjust and drives the forest owner to skinning his land and getting the last cent out of it that he can and letting it go for taxes. Farming lands yield an annual crop. Forest lands will yield a crop about once in twenty years, if carefully handled. If the crop were taxed as taken off the land the owner could then afford to wait for his small trees to grow, and pay his tax when he marketed the product. Parties who own small tracts of rocky, worthless, sandy land could afford to plant it with young trees, and to protect them from fire until such time as the product would be ripe; but under present conditions no man can afford to plant trees and wait for them to grow, for as soon as they were of any value whatever the local assessor would increase his valuation and high taxes would follow.

Mr. Cutting is taking active steps to procure better legislation in this regard.

The Whole Philosophy Mr. John H. Bissel, of Detroit, thinks that Professor Fernow's paper on taxation at the Saginaw meeting, was "the greatest thing on the subject ever written—the whole philosophy in a nut-shell."

Saw Peril Thirty Years Ago A few observing people saw long ago what is now glaringly apparent. Aaron W. Frederick, of Northfork, Calif., says:

"I remember about 1877 my uncle, Jacob Frederick, then an old man, having lived all his life in Westmoreland County, Pennsylvania, called my attention to the damage and loss resulting from cutting down the forests. He had seen the forests cleared off, and noted the drying up of springs and streams, the drouth and baking of the soil, and the floods that piled the best of hill and valley along the channels of the swollen streams."

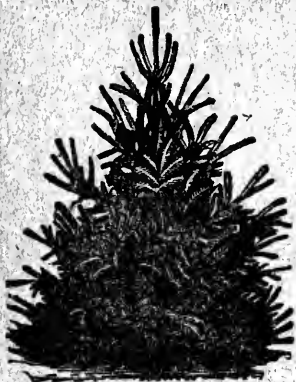

**Evergreens,
Forest Trees
and Seeds.**

*Three Millions of White Pine Seedlings and
nearly one ton of Seeds.*

Red Oaks, Linden, Black Locust

ALSO SEEDS

For forest planting on sandy soil I offer several millions Ponderosa and Jack Pines and Northern Red Cedar, and Seeds of same.

Northern Grown Trees and Seeds a Specialty
Mention this paper when you write.

D. HILL, Evergreen Specialist
DUNDEE, ILL.

BE A RAILWAY

Earn \$93 to \$130 a Month—Work
Only Half the Time. We prepare
you by mail to pass a successful

**MAIL
CLERK**



Civil Service
Examination.
Most complete course. Uncle Sam
wants Mail Clerks. Write today
for free catalog and special offer.
The Wenthe Correspondence School,
Box 90, Freeport, Illinois

ORCHIDS

ORCHIDS

We are the largest Orchid Growers
in the United States
Our Illustrated and Descriptive
Catalogue of Orchids is now ready
and may be had on application

Orchid Growers
and Importers

LAGER & HURRELL,
Summit, N. J.

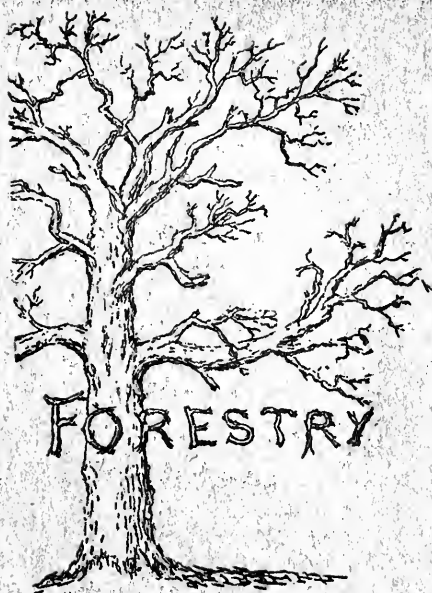

POWDER POINT SCHOOL, Duxbury, Mass.

In addition to the present work of the school, a new preparatory course in **Forestry** is being started, leading to the college courses in the subject. It requires hard, earnest application, and develops an appreciation of nature and power of leadership.

F. B. KNAPP, S. S.



**Rife Hydraulic
Ram**

(Pumps Water by Water Power)

Town Water Works,

**Railroad Tanks, Irrigation,
Country Homes, Greenhouses.**

No Attention—No Expense—Runs Continuously.

Operates under 18 inches to 50 feet fall. Elevates water
20 feet each foot of fall. 5000 in successful operation.
Sold on 30 days trial. Catalog and estimate free.

RIFE HYDRAULIC RAM COMPANY,
217 1/2 Trinity Bldg., New York.

The . . . **PAPER** . . . that this publication is printed
on is furnished by

R. P. Andrews Paper Co., Inc., Washington,

Sole Agents in the District of Columbia for the
West Virginia Pulp and Paper Company,
the Largest Manufacturers of Book Paper in
the world.

IF IN NEED, DROP THEM A LINE

In writing advertisers kindly mention **FORESTRY AND IRRIGATION**

Biltmore Forest School

Biltmore, N. C.



Theoretical and practical instruction in all branches of applied forestry.

The course comprises eighteen months; twelve consecutive months of lectures and field work, and six months of practical experience.

Object lessons within the mountain estate of George W. Vanderbilt, comprising 120,000 acres, where forestry has been practiced since 1895



For further information apply to

C. A. Schenck, Director

COLORADO SCHOOL OF FORESTRY...

Colorado Springs, Colo.

Three years' course in
TECHNICAL AND
APPLIED FORESTRY

Winter Term at Colorado College, Colorado Springs.
Summer Term at Manitou Park on the borders of the Pike's Peak Forest Reserve.

— TUITION, SIXTY DOLLARS
— A YEAR —

For further particulars apply to
WM. C. STURGIS, Dean

Colorado Springs - - - Colo.

YALE FOREST SCHOOL NEW HAVEN, . . CONNECTICUT

The course of study in THE YALE FOREST SCHOOL covers a period of two years. Graduates of collegiate institutions of high standing are admitted as candidates for the degree of Master of Forestry.

The Summer School of Forestry is conducted at Milford, Pike County, Fenna.

For further information address

Henry S. Graves, Director, New Haven, Conn.

FORESTRY AND IRRIGATION

Treasurer's Report

The Names of Mahogany

Arbor Day, The Spring Festival

Shall Uncle Sam Drain The Swamps?

Tree Planting in School Yards

California Irrigation Requires Forests

Canadian Forestry Association

Protection to American Industry

Meeting of Lumber Manufacturers

Thorburn's Seeds

Seed of *Pinus Banksiana* - \$4.00 per lb.
(Northern Jack Pine)

Seed of *Pinus Strobus* - \$1.50 per lb.
(White Pine)

Free by mail or express.

Special prices on large lots on application.
Also large line other tree and shrub seeds.
New crop imported natural grasses.
Send for 1908 catalog, ready about Jan. 1st.

J. M. Thorburn & Co.

33 Barclay Street,
Through to 38 Park Place

Established 1802

NEW YORK

This Solar can be used in hazy weather, when other Solars are useless. Used by the U. S. General Land Office.



Specifications:

Needle $3\frac{1}{2}$ inches long. Graduations $4\frac{1}{2}$ inches long reading minutes. Power of telescope 20 (with splendid definition, good light, and large field). Variation plate. Level to telescope, clamp and opposing screws. Vertical arc. Fixed Stadia-hairs. Extension

Tripod. Solar Attachment on side of standards.

Price, complete \$300

Telegraph and Code Word, Mountsolar

Illustrated Catalogue upon application

YOUNG & SONS, PHILADELPHIA

THE Pennsylvania State College

A thorough and practical undergraduate course in technical forestry, preparing men for all lines of professional and applied forestry.

Special attention is paid to practical field work in surveying, mapping and forest measurements. One of the largest of the State Forest Reserves is within a short walk of the college.

For information regarding entrance requirements, expenses, etc., address

Department of Forestry
State College, Penna.

PLANE SURVEYING

*A Text-book and
Pocket Manual*

By JOHN CLAYTON TRACY, C. E.

*Ass't Professor of Structural Engineering
Sheffield Scientific School of Yale University*

16 mo, xxvii + 792 pages, illustrated
with line cuts. Morocco, \$3.00

Used in the Yale Forestry School
and just adopted in Pennsylvania
Department of Forestry :: ::

Descriptive Circular on Application

JOHN WILEY & SONS

43 and 45 E. 19th St. New York City

IMPORTANT BOOKS ON FORESTRY

PRINCIPLES AND PRACTICE OF FORESTRY

Forest Mensuration. By HENRY SOLON GRAVES, M. A. A complete text book of this important subject and the first written for American Foresters. It deals with the determination of the volume of log, tree, or stand, and with the study of increments and yields. *Price, \$4.00*

Economics of Forestry, The. By H. E. FERNOW. This volume treats of forests and forestry from the standpoint of political economy, and is designed to furnish a trustworthy basis for formulating public policy. *Price, \$1.50*

First Book of Forestry, A. By FILIBERT ROTH. An outline of the general principles of forestry, written in simple, non-technical language, designed particularly for the beginner. *Price, \$1.10*

Practical Forestry, for Beginners in Forestry, Agricultural Students and Woodland Owners. By JOHN GIFFORD. A good general description of the principles of forestry with enough technical information to prepare the beginner. *Price, \$1.40*

History of the Lumber Industry of America. By J. E. DEFEBAUGH. The first authoritative work of its kind yet issued, and one which will commend itself alike to the timber owner, lumberman, lumber manufacturer, or merchant, or student of economics. In four volumes bound in half leather. *\$5.00 per volume.*

Forest Planting. By H. NICHOLAS JARCHOW. An illustrated treatise on methods and means of restoring denuded woodland. *Price, \$1.50*

Forestry. (Schwappach.) An English translation of "Forstwissenschaft." *Price, 70c*

Hedges, Windbreaks, Shelters and Live Fences. By E. P. POWELL. A treatise on the planting, growth and management of hedges with information concerning windbreaks and shelters. *Price, 70c.*

North American Forests and Forestry. By ERNEST BRUNCKEN. This volume, expository in its character, is written in a style intended for the general reader, to whom it should convey a good idea of our forests today. *Price, \$2.00*

Practical Forestry. By ANDREW S. FULLER. A treatise on the propagation, planting and cultivation, with descriptions and the botanical and popular names of all the indigenous trees of the United States, and notes on a large number of the most valuable exotic species. *Price, \$1.50*

Principles of American Forestry. By SAMUEL B. GREEN. Prepared especially for students in elementary forestry and for the general reader who wishes to secure a general idea of forestry in North America. *Price, \$1.50*

Seaside Planting of Trees and Shrubs. By ALFRED GAUT. Illustrated from photographs by FRANK SUTCLIFFE. This is a new volume in the English Country Life Library. Advice regarding selection and management to get satisfactory effects under adverse influence of closeness to seashore. *Price, \$1.75.*

Forest Management. By C. A. SCHENCK. Describes methods here and abroad to bring the most profit from all investments made in woodlands. *Price, \$1.25*

Forest Mensuration. By C. A. SCHENCK. Treats conditions in U. S. from mathematical and practical standpoint. *Price, \$1.25*

Forest Utilization. By C. A. SCHENCK. First treatise on this in U. S. Covers logging, lumbering, sawmilling, cooperage, paper-making, and description of all industries obtaining raw material from American forests. *Price, \$1.25*

Biltmore Lectures on Sylviculture. By C. A. SCHENCK. Written from author's long experience as forester of the Biltmore estate, where sylviculture has been practiced on a larger scale for a longer time than anywhere else in U. S., and where results become more apparent from year to year. *Price, \$2.50*

Forest Policy. By C. A. SCHENCK. (Second part.) Describes the various States of the Union under following heads: Area; physiography; distribution of forests; forest ownership; use of the forest; forestry movement; forest laws; forest reservations; irrigation. *Price, \$1.25*

Profession of Forestry, The. By GIFFORD PINCHOT. A pamphlet containing an address on that subject by Mr. Gifford Pinchot; also an address by Mr. Overton W. Price on "Study in Europe for American Forest Students," and a list of reference publications for students. *Price, 25c*

FOREIGN IMPORTATIONS

English Estate Forestry. By A. C. FORBES. An authoritative volume on English forest methods from the pen of a well known forester, that should prove of interest to Americans. *Price, \$5.50*

Forstwissenschaft. (Schwappach.) *Price, 60c*
Manual of Forestry. (Schlich.) Five volumes, complete, or separately as follows (*price, complete, \$18.80*):

Vol. I. "Forestry Policy in the British Empire." *Price, \$2.40*

Vol. II. "Sylviculture." *Price, \$3.20*

Vol. III. "Forest Management." *Price, \$3.60*

Vol. IV. "Forest Protection." *Price, \$1.80*

Vol. V. "Forest Utilization." *Price, \$1.80*

This is perhaps the most authoritative work that has been issued on the technical side of forestry, translated from the German.

Wood. By G. S. BOULGER. An important new book for arboriculturists and forestry students. A manual of the natural history and industrial applications of the timbers of commerce. Cloth. 82 Illustrations. *Price, \$2.60.*

Familiar Trees. By Prof. G. S. BOULGER. Written by an eminent botanical authority, yet couched in language easily understood. The coloured plates are the work of celebrated artists, and are truthful and trustworthy in every respect. A special feature is the series of photomicrographic illustrations of sections of woods. Three volumes. *Price, per volume, \$1.50.*

DENDROLOGY, BOTANY, AND IDENTIFICATION OF SPECIES

Manual of the Trees of North America (exclusive of Mexico). By CHARLES SPRAGUE SARGENT. A volume that presents in convenient form and with excellent illustrations, authoritative information concerning the trees of North America. It is written in a manner that enables the reader to readily find what family or species any particular tree belongs. *Price, \$6.00.*

American Woods. By ROMEYN B. HOUGH. A new departure in the publication of an authoritative work illustrated with actual wood sections of the various species described. Three are given of each, viz., radial, transverse, and tangential. Issued in ten parts, per part *Price, \$6.00*

Handbook of the Trees of the Northern U. S. and Canada, East of the Rocky Mountains. By ROMEYN B. HOUGH. Pictorial description of trees. Two pages to each species; photo-engravings of trunk, leaves, flowers or fruit, section of wood, and map of distribution, with botanical description, and brief other information. *Price, in buckram, \$5.00; in half morocco, \$10.00*

Flora of the Southern States. CHAPMAN. This is an excellent key to the flora of the south, complete and accurate in its scope. *Price, \$4.00*

Getting Acquainted with the Trees. By J. HORACE MCFARLAND. A handsome volume, copiously illustrated, and with facts accurately presented in an entertaining way. *Price, \$1.75*

How Plants Grow. By ASA GRAY. An understanding of the way in which a tree grows is of prime importance to the forester, and the matter here presented is accurate and authoritative. *Price, \$1.00*

Principal Species of Wood; Their Characteristic Properties. By CHARLES HENRY SNOW. No attempt is made to give exhaustive descriptions of species, but the author presents a mass of information designed for the use and instruction of woodworkers, etc., in a popular style. A host of concise information is brought under each head, and the work is a valuable one. *Price, \$2.50.*

Manual of Botany. By ASA GRAY. A key to the flora of the northeastern states, and the most authoritative publication of its nature.

Price, \$1.62; field edition, \$2.00

Trees of New England. By L. L. DAME and HENRY BROOKS. This book is a small volume which can be easily put in the pocket and carried in the woods, and at the same time is the best guide to the identification of our New England trees of any of the smaller books yet published. Price, \$1.50

Trees of Northeastern America. NEW-HALL. A good general check list of the more important trees of the northeastern United States.

Price, \$1.75

Trees and Shrubs. By C. S. SARGENT. The most thorough and authoritative publication yet issued, and a standard work. The matter is issued in parts, of which there are three already published.

Price, per part, \$5.00

Trees, Shrubs and Vines of the Northeastern United States. By H. E. PARKHURST. In this book the author describes the trees, shrubs, and vines of the northeastern United States in a popular way, the book being designed especially for persons who have never studied botany. To these it will appeal as a valuable guide to a familiarity with the salient characteristics of trees, shrubs and vines.

Price, \$1.50

Trees. A handbook of forest botany for the woodlands and the laboratory. By H. MARSHALL WARD. Vol. I, Buds and twigs. Vol. II, Leaves. Vol. III, Flowers and inflorescences. Three volumes to be added, on Fruits and seeds, Seedlings, Habit and conformation of the tree as a whole.

Price, per volume, \$1.50

PARTICULAR SPECIES AND LOCALITIES

Mountains of California, The. By JOHN MUIR. No other person is so well fitted to write of the mountains of California as John Muir, and the volume presented here describes not only the mountains themselves but the trees that clothe them and the wild life which they harbor.

Price, \$1.55

Our National Parks. By JOHN MUIR. If you want to learn about the glaciers, mountain peaks, canyons and great waterfalls of the West; of the habits of animals from the squirrel to the moose; plant life from the big trees to the wild flowers — in fact be brought face with nature's works, this is the book.

Price, \$1.55

Trees and Shrubs of Massachusetts. EMERSON. Two volumes. Plain cloth edition has 148 plates. The colored edition has 36 of these in colors. Price, plain, \$12.00. Price, colored, \$15.00.

The Earth as Modified by Human Action. By G. P. MARSH. A Revision of Man and Nature. Describes changes in the face of the earth caused by man, including desolation of various countries, once thickly inhabited, by removal of forests. Shows importance of maintaining natural balance of forces.

Price, \$3.50

The Longleaf Pine in Virgin Forest. A Silvical Study. By G. FREDERICK SCHWARZ. This is a study of the life history of this important forest tree. Intended primarily for foresters and forest students; also for owners and managers of pine timber lands. Deals with the preference or dislike of the species for particular conditions of soil, climate, and environment. Illustrations and six tables.

Price, \$7.25

The Sprout Forests of the Housatonic Valley of Connecticut. By G. F. SCHWARZ. Illustrated study of forests repeatedly cut over.

Price, \$5.00

IMPORTATIONS

Beautiful Rare Trees and Plants. By the EARL OF ANNESLEY. A description of some of the rarer English trees, shrubs and vines, illustrated copiously.

Price, \$12.00

Forests of Upper India and Their Inhabitants. By THOMAS W. WEBBER. This volume is an account of the author's life in India during the period shortly after 1857. It contains a vivid description of the country, its people, customs, etc., with some description of its forests and timber wealth.

Price, \$5.00

BOOKS ON IRRIGATION AND DRAINAGE

Irrigation in the United States. By F. H. NEWELL. The most authoritative and complete work on the subject which has yet been published, by the head of the Government's irrigation work.

Price, \$2.00

Irrigation Farming. By L. M. WILCOX. A newly revised edition of one of the standard works on irrigation. The principal chapters treat very fully of irrigation, its application, etc., and the volume is profusely illustrated.

Cloth, \$2.00

Irrigation for Farm, Garden and Orchard. By HENRY STEWART. This work is offered to those American farmers and other cultivators of the soil who, from painful experience, can readily appreciate the losses which result from the scarcity of water at critical periods.

Price, \$1.00

Irrigation and Drainage. By F. H. KING. While most of the existing books on these subjects have been written from engineering or legal standpoints, this one presents in a broad yet specific way the fundamental principles which underlie the methods of culture by irrigation and drainage.

Price, \$1.50

Irrigation Institutions. By ELWOOD MEAD. A discussion of the economic and legal questions created by the growth of irrigated agriculture in the West, by the Chief of Irrigation and Drainage Investigations of the Department of Agriculture.

Price, \$1.25

Land Draining. By MANLY MILES. A handbook for farmers on the principles and practise of draining, giving the results of his extended experience in laying tile drains.

Price, \$1.00

Land of Little Rain, The. By MRS. MARY AUSTIN. A nature book of the highest type. The volume is made up of a series of sketches of the human, animal, and plant life found in the region of the Mohave desert, Death Valley, and the Sierras, much of which the average person is likely to consider almost devoid of living things.

Price, \$2.00

IRRIGATION ENGINEERING AND CONSTRUCTIVE WORK

Design and Construction of Dams. By EDWARD WEGMANN. This volume includes an authoritative discussion of the constructive work involved and the principal forms of construction. Masonry, rock-fill and timber dams are discussed extensively.

Price, \$5.00

Improvement of Rivers. By B. F. THOMAS and D. A. WATT. This volume is a treatise on the methods employed for improving streams for open navigation and for navigation by means of locks and dams.

Price, \$6.50

Irrigation Engineering. By HERBERT M. WILSON. This is the fourth edition of Mr. Wilson's popular work, and the revision and enlargement which it has undergone, places it at the forefront of text books on the subject for American students.

Price, \$1.00

Engineering for Land Drainage. By C. G. ELLIOTT. A manual for laying out and constructing drains for the improvement of agricultural lands.

Price, \$1.50

Reservoirs for Irrigation, Water-power, and Domestic Water-supply. By JAMES DIX SCHUYLER. An account of various types of dams and the methods and plans of their construction, together with a discussion of the available water-supply for irrigation in various sections of arid America, distribution, application, and use of water: the rainfall, runoff, and evaporation from reservoirs, and effect of silt, etc.

Price, \$5.00

Water Supply Engineering. By A. PRESCOTT FOLWELL. A treatise on the designing, construction and maintenance of water-supply systems, both city and irrigation.

Price, \$4.00

Water Power. By JOSEPH P. FRIZELL. An outline of the development and application of the energy of flowing water. Price, \$6.00

Concrete, Plain and Reinforced. By FREDERICK W. TAYLOR and SANFORD E. THOMPSON. Designed for practicing engineers and contractors; text and reference book for students. Discusses materials, processes, and applications of concrete in construction and specifications. Price, \$5.00

Hydraulics. By MANSFIELD MERRIMAN. Purpose of book is to keep abreast of modern progress, and present subject with conciseness and clearness. Gives general principles and discusses flow of water through various kinds of openings and channels. Historical notes and references. Price, \$5.00

Foundations. By W. M. PATTON. A practical treatise explaining fully the principles involved. Numerous descriptions of important modern structures are given in sufficient detail. Includes articles on use of concrete in foundations. Price, \$5.00

Masonry Construction. By IRA O. BAKER. Contains results of a great number of experiments, and a large amount of practical data on cost of masonry, pile driving, foundations, culverts, etc., and 97 tables to facilitate estimating. Price, \$5.00

Reinforced Concrete. By ALBERT W. BUEL and CHARLES S. HILL. A treatise for designing and constructing engineers, governed by American practice and conditions. Theoretical discussions omitted, and replaced by practical working formulas, examples of representative structures, and records of practice. Price, \$5.00

BOOKS ON RELATED SUBJECTS

Utilization of Wood Waste by Distillation.—By Walter B. Harper. An important treatise on a subject regarding which the interest is great and the information scarce. Is intended to aid in the establishment and conduct of wood distilling enterprises on a business basis. Price, \$3.00

Handbook of Timber Preservation. By SAMUEL M. ROWE. Intended as a complete practical guide for the operator of a preservation plant, with hints on construction thereof. Price, \$4

In Forest Land. By DOUGLAS MALLOCH. The humor, sentiment and philosophy of the lumber business interpreted by the "Lumberman Poet." A kind of touch with the great outdoors that few books contain. Illustrated in tint, bound in silk cloth and gold stamped. Ideal for gift or library. Price, 1.25

The Garden

Roses and How to Grow Them. By many Experts. In text, practical; in subject and quality of illustrations, beautiful. Price, \$1.20

Ferns and How to Grow Them. By G. A. WOOLSON. The growing of hardy ferns, both in the garden and indoors. Price, \$1.20

Lawns and How to Make Them. By LEONARD BARRON. For the first time the subject of lawn seed mixtures is set forth and explained. 32 photographs. Price, \$1.20

How to Make School Gardens. By H. D. HEMENWAY. This suggestive little book is a practical manual of school gardening for both teacher and pupil, and supplies the first adequate work of the sort in this country. There are to-day a hundred thousand school gardens in Europe, and the progress of the recent movement in America has been most rapid. This volume is based on actual experience (the author is an authority and director of the Hartford School of Horticulture). Illustrations, 10. Price, \$1.10

How to Make a Fruit Garden. By S. W. FLETCHER. An eminently practical work on the subject of fruits for the home. With 182 photographic illustrations by the author. Price, \$2.25

How to Make a Flower Garden. A charming and a practical book by experts on every branch of the subject. More than 200 beautiful photographs. Price, \$1.75

How to Make a Vegetable Garden. By EDITH L. FULLERTON. The only adequate book on the home vegetable garden. 250 photographs by H. B. Fullerton. Price, \$2.20

Art and Craft of Garden Making. By THOMAS H. MAWSON. Third edition of this standard; out of print for a year, and now reissued in revised form. Over 100 plans and details of gardens. Methods employed by successful designers carefully analyzed. Characteristic sites in typical districts described and pictured. Price, \$15.00

The Home and Farm

The Country House. By CHARLES EDW. HOOPER. A practical manual of house building, absolutely invaluable to everyone with a country place. It covers every branch of the subject in detail and treats of the garden and its furnishings in connection with the dwelling. 380 photographs and plans. Price, \$3.30

Three Acres and Liberty. By BOLTON HALL. Description of what can be accomplished on a small place in the way of gardening, home-making, and addition to financial resources. Were it not for the unimpeachable authorities quoted, its statements as to the possibilities of the "Little Lands" for a living would seem fanciful. Price, \$1.85

The Making of a Country Home. By J. P. MOWERAY ("J. P. M."). This delightful story showed its universal appeal when published serially, and the volume amply carries out the intention of the author. Besides its practical interest for the thousands of city dwellers who have dreamed of having a country home, the story is one of such reality, humor, and interest as to ensure it the widest circulation in book form. Elaborately decorated. Price, \$1.65

The First Book of Farming. By CHARLES L. GOODRICH. No one interested in farming, old or young, can fail to appreciate this book, for it really gives the fundamental knowledge of how to conduct a farm with the least expense and the largest return. There are 63 full pages of helpful illustrations. The price is extremely low for a work of such value. 63 pages of photographs. Price, \$1.10

Nature Books

American Food and Game Fishes. By DAVID STARR JORDAN and B. W. EVERMANN. Fills a long-felt need in popular scientific works, being a full account of the life-histories and methods of capture of North American food and game fishes. The only book in existence which will enable the amateur readily to identify species new to him. With 10 lithographed color plates, 100 photographs of live fish in the water, and 200 text cuts. Price, \$4.40

Nature Biographies. By CLARENCE M. WEED. This volume is a sort of personal acquaintance with the lives of the more common butterflies, moths, grasshoppers, flies, and so on, the sort of fascinating details of these insect existences which make the reader want to go out and study these every-day marvels for himself. 150 photographic illustrations. Price, \$1.50

The Brook Book. By MARY ROGERS MILLER. A brook is one of the most living and companionable features of the landscape, and few people, even the most ardent nature lovers, realize what an endlessly interesting study its changes and its throbbing life afford. It is a fascinating subject which the author (well known as a teacher, lecturer, and writer connected with the Nature Study Bureau at Cornell) handles with much ability. 16 photographs. Price, \$1.50

Outdoors. A Book of the Woods, Fields and Marshlands. By ERNEST MCGAFFEY. Papers on out of doors, showing a love of nature and keenness of observation and power and beauty of description rarely surpassed. Price, \$1.25

Nature and the Camera. By A. RADCLIFFE DUGMORE. Mr. Dugmore is an expert in the new movement of photographing live birds, animals, fish, flowers, etc. His works brought him so many requests for information, that he has set down here a full and detailed account of his methods. From the choice of a camera to questions of lighting, and to the problem of "snapping" shy birds and animals in their native haunts, every step is explained so simply as to be easily comprehended, even by the beginner. 53 photographic illustrations. Price, \$1.50

THE American Forestry Association

Officers for 1908

President

HON. JAMES WILSON, Secretary of Agriculture

Vice-Presidents-at-Large

DR. EDWARD EVERETT HALE	DR. B. E. FERNOW	
N. J. BACHELDER	GEO. FOSTER PEABODY	GEO. C. PARDEE
RUTHERFORD P. HAYES	ALBERT SHAW	
W. W. FINLEY	J. T. ROTHROCK	
GEO. T. OLIVER	CHARLES R. VAN HISE	

Advisory Board Selected by Affiliated Organizations

SILAS W. GARDNER	H. H. WHELESS	
JAMES INNES	C. H. KEYS	ROBERT C. LIPPINCOTT
GEORGE F. CRAIG	C. A. SMITH	
GEORGE E. STONE	ALLEN CHAMBERLAIN	D. E. KLINE
E. F. SAWYER	F. E. WEYERHAEUSER	KENT SHEPPARD

Members of Board Designated as Vice-Presidents of Association

N. W. MCLEOD	LEWIS DILL	J. T. WYLIE
WILLIAM IRVINE	EDWIN A. START	D. E. KLINE

Secretary, THOMAS ELMER WILL, Washington, D. C.

Assistant Secretary, WILLIAM CANFIELD LEE, Washington, D. C.

Treasurer, OTTO LUEBKERT, Washington, D. C.

Directors

JAMES WILSON	WILLIAM L. HALL	W. J. MCGEE
GEO. P. WHITTLESEY	GEORGE K. SMITH	PHILIP W. AYRES
JAMES H. CUTLER	WILLIAM S. HARVEY	ROBERT GARRETT
HENRY S. GRAVES	H. A. PRESSEY	LIGON JOHNSON
F. H. NEWELL	ASBURY F. LEVER	FILIBERT ROTH

Application for Membership

To THOMAS ELMER WILL

Secretary American Forestry Association

1311 G Street, N.W., Washington, D. C.

Dear Sir: I hereby signify my desire to become a member of the American Forestry Association. Two Dollars (\$2.00) for annual dues are enclosed herewith.

Very truly yours,

Name _____

P. O. Address _____

. . T H E . .
AMERICAN FORESTRY ASSOCIATION

President—**HON. JAMES WILSON,**
Secretary of Agriculture.

The American Forestry Association was organized in 1882, and incorporated in January, 1897. It now has over 6,600 members, residents of every State in the Union, Canada, and foreign countries. From its origin it has been the tireless friend of the forests.

The object of the Association is to promote the preservation, by wise use, and the extension of the forests of the United States; its means are agitation and education; it seeks to encourage the application of forestry by private owners to forest holdings, large or small; and it favors, especially, the establishment and multiplication of National and State forests, to be administered in the highest interests of all.

The Association seeks as members all who sympathize with its object and methods, and who believe that our natural resources constitute a common heritage, to be used without abusing and administered for the common good. Seeking to conserve our supplies of wood and water, the Association appeals especially to wood-producers and users, including owners of wood lands, lumbermen, foresters, railroad men, and engineers; and to those dependent upon equable stream flow, as manufacturers, irrigators, employers of water power, and those engaged in internal commerce.

The Association meets annually in Washington. It publishes, monthly, **FORESTRY AND IRRIGATION**, the magazine of authority in its special field. The list of contributors to this publication includes practically all persons prominent in forest work in the United States, making it alone worth the cost of Annual Membership in the Association.

The dues, covering a subscription to **FORESTRY AND IRRIGATION**, are as follows: Annual—For Annual Members, \$2; for Sustaining Members, \$25; Total, with exemption from all other payments—for Life Members, \$100; for Patrons, \$1,000.

THOMAS ELMER WILL, Secretary.
Address: 1311 G Street, N. W., Washington, D. C.

FOR SALE

SET OF

SARGENT'S SILVA OF NORTH AMERICA

Fourteen volumes in original boxes. Cost \$350 net; offered at \$265 net. Also a number of books on FORESTRY and BOTANY. Address

W. W. ASHE

Forest Service Washington, D. C.

Philippine Bureau of Forestry

WANTED—Two foresters with field experience. Minimum salary \$1600. Travel expenses allowed, also liberal leave privileges.

At least seven months interesting field work per year.

For information concerning travel allowances to Manila, Civil Service rules, health conditions, in fact any information in regard to the Islands, apply to the **Bureau of Insular Affairs**, War Department, Washington, D. C.

Timber Tract for Sale

FOR SALE—Valuable tract of Spruce, Fir, Hemlock, and Cedar Timber, located in Washington State. 200,000,000 feet of standing timber; railroad, cars, engines, mills, kilns, tools, supplies, etc. Price, \$500,000; half cash. **FENWICK & SPEIDEL CO.**, Buffalo, N. Y.

HARVARD UNIVERSITY

The Graduate School of Applied Science and The Lawrence Scientific School

offer graduate and undergraduate courses in Civil, Mechanical, Electrical, Mining and Metallurgical Engineering, Architecture, Landscape Architecture, **Forestry**, Physics, Chemistry, Biology and Geology.

For further information, address **W.C. SABINE**, 15 University Hall, Cambridge, Mass.

Make Your Unproductive Land Profitable

Hundreds of acres too far away from the great irrigation canals can be made profitable at small expense. You can have running water in your house and at your barn. The only things necessary are a running stream or spring on any part of your ground and the installation of a

NIAGARA HYDRAULIC RAM

The U. S. Government is using this pump for irrigation purposes, because it does such good work. It's cheaper than a windmill or gasoline engine. Works continuously without cost. Send for booklet B, and guaranteed estimate. We furnish towers and tanks. **NIAGARA HYDRAULIC ENGINE CO.**, 140 Nassau St., New York. Factory, Chester, Pa.



Nominations for Membership

The activities of the National Office of the American Forestry Association are limited chiefly by its resources. These are derived almost wholly from its members in the form of dues. Every member is urged to aid in increasing the membership. Kindly fill out the enclosed blank form, lengthening the list, where possible, by attaching and filling blank sheet. The list should then be sent to

THOMAS E. WILL,

Secretary American Forestry Association,

1311 G Street, Northwest, Washington, D. C.

I hereby nominate the following persons for membership in The American Forestry Association:

Name

Address

.....

Signed.....

FORESTRY AND IRRIGATION

THOMAS ELMER WILL
WM. CANFIELD LEE

Editor
Associate Editor

CONTENTS FOR APRIL, 1908

CITY PARK AT MANHATTAN, KANSAS—AN EXAMPLE OF ARBOR DAY ACCOMPLISHMENT

Frontispiece

EDITORIAL

Our June Issue and the Conservation Conference	177
Status of the Appalachian Bill.....	177
Who is Blocking the Appalachian Bill	178
Pessimism vs. "Optimism".....	179
Demand Immediate Resurrection of the Bill	180
Political Platforms on Forestry, etc....	180
The Conference of Governors.....	180
First the Inland Waterways.....	181
All Sections and Interests	181
Meeting to Be Famous in History.....	182
For a Practical Working Basis.....	182
Some Vicious Bills.....	182
Designations of the Bills.....	183
Perpetual Privileges	183
Flooding	183
Competing with Government.....	184
The Secretary "Shall".....	184
Petty Payments	184
The Danger	185
A Concession	185
Another Message from the President..	185

Profits from Irrigated Land	188
Improvements in Methods of Irrigation	188
Drainage of Irrigated Lands.....	189
Irrigation of Australia.....	189
Reclaimed from Land Thief.....	189
Turks of the Ohio Valley.....	189
Silent Obstruction	190
The Political Advantage.....	190
Unanimity of Engineers' Opinion.....	191
Directors of Investing Corporations..	191
State Attention Needed.....	191
Will Not Break Up Farms.....	191
Los Angeles Resolutions.....	191
Help from Hawan.....	191
Kansas Farmers' Institutes.....	192
Colorado Short Course in Forestry...	192
University Lectures	192
Forestry at Winona Lake.....	192
Davis Industrial School Bill.....	192
Mrs. Voris Succeeds Mr. Bleecker...	193
Game Privileges Pay the Taxes.....	193
A State Association's Organ.....	193
Interesting the Lumbermen.....	193
Down with All the Trees.....	194
Forestry Association in Missouri.....	194
New York Purchases Mount Marcy...	194
Illinois State Tree and Flower.....	194
Pay Railroad for Good Work.....	194
Lecture on Appalachians.....	194
To Insure a Navigable Ohio.....	194
Kentucky Headed Right.....	195
Deforestation and Floods in Michigan	195
Uses of Excelsior.....	195

NEWS AND NOTES

Forest Planting on the Prairies.....	187
A Few Acres of Trees.....	187
Census of Water Transportation.....	187
Large Usefulness of Canals.....	188
More than 500 Miles Square.....	188

THE NAMES OF MAHOGANY. By Dr. John Gifford. (<i>Illustrated</i>)	196
TREASURER'S REPORT, AMERICAN FORESTRY ASSOCIATION	198
ARBOR DAY—THE AMERICAN SPRING FESTIVAL.	
By Wm. C. Lee. (<i>Illustrated</i>)	201
SHALL UNCLE SAM DRAIN THE SWAMPS? (<i>Illustrated</i>)	207
TREE PLANTING IN SCHOOL YARDS. By Louise Klein Miller (<i>Illustrated</i>)	211
CALIFORNIA IRRIGATION NEEDS FORESTS. By Lewis E. Aubury. (<i>Illustrated</i>)	212
CANADIAN FORESTRY ASSOCIATION MEETING	215
THE MOUNTAINS. (<i>Poem</i>). By Haven Charles Hurst	216
PROTECTION FOR AMERICAN INDUSTRY By Hon. A. F. Lever	217
THE KNELL OF THE FORESTS. (<i>Poem</i>). By George Klinge	220
THE WHOLESALE LUMBER DEALERS' CONVENTION.	
Reported by Mrs. Lydia Adams-Williams	221
U. S. FOREST SERVICE	224
THE GOVERNMENT'S HANDY MAN. (<i>Poem</i>).	226
U. S. RECLAMATION SERVICE	227
ONIONS AS IRRIGATORS	229
WITH MEMBERS AND CORRESPONDENTS	230
RECENT PUBLICATIONS	232

FORESTRY AND IRRIGATION is the official organ of the American Forestry Association. Price, \$2.00 per year, including Annual Membership in the Association. Copyright, 1908, by The American Forestry Association. Entered at the Postoffice at Washington, D. C., as second-class mail matter.

Published Monthly at
1311 G STREET, N.W. WASHINGTON, D. C.

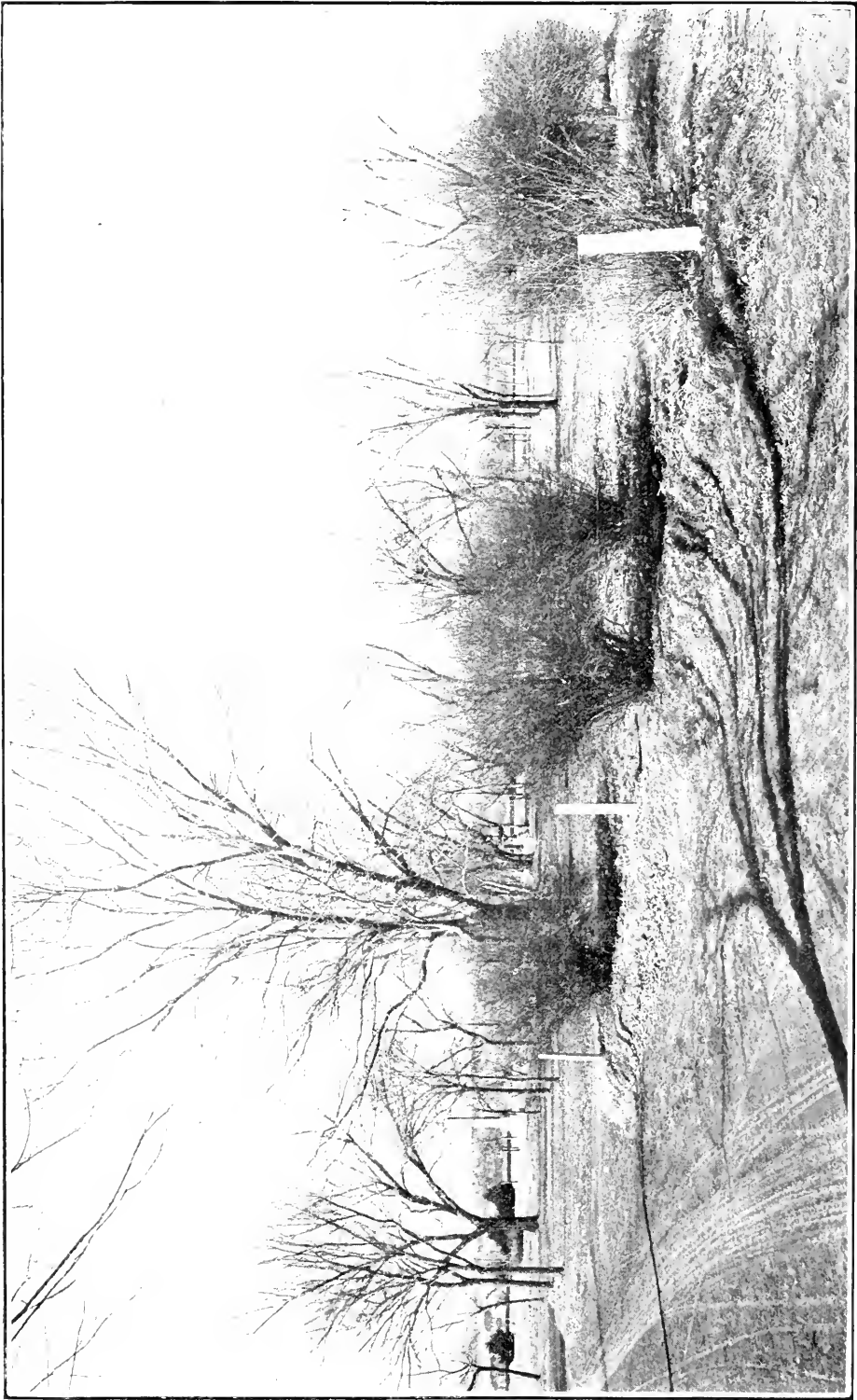

City park at Manhattan, Kansas—Trees planted by citizens—An excellent example of Arbor Day accomplishment

See page 201

FORESTRY AND IRRIGATION

VOL. XIV

APRIL, 1908

No. 4

EDITORIAL

Important Announce- ment

The Conservation Convention at the White House, May 13-15, discussed elsewhere in this issue, will be an epoch-making event. FORESTRY AND IRRIGATION desires to give its readers the full benefit of this meeting. Its June issue will be devoted to the proceedings of the Convention. Let every reader of this publication, and especially every member of the American Forestry Association, advertise this fact. Let him tell his friends. Let him put notices in his home papers. Let him have it announced at public meetings. Let him print dodgers and have them distributed. Let him proclaim in every possible way the coming of this great convention, and the fact that its story can be found in the June issue of this magazine.

FORESTRY AND IRRIGATION is fortunately placed with reference to this meeting. It is committed to this work. It is one of the few magazines published at the National Capital. Its office is within four blocks of the White House. On the Board and Magazine Committee of the American Forestry Association are members of the Inland Waterways Commission. It

will have every facility for securing materials. Its date of publication enables it to print this matter promptly. Members of organizations, industrial, commercial and philanthropic, that are interested in this great movement should see that their membership is supplied with copies. An organization having a treasury can, by vote, order copies by the hundred or the thousand for its membership. Other copies can be ordered to be distributed gratuitously for propaganda purposes. The country should be sown with the story of this great meeting

Single copies of FORESTRY AND IRRIGATION sell at 10 cents each. For large orders, substantial reductions in price can be made. This office, however, should be advised early of coming orders, that it may make proper preparation. Here is a field of activity for every member of the Association and for every friend of the movement.

Status of the the Appala- chian Bill

On January 30 the hearing on the Appalachian bill was had before the Committee on Agriculture of the House of Representatives. Then came the reference of the bill, through

the activity of Representative Charles Lafayette Bartlett, to the Committee on Judiciary of the House. A hearing on the constitutional features of the bill was had before that committee on February 27. In March it was announced that the Judiciary Committee would hold, on the 20th, an executive session to consider the question of the Appalachian bill. March 20 came, however, and passed, leaving the bill still slumbering in the committee pigeonhole, with no day announced for its consideration.

December, January, February and March have now almost worn away. A snowstorm of letters, telegrams, resolutions and petitions, begging, pleading and praying for, and demanding the passage of the Appalachian bill, has poured down upon Congress. A member writes the Secretary of the Association that these communications have come in "by the millions." The secretary of another Congressman, when asked whether members had received any communication from their constituents on this subject, replied: "Have they? Well, I should say so! They've been flooded with them."

Stand-pat-ism, however, still dominates Congress. Last year the session was "too short;" this year the Presidential election is coming on; next year a lot of members will probably have lost their seats, and the Sixtieth Congress will be waiting for its death knell to toll at high noon on March 4; hence nothing can be done then. And so it goes.

How long will a much-suffering people endure this travesty on popular government? Why do they elect Congressmen, pay them \$7,500 a year, and provide for them secretaries and palatial buildings in which to *work*? Why not provide, instead, tennis courts, bowling alleys, swimming pools, running tracks, "diamonds," "gridirons," gymnasiums and other paraphernalia for sports, and send them to Washington to *play*? It is not long since the President fired

a bombshell, in the shape of a special message, into Congress, with the hope of arousing it to action. How much action has followed? Will he try another. Says the *Atlanta Constitution*, "If the President sends in a second special message, as is now rumored, insisting on definite action toward materializing many of the recommendations in his message of last fall, it is to be hoped he will not overlook the forestry bill in his list of specifications."

Yes, this is to be hoped. But, meanwhile, let the friends of that measure redouble their efforts. Let them continue to pour in their letters, telegrams, resolutions, petitions and editorials, demanding the protection of their heritage. And let them make clear to members that if votes are wanted, the only way to get them is through the performance of plain duty.

Who Is Block- On the 20th, Mr. Henry ing the **Appa-** A. Barker, Chairman of lachian **Bill?** the special committee on National Forests of the American Civic Association, wrote Speaker Cannon a searching letter as to the attitude of the latter on the Appalachian Bill. The Speaker, as usual, disclaims responsibility and puts the matter up to the Committee on Agriculture, apparently forgetting that that committee is waiting on the Committee on Judiciary.

While answering questions, the Speaker might also state, (1) whether or not, as reported, he criticised the chairman of the Agricultural Committee of the 59th Congress for reporting the Appalachian Bill favorably; (2) whether, in organizing the Committee on Agriculture of the 60th Congress, he sought to injure the prospects of the Appalachian Bill; and (3) how the friends of forest conservation are to harmonize his remarks at the banquet of the National Wholesale Lumber Dealers' Association on the evening of March 12th with the theory that he can be expected to look with favor, or

even patience, upon such a measure as the Appalachian-White Mountain Bill.

The Secretary of the American Forestry Association has addressed a letter to Hon. John J. Jenkins, chairman of the House Committee on Judiciary, reminding him of his promise made at the hearing before that committee on February 27 that the measure would be promptly considered, and asking him when a report could be expected. The Chairman replies he cannot tell.

Pessimism A correspondent writes:
vs. "I do not believe any as-
"Optimism" sociation or individual can do anything toward the protection of the forests. They are bound to go, in this country, even down to the railroad ties and prop timbers. Assessments are so high that no one can afford to hold them to grow up into timber again. I have no sympathy with the movement at all."

Over against this should be put the speech made by Speaker Cannon before the National Wholesale Lumber Dealers' Association in Washington on the 12th.

Mr. Cannon declared himself to be "an optimist." He ridiculed the idea that our forests are facing destruction. He scorned the notion that special effort should be made to conserve our natural resources. He sneered at "men who make reputation in public life, in departmental life, in legislative life, by denouncing the criminal wastefulness touching the destruction of the forests." and added: "I sometimes hear them talk; I sometimes wonder how much they know."

He described his early pioneer life in Wabash County, Indiana, when it was necessary to clear the forests to provide land for farming; and then inquired: "Is there a man here * * * who would put us back to fifty years ago, when there was nothing but the wild beasts and the adventurous pioneer to be found in that vast domain known as the Northwest Territory, that would turn the hands back upon the dial fifty or sixty years ago?"

He exclaimed sarcastically: "What is to become of posterity? Oh, the natural resources are being destroyed! In forty or fifty years we are to freeze to death because there is no more coal and there will be no more lumber, no more timber. Burning the candle at both ends! I suppose we ought to freeze now, that fifty years from now they may have something to warm them." He expressed his faith that the Caucasian race would find some way to meet conditions which may arise, and declared that he was not "losing sleep."

In closing, he thought it "necessary" for lumbermen "to pursue a different policy toward the preservation of your holdings in the forest; that instead of cutting it clean, you should be more careful about the cutting." But added: "You will do it because it is to your interest to do it, and that is greater than anything else. It is greater than law."

Between the pessimism of our correspondent and the "optimism" of Speaker Cannon, the reader may take his choice. The chief difference between the two is that the latter is in the place of power. He sees no occasion for anxiety, and no ground for action by the community through its agency called government. For such slight corrections as may be necessary, he relies wholly upon cold-blooded self-interest and unregulated individual initiative. In so far as this speech is an index, his political economy is that of a hundred years ago, as voiced by David Ricardo: *Laissez faire*, each for himself, self-interest the grand automatic regulator of our whole industrial mechanism! Is it any wonder the Appalachian bill finds rocks in the channel through which it must travel?

"After us the deluge!"

"I suppose we ought to freeze now, that fifty years from now they may have something to warm them."

The world has not yet forgotten the speech of Louis XV. to Pompadour. Perhaps this speech of Speaker Cannon's may also prove historic.

**Demand
Immediate
Resurrection**

Speaking of the refer-
ence of a certain bill to
the House Committee on
Judiciary, and the uproar thereby cre-
ated in the House, the Washington
Times of March 27th, says:

"The House Judiciary Committee is
widely notorious as a grave-yard of
legislation sent to it—especially legis-
lation which is suspected of being 'pro-
gressive.' It is commonly supposed
that the committee is maintained for
this especial function."

Attention is called to the fact that
that committee now has the Littlefield
Liquor Bill, the Appalachian Forest
Reserve Bill, the Anti-Injunction Bill,
and the Employers' Liability Bill still
before it and doesn't seem to be mak-
ing much progress with any one of
them, and the question is raised as to
why it should now, at this late day, be
burdened down with other great ques-
tions.

Is this Judiciary Committee, not-
withstanding promises made of prompt
action, to be the "grave-yard" of the
Appalachian bill? Perhaps the friends
of this measure would like to say some-
thing on this subject themselves. Here
are the names of the Judiciary Com-
mittee: Messrs. John J. Jenkins, of
Wisconsin; Richard Wayne Parker,
of New Jersey; De Alva S. Alexander,
of New York; Charles E. Littlefield,
of Maine; Charles Q. Tirrell, of Mass-
achusetts; John A. Sterling, of Illi-
nois; John H. Foster, of Indiana;
Henry T. Bannon, of Ohio; Reuben
O. Moon, of Pennsylvania; Gerrit J.
Diekema, of Michigan; George R.
Malby, of New York; Henry S. Caul-
field, of Missouri; David A. De Ar-
mond, of Missouri; Henry D. Clayton,
of Alabama; Robert L. Henry, of
Texas; William G. Brantley, of Geor-
gia; Charles C. Reid, of Arkansas;
Edwin Y. Webb, of North Carolina.

Let the friends of the Appalachian
Bill arise to this occasion and inform
these statesmen that this measure shall
not be buried in the Judiciary or any
other committee without their earnest
protest.

**Political
Platforms on
Forestry, Etc.**

The Ohio Republican
platform of March 4,
1908, contains the fol-
lowing plank:

"Liberal appropriations for the im-
provement of waterways and harbors,
including the Ohio River and the
Great Lakes, in accordance with a
general plan which shall be compre-
hensive and just to all portions of the
country."

The Nebraska Democratic platform,
adopted on the following day, March
5, contains the following:

"We sympathize with the efforts
put forth for the reclamation of the
arid lands of the West and urge the
largest possible use of irrigation in the
development of the country. We also
favor the reclamation of swamp lands
upon the same principle.

"We favor the preservation of the
forests still remaining, and the re-
planting of the denuded districts in all
our mountain ranges, as well as the
forestation of the Western plains.

"We urge liberal appropriations for
the improvement and development of
the interior waterways, believing that
such expenditures will return a large
dividend in lessened cost of transpor-
tation."

Let all the friends of these great
questions, whatever their party affilia-
tions, urge their parties on to the adop-
tion of liberal platform declarations on
the questions of forestry, irrigation,
waterways, and conservation of re-
sources; and then let them see to it
that, when power is placed in the
hands of parties, platform pledges are
fulfilled.

**The
Conference
of Governors**

The consumption and
waste of our natural re-
sources is proceeding
apace. But whenever efforts have
been made to meet this situation, diffi-
culties have arisen from the facts that
the conditions of one community are
affected by the actions of another over
which it has no control; that the pre-
servation of one form of natural
wealth involves the protection of

others, and that none can be managed independently of others. Effective action has been blocked because there has been nobody broad enough to formulate a plan sufficiently comprehensive.

Such a body is now provided by the conference on the conservation of natural resources, which the President has called to meet him in the White House on May 13, 14 and 15. This conference will represent every part of the country, and all the country's needs. By direct personal contact, the members will be able to come to an understanding of the various inter-related problems and of what will be required of each part of the country to make a general scheme possible.

This conference will be the most remarkable in the historic mansion. It will deal with problems upon which the continued prosperity of the Nation vitally depends. For this reason its deliberations will be more fundamentally important and far-reaching than any since the days when the republic was planned. Never before have the chief executives of all the States met in one body presided over by the Chief Executive of the Nation, and never before has there been a subject bigger or broader to cause such a meeting.

The steps which led to the calling of this conference are particularly instructive in the way in which they emphasize the close inter-relation and interdependence of all the natural sources of the Nation's wealth, and the fact that any attempt to conserve one set will soon involve the protection of others.

First the Inland Waterways Last March, in response to petitions from numerous commercial bodies of the Mississippi Valley, President Roosevelt appointed the Inland Waterways Commission, to prepare and report a comprehensive plan for the improvement and control of the river systems of the United States. In the President's instructions to this Commission he said:

"Such a plan should consider and include all the uses to which streams may be put, and should bring together and co-ordinate the points of view of all users of water." And also: "It is not possible properly to frame so large a plan as this for the control of our rivers without taking account of the orderly development of other natural resources. Therefore, I ask that the Inland Waterways Commission shall consider the relations of the streams to the use of all the great permanent natural resources, and their conservation for the making and maintenance of prosperous homes."

All Sections and Interests In pursuance of these directions, the Commission soon came to the conclusion that the problem was so extensive and intricate that a conference representing all the interests concerned in all parts of the country ought to be called to formulate some broad basis of action. Upon their recommendation, therefore, the President issued invitations to the Governors of all the States and Territories to meet him to consider the possibilities of preserving the country's natural wealth, and to bring with them three representative citizens of their respective States. Practically every Governor has accepted the invitation, and many have announced the names of the three men who will accompany them. These men are, without exception, representatives of the ablest leaders of public opinion and public life in their communities.

Representatives of all national organizations dealing with natural resources or with practical questions relating to them have also been asked. The members of the President's Cabinet, the Supreme Court, the Inland Waterways Commission, and such members of Congress as can attend, will be present. Furthermore, the President has sent invitations to a number of well-known men who can assist either by their general counsel or by their special knowledge. Among

these are ex-President Grover Cleveland, William Jennings Bryan, Andrew Carnegie, who will be able to discuss the ore supply and lake traffic, James J. Hill, who is an authority on the relation of railroads and water navigation, and John Mitchell, who can contribute information on the coal situation and the labor aspects of the questions.

A Meeting to be Famous in History The President outlined the scope and purpose of the conference in his invitation to the Governors, published in FORESTRY AND IRRIGATION for December last, and emphasized the importance of the subject in the following words:

"There is no other question now before the Nation of equal gravity with the question of the conservation of our natural resources; and it is the plain duty of us who, for the moment, are responsible, to take inventory of the natural resources which have been handed down to us, to forecast the needs of the future, and so handle the great sources of our prosperity as not to destroy in advance all hope of the prosperity of our descendants. * * *

"Facts, which I cannot gainsay, force me to believe that conservation of our natural resources is the most weighty question now before the people of the United States. If this be so, the proposed conference, which is the first of its kind, will be among the most important gatherings in our history in its effect upon the welfare of all our people."

For a Practical Working Basis All the sessions of the conference will be held in the historic East Room of the White House, where so many other important scenes in American history have been enacted; and it is likely that President Roosevelt will not only open the conference, but will preside over all its deliberations.

It will be a conference in the truest sense of the word, with the single purpose of getting down to a practical working basis at once. To that end

there will be an absence of set papers, though in order to open the discussions, a few recognized authorities will present brief descriptions of existing facts and conditions. It is hoped that plans may be so formulated that there will be immediate and concerted action on the part of the different States toward the conservation of natural resources, the fundamentally vital problem, according to the President, before the people of the United States to-day.

Some Vicious Bills

In his waterways message of February 26 the President sounds the following warning note:

"Among these monopolies, as the report of the Commission points out, there is no other which threatens, or has ever threatened, such intolerable interference with the daily life of the people as the consolidation of companies controlling water power. I call your special attention to the attempt of the power corporations, through bills introduced at the present session, to escape from the possibility of government regulation in the interests of the people. These bills are intended to enable the corporations to take possession in perpetuity of National forest lands for the purposes of their business, where and as they please, wholly without compensation to the public. Yet the effect of granting such privileges, taken together with rights already acquired under State laws, would be to give away properties of enormous value. Through lack of foresight we have formed the habit of granting, without compensation, extremely valuable rights amounting to monopolies on navigable streams and on the public domain. The repurchase at great expense of water rights thus carelessly given away without return has already begun in the East, and before long will be necessary in the West also. No rights involving water power should be granted to any corporations in perpetuity, but only for

a length of time sufficient to allow them to conduct their business profitably. A reasonable charge should of course be made for valuable rights and privileges which they obtain from the National Government. The values for which this charge is made will ultimately, through the natural growth and orderly development of our population and industries, reach enormous amounts. A fair share of the increase should be safeguarded for the benefit of the people, from whose labor it springs. The proceeds thus secured, after the cost of administration and improvement has been met, should naturally be devoted to the development of our inland waterways."

Designations The bills to which, presumably, reference is above made are as follows, the letter following each number being introduced for convenience in reference in this editorial: H. R. 212 (A), H. R. 3907 (B), S. 435 (C), S. 2661 (D), H. R. 11356 (E), H. R. 12887 (F), S. 4060 (G), H. R. 17306 (H), S. 4179 (I).

Some or all of these bills would operate, if enacted, as modification of the Act of February 15, 1901 (31 Stat., 790). By this, the Secretary of the Interior is authorized and empowered to grant licenses within the National Forests, provided these be not incompatible with the public interest. Further, these licenses are revocable by the Secretary of the Interior (now, so far as the National Forests are concerned, the Secretary of Agriculture) in his discretion. Further, it is expressly provided that these licenses "shall not be held to confer any right, or easement, or interest in, to or over any public land, reservation or park."

These limitations are evidently irksome to certain great concerns desiring free access to the public property known as National Forests. Several of these bills grant easements and rights of way, as the following quotations show:

Perpetual Privileges

Bill A provides "that permanent easements and rights of way are hereby granted for the construction, use, maintenance and operation of roads and highways, canals, ditches, reservoirs, telephone and telegraph lines, and lines for the transmission of electric light and power within and through the various forest reserves." The bill further provides, it is true, that these easements and rights of way are granted "under such rules and regulations as the Secretary of Agriculture shall prescribe;" but it will be observed that, when granted, they are "permanent."

Bill B provides likewise for the granting of "rights of way through the public lands and reservations, excepting lands reserved for military or naval purposes or for National cemeteries."

Bill C grants "rights of way for the construction of highways over public lands and lands included in forest reserves, not otherwise reserved for public use." Bills D, E, F and G contain similar provisions. Bill D provides "that any of the persons or corporations referred to "may construct and maintain all necessary roads and trails over any of the lands referred to," though such roads and trails may also be used by the Government and the public. Bill E contains the same provision.

Flooding

Those who recall the attempt of certain companies to secure, by legislation, from the State of New York, at the last session of the legislature of that Commonwealth, the right to flood large areas of the Adirondacks, and the storm of protest raised thereby, will read with interest, in Bill B, that this measure carries with it "the right to submerge and flood such areas only as may be necessary to impound the water in such reservoirs." Bill D conveys "the right" to submerge and flood such areas as are shown and described upon

the maps filed, * * * "and as may be necessary to impound the water in such reservoirs." Bill E contains the same provision.

Competing With Government Bill F forbids the Interior Department "to prevent any corporation, person, association of persons or settlement or aggregation of people of the United States from competing for priority of right to use of the waters of any natural stream within any of the States and Territories of the arid region, with the Government of the United States, or with any other claimant." Bill G contains the same provision.

Both these bills graciously permit "that the Government of the United States shall have right to compete for priority of right to the use of the water for reclamation purposes in the arid States and Territories," with this proviso: "But shall not, either directly or indirectly, prevent the citizens of the United States from competing for prior rights to the use of waters in the arid region, nor retard them therein."

As against the provision of existing law "that any permission given by the Secretary of the Interior under the provisions of this Act may be revoked by him or his successor in his discretion," the following interesting provision appears in some of these new bills:

The Secretary "Shall" "And any existing right of way, license, permit or privilege for any of the purposes provided for in section 1 of this Act *shall*, upon application, be confirmed and approved by the Secretary of the Interior" (Bill B). Bill D, in prescribing that "any person, association or corporation desirous of securing the benefits of this act shall file * * * a map", adds "And if the application be in accordance with the terms of this act such map *shall* be approved by the Secretary of the Interior." The same Act also pro-

vides, "That any existing right of way, license, permit, or privilege for any of the purposes provided for in * * * this act *shall*, provided application therefor be made by the grantee or grantees, their successors or assigns, and only in that event, be approved by the Secretary of the Interior". Bill E contains the same provisions. Bill D grants the beneficiary "the right to take from the public lands adjacent to such works, materials, earth, and stone necessary for the construction and maintenance thereof." Bills E, F, and G contain the same provision; while Bill B, apparently, by typographical error, grants only "the right to take from the public lands and stone necessary," and so forth.

Petty Payments

It is true, however, that the bills contain provisions for partial payment for values received. Bill B, for example, provides, "That the grantee or grantees of any such right of way under this act shall pay to the United States the full value of all timber and wood cut, used, or destroyed within the right of way, in constructing and maintaining said works, including damages for injuries to the adjacent lands of the United States". Bill D contains a similar provision, as does Bill E.

Other modest payments are provided for, Bill B prescribing that "lands covered by structures, dams and reservoirs or the sites therefor," may be purchased by the grantee or grantees hereunder by the legal land subdivisions covering same, after the completion of such structures, dams and reservoirs, at the price of two dollars and fifty cents per acre." The same provision is found in bills D and E. Bill D further provides that the Secretary of the Interior may levy charges as follows: "for areas and sites for buildings and other structures, including reservoir sites, per acre of fraction thereof, one dollar; for rights of way," per mile of fraction thereof, one dollar." Bill E makes these fig-

ures two dollars and fifty cents.

Beside the values transferred by this legislation from public to private ownership, such payments are, of course, but as the crumbs which fell from Dives' table and were granted as charity to the beggar at his door.

The Danger

Thus far these bills have lain in committees. How long, however, they may thus slumber, no one, outside the leaders, probably knows. It is but necessary to focus public attention upon them to make the average congressman as shy of them as of the plums and prerequisites of which Mr. Dooley so effectively writes. Until, however, the appearance of the President's message above quoted the public knew little or nothing about these bills. Exactly there lies the danger in such legislation. It slumbers quietly in a pigeon hole until the opportune moment arrives, and then, with many members absent, others preoccupied, and still others lacking information, it goes through the chute with a lot of other legislation and is entered upon the statute books. Even now, there is a possibility that some of the more vicious clauses in these bills may be attached as riders to the agricultural appropriation bill, and thus forced through.

A Concession

It is conceded that the power of the Secretary to revoke licenses in his discretion might possibly, in hypothetical cases, work hardship. In the Agricultural Appropriation Bill, therefore, the following concession is made (page 24, lines 2-5): "Hereafter, permits for power plants within National forests may be made irrevocable except for breach of condition, for such term, not exceeding fifty years, as the Secretary of Agriculture may by regulation prescribe." It is hoped that every friend of the National Forests, whether within or without Congress, may be alert to see that the concessions to private interests go no further than this.

Another Message

The President has just sent another message to Congress. At the risk of delaying the presses, attention must be called to some of its features. He says:

"I am of the opinion, however, that one change in the tariff could, with advantage, be made forthwith. Our forests need every protection, and one method of protecting them would be to put upon the free list wood pulp, with a corresponding reduction upon paper made from wood pulp, when they come from any country that does not put an export duty upon them."

FORESTRY AND IRRIGATION delights to record this blow at the paper trust. While no tariff tinkering, or modification either up or down, will, without public ownership and administration, solve the forest question, the tariff upon wood pulp and paper made therefrom is an anomaly and abuse which should long since have been corrected.

The following regarding waterways will meet the full approval of our readers:

"Ample provision should be made for a permanent Waterways Commission, with whatever power is required to make it effective. The reasonable expectation of the people will not be met unless the Congress provides at this session for the beginning and prosecution of the actual work of waterways improvement and control."

For this Nation, at a time when its railroads cannot handle the traffic thrown upon them, to permit its vast network of inland waterways to lie idle is as preposterous as for China to leave her coal unmined. The sinister influences which have prevented the utilization of our inland waterways were made clear in the recent preliminary report of the Inland Waterways Commission and the presidential message accompanying it. Like American timberland owners in respect of wood pulp, railroad managers, of course, wanted no more competition than was inevitable. Hence, the Commission points out, they set themselves to kill

off their rivals, the waterways. But, with the failure of the railroads to do the business which they have thus monopolized, for the people of the country longer to put up with such a situation would reflect seriously upon their capacity for self-government.

That the President was not seriously influenced by the reactionary and astounding speech made by Speaker Cannon at the banquet of the National Wholesale Lumber Dealers' Association, elsewhere discussed, is shown by the following passage:

"The Congress should recognize in fullest fashion the fact that the subject of the conservation of our natural resources, with which this Commission deals, is literally vital for the future of the Nation."

Following our extended editorial on "Some Vicious Legislation," FORESTRY AND IRRIGATION hastens to chronicle the following additional executive declaration regarding these monopolistic bills:

"Numerous bills granting water-power rights on navigable streams have been introduced. None of them give the Government the right to make a reasonable charge for the valuable

privileges so granted, in spite of the fact that these water-power privileges are equivalent to many thousands of acres of the best coal lands for their production of power. Nor is any definite time limit set, as should always be done in such cases.

"I shall be obliged hereafter, in accordance with the policy stated in a recent message, to veto any water-power bill which does not provide for a time limit and for the right of the President or of the Secretary concerned to fix and collect such charge as he may find to be just and reasonable in each case."

The fact that the President would veto such legislation is reassuring, but for the fact, elsewhere suggested, that it may come in the shape of a rider upon the agricultural appropriation bill. It ought to be possible for an executive, Federal or State, to veto a portion of a bill without vetoing the whole. As law now stands, however, this is impossible for the President of the United States. It therefore behooves all friends of the forests to be on their guard against these power bills and to mark every Congressman who supports any one of them in any form.



See page 196

The mahogany as a shade tree

NEWS AND NOTES

Forest Planting on the Prairies—If the young farmers and the children of the older farmers in the prairie States are during the later years of their lives to be supplied with cheap fence posts and cheap fuel, whether there is a car shortage on the railroad or not, there must be a great deal more attention paid to forest planting on the farm than there has been heretofore.

There was considerable forest planting in these States in the early years of their settlement. The object then in view was not to secure post timber or building material or fuel, but to protect the farm houses and other buildings from the storms of the Western winter.

Times change, and farmers must change with them. The forest tree planting in the West, small as it appears to be in comparison with the acreage, has done much to modify the severity of the winters; more than any one would think.

What is needed now is timber for fence posts, for fuel and for lumber, as well as protection against the blizzards of the winter and the heat of the summer.—*Wallace's Farmer*.

A Few Acres of Trees—The importance of timber on the farm is becoming plainer each year. The uses and needs are many, and these increase as the farm becomes older. The one feature of fencing creates within itself almost a constant demand for timber for posts. Iron and stone are sometimes suggested as the coming fence post. This sounds as though the farmer was absolutely helpless in the matter of supply. The farmer need not look to any source outside his land resources for fence posts or fuel, if he decides that he will plan and produce these himself. The grove of quickly growing timbers will in a few years supply fence posts and fuel for all the needs

of the farm. It is simply a matter of planting and preparing for tree growth.

It does not require the lifetime of a man to do this and reap the benefits. True, it will take from ten to twenty years to see these trees satisfactorily serviceable, yet this time is often spent on a prairie homestead without any effort being made to plant, cultivate, or grow a tree.—*West Texas Journal*.

Census of Water Transportation—The Bureau of the Census has just issued a bulletin (No. 91) on transportation by water. The bulletin contains a summary of the main features of a census of transportation by water which covered the year ending December 31, 1906, further details of which are reserved for separate reports of the shipping on the Atlantic Coast and Gulf of Mexico, the Pacific Coast, the Great Lakes and St. Lawrence River, the Mississippi River and its tributaries, and all other inland waters, respectively.

During the year 1906, according to the census, ferryboats carried 330,737,639 passengers; over 63 per cent of whom were carried by the ferries in and around New York harbor.

By far the largest part of the American shipping is on the Atlantic Coast and the Gulf of Mexico. The next largest is on the Mississippi River and its tributaries; but so many of the river vessels are coal barges and scows, that the value of both shipping and freight moved on the Great Lakes is greater.

The total freight moved showed an increase of over 100 per cent from 1889 to 1906.

On the basis of tonnage moved, coal is the most important item of freight in the water commerce of the United States.

Considerable decreases are shown in the shipments of lumber and of ice.

The decrease in the former is due to the exhaustion of the forests near water courses; that in the latter, to the great increase in the use of manufactured ice.

One of the striking facts brought out by the report is the rapid increase in the use of iron and steel as materials for the construction of vessels.

Large Use-fulness of Canals In 1880 the amount of freight passing through the canals and canalized rivers of the United States was, in round numbers, 21,000,000 tons; in 1889, 49,000,000 tons; and in 1906, 122,000,000 tons, an increase of over 480 per cent between 1880 and 1906. This increase has resulted wholly from the increased use of Government canals, which are ship canals and canalized rivers; the use of canals under State and corporation control, largely of the smaller type, has steadily decreased.

In striking contrast to this great increase in the canal freight movement is the comparatively small increase in the length of the canals and canalized rivers.

The busiest canal in the world is the St. Mary's Falls canal connecting Lake Superior with Lake Huron. In 1906 the net tonnage of vessels passing through this canal was three times as great as that through the Suez canal and more than seven times as great as that through the Kaiser Wilhelm, or Kiel, canal. This is the more noteworthy since the St. Mary's Falls canal, on account of the severity of the cold, is open to traffic for only about eight months in the year, while the others are open twelve.

More Than 500 Miles Square Three hundred and sixty-three thousand acres of land, hitherto untilled or upon which the productiveness was limited, was put under water or included in irrigation projects in the Inland Empire in 1907. This does not include the acreage of the

projects at North Yakima, Lewiston, Sunnyside and others where the main ditches were dug before the beginning of last year; nor are the Twin Falls projects in Idaho, the Boise enterprises, the Jefferson Valley plan or the numerous plants in the Boundary country included in the total. These would make the acreage more than 700,000.

Profits from Irrigated Land Good wheat land in the Northwest may be depended upon, it is said, to produce an average of 25 bushels a year, and the grower may realize \$20 an acre gross profit out of his crop. Allowing only \$150 an acre for the value of the average irrigated land crop, it produces nearly eight times as much as the same area of wheat land, and is therefore worth as much to the city near which it lies. Hence the projects that will bring the equivalent of 64 square miles of wheat land near Spokane into cultivation opens a new empire that will easily support a population of 225,000 more than now live in the northwest. In revenue, allowing \$150 an acre for its annual productiveness, it will yield \$54,500,000 a year, or far more than the total value of the Inland Empire wheat crop in 1907, which is placed at \$37,500,000.

Since irrigation farming is so profitable, it would seem that even in humid areas it would pay to experiment with irrigation, to see whether having control of the moisture supply would not give an advantage to the farmer.

Improvements in Methods of Irrigation During the last five or six years the work done in the State of Washington by the irrigation investigations of the U. S. Office of Experiment Stations, especially in the Yakima valley, has thrown much light upon conditions existing in the irrigated districts and has pointed the way to betterment along many lines. In the improvement of canal construction, in the administration of canal systems, in the

methods of distribution of water and practices of irrigation, says a Washington writer, the State may look for many of its greatest possibilities of development by irrigation.

Drainage of Irrigated Lands One of the most important things in farm drainage in arid countries, says Professor Brown, drainage engineer of Colorado Agricultural College, is to know just when it becomes necessary. An excellent rule, adopted by Mr. Matthew Baer, manager of the Sommer Farm in Tremonton, Utah, is never to allow a wet spot to appear the second season. The experience on this farm is that wet spots, due to seepage, appear from year to year in different parts of the farm. By draining these spots as they appear, this farm continues to yield abundantly.

So much for wet spots which come this spring. Our immediate concern, however, is those wet spots which came last year and the year before. It is not hard to tell even now where those wet spots are. They fail to dry even when the wind blows for days, and when the surface generally is dry enough to plow. They needed very little irrigation, if any, last season.

When indications of such sort as these exist, it is time to go exploring below the surface. It is surprising how few farmers ever think of digging a few holes in the ground even when confronted with most certain indications of seepage and waterlogging. Besides showing how thoroughly the soil is saturated, test holes will reveal just what difficulties will be encountered if draining is attempted.

Irrigation of Australia Talk about the romance of engineering! Here are hundreds of thousands of square miles, formerly the despair and terror of Government and farmer alike, magically "struck," as Moses struck the rock, and forthwith turned into smiling fields of grain, and

far stretching stock farms capable of raising rams worth five thousand dollars each! So writes William George in the *Technical World Magazine*. Truly the "dead heart" of Australia is being slowly quickened into life by the waterwizard's derrick and his boring pipes, that are miles deep. A wonderful victory of mind over matter, such as enables the Commonwealth of Australia to produce fine wool alone worth nearly eighty million dollars a year! —*The Great West*.

Reclaimed From Land Thief H. H. Yard, who has operated most extensively in Government lands in Butte and Plumas counties, California, seeking to obtain public domain in those sections, has lost his fight for the possession of about 265,000 acres along the Feather River. The land office at Susanville has rendered a decision and report setting forth that in more than ninety claims there is no evidence of mineral. The lands taken by Yard revert to the Government as timber lands.

The decision is causing much excitement in Butte and Plumas counties, where similar large tracts are endangered.

The outcome of the controversy is a great victory for State Mineralogist L. E. Aubury, who has for years waged a bitter fight against individuals and corporations who took up timber lands under the Mineral and Placer Land Act. Aubury began this contest in 1901 and took the case directly to the President of the United States.

Mr. Aubury says his action is in the interests of the miners of California, who are shut out by these land grabbers.

Turks of the Ohio Valley The *Milwaukee Journal* says that "Kismet" is a Turkish word used to stupefy the will, as opium and hashish stupefy the body and mind. "When evils come upon the Turk he bows his head and mutters 'Kismet! It is Fate!'"

"Every winter and spring the people of the Ohio valley suffer the most destructive of floods, and they bow their heads and mutter their equivalent for Kismet. They think it fate.

"But it isn't. The floods are our fault. The science that prevents yellow fever and is conquering the white plague knows the remedy for the Ohio floods."

The financial loss and the deaths from pneumonia, says the *Journal*, are due to an ill as surely curable as the toothache. The U. S. Geological Survey has laid out a system of reservoirs which can be installed if the Appalachian National Forests are established.

"These reservoirs would hold back the flood waters and let them out in the dry seasons.

"The whole system of forests and reservoirs might cost the Government \$100,000,000. A single flood has done damage to that amount. During the recent flood, while the people of the Ohio valley were suffering untold privations and losses, Congress was busy—doing what? Considering the Appalachian forest bill? Oh, no! That useful body was getting up the campaign books for 1908. So much more important than flood prevention!

"And then it had to put the motto back on the coin.

"The projected reservoirs on the Ohio headwaters would take 402,000,000 gallons out of the floods. This would, by letting it out through gates, give the Ohio twelve feet of water through the dry season, clear to Pittsburgh. Low water is as curable as flood. Cure the one and you cure the other. And in damming back this water, the Government would create more power on the Monongahela and Great Kanawha alone, than is to be got out of Niagara, without spoiling the falls—nearly 400,000 horsepower, and capable of being raised to more than 1,000,000.

"The power would make the project a paying one. The forest would pay alone. Deep water in the Ohio would amply pay the whole cost. The

prevention of floods would pay it every year.

"How would it do for Congress to let up on playing politics for a while and take up the real practical problems of this wonderful age?"

"The Ohio Valley should know the answer?"

"Silent Obstruction"

Speaking of the Appalachian bill, the *Providence Journal* of March 14 suggests that Speaker Cannon may like "to play the public buildings bill" against the Appalachian bill, and continues:

"As between the pork barrel and the Appalachians, the former makes the more direct appeal to many Congressmen. Despite such ineffable considerations, it is difficult to see how Congress will be able to save its face if it rejects this important measure, or even permits it to slumber in committee. Silent obstruction may prove effective for the time being, but the obstructionists will need be deaf as well if they expect to escape the righteous indignation of the advocates of the measure and the important public interests which these represent."

The Political Advantage

The pressure from both North and South is so great upon Congress for the passage of the imperatively needed act that it can be defeated only by extraordinary means. That all the members of that body have not made haste to endorse the measure and secure all the political benefits of such a popular stand is astonishing.

If Congress intends to strangle the measure in secret, what is the motive? And whatever the motive, how can it be sufficiently strong to overcome the determination of the people of at least twenty-two States that it shall pass?—*Providence Bulletin*.

But a year has witnessed a remarkable change in the presence of public opinion. Uncle Joe now is almost ready to acknowledge this fact. "I really begin to believe that the people

of New England want this bill passed," he remarked recently to a friend of the cause.—*New Haven Journal-Courier*.

Unanimity of Engineers' Opinion The Board of Directors of the American Institute of Electrical Engineers are urging protection of the headwaters of important streams by scientific forestry, for the sake of preserving the stream flow on which water powers depend. The committee which recommended this action by the board asserted that:

"The really vital point at issue is the recognition or denial of the fundamental economic and engineering principles upon which forest reserves are based. On this question there can be no difference of opinion among engineers."

Directors of Investing Corporations The committee further states: "It is of the utmost importance that directors of corporations and other persons interested in hydroelectric developments should realize how great the ultimate effect upon the value of their properties will be if the forests which now protect their water supplies are destroyed, and that they should know that their advantage demands that regularity of stream flow be ensured through forest reserves and through the enforcement and improvement of the laws for the control of forest fires. Consulting engineers are urged to bring this matter to the attention of their clients with especial emphasis at the present time, when our National policy is being determined."

State Attention Needed The *Engineering Magazine*, referring to the electrical engineers' action, emphasizes the *immediateness* of the danger and of the requirement for action. "It is not a remote danger, but a present and progressive damage, with which we have to deal. The Ohio Valley is having bitter demonstration, and about the upper watersheds of the

Delaware, the Hudson and the Connecticut, destruction productive of like disaster is already under way.

"The cutter of timber feels no concern as to the aftermath, and those who do have no power of control and no redress. Beyond this Federal legislation and protection there would seem to be a crying need for a strong State forest law which would prohibit and prevent the absolute denudation now carried on, and enforce the preservation of sufficient cover, if not actually provide for reforestation."

Will Not Break Up Farms Persons opposing the Appalachian Bill in North Carolina for local political reasons have instilled into the minds of some of the mountain people that the Government proposes to take their lands for a mere pittance and drive them from their homes. This is altogether a misrepresentation. State Geologist Pratt has issued an explanation to allay these fears. It is not proposed to break up any farms at all, but to preserve the forests already standing and provide for reproduction of timber on cut-over lands.

Los Angeles Resolutions From the Pacific Coast, as from other sections of the country, comes the demand for the Appalachian National Forests. The Los Angeles Chamber of Commerce, after referring to its past record in promoting forest reserves and protection of watersheds in California, expresses its sense of vital importance of the National Forests in the Southern Appalachian and White Mountains, and commends the same to the support of the Los Angeles representative in Congress.

Help from Hawaii Even far away Hawaii is championing the Appalachian Bill. The *Pacific Commercial Advertiser* (Honolulu) of March, urges the Territorial delegate to do whatever falls in his

way to aid the Appalachian bill and any other legitimate measure of the same kind. "Broadly speaking," says the *Commercial Advertiser*, "it is a question of first economic importance to the Nation," and points out that, by deferring the timber famine, it will also help Hawaii. In addition, such an acquisition would be, it concludes, of first importance to the country at large. Would that some statesmen nearer home were as clear sighted as this Hawaiian editor!

**Kansas
Farmers'
Institute**

The Kansas State Agricultural College, at Manhattan, has engaged C. A. Kupfer of the U. S. Forest Service, for several weeks, to talk to farmers' institutes in western Kansas. This is in addition to the institute work done by the two professors of horticulture and forestry.

The college has recently issued a practical pamphlet on "Tree Culture," sending it to all the rural district teachers of the State and to all members of farmers' institutes. It will be sent free to anyone on application to the Superintendent of Farmers' Institutes, Kansas State Agricultural College, Manhattan, Kansas.

Another pamphlet of the same sort issued by the college, especially for teachers, is entitled "Bird Life."

**Short
Course
In Forestry**

A Short Course in Forestry is being held at the Colorado Agricultural College, at Fort Collins, commencing Monday, March 16, 1908, and continuing for four weeks. The course is under the direction of Mr. F. W. Morrell, of the Inspector's Office, District No. 2, U. S. Forest Service, assisted by members of the faculty of the Agricultural College and by others from the Forest Service.

**University
Lectures**

At the State University of Wisconsin, 185 students are taking a lecture course given by Mr. E. M. Griffith, the State Forester. Some students

may take this because they think they will have in it an easy study, but apparently the main reason is the increased interest in forestry prevailing in Wisconsin, as in other parts of the Union.

At the University of Nebraska, Mr. Raphael Zon, chief of the Office of Silvics, in the Forest Service, has been giving a series of lectures on forest types, problems, and conditions. Mr. Zon's alma mater is the University of St. Petersburg, Russia.

**Forestry at
Winona
Lake**

Mr. W. R. Eastman, until recently connected with the Maryland Agricultural College, has gone to be professor of forestry at the Winona Agricultural Institute, at Winona Lake, Indiana.

**Industrial
School
Bill**

Congressman C. R. Davis, of Minnesota, feels greatly encouraged concerning the passage, in the near future, of his industrial high school bill. It has received numerous endorsements from leading American educators, has been the object of favorable resolutions from educational organizations, farmers' associations, State colleges, commercial organizations, boards of trade, manufacturers' organizations, and industrial organizations generally throughout the country. President Roosevelt is strongly for this bill. It is in line with his Keokuk speech of October last, in which he said:

"We should strive in every way to aid in the education of the farmer for the farm, and should shape our school system with this end in view; and so vitally important is this that, in my opinion, the Federal government should co-operate with the State governments to secure the needed change and improvement in our schools. At present there is a gap between our primary schools in country and city which must be closed, and, if necessary, the Nation must help the State to close it. Too often our present

schools tend to put altogether too great a premium upon mere literary education, and therefore to train away from the farm and shop. We should reverse this process."

In reply to the objection that National appropriations for these schools would relieve the States from the sense of responsibility, Congressman Davis quotes a letter from Hon. Elmer Ellsworth Brown, U. S. Commissioner of Education, showing that, between 1896 and 1906 the amount which the land grant colleges received from their several States was increased from \$2,218,100 to \$7,531,502, an increase of about 240 per cent. In 1896 these institutions received 29 per cent. of their support from the Nation; in 1906 they received but 15.4 per cent. therefrom.

The Davis bill bridges the gap between the education of the school-house and that of the home, farm and shop. It is a far-reaching and beneficent measure.

Mrs. Voris Succeeds Mr. Bleecker The Paducah, Ky., *Sun* of February 20th published the following news item:

"Mrs. Robert Becker Phillips, of the State Federation Forestry Committee, has appointed Mrs. Victor Voris president of the local forestry association, to take the place of Mr. John S. Bleecker, who will leave the first of March to make his home in Columbus, Georgia. Mrs. Phillips, by right of her place on the Federation committee, has the appointment as chairman ex-officio.

"The choice of Mrs. Voris is a very happy one. She is not only deeply interested in the work of the forestry preservation, but her talents, versatility, and charming tact combine to make her an especially capable presiding officer."

Mr. Bleecker's energy, intelligence, and earnestness in the forestry cause will be missed in Paducah, but the loss of that city will be the gain of Columbus, Georgia.

Game Privileges Pay the Taxes

The Hampden Forestry Association, which has been formed to acquire white pine and other timber tracts in Massachusetts and Connecticut and hold same for proper management of the timber and for enhancement of timber values, have solved for themselves the problem of taxation, which might otherwise stand in the way of their holding timber lands. They are leasing the privileges of hunting and fishing in their forest to men who will stock the preserves with game and pay a rental practically equal to the taxes.

This is but a small expense for the sportsmen, and it enables the forestry association to get the benefit of the growth of the timber. Inasmuch as wild lands are becoming scarcer and game preservation more difficult, this policy may be helpful for other parties who desire to establish commercial forests.

A State Association's Organ

Prof. A. W. Nolan, secretary of the newly organized West Virginia Forestry Association, writes that that Association has decided to make FORESTRY AND IRRIGATION its organ. FORESTRY AND IRRIGATION respectfully suggests to other forestry associations, not provided with publications of their own, the adoption of the West Virginia plan. They can thereby save themselves the burden of publishing an organ, and can keep in touch with the general, nation-wide movement. This publication will also gladly give reasonable space to news matter, announcements and other communications which may be of special interest to state and local organizations.

Interesting the Lumbermen

The American Forestry Association is doing a good work both in agitating the matter of protecting the forests which we now have, and in encouraging the growth of timber by

cultivation. The effort of the association has had the effect of interesting the lumbermen and they are acting in conjunction with others in preventing forest destruction.—*Beatrice* (Neb.) *Sun*.

Down With All the Trees This motto, says the *Kansas City Star*, belongs to the past. The organization of a club or association in St. Louis, recently, to encourage the practice of forestry, shows that lumbermen realize how serious is the situation with respect to a future timber supply. The outlook in southern Missouri, some of the largest timber land owners say, is most discouraging; so bad, indeed, that the State's production will continue now annually to show a very large decrease. Many mills have been abandoned entirely because the woods have been "stripped."

The St. Louis organization includes some of Kansas City's big lumbermen. These are men who know something of the history of timber supply, and realize that the old answer, "We'll go somewhere else when these woods play out," won't do now. Lumbermen know that "somewhere else" either is being stripped or will be protected by forestry rules.

New York Purchases Mount Marcy Mount Marcy and its surrounding peaks are included in a purchase of a tract of 3,500 acres of land in the Adirondacks which the New York State Forest Preserve Board has just secured. The tract is heavily timbered and but for the State's action in stepping in at this time the lumber would have been cut off for pulp.

The Hudson river has its source in the wooded slopes of Marcy. Mount Marcy and the wooded tracts adjoining are included in one of the few parcels of land in the State in which the woodman's axe has never been swung, the forests being in their primitive state.—*Albany Argus*.

State Tree and Flower

The Legislature of Illinois has passed an act declaring the native oak tree to be the State tree of Illinois, and the native violet the State flower.

Pay Railroad for Good Work

The President has urged prompt action on the Southern Pacific Railroad's claim of \$1,600,000 expended in controlling the Colorado River in southern California. That work was performed by the Southern Pacific as the result of a personal letter of appeal sent to President E. H. Harriman by President Roosevelt. It cost, according to the railroad company, more than \$3,000,000, and saved the Imperial Valley of California from inundation and its crops and farms from ruin. Part of the expense they hold belongs to the Government.

Lecture on Appalachians

The North Carolina Society of New York at its annual dinner recently had as a feature of the evening an address by Mr. William L. Hall, in charge of the Appalachian investigation, with stereopticon pictures.

To Insure a Navigable Ohio

The Indianapolis *News* of March 19 discusses this topic editorially, strongly advocating the adoption of measures which will insure this important end. It continues:

"A question has been raised in some quarters as to the constitutional power of Congress to establish National forest reservations for such a purpose. This is a mere quibble. If Congress may establish reservations of public lands, as it has done repeatedly, it may do so by purchasing lands. The power is clearly covered by the power of Congress to promote the general welfare. It has as much right to improve the navigation of the Ohio and its tributaries by establishing a National forest reserve at their headwaters as it has by dredging their beds or building locks."

**Kentucky
Headed
Right**

Kentucky is making good progress in the movement for the preservation of the forests of the State. In 1906 the Legislature enacted the law providing for the State Board of Agriculture, Forestry and Immigration. During the following winter the Board asked and received the co-operation of the United States Forest Service in a study of the forest conditions of the state. The work was begun last summer and the investigations of a considerable area of land in the eastern part of the State completed. At the third annual meeting of the Kentucky Farmers' Institute, at Frankfort, in February, the subject of forestry was discussed with an interest which promises for Kentucky a high place among the other progressive states which are looking to the careful use and conservation of forest resources.

The manner in which the forestry problem has been approached indicates that the people of Kentucky realize that the ultimate solution of the impending timber scarcity must, for the farmer, depend largely on how he handles his individual timber resources, and that there is no better way than for him to consider the woodlot as a bank account, using the interest which is constantly accruing, but leaving the capital undiminished. Much education work, however, will be needed to secure this desirable end.

A bill has been introduced in the legislature providing for the appointment of a State Forester.

**Deforestation
and Floods
in Michigan**

Replying to an inquiry, Mr. C. F. Schneider, section director of the Climatological Service of the Weather Bureau, at Grand Rapids, Michigan, writing February 24, says:

"Regarding the connection between deforestation and floods in Grand River, my experience along this line confirms the oft repeated claims of the friends of reforestation—that the cutting down of trees destroys one of

Nature's savings banks. Not only do the deforested slopes of the Grand River shed the heavy rains of the summer very quickly, but they yield up all the water content of the winter's snow in a remarkably short time when the warm sun and warm rains of spring come on. The rapid congestion of the water into creeks and rivers is also forwarded by the extensive network of county drains, farm drains and tilled land."

Speaking of rivers in the same section, the Huron and Raisin, the U. S. Geological Survey bulletin says: "The location of the cities and nearly all of the villages on the banks of streams was determined by the water power they afforded for grist mills and saw-mills." This suggests a similarity of conditions in Michigan and New England, and a corresponding interest in forest conservation.

**Uses of
Excelsior**

Excelsior seems to the average man a trifling product that cannot represent a large consumption of timber, yet there are so many uses for it that the total annual production for this country requires sixty million feet of timber.

Besides the constant use in general packing, excelsior is in demand by upholsterers of furniture and carriages, by mattress makers occasionally, for stable bedding, and by steamships to filter sea water. A richly upholstered chair and a mattress which a customer fondly supposes to be filled with hair may contain nothing but excelsior beneath, with possibly a layer of cotton. Thus, we sit and sleep on wood as well as read wood pulp newspapers, and at the mortal end of things we are likely to repose in a coffin upholstered with a choice grade of excelsior. The New York mattress factory uses a carload a day. Teddy bears owe their rotundity to a special quality of fine excelsior.

There is not much wood left on ten thousand acres of land when the excelsior machines have had their year's rations.—*N. Y. Tribune.*

THE NAMES OF MAHOGANY

BY

Dr. John Gifford, Founder and Former Editor of this Magazine

THE TERM "mahogany" is applied to several woods which are in no way related to the genuine article, and to several woods which are closely akin to it and resemble it in many ways.

The scientific name is *Swietenia mahagoni* Jacq. The genus *Swietenia* was named for a Holland doctor by the name of Swieten, and the specific name *mahagoni* is merely another form of the common name mahogany, which had its origin in the old American Indian name of the tree. The French for mahogany is *mahagoni*, and since the botanist who named it was a Frenchman, this accounts for the use of the letter *a* in the second syllable of the specific name, instead of *o* as in our English word mahogany.

For the benefit of those not familiar with botany it is proper to explain that every known plant has an official scientific name. Each plant has a generic or family name, followed by a specific or individual name. These scientific names are often of interest in themselves, in that they perpetuate the common or local name, or the name of some person directly or indirectly associated with the plant, or indicate a region in which it grows, some striking feature in connection with it, or even some error in reference to it. As an illustration of the last, the term "fiddlewood" in the English tropics is of interest. The scientific generic name is *Citharexylum*, a translation of fiddlewood. The wood, however, is absolutely unfit for violins, and has never been used for that purpose. The term "fiddle" in this case is merely a corruption of the French *fidèle*, meaning true or strong.

Khaya senegalensis is the name of the African mahogany. *Khaya* is the

common native African name of the tree, and *senegalensis* means that it comes from the region of the Senegal. One of the Indian mahoganies is *Soyimida febrifuga*, *Soyimida* being a native name and *febrifuga* indicating that the parts of the tree are useful in combatting fever.

With the foreign species of mahogany the writer is not familiar, although the African mahogany is a common wood of commerce. He knows only of the genus *Swietenia*, and of this genus only one species *mahagoni*, although there may be other species in tropical America. Our mahogany varies considerably in character in the various regions in which it occurs, but these differences are probably due to the great variety of conditions under which it grows and are not sufficiently marked and fixed to warrant the formation of a greater number of species. The seed of the Bahaman mahogany, if planted in the lowlands of Honduras and Mexico, would no doubt produce a tree indistinguishable from that of its native neighbors, and *vice versa*. There is great variation in the quality of a wood, due to its location.

The tendency of botanists to name new species on insufficient grounds is unfortunate and unscientific, and merely litters our vocabulary with a lot of useless names, and renders more confusing a subject already much confused. It is almost impossible for the practical man to keep track of these changes in the obscure literature in which they are often published. Even then, if he knows of such changes he is suspicious of the standing of the author and the grounds on which these changes are founded. A scientific name is worse than useless, unless it is universally accepted and used.

The name mahogany is a magic word. It stands for excellence, so that if a dealer can affix it to a pile of lumber he can drive a better bargain with an ignorant buyer. And this in spite of the fact that ordinary mahogany is not an expensive wood. The price of mahogany varies from eight to twelve cents per foot in the log in the New York market. I know of one instance in which a dealer sold some bilsted, or sweet gum, under the name of "mountain mahogany." The buyer was well pleased, thinking his house was finished in a rare and beautiful wood. In the Philippines there is a wood called the red cedar, or toon. It produces a wood something like mahogany, and is sometimes called "Indian mahogany." In a store in Washington, D. C., I saw furniture labeled "toon mahogany." It was a wood quite as beautiful and even more valuable than some mahogany. The use of the word mahogany in its name helped to sell it.

The term "mahogany" is applied to woods which resemble it so faintly that it is hard to imagine how and when they were named. The Kentucky coffee tree (*Gymnocladus dioica*) is called mahogany in New York and Pennsylvania. *Rhus integrifolia*, the western sumac, is called mahogany. The red bay (*Persia borbonia*) is often called "Florida mahogany," while the true mahogany which is common in the southernmost part of the State of Florida is known as Madeira or redwood.

In Australia there is a species of eucalyptus (*E. resinifera*) called "red mahogany," and the term "mahogany gum" is sometimes applied to the famous jarrah (*E. marginata*). It seems most incongruous to combine the words mahogany and gum, since these timbers are usually the opposite in character, although jarrah may possess some qualities of both, and thus warrant this apparent misnomer. Nothing is more characteristic of mahogany than its color; yet there are woods known as "white mahogany."

Two species of eucalyptus are sometimes called "white mahogany," also a West Indian tree (*Antirrhoea bifurcata*). There is a wood sometimes called "horseflesh mahogany," or just horseflesh or sabicu.

And so on—in the great American tropics there is a tangle of tree names equal to the forest itself. There are Spanish, English, Portuguese, French, Dutch, and Danish colonies in the American tropics. These have all tried to interpret the Indian names of many plants, or have invented new names. There are many Indian tribes, and therefore many Indian tree names. Add to this the negro, who is famous for corrupting names, and the Japanese, Chinese, and Hindus, who have brought their languages into the mix-up, and it is easy to understand how the common name of a tree is of use only in a very restricted area. The negroes of Dutch Guiana, for instance, speak Taki-Taki, which is a combination of English, Dutch, Spanish, Portuguese, French, African, and what-not. One hopes, therefore, that some day an official international congress may be formed to settle one scientific name and one common name on at least all the important commercial plants of the world.

In the great order Meliaceæ, to which the mahogany belongs, there are several genera and many species yielding some of the most valuable and best known woods of commerce, while many others yet to be tried and developed. There is the famous cigar-box cedar (*Cedrela odorata*), logs of which are usually worth more than mahogany; there is the quaraguo (*Guarea trichilioides* L.) of Porto Rico; there is the acajou wood (*Cedrela fissiles* or *braziliensis*) of South America; and many others of the cedar type. The term "cedar" is here used merely to indicate that the wood is light and often has a cedary aroma. The trees in foliage and habit of growth look like walnuts. The term *Cedrela* applied to this genus is a combination of two Greek words, one

meaning cedar and the other the silver fir.

A specimen of the acajou (*Cedrela fissiles*), mentioned above, is growing with remarkable rapidity in Dr. F. Franceschi's garden in Santa Barbara, California. Much credit is due this distinguished gentleman, who has introduced many valuable exotics into California.

Owing to the fact that the Cedrelas mentioned above are such fine woods, of quick growth, and in general as valuable on the market as mahogany, it would be wise to plant these trees also. One objection to mahogany is that, in comparison with these cedrelas, it grows slowly. Dark wood of these cedrelas might be easily confounded with light form of mahogany. The Cuban cedrela has one quality which mahogany does not possess, fragrance of the wood, which presumably protects cigars from insect invasion.

Throughout Spanish America mahogany is usually known by its Spanish name *Caoba*. Baywood was an old English name for this wood, because it came in the early days mainly from

the Bay Islands in the Gulf of Honduras. Of all the names in common use the term mahogany is probably more familiar than any other. In fact, the Century Dictionary is authority for the verb "mahoganize," to cause to resemble mahogany, as by staining.

I know of one instance in which an engineer was forbid to cut mahogany. He could use all other woods on the land for ties and bridges, but no mahogany. The natives knew nothing of the wood mahogany, but recommended caoba strongly for the work. He proceeded to cut caoba, and up to the time of his removal did not know that caoba and mahogany were one and the same.

The term acajou is applied to mahogany, although it belongs properly only to *Cedrela fissiles*, mentioned above. It is claimed by some that the terms acajou and caoba had a common origin. The French is *acajou*, Portuguese *acaju*, Spanish *acayoiba*, *caoba* and *caobana*. It is said also that the French acajou, applied to the cashew tree of South Europe, is an entirely different word, which has become confused with it.

AMERICAN FORESTRY ASSOCIATION

TREASURER'S REPORT

WASHINGTON, D. C., *January 29, 1908.*

THE BOARD OF DIRECTORS,

THE AMERICAN FORESTRY ASSOCIATION.

GENTLEMEN:

I have the honor to submit herewith my report as Treasurer of your Association for the year ended December 31, 1907, including two exhibits, to wit:

STATEMENT OF ASSETS AND
LIABILITIES

As at December 31, 1907.

EXHIBIT "A"

REVENUE ACCOUNT

For the year ended Dec. 31, '07.

EXHIBIT "B"

For your enlightenment I beg leave to refer briefly to the more important items of the Balance Sheet.

BOND INVESTMENTS, \$6,162.80.

The bonds owned by the Association are carried on the books at the purchase price.

DUES OUTSTANDING, \$790.90.

Of this amount some dues have been paid since the closing of the books. It is estimated over one-half of the amount outstanding will be collected.

SUNDRY ACCOUNTS RECEIVABLE,
\$175.00.

Since the closing of the books the money advanced to the Secretary on account of traveling expenses has been returned.

ADVANCE TO F. & I. DEPARTMENT,
\$2,000.00.

Early in the year 1907 the Association purchased the magazine FORESTRY AND IRRIGATION, the price being \$1,650.00. The sum of \$500.00 was advanced as working capital—making a total investment of \$2,150.00. Of this amount \$150.00 were refunded during the year, leaving the balance on this account as above.

FURNITURE & FIXTURES, \$449.90.

This amount remains the same as last year.

ADVANCE ON POSTAGE, 1908, \$212.40.

This is an expenditure made during 1907, but properly chargeable against the year 1908, being the cost of stamped envelopes for Treasurer's bills, 1908.

BILLS PAYABLE, \$2,000.00.

This is a demand loan for which three of the bonds owned by the Association have been put up as collateral. The loan was authorized by the Board of Directors to provide funds for current expenses.

EXHIBIT "A"

BALANCE SHEET

As at December 31st, 1907

ASSETS.			LIABILITIES.		
CASH IN BANK Dec. 31, 1907.....	\$.....	\$ 195 04	BILLS PAYABLE:		
BOND INVESTMENTS (purchase price)			Demand Loan, Union		
2 Chicago & Eastern			Savings Bank.....	\$.....	\$2,000 00
Illinois 5's.....	2,305 00		ACCOUNTS PAYABLE:		
2 Minneapolis & St.			Security Storage Co..	1 00	
Louis 4's	1,982 50		F. & I. Dept. Over-		
2 Japanese Imperials			payment of Advance	4 00	
4½'s.....	1,875 30		Educational Fund.....		5 00
DUES OUTSTANDING		6,162 80			194 00
Annual.....	665 90		DUES UNEARNED:		
Sustaining.....	125 00		Annual Dues.....	846 00	
SUNDRY ACCOUNTS RE-		790 90	Sustaining Dues.....	125 00	971 00
CEIVABLE:			SURPLUS ACCOUNT:		
Deposit, Potomac			Balance as per Ledger	6,451 34	
Electric Power Co..	5 00		ADD:		
Advance on Travel-			Net Revenue for Year		
ing Expenses(Sec'y)	175 00	180 00	as per Exhibit "B"	454 42	
ADVANCE TO FORESTRY					6,905 76
AND IRRIGATION					
DEPARTMENT:					
As per Ledger Acct....		2,000 00			
FURNITURE AND FIX-					
TURES:					
As per Ledger Acct....		449 90			
Interest Accrued.....		84 72			
Advance on Postage, 1908.		212 40			
		\$10,075 76			\$10,075 76

EDUCATIONAL FUND, \$194.00.

This is the amount of money received in response to the appeal for funds to be used in special educational work.

DUES UNEARNED, \$971.00.

This amount has been received in payment of dues in advance; only \$58.00 of this, however, are for years after 1908, \$788.00 for annual members and \$125.00 for sustaining members being for the year 1908.

SURPLUS ACCOUNT, \$6,905.76.

The Surplus Account on January 1, 1907, was \$6,743.34. During the year

this was reduced by \$292.00, which amount was lost by dropping members for non-payment of dues, leaving a balance of surplus of \$6,451.34. The NET REVENUE for the year 1907 was \$454.42, which added to the balance brings the Surplus at December 31, 1907, to \$6,905.76.

Referring to the Revenue Account, herewith, you will find the amounts received from various sources and also the expenditures classified.

Respectfully submitted,

OTTO LUEBKERT,
Treasurer.

EXHIBIT "B"

REVENUE ACCOUNT

For Twelve Months Ended December 31, 1907.

DEBITS.			CREDITS.		
EXPENSE OF SECRET'Y'S OFFICE:			INCOME FROM MEMBERSHIP:		
Magazine.....	\$6,729 44		Annual Dues.....	\$10,080 64	
Salaries & Clerk Hire..	4,601 78		Life Membership.....	4,500 00	
Stationery & Printing..	1,642 64		Sustaining Dues.....	1,825 00	
Postage.....	3,197 86		Patron Membership..	1,000 00	
Rent and Telephone...	413 50				\$17,405 64
Miscellaneous.....	549 94		Contributions.....		733 20
		\$17,135 16			
EXPENSE OF TREAS'R'S OFFICE:			MISCELLANEOUS INCOME:		
Salaries & Clerk Hire..	443 75		Exchange on Checks..	5 62	
Stationery & Printing..	164 67		Sale of Circulars.....	12 05	
Postage.....	165 00		Sale of Forest Congress Proceedings..	39 15	
Miscellaneous.....	23 03				56 82
		796 45			
Balance, carried down...		264 05			
		\$18,195 66			\$18,195 66

Interest on Loans.....		\$143 33	Balance, brought down.....		\$264 05
Balance, being Net Revenue, carried to Surplus Account, Exhibit "A".....		454 42	Interest on Bonds.....	\$267 66	
		\$597 75	Interest on Deposits....	66 04	333 70
					\$597 75

ARBOR DAY—THE AMERICAN SPRING FESTIVAL

BY

Wm. Canfield Lee, Washington, D. C.

THE time of year is now at hand when Arbor Day is observed in many States. The date varies according to the climatic location of the State. In the South, Arbor Day usually occurs in the fall; Texas and Alabama, however, keep it in February, on Washington's Birthday; and thence it ranges northward at varying dates, until in Maine and Montana it is in May. In Georgia, the first Friday in December is fixed as the day, but the custom is to observe that part of the year as the tree-planting season, rather than to confine efforts to a single day.

In some States the day is appointed by the Governor; in others by school authorities. In some it is required by law, and in others it is merely a custom. In Idaho the climatic conditions in different parts of the State are so variable that the law requires the superintendent of schools in each county to appoint a suitable day.

In Pennsylvania there are three days; two days appointed by the Governor in the earlier and latter part of April, from which schools can choose one most suitable to the locality; and another in the fall appointed by the School Department.

According to one account, the Arbor Day idea originated with the secretary of the Connecticut Board of Education, Mr. B. G. Northrop, in 1865. The man who made it a public observance, however, was J. Sterling Morton, Secretary of Agriculture under President Cleveland. Mr. Morton was reared in Michigan amidst woods. When he went to the treeless country of Nebraska as a young man, and took up a claim in 1854, he was so impressed by the need of trees that he

set out a grove and made it a public institution, which has since become famous for its beauty and value. In 1872 Mr. Morton induced the State Board of Agriculture to adopt a resolution recommending the observance of a tree-planting day. April 10th was selected, and on that first Arbor Day, in the one State of Nebraska, a million trees were planted; some reports say several millions. Nebraska has since been called the Tree Planter's State. At the present time the date taken for Arbor Day in Nebraska is April 22d, which is Mr. Morton's birthday.

Other States followed the good example set, and a large amount of tree planting has been done. Minnesota in 1876, is said to have planted one and a half million trees, and the Province of Ontario 40,000 in 1885. The move has spread to foreign countries, and a recent issue of this magazine noted the establishment of Arbor Day in the fall in Ireland. It has also established itself in Great Britain, France, Norway, Russia, Spain, and Japan.

At the first meeting of the American Forestry Association, then called the American Forestry Congress, in Cincinnati, in 1882, tree planting was brought to the public attention to such an extent that there were public ceremonies; the school children and citizens planted a large number of trees; and the reports of this occasion helped to spread the knowledge of Arbor Day throughout the country.

In most States the day is primarily used to teach children the beauty and usefulness of trees. Planting is made on school grounds and elsewhere by the school children; and in cities, where actual planting is not practic-

able, indoor exercises are used. Where real planting can be done, however, that is generally a part of the observance. It is recognized that literary exercises, though valuable, are not sufficient without the actual setting out of trees. The State Superintendent of Washington writes that in the western part of the State trees are entirely too numerous, hence indoor exercises make up the day's observance, but east of the Cascade Mountains the reverse is true.

ly well wooded, the value of trees has not been appreciated until recent years. At the present time, however, probably every State and Territory in the Union has an Arbor Day, fixed by proclamation of some public authority.

Innumerable applications are made by citizens all over the country for trees from the Government nurseries. These cannot be granted, because the Government is unable to grow trees enough for the planting needed in the National Forests. Furthermore, the



Starting the seedling collections on their way after packing

Not only the school children have planted trees, however, but their example has stimulated their elders; and in fact, Arbor Day has been by no means intended for a school day only, but it has been recognized as a day for the whole community to act in unison for this form of public improvement. This is especially the case in the prairie States, where trees are scarce, and the need is felt. As we all know, in the parts of the country which are natural-

kinds of trees desirable vary to the greatest extent with the infinite diversity of climatic and soil conditions. It has been suggested, however, that the States provide means for distribution of trees at a low cost, for school purposes or to promote tree planting by citizens where trees are scarce. Twenty-six States now have forest officers, and all have agricultural experiment stations, where such work might be carried on.

Prof. F. W. Rane, State Forester of Massachusetts, has had success in such work. He offered the citizens of Massachusetts 150 each of white pine and white ash seedlings, two years old, for the price of one dollar, with the understanding that they were to be planted in Massachusetts. He further offered to schools, at the same price of one dollar, a collection consisting of twelve white pine seedlings, twenty-four white ash seedlings, twelve red spruce seedlings, five beech seedlings,

price, it would be better than giving them away free. A small charge would save the States the experience of Kansas. That State supplies 300,000 trees or more, for planting to her people each year; but often, in busy days, the farmer lets the trees he has asked for lie untended at the express office till they die, and thus he loses the trees, which have cost the State something.

Again, nurserymen might co-operate in the movement because it would



Planting forest trees on sand plain in Connecticut—This land is assessed at six dollars an acre, though worthless for agriculture

one-half ounce of white pine seed (about 900 seeds), twelve chestnuts for seed, twenty-five acorns for seed, and fifty white ash seeds. These, it will be seen, furnish an excellent stock for a school nursery. A large number of orders were received for both collections. Directions for planting were given with the trees and seeds.

This is a line of effort that might well be copied in other States. If the State would furnish funds for supplying these seedlings and seeds at a low

price, it would be better than giving them away free. A small charge would save the States the experience of Kansas. That State supplies 300,000 trees or more, for planting to her people each year; but often, in busy days, the farmer lets the trees he has asked for lie untended at the express office till they die, and thus he loses the trees, which have cost the State something.

Again, nurserymen might co-operate in the movement because it would be an excellent way of stimulating a demand for forest tree nursery stock. Professor Rane also urges that children be taught to collect tree seeds. The interest of live things for children is well known, and the value of nature study is recognized by educators. Arbor Day is one form of nature study. It is much to be desired that the children should be taught to give care to the trees after planting, and it may not be impracticable to make use of parks and woodlots for

tree study, and for training in the use of trees, as at Princeville, Ill., where it is reported that a forty-acre woodlot, which has come into the possession of the village, is to be used for nature study.

The animal kingdom as well as the vegetable, should have its share in nature study. Arbor Day and Bird Day are the same in quite a number of States, as Connecticut, Delaware, Illinois, New Jersey, and Wisconsin.

essential relation of tree growth to the material side of our civilization, can on Arbor Day be impressed upon the childish mind, so that the next generation will be readier than the present to use economically this gift of Providence.

A circular on Arbor Day issued by the Forest Service, says: "What child has not seen a muddy freshet? Yet this sight, so common in the spring, is full of suggestion for a forest lesson.



Normal school students at Washington, D. C., stratifying seeds in sand to carry them through the winter—The seeds are collected in the city parks

One mission of Arbor Day should be to make every child in the United States know the native trees near his home, how they grow, and how they are reproduced. Such a lesson will ultimately be invaluable when the Nation begins to realize the necessity for conservative lumbering and the arts of reforestation. Then it will be known what trees to use.

The facts of which the general public is now taking cognizance, as to the

The stream is discolored by the earth which it has gathered from the soil. This carries us back to the stream's source, in the forest springs. Again, it shows us with what force the water has rushed over the exposed ground where there was no forest to shield and bind it. In just this way the Mississippi tears down and flings into its bed, each summer, more soil than will be dredged with years of costly labor to make the Panama Canal. An ex-

periment with fine and coarse soils, stirred quickly in a tumbler of water, and then allowed to settle, explains how the stream continues muddy while it runs swiftly, and how it clears again as it slackens on more level stretches, dropping the soil to the bottom.

"On any steep, plowed hillside, or on any railroad or trolley embankment, exposed soil may be seen washing with the rain. A forest on a mountain

spongy soil of a forest and the bare soil or bed rock from which the forest litter has been removed.

In many cases the trees planted by school children on Arbor Day are neglected afterwards and allowed to die. In many other cases, however, they are carefully looked after by the children; and in Idaho, South Dakota, and Utah, the law requires the school board to care for them during the vacation.



Portion of the class at work planting tree seeds

slope may be pictured by a cloth upon a tilted table; then if water be poured on the higher edge, it will creep downward through the cloth and drip slowly from the lower edge, as would rain falling upon the forest. If now the cloth be plucked off, and the water still poured, we may observe at once what happens when such a forest is destroyed."

This is an admirable illustration of the difference in run-off between the

The State Superintendent of North Dakota reports that the treeless character of the country is the reason why the people fail to realize the need of replacing, by artificial culture, the favorable conditions which nature supplies in a forested country. He says, however, that progress is being made in bringing this to the knowledge of the people. In Kansas the day appointed is so late in the season that trees planted then are not apt to thrive

unless given unusual care. The State Superintendent urges that Arbor Day should be changed to the fall, as trees planted then are more apt to survive.

In addition to the tree planting there is a notable effect in many States in the embellishment of school grounds in other ways, as by planting shrubbery, cleaning up the yards, fixing fences, and the like. In Nebraska the boys have fenced the school yards. In some places the law requires the school board to fence the yard. In other places the school work has been the means by which the idea of tree planting and land-scape gardening was introduced to the general public, and so not only the schools, but the villages and the country surrounding have been beautified.

In Bath, Pennsylvania, for many years it has been the custom to plant a tree each year and name it in honor of some eminent man or woman. Last year "the Carnegie oak" was planted.

Many States, one-third or more, have Arbor Day manuals issued by the State Superintendent, the State Forester, or the Federation of Women's Clubs. In Ohio monthly bulletins on forestry and arboriculture are sent out by the extension department of the State University. In other States elementary agriculture is taught to the children, by legal requirement; and this should, and often does, include the primary elements of forestry. In West Virginia the day was not much observed for several years, but in 1907 the State Superintendent of Schools issued a good-sized manual and succeeded in obtaining general recognition of the day.

An Arbor Day manual, which especially carried out the intent of the authors of Arbor Day, was issued in 1902 by Arthur Le Fevre, then State Superintendent of Public Instruction, in Texas. This took account of the forest resources of Texas, and of the organizations for forest work in the States, in the Nation, and in foreign nations; and discussed the practical value of woodlots and of forests as a protection to many industries.

In Hawaii Arbor Day was first observed on November 3, 1905, when the Governor generously contributed half

of a fund for a prize of \$5 in each of the 154 public schools, to be given to the grade whose planting on Arbor Day secured most successful results. The other half of the fund was raised by subscription. Most of the trees were furnished by the Territorial nursery, at Honolulu.

In FORESTRY AND IRRIGATION for May, 1907, was given an illustrated account of the notable work done by the schools and citizens of Winnebago County, Illinois, under County Superintendent Kern.

In the same issue was given President Roosevelt's proclamation to the school children of the United States. In this the President said: "It is well that you should celebrate Arbor Day thoughtfully, for within your lifetime the Nation's need of trees will become serious. * * * A people without children would face a hopeless future; a country without trees is almost as hopeless."

One of the best examples of Arbor Day accomplishment in village improvement outside of school work is in the park at Manhattan, Kansas. When this town was laid out in 1854, a large square tract of forty-five acres was set aside as a city park, but the land was bare prairie, and the pioneer citizens had no time to turn it into a park; for many years it was used as a county fair ground. In 1894 a fountain was placed in the park, and in 1904 an obelisk was erected to the memory of the Indian Chief, Tatarrax, who, legend says, befriended Coronado when on his trip of exploration. Elm, box-elder, sycamore, and hackberry have grown rapidly. Norway and Austrian pines and red cedar have done fairly well. White pine and arborvitæ have been a failure. A few oaks of different species are thriving.

This experience further shows the value of providing for things of public benefit, even though they cannot be realized at once. The founders of Manhattan placed this park on their plat, and though for thirty-four years no real park was there, yet when the time came the ground was public property, and only needed to be improved. A view of this park is shown in the frontispiece of this magazine.

SHALL UNCLE SAM DRAIN THE SWAMPS?

THE jocular statement was made recently by one of the best qualified observers of Congressional legislation, in speaking of the chances for enactment of the various measures advocated by the President, looking to the conservation and utilization of the Nation's internal resources, that a National drainage enactment of some sort was practically assured, since the majority in both branches of Congress had introduced swamp bills. While

matated at this session; but for an issue which has heretofore scarcely been spoken of, certainly remarkable progress has already been made, and the National Drainage Bill now pending, a very comprehensive, home-making measure, appropriating about \$6,000,000, is well along on the Senate calendar and likely to pass that body at an early date. It is grounded on the same vital principle as that upon which the Irrigation Act is based.



One of the present inhabitants of the land to be reclaimed—In the Florida Everglades

the gentleman has withheld his "remarks" for a possible slight revision of the figures, it is nevertheless a fact, as shown by the Congressional Record, that for a new legislative issue, a large number of bills have been introduced providing for the drainage of swamp and overflow lands by the Federal Government, and much interest has been shown by various Senators and Representatives in the subject.

It is hardly to be expected that drainage legislation will be consum-

This principle, embodied nearly a decade since in the first irrigation reclamation bill, introduced by Senator Newlands of Nevada, provides a happy solution, for the time being, of the problem of getting annual sums from Congress for internal improvement; namely, an automatic appropriation into a "reclamation fund" of the money received by the Government from the sales of public lands. The Drainage Bill appropriates the proceeds of such sales from 1902 to date and hereafter,

and places them in the hands of the Secretary of the Interior for drainage construction, as in the case of the irrigation reclamation act. As under that act, the fund becomes a revolving one, the amounts by which the Government is repaid for the cost of drainage construction, going back into the fund to be used in future projects.

In the account published in *FORESTRY AND IRRIGATION* of the recent National Drainage Congress at Baltimore, the general statis-

ornia. The report also shows that the Reclamation Service is conducting actual drainage construction on a large scale in connection with a number of the Western irrigation projects, so that, as Secretary Garfield points out, these two bureaus of his department are fully prepared to prosecute any further new drainage work, either surveys and plans, or construction.

Many of the best friends of this proposed development of a great latent resource of the Nation, express

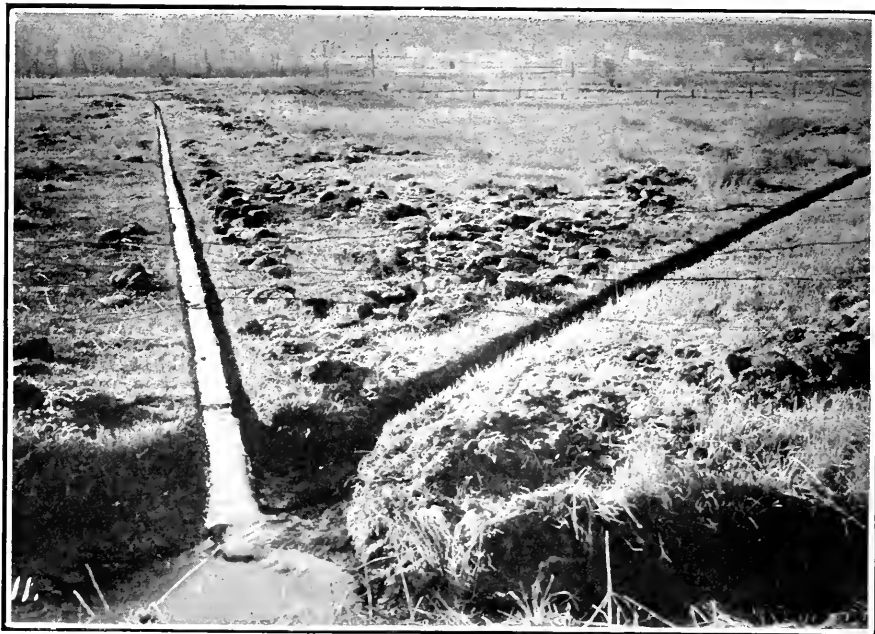

Not all of this work is in remote regions—Here are drainage ditches on Staten Island, New York—Constructed in connection with mosquito war, but incidentally the land grows paying crops of hay

tics regarding the areas of swamp lands were stated; but since then a report has been transmitted to Congress by the Secretary of the Interior, giving some further interesting information, and showing that the Geological Survey has made a preliminary investigation and survey of large areas of swamp lands, and is now conducting a number of special drainage surveys, notably in Minnesota, Mississippi, and the great Sacramento Valley of Calif-

grave doubt as to the constitutionality of the drainage by the Government of land in private ownership. There would appear to be no real difference between improving either by irrigation or drainage a tract of land which is today Government land, but when reclaimed tomorrow will be homesteaded and become privately owned, and reclaiming land which was homesteaded yesterday, but which must remain undeveloped unless reclaimed.

However, the constitution is sometimes a serious stumbling block to the carrying out of good policies, as it is a safe-guard against the consummation of bad ones.

There are many, nevertheless, who believe that both irrigation and drainage of private lands by Federal agency is a constitutional privilege, if not a duty, of the General Government. Senator Newlands puts it, that drainage considered broadly is an interstate affair in its direct effects, because it influences the flow of interstate rivers; a disturbance of the conditions

trend of the times seems to be to accord more power to the state than heretofore, and to take into consideration broadly the question of general welfare. For instance, the Supreme Court of the State of Maine handed down an opinion during the month, that the State Legislature had a right to prevent forest destruction or waste on private lands. If a legislative body has such a right and power to go on to privately owned lands—and the opinion calls attention to the fact that all lands are originally derived from the State—and prevent the owner



Swamp scene in Dugdemona Bottom, Louisiana

of run-off or drainage in any one locality must affect other localities widely separated, and in the case of drainage on a large scale the changes caused would be very great. Yet even aside from this phase of the question, the projects and commodities from drainage reclamation would enter into interstate commerce; and the Senator holds that upon this broad ground alone the Nation would be warranted in prosecuting the work.

Various other good constitutional lawyers have stated their belief in the constitutionality of such work. The

from wasting his timber, a natural resource, in the interests of the general welfare, it should similarly have a right to go upon private waste lands and make them productive. The fact that in irrigation, as well as in the proposed drainage construction, the cost of the Government work is returned to the Government, removes the objection of many legislators who look with disfavor upon annual appropriations for internal improvements, the benefits from which come back to the Government only indirectly.

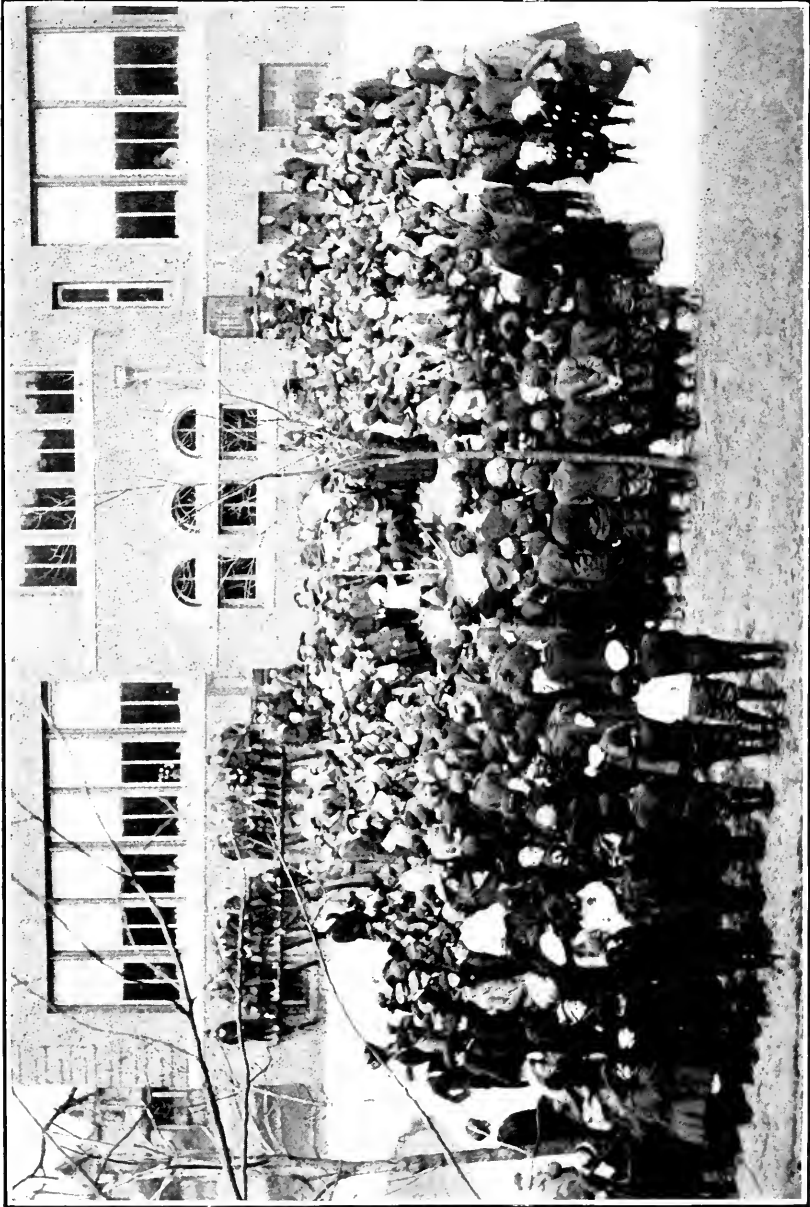

Pupils of Rosedale School, Cleveland, on Arbor Day, 1907, planting "Louise Klein Miller tree"

TREE PLANTING IN SCHOOL YARDS

BY

Louise Klein Miller, Curator of School Gardens, Cleveland, Ohio

IF AN appreciation of forests and forest preservation is ever to become general, public sentiment must be aroused, and the most comprehensive way of accomplishing the result is to educate the children of the public schools and, through them, their parents.

Through the efforts of the Home Gardening Association, the children of Cleveland are becoming intelligently interested in flowers, and as a consequence, back yards have been cleaned up, and made objects of beauty and delight.

The association was organized a few years ago by the residents of Goodrich House, a social settlement in one of the most congested and immoral districts of the city. The neighbors were called together and a Home Gardening Club was formed, each member paying ten cents as annual dues, and receiving in return ten penny packages of seeds. The dreary back yards were transformed, the people were regenerated, and light came into many souls through contact with the beautiful.

What proved so uplifting in one community it was felt could not fail to be of influence in other sections of the city. The president of the Home Gardening Association secured permission from the school authorities to sell penny packages of seeds to the children of the public schools. The first year 40,000 packages were sold; and last year over 546,000 packages were disposed of to children of Cleveland and other cities that have adopted the Cleveland plan. By purchasing seeds in large quantities the association found it could make money, all of which is used for extending the work.

The school gardens, the outgrowth of the movement, were started about three years ago, supported by the Home Gardening Association and the Board of Education. Last year the school gardens were made a regular part of the school work, under the direction of the Curator of School Gardens. She co-operates with the Home

Gardening Association, has direction of the school gardens, superintends the planting of trees and shrubs for the improvement of the school grounds and delivers illustrated lectures in the public schools for the purpose of giving specific directions on preparation of soils, planning and laying out of gardens, artistic color combinations, and succession of blooming and crops. The city is not only made more sanitary and beautiful, but the children are becoming strong and well, and are acquiring a life-giving, wholesome occupation.

The herbaceous botanical garden which has been started will enable the children to study plants scientifically. In the near future it is hoped to have an arboretum of trees and shrubs, which will serve as a laboratory for students taking a course in landscape gardening, horticulture, arboriculture, and the elements of forestry; and serve as a base of supply for the improvement of the school grounds.

The children raise their flowers at home, and in the autumn bring them to the schools for the annual flower shows. Judge Dellenbaugh, who has always been a most generous friend, will give each school that had a flower show last autumn a tree for Arbor Day. Last spring the Board of Education supplied one or several trees for each school yard. Each child who did efficient and faithful work in the school gardens was given a *Catalpa speciosa* for home planting, sent by Mr. Brown, editor of *Arboriculture*. Through the generosity of Mr. Brown a thousand *Catalpa speciosa* are ready for distribution to the children and schools this spring.

The superintendent of one of the parks states that the work being done in the schools is showing its influence, because several years ago, in some of the foreign neighborhoods, as soon as trees and shrubs were planted they were injured or destroyed, but now it is a rare thing for any plant to be disturbed.

CALIFORNIA IRRIGATION NEEDS FORESTS

BY

Lewis E. Aubury, State Mineralogist of California

IN CONSIDERING the subject of irrigation, I wish to say a few words upon that of forests, which are essential as an aid in conserving the water supply.

While the subject of irrigation has at times been of absorbing interest to the people of this State, they have given little thought to the sources of

spin. All went well for a while. Suddenly the machine came to a stop, and believing something had gone wrong with the running gear, he jumped out, wrench in hand, to seek the cause of the stoppage. First he turned a crank, then he tightened a bolt. He went under the machine, and over the machine, and all around the machine. He



North side of Strawberry Peak, California, looking east—Snow held by the pines

water supply; which lack of interest, in view of the necessity for protection of these sources, reminds me very much of a friend of mine who recently purchased an automobile. He was so proud of his new acquisition that he invited a few of his friends for a

screwed and unscrewed, opened valves and closed them, but all to no avail—the blamed thing would not budge. After expending considerable time in efforts to discover the cause of the difficulty, it suddenly occurred to him to examine the gasoline tank, when to

his astonishment and consternation, he found it empty.

So with our friends, the irrigation-ists. Unless they awaken in time to the fact that if they ignore the protection of the sources of their water supply, their ditches will be empty, they will, like my friend who owned the auto, suddenly discover that they have paid too little attention to the most essential requirement. An empty gasoline tank will not furnish power to

cure forty millions.

I am aware that I do not voice the unanimous sentiment of all citizens of our country, and particularly not that a few non-resident owners of timber lands in California. These persons have been particularly active of late, both in the halls of Congress and in so-called land conventions, as well as elsewhere, in endeavoring to create a sentiment antagonistic to the present National Forest policy, so ably con-



Hillside two miles west of Fredalba, San Bernardino County, California—
Nearly all the timber cut away—Erosion begun—Nothing to hold the
water

propel a motor, neither will empty ditches promote the growth of alfalfa.

Our present executive, far seeing, and knowing the protection needed, has wisely set aside tracts of timbered lands at the sources of our water supplies. National Forests have been so extended under the administration of Theodore Roosevelt that to-day we have in California over 20,000,000 acres of timbered lands in forest reserves, and it is my personal regret that the President could not have se-

ducted under the direction of Gifford Pinchot.

They say the lands should be thrown open for settlement by the people. What great solicitude the persons who are fathering this movement are exhibiting for the poor people! Let me say that their scheme is too transparent. We have had too many demonstrations of fine bodies of timbered land which have been acquired by the people, only to be transferred to the control of the timber grabbers.

Under the present National Forest policy, the home builder will be properly taken care of when he can find land suitable for cultivation. We of California are just beginning to realize what a protection to our interests the National Forest means.

It may be true that there are isolated cases where the management of the National Forests works a hardship, not only on the stockraiser but on the miner; but I say, give the Forest Service a chance—it is yet young,

and to be continually confronted with the sign, "Keep off the grass."

I see much trouble ahead in the not far distant future for the people of this State, and particularly the northern portion of California, unless the Government, and for that matter, the State, provides means to properly control the monopolistic tendency to acquire not only our timbered lands, but our water supply as well. The miner, agriculturist, horticulturist, and in



Hillside and irrigating ditch in perfect condition, undisturbed by fire—In the absence of trees, brush does much to hold the soil and the rain water

and I believe, from my knowledge of the system of conducting these holdings, that any wrongs with which it may be afflicted will soon be remedied.

The complainants might well be asked which they would prefer—Government supervision, or private ownership of the timber lands in the hands of a

fact, the people generally, will have their most valuable public utilities controlled by a few individuals.

Therefore, as a check to our monopolistic friends I can see no better method to adopt than strengthening National Forests and lending our aid towards the present policy of the President.

CANADIAN FORESTRY ASSOCIATION MEETING

THE Canadian Forestry Association met in its ninth annual session in the Board of Trade rooms, Montreal, Province of Quebec, on Thursday and Friday, March 12th and 13th. His honor Sir L. J. Jette, Lieut.-Governor of the Province of Quebec, opened the meeting, which was presided over by the Association's president, H. M. Price, of the city of Quebec. The meeting was a large and enthusiastic one, and was a success in every way.

An announcement that brought great gratification to the members of the association and evoked hearty applause was made by Hon. Sidney Fisher, Dominion Minister of Agriculture, who declared the intention of the Dominion Government to set aside, in a short time, the whole of the eastern slope of the Rocky Mountains, from the international boundary as far north as the timber goes, as a forest reserve. The new reserve will embrace the entire belt of the foothills, so that a vast area running north and south over 1,500 miles will be preserved as a national asset of incalculable value. In extent and magnitude of virgin woodland, this will be no doubt the greatest government forest reserve on earth.

An important feature of the meeting was the use of both the French and English languages; papers were read and discussions carried on in both tongues, and two editions of the report of the meeting will be published, one in English and the other in French.

Much importance was also attached to the active and enthusiastic interest taken in the meeting by a number of the higher Roman Catholic clergy of the province. Among these were Archbishop Bruchesi and Bishop Racicot, of the Archdiocese of Montreal, and Canon Dauth, of Laval University, who gave addresses, and Monsignor Laflamme, dean of the faculty of

arts in Laval University, who gave an admirable paper on "Le maniere dont quelques cultivateurs usent le bois de leurs terres" (The way in which some farmers use the wood on their lands).

Mr. G. C. Piche, forester to the Department of Crown Lands of the province of Quebec, also gave a paper in French, while papers in English were contributed by Messrs. H. G. Joly de Lotbiniere, A. H. D. Ross, E. Stewart, R. R. Bradley, and L. O. Armstrong and Dr. Robert Bell.

The idea that the forests of the far North were practically illimitable was combated by several speakers who had traversed these districts. Mr. E. Stewart and Mr. Macoun both stated that very little was known of the real timber resources of the North country, since explorers necessarily traveled by the rivers, canoeing up in summer, or taking the frozen surface of the streams in winter. In this way they traveled through the river bottoms, which were heavily wooded, and thus were apt to get quite mistaken ideas of the country, since the districts back of the river valleys might be quite useless from a timber point of view.

American publishers will be interested to know that an export duty on both pulpwood and pulp was strongly favored.

On Thursday evening Prof. F. Roth gave a lecture, illustrated by stereopticon views, on "Forest Lands and Agriculture," and at the noon hour, on Friday, Dr. Fernow addressed the Canadian Club of Montreal on Canadian forest policy and problems.

The necessity of protecting the forests from fires, especially along the line of the new transcontinental railway, and the question of restricting the export of pulpwood, also figured largely in the discussions.

Mr. Overton W. Price represented the U. S. Forest Service. Mr. E. A.

Sterling, of Philadelphia, and Prof. Hugh P. Baker, of the Pennsylvania State College, were also welcome guests from south of the international boundary.

Resolutions were adopted by the meeting urging on the different governments the necessity of more thorough protection of the forests from fire; calling on the governments—especially those of the provinces of Ontario and Quebec—to take measures to re-acquire their areas of waste and broken land and set these apart for forest reserves; and congratulating the provinces of Ontario and Quebec on the adoption of forward steps in forestry.

The following were elected officers for 1908-1909:

Patron, His Excellency Earl Grey, Governor-General of Canada.

Honorary President, Rt. Hon. Sir Wilfrid Laurier.

President, Mr. W. B. Snowball, Chatham, N. B.

Vice-President, Mr. Thos. Southworth, Toronto, Ont.

Secretary, Mr. A. H. D. Ross, Faculty of Forestry, University of Toronto, Toronto, Ont.

Assistant Secretary, Mr. F. W. H. Jacombe, Ottawa, Ont.

Treasurer, Miss Marion Robinson, Ottawa, Ont.

Mr. R. H. Campbell, who resigned the position of secretary, was added to

the Board of Directors.

The Association has now a membership of 1,282, an increase of sixty during the past year.

CANADIAN SOCIETY OF FOREST ENGINEERS

Canadian foresters have organized the Canadian Society of Forest Engineers. The society was formed on March 13, 1908, at the time of the annual meeting of the Canadian Forestry Association. The objects of the society, in the words of its constitution, are "the advancement of its members in the theory and practice of forestry by the discussion of technical and professional topics, the promotion of a better mutual acquaintance among Canadian foresters, and the cultivation of an *esprit de corps* among the members of the profession." Four classes of members are provided for, namely: Honorary, Active, Student, and Associate. The inaugural dinner was held in the Place Viger Hotel, and the society numbered among its guests Mr. Overton W. Price, Prof. F. Roth, and Prof. Hugh P. Baker. Dr. Fernow was elected president of the society; Mr. R. H. Campbell, Dominion Superintendent of Forestry, vice-president, and Mr. F. W. H. Jacombe, of the Forestry Branch, Department of the Interior, secretary-treasurer. The society already numbers thirteen members.

THE MOUNTAINS

By Haver Charles Hurst

Gazing across the level of the plain,
A stranger little dreams that any call
To march against that purple mountain
wall
Could yield him aught of pleasure or of
gain;

Yet these same mountains never will
disdain,
Upon approach, to open to one and all
Their canyons' gates with wood and
waterfall,
And rivers flowing down to the blue
main.

E'en so the alien soul at times doth stand
Doubting the blank face of eternity,
Not knowing that the walls on either
hand
Make way for living rivers, pure and free,
That flow on through a sweet, ethereal
land,
And empty in a great and boundless sea.

PROTECTION FOR AMERICAN INDUSTRY

BY

Hon. Asbury F. Lever, Representative from South Carolina

AT the annual meeting of the American Forestry Association, January 29th, Congressman Lever was called upon to speak, the Chairman remarking that here was a lever which might be used in moving Congress. Mr. Lever responded:

MR. CHAIRMAN, LADIES AND GENTLEMEN:

You may be interested to know that my mother was a Derrick, and a combination of a Lever and a Derrick ought to be able to move somebody or something. So far, that combination has not been able to move the powers that be in the National House of Representatives; but we are hopeful, we are optimistic, we are rather sanguine with respect to the pending bill. It was not my purpose to make a speech here to-night, and I am not going to do so. I came down to hear speeches made, and I am glad I have come, because Mr. Shepard has very briefly but very comprehensively met the chief objection that the friends of this proposition find in the House, namely, that relating to the power of Congress to appropriate money for this purpose. He has shown you, he has convinced me—though I was convinced before—that if Congress has the power to appropriate money for the purpose of dredging your rivers and your harbors; if Congress has the power to appropriate money for the purpose of building locks and dams in the aid of navigation; if Congress has the power to acquire lands at the head of navigation on the Mississippi River in aid of the navigation of that great artery of commerce; if Congress has the power to appropriate money for the purpose of acquiring artificial

means in aid of navigation, then, in the name of heaven, I ask why has not Congress the power to acquire the natural reservoirs of this country in aid of navigation?

I am not a lawyer—I am glad sometimes that I am not one. I approach this subject, therefore, as a layman. I approach this subject without the constitutional cobwebs that sometimes grow in the brains of great lawyers, but I can look at it, I hope, from a purely practical and business point of view. I take it that the Democrat from Texas who votes an annual appropriation of \$500,000 for the purpose of controlling the cotton boll weevil will not have the nerve to stand up and argue his constitutional conscience upon this proposition. I take it that the member of Congress from Kansas who appropriates Federal money for the purpose of destroying the green-bug that destroys the wheat fields out there, will not have the nerve to stand up and quibble about his constitutional objections to this proposition. I take it that the New Englander who voted an emergency appropriation of \$500,000 for the purpose of stamping out the foot-and-mouth disease in that section several years ago, is not going to find it very easy to reconcile his constitutional objections to this proposition with his past record. I take it that these gentlemen who vote appropriations of over a million dollars each year for the maintenance of the great Weather Bureau of the Department of Agriculture, which furnishes such valuable information, not only to the agricultural, but to the commercial, the industrial and the shipping interests of this country, will find it a rather hard

task to reconcile their boasts in that direction with their objections to this proposition. So, if we are looking for precedents, I think we can find them, world without end, amen.

What interest do I have in this proposition? I have the honor to represent the capital district of the little State of South Carolina—little in area, but great in her possibilities, and great in her history. I am in the central part of the State. I am one hundred and fifty miles from any of the forests that we are now talking about. What interest, therefore, have I? I will tell you. There is not a wheel of industry in the city of Columbia, the capital of my State, that is not dependent upon the rainfall in the Southern Appalachian Mountains. There is not a foot of rich, alluvial, bottom land on the Congaree or the Santee River that is not dependent upon the rainfall up there, and dependent upon the sponge-like humus of those mountains to protect it from the overflow of the river. That is my interest.

I am here to protect myself against the State of North Carolina. Every navigable stream in the State of South Carolina has its origin in North Carolina, in these very mountains that we seek to set aside as a forest reserve. South Carolina, therefore, is at the very mercy of North Carolina. What reason, says North Carolina, do I have for desiring Congress to set aside large appropriations to establish reserves to protect the forests of North Carolina? But we of South Carolina know that the forests of North Carolina are a necessity to the people of South Carolina, and if these forests are destroyed, what redress have we in our own State? None, except the appeal that we are making to Congress to exercise the power vested in it, and to discharge its duty in aiding a great National undertaking.

The three States of Georgia, North Carolina and South Carolina have capital invested in cotton mills, I am informed, amounting to forty million dollars, with an annual output of one hundred million dollars. These mills

are absolutely dependent upon water power to keep them running. Three hundred thousand of our population are dependent upon these mills for their daily bread. Is not that a big problem? Is not that getting to the point that Mr. Jackson reached in one of his famous veto messages, that the problem must be National before the Federal Government had the power to deal with it? I think so.

And I rather agree with Mr. Jefferson in his statement relative to the power of Congress to erect lighthouses in aid of navigation. Mr. Jefferson held that we did not have that power; but the Congress of the United States thought otherwise, and kept on and on making appropriations until Mr. Jefferson finally said—and I quote him literally—"The thing is so valuable that it justifies the infraction of the Constitution," and Mr. Jefferson was quite right there. Mr. Monroe's objection in his famous veto of the Cumberland Gap road was based upon the fear that the Federal Government would usurp the jurisdiction of the State Government, and that was a fear that we can right readily understand when we take into consideration the history of that period; but we in this bill guard against the objection that Mr. Monroe found to the Cumberland road proposition; by making it necessary, or making it a condition precedent, upon the part of the State Legislature to give us the authority to go into a State before we do go into it. Then, as I said a moment ago, Mr. Jackson, in putting the final quietus upon this Cumberland road proposition, said that he vetoed it because it was a local and not a National proposition; that the Federal Government had no power except over National propositions. And I take it that there is not a sensible man, woman, or ten-year-old child in America who understands the situation with reference to the propositions pending before Congress in these bills that will not concede that we have a National and not a local proposition.

Why, my friends, the water power

in the Southern Appalachians amounts to 2,700,000 horsepower, which at an annual rental of \$20 per horsepower would amount to something over \$50,000,000 of revenue per year. If Congress had done its duty and passed this bill when it was introduced some ten or twelve years ago, and had acquired these lands in the Southern Appalachian and in the White Mountain ranges, the Government would have been saved millions upon millions of dollars; and the longer we delay the more the destruction goes on, and the more in the end will we be called upon to appropriate out of the Federal treasury. The time is now; this is the accepted moment. The lumber industry is in a pretty bad way, I am informed. Great lumber companies are willing to sell their cut-over lands very cheaply; they are willing to sell a great deal of their virgin timber rather cheaply, much more cheaply than they would twelve months ago; and if we are to act, now is the time to begin.

I am glad to see this large representative gathering of people here, and I want to ask you to come over to-morrow to the Committee on Agriculture, of which committee I happen to be a member. I want you to come in such numbers, and pack in there so thickly that when you breathe you will burst the walls of the building. I want you to let that committee know that there is a strong, wholesome sentiment behind this proposition. Heretofore we have been told that there was no real sentiment behind it; that there was nothing more behind it than the theory of a few dreamers. We have been told that the Federal Government surely is not going into the business of buying scenery. We want the business men of this country to go before the committee to-morrow and impress upon the committee that this is no scenery proposition, but that it is a business proposition pure and simple. We are said to have a business administration up there in the House, but sometimes the folks there, when they don't want to do a thing, find it

convenient to have an attack of constitutional tight colic. I want you to go before that committee and give them a preventive for this dread disease.

I feel, my friends, that if we could get that bill out of the committee it would pass. Surely, when the Senate of the United States has passed the bill so many times without any serious objection; when the Committee on Agriculture, last year, without any information on the subject before it except some comparatively meager data, passed it unanimously, surely that committee, with this full report that the Forest Service has made, which emphasizes the need of this legislation, will act this year. A committee which passed the bill last year, with practically no information about it, surely ought to pass it this time; and if the committee does not pass it this time there will be an inclination in the breasts of some of us to inquire why it does not pass it.

I am glad that you are here. I want the committee, and I want the House of Representatives, to know that there is a sentiment behind this proposition; that there is a strong sentiment behind it. I want them to know that they have some constituents at home who are watching them. It is a pretty good idea for the public to keep its eyes on members of Congress. I am glad you are here, and I want the Congress to know that the ballot box down there in South Carolina has been heard from, and the ones in North Carolina, and in West Virginia, and in Pennsylvania, and in New York, and throughout the New England States; and that the returns show that the country is overwhelmingly in favor of this proposition.

I believe that when the committee understands this proposition, I believe that when Congress understands this proposition, they will both be very much in the position of the parrot that the country parson owned. This parson bought a parrot that had a habit of using cuss words. When the parson's friends would come to call on him he

was very much mortified at the old-fashioned South Carolina cussing that this parrot would do, and the parson did not know what to do to remedy the evil. He finally went to the man from whom he got the bird and said to him, "Your parrot is a fine bird, but he has a habit of cussing, and this embarrasses me very much. What can I do to cure him?" "That's easy," was the reply; "next time he begins cussing you take his cage and whirl it around and around until you make him dizzy, and then dash him into water, and you will have no further trouble." The next Sunday the parson's friends dropped in. They began teasing the parrot, and the parrot started his cussing. The parson picked up the cage and whirled it around un-

til he got the parrot dizzy, and then he dashed him into a tub of water. When he took him out the bird sat there wobbling from side to side. When he came to himself he shook his feathers, turned around, looked at the parson and said, "Will you tell me where the devil you were when the cyclone struck me?"

And I feel, my friends, that when the powers in Congress know we have a strong public sentiment in favor of this proposition, when Congress knows that we are attempting to protect the future and to protect the present, by preserving our natural resources—I am satisfied when Congress finds that out, they will ask the question that the parrot asked the parson.

THE KNELL OF THE FORESTS

By George Klinge, Summit, N. J.

Have you heard the throb of the forest heart?
The crash as the shivering timbers part,
And a life goes out—a forest king
Reels to his fate where the ax strokes ring?

Have you seen the monarch of centuries past
Throw down his crown and give over at last,
From the struggle of years to bring to its height
The shaft reaching up to the blue and the light?
The struggle to gather from earth and from air
The elements wrought into food by his care;
To gather the waters and hold them for you
To be fed to the springs, and fed to the dew?
The struggle with drought and tempest and blast?
Oh, the doomed, passing forests! The die is cast!
Each moment that spins from the wheel of Time,
Marks a veteran's fall in his native clime.

There are deserts to-day, where a while ago,
The rain-spirit brooded, and wild buds could blow;
Where the arms of the forests were held to the sky
As a pledge that the water-springs never should dry.
But the ax of invasion swung in with its threat;
The forest-heart reeked where the ax-blade was set;
And the Earth, in revolt, gave the shafts of her dead,
But her waters withdrew! The sun burneth red,
Where Verdure once wrought at her looms, and the rain
Through the forests sung Nature's sweet, joyous refrain;
But to-day, where scorched Nature lies burned with its brand,
The death-angel broods on the wings of the sand.

Shall America, garden of earth, cast away,
The gifts of the centuries, felled in a day;
Till she stands in her poverty, branded, servile,
A target for cycles of time to revile?

THE WHOLESALE LUMBER DEALERS' CONVENTION

REPORTED BY

Mrs. Lydia Adams-Williams

THE sixteenth annual meeting of the National Wholesale Lumber Dealers' Association was held at the New Willard Hotel, Washington, D. C., March 4 and 5, 1908.

The attendance was representative, delegates coming from all parts of the United States.

The most important questions considered were those relating to lumber transportation and rates. The preservation of the forests received much attention, about one-fourth of the time, exclusive of the banquet, being devoted to that subject. The work of the U. S. Forest Service was highly praised. Resolutions were adopted favoring the Appalachian Bill and commending President Roosevelt's efforts to increase the effectiveness of the work of the Forest Service.

OUR LITTLE SUCCESSORS

A pleasant feature of the convention, early in its progress, was a reception tendered the delegates and their guests by President Roosevelt.

The President said to them:

"It behooves every man who wishes to see the land left better, instead of worse, for the children that come after him, to join with the Government in trying to take steps to make the lumber industry a permanent industry, to perpetuate, through use, the forests of this country. We, all of us, in this country, must turn our attention more and more to the conservation of the natural resources of the land; but there is no body of our citizens to whom it is a matter of such immediate moment as this body that I am now addressing."

Mr. Roosevelt remarked on the presence of some little representatives

of the next generation, in whose behalf he was speaking.

BUSINESS ACTION

The annual address of the president of the Association, Mr. J. M. Hastings, of Pittsburg, Pa., dealt principally with the year's business conditions.

Secretary E. F. Perry gave a very complete report of the year's work. He urged the formation of a plan of co-operation with the Forest Service, whereby the study of Forestry may be introduced into the public schools of the country.

Committees were appointed on nominations, resolutions, and trade relations; and reports were heard from the committees on hardwood inspection, fire insurance, trade relations, arbitration, and marine insurance, and legislation.

FOREST PRESERVATION

The second day's session was devoted to topics connected with forest preservation. The chairman of the forestry committee of the National Wholesale Lumber Dealers' Association, Hon. Nelson P. Wheeler, an old-time lumberman and a member of Congress from Pennsylvania, presented a very interesting report, in which he said that conservative lumbering is getting to be the rule, that all parts of the tree are used, even the scraps being raked together and sent to the pulp mills. He said that the lumbermen are doing more, probably, than any other agency to promote the cause of forestry; that they approve in general of the National Forest policy of the Government; and that under such management the forests should

continue forever to furnish material for the homes of men and to preserve the water flow.

Mr. Wm. L. Hall, assistant forester of the Department of Agriculture, who had charge of the work of surveying the proposed Appalachian and White Mountain National Forests, spoke very interestingly of conditions there.

After eulogizing the address made by Mr. Wheeler, Mr. Hall emphasized, from his study and observation, the deplorable waste of timber now going on in the Appalachian and White Mountains, through destructive methods of lumbering.

Mr. Hall said that it is the practice of some lumbermen, where spruce is taken out full length on the higher slopes, to cut the hardwoods, which are then left on the ground to decay, making one of the worst examples of wasteful lumbering to be seen in the country to-day.

Fires sweep through this decaying timber, destroying the leaf humus and leaving the soil bare, so that the forest cannot reproduce itself in hundreds of years.

Mr. Hall said that the Forest Service had pictures showing thousands of acres, in the aggregate, on which the soil has been absolutely destroyed.

One of the most valuable addresses, from a scientific standpoint, and from its wealth of useful statistics, was made by Mr. R. S. Kellogg, of the Forest Service. Mr. Kellogg gave the annual drain upon the forests as 100 billion feet, board measure; and the annual growth as not over 40 billion, leaving 60 billion as the net annual reduction of our national stock of standing timber.

The largest estimate possible of the standing timber is 2,000 billion board feet, so that there is a prospect of exhaustion in thirty-three and one-third years, or one generation. In the United States, said Mr. Kellogg, we use 450 feet of timber per annum for every man, woman and child in the country; Europe uses 60 feet, a remarkable contrast.

Mr. Kellogg spoke further of the importance of conserving other natural resources. A very interesting discussion followed Mr. Kellogg's paper.

"The Drain upon the Forests" is the title of a recent circular of the Forest Service, written by Mr. Kellogg, and published in November of last year.

F. E. Underhill, of Philadelphia, delegate to the hearing on the census of standing timber, gave his report and said that from 1880 to 1906, 55 billion feet of lumber had been cut from the forests of Pennsylvania, indicating the vast amounts of timber that are being taken regularly from the State and from the Nation.

A. D. Hopkins, forest entomologist of the Department of Agriculture, said that the Bureau of Entomology, of which Dr. L. O. Howard is in charge, has now arrived at facts and methods whereby loss of timber from insects can be controlled and prevented.

CHINESE FLOODS

George H. Maxwell, chairman of the National Irrigation Association, gave a splendid exposition of the control of floods by forests and forest planting. He spoke of the floods on the Ohio, Mississippi and Missouri rivers and their tributaries, the floods growing more destructive each year, and said that in a comparatively few years we will have the same conditions on the Mississippi that they have in China today. In that country there are no forests to control floods, and the water runs out over the country, with the result that we have the news every once in a while of those awful famines in China, and an appeal to the world for aid, caused by nothing but forest destruction.

Mr. Maxwell advocated a postal savings bank, such as is in operation in France and New Zealand, to bring into the National treasury money for planting forests, acquiring forest lands, reclaiming swamp lands and

overflowed lands, and for building waterways.

Here we are facing a timber famine, with more than half a million men out of employment, with \$500,000,000 locked up in chimneys, bureau drawers, and other hiding places for money. Put the money in United States postal savings banks at two per cent; reinvest it in reclaiming lands, building waterways, and acquiring forests, that will pay four per cent annually and give employment to almost a million idle men.

YALE FOREST SCHOOL

R. C. Lippincott, of Philadelphia, made a long statement describing the splendid work of the Yale Forest School, which was endowed by James W. Pinchot (since deceased). Mr. Lippincott made a plea for further subscriptions for the support of the chair, which is known as "The Yale School of Lumbering and Applied Forestry," saying that they wished to raise \$150,000. Mr. Lippincott also discussed a change in the grade of maple flooring.

BANQUET AT THE NEW WILLARD

The sessions of the Association were brought to a brilliant close by a banquet at the New Willard hotel.

Mr. J. M. Hastings, of Pittsburg, Pa., the retiring president, was toastmaster, and the speakers included Speaker Cannon and Senator Knox, both presidential possibilities.

Contrary to precedent in the Lumber Dealers' banquets, (but an agreeable feature, nevertheless) the ladies were invited to the banquet hall to listen to the speeches and toasts.

Senator Knox complimented the lumbermen on their character and achievements, mentioning the vastness and value of their products, and that

the area of production extends from Washington to Florida, and from Maine to southern California.

"Unity of interest and unity of purpose," said Senator Knox, "are what constitute a meeting like this." The Senator closed with a plea for unity, commercial unity, and said that the country should unite for the benefit of the whole, and that one section should not be pitted against another.

Hon. Joseph G. Cannon, Speaker of the House of Representatives, received an ovation when he appeared in the banquet hall. He told of his boyhood days in Indiana and compared the conditions of those times with the present. Mr. Cannon's remarks were in strong opposition to President Roosevelt's aim of preserving carefully, by legislation and public administration, the natural resources of the country. Mr. Cannon ridiculed the idea of any necessity for this, and intimated that such agitation is based on ignorance. A fuller mention of Mr. Cannon's speech will be found in the editorial department of this magazine.

RESOLUTIONS

Strong resolutions were adopted, binding the National Wholesale Lumber Dealers' Association to co-operate with the Forest Service in introducing the study of forestry in the public schools, and pledging the support of the association to the bill providing for the establishment of National Forests in the Southern Appalachian and White Mountain regions. The resolutions further urge the prompt securing of a practical census of the timber of the United States; endorse President Roosevelt's untiring zeal in promoting forestry; and commend the Bureau of Entomology in the Department of Agriculture for its useful efforts in the investigation of forest and timber insects.



The Month in Government Forest Work.

What Forestry Has Done Already Many people in this country think that forestry had never been tried until the Government began to practice it upon the National Forests. Yet forestry is practiced by every civilized country in the world except China and Turkey. It gets results which can be got in no other way, and which are necessary to the general welfare.

What forestry has done abroad is the strongest proof of what it can accomplish here. The remarkable success of forest management in the civilized countries of Europe and Asia is the most forcible argument which can be brought in support of wise forest use in the United States.

The United States, then, in attacking the problem of how best to use its great forest resources, is not in the position of a pioneer in the field. It has the experience of all other countries to go upon. There is no need for years of experiment with untried theories. The forest principles which hundreds of years of actual practice have proved right are at its command. The only question is, How should these be modified or extended to best meet American conditions? In the management of the National Forests the Government is not working in the dark. Nor is it slavishly copying European countries. It is putting into practice, in America, and for Americans, principles tried and found correct, which will insure to all the people alike the fullest and best use of all forest resources.

A circular entitled "What Forestry Has Done," just published by the Forest Service, and obtainable upon application to the Forester, Washington, D. C., reviews the forest work of the leading foreign countries.

Study of Forest Taxation An exhaustive study of the forest taxation problem has been begun by the New Hampshire State Forestry Commission, in cooperation with the United States Forest Service. The study will take in all questions of forest land taxation and protection of New Hampshire forests from fire. This study is sure to be followed up with great interest by other States which are finding the tax difficulty a serious check to forest preservation. Taxation of timber land is one of the most difficult problems now before the forestry people of the country. On its right settlement depends largely the rapidity with which private owners adopt forestry principles.

At the same time that efforts are made to reduce or remove taxation from standing forests, or defer it until the harvesting of the timber crop, there are people who urge increased taxes on such property on the ground that it does not now pay its just share of the general tax burden. In Maine the tax commission appointed by the last Legislature is about to hold public hearings and it is said that the commission will be asked to recommend taxing wild land on the same basis as municipal property.

In the New York Legislature, on

the other hand, a bill has been introduced which would tax timberlands no higher than barren, unproductive land, provided the timberland is managed in a way to meet the approval of the Forest, Fish and Game Commission. The bill provides an additional tax on the stumpage value of the timber when cut. The New York bill seeks to encourage forestry as a means of increasing the wealth of the State; the Maine plan, if carried through, will powerfully discourage forestry.

The New Hampshire study has been undertaken in the belief that it will help solve what is undeniably a knotty problem. A forest taxation law which is both wise and practicable is by no means easy to draw. In Pennsylvania, a State which appreciates the value of its forests and the importance of foresighted action to prevent non-agricultural lands from becoming worthless wastes, a law passed in 1905 providing for a rebate of taxes levied upon forested lands was pronounced unconstitutional by the courts because it destroyed uniformity of taxation. On the other hand, the State of Michigan has one-sixth of its area on the delinquent tax list because the land is worthless for any purpose but growing forests and is taxed too high to be held by the owners for this purpose.

Lumber Prices Year by Year The Forest Service has just issued a sheet showing the wholesale prices of lumber year by year from 1886 to 1908. The prices on July 1, 1886, and January 1 of every year thereafter are given on twelve different kinds of lumber in the New York market, and selected kinds in Baltimore, San Francisco and Buffalo; also the market reports of the Yellow Pine Manufacturers' Association.

Luquillo Forest to Be Administered The Luquillo National Forest is the only one in the insular possessions of the United States, and while it was created in 1903, provisions for its administration were not made until early

in January of this year, when the Comptroller of the Treasury affirmed the jurisdiction of the Department of Agriculture over the forest. Mr. M. Rothkugel, of the Forest Service, has sailed for Porto Rico to investigate conditions and prepare plans. On reaching Porto Rico he will confer with Governor Post, who has been exceedingly anxious that the forest be early put under administration.

While in Porto Rico Mr. Rothkugel will select and appoint native rangers, picking men who have a thorough knowledge of forest conditions in Porto Rico. This is in keeping with the Government's policy of putting all National Forests under administration of local officers.

Many of the laws governing the regulation of the National Forests in this country will not apply to Porto Rico forests, because of the different conditions. It is expected that the Luquillo National Forest will not be put under actual administration until next fall, by which time the details of the plans will have been worked out.

The Luquillo National Forest takes in nearly 66,000 acres in the north-eastern part of Porto Rico.

Chief Inspectors' Meeting There are six inspection districts in the National Forest system of the United States. The chief inspectors of these districts meet annually for consultation with each other and the higher officers of the Service and to make estimates for the expenses for their respective districts, that the funds may be properly distributed. This meeting has just taken place in Washington. The reports show that the affairs of the forests are in excellent condition, and no changes in policy are found to be necessary.

Thirty-Six Thousand Sheep The Forest Service has recommended that the number of sheep allowed to graze on the Prescott National Forest in the Territory of Arizona, dur-

ing the season of 1908, be increased from 30,000 to 36,000 head.

This is the first year of administration on a large area which was added to the forest, and the grazing allotment has been increased to provide for all of the stock which is entitled to be grazed upon this range through regular use in the past.

Government Harvests Basket Willows The work of cutting the basket willows to supply slips for free distribution has just been begun at the Government's experimental holt at Arlington, just across the Potomac from this city. These experiments in extensive willow culture are carried on by the United States Forest Service, which distributes each year a great many cuttings, together with special instructions for growing them, to applicants in all parts of the country.

This country's willow-ware industry now has to depend on foreign growers for a great part of its supply, but each year marks an increase in the number of American holts. Willow cultivation is sometimes more

profitable than the growing of other crops.

The four varieties of approved basket willows propagated at Arlington have made an excellent growth compared with those of other holts throughout Maryland and Pennsylvania. The unfavorable weather in the spring of 1907 greatly retarded the growth of the young rods in most localities, but the holt at Arlington is so favorably situated that little or no harm was done the willows there. On the contrary, the American Green variety has made a better growth in the Government holt this year than in any previous year. The rods are long, straight and branchless.

After the rods of each plat are cut and carefully sorted into different height classes, they are tied into bundles weighing from 40 to 50 pounds and placed on their butt ends in a pit containing water from 4 to 6 inches deep. They remain in this position until the sap rises and the rods put forth new leaves. During the latter part of April and early May the bark will be removed by ordinary hand peeling. A large percentage of the rods of all varieties have been selected to make cuttings for free distribution.

THE GOVERNMENT'S HANDY MAN

Your Uncle Sam he says to me, "I want a man to ride,
To pack a hess, and shoot a few, and sleep outdoors beside;"
So I signed with him as a ranger bold, to ride the forests free,
But lands! you ought to see the stunts your Uncle Sam gave me.

It's law in the morning, science at night,
Study all day, and figger and write;
He gets high-browed work on a high-browed plan,
Does the Government's handy man.

I've broke my jaw on science names fer every tree and bark;
I've got to know fine points in law, jest like a Blackstone shark;
I've got to pick out min'ral land, same as a blained M. E.;
And this here ranger job ain't jest what it's cracked up to be.

It's readin' the Use Book early and late,
Rules by the hundred—get 'em all straight.
He'd ruther punch cows, but he does what he can,
Does the Government's handy man.

—*Denver Republican.*

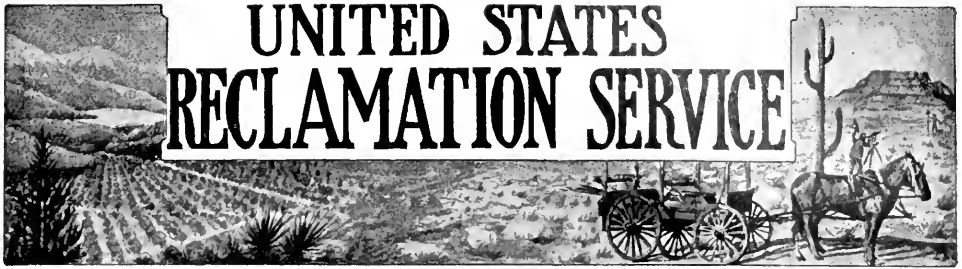

Government Irrigation Work During the Month.

Good Lands To Be Opened This Spring A number of exceptional opportunities will be offered this spring by the Government for enterprising and intelligent farmers to secure choice farms on a dozen or more large irrigation projects which are now nearing completion.

Owing to the rapid narrowing of the limits of the unoccupied public domain, it is doubtful if these opportunities will ever occur again. It is probable, therefore, that the West will see in 1908 one of the greatest influxes of homeseekers that has been witnessed in many years.

The great fertility and wonderful crop yields from irrigated lands, and the favorable terms the Government offers settlers, warrant the belief that before the year closes not a single farm will be without its entryman. These farms are located in North Dakota, Montana, Wyoming, Nevada, and Kansas.

A letter addressed to the Statistician, U. S. Reclamation Service, Washington, D. C., will secure full information concerning the location, soil, climate, crop possibilities, and terms of disposal.

In Montana For Instance Uncle Sam has 412 choice 40-acre farms in Montana which he offers to-day, on very easy terms, to practical farmers who are citizens of the United States.

These farms are in eastern Montana, in the beautiful valley of the Yellowstone River, one of the richest ag-

ricultural sections of the Northwest. Each is located within three miles of a railroad, and each is irrigated by one of the best irrigation systems in the world.

The lands lie at an elevation of 3,000 feet above sea level. The climate is delightful, the soil of exceptional fertility, producing abundant crops when watered. Wheat, oats, rye, barley and alfalfa are the principal crops grown. Alfalfa yields five tons per acre, and is selling to-day at \$5 per ton in the stack. Apples, small fruits, and vegetables do well here. An especially profitable crop is the sugar beet, which last year in the valley yielded nearly \$50 per acre net, when properly cultivated.

Detailed information concerning the available lands and terms may be obtained by addressing the Statistician, U. S. Reclamation Service, Washington, D. C.

Villages on Sun River Eleven tracts of land, mostly quarter-sections, have been withdrawn from public entry and segregated for townsite purposes in connection with the Sun River project, Montana. This segregation is for the purpose of carrying out the Reclamation Service farm village idea, which provides for a village about every six miles. On the whole Sun River project there will be nearly twenty of these little towns. No settler will be more than three or four miles from one of these villages, and he will thus be in close touch with the usual town facilities.

Payments on Garden City Land

As a sample of the requirements in connection with the opening of new land to settlement, by the Reclamation Service, and as particular information in regard to the Garden City project, in western Kansas, the following public notice of the opening of the Garden City project is given. This notice was issued about March 14th by the Secretary of the Interior:

Water will be furnished from the Garden City project in Kansas under the provisions of the Reclamation Act in the irrigation season of 1908 for the irrigable land shown upon plats of Townships 23 and 24 South, Ranges 32, 33 and 34 West, 6th principal meridian, approved March 2, 1908, by the Secretary of the Interior, and on file in the local land office at Dodge City, Kansas.

The limit of areas for which water right application may be made, for lands in private ownership, shall be 160 acres of irrigable land for each land owner.

The charges which shall be made per acre of irrigable land which can be irrigated by the waters from the said irrigation project are in two parts, as follows:

1. The building of the irrigation system, \$35 per acre of irrigable land, payable in not less than five nor more than ten annual instalments, each not less than \$3.50 per acre.

2. For operation and maintenance, which will, as soon as data are available, be fixed in proportion to the amount of water used, with a minimum charge per irrigable acre whether water is used thereon or not. The operation and maintenance charges for the irrigation season of 1908, and until further notice, will be \$2.75 per acre of irrigable land, whether water is used thereon or not, and I hereby establish the regulation that no water will be furnished in any year until the portion of the installment for operation and maintenance for the preceding years have been paid. This will apply to the irrigation season of 1909, as to these charges for 1908.

The first instalment on account of said charges, for all irrigable areas shown on these plats, whether or not water right application is made therefor or water is used thereon, shall be due at the local land office at Dodge City, Kansas, on December 1, 1908.

The portion of the instalment for the building charge for subsequent years shall be due on December 1 of each year at the same place, and until further notice the portion for operation and maintenance, \$2.75 per acre of irrigable land per annum, shall be due at the same time and place.

The charges herein provided for may, for the convenience of applicants, be paid to and received by the Special Fiscal Agent of the U. S. Reclamation Service at Garden City, Kansas, for transmission to the Receiver of the U. S. Land Office at Dodge City, Kansas, on or before the dates specified herein for payments at the local land office.

Water Users Themselves Will Manage

The charges for land and water in the Shoshone project, Wyoming, were stated in last month's issue. The Garland main canal, with a bottom width of forty feet, is practically done, as are the lateral canals, so that every settler will find an abundant supply of water delivered at the highest point of his farm. It is believed that this is the first irrigation system of such magnitude ever constructed where the farmer will have to go to no expense whatever to get the water on his land. It is proposed to arrange an organization of water users for each lateral, whereby they will operate the lateral and distributary canals themselves, thus reducing the cost of administration, the Government doing only the wholesale distribution and administration.

Soil and Weather

The drainage of these lands is unusually perfect. The surface soil is underlaid with a deep stratum of gravel, which can be depended on to carry off excess moisture and prevent waterlogging. The surface soil, how-

ever, is of satisfactory depth, and is of fine quality for growing all kinds of farm crops common to a latitude 500 miles south of this. The climatic conditions in the Shoshone basin are controlled largely by the mountain ranges which entirely surround the Shoshone and Big Horn basins. The snowfall, like the rainfall, is very limited. The weather conditions are indicated by the fact that building work on reinforced concrete structures has been carried on continuously throughout the entire winter.

Coal and Oil Deposits Handy There are abundant coal measures within teaming distance of the irrigated lands. A coal mine has been opened within the area served by the Frammie extension of the Garland canal. Also oil, in commercial quantities, has been developed in the vicinity. The oil has a paraffin base, and can be refined for illumination.

Richness of Water Power Power for all purposes will be available in great quantities from the Shoshone dam. Practically all the water to be impounded into the reservoir will be discharged under a pressure of 240 feet. Two 42-inch cast-iron pipes are being placed in the base of the dam for immediate power gen-

eration, thus insuring for the people of this project one of the most inexpensive and permanent water powers in the entire West. The power thus made available will belong exclusively to the irrigators filing on the lands, the receipts from the sale of power going naturally first to defray the cost of maintaining and operating the irrigation works; and as the power is utilized it should, and undoubtedly will, yield a substantial annual revenue, probably more than sufficient to operate and maintain the entire canal system.

The Shoshone reservoir now under construction, when completed, regulating as it will the entire discharge of the north and south forks of the Shoshone River, will provide water sufficient to cover 400,000 acres of land three feet in depth each year. The Garland canal, now under construction, is only one of four main canals which may ultimately be built.

There is not a wooden structure on the entire project. The Shoshone dam, the highest masonry dam in the world, will be of concrete masonry. The Corbett diverting dam is of concrete masonry reinforced with steel bars. This structure has an overflow weir 400 feet long, with a capacity to handle twice the greatest flood ever known in the Shoshone River.

ONIONS AS IRRIGATORS

While it is unquestionably true that irrigation water in general must come from wooded mountain slopes, it appears this is not absolutely the only source. A farmer in Ohio has made a discovery that will be of vast importance to farmers during a dry season. He has found that when onions and potatoes are planted in the same field in alternate rows the onions, being so strong, bring tears to the eyes of the potatoes in such volumes that the roots of the vines are kept moist and a big crop is raised in spite of the drought.

WITH MEMBERS AND CORRESPONDENTS

The March Magazine

Mr. Henry A. Barker, chairman of the Committee on Parks and Public Reservations, American Civic Association, wrote on March 9th:

"I want to compliment you very heartily on the March number of FORESTRY AND IRRIGATION. It is impossible to imagine any Congressman reading it through and waiting a day before calling up the Appalachian matter.

"Will you send me several more copies, as I want to distribute them to the papers in order that they may be reviewed?"

Miles Roberts, of New York, sends in a new member and asks especially that the new member receive the March issue, saying that this is the best number yet out, as it seems to him.

Improvement in Magazine

A correspondent writing from Kansas City says: "I must congratulate you on the improvement, and I think the improved appearance, you have made in FORESTRY AND IRRIGATION. I wish you and the magazine much success."

Texas to Improve Legislation

Mr. John M. Gilbert, of Beaumont, Texas, writes that an effort is being made to procure advanced forestry legislation in that State.

He has obtained copies of the forestry laws of various States, including Maryland, California, and Alabama, which are generally regarded as being the most comprehensive and practical of any which have been passed in the three sections of the country which these States respectively represent.

It is fortunate that a man of long experience and high standing among the lumbermen of Texas, such as Mr. Gilbert, is taking an active interest in this work, and it is to be hoped that his influence will bring about more conservative methods of logging in the region affected.

Practical Religion

Rev. David R. Breed, of Pittsburg, Pa., professor of practical theology in the Western Theological Seminary, wrote on March 16:

"I have been a member of the Forestry Association for some years. Next Monday morning I am to read a paper before our ministers' association on 'Reforestation—Our Supreme National Duty.'" He asked for literature to distribute at the meeting.

May not a minister, by such means, aid in establishing the "new earth in which dwelleth righteousness?"

Show Them the Opportunity

Mr. Alfred Senn, of Sheboygan, Wisconsin, sent in recently a large number of new members and the following information:

"It seems to me that with regard to private forestry the symptoms are now indicating a prosperous future in this State, and I have decided to take this kind of work. There are besides lumbermen and land companies, quite a number of wealthy people that have holdings in the northern part of this State, but none of these are under management. There are quite a number of people that ought to take up planting. All it needs is to illustrate to these people that from the economical and financial point of view, reforestation of waste land is the best and surest investment."

Both the new members and the information are appreciated.

Fighting For Her Trees

Mrs. D. M. Osborne, of Auburn, N. Y., is not only exceedingly interested in the forests at large; but has been making a fight for her own trees, with lawsuits against a telephone company which put up a line on the road without her permission and trimmed trees on her part of the way mercilessly. Half of the road belongs to Mrs. Osborne, and when she learned what was going on she drove off the workmen and cut down the poles.

Prizes for Essays

Mrs. Ruth H. Spray, of Salida, Colorado, wrote that the women's club in that city offered prizes last year to school children for the best essay on trees. This is one good way to interest the young people.

Help of Two Kinds

A new member from San Diego, California, sends his dues and says: "This is the only mite I can contribute to a public business policy that I feel sure goes to the accomplishment of much good. I send also list of names, as requested." These two mites of help may appear small to some people, but such cooperation on the part of many is what makes a movement go.

The Silver Streams No Longer Flow

Mrs. E. M. Eno Humason, of New Britain, Conn., writes that she hopes we may be permitted to see the results that will be accomplished by irrigation and forestry on our sandy deserts

and uncultivated lands in the Western States. No other improvements that can be made in our country will show greater benefit than what has already been done by these two kinds of effort. From a soil rich in itself, but waste for want of water, irrigation combined with forestry brings health and wealth, together with a country beautiful to pass through.

In our Eastern States, she adds, we see the result of the disappearance of much of our forests; the silver streams no longer flow, and the larger rivers decrease in size and power.

Paintings of Trees

Mr. R. M. Shurtleff writes from New York that the New Hampshire Society, to which he belongs, is very much interested in the work of the American Forestry Association. Mr. Shurtleff is an artist, and has painted the forests of the Adirondacks for forty years. His painting of a tree in his own woods is on exhibition in the Corcoran Gallery at Washington under the title "The First Snow."



Young black walnut near Linden, Indiana—The walnuts were scattered thickly in a potato patch and cultivated in, and then allowed to care for themselves—Trees at 23 years of age are about 30 feet high, and 3 to 6 inches in diameter



RECENT PUBLICATIONS

The Naturalist and The Civil Engineer.

This plea for the conservation of natural forces and the betterment of inland navigation was read before the Cincinnati Society of Natural History on February 4, by M. D. Burke, M. Am. Soc. C. E., and has been printed as a pamphlet. The paper may be characterized as unprofessional because it contains no technical figures or formulæ, but is a presentation of conservative conclusions, well based on accurate observations.

The Indiana State Forester's Report for 1907

has just come to hand. It tells of the work accomplished on the State forest reservation, discusses the economic problem and some experiments, and gives the Governor's Arbor Day proclamation, with articles on the observance of Arbor Day.

Recent Publications of the Forest Service:

Circular 127. Forest Tables—Western Yellow Pine.

Circular 128. Preservation of Piling against Marine Wood Borers.

Circular 132. The Seasoning and Preservative Treatment of Hemlock and Tamarack Cross-Ties.

Circular 133. Production of Veneer in 1906.

Circular 134. Estimation of Moisture in Creosoted Wood.

Circular 135. Chestnut Oak in the Southern Appalachians.

Circular 136. Seasoning and Preservative Treatment of Arborvitæ Poles.

Circular 137. Consumption of Poles in 1906.

Circular 139. A Primer of Wood Preservation.

Circular 140. What Forestry Has Done.

Circular 141. Wood Paving in the United States.

Circular 142. Tests of Vehicle and Implement Woods.

Senate Document 91. Report of the Secretary of Agriculture on the Southern Appalachian and White Mountain Watersheds.

The Superintendent of Forestry for the Dominion of Canada

makes his annual report for 1907 in a document recently received at this office. The document includes reports from the various provinces and from persons in charge of special enterprises in the lines of forestry and of irrigation. An account is given of experimentation in sowing maple and ash seed with a machine; it is hoped the results will be satisfactory. About twenty-five pages are given to a detailed account of the trip by Mr. Stewart, the late superintendent of forestry, down the Mackenzie and up the Yukon Rivers, in the year 1906.

The American Lumberman for March 14 reports an excellent and strikingly significant address by G. E. Ames, of the Puget Mill Company, Port Gamble, Washington, before a meeting of the State assessors at Seattle, Washington, upon unjust taxation of timberland. Enlightenment of assessors on this subject is a good thing.

Vick's Magazine is another periodical that is running in each issue a special featuring of one or another line of endeavor for social progress. In May it will have an Arbor Day issue, and will make efforts to co-operate with the school children in rendering Arbor Day useful.

The New Jersey Forest Park Reservation Commission.

The Third Annual Report of this body, for 1907, has just come to hand. It contains much valuable material. New Jersey has been active in forestry during the year. The report of the State fire warden, Mr. T. P. Price, is especially valuable. There has been a gradual decrease in the area burned by forest fires from 1872 to 1907, from 100,000 acres to 11,525 acres. Another fact brought out is that the fires of the past year were of comparatively brief duration. This, of itself, is evidence of little damage done and of the activity of the wardens. The State Forester, Mr. Alfred Gaskill, contributes an article on growing chestnut for profit.



**Evergreens,
Forest Trees
and Seeds.**

*Three Millions of White Pine Seedlings and
nearly one ton of Seeds.*

Red Oaks, Linden, Black Locust

ALSO SEEDS

For forest planting on sandy soil I offer
several millions Ponderosa and Jack Pines
and Northern Red Cedar, and Seeds of
same.

Northern Grown Trees and Seeds a Specialty

Mention this paper when you write.

D. HILL, Evergreen Specialist

DUNDEE, ILL.

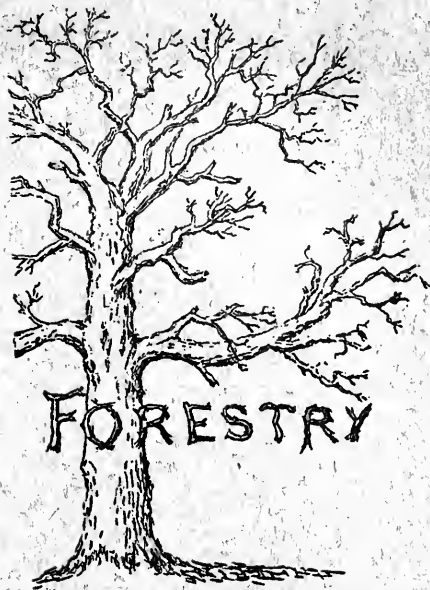

POWDER POINT SCHOOL, Duxbury, Mass.

In addition to the present work of the school, a
new preparatory course in *Forestry* is being started,
leading to the college courses in the subject. It re-
quires hard, earnest application, and develops an
appreciation of nature and power of leadership.

F. B. KNAPP, S. B.

Read "Irrigation in the United
States," by Fredrick Haynes
Newell, Director of the
Reclamation Service. Price, \$2,
postpaid to any address. Address
"Forestry and Irrigation," Wash-
ington, D. C.

ORCHIDS

ORCHIDS

We are the largest Orchid Growers
in the United States.
Our Illustrated and Descriptive
Catalogue of Orchids is now ready
and may be had on application.

Orchid Growers
and Importers

LAGER & HURRELL,
Summit, N. J.

**Economical, Reliable
RUNNING WATER SERVICE**

A constant supply wherever you want it. Automatic in
action—no expense for power or repairs. It's easy
with a



RIFE HYDRAULIC RAM

Large and small rams for Country Places,
Irrigation, Supply Tanks, Town Plants,
etc. For every foot water drops to ram it
is raised 30 ft. 7,000 in use.

Write for Free Plans and
Estimates

RIFE ENGINE CO.
2172 Triality Bldg., New York

The . . . **PAPER** . . . that this publication is printed
on is furnished by

R. P. Andrews Paper Co., Inc., Washington,

Sole Agents in the District of Columbia for the
West Virginia Pulp and Paper Company,
the Largest Manufacturers of Book Paper in
the world.

IF IN NEED, DROP THEM A LINE

In writing advertisers kindly mention **FORESTRY AND IRRIGATION**

Biltmore Forest School

Biltmore, N. C.



Theoretical and practical instruction in all branches of applied forestry.

The course comprises eighteen months; twelve consecutive months of lectures and field work, and six months of practical experience.

Object lessons within the mountain estate of George W. Vanderbilt, comprising 120,000 acres, where forestry has been practiced since 1895



For further information apply to

C. A. Schenck, Director

COLORADO SCHOOL OF FORESTRY...

Colorado Springs, Colo.

Three years' course in
**TECHNICAL AND
APPLIED FORESTRY**

Winter Term at Colorado College, Colorado Springs.
Summer Term at Manitou Park on the borders of the Pike's Peak Forest Reserve.

**TUITION, SIXTY DOLLARS
— A YEAR —**

For further particulars apply to
WM. C. STURGIS, Dean

Colorado Springs - - - - - Colo.

YALE FOREST SCHOOL NEW HAVEN, . . . CONNECTICUT

The course of study in THE YALE FOREST SCHOOL covers a period of two years. Graduates of collegiate institutions of high standing are admitted as candidates for the degree of Master of Forestry.

The Summer School of Forestry is conducted at Milford, Pike County, Penna.

For further information address

Henry S. Graves, Director, New Haven, Conn.

FORESTRY AND IRRIGATION

The President Says:

"There is no other question now before the Nation of equal gravity with the question of the conservation of our natural resources; and it is the plain duty of us who, for the moment, are responsible, to take inventory of the natural resources which have been handed down to us, to forecast the needs of the future and so handle the great sources of our prosperity as not to destroy in advance all hope of the prosperity of our descendants."

—THEODORE ROOSEVELT.



Thorburn's Seeds

Seed of *Pinus Banksiana* - \$4.00 per lb.
(Northern Jack Pine)

Seed of *Pinus Strobus* - \$1.50 per lb.
(White Pine)

Free by mail or express.

Special prices on large lots on application.
Also large line other tree and shrub seeds.
New crop imported natural grasses.
Send for 1908 catalog, ready about Jan. 1st.

J. M. Thorburn & Co.

33 Barclay Street,
Through to 38 Park Place

Established 1802

NEW YORK

This Solar can be used in hazy weather, when other Solars are useless. Used by the U. S. General Land Office.

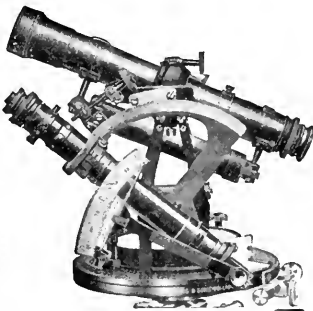

Specifications:

Needle $3\frac{1}{2}$ inches long. Graduations $4\frac{1}{4}$ inches long reading minutes. Power of telescope 20 (with splendid definition, good light, and large field). Variation plate. Level to telescope, clamp and opposing screws. Vertical arc. Fixed Stadia-hairs. Extension

Tripod. Solar Attachment on side of standards.

Price, complete \$300

Telegraph and Code Word, Mountsolar

Illustrated Catalogue upon application

YOUNG & SONS, PHILADELPHIA

THE Pennsylvania State College

A thorough and practical undergraduate course in technical forestry, preparing men for all lines of professional and applied forestry.

Special attention is paid to practical field work in surveying, mapping and forest measurements. One of the largest of the State Forest Reserves is within a short walk of the college.

For information regarding entrance requirements, expenses, etc., address

Department of Forestry

State College, Penna.

PLANE SURVEYING

*A Text-book and
Pocket Manual*

By JOHN CLAYTON TRACY, C. E.

*Ass't Professor of Structural Engineering
Sheffield Scientific School of Yale University*

16 mo, xxvii + 792 pages, illustrated
with line cuts. Morocco, \$3.00

Used in the Yale Forestry School
and just adopted in Pennsylvania
Department of Forestry :: ::

Descriptive Circular on Application

JOHN WILEY & SONS

43 and 45 E. 19th St. New York City

IMPORTANT BOOKS ON FORESTRY

PRINCIPLES AND PRACTICE OF FORESTRY

Forest Mensuration. By HENRY SOLON GRAVES, M. A. A complete text book of this important subject and the first written for American Foresters. It deals with the determination of the volume of log, tree, or stand, and with the study of increments and yields. Price, \$1.00

Economics of Forestry, The. By B. E. FERROW. This volume treats of forests and forestry from the standpoint of political economy, and is designed to furnish a trustworthy basis for formulating public policy. Price, \$1.50

First Book of Forestry, A. By FILIBERT ROTH. An outline of the general principles of forestry, written in simple, non-technical language, designed particularly for the beginner. Price, \$1.10

Practical Forestry, for Beginners in Forestry, Agricultural Students and Woodland Owners. By JOHN GIFFORD. A good general description of the principles of forestry with enough technical information to prepare the beginner. Price, \$1.40

History of the Lumber Industry of America. By J. E. DEFEBAUGH. The first authoritative work of its kind yet issued, and one which will commend its self alike to the timber owner, lumberman, lumber manufacturer, or merchant, or student of economics. In four volumes bound in half leather. \$5.00 per volume.

Forest Planting. By H. NICHOLAS JARCHOW. An illustrated treatise on methods and means of restoring denuded woodland. Price, \$1.50

Forestry. (Schwappach.) An English translation of "Forstwissenschaft." Price, 70c

Hedges, Windbreaks, Shelters and Live Fences. By E. P. POWELL. A treatise on the planting, growth and management of hedges with information concerning windbreaks and shelters. Price, 70c.

North American Forests and Forestry. By ERNEST BRUNCKEN. This volume, expository in its character, is written in a style intended for the general reader, to whom it should convey a good idea of our forests forestry. Price, \$2.00

Practical Forestry. By ANDREW S. FULLER. A treatise on the propagation, planting and cultivation, with descriptions and the botanical and popular names of all the indigenous trees of the United States, and notes on a large number of the most valuable exotic species. Price, \$1.50

Principles of American Forestry. By SAMUEL B. GREEN. Prepared especially for students in elementary forestry and for the general reader who wishes to secure a general idea of forestry in North America. Price, \$1.50

Seaside Planting of Trees and Shrubs. By ALFRED GAUT. Illustrated from photographs by FRANK STUTLIFFE. This is a new volume in the English Country Life Library. Advice regarding selection and management to get satisfactory effects under adverse influence of closeness to seashore. Price, \$1.75.

Forest Management. By C. A. SCHENCK. Describes methods here and abroad to bring the most profit from all investments made in woodlands. Price, \$1.25

Forest Mensuration. By C. A. SCHENCK. Treats conditions in U. S. from mathematical and practical standpoint. Price, \$1.25

Forest Utilization. By C. A. SCHENCK. First treatise on this in U. S. Covers logging, lumbering, sawmilling, cooperage, paper-making, and description of all industries obtaining raw material from American forests. Price, \$1.25

Biltmore Lectures on Sylviculture. By C. A. SCHENCK. Written from author's long experience as forester of the Biltmore estate, where sylviculture has been practiced on a larger scale for a longer time than anywhere else in U. S., and where results become more apparent from year to year. Price, \$2.50

Forest Policy. By C. A. SCHENCK. (Second part.) Describes the various States of the Union under following heads: Area; physiography; distribution of forests; forest ownership; use of the forest; forestry movement; forest laws; forest reservations; irrigation. Price, \$1.25

Profession of Forestry, The. By GIFFORD PINCHOT. A pamphlet containing an address on that subject by Mr. Gifford Pinchot; also an address by Mr. Overton W. Price on "Study in Europe for American Forest Students," and a list of reference publications for students. Price, 25c.

FOREIGN IMPORTATIONS

English Estate Forestry. By A. C. FORBES. An authoritative volume on English forest methods from the pen of a well known forester, that should prove of interest to Americans. Price, \$3.50

Forstwissenschaft. (Schwappach.) Price, 60c
Manual of Forestry. (Schlich.) Five volumes, complete, or separately as follows (price, complete, \$18.80):

Vol. I. "Forestry Policy in the British Empire." Price, \$2.40

Vol. II. "Sylviculture." Price, \$3.20

Vol. III. "Forest Management." Price, \$3.60

Vol. IV. "Forest Protection." Price, \$4.80

Vol. V. "Forest Utilization." Price, \$4.80

This is perhaps the most authoritative work that has been issued on the technical side of forestry, translated from the German.

Wood. By G. S. BOULGER. An important new book for arboriculturists and forestry students. A manual of the natural history and industrial applications of the timbers of commerce. Cloth. 82 Illustrations. Price, \$2.60.

Familiar Trees. By Prof. G. S. BOULGER. Written by an eminent botanical authority, yet couched in language easily understood. The coloured plates are the work of celebrated artists, and are truthful and trustworthy in every respect. A special feature is the series of photomicrographic illustrations of sections of woods. Three volumes. Price, per volume, \$1.50.

DENDROLOGY, BOTANY, AND IDENTIFICATION OF SPECIES

Manual of the Trees of North America (exclusive of Mexico). By CHARLES SPRAGUE SARGENT. A volume that presents in convenient form and with excellent illustrations, authoritative information concerning the trees of North America. It is written in a manner that enables the reader to readily find what family or species any particular tree belongs. Price, \$5.00.

American Woods. By ROMEYN B. HOUGH. A new departure in the publication of an authoritative work illustrated with actual wood sections of the various species described. Three are given of each, viz., radial, transverse, and tangential. Issued in ten parts, per part Price, \$5.00

Handbook of the Trees of the Northern U. S. and Canada, East of the Rocky Mountains. By ROMEYN B. HOUGH. Pictorial description of trees. Two pages to each species; photo-engravings of trunk, leaves, flowers or fruit, section of wood, and map of distribution, with botanical description, and brief other information. Price, in buckram, \$3.00; in half morocco, \$10.00

Flora of the Southern States. CHAPMAN. This is an excellent key to the flora of the south, complete and accurate in its scope. Price, \$4.00

Getting Acquainted with the Trees. By J. HORACE MCFARLAND. A handsome volume, copiously illustrated, and with facts accurately presented in an entertaining way. Price, \$1.75

How Plants Grow. By ASA GRAY. An understanding of the way in which a tree grows is of prime importance to the forester, and the matter here presented is accurate and authoritative. Price, \$1.00

Principal Species of Wood; Their Characteristic Properties. By CHARLES HENRY SNOW. No attempt is made to give exhaustive descriptions of species, but the author presents a mass of information designed for the use and instruction of woodworkers, etc., in a popular style. A host of concise information is brought under each head, and the work is a valuable one. Price, \$3.50.

Manual of Botany. By ASA GRAY. A key to the flora of the northeastern states, and the most authoritative publication of its nature.

Price, \$1.62; field edition, \$2.00

Trees of New England. By L. L. DAME and HENRY BROOKS. This book is a small volume which can be easily put in the pocket and carried in the woods, and at the same time is the best guide to the identification of our New England trees of any of the smaller books yet published. Price, \$1.50

Trees of Northeastern America. NEW-HALL. A good general check list of the more important trees of the northeastern United States.

Price, \$1.75

Trees and Shrubs. By C. S. SARGENT. The most thorough and authoritative publication yet issued, and a standard work. The matter is issued in parts, of which there are three already published.

Price, per part, \$5.00

Trees, Shrubs and Vines of the Northeastern United States. By H. E. PARKHURST. In this book the author describes the trees, shrubs, and vines of the northeastern United States in a popular way, the book being designed especially for persons who have never studied botany. To these it will appeal as a valuable guide to a familiarity with the salient characteristics of trees, shrubs and vines.

Price, \$1.50

Trees. A handbook of forest botany for the woodlands and the laboratory. By H. MARSHALL WARD. Vol. I, Buds and twigs. Vol. II, Leaves. Vol. III, Flowers and inflorescences. Three volumes to be added, on Fruits and seeds, Seedlings, Habit and conformation of the tree as a whole.

Price, per volume, \$1.50

PARTICULAR SPECIES AND LOCALITIES

Mountains of California, The. By JOHN MUIR. No other person is so well fitted to write of the mountains of California as John Muir, and the volume presented here describes not only the mountains themselves but the trees that clothe them and the wild life which they harbor.

Price, \$1.85

BOOKS ON IRRIGATION AND DRAINAGE

Irrigation in the United States. By F. H. NEWELL. The most authoritative and complete work on the subject which has yet been published, by the head of the Government's irrigation work.

Price, \$2.00

Irrigation Farming. By L. M. WILCOX. A newly revised edition of one of the standard works on irrigation. The principal chapters treat very fully of irrigation, its application, etc., and the volume is profusely illustrated.

Cloth, \$2.00

Irrigation for Farm, Garden and Orchard. By HENRY STEWART. This work is offered to those American farmers and other cultivators of the soil who, from painful experience, can readily appreciate the losses which result from the scarcity of water at critical periods.

Price, \$1.00

Irrigation and Drainage. By F. H. KING. While most of the existing books on these subjects have been written from engineering or legal standpoints, this one presents in a broad yet specific way the fundamental principles which underlie the methods of culture by irrigation and drainage.

Price, \$1.50

Irrigation Institutions. By ELWOOD MEAD. A discussion of the economic and legal questions created by the growth of irrigated agriculture in the West, by the Chief of Irrigation and Drainage Investigations of the Department of Agriculture.

Price, \$1.25

Land Draining. By MANLY MILES. A handbook for farmers on the principles and practise of draining, giving the results of his extended experience in laying tile drains.

Price, \$1.00

Land of Little Rain, The. By MRS. MARY AUSTIN. A nature book of the highest type. The volume is made up of a series of sketches of the human, animal, and plant life found in the region of the Mohave desert, Death Valley, and the Sierras, much of which the average person is likely to consider almost devoid of living things.

Price, \$2.00

Our National Parks. By JOHN MUIR. If you want to learn about the glaciers, mountain peaks, canyons and great waterfalls of the West; of the habits of animals from the squirrel to the moose; plant life from the big trees to the wild flowers—in fact be brought face with nature's works, this is the book.

Price, \$1.85

Trees and Shrubs of Massachusetts. EMERSON. Two volumes. Plain cloth edition has 148 plates. The colored edition has 36 of these in colors.

Price, plain, \$12.00. Price, colored, \$13.00.

The Earth as Modified by Human Action. By G. P. MARSH. A Revision of Man and Nature. Describes changes in the face of the earth caused by man, including desolation of various countries, once thickly inhabited, by removal of forests. Shows importance of maintaining natural balance of forces.

Price, \$3.50

The Longleaf Pine in Virgin Forest. A Silvicultural Study. By G. FREDERICK SCHWARZ. This is a study of the life history of this important forest tree. Intended primarily for foresters and forest students; also for owners and managers of pine timber lands. Deals with the preference or dislike of the species for particular conditions of soil, climate, and environment. Illustrations and six tables.

Price, \$1.25

The Sprout Forests of the Housatonic Valley of Connecticut. By G. F. SCHWARZ. Illustrated study of forests repeatedly cut over.

Price, 35c

IMPORTATIONS

Beautiful Rare Trees and Plants. By the EARL OF ANNESLEY. A description of some of the rarer English trees, shrubs and vines, illustrated copiously.

Price, \$12.00

Forests of Upper India and Their Inhabitants. By THOMAS W. WEBBER. This volume is an account of the author's life in India during the period shortly after 1857. It contains a vivid description of the country, its people, customs, etc., with some description of its forests and timber wealth.

Price, \$5.00

IRRIGATION ENGINEERING AND CONSTRUCTIVE WORK

Design and Construction of Dams. By EDWARD WEGMANN. This volume includes an authoritative discussion of the constructive work involved and the principal forms of construction. Masonry, rock-fill and timber dams are discussed extensively.

Price, \$6.00

Improvement of Rivers. By B. F. THOMAS and D. A. WATT. This volume is a treatise on the methods employed for improving streams for open navigation and for navigation by means of locks and dams.

Price, \$6.50

Irrigation Engineering. By HERBERT M. WILSON. This is the fourth edition of Mr. Wilson's popular work, and the revision and enlargement which it has undergone, places it at the forefront of text books on the subject for American students.

Price, \$4.00

Engineering for Land Drainage. By C. G. ELLIOTT. A manual for laying out and constructing drains for the improvement of agricultural lands.

Price, \$1.50

Reservoirs for Irrigation, Water-power, and Domestic Water-supply. By JAMES DIX SCHUYLER. An account of various types of dams and the methods and plans of their construction, together with a discussion of the available water-supply for irrigation in various sections of arid America, distribution, application, and use of water; the rainfall, runoff, and evaporation from reservoirs, and effect of silt, etc.

Price, \$5.00

Water Supply Engineering. By A. PRESCOTT FOLWELL. A treatise on the designing, construction and maintenance of water-supply systems, both city and irrigation.

Price, \$4.00

Water Power. By JOSEPH P. FRIZELL. An outline of the development and application of the energy of flowing water. Price, \$5.00

Concrete, Plain and Reinforced. By FREDERICK W. TAYLOR and SANFORD E. THOMPSON. Designed for practicing engineers and contractors; text and reference book for students. Discusses materials, processes, and applications of concrete in construction and specifications. Price, \$5.00

Hydraulics. By MANSFIELD MERRIMAN. Purpose of book is to keep abreast of modern progress, and present subject with conciseness and clearness. Gives general principles and discusses flow of water through various kinds of openings and channels. Historical notes and references. Price, \$5.00

BOOKS ON RELATED SUBJECTS

Utilization of Wood Waste by Distillation.—By Walter B. Harper. An important treatise on a subject regarding which the interest is great and the information scarce. Is intended to aid in the establishment and conduct of wood distilling enterprises on a business basis. Price, \$3.00

Handbook of Timber Preservation. By SAMUEL M. ROWE. Intended as a complete practical guide for the operator of a preservation plant, with hints on construction thereof. Price, \$4

In Forest Land. By DOUGLAS MALLOCH. The humor, sentiment and philosophy of the lumber business interpreted by the "Lumberman Poet." A kind of touch with the great outdoors that few books contain. Illustrated in tint, bound in silk cloth and gold stamped. Ideal for gift or library. Price, 1.25

The Garden

Roses and How to Grow Them. By many Experts. In text, practical; in subject and quality of illustrations, beautiful. Price, \$1.20

Ferns and How to Grow Them. By G. A. WOOLSON. The growing of hardy ferns, both in the garden and indoors. Price, \$1.20

Lawns and How to Make Them. By LEONARD BARRON. For the first time the subject of lawn seed mixtures is set forth and explained. 32 photographs. Price, \$1.20

How to Make School Gardens. By H. D. HEMENWAY. This suggestive little book is a practical manual of school gardening for both teacher and pupil, and supplies the first adequate work of the sort in this country. There are to-day a hundred thousand school gardens in Europe, and the progress of the recent movement in America has been most rapid. This volume is based on actual experience (the author is an authority and director of the Hartford School of Horticulture). Illustrations, 10. Price, \$1.10

How to Make a Fruit Garden. By S. W. FLETCHER. An eminently practical work on the subject of fruits for the home. With 182 photographic illustrations by the author. Price \$2.25

How to Make a Flower Garden. A charming and a practical book by experts on every branch of the subject. More than 200 beautiful photographs. Price, \$1.75

How to Make a Vegetable Garden. By EDITH L. FULLERTON. The only adequate book on the home vegetable garden. 250 photographs by H. B. Fullerton. Price, \$2.20

Art and Craft of Garden Making. By THOMAS H. MAWSON. Third edition of this standard; out of print for a year, and now reissued in revised form. Over 100 plans and details of gardens. Methods employed by successful designers carefully analyzed. Characteristic sites in typical districts described and pictured. Price, \$15.00

The Home and Farm

The Country House. By CHARLES EDW. HOOPER. A practical manual of home building, absolutely invaluable to everyone with a country place. It covers every branch of the subject in detail and treats of the garden and its furnishings in connection with the dwelling. 380 photographs and plans. Price, \$3.30

Three Acres and Liberty. By BOLTON HALL. Description of what can be accomplished on a small place in the way of gardening, home-making, and addition to financial resources. Were it not for the unimpeachable authorities quoted, its statements as to the possibilities of the "Little Lands" for a living would seem fanciful. Price, \$1.85

Foundations. By W. M. PATTON. A practical treatise explaining fully the principles involved. Numerous descriptions of important modern structures are given in sufficient detail. Includes articles on use of concrete in foundations. Price, \$5.00

Masonry Construction. By IRA O. BAKER. Contains results of a great number of experiments, and a large amount of practical data on cost of masonry, pile driving, foundations, culverts, etc., and 97 tables to facilitate estimating. Price, \$5.00

Reinforced Concrete. By ALBERT W. BUEL and CHARLES S. HILL. A treatise for designing and constructing engineers, governed by American practice and conditions. Theoretical discussions omitted, and replaced by practical working formulas, examples of representative structures, and records of practice. Price, \$5.00

The Making of a Country Home. By J. P. MOWERAY ("J. P. M."). This delightful story showed its universal appeal when published serially, and the volume amply carries out the intention of the author. Besides its practical interest for the thousands of city dwellers who have dreamed of having a country home, the story is one of such reality, humor, and interest as to ensure it the widest circulation in book form. Elaborately decorated. \$1.65

The First Book of Farming. By CHARLES L. GOODRICH. No one interested in farming, old or young, can fail to appreciate this book, for it really gives the fundamental knowledge of how to conduct a farm with the least expense and the largest return. There are 63 full pages of helpful illustrations. The price is extremely low for a work of such value. 63 pages of photographs. Price, \$1.10

Nature Books

American Food and Game Fishes. By DAVID STARR JORDAN and B. W. EVERMANN. Fills a long-felt need in popular scientific works, being a full account of the life-histories and methods of capture of North American food and game fishes. The only book in existence which will enable the amateur readily to identify species new to him. With 10 lithographed color plates, 100 photographs of live fish in the water, and 200 text cuts. Price, \$4.40

Nature Biographies. By CLARENCE M. WEED. This volume is a sort of personal acquaintance with the lives of the more common butterflies, moths, grasshoppers, flies, and so on, the sort of fascinating details of these insect existences which make the reader want to go out and study these every-day marvels for himself. 150 photographic illustrations. Price, \$1.50

The Brook Book. By MARY ROGERS MILLER. A brook is one of the most living and companionable features of the landscape, and few people, even the most ardent nature lovers, realize what an endlessly interesting study its changes and its throbbing life afford. It is a fascinating subject which the author (well known as a teacher, lecturer, and writer connected with the Nature Study Bureau at Cornell) handles with much ability. 16 photographs. Price, \$1.50

Outdoors. A Book of the Woods, Fields and Marshlands. By ERNEST MCGAFFEY. Papers on out of doors, showing a love of nature and keenness of observation and power and beauty of description rarely surpassed. Price, \$1.55

Nature and The Camera. By A. RADCLIFFE DUGMORE. Mr. Dugmore is an expert in the new movement of photographing live birds, animals, fish, flowers, etc. His works brought him so many requests for information, that he has set down here a full and detailed account of his methods. From the choice of a camera to questions of lighting, and to the problem of "snapping" shy birds and animals in their native haunts, every step is explained so simply as to be easily comprehended, even by the beginner. 53 photographic illustrations. Price, \$1.50

THE American Forestry Association

Officers for 1908

President

HON. JAMES WILSON, Secretary of Agriculture

Vice-Presidents-at-Large

DR. EDWARD EVERETT HALE	DR. B. E. FERNOW	
N. J. BACHELDER	GEO. FOSTER PEABODY	GEO. C. PARDEE
RUTHERFORD P. HAYES	ALBERT SHAW	
W. W. FINLEY	J. T. ROTHROCK	
GEO. T. OLIVER	CHARLES R. VAN HISE	

Advisory Board Selected by Affiliated Organizations

SILAS W. GARDNER	H. H. WHELESS	
JAMES INNES	C. H. KEYS	ROBERT C. LIPPINCOTT
GEORGE F. CRAIG	C. A. SMITH	
GEORGE E. STONE	ALLEN CHAMBERLAIN	D. E. KLINE
E. F. SAWYER	F. E. WEYERHAEUSER	KENT SHEPPARD
W. W. KNOX	A. L. HAYES	FREDERICK S. UNDERHILL
ROBERT L. LIPPINCOTT	W. R. ANDERSON	ROBERT A. JOHNSON

Members of Board Designated as Vice-Presidents of Association

N. W. McLEOD	LEWIS DILL	J. T. WYLIE
WILLIAM IRVINE	EDWIN A. START	D. E. KLINE
GEORGE H. HAMPTON	SAMUEL B. VROOMAN	B. W. PORTER

Secretary, THOMAS ELMER WILL, Washington, D. C.

Assistant Secretary, FRANK GLOVER HEATON, Washington, D. C.

Treasurer, OTTO LUEBKERT, Washington, D. C.

Directors

JAMES WILSON	WILLIAM L. HALL	W. J. MCGEE
GEO. P. WHITTLESEY	GEORGE K. SMITH	PHILIP W. AYRES
JAMES H. CUTLER	WILLIAM S. HARVEY	ROBERT GARRETT
HENRY S. GRAVES	H. A. PRESSEY	LIGON JOHNSON
F. H. NEWELL	ASBURY F. LEVER	FILIBERT ROTH

Application for Membership

To THOMAS ELMER WILL,

Secretary American Forestry Association

1311 G Street, N.W., Washington, D. C.

Dear Sir: I hereby signify my desire to become a member of the American Forestry Association. Two Dollars (\$2.00) for annual dues are enclosed herewith.

Very truly yours,

Name _____

P. O. Address _____

. . T H E . .
AMERICAN FORESTRY ASSOCIATION

President—HON. JAMES WILSON,
Secretary of Agriculture.

The American Forestry Association was organized in 1882, and incorporated in January, 1897. It now has nearly 7,000 members, residents of every State in the Union, Canada, and foreign countries. From its origin it has been the tireless friend of the forests.

The object of the Association is to promote the preservation, by wise use, and the extension of the forests of the United States; its means are agitation and education; it seeks to encourage the application of forestry by private owners to forest holdings, large or small; and it favors, especially, the establishment and multiplication of National and State forests, to be administered in the highest interests of all.

The Association seeks as members all who sympathize with its object and methods, and who believe that our natural resources constitute a common heritage, to be used without abusing and administered for the common good. Seeking to conserve our supplies of wood and water, the Association appeals especially to wood-producers and users, including owners of wood lands, lumbermen, foresters, railroad men, and engineers; and to those dependent upon equable stream flow, as manufacturers, irrigators, employers of water power, and those engaged in internal commerce.

The Association meets annually in Washington. It publishes, monthly, FORESTRY AND IRRIGATION, the magazine of authority in its special field. The list of contributors to this publication includes practically all persons prominent in forest work in the United States, making it alone worth the cost of Annual Membership in the Association.

The dues, covering a subscription to FORESTRY AND IRRIGATION, are as follows: Annual—For Annual Members, \$2; for Sustaining Members, \$25; Total, with exemption from all other payments—for Life Members, \$100; for Patrons, \$1,000.

THOMAS ELMER WILL, Secretary.

Address: 1311 G Street, N. W., Washington, D. C.

FOR SALE

SET OF

SARGENT'S SILVA OF NORTH AMERICA

Fourteen volumes in original boxes. Cost \$350 net; offered at \$265 net. Also a number of books on FORESTRY and BOTANY. Address

W. W. ASHE

Forest Service Washington, D. C.

Philippine Bureau of Forestry

WANTED—Two foresters with field experience. Minimum salary \$1600. Travel expenses allowed, also liberal leave privileges.

At least seven months interesting field work per year.

For information concerning travel allowances to Manila, Civil Service rules, health conditions, in fact any information in regard to the Islands, apply to the **Bureau of Insular Affairs**, War Department, Washington, D. C.

Timber Tract for Sale

FOR SALE—Valuable tract of Spruce, Fir, Hemlock, and Cedar Timber, located in Washington State. 200,000,000 feet of standing timber; railroad, cars, engines, mills, kilns, tools, supplies, etc. Price, \$500,000; half cash. FENWICK & SPEIDEL Co., Buffalo, N. Y.

HARVARD UNIVERSITY

Graduate School of Applied Science and Lawrence Scientific School

offer graduate and undergraduate courses in Civil, Mechanical, Electrical, Mining and Metallurgical Engineering, Architecture, Landscape Architecture, Forestry, Physics, Chemistry, Biology and Geology.

For further information, address W.C. SABINE, 15 University Hall, Cambridge, Mass.

Make Your Unproductive Land Profitable

Hundreds of acres too far away from the great irrigation canals can be made profitable at small expense. You can have running water in your house and at your barn. The only things necessary are a running stream or spring on any part of your ground and the installation of a

NIAGARA HYDRAULIC RAM

The U. S. Government is using this pump for irrigation purposes, because it does such good work. It's cheaper than a windmill or gasoline engine. Works continuously without cost. Send for booklet B, and guaranteed estimate. We furnish towers and tanks.

NIAGARA HYDRAULIC ENGINE CO., 140 Nassau St., New York. Factory, Chester, Pa.



Nominations for Membership

The activities of the National Office of the American Forestry Association are limited chiefly by its resources. These are derived almost wholly from its members in the form of dues. Every member is urged to aid in increasing the membership. Kindly fill out the enclosed blank form, lengthening the list, where possible, by attaching and filling blank sheet. The list should then be sent to

THOMAS E. WILL,

Secretary American Forestry Association,

1311 G Street, Northwest, Washington, D. C.

I hereby nominate the following persons for membership in The American Forestry Association :

Name

Address

.....

Signed

JUST PUBLISHED

Our Trees

How to Know Them

Photographs from Nature By ARTHUR I. EMERSON

With a guide to their recognition at any season of the year and notes on their characteristics, distribution and culture

By Clarence M. Weed, D. Sc.

Teacher of Nature-Study in the Massachusetts State Normal School at Lowell.

The purpose of this book is to afford an opportunity for a more intelligent acquaintance with American trees, native and naturalized. The pictures have in all cases been photographed direct from nature, and have been brought together in such a way that the non-botanical reader can recognize at a glance either the whole tree or the leaves, flowers, fruits, or winter twigs, and thus be able to identify with ease and certainty any unknown trees to which his attention may be called.

One hundred and forty illustrations.
Size of book, 7 1/2" x 10".
Cloth, \$3.00 net. Post-paid, \$3.20.

J. B. LIPPINCOTT COMPANY
PUBLISHERS PHILADELPHIA



BANNERMAN Army Auction Bargains

Tents - \$1.90 up	Old Pistols - \$.50 up
Rifles - 1.95 "	Officers' Swords, new \$1.75 "
ARMY SADDLES 3.00 "	Cavalry Sabres " 1.50 "
" Bridles - 1.00 "	UNIFORMS " 1.25 "
" Leggings, pr. .15 "	7 Shot Carbine " 3.50 "

1907 MILITARY ENCYCLOPEDIA CATALOGUE, 260 large pages, containing thousands of beautiful illustrations—available in wholesale and retail prices at 15 acres **GOVT. AUCTION SALE GOODS**, mailed for 15 cents (stamp).

FRANCIS BANNERMAN, 501 Broadway, NEW YORK

Text Books on Conservation

¶ If you are interested in any of the phases of conservation, read the list of publications carried in stock by FORESTRY AND IRRIGATION . . .

STUDENTS

will find this list invaluable. Let us know what you want. We can fill your order. Address

FORESTRY AND IRRIGATION

1311 G STREET
WASHINGTON, D. C.

To Friends of Conservation!

¶ FORESTRY AND IRRIGATION is preparing to inaugurate an aggressive subscription campaign. The time is ripe—interest in all branches of conservation was never so intense as now—the public is awakening to the gravity of present conditions. We offer

...Dignified Employment...

with good pay to those who work for this magazine.

STUDENTS IN FORESTRY SCHOOLS

are especially wanted. Attractive rates, the highest cash commission, and a magazine of authority in its field. These make our proposition a good one for young men wishing to earn money during the summer vacation.

Will You Join Us?

For sample copies, terms, etc., address

Forestry and Irrigation

1311 G Street, N. W.

Washington, D. C.

ANNOUNCEMENT

TO THE MEMBERS AND FRIENDS OF THE
AMERICAN FORESTRY ASSOCIATION AND
READERS OF "FORESTRY AND IRRIGATION"

THE June issue of this Magazine will be the "Conference Number." It will contain a complete, accurate and live story of the White House Conference, to be held in Washington on May 13, 14, and 15.

Located at Washington, and with the facilities at its command, FORESTRY AND IRRIGATION will be enabled to present to the reading public the first and most authentic account, in full, of this tremendously important gathering of the country's leading public men. For this reason, FORESTRY AND IRRIGATION'S June issue should be in the hands of every **thinking** American—every American citizen who is interested in the welfare, present and future, of his country.

To bring this about, it has been decided to make the following

SPECIAL OFFER

The regular price of single copies of FORESTRY AND IRRIGATION is ten cents, but to those ordering copies of the June issue in numbers the price has been made—

In Lots of 10 to 100 . . . 7 Cents per Copy

In Lots of more than 100 . . . 6 Cents per Copy

These prices include carriage charges.

Members of the Association, readers of the Magazine, and friends of the Conservation movement can help in the program of popular education by ordering copies of the June issue for circulation among those likely to become interested in this most important problem.

Orders should be sent in at once, so that provision may be made for those who will help in this work. A large number of extra copies will be printed, but we cannot guarantee to fill orders that reach this office later than May 20. Send all orders to : : : : :

FORESTRY AND IRRIGATION
Thos. E. Will, Sec'y, Washington, D. C.

FORESTRY AND IRRIGATION

THOMAS ELMER WILL Editor
 FRANK GLOVER HEATON Associate Editor

CONTENTS FOR MAY, 1908

	PAGE.
EAST ROOM OF WHITE HOUSE	<i>Frontispiece</i>
THE WHITE HOUSE CONFERENCE. (<i>Illustrated</i>)	235
"THE GOVERNORS SAY"	240
THE HILL MAN'S LAMENT. (<i>Poem.</i>) By Arthur Chapman	242
WORK IN A NATIONAL FOREST. By Charles Howard Shinn	243
EDITORIAL:	
Some Criticisms Considered.....	251
Forests of Korea to be Protected....	253
Trust to be Probed.....	254
Government to Try Siberian Legumes	255
Startling Words of Timber Expert...	255
Engineering Experiment Stations	257
A Notable Conference..... 248	
The Woods We Have..... 249	
Interrelation of Phases..... 250	
The Appalachian Bill..... 250	
AMERICA'S GREATEST IRRIGATION SCHEME. (<i>Illustrated</i>) By Agnes Dean Cameron	258
WASTE OF NATURAL RESOURCES, AND NEED FOR CONSER- VATION. By Mrs. Lydia Adams-Williams	266
THE SPENDTHRIFT. (<i>Poem.</i>) By Robert M. Reese	269
NEWS AND NOTES:	
Reports Successful Initial Year.....	275
Colorado Farmers Want Forests.....	276
How Can Irrigation be Improved?....	276
Manufacturers Take Note of Forestry	277
Mrs. Williams to Speak at Boston...	277
A Labor of Love.....	277
Argentine Republic to Protect For- ests	277
Lumber Losses from Fire.....	278
Widening Interest in Conservation... 270	
Upholding the Government..... 270	
Floods 273	
Disastrous Flood in China..... 274	
Peat Briquettes for Mexico's Fuel... 274	
Better Figures on Tree Growth Soon Available 275	
THE CRY OF THE PINES. (<i>Poem.</i>) By Anne McQueen	278
WITH MEMBERS AND CORRESPONDENTS:	
Southern Timber is Almost Gone.... 279	280
Is Much Appreciated 279	280
Prevention of Forest Fires..... 279	280
Range of Topics Treated.....	280
Kentuckians Becoming Interested....	280
Recognize Value of Forestry.....	280
THE BRAVE OLD OAK. (<i>Poem.</i>)	280
AN INLAND WATERWAYS SYSTEM. By Dr. Clarence B. Edwards	281
TREES. (<i>Poem.</i>) By Marion Elza Dodd	283
IN THE DEPARTMENTS:	
Change in Boundaries of National Forests	286
Cheap Cement Production.....	287
Y. M. C. A. and Reclamation Service..	287
Division of Bowl Creek.....	288
Co-operative Construction	288
Interest in Reclamation Work.....	288
Irrigation in Republican River Valley, Nebraska 284	
The Los Angeles Aqueduct..... 284	
Survey Work in Luquillo National Forest 286	
RECENT PUBLICATIONS	289

FORESTRY AND IRRIGATION is the official organ of the American Forestry Association. Price, \$2.00 per year, including Annual Membership in the Association. Copyright, 1908, by The American Forestry Association. Entered at the Postoffice at Washington, D. C., as second-class mail matter.

Published Monthly at
 1311 G STREET, N.W. WASHINGTON, D. C.

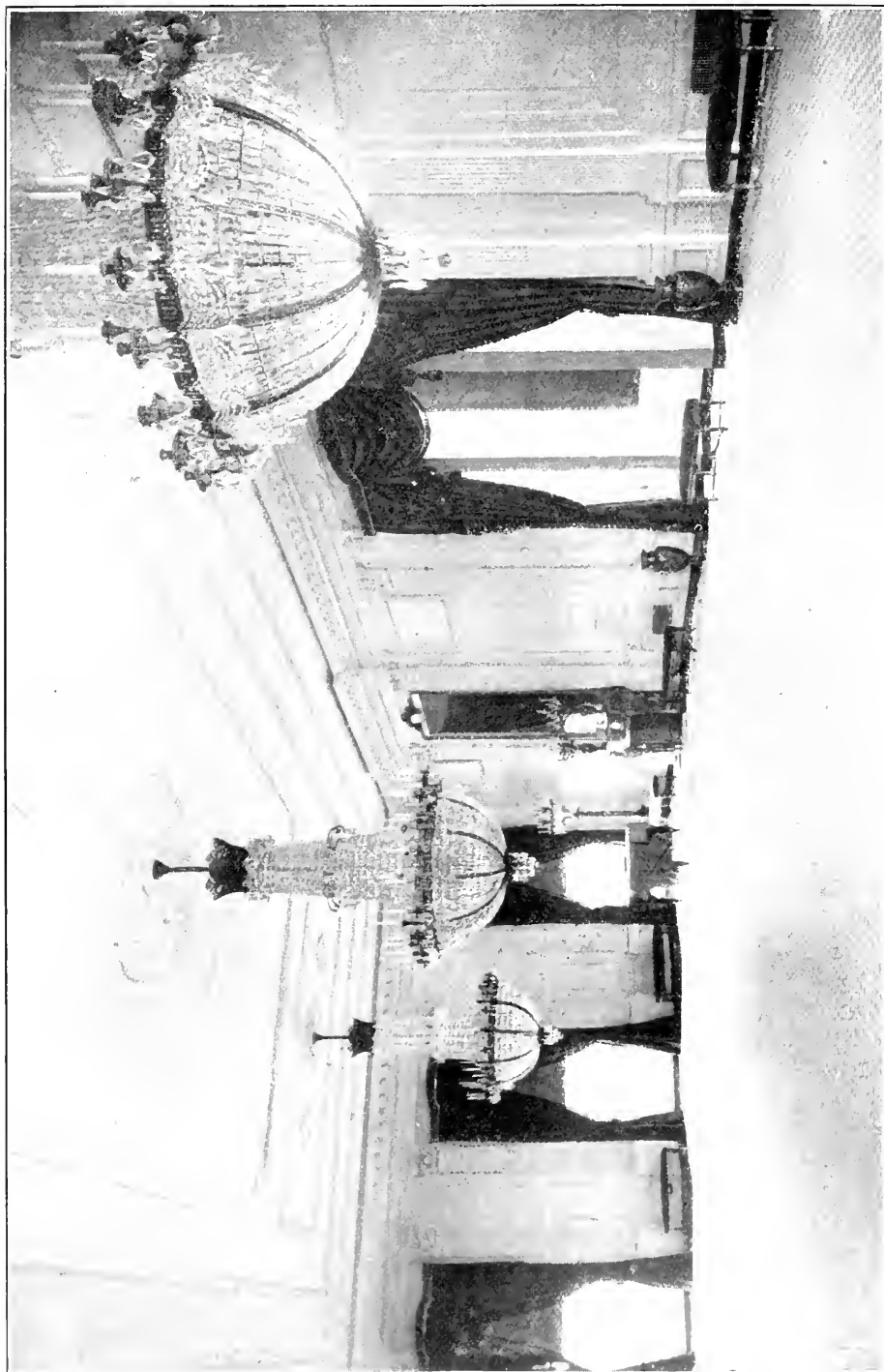

EAST ROOM OF THE WHITE HOUSE
Where the Conference of the Governors Will be Held, May 13, 14 and 15

FORESTRY AND IRRIGATION

VOL. XIV

MAY, 1908

No. 5

THE WHITE HOUSE CONFERENCE

Gathering of the Governors in May---Most Important Conference
in Country's History---Problems to Be Considered
---Makeup of the Assembly

LIBRARY
NEW YORK

ON MAY 13, when President Roosevelt calls to order the opening session of the "Conference of Governors," a new era in the history of the country will have begun. In the East Room of the White House, at Washington, on that day, will assemble the most dignified and the most thoroughly representative gathering of the nation's leading public men ever brought together; and upon the results of their deliberations hangs the weighty question of American supremacy in the fields of manufacture, agriculture, mining, lumbering, and the hundreds of kindred industries that are dependent upon one or another of the various natural resources of the land.

It is not putting it too strongly to say that never in the country's history has so important a convention been held, and that never before have questions of equal gravity been discussed in any national conference, either in the United States or any other country of the world. Questions that vitally affect every individual in the whole

length and breadth of the land will form the basis of the Conference's discussions, and upon the results obtained will depend, in large measure, the prosperity of the present generation, and in vastly larger measure the prosperity and happiness of the generations to come.

The causes that have led to the calling of this Conference by President Roosevelt are too well known to require repetition. It is sufficient to say that, having become seriously alarmed over the continued destruction of the country's standing timber, the waste of coal, etc., in mining operations, the annual recurrence of disastrous floods, with their concomitants of tremendous destruction of property and loss of life, and the pressing importance of finding ways to prevent such destruction, loss and waste, President Roosevelt has called into consultation the Governors of all the States, together with three advisors to each Governor, and representatives of the great national organizations whose continued welfare and prosperity is gravely men-

MAY 13, 1908

aced by a continuance of the present typically American heedless wastefulness.

In addition to the Governors and their advisors, and the delegates from the great national associations, the President has invited six special guests who are expected to lend their aid and advice in the deliberations of the Conference. The six are:

Hon. Grover Cleveland, former President of the United States; Hon. William Jennings Bryan, Mr. Andrew Carnegie, Mr. John Mitchell, former President of the United Mine Workers of America; Mr. James J. Hill, President of the Great Northern Railway; Dr. Albert Shaw, editor of the *Review of Reviews*.

These six gentlemen are expected to take an active part in the advisory work of the Conference. Mr. Carnegie, from his long association with and intimate knowledge of the iron and steel business, is peculiarly fitted to discuss the various phases of the iron-mining industry. Mr. Hill has been chosen to discuss the transportation side of the general economic proposition of national conservation and proper utilization of resources. Mr. Mitchell knows the coal mining industry as perhaps no other man in the United States knows it, and he has, besides, the mental equipment necessary for a logical presentation of the subject, either in written article or in speech.

Mr. Cleveland, Mr. Bryan, and Dr. Shaw are men who, from their breadth of understanding and their ability to grasp big questions of national importance, will be able to add much to the general discussion of the various phases of the problem of conservation. It is considered possible, however, in view of his continued ill-health, that Mr. Cleveland will not be able to attend the Conference, though it is hoped that he will sufficiently improve to make his presence possible.

The list of associations and societies that will be represented at the Conference covers practically every field of scientific and industrial endeavor.

The list follows:

American Association for the Advancement of Science, President, T. C. Chamberlain, University of Chicago, Chicago, Ill.

American Academy of Political and Social Science, President, L. S. Rowe, University of Pennsylvania, Philadelphia, Pa.

American Bar Association, President, J. M. Dickinson, Park Row, Chicago, Ill.

American Chemical Society, President, Marston T. Bogart, Columbia University, New York.

American Civic Association, President, J. Horace McFarland, Harrisburg, Pa.

American Economic Association, President, Simon Patton, Philadelphia, Pa.

American Federation of Labor, President, Samuel Gompers, 432 G street, Washington, D. C.

American Forestry Association, President, Hon. James Wilson, Secretary of Agriculture.

American Institute of Electrical Engineers, President, Henry G. Stott, 600 W. 59th street, New York City.

American Medical Association, President, Dr. Jos. D. Bryant, 32 W. 48th street, New York.

American Institute of Mining Engineers, President, John Hayes Hammond, New York City.

American National Livestock Association, President, J. A. Jastro, Bakersfield, Cal.

American Newspaper Publishers' Association, President, Herman Ridger, *Staats-Zeitung*, New York.

American Public Health Association, President, Dr. Charles H. Lewis, 217 N. Wilmington st., Raleigh, N.C.

American Pulp and Paper Association, President, David S. Cowles, 309 Broadway, New York City.

American Railway Association, President, W. C. Brown, New York City.

American Railway Engineering and Maintenance of Way Association, President, Walter G. Berg, 143 Liberty street, New York City.

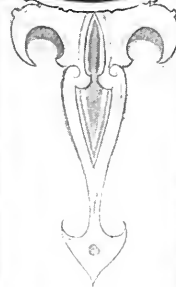
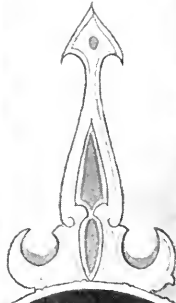
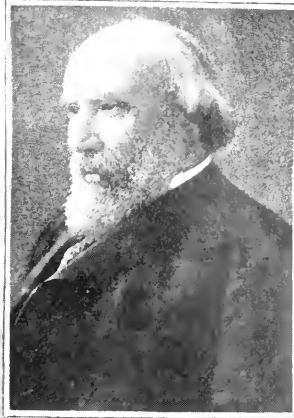

HON. GROVER CLEVELAND

Andrew Carnegie
John Mitchell

James J. Hill
Hcn. William Jennings Bryan

American Railway Master Mechanics' Association, President, Wm. McIntosh, Central R. R., Jersey City, N. J.

American Society of Civil Engineers, President, Chas. MacDonald, 220 W. 57th street, New York City.

American Society of Mechanical Engineers, President, M. L. Holman, 29 W. 39th street, New York.

American Society for Testing Materials, President, Chas. B. Dudley, Altoona, Pa.

American Statistical Association, President, Hon. Carroll D. Wright, Washington, D. C.

Atlantic Deep Waterways Association, President, J. Hampton Moore, U. S. House of Representatives.

Association of Agricultural Colleges and Experiment Stations, President, J. L. Snyder, Lansing, Mich.

Business Men's League, President, James E. Smith, St. Louis, Mo.

Chautauqua Institute, President, Dr. George H. Vincent, University of Chicago, Chicago, Ill.

Farmers' National Congress, President, B. Cameron, Stagville, N. C.

General Federation of Women's Clubs, President, Mrs. Sarah S. Platt Decker, 1550 Sherman avenue, Denver, Colo.

Geological Society of America, President, Samuel Calvin, Iowa City, Iowa.

Interstate Inland Waterway, President, C. S. E. Holland, Victoria, Tex.

Interstate Mississippi River Improvement and Levee Association, President, Chas. Scott, Rosedale, Miss.

Lake Carriers' Association, President, William Livingston, Detroit, Mich.

Lakes-to-the Gulf Deep Waterways Association, President, W. K. Kavanaugh, 704 Locust street, St. Louis, Mo.

Mining Congress of America, President, J. H. Richards, Boise, Idaho.

Missouri Valley Improvement Association, President, Lawrence M. Jones, Kansas City, Mo.

National Academy of Sciences, President, Ira Remsen, Baltimore, Md.

National Association of Cotton Manufacturers, President, W. D. Hartshorne, Lawrence, Miss.

National Association of Manufacturers, President, James W. Van Cleave, St. Louis, Mo.

National Association of Agricultural Implement and Vehicle Manufacturers, President, C. H. Huhlein, Louisville, Ky.

National Association of State Universities, President, Chas. R. Van Hise, Madison, Wis.

National Business League of America, President, Erskine M. Phelps, Chicago, Ill.

National Civic Federation, President, Seth Low, New York City.

National Council of Commerce, President, Gustav H. Schwab, New York City.

National Editorial Association, President, Henry B. Varner, Lexington, N. C.

National Educational Association, President, Dr. E. G. Cooley, Supt. of City Schools, Chicago, Ill.

National Geographic Society, President, Willis L. Moore, Washington, D. C.

National Grange, President, N. J. Bachelder, Concord, N. H.

National Irrigation Congress, President, Frank C. Goudy, Symes Block, Denver, Colo.

National Lumber Manufacturers' Association, President, Wm. Irvine, Chippewa Falls, Wisconsin.

National Rivers and Harbors Congress, President, Hon. Jas. E. Ransdell, U. S. House of Representatives.

National Slack Cooperaage Manufacturers Association, President, H. M. Schmoldt, Beardstown, Ill.

National Wagon Manufacturers' Association, President, W. A. Rosenfield, Moline, Ill.

National Wool Growers' Association, President, Fred Gooding, Shoshone Falls, Idaho.

Ohio Valley Improvement Association, President, Col. John L. Vance, 204 L. Front St., Cincinnati, O.

Society for the Promotion of Engineering Education, President, Chas.

S. Howe, Case School of Applied Science, Cleveland, O.

Society of American Foresters, President, Gifford Pinchot, Washington, D. C.

Transmississippi Commercial Congress, President, J. B. Case, Abilene, Kans.

United Mine Workers of America, President, T. L. Lewis, Indianapolis, Ind.

Upper Mississippi River Improvement Association, President, Thomas Wilkinson, Burlington, Iowa.

In addition to the foregoing, invitations have been extended to both Houses of Congress, to the President's Cabinet, and to the members of the Supreme Court.

As has been stated, the Conference will hold its session in the East Room of the Executive Mansion. The opening session will be held on May 13, and the Conference will sit until the evening of May 15.

Primarily the Conference will be between the Governors of the several states and territories, with their respective advisors; and in general, the character of the discussions will be determined wholly by the executives present.

In the interest of convenience, sessions have been arranged; and merely to bring before the conferees the leading facts relating to the natural resources of the country, with the view of directing discussion along the most practical lines, provision has been made for opening each session with brief, formal statements. As arranged, the outline follows:

May 13.

10.00 a. m.—Conservation as a National Duty, Theodore Roosevelt, President of the United States.

2.30 p. m.—Mineral Resources:

Ores and Related Minerals, Andrew Carnegie.

Mineral Fuels, Dr. I. C. White, Professor of Geology, University of West Virginia, and State Geologist of West Virginia.

General discussion, opened by John Mitchell, former President of the United Mine Workers of America.

May 14.

10.00 a. m.—Land Resources:

Soil, Professor T. C. Chamberlin, University of Chicago, formerly State Geologist of Wisconsin, President University of Wisconsin, and Geologist, U. S. Geological Survey.

Forests, R. A. Long, President of the Long-Bell Lumber Company, Kansas City, Missouri.

Public Health, Dr. George M. Kober, Dean of the Medical Department, Georgetown University, Washington, D. C., formerly President of the Medical Society of the District of Columbia.

2.30 p. m.—Land Resources:

Reclamation by Irrigation and Drainage, Dr. George C. Pardee, former Governor of California.

Grazing and Stock-raising, Hon. J. A. Jastro, President of the American National Livestock Association.

The Public Lands and Land Tenure, Judge Joseph M. Carey, formerly United States Senator from Wyoming.

May 15.

10.00 a. m.—Water Resources:

Transportation, James J. Hill, President of the Great Northern Railway.

Navigation, Professor Emory R. Johnson, Professor of Transportation and Commerce, University of Pennsylvania; formerly Isthmian Canal Commissioner.

Water Power, H. S. Putnam, American Institute of Electrical Engineers.

2.30 p. m.—General Discussion.

It should not be inferred that the above outline covers the entire range of topics to be discussed at the Conference, or that discussion will be confined to the subjects mentioned in the outline. It is also to be understood that there will be other papers and addresses besides those mentioned in the outline.

The opening address by President Roosevelt, who will be chairman of the Conference, will strike the keynote of the meeting; and it is planned to have discussions which, while following the general lines laid down in the outline, will be broad enough to cover the entire field of conservation of natural resources. The fact is recognized that the three days set for the Conference will be all too brief to permit the thorough discussion of the

subject; but it is believed that, as an outcome of the White House Conference, there will be formed some sort of permanent organization of the executives of the several states and territories; and it is further believed and hoped that, through such permanent organization, definite and comprehensive plans will be formulated for a conservation movement that will be truly national in its scope, and that will result in the general adoption, by the States and the Federal Govern-

ment, of far-reaching measures looking toward reforestation, forest conservation, the re-grassing of the range lands of the West, conservation and full utilization of the country's water resources, both for purposes of irrigation and power, and, in fact, a general and well directed movement for the husbanding of existing resources and retrenchment as regards present methods of use of what the Nation possesses in the way of timber, water, minerals and other natural wealth.

THE GOVERNORS SAY

THE following symposium, culled from the letters of the Governors accepting the invitation to attend and participate in the Conference at the White House, May 13, 14, and 15, is significantly indicative of the interest that is being taken by the leading men of the country in the gathering. Not all of the Governors have been quoted, for the reason that lack of space forbids; but the expressions selected at random from the numerous and in some cases voluminous letters serve well to show the trend of the whole mass of correspondence.

B. B. Cemer, Governor of Alabama:

"Please allow me to congratulate you on the call for this meeting, and to congratulate you on your general good work for the country and for the people in many respects. I shall gladly accept for myself * * * I feel sure that much good will result from the Conference itself, and from the commingling of these officials and citizens."

Joseph H. Kibbey, Governor of Arizona:

"I agree with the views you express, without reservation. I do not think you stated the facts too strongly when you expressed the opinion that 'there is no other question now before the Nation of equal gravity with the question of the conservation of our natural resources,' and to me it has been especially gratifying to note the warm approval with which the thinking people of the West received the speech from which this quotation is made. The proposed Confer-

ence will, in my judgment, do great good, and I take pleasure in advising you that I intend to be present."

E. W. Hoch, Governor of Kansas:

"Kansas is the most inland of States. No great navigable river traverses its territory, but I think I voice the sentiment of our people when I say that we are heartily in favor of the improvement of all our inland waters for transportation purposes, and the conservation of all our waters for irrigation and manufacturing purposes. Kansas has no public lands, agricultural or mineral, but it is in favor of preserving what remains of these to legitimate business enterprises, and to prevent their absorption by speculators. Kansas has no timber lands, but it is in favor of preservation and restoration of our National forests. * * * And I trust that the proposed Conference will crystallize your ideas into an organized movement that will ultimately accomplish all the results you desire."

J. N. Gillett, Governor of California:

"The conservation of our water, and the application of it to power, and irrigation also, are questions of great moment to us. I heartily approve of any scheme which will preserve to our people the natural resources of our country and save the same, not only for our present uses, but for the uses of those who are to follow us."

Curtis Guild, Jr., Governor of Massachusetts:

"May I state that the present duty on wood pulp and forest products is tending not only to destroy our natural resources, but is a menace to the headwaters of the rivers that furnish the wa-

ter supply and the water power of the Commonwealth of Massachusetts? If nothing else is done in the way of tariff revision, the need of immediate action in this respect appeals particularly to those States which, like Massachusetts, find their attempts at reforestation, through the efforts of State laws and State foresters, negated by the bounty given by the tariff to the destruction of the trees."

C. S. Deneen, Governor of Illinois:

"I appreciate fully the importance of the movement which you have inaugurated, and shall be pleased to do anything within my power to assist you in this regard."

Fred M. Warner, Governor of Michigan:

"The plan outlined for a Conference that shall have for its object the discussion of methods for the conservation of our country's great natural resources meets with my cordial approval. Our people's energies have been devoted to the development and exploitation of these resources for more than a century and a quarter, and the time has come when this policy should be followed by an era of conservation. How to bring this about is a problem now confronting us as a people, and to its solution we should devote the best there is in us."

Albert B. Cummins, Governor of Iowa:

"I am wholly in sympathy with the movement that looks to the conservation of our natural resources."

John Sparks, Governor of Nevada:

"It must be conceded that our people, insofar as conservation of natural resources is concerned, have been wasteful in the extreme. Your call to the Governors and their advisors, as outlined in your letter, meets with my hearty approval. An exchange of opinion in such a gathering will certainly be productive of great good."

J. Frank Hanly, Governor of Indiana:

"I am in hearty sympathy with the purpose which has prompted the call for this Conference, and if I can be of any service to you at any time, you may command me."

R. B. Glenn, Governor of North Carolina:

"I will make it a point to be present and take part in this meeting, which, I think, will be of incalculable advantage to the entire Nation. I can assure you, Mr. President, that nothing will give me more pleasure than at any and all times to aid, in any way in my power, in the upbuilding of the great natural resources

of our Nation, and in preserving from willful and malicious destruction our forests, mines and other natural sources of wealth."

F. R. Gooding, Governor of Idaho:

"This meeting, I am sure, will be productive of much good. It should arouse the people to the importance of conserving the natural resources with which this country has been so generously blest. The people have looked upon these resources as inexhaustible; waste and extravagance have been practiced on every hand, until the citizen who has taken the time to look into our great resources is becoming alarmed for the future interests of the country."

C. N. Haskell, Governor of Oklahoma:

"I believe that this Conference will be of much benefit, and that the study of these subjects—the natural outgrowth of such a conference—will be vastly beneficial to posterity."

M. F. Ansel, Governor of South Carolina:

"I have for some time taken great interest in the question of the conservation of our forests and waterways, and I have been made mindful of the fact that unless something is done to conserve these interests, our posterity will not have what they are entitled to from our hands. And I realize the importance of this great question to our country at large."

John C. Cutler, Governor of Utah:

"The suggestions regarding the conservation of the natural resources of our great country are most timely and appropriate. It has been evident for some time that the people of America are too wasteful of the splendid patrimony God has given them. Apparently assuming that our resources are inexhaustible, we have manifested an extravagance which, if allowed to go unchecked, will impoverish the country and transmit a bankrupt commonwealth to later generations. This condition is not so apparent in the West as in the older regions of the East. But that is all the stronger reason why we of the West should take the matter in hand and stop the wasteful tendency before actual need confronts us. For the tendency toward extravagance is at least as great here as in the East; its results are not yet so apparent only because it has not prevailed so long."

William M. O. Dawson, Governor of West Virginia:

"I beg to say that I am in hearty accord with the purpose of the meeting, and am glad indeed that you have

called this Conference. * * * West Virginia is very greatly interested in this matter, as there is great waste in this State of natural gas, oil, coal and timber. And I beg to suggest that a meeting of the Governors of the States, such as you propose, will be beneficial in other respects."

Bryant B. Brooks, Governor of Wyoming:

"Personally, I am strongly inclined to the belief that the proper conservation of our natural resources can better be promoted and safeguarded by arousing local interest in the subject, and by enacting strong and suitable laws in our State Legislatures, and giving the States the widest possible power and control, rather than by turning everything over to Federal authority, to be controlled through Federal Bureaus."

Joseph W. Folk, Governor of Missouri:
"I fully appreciate the importance of this subject to every section of the United States, and the necessity of some action being taken to conserve those resources upon which our continued prosperity so largely depends."

E. F. Noel, Governor of Mississippi:

"The question—of conservation—is one of great importance, and I shall gladly give all possible aid to the promotion of the objects of this Conference. I intend to bring the matter to the attention of the Legislature, with a view to having the question forcibly presented to our Senators and Representatives. I do not know what action has been taken by our Representatives in Congress, in the past, in regard to the better conservation of our natural resources, but we shall try to quicken their interest in the subject."



THE HILL MAN'S LAMENT

By Arthur Chapman

[The most inaccessible parts of the forest reserves in Colorado will soon be put in telephone connection with civilization.—Government Report.]

I'm off for the undiscovered ways,
Along with the old pack horse;
I want to spend some cheerful days
By the side of a water course;
I want to get in the deepest wood
Where wild birds dare to sing,
And—pardner, be this understood—
No 'phone goes brrr-ing-ing!

I've ranged the hills for years a score,
And fled from pillar to post,
To get away from the trains that roar
On their way from coast to coast;
But now they're stringing wires through
The last haunt where I cling;
So I'm up and off to a country new
Where no 'phone goes brrr-ing-ing!

The frontier's gone, and the cowboy, too—
The sheepherder's doomed to go—
For a man who loves Dame Nature true
There soon won't be a show;
So it's up and pack, and pull my freight
To a land where Solitude's king;
And where there's ne'er that sound I hate—
The telephone's brrr-ing-ing!

—*Denver Republican.*

WORK IN A NATIONAL FOREST

BY

Charles Howard Shinn, Supervisor of Sierra (North) National Forest

No. 7: Land, Indians and Whisky

HAVE something of a story to tell, and a few questions to ask of those fellow-workers in the Service who are up against these particular problems. They belong mainly to California, for in most States the Indians are on reservations and more directly under Governmental control than here. Even in California the special difficulties that I shall describe are less serious south of the Tehachipi. As it happens, my friends Bigelow of Klamath, Barrett of Lassen Peak, Elliott of Tahoe, Britten of Stony Creek, and a few others of the northern and central forests of California, besides some of our Pacific Coast Inspectors, are the ones who can contribute most to a symposium upon Indians. I hope that the energetic editor of *FORESTRY AND IRRIGATION* will wisely trouble all these, and others too, for contributions along this line.

The full-blooded Indians of California are estimated to have numbered 210,000 in 1834 under Spanish rule and before the Days of Gold. They now number but 17,000, and about sixteen hundred of these live in the National Forests. A map was prepared in 1907 for the Northern California Indian Association, which map shows some nineteen points in Sierra North at which Indians live in numbers of from ten to one hundred. These places are not really "rancherias," though they are commonly called so. The little Indian homes are scattered here and there, wherever a spring can be found and a little pasturage for a few horses. These Indians wander around to each others' camps at different seasons, or up into the higher mountains, or down to the plains for

the hop-picking and grape gathering, returning to their homes in winter.

In 1906 the report of C. E. Kelsey, Special Agent for the California Indians, was issued, in which he says: "There is also quite a number of Indians located within the boundaries of the Forest Reserves. According to figures of your Special Agent they number 1181. They have no title to the lands they occupy, and since the establishment of the Forests it is uncertain whether the lands within their boundaries can legally be allotted to them." Mr. Kelsey says further that the Indians are protected by the forest regulations and that there is "no occasion for any action in respect to any of them."

Mr. Kelsey has again visited this forest (March, 1908) and, comparing notes, we decide that the total number inside of the forests is fully 2,490, and a complete census will certainly bring it to 3,000 or even 3,300 when the proposed additions to several forests are made. The number in Supervisor Bigelow's bailiwick is not less than 790; Sierra North, when the proposed new area is taken in, will include not less than 862; Sierra South and Sierra East have some; Monterey has a few; Diamond Mountain, Shasta, Trinity, Stony Creek, Tahoe and Stanislaus hold about all the rest. We are making a census here; and it is a heavy piece of work, too, for we want it more than a mere alphabetical list; it must include all attainable personal, historical and economic facts.

Evidently the problems pressing upon those who wish to give the Indians "a white man's chance" are many and serious. In fact it appears

to me that the attitude taken by forest officers towards the Indians within their jurisdictions is exceedingly important. We have it in our power to help them in perfectly simple, direct and practical ways free from sectarianism or sentimentality. We can understand them, and their needs, better than most people do, and we can help their slow, halting progress.

Dr. Merriam, of the U. S. Biological Survey, one of the most charming of men and earnest of scientists, has said that the chief cause for the decrease of the Indian population in California—from 210,000 to 17,000—was the “relentless confiscation of their lands and homes.” The Indian delegates to the Zayante Conference held in Santa Cruz County, July 19, 1907, placed as their first appeal: “We want land for homes. Our land has been taken from us. We have been kept by law from taking up land until all the good land was gone.”

On this point all the Indians that I know are strenuous. “Indian want paper on his land,” is the way they put it. But what they really mean to say is that they want absolute safety in some clear, definite and final way. It must be made certain that no one can ever take their homes away. The more thoughtful of them know that it is dangerous at present to give them the power to sell their lands.

This brings us to the main problem of the land question, on which the Service has been working for some time: How shall their little patches of tillable ground in the rocks and timber be so secured to the Indians as amply to satisfy their claims without permitting white men to take it from them by fraud or force? It is not as if the land were farming land. It is not; it is mainly pastoral, and speculators would like nothing better than to have hundreds of Indians take up a quarter-section each, and then lease, or ultimately sell it all. The land they want in this way is largely wood-

land. Cleared and handled by men of capital and horticultural skill it may eventually lend itself to higher than pastoral uses, but certainly not now. And as certainly it will grow firewood—oaks, manzanita, and the inferior pines. At present white men will not take it under the Act of June 11, nor can they profitably use it, except for pasture.

Now, since the Indians are not citizens, they do not come under the Act of June 11. Nor does the so-called Indian Allotment Act appear to apply within the forests, for which new legislation is necessary. But the tendency of recent congressional action has been to break down the safeguards of that famous law of 1884 by allowing Indians to lease, and practically to transfer their lands. Thus we are brought to a point where the Indians are easily led to believe that various officials are deliberately avoiding the obligation of securing to said Indians the little patches of tillable land which they need.

One Indian said to me: “White man talk, talk, talk; give Indian no land. What for Indian get no land?”

To which I said: “You got land now. You go your cabin, cut brush, make fence, sow hay. You work—that your land.”

Under the present regulations of the Service I presume that ample and non-transferable leases could be given to Indians for all the land they actually use, and for the additional areas as fast as they clear off the chaparral. I have no doubt that an intelligent lease system is sufficient for years to come, and it also retains control of the timber. When the Indians become citizens, they can receive patents to their homes. Meanwhile let us teach and train them for the responsibilities of citizenship.

But, as it so often happens in real life, many of the friends of the Indians take exactly the same view of the case that their enemies do. Bad whites want each Indian to get a pat-

ent at once to a quarter-section of land—so that it can be alienated for a little whisky. A few short-sighted friends of the Indian want him to wait till he can get an allotment in some remote future, or even run the risk of an immediate patent because they think it "mere justice." So the Indian is too often told, "You want same paper white man get."

Meanwhile, and until those in authority settle the procedure, what do the Indians in the forests get? They have, I think, absolute protection here and now, in all their rights of what lawyers call "useage" as against any interloper. True, it depends on the forest officer and the Service, but do not white men's rights depend on white men's courts? A friend of mine is just now trying to dispossess a fellow who jumped his patented claim in a town, in broad daylight, and is living there at the present time. The Indians up here, believe me, are much better off.

There was the case of Jim Roan. He is a full-blood Indian of first class standing and he wanted to build "one cabin on my land, where I live long time ago". One trouble about handling Indian cases is to get exactly the Indian point of view. They move around a good deal; but they hold tenaciously to the belief that to every place where they once dwelt they have some sort of a possessory right.

The Roan case came up in old Land Office days. When I looked it up, it was perfectly evident that Jim had once had a cabin there; that it had burned down; that he had always called it his own little flat, in the oak country over by Ahwahnee. But some white neighbors immediately objected for all sorts of irrelevant reasons. The real reason was that they had cattle, and the little flat was handy. But outside range was near and abundant, and even if it had not been, Jim's claim was a better one in equity. So he rebuilt his cabin, fenced his little garden, runs his few horses on the

range and has become a strong support to the forest.

There was the more recent case of "Bill Grant's wife's mother," an Indian woman who claims a field that she had cleared years ago and had surrounded by a brush fence. She lives with Bill, who has a quarter section; but this little outside field is her own. A white man came along, entered under Act of June 11 an adjacent quarter, and securing a permit to begin operations, calmly took possession of the Indian woman's field, plowed, sowed grain there, and made preparations to build. An Indian rode up one night and told me all about it.

"What she do?"

The next morning I sent a ranger there—a two day's trip—and the white man was moved back to his own land with a terse warning to be good, or something worse would follow; and Bill Grant's wife's mother is again in possession. If she had a patent, but no Forest Service at hand, how could she hire lawyers when a white man jumped her claim?

There is the case of Mrs. Emma, who is a famous laundress, and knows as well as anybody does when she is treated fairly. The ranger ran out the lines of the land she wanted and I told her she might put an addition to her cabin, fence, plow and sow just as she chose, and I had the rangers brush out a new road for her when her old one was shut off by the creation and fencing of Sight Rock Range Station.

I could tell dozens of such stories to show how safe are the homes of the Indians in this forest under Service management. But is this really enough? And, further, how shall Indians who have no homes as yet acquire them, unless by leases? Would it not be well to have each Supervisor empowered to allot to Indian families whatever lands they can use, on some carefully thought out lease system, and to have the Indian Commission take steps to show these Indians how best to improve and utilize these small holdings?

The second great need of all our Indians is protection from the liquor traffic. The Indians are realizing the evil of this traffic more than ever, and they are trying hard to stop, but disreputable white men conduct low-class saloons and smuggle whisky to the Indians; half-breeds and worthless whites carry it to the rancherias, where unnamable crimes have been committed in drunken debauches. The fact is, our laws are defective and public sentiment is not yet fully aroused. Indians when they get drunk are especially dangerous to themselves and others. They lie in the villages or by the trails or in the rocks, some times all night without shelter.

This forest is full of strange and sad stories of Indians and whisky. I remember how old José came to my cabin once.

"Huh! You know that Cap Wah-Wah? He get big drunk. He go home, an' take he wife an' drag her all roun' by her hair; he kick her; he run; he yell; he tumble down. He ver' bad Injun. What for white man no put Cap Wah-Wah in jail?"

Whisky killed Cap a few years later—one of the best workers in this region, too, when he could be kept straight.

There has been much complaint about the laws in regard to Indians and whisky. The old California statute made it a felony to sell or give intoxicants to any Indian. But it proved very hard to get a jury to send a man to State's Prison for this offence. The law was amended so as to read "misdemeanor."

One District Attorney in California has secured forty convictions under this amended act. But of course, officers must have the honest and steady backing of public sentiment.

The friends of the Indians are trying hard to bring the whole matter under United States law. It is believed that the law should forbid sale or gift of intoxicants to Indians and to men of mixed blood, and that cases should be tried in the Federal courts.

When a growing public sentiment suppresses the so-called "road houses" and the village saloons, the evil will be handled easily. It is surprising how many people are in favor of prohibition through local option everywhere in these mountains.

Thirdly, nearly all the Indians up here are anxious to educate their children. There are about 17,000 Indians in California, you know, about a tenth of them in the forests. About 12,000 of these (including all the forest 1,700) are not on reservations, and the Government has done nothing at all for them as yet. As Helen Hunt Jackson said long ago, we seem to have kept our help entirely for the tribes that did the most dare-devil fighting. In this forest the children are so widely scattered that few of them can reach the public schools, which take them in, though sometimes a little under protest. These Indians need boarding schools for their children. In other words, the Government should feed and clothe their children for a few years.

But I think I know what real education should mean for these mountain children of a despised and forgotten people. It should be in the main that sensible industrial training of which Hampton and Tuskegee struck the key notes. They ought to be shown, by example and by daily practice, the bread and butter trades of life. That means that some very capable and practical men and women must come and live among them for years, to gain their complete confidence; and lead them, millimeter by millimeter, up the trail to good citizenship. The time will come when educated Indian doctors, nurses, lawyers, and missionaries will be fitted to work among them; but not yet, nor for years to come. Just now the children want to be taught how to plant and care for orchards and grain fields, how to build houses and raise live stock, how to shoe horses, keep poultry, and make butter and cheese.

If all this appears to anybody a little

aside from one's legitimate forest work, let me tell you about a few of the things that happen up here where we have to deal more or less with Indians every day of our lives.

First, I shall illustrate what the Indians think about the National Forest. Once a very drunken Indian walked up in front of me and gave a yell. Then he said: "You heap big man—own all land—million million acres!" Then he went off leaving me to reflect on the bigness of my ranch.

Second, let us consider the willingness of all the Indians, when sober, to accept guidance; and their capacity, in the main, to pick out their real friends. Nothing in the whole Indian problem seems to me more wonderful than this. After so enormous an amount of suffering as these people have endured, they meet good will half way; they finally give us their faith in the most complete manner.

There was old Julie, who lives all alone in a cabin on the side of Goat Mountain. It was built by her Frenchman years ago; he was a workman on a certain infamous mining swindle, the great placer mining ditch of this region, floated on Parisian capital by a small promoter. He took the girl from her rancheria, named her Julie, taught her much, died in this cabin—and she lives on and on, without change or forgetfulness.

One time we had a fire up there; Julie sat in her doorway and watched us; we filled our canteens at her spring. The next day the rangers wanted to sleep, and she "spelled" them on the fire line. She made coffee, too—her coffee—in an old tin can.

Well, the boys gave her some grub, and I paid her for half a day on the fire line, and she thought it was pretty nice. Then I heard lots of pleasant tales about her. One was how a man, now a ranger, had once been ill and wanted to stay in a tent near her spring. She told the man's wife: "Your man he sick; put him in my house." And she went out under a pine tree, and slept in utter content.

One very cold and rainy night there was a knock at my cabin door. It was old Julie, wet and draggled, but serene as a princess.

She announced: "I stay here."

"Where you come from, Julie?"

"I stay here to-night."

"Why, sure; come right in; get warm at fireplace; my wife make you some supper."

"I got horse; he stay here to-night."

So we took care of her horse, and the next morning when the storm was past, she made ready to leave.

"Well, goodbye, Julie; good luck to you."

"Wait, I show you." She untied a piece of cotton rag and brought out her small store of silver and tendered it all. "You take."

"No good take money, Julie; all friends; you fight fire, too."

One swift look, then a cheerful laugh. "All right. Goodbye."

Now you, who teach language in universities, can you set forth a terser, more idiomatic English than this of Julie's? Oh, the loads that I have seen this poor old Indian woman carry up the rough trails would stagger a mule! There are many more of just the same sort, growing old, and as full of courage as it is possible for any human being to be.

It is time to stop, and it is midnight, too; and magazine forms will not stretch. But let me put emphasis, in closing, on just this: That not least among the responsibilities carried by a forest officer are those which arise from the presence of dependent human beings of every kind. We all know the Grazing, the Special Use, the Timber Sale problems, all of which are tied up with human affairs. The Act of June 11 and the Indian Allotment and Lease problems have put gray hairs on the tops of some of our heads. But they have done us good, after all, for we have gotten closer to the plain people, white, brown and red. And it doesn't hurt to keep a box of apples for the Indian children, or a cigar for your Indian wood-chopper.

EDITORIAL

A Notable Conference.

It is a peculiar fact, not recognized by many of those who have read in the daily papers news articles in regard to the coming conference at the White House, that never before in the history of the United States has it seemed advisable that the Nation's Chief Executive call into convention the Chief Executives of the several States. No circumstance has seemed so great; no contingency has loomed so gravely upon the horizon, as to make it seem necessary for the President to call into consultation the Governors of the States, for the purpose of counseling with them as to the means to be adopted to forestall threatening disaster.

Not even when the civil war impended, and the country's very existence was menaced as it never was before, was such a council suggested. With war clouds lowering, and the grim mutterings of rebellion growing louder and more threatening month after month, and year after year, no President conceived the idea of calling together the different Governors, that the disputed questions might be discussed as calmly as possible, in the hope of finding, in a council of the wise, a solution of the problems that afterward were discussed with rifle and cannon and washed out in torrents of blood.

But the thing that was not deemed necessary, or that was not thought of at all, when the Nation faced the prospect of a bloody internecine strife, has been considered vitally needful in a time of peace; and for months past preparations have been making for this, the first conference in the history of the country at which the different Governors will meet to consider, with the country's President, and with the ablest men now living, a problem so grave that even a brothers' war is play beside it. For surely the questions and the problems having to do with

and bearing upon the conservation and proper use of our natural resources are worthy to be ranked as of the deepest importance to the people of the land.

The continued prosperity of a nation depends absolutely upon the proper use and the proper conservation of that nation's natural resources. If the resources are wasted, then will the nation sooner or later become bankrupt; just as is assuredly the case if the resources of an individual are wasted, or permitted to escape their fullest proper utilization. In the case of either nation or individual, ultimate bankruptcy is certain unless capital is husbanded; and in the case of a nation, the resources originally provided by nature are the capital. The results accruing from proper utilization of such resources are the interest earnings of that capital; and no nation that ever existed can sustain a continued impairment of its capital without impairing its earnings.

It is these facts, and the rapidly increasing general appreciation of them, that makes the coming conference at the White House of such momentous importance. Starting with a natural equipment, in the way of timber, mineral and soil resources, of a richness and diversity such as no other country in the world's history could boast of, we Americans have wasted our heritage to a point where its ultimate extinction is a matter of years, unless we face about and make a determined and understanding start in the direction opposite to that in which we have been traveling. And that the conference called by President Roosevelt will result in a crystallization of public sentiment such as will make an about-face easily possible is the belief of those best informed as to the present status of the nation's natural bank account.

The preliminary steps in educating a people to the necessity for the adop-

tion of a revolutionary course of conduct are always the most difficult; once well started on its way, the course of an educational propaganda, that roots in human necessity, is comparatively easy. The preliminary steps—the primary grades, as it were—are the ones in which endless tact, exhaustless patience, and a deep and broad understanding are prime requisites. The propaganda of conservation has been carried on for years, with more or less success, in this country; every succeeding year a larger number of thinking men and women have been brought to see the absolute necessity for a program of retrenchment as regards natural resources. And now the time has come for a conference such as the one to be held in Washington during the early part of May.

The whole reading population of the country is more or less familiar with recent events that have led up to the calling of this convention of the Governors, their advisors, and the country's leading men—this national, unofficial conference of public officials, sitting in the capital of the Nation, with the Nation's Chief Executive as chairman. Truly unique, this gathering; and truly great must have been the crisis that has brought it about.

The Woods We Have. Americans have long been known as a practical people—a nation of men of business sagacity, with an eye out for the main chance. This being true, is it not amazing when one considers the indifference of Americans, business men, professional men, farmers and men in every walk of life, in regard to the absolutely vital questions now confronting the country? How slight is the realization—that is, the really popular realization—of the extent to which deforestation, with all its evil consequences, has been pushed in this country! It is common to hear one of these uninformed men say, when forest conservation or reforestation is under discussion:

“Bah! All talk! Why, we have plenty of trees; look at them!”

And the hand is waved in a horizon-embracing sweep.

There are trees, to be sure—lots of them. But of what sorts? Go into the woods and count the hickories, the white oaks, the black walnuts, the white walnuts, the elms, and other hardwood trees. It will not require much counting. Even of the ash there are few specimens left; and rock maple is practically gone. There are woods, to be sure, but what are they? Soft maple, dogwood, sassafras and bushes of various kinds—not even a poplar in a five mile walk through the “plenty-of-wood” the uninformed take in in their sweeping gestures.

North, and east, and south, and west, the condition is the same. The pines are almost gone; red cedar is as scarce and as valuable as mahogany, almost; and about all that is left is beech and soft maple—equally worthless for lumber—and the undergrowth that gives the appearance of dense forestation to the hillsides. And there—right there—is the explanation of high lumber prices that confront those who would build their homes. With little or no pine or poplar, little or no elm or ash, little or no oak, rock maple or walnut, how can one expect to avoid high prices? This much for the purely materialistic, selfish side of the forest question.

Soil erosion, another phase of this all-embracing problem, comes from deforestation, as surely as rain comes from the clouds. Deforested slopes, mistakenly put under cultivation, plowed, harrowed and left free to throw their soil into the nearest water-courses—how much, in the aggregate, do these take from the nation's wealth in a year's time? Ask the men who work the dredges that are constantly in operation in the harbors of the Atlantic seaboard; ask the men whose task it is to clear the channels by which the Mississippi flows into the Gulf. A billion tons a year, of the most fertile soil from the farms of the Middle West, wastes itself in the waters of the Gulf of Mexico—enough to make a blanket a foot deep over the entire

State of Illinois. Millions of dollars wasting every year, because the practical American can not see the necessity of caring for the forested uplands he already has, and the further necessity for reforesting such uplands and slopes as have already been scourged and skinned with the ax and the cross-cut saw.

There are plenty of men yet active in daily life who can recall the time when freighting on the Wabash River was a regular occupation for scores of men. Strings of flatboats, and heavy barges, propelled by steamers, worked on the Wabash as far up as Lafayette, Indiana; and their working season ran practically through the year. Today, one may see, occasionally, a little sternwheeler, pushing a single barge, carrying corn or coal as far up as Terre Haute—over one hundred miles, by river, below Lafayette. And it is only during high water in the spring that even this is to be seen. These boats used to run to Cairo, Louisville or Cincinnati: but they have not made such trips in a good many years. Because the Wabash has no longer a permanent channel—the channel that used to be is filled up with silt and sand, with logs and with gravel bars, until what used to be a waterway is now merely a drain, filled and overflowed for miles on either side during the flood periods, and reduced in size to a creek through the rest of the year.

The expense of dredging and caring for the channels of the Ohio, Mississippi, Miami, Kanawha and a few other Middle West rivers, and of dredging the harbors and streams of the Atlantic seaboard, is more, in a single year, than the whole sum that would be required to make the northern crest of the Appalachians—the White Mountains—a National Forest. Government, municipal, state and private expenditures for such dredging amount to a sum so stupendous that, with the money so expended in five years, the crest of the Appalachians, from Maine to the Carolinas, could be made into a National Forest.

Inter-relation of Phases. The question is syllogistic; it runs thus: The country needs a system of waterways, in order that the strain on the railroads, and the country's mineral resources, may be relieved; to make sure and permanent such a waterways system, forested hillsides and mountain crests are necessary. Forest conservation and intelligent reforestation mean an equable flow of rivers, an equable distribution of surplus waters, a lessening of the constant strain upon the country's transportation facilities, a lessening of the steady drain upon the coal and iron mines, and a steadily increasing timber supply, as well as a means of preventing soil erosion and the consequent appalling drain upon the farm fertility of the land. And the answer to the whole question equals a good business proposition—a sound, safe and increasingly valuable investment.

These are a few of the things that make the coming White House Conference the most momentous convention that has been held in the history of the country. To find correct answers to the big questions that are to be discussed at this Conference will mean more to the country—now, next year, and the years to come—than all the questions of tariff, of political expediency, of world-relations, that could be discussed in a century. Are the American people practical enough to see and to realize fully the importance of these problems, and the importance of finding solutions for them? Are the American people practical enough to see the value—present and future—of the investment they are called on to make? Or are they willing to go ahead, checking against their capital while discounting the interest on that capital, until at some not distant day, the nation awakes to the fact that it is bankrupt, so far as natural resources are concerned?

The Appalachian Bill

False reports regarding the action by the House Committee on Judiciary on the Appalachian-White Mountain

Bill have recently been widely scattered. It was stated that the Committee, by a majority vote, had declared the whole proposal unconstitutional. Instead, the Committee had, at that time, taken no action, for or against, save to consider the measure.

On April 22, however, the Committee unanimously adopted the following resolutions:

"Resolved, That the Committee is of the opinion that the Federal Government has no power to acquire lands within a State, solely for forest reservation; but under its constitutional power over navigation the Federal Government may appropriate for the purchase of lands and forest reserves in the States, provided it is made clearly to appear that such lands and forest reserves have a direct and substantial connection with the conservation and improvement of the navigability of a river, actually navigable in whole or in part; and any appropriation made therefor is limited to that purpose.

"Resolved, That the bills referred to in the resolutions of the House, H. R. 10456 and H. R. 10457, are not confined to such last mentioned purpose, and are therefore unconstitutional."

To the superficial, this action might appear to block the entire movement for establishing the forests proposed. Such, however, is not the case. It is now only necessary so to modify the Appalachian bill as to bring it into harmony with the requirements of the Judiciary Committee. Representative Weeks, of Massachusetts, has introduced a bill. Representative Pollard, of Nebraska, has also introduced a far-reaching bill providing for continued private ownership of the Appalachian area, but for Government regulation of cutting. Both these bills have been referred to the House Committee on Agriculture, which is expected to meet this week. Still another bill may be offered in Committee, as a substitute for the Currier and Lever Bills.

Friends of the Appalachian-White Mountain forest proposal should concentrate their attention upon the Agricultural Committee, urging the favorable report of a measure which will protect the forests, streams and de-

pendent interests of the areas involved. Following are the names of the Committee:

Committee on Agriculture, House of Representative:

Charles F. Scott, Kansas, Chairman, 2nd District; Jack Beall, Texas, 5th District; W. W. Cocks, New York, 1st District; Ralph D. Cole, Ohio, 8th District; G. W. Cook, Colorado, at large; Clarence C. Gilhams, Indiana, 12th District; Kittredge Haskins, Vermont, 2nd District; Gilbert N. Haugen, Iowa, 4th District; W. C. Hawley, Oregon, 1st District; J. T. Heflin, Alabama, 5th District; John Lamb, Virginia, 3rd District; A. F. Lever, South Carolina, 7th District; William Lorimer, Illinois, 6th District; J. C. McLaughlin, Michigan, 9th District; Ernest M. Pollard, Nebraska, 1st District; Wm. W. Rucker, Missouri, 2nd District; A. O. Stanley, Kentucky, 2nd District; J. W. Weeks, Massachusetts, 12th District, Wm. H. Andrews, New Mexico, Territorial Delegate.

Of these Messrs. Cocks, Haskins, Lamb, Lever, Lorimer and Weeks are counted as certainly for the desired legislation, except that Mr. Lorimer is away; Messrs. Gilhams, Heflin, McLaughlin and Stanley are also believed to be favorable.

The fact that Representative Pollard, who has been regarded as antagonistic to the legislation, should have reported a measure of such comprehensive character is a favorable omen.

There is talk of adjournment about the middle of May; no effort should be spared to secure the enactment of this legislation in the present session.

Some Criticisms Considered

An editorial from the *Great Southwest Magazine* (Denver) is being distributed anonymously as a folder. The folder is entitled "The West to the East, An Appeal." The editorial is said to be representative of the sentiment of the mountain States.

This editorial makes some important concessions. It says: "It is proper enough that the Nation should be edu-

cated to a startling realization of how we have recklessly squandered our heritage of forests, soil and other natural resources for over a hundred years. Our prodigality has been shameful and criminal." It says: "No where in the world are forest reserves more enthusiastically approved and appreciated as an institution as in this arid Western country." It refers to the Appalachian-White Mountain forest proposal as a far-seeing one. It speaks of the Government Reclamation work with the highest approval. At the same time it offers some sharp criticisms.

It is strongly opposed to Government control and leasing of the open public range. This proposal, in its view, is demanded by the Forest Service and by big cattle owners, in each case for revenue only.

This policy, it claims, is highly detrimental to the interests of the communities immediately concerned. The big cattle men anticipate long leases of land from which the home-owner would practically be excluded. Thus the settlement of the country would be retarded and opportunity denied the man of small means seeking a home.

In answer it may be said that whatever interest the Forest Service may have had in revenue, whether from National Forests or range, in the past, it has none now. The Fifty-ninth Congress provided that all revenues from National Forests should, hereafter, be covered into the Federal Treasury, and the Forest Service should be maintained not by revenues from the National Forests but by direct appropriations from Congress. Revenues from the range would, of course, be no more available to the Service than revenues from the National Forests.

As to regulating the use of the range, it must be conceded that the Government owns the range and hence has the right to control it. Again, according to the dictionaries, the absence of government is anarchy. Those who advocate it should show why anarchy on the range is superior

to anarchy elsewhere. Experience is proving that government in the National Forests, as outside, is vastly superior to no government; the natural inference would therefore be that government on the range would be superior to no government there.

The need for regulation should be plain. Unregulated grazing is damaging and, in some cases, destroying the range, as unregulated use and abuse are damaging and destroying the forests.

Again, throwing a fertile range open to competing regiments or armies of cattle and sheep men is much like "throwing a banana to a cage of monkeys," or throwing open the Cherokee Strip to settlers. Civilization should have advanced beyond that method of distribution.

Further, government is necessary to the establishment of homes upon the land.

If the plans for regulation provided by the Burkett or Scott bills are objectionable, let the objectors suggest better plans.

Again, stress is laid (outside the editorial) upon the irrigation situation. Attention is called to the fact that the Government irrigates only on large projects; a multitude of small ones must therefore, if irrigated at all, be irrigated through private initiative. The private irrigator, usually a big stock man, and the small home owner, it is argued, work together under the non-governmental system in harmony; the big man furnishes the water, and the little one the crop, which he sells to the irrigator for winter feed. The lease system, however, with its long tenure, would justify the big cattle man in raising his own feed and would thus eliminate the home owner.

The obvious remedy for this difficulty is more Government irrigation. It is recognized that the present National irrigation works cost the country nothing; that it is maintained by a perpetually self-renewing, revolving fund; that what the Government pays out with one hand for reclamation work it takes back with another

through the sales of irrigated land. Such being the case, why should not this revolving fund be increased to any necessary amount, thus enabling the Government to irrigate not only a few great areas but a multitude of small ones? No question is raised over the protection accorded the home owner on lands irrigated by the Government. Why have we not here then a complete solution of the home owner's problem?

The editorial in question praises the National Forest principle but condemns its operation. The administration, it claims, is defective; red tape abounds; subordinates are arbitrary, etc. The author, however, cannot expect blanket charges to be met. Let him specify, furnishing names, dates, and places.

If the National Forests are to be successfully administered, the local viewpoint must, of course, be understood. The same principle applies to the successful national administration of the public range. Why may not provision be made for the establishment of some State advisory board or commission, with which the responsible forest officers in each state might keep in touch?

The editorial voices the familiar view that public lands should, with rare exceptions, be converted as promptly as may be in private property. The time has come when the Nation should think twice before accepting this dictum. The fact that it has acted upon it in the past is no proof that it should continue to act upon it. The pell-mell haste with which we have rushed to convert our public domain into railway empires, and otherwise to enrich vast corporations at the expense both of the public as such and of the man to whom home-owning has now become impossible, should warn us against future progress in this direction. It is instructive to contrast the ease with which public lands have been made private with the enormous difficulty, now illustrated by the Appalachian campaign, incurred in the endeavor to convert private lands into public.

The first process is like descending a toboggan slide; the second is like climbing back to the top of the hill and dragging the sled. The era of unrestricted private ownership has, let us hope, reached its culmination and begun its decline. Special pleas may still be made for the return of the "good old times"; but if the people are wise, these pleas will be made in vain.

Forests of Korea to be Protected Korea, the Hermit Kingdom, is waking up to the necessity of protecting its remaining forests and replanting denuded tracts on important watersheds. Japan is furnishing the inspiration and part of the money which will produce the change from the old order of things to the new. A school for training Korean foresters has already been put in operation.

The two governments drew up a co-operative agreement last spring and outlined a plan for the wise use of the forests in the Yalu and Tumen valleys and as a result a national forest policy for Korea has been developed. The new Korean forest laws are similar to those of Japan, according to United States Consul-General Thomas Sammons, of Seoul.

Although Korean forests have been exploited and neglected, and the country has suffered from drought, floods, and erosion, the denudation is less serious than in neighboring provinces of China. One of the first measures to be taken up will be the preservation of such wooded tracts as yet remain. In order to do this, the government has taken all forests under its care, whether they are publicly or privately owned. The owners will not be deprived of their property without compensation, but the Government will regulate the cutting of timber, and in certain cases may prohibit all cutting on tracts which ought to remain timbered, "to prevent floods, droughts, landslides, and to preserve unimpaired the scenic attractiveness of places of public resort." All owners of timberland and all leaseholders are required

to report to the Government their holdings in order that the property may be listed and cared for. Failure to report within a year subjects the forest to forfeiture.

The forested area of Korea is about 2,500,000 acres, which is only one-tenth of the land on which forests ought to be growing. Extensive timbered tracts remain in the Northern part of the country on the waters of the Yalu and Tumen Rivers, and lumber operations are carried on in the mountain districts. But in the agricultural sections of the country wood is very scarce and the fuel problem is serious. Coal and other mines have been opened by Americans, and one of the most pressing needs is timber for use in and about the mines. In that country, as elsewhere, large quantities of timber are necessary in developing mining property, and it is noteworthy that a country as backward industrially as Korea can put into practice the principle that the only sure way of getting timber is to grow it.

Nominate Members

A study of the statistics of the membership campaign of the American Forestry Association shows that few, if any, lists are better for solicitation purposes than the list of nominees sent in by members of the Association. These names are evidently carefully collected and yield, on the whole, excellent results. We again earnestly urge our membership to aid the work of the Association by sending in names of possible members for the use of this office. A large and growing membership adds greatly to the prestige and power of this organization. It furnishes funds with which to prosecute the work, and it raises up a body of friends everywhere to sow the seed from which the ultimate harvest may be reaped.

On the advertising page opposite the table of contents will be found a form entitled "NOMINATIONS FOR MEMBERSHIP." Post-office regulations curtail the blank space; nevertheless, by pasting on a sheet of paper it may

be indefinitely enlarged. Let each member faithfully use this form and send in the names of all, whether few or many, whom he may believe would be willing to join the Association. And wherever possible let him use his personal influence with these to encourage, or even urge them to join. A few earnest, aggressive, working members, soliciting memberships can very materially aid the progress of the organization. The existence of the present industrial stringency necessitates increased activity on the part of our friends. Let the nominations pour in.

Trust to be Probed

The announcement is made that the Bureau of Corporations intends to devote much attention during the coming year to the "Lumber Trust;" and the further statement is given out that the fireworks may be looked for at almost any time now. For more than a year past the Bureau has been conducting preliminary investigations and searching into all the conditions of the lumber business, and now active work, it is said, is ready to be put under way.

Within the next few weeks the Bureau will put a large force of men into the field, to reach all the lumber regions and the important trading centers of the country, and these men, specially trained for the work they will have to do, are to investigate right on the ground the conditions of the lumbering industry and the various and multitudinous correlated industries.

In the preliminary inquiry the Bureau has already given a liberal lumbering education to the men who will act as special agents, and these men have been for a year or more trained into the essentials, so that they will be able to go about their task in an intelligent manner.

The coming report, which may require two or three years in compiling, will, it is believed, be the most voluminous and the most important contribution to the literature of forestry—

commercially speaking—that has ever been made. Among the questions covered will be: Destruction of the forests; the necessity for stopping this proceeding, the extent of reforestation work in progress, the means necessary for the encouragement of reforestation; in addition to which the report will cover such grounds as the purely commercial aspect of the matter, operations of the lumbering business, relations of railroad rates to lumbering, and of water transportation to railroad rates; the making and maintenance of prices, average and actual cost of lumber production, and profits of the business.

It will be seen from the above that the probe is to be thrust deeply into the lumbering industry, and the resulting report is certain to be of very great interest and value to everyone concerned, whether he be engaged in lumbering, or merely interested from the standpoint of one who is affected by the increasingly grave conditions that are touching more and more closely all Americans and every branch of American industry.

Government to Try Siberian Legumes Among the recommendations of the Senate Committee on Agriculture, in reporting the Agricultural Appropriation Bill, was one to the effect that \$10,000 be appropriated for the purpose of importing hardy forage plants from Siberia, such plants to be tried on the northern portions of the great plains areas. This is in addition to a recommended appropriation of the same amount, to be used in cooperation between the Department of Agriculture and the Reclamation Service in demonstrating the possibility of crop production on lands under the latter service. In its report the Committee said:

“The great need in all these regions (the northern plains areas) is for leguminous crops which will serve not merely to maintain normal husbandry, but to build up the soil, which otherwise will be utterly depleted by the single-crop system now in vogue.”

On several isolated, and relatively small, sections of the areas mentioned, experiments have already been made with one or more of the Siberian vetches; but these experiments have not been particularly successful, as a whole, although a measure of success has been attained in securing profitable stands of vetch. It is well known that the steppes of Siberia produce other legumes that are extremely valuable for forage; and it is also well known that these forage crops bear the long, hard winters of Siberia with no apparent ill effects. The question of over-grazing is one that has not, as yet, affected Siberia to any appreciable degree; and just how well these high-latitude forage legumes will stand transplanting and American grazing methods is problematical. However, it is certain that the native grasses have been so closely grazed—practically to the point of extermination—that some forage crop will have to be sown, if grazing is to continue as a profitable business. With an appropriation even as limited as the one recommended by the Senate Committee on Agriculture, a start can be made toward replacing grasses that are gone with a vigorous forage that may be adaptable to the conditions that exist over the northern portions of the range States.

Startling Words of Timber Expert

Ridicule of all sorts has been heaped upon Gifford Pinchot for his expressed opinions as to the quantity of merchantable timber remaining in the United States, and persons and publications having absolutely no knowledge of actual facts and conditions have waxed funny at the expense of the Forester and his published expressions as to the imminence of a universally disastrous timber famine. It is interesting to know that men fully acquainted with the facts share Mr. Pinchot's views on this question, and that some of them are willing to risk their professional reputations by going further than Mr. Pinchot felt safe

in going, in calling attention to the danger that confronts the country. We have been handed the following letter from William J. Wallace, a timber expert, of Duluth, Minnesota, which we commend to the careful attention of our readers:

"Having spent the past twenty years in estimating timber in different parts of the United States, I have had a fair opportunity to study the general timber situation and will say that the problem of forest preservation and reforestation is one that should interest every citizen of this country.

"It is safe to say that timber values have doubled in the United States in the past five years, and with the increased demand and the decreased supply, it must be plain to every thinking man that if reforestation does not take place it will only be a few years until the price of lumber will be beyond the reach of the common people.

"When Mr. Pinchot makes the statement that the forests of the United States will only last twenty-five years, I consider he has placed the time limit too far away for the remaining timber supply east of the Rocky Mountains.

"Take the State of Minnesota, for instance. Eighteen years ago, when I made my first trip to this locality, Minnesota, Northern Michigan and Wisconsin were, generally speaking, virgin forests. To-day the pine timber of Michigan and Wisconsin is practically a thing of the past, and the remaining timber, the hardwoods and hemlocks in those States, that the early lumbermen considered worthless, has become valuable because of the scarcity of timber and the greatly increased demand. The railroads of these States to-day are using hemlock and birch ties, which a few years ago were considered worthless. When the lumbermen get through in Minnesota, there will be even no worthless timber to fall back on, for the reason that nearly all of the logging done in this state at the present time is done by logging railroads, and all the timber that will measure 5 inches at the top end is cut into sawlogs, regardless of kind and qual-

ity. One by one the lumber companies are exhausting their present supply of timber, and it is safe to say that in less than fifteen years the great lumber industry of this section of the country will be past history.

"As we have no reliable figures, at this time, as to the amount of the remaining timber stumpage left in the United States, only those who have studied the situation are in any position to judge how long our forests will last. There is going to be a great increase in the consumption of timber in this country, and I think it will be safe to say that as much timber will be consumed in the next fifteen years as was consumed in the past twenty-five; so it is my opinion that if reforestation is not made a part of the business of the Government, State, corporation and private interests in the next few years, we will have a timber famine which will cause financial embarrassment to a great many of our industries.

"We know what has taken place in the states of Minnesota, Wisconsin and Michigan in the past twenty-five years, and with the increased demand, how long will the remaining forests east of the Rocky Mountains last? Billions of feet of timber have been cut in the last ten years in the southern states, and there are millions of acres of land there with no timber on it. The original stand of timber per acre of the Michigan, Wisconsin and Minnesota forests would, as a whole, average at least three times that of the southern forests, and I certainly believe that twenty years hence ninety per cent of the remaining timber of the United States will be west of the Rocky Mountains, and ninety per cent of the demand for the same will be east of the Rocky Mountains, so that the average freight rate added to the value of the western stumpage twenty years hence would give one some idea of the value of timber stumpage in any of the states east of the Mississippi River, if reforestation does not take place.

"There may be large forests of timber left in Canada, but we cannot fig-

ure on that, as Canada has already stopped the export of pulpwood and sawlogs to the United States; and if there is going to be a shortage in the future timber supply, Canada will certainly prohibit the export of timber products. So, therefore, it should be plain to all that the only remedy is forest preservation and reforestation.

"The largest corporation consumers of timber in the United States to-day are the railroads and mining companies, and reforestation should be as much of their present business policy as any department they have. If a substitute for a wooden railroad tie is not discovered, what will be the future of railroad stocks and bonds when the timber is exhausted? Very few corporation officials know anything of the general timber situation, nor do they know that timber can be planted at the present time, a small rate of interest charged against the investment, and with the present methods of creosoting and preserving a perpetual timber supply can be obtained at about the same cost as they are now paying. If every large corporation consuming timber in any quantity would set aside a small per cent. of its net earnings and invest in tree planting for its future use, it would greatly add to the value of such corporation's assets, and in a few years such corporations could say, 'we have a perpetual timber supply at a small cost and the public is safe in buying our stocks and bonds.'

"In my opinion every railroad in this country at the present time should have a tree growing for every two ties it

have in its roadbed, so as to allow something for timber destroyed by wind and fire.

"A census of the remaining timber supply of this country should be taken as near as possible every five years, without incurring too much expense; also a census each year of the number of trees planted by the Government, state, corporation and private interests, so that the public would know what progress is being made.

Respectfully submitted,

W. J. WALLACE."

Engineering Experiment Stations

It is evident that larger and more definite provision should be made for technical and scientific investigations at the Land Grant Colleges. The resources of the country should be properly developed and carefully and economically utilized. Much information is needed to make this possible. The prevention of waste of our forests, our sources of power, our fuels, our minerals, our materials of engineering and manufacturing and our labor need most careful and accurate investigation. The economical and safe use of materials, energy or processes can not be assured without continuous experimentation relating to the strength and durability factors of all materials entering into engineering structures or into manufacturing processes. It is more rational to invest money for facts at the start than to try to subsidize industries which need fundamental investigations—*The Industrialist*, Kansas Agricultural College.

SPECIAL NOTICE—In order that copies of the June issue of "Forestry and Irrigation," containing the complete story of the great White House Conference, may be as widely distributed as possible, a special low price has been made on such copies when ordered in numbers. All readers of this magazine, members of the Association, and friends of Conservation, are urged to take advantage of this special low price. See announcement in the advertising pages.

AMERICA'S GREATEST IRRIGATION SCHEME

BY

Agnes Dean Cameron, Vice-President Canadian Women's Press Club

Irrigation was practised on this continent long before the discovery by Columbus or the conquest by Cortez. The Indian was the first water-farmer, and the Canadian has the biggest irrigation scheme in America today. The scene of this gigantic project is in the new province of Alberta, where the Bow River sparkles through the cattle country of the Canadian foot-hills; in that great region where the peoples of all the earth are building up a Nation of the Plains, the country which claims the dual name of the Sirloin of Canada and the Bread-Basket of Britain.

EXPLODED THEORIES

The application of water to lands other than those which produce fruit has upset many theories of merchant, manufacturer, and agriculturist. These used to join in considering the large farm the only farm really worth while; now all three unite in the verdict that on every irrigated area a hundred farms of ten acres each will produce nearly a hundred times as much business as one farm of a thousand acres.

It is now an exploded theory that the advantages of irrigation are restricted to the hot, arid countries of the South. Irrigation is by no means confined to areas where the rainfall is so scant that nothing will grow without it. On the contrary, in many countries where irrigation has been brought to the highest state of perfection, the natural rainfall is very heavy. For example, the States of Iowa, Wisconsin, Illinois and Ohio, and the provinces of Ontario and Quebec, are generally supposed to be am-

ply supplied with rain and snow, and able to produce excellent crops under ordinary culture without the artificial application of water. Yet, in all of India, except the northwestern part, throughout China, Japan, Siam, Italy, France, and Mexico, where millions of acres are brought under irrigation, the rainfall is quite as heavy as in the States and Provinces mentioned, namely, from 23 to 51 inches per annum.

The average rainfall during the past ten years in the Provinces of Alberta and Saskatchewan, where irrigation by gravity is practised, is as follows: Calgary, 17.69 inches; Macleod, 13.18 inches; Medicine Hat, 15.83 inches; and Swift current, 16.40 inches. The average rain-fall of the State of North Dakota is somewhat less, being over 10 inches, but under 20 inches per annum.

DEVELOPMENT OF THE WATER IDEA IN CANADA

When the construction of the Canadian Pacific Railway was pushed across the Great Plains region of western Canada, in 1882-83, scattered settlements followed closely in its wake. By the time the line had reached the foothills of the Rocky Mountains, some of these settlements had been established in what is now the southern portion of the provinces of Alberta, and from them the cities of today have grown.

For many years stock raising was the only occupation of these settlements, the country having been found specially adapted to the grazing of large of cattle, sheep and horses during the whole year. But, by degrees,

small areas of land were brought under cultivation, especially in the valleys along the many streams, and this fact proved that the country during seasons of sufficient rainfall was well adapted to the growth of grain, vegetables, and fodder crops.

A series of dry years, commencing in 1892, with consequent crop failures, turned the attention of the settlers to the possibility of aiding the growth of their crops by irrigation. Such marked success followed their efforts

ume of the water supply available, and the location of the areas where such water could be used to the best advantage.

In considering the possibilities of irrigation in northerly latitudes, bear in mind the fact that the State of Montana, where the conditions are almost identical with southern Alberta, raises more agricultural products under irrigation than the States of Oregon, Washington and Wyoming combined; as much as the State of Utah, and half

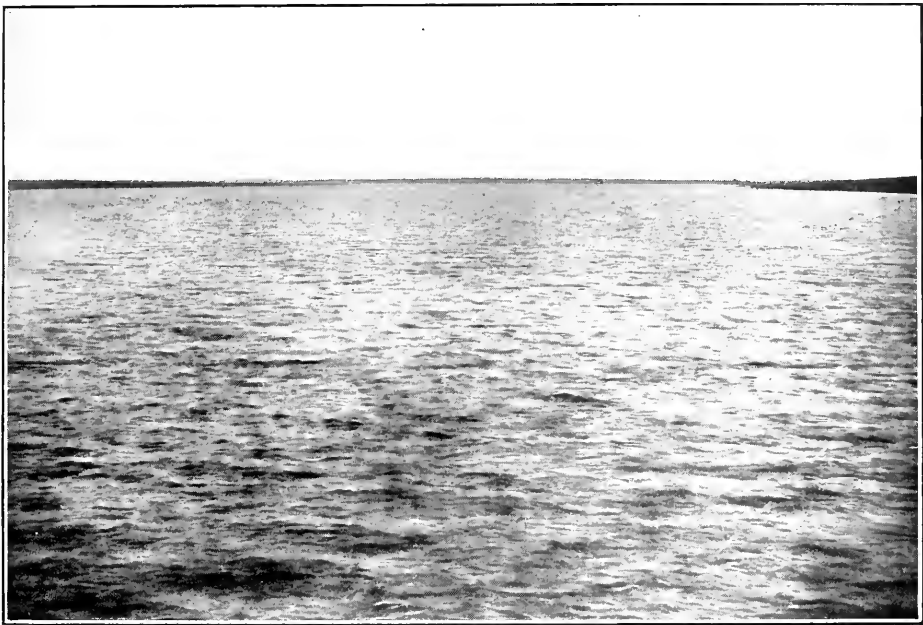

AMERICA'S BIGGEST IRRIGATION SCHEME

Reservoir No 1, Canadian Pacific Railway's Irrigation Plant, Calgary

that general attention was directed to this method of extending settlement and insuring crop production.

The question finally assumed sufficient importance to warrant its being taken up by the government, and, after careful consideration, and examination of existing conditions in the irrigated States to the south, a well considered and comprehensive law relating to the use of water for irrigation was passed, a system of general surveys undertaken to determine the source and vol-

as much as the State of Colorado. Enormous irrigation development is now taking place in northern Montana, by and under the direction of the United States Government, which will place that State in the front rank of irrigation countries. In fact, unmistakable evidence is visible on all sides to the effect that the largest area of irrigable lands in America will presently be found among the rich agricultural lands of northerly latitudes, under semi-humid climatic conditions.

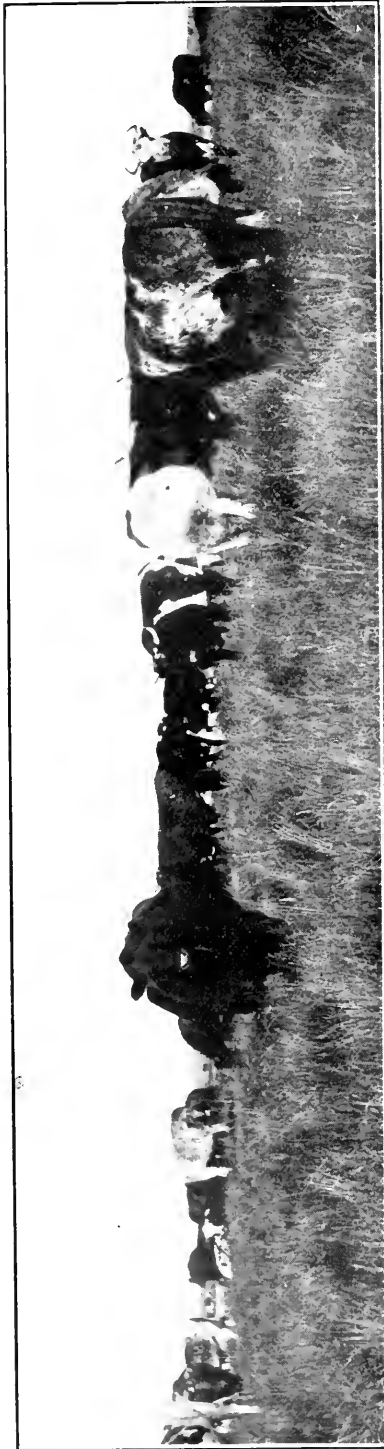

"Roast Beef of Old England" in the Raw

The area included in the Canadian Pacific Railway Company's irrigation project comprises a block of three million acres situated east of Calgary along the main line of the company's railway.

The block is an open prairie plateau with a general elevation near its western boundary of 3,400 feet above sea level, and slopes rapidly to the east until the elevation of 2,300 feet is reached at the eastern boundary. The surface throughout is more or less rolling until the eastern section is reached, where large areas of almost level plains are found. The whole block produces a most luxuriant growth of nutritious grasses.

Probably the most striking way of illustrating the magnitude of the area embraced in this irrigation block, is to offer some comparative facts. It is larger than the States of Connecticut and Rhode Island combined. It is twice as large as the province of Prince Edward Island. It is one-eighth the size of England and Wales; about the same size as the Hawaiian Islands, and twice the size of the island of Porto Rico. Fully half of this block is embraced in the company's present scheme of reclamation.

In developing the scheme the block has been divided into three sections, western, central and eastern, of about one million acres each; and the work is being carried on along the lines of development of sections, in the order named.

In the western section about 350,000 acres are to be brought under irrigation, and the following brief description of the works to supply water for this area will indicate the character and magnitude of the undertaking.

The water is diverted from the Bow River at a point about two miles below the city of Calgary. From there it is carried south and east through a main canal seventeen miles in length, which is sixty feet wide at the bottom, one hundred and twenty feet in width at the water line, and carries water to a depth of ten feet.

This main canal delivers water to a reservoir, for which a natural depression has been utilized; and where, by the erection of a dam, a body of water three miles long, half a mile wide, and forty feet deep, has been created.

From this reservoir the water is taken out in three secondary canals and carried to the different districts which are to be irrigated. These secondary canals are about thirty feet in width on the bottom, at their western end, and carry water to a depth of eight feet; their combined length being one hundred and fifty miles.

From these secondary canals the water is again taken out and conducted in each irrigation district through a comprehensive system of distributing ditches that bring the water to each 160 acres, or quarter section, of land to be irrigated. The combined length of these distributing ditches is about 800 miles.

To complete the western section, eight and one-quarter million cubic yards of earth must be moved.

The ultimate expenditure on this great undertaking is estimated at about \$5,000,000; which, taken in conjunction with the area of land in the block that it is proposed to irrigate, justifies the title given this scheme: "America's Greatest Irrigation Project."

The manner in which the work is being performed is vouched for in the following statement by Dr. Elwood Mead, late chief of Drainage and Irrigation Investigations, Department of Agriculture, Washington, the leading irrigation engineer authority on this continent:

"The chief problem of the main canal was to build a waterway which would be free from leaks and all danger of breaks. The precautions which have been taken to insure this are greater than those usually observed. The specifications for stripping the surface soil and packing the embank-



"Britain's Bread Basket"

ments are vigorous, and are being lived up to in all the work I inspected; and I have never seen more compact or uniformly solid banks than those being built.

"The soil of the irrigable areas is fertile, and well suited to the application of water. Taken in connection with the productiveness of the contiguous pasture land, it is certain that the cultivation of irrigated areas will be highly profitable, and will insure the creation of a large and prosperous agricultural community. The water supply is ample, and the rights of the company thereto are secure. The laws of Canada for the acquirement of water titles are equalled by few countries in the world in the specific character of the rights granted and the subsequent protection afforded appropriators. The filings in connection with the control of the land to be watered give the company a security and a freedom in carrying out its plans which is altogether exceptional."

CANADIAN WATER LAWS

The law of Canada concerning the rights of water-farmers has been declared by resolution of the American Irrigation Congress to be far in advance of any similar laws in the United States, and the Irrigation Office of the Department of Agriculture at Washington has issued a special bulletin calling attention to the good features of the Canadian law, and setting it up as a pattern which should be adopted by States within which irrigation is practiced.

The Canadian law is based upon the following broad principles:

(1) That all water is the property of the Crown.

(2) That applicants for the right to construct irrigation works must complete them within a stated time, and to the satisfaction of government engineers.

(3) That the amount of water to be supplied for any given area (at

present one cubic foot per second for each 150 acres), and the irrigation season (May 1 to October 1) during which such water must be supplied, shall be fixed by the government, and not left to the whim of any irrigation company or person selling water for irrigation.

(4) That all agreements for the supply of water for irrigation must be registered with the government.

(5) That any disputes regarding the division or distribution of water are settled by the government officials without the necessity of any appeal to the courts or bill of costs to parties making complaint.

(6) That parties complying with the provisions of the law, and granted the right to divert water, obtain a patent direct from the Crown for the water, which they can carry in their pocket, if they wish, as prima facie evidence of their title, and that any attempt to interfere with such title is prevented by government officials without cost to owners of the water patent.

The best proof of the fairness and stability of the Canadian law relating to irrigation is the statement that although irrigation has been practiced for ten years, and today in southern Alberta there are, including the Canadian Pacific Railway's project, eight hundred miles of canals and ditches carrying water for irrigation, there has not during that time been one law suit about water rights.

The canal constructed by the Canadian Pacific Railway Company has an absolute title under the Canadian law to two thousand cubic feet of water per second from the Bow River; and that river at the point of intake for the canal has never shown at its lowest stage, since government gaugings were commenced some years ago, a smaller flow than three thousand cubic feet per second. During the irrigation season the flow usually averages about six thousand cubic feet per second.



THE CALGARY SCHEME
Headgate of the Main Canal of America's Biggest Irrigation Works, in the Canadian Northwest

The source and volume of the supply are therefore assured, the title to the water is as good as the title to the land, and in addition the purchaser of an irrigated farm gets the guarantee of the Canadian Pacific Railway Company to supply him with water for all time.

This is the first time on the continent that water has been supplied for irrigation under such an absolute title and with such a guarantee.

SOIL OF THE BOW VALLEY

The soil throughout the whole of the irrigation block is first class, with a heavy black loam and clay subsoil in the western portion, and a lighter sandy loam, with good subsoil, in the more easterly parts.

Professor Shaw, editor of the *Orange Judd Farmer*, says:

"The first foot of soil in western Canada is its greatest natural heritage. It is worth all the mines in the mountains, from Alaska to Mexico, and more than all the forests from the United States boundary to the Arctic Sea, vast as they are. And next in value to this heritage is the three feet of soil which lie underneath the first. The subsoil is only secondary in value to the soil, for without good subsoil the value of a good surface soil is neutralized. One acre of average soil in the Northwest is worth more than twenty acres of average soil along the Atlantic seaboard. The man who tills the former can grow twenty successive crops without much diminution in the yields, whereas the person who tills the latter must pay the vendor of fertilizers half as much for materials to fertilize an acre as would buy the same in the Canadian Northwest, in order to grow a single remunerative crop."

CALGARY'S CLIMATE

"What is the climate like?" is a question which intending settlers in the irrigation block are sure to ask.

The winter in south Alberta is a season of bright sunny days, broken by short intervals of cold weather; with long spells when the western chinook winds bring almost summer temperatures. The snow fall is so light that as a rule wagons are used throughout the year, and the snow disappears entirely two or three times during the winter under the influence of the warm chinook. During February and the early part of March brief periods of cold weather are usually experienced, but from one month to six weeks of winter is the limit.

The marked characteristic of the climate of southern Alberta is the "chinook" wind, which is a warm, dry wind, blowing across the plains from the Rocky Mountains which bound the province on the west. This wind has the peculiarity of melting and drawing up the snow in winter seasons with amazing celerity, and to its influence may be ascribed the fact that southern Alberta has many times celebrated midwinter holidays with cricket, baseball, and other outdoor sports.

CROPS AND MARKETS

What is raised on the big water-farm? First is the never failing crop of stock, consisting of horses, cattle, sheep and hogs. The hackney carriage horses which took first prize at the Montreal and New York Horse Fairs were foaled and raised near Calgary.

The winter wheat grown in southern Alberta was awarded the first prize and gold medal at the Lewis and Clark Exposition, Portland, 1905, in competition with wheat of that variety grown in Washington, Oregon, and Idaho. Timothy, alfalfa, bromus and all fodder grasses do well and yield heavy returns. The sugar beet is produced in abundance, and of an exceptionally high quality, as will be noted from the fact that the average of purity and saccharine quality of the sugar beets raised in Alberta is: purity 80 per cent; and saccharine content, 16 per cent.



ALBERTA TIMBERLANDS
Lumbering in the foothills west of Calgary

The following statement from the Government Crop Bulletin for 1905 will be of interest as showing the *average* yield of grain in the Calgary district:

Wheat (spring)	33.92	bushels	per	acre
Wheat (winter)	32.18	"	"	"
Oats	43.41	"	"	"
Barley	32.01	"	"	"
Flax	28.64	"	"	"

Southern Alberta is favored in the matter of markets for its produce, situated as it is alongside the great mining and lumbering districts of her sister province of British Columbia, and

having the shortest and most direct outlet to the great markets of Yukon, Alaska and the Orient by the port of Vancouver. A steady and never failing market already exists for its general produce; and prime beef for many years has gone eastward across the continent to Great Britain.

Nature has done much for the rolling mesas of the Canadian foothills. It needs but man's enterprise and initiative to convert into a region of happy homes these erstwhile sites of Indian raids and old wallows of the buffalo.

IMPORTANT ANNOUNCEMENT

The June number of "Forestry and Irrigation" will contain the most complete account of the White House Conference, to be held May 13 to 15, inclusive, to be found anywhere. This report will be the live, crisp story of the greatest gathering of public men that has ever been held in

America. A special price has been made on copies of the June number, when ordered in quantities. Attention is called to the advertisement on another page, and all members of the American Forestry Association, and other readers of this magazine, are urged to take the fullest advantage of this offer.

WASTE OF NATURAL RESOURCES AND NEED FOR CONSERVATION

BY

Mrs. Lydia Adams-Williams, Member of the Women's National Press Association

FOR years and years and years, with that prodigality which ever characterizes those richly endowed, we have like profligates wasted and thoughtlessly destroyed the vast and apparently unlimited store of natural resources which a wise and beneficent Providence has placed at our disposal.

Facing the firmly established fact that in the space of a short half century our population will have increased to at least 150,000,000, and with the incontrovertible evidence that our natural resources are rapidly dwindling, the American people, with our indomitable President, Theodore Roosevelt, in the lead, have at last awakened to a realization of the enormous and dangerous waste. Further, the truth has been brought home that upon the fundamental basis of our natural resources rests the continuance of our unprecedented prosperity and phenomenal progress, and our power to advance the cause of humanity the world over.

With the view of comprehensively planning the most efficient means of utilizing and preserving our varied resources, a number of Government bureaus have been created, each one of which deals with a specific branch of the subject.

The United States Reclamation Service, which was created in 1902 to carry out the provisions of the Reclamation Act, has for its especial field the building of reservoirs and canals whereby the floods may be stored and the waters let out over the thirsty land, thus reclaiming the desert by irrigation, and providing homes for thousands of tillers of the soil.

The funds available for building are

derived from the sale of public lands in the States where reclamation work is done—both agricultural and mineral lands, and from water rights as these are progressively developed. During the twelve months ending June 30, 1907, \$25,248,641 were expended. During the present fiscal year not so much is to be expended, as the fund originally in hand has been largely reduced by the work already done. It will be replenished by the sums received from settlers, but these will not be turned over to the Reclamation Service until the end of the fiscal year. The estimates for the year ending June 30, 1908, amount to \$12,391,214; and for the last half of 1908, some four or five millions more.

At the present time about 250,000 acres of arid land have been reclaimed, and by 1910 the number of acres of irrigated land is expected to be 1,600,000. This area is equal to 80,000 farms of twenty acres each; or homes for three to five hundred thousand people.

Works practically finished are the Minidoka project in Idaho, the Umatilla project in Oregon, the Belle Fourche in South Dakota, the North Platte in Nebraska and Wyoming, the Shoshone in Wyoming, the Garden City in Kansas, the Huntley in Montana, the Carlsbad in New Mexico, and the Truckee-Carson in Nevada; of works which are under way, the largest now in hand are the Roosevelt dam in Arizona, the Gunnison tunnel in Colorado, the Shoshone and the Pathfinder dams in Wyoming, the Strawberry tunnel in Utah, and the Laguna dam between Arizona and California.

The National Drainage Association

is organized to further legislation whereby the large area of swamp land in the United States may be drained and reclaimed under the supervision of the Reclamation Service. The average cost of draining the swamp lands is \$5 an acre; and the 80,000,000 acres of these lands, in the various States from Maine to California, if drained, would furnish homes of 100 acres each for 800,000 families, or some 4,000,000 people; or farms of 20 acres each for 4,000,000 families, making 20,000,000 people.

In appointing the Inland Waterways Commission, the President planned for a comprehensive study of the vast inland chain of rivers and lakes, with a view of developing and utilizing these great waterways, thus opening the channels of trade and extending commerce in some forty of our richest and most prosperous States. A fourteen foot channel, as proposed, from the Gulf to the Great Lakes, would relieve the railway congestion, by taking over the bulky and non-perishable commodities of freight, and open the way for the fullest utilization of the benefits of the Panama Canal.

We speak of the mineral wealth of the West. But the gold, the silver, and all the products of the mines in the Rocky Mountains do not equal in value the waters flowing from those mountains, and practically all unused. Running to waste over Government dams, year after year, are 1,600,000 horse power, one of our greatest National assets.

Not being controlled, the water is free to come down in the wet seasons in floods. The damage from floods in the country is over a hundred million dollars a year. We shall have reached the ideal condition when we manage and control our rivers and streams as a city manages its water mains and hydrants; when, at the head-waters of our navigable streams are reservoirs of sufficient capacity to hold all the waters of the severest floods, so that we can shut off or let on at will any volume of water, thus maintaining an

equal flow and a required depth for navigation, and furnishing an assured supply for power plants, municipal purposes and irrigation, as well as preventing floods and droughts.

There is an enormous and dangerous waste in the using of our mineral fuel resources.

For instance, the railroads annually burn 150,000,000 tons of coal, of which only 5 per cent of the potential power residing in the coal is actually used; the other 95 per cent. being lost by wasteful mechanical methods. In the best incandescent electric lighting plants one one-fifth of 1 per cent of the potential power in the coal can, under our present methods, be converted into light.

If the rate of consumption of coal continues to increase hereafter as it has increased in the last ninety years, and there is reason to believe that it will do so, the anthracite coal will last about fifty years, and the bituminous coal a little over 100 years.

The consumption of coal by decades is as follows:

	SHORT TONS
1816 to 1825	331,356
1826 to 1835	4,168,149
1836 to 1845	23,177,637
1846 to 1855	83,417,825
1856 to 1865	173,795,014
1866 to 1875	419,425,104
1876 to 1885	847,760,319
1886 to 1895	1,586,098,641
1896 to 1905	2,832,599,452

As shown by the above figures the amount consumed in any one decade is equal to the entire previous consumption. This rate, if continued, means an increased consumption that no supply, however great, can withstand for many years.

The total tonnage of coal in the United States, exclusive of Alaska, is 200 billion tons. This amount of coal would form a cube seven and a half miles high, seven and a half miles long, and seven and a half miles broad; or it would form a layer of coal six and a half feet thick over the entire area of the coal fields of the United

States, 400,000 square miles in extent. Surely such a supply seems inexhaustible, and if the rate of consumption of 1905 were continued indefinitely without change, our coal would last approximately 4,000 years, but at the constantly increasing rate of consumption which has marked the past century, our coal will be practically exhausted within one hundred years.

The policy of the Government which, when the years have told their story, will be perhaps the most far-reaching of all, is that embodied in the National Forest Service; for the proper use of nearly all our other resources undeniably depends upon the forests.

The Forest Service estimates of the timber now standing in the United States, compared with the present rate of consumption, show a probable exhaustion of our timber supplies in a little over thirty-three years. These facts should convince the most skeptical of the immediate and vital necessity of using every means within our power to prolong the life of our forests.

That a realization of the truth is being brought home to us, is shown by the newspapers of the country. Says the *Chicago Inter-Ocean*: "One of the noteworthy signs of the times is that the American people are at last becoming awake to the importance of forest preservation, and reforestation, and the work of the Government Forest Service."

The question which most concerns the people of the United States to-day is the conservation of the hardwood forests in the Southern Appalachian and White Mountain regions. Statistics prove that there are lean years ahead, and that many industries will be seriously crippled by the shortage of hardwood timber, and that some will have to suspend entirely.

If the trees go, the soil on which they grow goes too. Senator Depew is one of those who have pointed out this fact. Before the United States Senate in 1902, Mr. Depew said in the rhyth-

mic flow of eloquence to which his colleagues delight to listen:

"The results of an attack upon the Appalachian forests, created by Nature for the protection and enrichment of the people, is more disastrous than the sweep of an invading army of savages over a thickly populated and fertile country. They kill, they carry off captives, they burn, and they destroy; but after the war is over the survivors return to their homes, and in a few years every vestige of the ruin has disappeared. In its place there are again cities, villages and happy people. But the lumber man selects a tract of hardwood forest upon the Appalachian Mountains. The trees, young and old, big and little, surrender to the ax and the saw. Then the soil is sold to the farmer, who finds abundant harvest in its primeval richness. For about three years, he gathers a remunerative and satisfactory harvest, but he sees, as the enormous rainfall descends, his farm gradually disappear. At the end of three years, he can no longer plant crops, but for two years more, if lucky, he may be able to graze his stock. At the end of five years, the rain and flood have washed clean the mountain sides, have left nothing but the bare rocks, have reduced his farm to a desert, and created a ruin which can never be repaired.

"But this is not all. That farm has gone down with the torrents, which have been formed by the cutting off of the protecting woods, into the streams below. It has caused them to spread over the farms of the valleys and plateaus. It has turned these peaceful waters into roaring floods, which have plowed deep and destructive gulleys through fertile fields and across grassy plains. One freshet in the Catawba River, last spring, occasioned wholly by the deforesting of the mountains, swept away a million and a half dollars' worth of farms, buildings, and stock.

"Negligence of this kind on the part of Congress becomes almost a crime. Those wonderful woods should have

been preserved not for speculators and bogus settlers, but for the whole of the country. They would, under scientific forest management, have been for all time to come not only self-supporting and revenue producing, but they would have been more—they would have been the source of supplies of wood for all purposes, for all the inhabitants of all the country. They would have been additions to the rural scenery, which in every State and country, when attractive, helps culture and civilization. They would have been the home of game, where sportsmen could have found health and pleasure. But, instead, the land will become an arid waste, the streams will dry up, and the country will lose not only one of its best possessions, but there will be inflicted incalculable damage upon a vast region which otherwise would have supported vast manufacturing and other industries, and which would have remained full of happy homes and cultivated farms."

THE SPENDTHRIFT

By Robert M. Reese, Washington, D. C.

I

Into my great inheritance
 I came when I was young;
 I spent it freely with both hands;
 I mocked, with jeering tongue,
 At those who sorrowfully said,
 "Beware! The end is near!"
 And, drunk with riches, shook my head,
 Regarding not their fear.

II

My squandered forests, hacked and
 hewed,
 Are gone; my rivers fail;
 My stricken hillsides, stark and nude,
 Stand shivering in the gale.
 Down to the sea my teeming soil
 In yellow torrents goes;
 The guerdon of the farmer's toil
 With each year lesser grows.

III

Lord! Of Thy bounty heedless still,
 My store of good I spend;
 Thy brimming cup I careless spill,
 Regarding not the end.
 My riches melt away like snow
 Beneath the April rain;
 And though my hand prepareth Woe,
 Yet may I not refrain.

IV

O stay my sinful hand and lend
 My falt'ring heart Thine aid,
 That these my spendthrift days may end
 And at Thy feet be laid
 The will to show the past retrieved,
 Thy gifts renewed, restored.
 That I have spent what I received,
 Thy pardon grant, O Lord!

NEWS AND NOTES

Widening Interest in Conservation From every section of the land comes indications of the ever-widening interest that is being taken, by people in every walk of life, in the problem of conservation. Organizations of all characters, associations of business men, lumbermen, chambers of commerce, granges, federations of women's clubs and scores of other larger or smaller associations of representative Americans, numbering in the aggregate hundreds of thousands of American men and women, have recently passed resolutions endorsing the conservation movement. FORESTRY AND IRRIGATION wishes it were possible to print all the resolutions along such lines that are received in this office; but to do so would be to take up the entire magazine and crowd out all other matter. However, we are printing herewith a few of the resolutions recently received, and mention of organizations that have endorsed the work of the Government along conservation lines.

Upholding the Government Following President Roosevelt's invitation to the State Governors to meet at the White House, Mrs. Lydia Adams-Williams, whose article on The Waste of Natural Resources appears elsewhere in this issue, addressed the District of Columbia Federation of Women's Clubs; and after her lecture the Federation adopted resolutions in support of the conservation movement. This Federation, comprising seventeen societies with 4,000 members, is the first among the Women's Club organizations to take action in this larger field. The resolutions are here reproduced:

Recognizing the incontrovertible fact, which has been too long neglected, that upon the fundamental principle of the conservation and development of all our natural resources, under the supervision of, and by the aid of the Fed-

eral Government, depends the continuance of our country's unequalled wealth, prosperity, and phenomenal progress, thus enabling us to advance the cause of humanity and civilization the world over, we heartily endorse and unreservedly commend the policy of President Roosevelt in his earnest efforts to preserve and develop all our natural resources.

To further augment the President's wise and beneficent policy, in utilizing our public lands and in securing the use of the water, the forage, the coal, and the timber for the public, we hereby pledge ourselves, individually and collectively, to assist by our pens and our influence, and to promote by all honorable means within our power, the branches of the United States Government devoted to these subjects, namely:

The United States Reclamation Service in its worthy efforts to reclaim the desert by irrigation and to build homes upon the land.

The Forest Service and the United States Forester, Mr. Gifford Pinchot, in his commendable plan to use and save the forests and to reforest the land, for "without our forests there would be no irrigation."

The Geological Survey in its efforts to utilize more economically the coal deposits which when once exhausted can never be renewed.

The Inland Waterways Commission with its plans for a fourteen-foot channel from the Gulf to the Great Lakes, thus relieving the railway congestion and opening new channels of trade and extending commerce in some forty of our richest and most prosperous States, and further preparing the way for our fullest utilization of the incalculable benefits of the Panama Canal.

And to further aid the United States Forester and the American Forestry Association by urging Congress to appropriate money for the purchase of the Southern Appalachian and White Mountain National Forests, that the numerous factories, power plants and other manufacturing industries, also the homes of hundreds of prosperous and contented tillers of the soil, may be saved from destruction by floods and droughts, of which the lowest estimate of yearly loss by flood alone is \$100,000,000.

And to aid the American Mining Congress in its efforts to open to homesteads and agricultural uses the mineral fuel lands, while still retaining their ownership by the United States for the benefit of the people.

And to further the work of the Drainage Investigating Committee, which plans to reclaim our eighty million acres of swamp lands, thus providing homes and tillable land for the 150,000,000 of people which a short half century will see within our borders.

To give all due publicity and aid to the Rivers and Harbors Congress which convenes at Washington, D. C., on December 3rd next; also to the Sixteenth National Irrigation Congress which meets at Albuquerque, New Mexico, in September, 1908; also to the Conference for the Conservation of Natural Resources, called by President Roosevelt, to meet at the White House, May 13, 14, and 15, 1908.

And again from the West comes a note of encouragement, when the Colorado State Forestry Association unanimously adopts the following preamble and resolutions:

"Believing that the movement, on the part of the friends of forestry, to establish National Forests in the White Mountains and the Southern Appalachian Range, is a matter of great moment and far-reaching in its benefits, not only to those adjacent to the regions affected, but to many material interests incident to our civilization and public welfare, and

Whereas, We desire to co-operate in every good work relating to forestry, and

Whereas, The people directly interested are appealing to the friends of forestry throughout the country to lend their influence and aid, Therefore

Resolved, That we, the Directors of the Colorado State Forestry Association, do hereby heartily endorse Senate Bill No. 2985, and House Bill No. 10457, now before Congress, and recommend their passage, and that ample provision be made for the purchase, by the United States Government, of the tracts described in the said bills; and be it also

Resolved, That a copy of the foregoing be sent to our Senators and Representatives at Washington, and that they be advised of our desire to have them support the measure and vote for its passage, and also that a

copy be sent to the presiding officer of both Houses of Congress, the Chairman of the House Committee on Agriculture, and the Secretaries of such Associations, as are interested in the enactment of this law."

The Eastern States Retail Lumber Dealers' Association, with a membership scattered throughout the entire eastern part of the country, recently met in annual convention in Washington, D. C. At the convention the following resolution was unanimously adopted, and copies of the paper were ordered sent to the President of the Senate, the Speaker of the House, and the Chairman of the Committee on Agriculture:

Whereas: It has been demonstrated that the communities, situated along the many great rivers having their sources in the lower Appalachian and White Mountains, will in time to come suffer great damage and loss, and their industries be practically destroyed if prompt and judicious steps are not taken to protect the watersheds and properly preserve the timber upon the mountain slopes, and

Whereas, The estimates published by the Department of Agriculture indicate the rapid disappearance of our timber supply for which the country is now looking largely to the Appalachian forest.

Resolved, That we, the Eastern States Retail Lumber Dealers' Association, in convention assembled, submit to Congress the urgent necessity of adopting one of the measures now before the House of Representatives, having for their object the purchase of what is known as the lower Appalachian and White Mountain Forest Reserve."

The Los Angeles Chamber of Commerce has forwarded the following resolutions to California Representatives in Congress:

Whereas, The Los Angeles Chamber of Commerce has been most active, in the past, in furthering legislation looking to the preservation of forests,

forest reserves and watersheds in California, and

Whereas, The American Forestry Association is making an effort to have bills passed, now pending before Congress, looking to the acquirement of National Forests in the Southern Appalachian Mountains and White Mountains, and appreciating the vital importance of such legislation, therefore be it

Resolved, That the Los Angeles Chamber of Commerce hereby respectfully suggests that our representatives in Congress support H. R. 10457, introduced by Mr. Currier."

The Committee on Forests of the New York Board of Trade and Transportation, composed of Edmund Philo Martin, Peter E. Schofield, John H. Washburn, Lewis Nixon, William Jay Schieffelin, Clarence G. Stone, William F. Oatman, and Henry S. Harper, in submitting a report to the Board, recently said:

"The continued deforestation of these reliefs (the White Mountains and the Appalachian system) cannot, therefore, fail to work to the disadvantage of the great manufacturing and all other industries dependent upon the proper flow of their rivers and tributaries. When competition between the most advanced nations has not only reached a stage unprecedented in the history of the commercial world, but gives every indication that it will grow more severe, owing to the forceful and intelligent leadership of those engaged in this mercantile rivalry, no advantage, either acquired or natural, which any section of the country possesses, should be sacrificed or needlessly wasted.

"These observations have a special application to the region watered by the river system of the southern Appalachians. Raising such a large proportion of raw cotton, one of the most valuable gifts of nature to mankind, with a native population peculiarly adapted to its successful cultivation, a favoring climate, and with water and electric powers practically unlimited,

if wisely conserved and applied, its manufacturers should in time be able to wrest from the nations of Europe the cotton trade of the peoples and nations inhabiting the countries and islands washed by the Pacific Ocean, and now constituting more than half the population of the globe. Great as it is at present, it is insignificant, as to what it must be, when the East awakens from the lethargy of its ancient civilizations and enters upon the march of Western progress."

The Committee concludes with the following resolution, which was unanimously adopted by the Board:

"Resolved, That the New York Board of Trade and Transportation most heartily endorses the proposition to create the Southern Appalachian and White Mountain reserves, and requests the Committee on Forests of this Board to urge the passage of such one of the pending bills as in its judgment will best serve the public interests and prevent the diversion to private or corporate interests of the benefits to accrue from such forest reserves when created."

The Pomona Grange of Oregon has adopted resolutions demanding a change in existing laws concerning water rights, both for power purposes and irrigation, and the resolutions adopted call on every legislative candidate to make clear, in a public statement, just how he stands on the question of water preservation.

The Toledo, Ohio, Federation of Women's Clubs recently adopted resolutions declaring that the best interests of the country demand the conservation of natural resources—timber, water and mineral—and unqualifiedly endorse the plans for the Appalachian-White Mountain forest reserves.

The Association for the Protection of the Adirondacks, headquarters in New York City, in resolutions, expresses its earnest approval of the Appalachian-White Mountain bills and memorializes Congress to that effect. The memorial calls renewed attention to the danger that menaces the

eastern parts of the country from the effects of the progressive deforestation now and for years past destroying the woods, the waters and the soil of the whole region east of the Appalachians, and also, in almost equal degree, the regions lying on the other side of the mountains; and Congress is urged to take warning from the fate of the deforested countries of the Old World, so that steps may be taken to avoid in this country such conditions as now exist in the countries of Europe and Asia.

The Detroit New Century Club has heartily and unanimously endorsed the Appalachian-White Mountain bill, and has so written to the members of the House Committees on Judiciary and Appropriations.

The two House committees have also received letters over the signature of every prominent manufacturer in New England, these letters expressing the conviction that the proposed forests reserves should be established without further delay. The men signing these letters represent industries capitalized far up in the millions of dollars, and they are all actively engaged in business that is vitally affected by the conditions of streams rising in the mountains where it is sought to locate the reserves.

The following was adopted by the National Executive Board of the D. A. R., at the convention in Washington, in April:

"Recognizing that a timber famine is almost at hand; also that the health of the people, and that water power for navigation and for vast manufacturing interests; also that electrical energy for heating and lighting our homes and for culinary purposes; also that the conservation of the natural resources of the country, are all dependent upon the preservation of the forests,

Resolved, That the National Society of the Daughters of the American Revolution unqualifiedly endorse President Roosevelt's far-sighted policy of conserving all the natural resources, including the forests, and that

we will use all honorable means within our power to further the passage of the bill now before Congress, which provides for acquiring national forests in the Southern Appalachian Mountains and White Mountains."

Floods The flood season is again on. Spokane dispatches of March 16 reported the Coeur d'Alene at three feet, and dwellings along the entire length of the St. Joe abandoned, the people taking to the uplands. All docks had been washed away, and rain was still falling in sheets. Lewiston, Idaho, was isolated, and more than two miles of track and many bridges were washed out on the line of the Potlatch Creek. The Pine Creek Lumber Company had lost a \$100,000 dam and more than 1,000,000 feet of logs. Other damage was reported. On March 19 the Monongahela and Allegheny were on the rampage, with the flood stage of thirty-three feet expected the following day. Merchants were moving their wares out of the danger zone. Railroad schedules were badly disarranged on account of numerous landslides. Eight miles of Pennsylvania passenger track were out of commission.

Contrast experiences like this with the statement of Chief Hydrographer Leighton, of the United States Geological Survey: "Our rivers should be controlled in much the same manner that we control city water."

The world is learning that what, in ignorance, it once assumed to be mysterious visitations of an inscrutable Providence are, in fact, effects which can be traced directly to causes which, in turn, can be removed. Diseases which once swept away thousands have been practically abolished. Distance is being largely annihilated by modern transportation facilities, and time, by modern methods of communication. Instead of continuing the plaything of omnipotent and merciless natural forces, man is learning to master his environment, and make of

these same forces his obedient and vastly serviceable slaves.

From the standpoint of those who know, floods are superfluous. There is no more need of the periodical inundation of great areas of fertile land, the sweeping away of mills, factories, railway tracks and residences, and the destruction of lives by river overflows than there was need for water pouring, at every rain, through the roof of the patient native interrogated by the "Arkansas Traveler." The up-to-date man mends his roof before the rain comes. When, as a nation, we get up to date, we will mend our river systems before the floods come.

No informed man claims that forests alone will completely prevent all floods. The forest, however, is a potent factor in flood prevention. Reservoir systems, well understood by engineers, are other factors. Here, as in the case of the roof and the pestilence above referred to, the remedy is incomparably less expensive than the disease. Which shall we have?

Disastrous Flood in China Two thousand persons were drowned at Hankow, China, on the night of April 12th, by a sudden freshet which swept down on the city and flowed over the dikes which protect it. The inhabitants asleep in their homes had but little chance of escape. Hankow is a city of 800,000 inhabitants, situated at the junction of the Han with the Yang-tse-Kiang, about 450 miles west of Shanghai.

The towns of Craig, Cascade, and Great Falls, Montana, were menaced by a flood that swept down the Missouri River on April 15, and great damage, as well as considerable loss of life, occurred along the course of the upper Missouri. The flood was caused by the breaking of the Great Hauser Lake dam, and this, occurring in the night, gave little opportunity for those exposed to the flood's fury to remove their household goods, their live stock, or, indeed, to save more than their lives. The impounded wa-

ters had been largely augmented by rains and by the rapidly melting snow from the mountain sides, and the structure of the dam was not strong enough to stand the added strain. The mountain slopes surrounding the Hauser Lake dam site have been practically denuded of forest growth, and there is nothing to prevent the melting snow and the excess rainfall from pouring directly and rapidly into the river and its tributary streams.

At Great Falls the Boston and Montana smelter, one of the largest in the world, was seriously damaged, while the flood loss along the entire upper reaches of the Missouri, from the breaking of the dam, runs far into the thousands of dollars.

Peat Briquettes for Mexico's Fuel

Word comes from the City of Mexico to the effect that an American company has undertaken the manufacture of briquettes from peat. The increasing difficulty of supplying the capital city of the Republic with wood from neighboring forests whence its fuel has come since the days of Cortez, has led to this project of utilizing deposits of peat which have long been known to exist in the vicinity.

Eighty years ago Humboldt described magnificent forests within reach of the City of Mexico. To-day the region supports only a second growth of little value. The change has been brought about by wood cutters and charcoal burners who have stripped the land and left it to reforest itself if it could, or to relapse into waste. Thus neglected, the land could not grow timber to meet the demands upon it, and the woodcutters have little or nothing near to cut.

Fortunately large bogs of peat are within reach. It has never been much used for fuel because the Mexicans never took pains to learn how to burn it. The company which has undertaken to manufacture the bog fuel into briquettes has made large investments in land and machinery.

Better Figures Soon Available . The average man usually has a very hazy idea as to the rapidity of growth of trees. In fact, until recently very little accurate information had been gathered which could throw light on this very important aspect of American forestry. The value of a forest is not merely the standing timber which it contains, but it includes also the power to produce a future crop. The study of tree growth has a very practical purpose, that of measuring this producing power of forests. It is only through this knowledge that the forester can determine whether or not forestry will pay.

To gather enough information to furnish complete figures of growth even for such of our trees as are at present of commercial importance, would be a vast undertaking and would involve a greater outlay of money than can at present be made. The United States Forest Service has, however, made a large number of local studies of growth which serve well as a first step in this direction. While the figures at present available are not claimed to be complete or final, they are of great use to foresters in working out problems of forest management.

In an old publication which has a large circulation among handlers of lumber is given a table showing the sizes of different kinds of trees at the age of twelve years. According to this table the diameter of a birch tree at this age is ten inches and its height twenty feet. The height is approximately correct, but the diameter given is several hundred per cent too high. The actual diameter would be from one to three inches, depending on the kind of birch, situation, and other factors. Again, silver maple is given a diameter of twelve inches, whereas the true size should be about three and a half inches.

The Forest Service is preparing for publication a "Preliminary Synopsis of the Rate of Growth of Forest Trees" in which is given a summary of the figures of growth so far obtained and worked up. The most important trees in each of the forest regions of the

United States are given, together with the sizes which they attain at ages of 30, 50, 80, 100, 150, and 200 years. While the figures for different species should not be compared too closely, they will admit of rough generalization which will be of considerable value.

Prize Winner James D. Schuyler, of Los Angeles, the prominent hydraulic engineer, has achieved the distinction of being the first member of the profession twice to receive one of the principal honors bestowed by the American Society of Civil Engineers. This is the "Thomas Fitch Rowland Prize" given annually to the member or engineer who contributes the most noteworthy paper describing in detail accomplished work of construction. Mr. Schuyler, who is the author of a standard work on Dams, has been advised that he has received the 1907 award for his paper entitled "Recent Practice in Hydraulic-Fill Dam Construction," a contribution to science which has created a stir among engineers throughout the world. He had previously won the prize for his paper, "The Construction of the Sweetwater Dam."

Reports Successful Initial Year The new School of Forestry at the University of Washington, Seattle, reports a successful initial year, and interest in the course is developing in a very satisfactory way. Eighteen students have enrolled in the School, nine of whom are in the full course. Although instruction in forestry has been given at the University since 1895 the work was not placed on an independent footing until the present year. Full announcement of the plans and aims of the School will be made in the catalogue, which will be ready for distribution by May first.

Three courses are outlined. One, a four year undergraduate course, designed more especially for those who wish to enter on a business career in some phase of the lumber industry, but who wish first to have the advantages of a university training; also for those

who expect later to enter the profession of forestry. Second, a two year graduate course, designed especially for those who expect to enter the profession of forestry. Third, a short special course of twelve weeks designed for forest rangers who wish to increase their efficiency, or for those who wish to fit themselves for ranger duties; also for logging superintendents, woodland owners and others desiring a general knowledge of the principles of forestry, but who do not have the time to enter on a full course in the subject. The United States Forest Service co-operates with the University in offering this short course and will detail experts to give several of the special subjects. The others will be handled by various departments of the University. This course will be given next year for the first time, opening Tuesday, January 5, and closing Friday, March 25.

The School has exceptional advantages in its location. The University campus comprises 355 acres, a considerable portion of which is in timber and offers splendid opportunities for field work in silviculture and forest measurements. Other excellent forests are within walking distance of the campus. The University also owns large forest tracts in various parts of the State, where students may conduct extensive research work. The immense National Forests, within a few hours' ride of Seattle, afford practical object lessons in the art of forest management. The city of Seattle is in the center of the timber industry of Washington and the Northwest. In its sawmills and wood-working industries, the student has unrivaled opportunities for studying wood utilization.

In 1905 the United States Government, through its Forest Service, designated the University of Washington as a government timber-testing station. A timber testing engineer and a corps of assistants are stationed there, and extensive scientific tests of the strength of western timbers are regularly carried on. Students of forestry are given the privileges of the testing

laboratory and have ample facilities for making investigations in the physical and mechanical properties of wood.

Prof. Frank H. Miller, for four years head of the department of forestry in the University of Nebraska, and who is a member of the U. S. Forest Service, is in charge of the new School of Forestry in the University of Washington.

Colorado Farmers Want Forests

At Longmont, Colorado, the farmers of that vicinity and the business men of the town and section have adopted resolutions in favor of the Government control and preservation of the forests of the watershed of the St. Vrain Valley as a means of maintaining and regulating the flow of the streams which furnish water for irrigation.

The Fruit Growers' Association in the preamble to its resolutions declares that it is necessary for successful fruit growing in this section of the State of Colorado to have an abundance of late water for irrigation, and to secure such water they want the watersheds protected with trees.

How Can Irrigation Be Improved?

Gov. Albert E. Mead is considering a plan to ask the next Legislature of Washington to provide a State fund to be used, in co-operation with a like amount appropriated by Congress, for a study of the problems confronting water-users in various parts of Washington.

Mr. Samuel Fortier, who is at the head of the Government irrigation investigations, and was, till recently, stationed on the Pacific Coast, says:

"I do not think I am mistaken in stating that the economical use of the available supply in the arid and semi-arid portion of Washington transcends all others in importance. The object of our investigations is to produce the most valuable yields with the smallest amount of water."

Mr. Fortier quotes from a report by O. S. Jaynes, who is at the head of

irrigation investigations in the State: "The earlier ditches, and, in fact, most of the now existing ones, have been more or less carelessly built, while as a rule the methods employed in the distribution and application of the water have been such as to lead to needless extravagance and waste. As a result of the practices which have obtained, thousands of acres of land have been ruined by over-irrigation, while thousands more that might have been providing homes and producing wealth have been lying idle and worthless for lack of water."

Manufacturers Take Note of Forestry On May 15th will occur in New York the convention of the National Association of Manufacturers. Forestry will be one of the chief subjects considered at this meeting. Preparatory to the meeting the organ of the association, *American Industries*, published in St. Louis, is making a special feature in each issue of one or other of the topics that are to be most discussed at the meeting. One such issue will be devoted to forestry.

Mrs. Williams to Speak at Boston Mrs. P. S. Peterson, of Chicago, Chairman of the Forestry Committee, General Federation of Women's Clubs, has invited Mrs. Lydia Adams-Williams to speak on the topic "Waste of Natural Resources and Need for Conservation" at the biennial meeting of the Federation to be held in Boston in June.

A Labor of Love Col. Jos. H. Acklen, of Nashville, Tenn., serves his State as warden of the Department of Fish, Game and Forestry without compensation. The Department was created by the Legislature in 1905. Col. Acklen was appointed for eight years. He is one of the very few state officials in America who work without compensation. An exchange says: "All of our present admirable laws for the protection of the game, fish and forests of Tennes-

see were drafted by him. The beneficial effects of these laws which his wisdom, ability and energy have placed on our statute books are already felt, and the people owe him a debt of gratitude for his work which some day they will undoubtedly pay."

Argentine Republic to Protect Forests South America is beginning to show the world that she recognizes the value of her natural resources. The Republic of Colombia has already outlined a forest policy, and now the people of the Argentine Republic have taken up the discussion of forestry and its application to the country's rich hardwood timber areas. So far the destruction of valuable fruit trees has received more attention than that of forest trees. The following is from an article which recently appeared in *La Nacion*, and was translated by the Buenos Aires *Herald*:

"It is not only in the province of Buenos Aires that the ancient tree plantations are being destroyed; the evil has spread to the remotest inhabited corners of the republic. In a recent journey to and through the provinces of the interior, I have found on every hand the effects of the savagely reckless felling of timber and the censurable carelessness of the authorities who allow it. The destruction is general, the finest specimens of our indigenous trees have been ruthlessly sacrificed; not only those of spontaneous growth, but also those planted by our ancestors on behalf of their posterity.

"As for Tucuman, the Tucuman of poetic legends mentioned by Avellaneda, it is today almost unrecognizable. It would no longer be true to repeat his words where he says: 'The orange and lemon tree which produce in rich abundance flowers and fruit, perfuming the ambient air, feeding the inhabitants and affording them a house and a home, are most beloved by them as the emblem of the felicitous union of the useful and the beautiful.' No; even the famous and magnificent or-

ange trees of the city plaza have disappeared to make way for more pretentious plants that, unfit for the climate and inappropriate for the spot, present the feeble and insignificant appearance of weazened and sapless consumptives."

From the destruction of the fruit orchards to that of the forests is but a step. The work of the United States Government in protection is attracting attention there. So far, happily, the damage done to the forests is comparatively slight. The enormous lumber resources of the country are with few exceptions as yet practically untouched, and Argentina has a splendid opportunity to show its wisdom and foresightedness by taking this action before it is too late.

Lumber Losses from Fire An important statement regarding losses by fire to the lumber trade for 1907 is sent out by the Lumber Insurers' General Agency, of New York, compiled from the files of the *Journal of Commerce*. It shows that the number of fires in which the loss was not in excess of \$10,000 each in the United States and Canada last year was 332, with total losses of \$12,623,000. Allowing 15 per cent for small and unreported fires, the average monthly loss reached \$1,209,712 and the total loss \$14,516,550. While these figures look large, the year was in reality favorable to the lumber business, indicating that the better methods of fire protection prevailing in the lumber industry have had their effect.

THE CRY OF THE PINES

By Anne McQueen

Listen! The great trees call to each other:
 "Is it come your turn to die, my brother?"
 And through the forest, wailing and moaning,
 The hearts of the pines, in their branches groaning—
 "We die, we die!"

"We, who have watched the centuries dying,
 The span of years as an arrow flying,
 Ages seeming a day and a morrow;
 Lo, we have reached the time of our sorrow—
 We die, we die!"

"We, who have stood with our ranks unbroken,
 Breasting the storms, a sign and a token
 That the gale must cease; and the wild winds staying,
 Man, we shielded, is come, and is slaying—
 We die, we die!"

"Flaying the bark, and our bodies baring;
 Like dim white ghosts in the moonlight staring,
 Naked we stand, with the life-sap welling—
 Tears of resin, to gather for selling—
 We die, we die!"

All over the land are the forests dying,
 One piece of silver a tree life buying.
 Listen! The great trees moan to each other:
 "The as has scarred me, too, my brother—
 We die, we die!"

—Uncle Remus's Magazine.

WITH MEMBERS AND CORRESPONDENTS

Southern Timber is Almost Gone

The following letter received from H. C. Putnam, of Eau Claire, Wisconsin, gives some facts concerning the forest situation in the Southern States that are worthy of the most serious consideration:

"On my return from Florida I found your recent favor, and at once wrote my friend, Hon. J. J. Jenkins, a mighty strong letter on the subject of the forestry bills—not only the Appalachian-White Mountain bill, but that other very important one, the timber census bill.

"Of course, I know the House is crowded with bills, many of them 'dinkey' ones to us who are interested in the forestry and water supply measures. I know the Appalachian country well. Am an old civil engineer, and was eight years in the mountains of the Carolinas and Georgia. It is appalling to think of that country being in the condition of the lower Potomac River, and it will be worse if the waters all run off at once as they do from the head of the Potomac, because the soils are poorer, and, the sources being higher, the streams are more rapid. I was also an engineer on the Mount Washington road in the early '50s, and remember well the timber we worked in. I was there again in 1894, and saw what had been done, and how the waste of soil, etc., was going on.

"Forester Pinchot says 'the timber will all be used up within twenty years.' I have been in the timber, south, all winter, and he is right. Three-fourths of all the timber in the south has been turpented already. That means dead, and must be cut. I saw many small mills cutting and selling lumber—the best they could get—for \$10 per thousand feet, mill run, and only sawing the best. The best in 1906, sold for \$20, mill run—now it is \$10. We have 240,000 acres

in LaFayette County, Florida, that we are trying to save from the ax and the turpentine still.

"Sincerely yours,
"H. C. PUTNAM."

Is Much Appreciated

Mr. E. L. Kill, Master of Science, Department of the Collegiate Institute at Guelph, Ontario, writes, "FORESTRY AND IRRIGATION is much appreciated."

Prevention of Forest Fires

A correspondent, writing from Capron, West Virginia, thinks the Government does not take a sufficiently active part in the prevention of forest fires, and speaks of the annual burning off of forests to improve pastures. The Government can not well take control in such matters where the forests are privately owned and the prevention of forest fires, as our correspondent should know, forms a large part of the rangers' work, during the summer and autumn months, on National forest areas. The letter follows:

"If the Government is really in earnest about forest preservation, then let it get after the fire bug, not in the national reserves alone, but in every state in the Union. The National Government has no power? Well, then, if they cannot make any laws that will give them the power the forests are irretrievably lost, for the states will not enforce the laws. Our mountains are burned off *every* year. The people burn them to improve the cattle and sheep range. Of course it kills the timber, but then the timber does not belong to them. There is a man here who has the woods fired so the huckleberry will not be *shaded* and consequently bear better, which means more feed for his hogs. There are the people who keep the woods fired regularly. The hog people are worse than all the rest put together. If we had laws by which hogs would not be

allowed to roam at large our fires would almost cease; but the hog owner is a voter and his name is legion. Unless the National Government can bring some pressure on the State Legislature our forests will simply be ash piles.

"Yours truly,
"V. P. KELLER."

Range of Topics Treated A California correspondent interested in irrigation sends a copy of a newspaper containing an article on reforestation, regarding which he says:

"I took the liberty of quoting the very able and impressive article on reforestation which appeared in a recent number of your magazine. I am very much pleased with the range of topics and the very thorough way in which each one is treated in the magazine."

Kentuckians Becoming Interested The Kentucky State Department of Agriculture, Labor and Statistics writes for certain literature on forestry matters and says that interest in this subject among the citizens of Kentucky is increasing greatly. A bill is before the General Assembly at the present time to start forestry work in the State.

Recognize Value of Forestry There was a time when business men, such as lumber manufacturers despised forestry, but they now recognize its practical value. One instance of this was at a convention where a prominent southern dealer in lumber and timber publicly stated that had his company and several others known earlier the things which Mr. Pinchot told them at that convention, and if they had done business according to the ideas advanced at this time by him, they would have saved more than a million dollars.

The following quotation from a letter by Mr. W. O. McGowan, of Waycross, Ga., dealer in lumber and timber, and general superintendent of the Southern Pine Company, is indicative of this:

"Yes, sir, while Vice-President and Chairman of the Southern Industrial Congress in Washington, I invited a delegate from Texas to the chair and then made some remarks in support of the resolution relating to the United States Forestry Service—using about the expression Mr. Richards refers to: 'There is no doubt that had ours and several companies done business according to the ideas advanced in my talk with Mr. Pinchot they would have saved more than a million dollars.'"

THE BRAVE OLD OAK

From "Our Familiar Songs," by Helen K. Johnson. Copied by permission of Henry Holt & Co

A song for the oak, the brave old oak,
Who hath ruled in the greenwood long;
Here's health and renown to his broad
green crown,
And his fifty arms so strong!

There is fear in his frown, when the sun
goes down,
And the fire in the west fades out;
And he showeth his might on a wild
midnight,
When the storms through his branches
shout.

Chorus:

Then sing to the oak,
The brave old oak,

Who stands in his pride alone;
And still flourish he,
A hale green tree,
When a hundred years are gone.

He saw the rare times when the Christ-
mas chimes
Were a merry sound to hear,
And the squire's wide hall, and the cot-
tage small,
Were full of English cheer.

And all the day, to the rebeck gay,
They caroled with gladsome swains.
They are gone, they are dead, in the
church-yard laid,
But the brave tree still remains.

Chorus: Then sing, etc.

AN INLAND WATERWAYS SYSTEM

Part of an Address before the California State Farmers' Institute

BY

Dr. Clarence B. Edwards, of the California State Promotion Committee

NOTHING is of greater moment in the political economy of the present than inland waterways. We have had a railroad era, which, sweeping on to its full tide, has forced its own limitation; for so great has become the development of the country, through railroad progress, that all lines are now taxed to supply the means of getting the products of that development to market. As a result of these pressing conditions, the navigable waterways of the country are occupying a large place in the public mind, as the logical and practical relief for a condition that is becoming unbearable.

It is realized that the congestion of freight of the railroads of the country must be relieved through the waterways. Millions of tons of the heavier commodities can be transported by slow water routes, thus permitting the railroads to transport the more valuable freight rapidly and expeditiously.

Germany long ago recognized the vast importance of her inland waterways, and as a result every city in that empire is connected with water transportation. On her 3,700 miles of natural waterways and 5,000 miles of artificial waters, the German government has expended the sum of \$1,400,000,000, yet the German empire has an area of but 208,000 square miles, while California alone has an area of 160,000 square miles, and the United States as an entirety has expended but a little more than one-third of the sum that the German government has found available.

What this development of Germany's waterways means is shown in the fact that through this wonderful inland waterway system that nation has developed an inland commerce exceeding her outside commerce of 2,-

250,000 tons annually. France has so thoroughly recognized the importance of water transportation that she has expended upon her harbors alone the vast sum of \$155,000,000.

The moment seems to have arrived in the United States for a concerted action of all the people of the Nation toward the betterment of inland waterways. Certain movements, great epochs in history, appear to spring full panoplied into being and astonish the world with their completeness. Such movements have been nurtured long in the minds of a few earnest and studious men who have worked out the problems to satisfactory solutions, and then have educated the people to conditions, so that when public announcement has been made the whole world grasped the idea and adopted it. So it is with the improvement of the inland waterways of the United States. These problems have been occupying the minds of studious men for years, and now they are prepared to ask for concerted action by all the people, and the people are ready for the opportunity.

Permit me to quote from an address delivered by Major T. G. Dabney, chairman of the Commission of Engineers, which investigated conditions in California, before the River Improvement and Drainage Association of California, in August, 1904. Major Dabney's remarks are of peculiar value as they show the great work accomplished in the improvement of the Mississippi river, and show how similar work can be carried to successful conclusion in California. Major Dabney outlined the sporadic and individual efforts of the people along the great waterway to protect their lands, and to restrain the floods, and showed

their ineffectiveness. He then pointed out that a comprehensive plan, embodying a vast problem and an immense outlay of money, was devised, which could not be carried out in its entirety, owing to the fact that such immense sums could not be made available; then, when the people were almost despairing of successfully coping with the problem, it was proposed to begin the work by units, gradually combining them into a harmonious whole. The success of the first unit was shown, and Major Dabney says the following of the result:

"The accomplishment of this work at once inspired the people with renewed hope and energy, and the wheels of industry began turning rapidly. The next Legislature, in 1886, authorized a bond issue of \$400,000. From this period the industrial development of the district progressed in accelerated ratio. Forest lands were cleared; railroad building became more and more active; numerous small towns were built up along the railroads, some of which have grown into industrial and financial importance, and all are thriving business places; a great many banks were established and all appear to be thriving; numerous saw mills, besides wood factories of various sorts, with numerous outputs of lumber and wood products were built; many cotton compresses and cotton oil mills are engaged in profitable activity; and flourishing cotton and corn crops are being raised on land which shows river flood marks twenty feet above the ground."

"It is interesting to note," continues Major Dabney, "that the California Debris Commission has recommended a joint appropriation by the United States and the State of California of \$800,000, which it is proposed shall be applied to the initiatory step in the execution of the plan of reclamation recommended by the California Commission of Engineers in the Sioux City report—that is, to channel rectification. The Commission of Engineers estimated the total cost of the reclamation of the Sacramento Valley at

about \$23,000,000, and recommended that the whole amount be provided for before the work should begin.

"Taking an object lesson from the fortunes of this levee (the Yazoo district of the Mississippi River) it may be said with assurance that had it been proposed in 1884 to finance the whole project in advance this enterprise would never have gotten on its feet at all. As the event shows, however, the undertaking advanced step by step, growing stronger with each advance, and so better able to carry the burden, until it is now approaching consummation and is fully justified by resultant benefits."

Major Dabney thus emphasizes the importance of the unit system of work for river improvement; and while the report of the California Commission of Engineers, which he has quoted, gives a broad, comprehensive and complete plan of river development, it is neither necessary nor essential that this work should all be provided for before any part of it be done.

The plan for improvement of the waterways of California, as devised by the Commission of Engineers, in brief, is as follows:

(a) To confine the flood waters to the channels of the various streams by the means of levees, so as to prevent destructive inundations of the fertile valley lands.

(b) To correct the alignment of the river by cut-offs where necessary, and to increase its channel capacity by mechanical means wherever current action fails to accomplish this purpose.

(c) To collect the hill drainage, which now loses itself in the basins, in intercepting canals and convey it to the river at selected points.

(d) To provide escape ways over the levees for surplus waters during the channel development, and to provide for the disposal of this water in connection with the hill drainage.

(e) To provide for the relief of the basins from the accumulations of rain and seepage water by means of pumps wherever gravity drainage is not practicable.

The first steps in the work have been taken, in the formation of the River Improvement and Drainage Association of California. This organization has worked consistently toward one plan of complete improvement of all the inland waterways of the State, and one of its first moves was the framing of the bill which was passed by the State Legislature, known as the Sacramento Drainage Bill, which law has recently been declared constitutional by the Superior Court of Sacramento County. This law establishes the Sacramento drainage district and the election of the Sacramento Drainage Commission, which is now actively at work.

The establishment of the Commission is a long step toward a betterment of conditions in the great interior valley of California, which has been inundated periodically by disastrous floods—two recent ones, that of 1904 and that of 1907, being fresh in mind. These two floods alone caused a monetary loss to the State sufficient to have provided the funds for the complete plan of reclamation recommended by the Commission of Engineers, for it is estimated that fully \$25,000,000 was lost to the property owners and lessees along the river by the overflows since January 1, 1900.

It may be easier to get rid of money this way than by applying it to betterment of the river, but it certainly is not so wise.

The plan of the River Improvement

and Drainage Association is to improve the rivers by units, and have these finally coalesce into the plan in its entirety. Naturally this unit plan would begin in the lower reaches of the river in straightening channels and providing for the ready outlet of the surplus water, while the greater work of providing storage basins, in which this flood water can be conserved until later in the season, shall be completed.

The possibilities of such flood water storage are so great as to be astounding in their immensity. Not only is it possible thus to provide for a constant flow of water sufficient to make the streams, navigable at all seasons, but it would also provide for irrigation water at all times when needed; and it would reclaim millions of acres of fertile land in the valley.

It may be said in this connection that the entire \$23,000,000 required for the completion of this plan of betterment of the Sacramento River would be returned in the increased value of the adjacent lands alone, to say nothing of the benefits that would be derived by every land owner in the whole valley and the adjacent foot hills.

The era of the inland waterway is at hand, and it behooves every person who has an interest in cheap and ready transportation, in land reclamation, and in the conservation of water, to unite in the work of carrying out a general and specific plan for river improvement.

TREES

By Marion Elza Dodd, Glen Ridge, New Jersey

Doomed by the lust of men,
The great trees in solemn silence
Watch the course of human progress
As their kin meet the call to death.
No forest depth escapes the scourge
Of the blazing ax of woodsmen
Who are singing to swinging blows
In the rhythm of life unbound.
But what of the choir of winds
Wailing for the dead?

Sentinels of strength,
Proof of a destined purpose,
Evidence of a law divine
From winter buds to spreading leaf,
Inspiration to see beyond
The heights in view to those of faith,
The very sap-blood of our lives!
You who cut and scar, change the chant
Of winds to swaying melody
Abounding in life!

IN THE DEPARTMENTS

Forest Service, Reclamation Service, and Geological Survey

Irrigation in Republican River Valley, Nebraska A report just issued by the Geological Survey (Water Supply Paper No. 216) states that about 35,000 acres are under irrigation in the Republican River Valley in Southern Nebraska. The principal irrigation is on the valleys and bench lands, though some of the ditches, of which there are about 130 miles, extend out on the lower adjacent valley slopes. The extent of irrigable land is large but the supply of water is not adequate for the reclamation of the entire area. In the eastern and central part of the Republican Valley region—that is, in Jefferson, Thayer, Nuckolls, Webster, Franklin, and Harlan counties—the average rainfall is sufficient for the growth of crops without irrigation except in an occasional season.

It has been hoped that the wells of the uplands and valley bottoms of the southwestern counties of Nebraska would yield enough water for the irrigation of large areas, but the supply has so far been found inadequate at most localities. The ground water, however, furnishes a sufficient supply for use in gardens, for raising fruit, vegetables, and flowers, and to a limited extent for certain crops. The best-known irrigation plant using well water is on the valley bottom a short distance southeast of Benckelman, where a twenty-acre garden is irrigated from a well twenty-seven feet deep. The water is raised by a gasoline pumping engine pumping 150 gallons a minute into a reservoir covering three-fourths of an acre to a depth of six feet.

The Los Angeles Aqueduct One of the western enterprises that has attracted wide-spread attention throughout the East and that stands as a testimonial to the boldness and energy of western business

men, is the project recently launched by the city of Los Angeles for bringing to the gates of that city, from the Owens River Valley, 250 miles to the north, a supply of pure water from the slopes of Mount Whitney and its sister peaks along the eastern crest of the Sierras. It is planned to bring sufficient water to supply the needs of a city with a million and a half inhabitants. The estimated cost of this enterprise is \$25,000,000. It is launched by a city of 250,000 inhabitants. A water supply of equal expense in proportion to the number of inhabitants would cost the city of New York \$400,000,000.

The first issue of bonds for the preliminary work on the Los Angeles aqueduct was floated at par in the midst of the recent depression, although the bonds yield but 4 per cent interest per annum. This in itself is a financial feat of no small magnitude.

The determination of Los Angeles to go 250 miles across mountain ranges and deserts for an adequate supply of pure water was reached as a result of exhaustive study of all possible nearer sources and was finally determined upon only after it had been proved to the satisfaction of those responsible for the city's policy that the ground waters of the adjacent valleys, particularly those of the coastal plain below Los Angeles, which during recent years have been looked upon as the most promising source for increased supply, are all needed for the agricultural interests already established in these valleys and for the municipal supplies of the smaller towns that are scattered over them. An essential and convincing portion of this evidence was supplied as a result of studies carried out by the Geological Survey during the last few years upon the ground waters of the south end of the State, where, in strong contrast to San Joaquin and

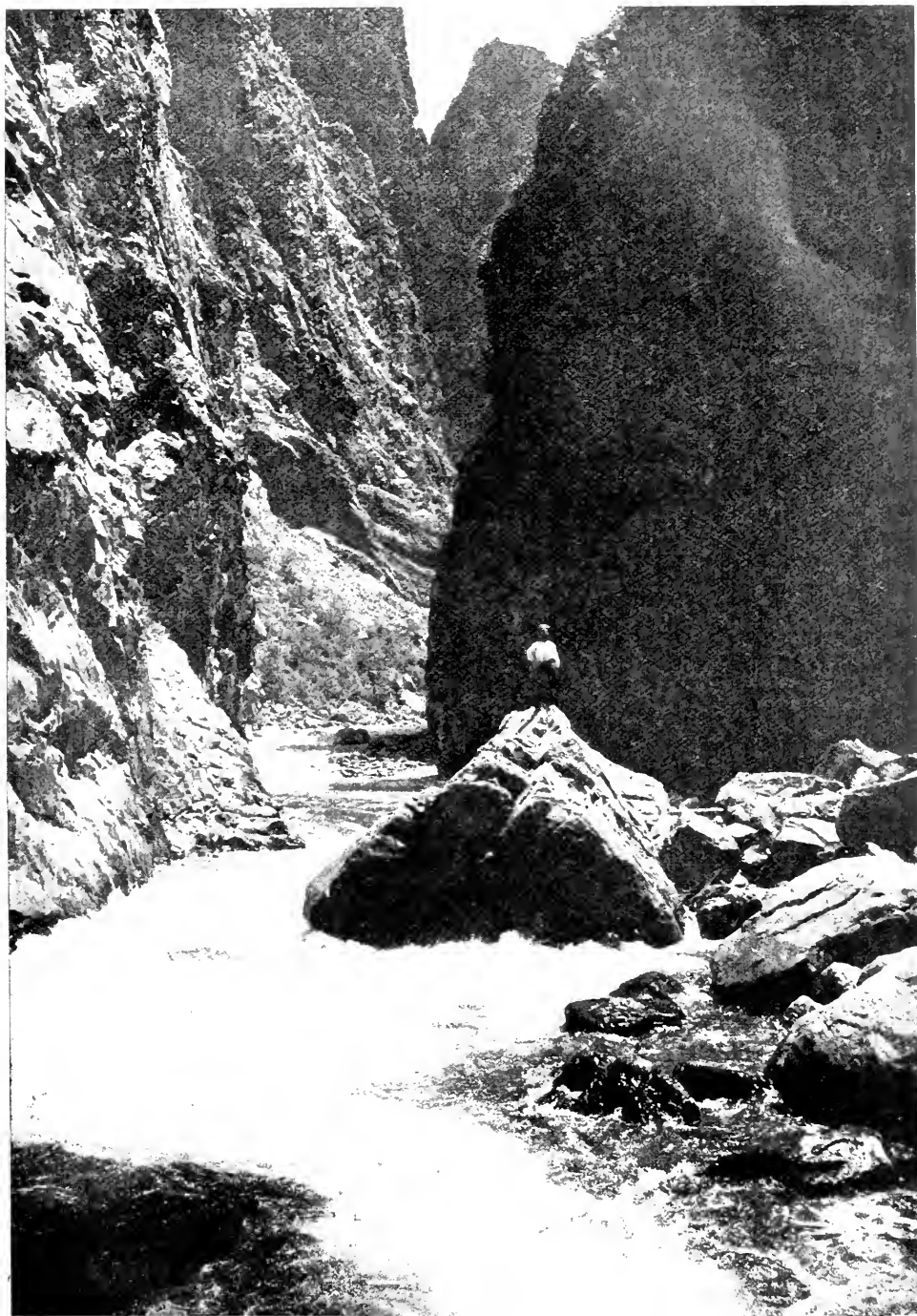

Site of Gunnison Dam, Black Canyon, on Gunnison River, Colorado

Sacramento valleys, full use has been made during recent years of subsurface waters, and millions of dollars have been invested in their development and utilization.

Survey Work In Luquillo National Forest Messrs. E. M. Douglas and C. L. Nelson, two of the topographers of the United States Geological Survey, are now in Porto Rico engaged in running the boundary line of the Luquillo National Forest. The total length of the line to be run is about forty miles, and it is expected that the work will consume about a month's time. As stated in the last number of this magazine, the forest covers nearly 66,000 acres (about 100 square miles) in the northeastern part of Porto Rico, and is the only national forest in the insular possessions of the United States.

Change in Boundaries of National Forests The President has just signed a proclamation combining the Manzano and Mt. Taylor National Forests, New Mexico, under the name of the Manzano National Forest. Besides designating the two forests as Manzano No. 1 and Manzano No. 2, the proclamation makes several changes in the boundaries of each. Approximately 70,636 acres have been added to the old Manzano and an elimination of that part of the forest lying south of the Belen cut-off of the Santa Fe Railroad, amounting to 167,156 acres, has been made.

The additions are located along the northeast portion of Manzano No. 1, bordering the Estancia Valley. This includes the greater portion of the north and south San Pedro Mountains. This addition lies between the San Pedro Grant, Tejon Grant, and Ortiz Mine Grant. Much of the extreme northern portion of the addition covers the steep slopes of the North and South San Pedro Mountains, while the southern part covers a more or less smooth country along the east slope of the Manzano Mountains.

Considerable yellow pine is found in the area included in this recent proclamation in the vicinity of the San Pedro Mountains. On North San Pedro Mountains there are scattered clumps of yellow pine and red fir, while on the south side of the mountains there is some good pine in the canyons. The slopes of San Pedro Mountains bear a scattered stand of red fir and yellow pine. Much of this mountain has been cut over from time to time to supply the mines at San Pedro and Golden. With the exception of the areas covered by yellow pine, the remainder of the additions is covered with a heavy stand of juniper and pinon.

The Estancia Valley, which borders the additions on the east, is rapidly becoming a prosperous agricultural region, and large numbers of people are coming in from all parts of the Middle West to take up ranches in this locality. Under the new Campbell system of dry farming there has been considerable success the past few years, and hence it is very important that the timber and woodland embraced in the additions be protected from ruthless exploitation, in order that the settlers may have an abundant supply of wood for fuel and posts, both at the present time and in the future.

The elimination made by this proclamation of all the land lying south of the Belen cut-off, contains a considerable quantity of juniper and pinon timber, but on account of its isolation and the great scarcity of water it does not form a very important factor in the timber supply of the Estancia Valley. This area is chiefly important at the present time for sheep grazing.

The recent proclamation also added an area of 110,525 acres to the old Mt. Taylor National Forest, now Manzano No. 2. This addition is in two bodies, one on the high mesa northeast of the town of San Mateo, locally known as the Sierra Chivato, and the other on the ridge northwest of the town of San Mateo. The former lies between the Cebolleta, Ignacio Chaves and

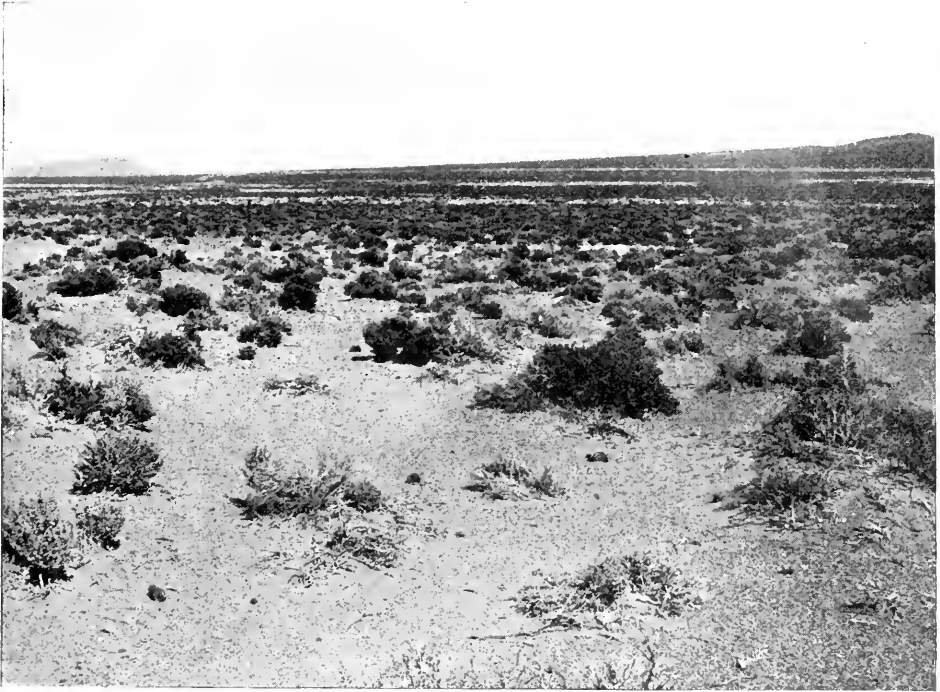

Irrigable Land on Main Truckee Canal, Nevada

Bartolome Fernandez land grants and the original forest. A greater portion of this area is covered with a fair stand of yellow pine timber, which, although it may not be of any great commercial value at the present time, promises to be of great importance in the future.

In the other addition to the Manzano No. 2, on the ridge lying northwest of the town of San Mateo, there are some scattered bodies of yellow pine upon the higher points, while the remaining area is clothed with a dense stand of juniper and pinon, which will average at least ten cords per acre.

**Cheap
Cement
Production**

During the year 1907 there were produced at the cement mill at Roosevelt, on the Salt River project, Arizona, 42,145 barrels of cement at an average cost of \$2.27 per barrel. The mill was shut down for over four and one-half months of the period, but all expenses for office salaries, superintendent's wages and skilled laborers

kept on the payroll have been included in estimating the unit cost. The cost of repairs has also been included, but no allowance has been made for general depreciation of the plant. The shutting down of the mill was necessitated by the lack of requirements for cement by the contractor and the consequent crowded condition of the storage bins for both the clinker and the finished product. Moreover, the mill, when running, was doing so at only a little over one-half of its normal capacity. Had it been operated at full capacity continuously throughout the year, the average cost of the output would have been considerably less than \$2 per barrel.

**Y. M. C. A. and
Reclamation
Service**

Mr. Clarence J. Hicks, general secretary of the Y. M. C. A. of New York, has called at the Washington office and discussed with the Director the practicability of introducing Y. M. C. A. work in the principal camps of

the Reclamation Service and of its contractors in a manner somewhat similar to that carried on within the Canal Zone on the Isthmus of Panama. One of the traveling secretaries will probably visit some of the principal camps to ascertain for himself the general conditions and outlook. The Director has issued instructions that any such person be afforded all proper facilities for an investigation and advice from the principal men in charge.

Diversion of Bowl Creek An interesting feature of the Sun River project is the contemplated diversion of Bowl Creek into Sun River, thus turning across the Continental Divide toward the Atlantic Ocean water now running into the Pacific Ocean.

Water Right Application The latest returns from the various local land offices show that the water right applications under the Reclamation Act are as follows:

Minidoka project under public lands, 887 applications, totaling 58,811.72 acres, with no applications under private lands.

Huntley project, 175 applications under public land totaling 7,973.58 acres, with no applications under private lands.

Truckee-Carson project under public lands, 187 applications, totaling 11,429.10 acres, and under private lands 71 applications, totaling 8,945 acres.

Umatilla project, one application under public lands of ten acres, and two applications under private lands amounting to 114.50 acres.

Belle Fourche project under public lands, four applications, totaling 172 acres, and under private lands, three applications, totaling 399 acres.

Co-operative Construction The Payette-Boise Water Users' Association, in carrying out its arrangement with the Reclamation Service for co-operative construction, has recently let contracts for the excavation of about thirty miles of laterals. The payment for this work is to be made entirely with certificates redeemable in payment for water rights in accordance with the contract between the United States and the Water Users' Association. Contracts were let to about twenty different parties, and the unit prices bid range from 15 to 18 cents per cubic yard for Class 1 material, and from 35 to 70 cents for Class 2, while for Class 3 a uniform price of \$1.50 per cubic yard is named.

Interest in Reclamation Work Widespread interest in the work of the Reclamation Service is being evidenced by homeseekers from all parts of the country. The daily mail of the Service has grown to large proportions, and the indications point to a very heavy movement of settlers to the West this summer. The homemaker will find this season most propitious, as several of the large Government works are now completed and are supplying water to thousands of acres. Reduced rates on all railroads are advertised, and several train loads of homeseekers have been carried to Western points.

INDEX IS READY

The complete index for FORESTRY AND IRRIGATION for 1907 is now ready, and readers of the magazine who desire an index for their files should place their orders at once. Indexes

are not sent to readers unless they are requested; the supply is not inexhaustible, therefore those who want them for binding with their files should order immediately.



Wood, by G. S. Boulger. Edwin Arnold, London. Placing in the hands of those for any reason interested in the subject of wood, its supply-sources and its uses, in a single volume, a mass of well-prepared information hitherto unavailable except in a large number of scattered publications. The author has treated his subject rather more from the scientific standpoint than the popular, and the work may, therefore, possibly not reach so wide an audience as it would otherwise have done. The volume is divided into two parts, with four appendices. The first part treats of the origin, structure and development of wood; the recognition and classification of wood; its defects; selection, durability and seasoning; uses, sources of supply, and methods of wood testing; while the second part has to do with the sources, characters and uses of the woods of commerce. The volume is well printed, is illustrated with numerous handsome half-tone engravings and a large number of drawings, and is attractively put together.

Our Trees: How to Know Them, by Arthur I. Emerson and Clarence M. Weed. J. B. Lippincott Company, Philadelphia and London. Here is a volume that will prove invaluable to the student of forestry who is just beginning, and who wants to gain as rapidly as possible the rudimentary information that will enable him or her to recognize the trees of the forest. Little attention is given to the scientific side of the subject; in fact, the Latin names of the trees are only given in a sub-caption beneath the illustrations. Of these there are almost two hundred, and each illustration shows several figures of the same tree—the trunk, a branch of the foliage, and the fruit, seedpod or cone, as the case may be. The text is written in a delightfully understandable style, and the illustrations are such as to make the subjects easily recognizable. The book is a handsomely gotten up volume, and should be in the library of every man or woman who is inter-

ested in the vital question of forest conservation.

The Relation of the Southern Appalachian Mountains to Inland Water Navigation; Forest Service Circular No. 143. This is worthy of more than passing notice, it being a study, by M. O. Leighton and A. H. Horton, of the United States Geological Survey, of the matter which forms the title of the pamphlet. The work gives the result of investigations made by the Geological Survey covering the whole territory of the Atlantic seaboard from the Potomac River southward; it shows clearly the vastly increased use that can be made of the rivers of this entire region, for transportation purposes, when the crest of the Appalachian system is placed under Government supervision and the process of total deforestation is ended. The tabulations contained in the work may be depended upon as being exact and accurate; and the pamphlet is a most valuable reference work.

Other Publications Received:

Quarterly Journal of Forestry; issued by the Royal English Arboricultural Society. Detailed information regarding forestry work in the British Empire, together with a brief resumé of important forestry work in other regions of the world.

Bulletin of the New York Botanical Garden. Containing reports of the various officials and departments for the year 1907.

Prospectus of the Colorado State School of Forestry, for 1908. Giving an outline of the coming year's work in the school, with a brief curriculum, and numerous illustrations, many of which show the result of work done by students at the school.

The Indian Forest Records; published by order of the Government of India. This volume contains an exhaustive study of a single apparently insignificant insect—the lac insect, that, by its activities, causes two or three species of trees native to Indian forests to produce shellac and other forms

of the lac so universally used in the preparation of fine varnishes.

Proceedings of the Tenth Annual Convention of the Associated Boards of Trade of Eastern British Columbia. In this report are contained resolutions adopted at the convention touching upon forestry matters such as affect both the Canadian Provinces and the United States. The different Boards of Trade are emphatic in their demand that the Provincial Governments become more active in adopting and enforcing protective measures, and a progressive lumbering license is advocated in place of the present royalty system in vogue throughout the Dominion.

Bulletin 95, of the Soils Section, Iowa State College of Agriculture and Mechanic Arts. A study of soils in the Missouri loess area, with a consideration of plant food and its sources, and a recommended treatment for hilltops in the Missouri loess area.

The Mosquito as a Sanitary Problem; by Edward A. Ayers, M. D. A lecture delivered by Dr. Ayers at the Academy of Medicine, New York City. The lecture, printed in pamphlet form, with a number of striking illustrations and plates, is intended to show the connection between mosquitos and malaria, yellow fever and other allied forms of disease. It also shows the practicability of exterminating the mosquito, and consequently the diseases transmitted by it, by systematic drainage or by scientific treatment of breeding grounds, such as is done by means of crude oil in various parts of the country.

Bulletin of the California Physical Geography Club. The important paper in this issue is "Natural Warfare and Human Welfare," by G. B. Lull. The report of the semi-annual meeting of the club contains numerous interesting paragraphs; and the volume contains, also, notes on Death Valley and the Colorado Desert that are of more than ordinary interest.

Forestry and Forest Preservation in Alabama. This is the title of Bulletin No. 1 of the newly organized State Commission of Forestry. It begins with the true statement that the preservation of the natural resources of a State depends entirely upon the interest the citizens take in the State's welfare.

The importance of forest preservation is pointed out, directions are given how to fight forest fires, and a summary of the forest laws of Alabama. Attention is called to the Appalachian National Forest proposition. People

are urged to refrain from firing forests; and on various grounds to look to the future. Suggestions are made to owners of Alabama forest land. The book closes with the text of the new forest law.

This book is the result of the Commission's decision that the thing needed is to acquaint the people with the situation. No law is automatic; and the needed interest on the part of citizens is sought to be aroused.

Canada's Approaching Peril is a pamphlet issued in both French and English editions by the Biggar-Wilson publishing house at Toronto. It shows the vital necessity of forests, with warnings from the history of dead and dying nations, and calls the unrestricted export of pulp wood a menace to the country.

Forest Planting in Vermont. Bulletin No. 132 of the Vermont Agricultural Experiment Station tells how to manage lands and encourage natural reforestation, and how to supplement this by judicious planting.

The Transactions of the Royal English Arboricultural Society, Vol. VII, Part 1, are at hand. This issue of the transactions contains the list of the members of the Society, headed by the Patron, His Most Gracious Majesty, the King. The members number about 1,200.

Books on Massachusetts Trees:

Forest Trees of Massachusetts—This is a pocket manual published and printed by the State Forester in order to have a practical working description of commercial trees, at the command of Massachusetts citizens. A page is given to each tree, with a line cut illustration.

Forestry from a Commercial Standpoint—Also by the Massachusetts State Forester, F. W. Rane, is a fitting accompaniment to the foregoing, as is also the large pamphlet on **The Study of Trees in Our Primary Schools,** by Professor Rane and Dr. Clarence M. Weed. This is a beautifully printed book with illustrations. It suggests in particular the observance and collection of leaves by young children.

The Massachusetts State Forester's report for 1907 has just been issued, with illustrations. A notable feature of this is the distribution of tree and seed collections to citizens of Massachusetts at a low price.



**Evergreens,
Forest Trees
and Seeds.**

*Three Millions of White Pine Seedlings and
nearly one ton of Seeds.*

Red Oaks, Linden, Black Locust

ALSO SEEDS

For forest planting on sandy soil I offer several millions Ponderosa and Jack Pines and Northern Red Cedar, and Seeds of same.

Northern Grown Trees and Seeds a Specialty

Mention this paper when you write.

D. HILL, Evergreen Specialist

DUNDEE, ILL.

Read "Irrigation in the United States," by Fredrick Haynes Newell, Director of the Reclamation Service. Price, \$2, postpaid to any address. Address "Forestry and Irrigation," Washington, D. C.

ORCHIDS

ORCHIDS

We are the largest Orchid Growers in the United States. Our Illustrated and Descriptive Catalogue of Orchids is now ready and may be had on application

Orchid Growers and Importers

LAGER & HURRELL,
Summit, N. J.

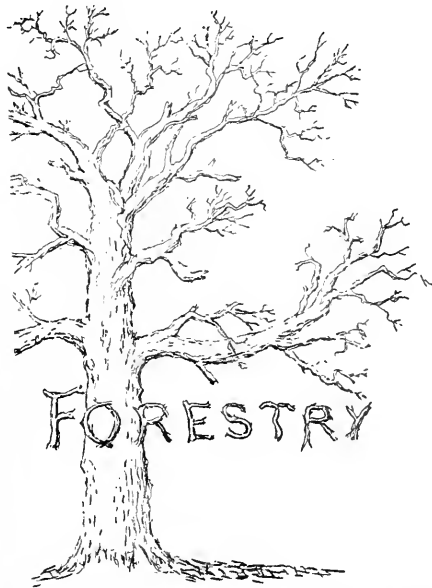

POWDER POINT SCHOOL, Duxbury, Mass.

In addition to the present work of the school, a new preparatory course in **Forestry** is being started, leading to the college courses in the subject. It requires hard, earnest application, and develops an appreciation of nature and power of leadership.

F. B. KNAPP, S. B.



GET THIS

RIFE

Hydraulic Ram

if there is a stream, spring or pond near by and have running water wherever you want it.

PUMPS WATER WITH WATER

works continuously without attention. No expense for power, nothing to get out of order. Raises water 30 feet for each foot of fall. For Home, Farm, Irrigation, and all purposes. Over 7,000 in use. Free Plans and Estimates furnished. Write today.

RIFE ENGINE CO., 2172 Trinity Bldg., NEW YORK

The . . . **PAPER** . . . that this publication is printed on is furnished by

R. P. Andrews Paper Co., Inc., Washington,

Sole Agents in the District of Columbia for the **West Virginia Pulp and Paper Company,** the Largest Manufacturers of Book Paper in the world.

IF IN NEED, DROP THEM A LINE

In writing advertisers kindly mention **FORESTRY AND IRRIGATION**

Biltmore Forest School

Biltmore, N. C.



Theoretical and practical instruction in all branches of applied forestry.

The course comprises eighteen months; twelve consecutive months of lectures and field work, and six months of practical experience.

Object lessons within the mountain estate of George W. Vanderbilt, comprising 120,000 acres, where forestry has been practiced since 1895



For further information apply to

C. A. Schenck, Director

COLORADO SCHOOL OF FORESTRY...

Colorado Springs, Colo.

Three years' course in
TECHNICAL AND
APPLIED FORESTRY

Winter Term at Colorado College, Colorado Springs.
Summer Term at Manitou Park on the borders of the Pike's Peak Forest Reserve.

TUITION, SIXTY DOLLARS
— A YEAR —

For further particulars apply to
WM. C. STURGIS, Dean

Colorado Springs - - - Colo.

YALE FOREST SCHOOL

NEW HAVEN, CONNECTICUT

The course of study in the YALE FOREST SCHOOL covers a period of two years. Graduates of collegiate institutions of high standing are admitted as candidates for the degree of Master of Forestry.

The Summer School of Forestry is conducted at MILFORD, PIKE COUNTY, PENNA.

FOR FURTHER INFORMATION ADDRESS

HENRY S. GRAVES, Director - New Haven, Connecticut

FORESTRY AND IRRIGATION

CONFERENCE NUMBER

Containing the full report of the meeting of the Governors with the President, at the White House, with the papers, addresses and discussions of this historic assembly of the Nation's leading public men

Thorburn's Seeds

We carry a large assortment of seeds of **EVERGREEN** and **DECIDUOUS TREES** and **SHRUBS**, both native and imported, and shall be glad to quote on any that are still unsold.

J. M. Thorburn & Co.

33 Barclay Street,
Through to 38 Park Place

Established 1802

NEW YORK

This Solar can be used in hazy weather, when other Solars are useless. Used by the U. S. General Land Office.

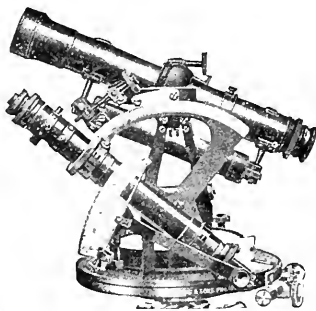

Specifications:

Needle $3\frac{1}{2}$ inches long. Graduations $4\frac{1}{4}$ inches long reading minutes. Power of telescope 20 (with splendid definition, good light, and large field). Variation plate. Level to telescope, clamp and opposing screws. Vertical arc. Fixed Stadia-hairs. Extension side of standards.

Tripod. Solar Attachment on

Price, complete \$300

Telegraph and Code Word, Mountsolar

Illustrated Catalogue upon application

YOUNG & SONS, PHILADELPHIA

THE Pennsylvania State College

A thorough and practical undergraduate course in technical forestry, preparing men for all lines of professional and applied forestry.

Special attention is paid to practical field work in surveying, mapping and forest measurements. One of the largest of the State Forest Reserves is within a short walk of the college.

For information regarding entrance requirements, expenses, etc., address

Department of Forestry
State College, Penna.

PLANE SURVEYING

A Text-book and Pocket Manual

By JOHN CLAYTON TRACY, C. E.
*Ass't Professor of Structural Engineering
Sheffield Scientific School of Yale University*

16 mo, xxvii + 792 pages, illustrated with line cuts. Morocco, \$3.00

Used in the Yale Forestry School and just adopted in Pennsylvania Department of Forestry :: ::

Descriptive Circular on Application

JOHN WILEY & SONS

43 and 45 E. 19th St. New York City

FORESTRY AND IRRIGATION

FRANK GLOVER HEATON }
 THOMAS ELMER WILL }

Editors

CONTENTS FOR JUNE, 1908

MEMBERS OF THE GOVERNORS' CONFERENCE	<i>Frontispiece</i>
THE GOVERNORS' CONFERENCE. (<i>Illustrated.</i>) By Frank Glover Heaton	291
List of Governors and Advisers.....	293
National Organizations—Representatives..	296
FIRST DAY'S SESSIONS	298
President Roosevelt's Address.....	298
<i>Afternoon Session.</i>	
Mr. Andrew Carnegie's Paper.....	303
Dr. I. C. White's Paper.....	308
Mr. John Mitchell's Remarks.....	314
Governor Johnson's Remarks.....	314
Dr. Van Hise's Paper.....	315
Mr. John Hays Hammond's Address.....	318
Secretary Root's Address.....	319
Governor Dawson's Remarks.....	319
SECOND DAY'S SESSIONS	319
Mr. James J. Hill's Paper.....	320
Dr. Thomas C. Chamberlain's Paper....	326
Secretary Wilson's Address.....	330
Mr. James S. Whipple's Address.....	331
Dr. Arthur D. Hadley's Remarks.....	333
Governor Glenn's Address.....	334
Governor Davidson's Remarks.....	335
<i>Afternoon Session.</i>	
Dr. George C. Pardee's Address.....	337
Hon. H. A. Jastro's Paper.....	338
Governor Folk's Address.....	338
Governor Cutler's Remarks.....	339
Governor Gooding's Remarks.....	340
Governor Norris's Remarks.....	340
Dr. James's Remarks.....	340
Secretary Garfield's Address.....	341
Mr. W. S. Harvey's Address.....	342
Call for Organization of "The House of Governors".....	342
THIRD DAY'S SESSION	343
Report of Committee on Resolutions....	343
Hon. William Jennings Bryan's Address..	344
Governor Comer's Remarks.....	346
President Roosevelt's Remarks.....	347
Governor Mead's Remarks.....	347
Governor Hanly's Remarks.....	347
Governor Willson's Remarks.....	347
Governor Hoch's Remarks.....	347
Governor Sheldon's Remarks.....	348
Closing of Conference.....	348
THE FOREST LESSON. (<i>Poem.</i>) By Arthur Chapman	348
IMPORTANT ANNOUNCEMENT	349
THE DRAINAGE CONGRESS	349
CONSERVATION—WOMAN'S WORK. By Lydia Adams-Williams	350
(<i>With portrait of the author.</i>)	
EDITORIAL	352
Forestry and Irrigation First.....	352
A New Departure in Government.....	352
Grants in Perpetuity.....	354
The Appalachian Bill in Congress.....	355
Some Western Criticisms	357
NEWS AND NOTES	359
Timber Owners Organize to Fight Forest Fires.....	359
Novel Forestry Course.....	359
Possibilities for Turpentine in the Northwest.....	359
Proposed Summer Home for Teachers... New National Forest in Kansas.....	359 360

FORESTRY AND IRRIGATION is the official organ of the American Forestry Association. Price, \$2.00 per year, including Annual Membership in the Association. Entered at the Postoffice at Washington, D. C., as second-class mail matter.

Published Monthly at
 1311 G STREET, N.W. WASHINGTON, D. C.

IMPORTANT BOOKS ON FORESTRY

PRINCIPLES AND PRACTICE OF FORESTRY

Forest Mensuration. By HENRY SOLON GRAVES, M. A. A complete text book of this important subject and the first written for American Foresters. It deals with the determination of the volume of log, tree, or strand, and with the study of increments and yields. *Price, \$1.00*

Economics of Forestry, The. By B. E. FERNOW. This volume treats of forests and forestry from the standpoint of political economy, and is designed to furnish a trustworthy basis for formulating public policy. *Price, \$1.50*

First Book of Forestry, A. By FILIBERT ROTH. An outline of the general principles of forestry, written in simple, non-technical language, designed particularly for the beginner. *Price, \$1.10*

Practical Forestry, for Beginners in Forestry, Agricultural Students and Woodland Owners. By JOHN GIFFORD. A good general description of the principles of forestry with enough technical information to prepare the beginner. *Price, \$1.40*

History of the Lumber Industry of America. By J. E. DEFEBAUGH. The first authoritative work of its kind yet issued, and one which will commend its self alike to the timber owner, lumberman, lumber manufacturer, or merchant, or student of economics. In four volumes bound in half leather. *\$5.00 per volume.*

Forest Planting. By H. NICHOLAS JARCHOW. An illustrated treatise on methods and means of restoring denuded woodland. *Price, \$1.50*

Forestry. (Schwappach.) An English translation of "Forstwissenschaft." *Price, 70c*

Hedges, Windbreaks, Shelters and Live Fences. By E. P. POWELL. A treatise on the planting, growth and management of hedges with information concerning windbreaks and shelters. *Price, 70c.*

North American Forests and Forestry. By ERNEST BRUNCKEN. This volume, expository in its character, is written in a style intended for the general reader, to whom it should convey a good idea of our forests forestry. *Price, \$2.00*

Practical Forestry. By ANDREW S. FULLER. A treatise on the propagation, planting and cultivation, with descriptions and the botanical and popular names of all the indigenous trees of the United States, and notes on a large number of the most valuable exotic species. *Price, \$1.50*

Principles of American Forestry. By SAMUEL B. GREEN. Prepared especially for students in elementary forestry and for the general reader who wishes to secure a general idea of forestry in North America. *Price, \$1.50*

Seaside Planting of Trees and Shrubs. By ALFRED GAUT. Illustrated from photographs by FRANK SUTCLIFFE. This is a new volume in the English Country Life Library. Advice regarding selection and management to get satisfactory effects under adverse influence of closeness to seashore. *Price, \$1.75.*

Forest Management. By C. A. SCHENCK. Describes methods here and abroad to bring the most profit from all investments made in woodlands. *Price, \$1.25*

Forest Mensuration. By C. A. SCHENCK. Treats conditions in U. S. from mathematical and practical standpoint. *Price, \$1.25*

Forest Utilization. By C. A. SCHENCK. First treatise on this in U. S. Covers logging, lumbering, sawmilling, cooperage, paper-making, and description of all industries obtaining raw material from American forests. *Price, \$1.25*

Biltmore Lectures on Sylviculture. By C. A. SCHENCK. Written from author's long experience as forester of the Biltmore estate, where sylviculture has been practiced on a larger scale for a longer time than anywhere else in U. S., and where results become more apparent from year to year. *Price, \$2.50*

Forest Policy By C. A. SCHENCK. (Second part.) Describes the various States of the Union under following heads: Area; physiography; distribution of forests; forest ownership; use of the forest; forestry movement; forest laws; forest reservations; irrigation. *Price, \$1.25*

Profession of Forestry, The. By GIFFORD PINCHOT. A pamphlet containing an address on that subject by Mr. Gifford Pinchot; also an address by Mr. Overton W. Price on "Study in Europe for American Forest Students," and a list of reference publications for students. *Price, 25c.*

FOREIGN IMPORTATIONS

English Estate Forestry. By A. C. FORBES. An authoritative volume on English forest methods from the pen of a well known forester, that should prove of interest to Americans. *Price, \$1.50*

Forstwissenschaft. (Schwappach.) *Price, 60c*
Manual of Forestry. (Schlich.) Five volumes, complete, or separately as follows (*price, complete, \$18.80*):

Vol. I. "Forestry Policy in the British Empire." *Price, \$2.40*

Vol. II. "Sylviculture." *Price, \$3.20*

Vol. III. "Forest Management." *Price, \$3.60*

Vol. IV. "Forest Protection." *Price, \$4.80*

Vol. V. "Forest Utilization." *Price, \$4.80*

This is perhaps the most authoritative work that has been issued on the technical side of forestry, translated from the German.

Wood. By G. S. BOULGER. An important new book for arboriculturists and forestry students. A manual of the natural history and industrial applications of the timbers of commerce. Cloth. 82 Illustrations. *Price, \$2.60.*

Familiar Trees. By Prof. G. S. BOULGER. Written by an eminent botanical authority, yet couched in language easily understood. The coloured plates are the work of celebrated artists, and are truthful and trustworthy in every respect. A special feature is the series of photomicrographic illustrations of sections of woods. Three volumes. *Price, per volume, \$1.50.*

DENDROLOGY, BOTANY, AND IDENTIFICATION OF SPECIES

Manual of the Trees of North America (exclusive of Mexico). By CHARLES SPRAGUE SARGENT. A volume that presents in convenient form and with excellent illustrations, authoritative information concerning the trees of North America. It is written in a manner that enables the reader to readily find what family or species any particular tree belongs. *Price, \$8.00.*

American Woods. By ROMEYN B. HOUGH. A new departure in the publication of an authoritative work illustrated with actual wood sections of the various species described. Three are given of each, viz., radial, transverse, and tangential. Issued in ten parts, per part *Price, \$5.00*

Handbook of the Trees of the Northern U. S. and Canada, East of the Rocky Mountains. By ROMEYN B. HOUGH. Pictorial description of trees. Two pages to each species; photo-engravings of trunk, leaves, flowers or fruit, section of wood, and map of distribution, with botanical description, and brief other information. *Price, in buckram, \$5.00; in half morocco, \$10.00*

Flora of the Southern States. CHAPMAN. This is an excellent key to the flora of the south, complete and accurate in its scope. *Price, \$1.00*

Getting Acquainted with the Trees. By J. HORACE McFARLAND. A handsome volume, copiously illustrated, and with facts accurately presented in an entertaining way. *Price, \$1.75*

How Plants Grow. By ASA GRAY. An understanding of the way in which a tree grows is of prime importance to the forester, and the matter here presented is accurate and authoritative. *Price, \$1.00*

Principal Species of Wood; Their Characteristic Properties. By CHARLES HENRY SNOW. No attempt is made to give exhaustive descriptions of species, but the author presents a mass of information designed for the use and instruction of woodworkers, etc., in a popular style. A host of concise information is brought under each head, and the work is a valuable one. *Price, \$3.50.*

Manual of Botany. By ASA GRAY. A key to the flora of the northeastern states, and the most authoritative publication of its nature.

Price, \$1.62; field edition, \$2.00

Trees of New England. By L. L. DAME and HENRY BROOKS. This book is a small volume which can be easily put in the pocket and carried in the woods, and at the same time is the best guide to the identification of our New England trees of any of the smaller books yet published. Price, \$1.50

Trees of Northeastern America. NEW-HALL. A good general check list of the more important trees of the northeastern United States.

Price, \$1.75

Trees and Shrubs. By C. S. SARGENT. The most thorough and authoritative publication yet issued, and a standard work. The matter is issued in parts, of which there are three already published.

Price, per part, \$5.00

Trees, Shrubs and Vines of the Northeastern United States. By H. E. PARKHURST. In this book the author describes the trees, shrubs, and vines of the northeastern United States in a popular way, the book being designed especially for persons who have never studied botany. To these it will appear as a valuable guide to a familiarity with the salient characteristics of trees, shrubs and vines.

Price, \$1.50

Trees. A handbook of forest botany for the woodlands and the laboratory. By H. MARSHALL WARD. Vol. I, Buds and twigs. Vol. II, Leaves. Vol. III, Flowers and inflorescences. Three volumes to be added, on Fruits and seeds, Seedlings, Habit and conformation of the tree as a whole.

Price, per volume, \$1.50

PARTICULAR SPECIES AND LOCALITIES

Mountains of California, The. By JOHN MUIR. No other person is so well fitted to write of the mountains of California as John Muir, and the volume presented here describes not only the mountains themselves but the trees that clothe them and the wild life which they harbor.

Price, \$1.35

Our National Parks. By JOHN MUIR. If you want to learn about the glaciers, mountain peaks, canyons and great waterfalls of the West; of the habits of animals from the squirrel to the moose; plant life from the big trees to the wild flowers — in fact be brought face with nature's works, this is the book.

Price, \$1.85

Trees and Shrubs of Massachusetts. EMERSON. Two volumes. Plain cloth edition has 148 plates. The colored edition has 36 of these in colors. Price, plain, \$12.00. Price, colored, \$13.00.

The Earth as Modified by Human Action. By G. P. MARSH. A Revision of Man and Nature. Describes changes in the face of the earth caused by man, including desolation of various countries, once thickly inhabited, by removal of forests. Shows importance of maintaining natural balance of forces.

Price, \$3.50

The Longleaf Pine in Virgin Forest. A Silvical Study. By G. FREDERICK SCHWARZ. This is a study of the life history of this important forest tree. Intended primarily for foresters and forest students; also for owners and managers of pine timber lands. Deals with the preference or dislike of the species for particular conditions of soil, climate, and environment. Illustrations and six tables.

Price, \$1.25

The Sprout Forests of the Housatonic Valley of Connecticut. By G. F. SCHWARZ. Illustrated study of forests repeatedly cut over.

Price, \$3.50

IMPORTATIONS

Beautiful Rare Trees and Plants. By the EARL OF ANNESLEY. A description of some of the rarer English trees, shrubs and vines, illustrated copiously.

Price, \$12.00

Forests of Upper India and Their Inhabitants. By THOMAS W. WEBBER. This volume is an account of the author's life in India during the period shortly after 1857. It contains a vivid description of the country, its people, customs, etc., with some description of its forests and timber wealth.

Price, \$5.00

BOOKS ON IRRIGATION AND DRAINAGE

Irrigation in the United States. By F. H. NEWELL. The most authoritative and complete work on the subject which has yet been published, by the head of the Government's irrigation work.

Price, \$2.00

Irrigation Farming. By L. M. WILCOX. A newly revised edition of one of the standard works on irrigation. The principal chapters treat very fully of irrigation, its application, etc., and the volume is profusely illustrated.

Cloth, \$2.00

Irrigation for Farm, Garden and Orchard. By HENRY STEWART. This work is offered to those American farmers and other cultivators of the soil who, from painful experience, can readily appreciate the losses which result from the scarcity of water at critical periods.

Price, \$1.00

Irrigation and Drainage. By F. H. KING. While most of the existing books on these subjects have been written from engineering or legal standpoints, this one presents in a broad yet specific way the fundamental principles which underlie the methods of culture by irrigation and drainage.

Price, \$1.50

Irrigation Institutions. By ELWOOD MEAD. A discussion of the economic and legal questions created by the growth of irrigated agriculture in the West, by the Chief of Irrigation and Drainage Investigations of the Department of Agriculture.

Price, \$1.25

Land Draining. By MANLY MILES. A handbook for farmers on the principles and practise of draining, giving the results of his extended experience in laying tile drains.

Price, \$1.00

Land of Little Rain, The. By MRS. MARY AUSTIN. A nature book of the highest type. The volume is made up of a series of sketches of the human, animal, and plant life found in the region of the Mohave desert, Death Valley, and the Sierras, much of which the average person is likely to consider almost devoid of living things.

Price, \$2.00

IRRIGATION ENGINEERING AND CONSTRUCTIVE WORK

Design and Construction of Dams. By EDWARD WEGMANN. This volume includes an authoritative discussion of the constructive work involved and the principal forms of construction. Masonry, rock-fill and timber dams are discussed extensively.

Price, \$5.00

Improvement of Rivers. By B. F. THOMAS and D. A. WATT. This volume is a treatise on the methods employed for improving streams for open navigation and for navigation by means of locks and dams.

Price, \$6.50

Irrigation Engineering. By HERBERT M. WILSON. This is the fourth edition of Mr. Wilson's popular work, and the revision and enlargement which it has undergone, places it at the forefront of text books on the subject for American students.

Price, \$1.00

Engineering for Land Drainage. By C. G. ELLIOTT. A manual for laying out and constructing drains for the improvement of agricultural lands.

Price, \$1.50

Reservoirs for Irrigation, Water-power, and Domestic Water-supply. By JAMES DIX SCHUYLER. An account of various types of dams and the methods and plans of their construction, together with a discussion of the available water-supply for irrigation in various sections of arid America, distribution, application, and use of water; the rainfall, runoff, and evaporation from reservoirs, and effect of silt, etc.

Price, \$5.00

Water Supply Engineering. By A. PRESCOTT POLWELL. A treatise on the designing, construction and maintenance of water-supply systems, both city and irrigation.

Price, \$1.00

These books sent prepaid upon receipt of price indicated, by FORESTRY AND IRRIGATION

1311 G Street, N. W., Washington, D. C

(over)

Water Power. By JOSEPH P. FRIZELL. An outline of the development and application of the energy of flowing water. Price, \$5.00

Concrete, Plain and Reinforced. By FREDERICK W. TAYLOR and SANFORD E. THOMPSON. Designed for practicing engineers and contractors; text and reference book for students. Discusses materials, processes, and applications of concrete in construction and specifications. Price, \$5.00

Hydraulics. By MANSFIELD MERRIMAN. Purpose of book is to keep abreast of modern progress, and present subject with conciseness and clearness. Gives general principles and discusses flow of water through various kinds of openings and channels. Historical notes and references. Price, \$5.00

BOOKS ON RELATED SUBJECTS

Utilization of Wood Waste by Distillation.—By Walter B. Harper. An important treatise on a subject regarding which the interest is great and the information scarce. Is intended to aid in the establishment and conduct of wood distilling enterprises on a business basis. Price, \$3.00

Handbook of Timber Preservation. By SAMUEL M. ROWE. Intended as a complete practical guide for the operator of a preservation plant, with hints on construction thereof. Price, \$4

In Forest Land. By DOUGLAS MALLOCH. The humor, sentiment and philosophy of the lumber business interpreted by the "Lumberman Poet." A kind of touch with the great outdoors that few books contain. Illustrated in tint, bound in silk cloth and gold stamped. Ideal for gift or library. Price, 1.25

The Garden

Roses and How to Grow Them. By many Experts. In text, practical; in subject and quality of illustrations, beautiful. Price, \$1.20

Ferns and How to Grow Them. By G. A. WOOLSON. The growing of hardy ferns, both in the garden and indoors. Price, \$1.20

Lawns and How to Make Them. By LEONARD BARRON. For the first time the subject of lawn seed mixtures is set forth and explained. 32 photographs. Price, \$1.20

How to Make School Gardens. By H. D. HEMENWAY. This suggestive little book is a practical manual of school gardening for both teacher and pupil, and supplies the first adequate work of the sort in this country. There are to-day a hundred thousand school gardens in Europe, and the progress of the recent movement in America has been most rapid. This volume is based on actual experience (the author is an authority and director of the Hartford School of Horticulture). Illustrations, 10. Price, \$1.10

How to Make a Fruit Garden. By S. W. FLETCHER. An eminently practical work on the subject of fruits for the home. With 182 photographic illustrations by the author. Price \$2.25

How to Make a Flower Garden. A charming and a practical book by experts on every branch of the subject. More than 200 beautiful photographs. Price, \$1.75

How to Make a Vegetable Garden. By EDITH L. FULLERTON. The only adequate book on the home vegetable garden. 250 photographs by H. B. Fullerton. Price, \$2.20

Art and Craft of Garden Making. By THOMAS H. MAWSON. Third edition of this standard; out of print for a year, and now reissued in revised form. Over 100 plans and details of gardens. Methods employed by successful designers carefully analyzed. Characteristic sites in typical districts described and pictured. Price, \$15.00

The Home and Farm

The Country House. By CHARLES EDW. HOOPER. A practical manual of house building, absolutely invaluable to everyone with a country place. It covers every branch of the subject in detail and treats of the garden and its furnishings in connection with the dwelling. 380 photographs and plans. Price, \$3.30

Three Acres and Liberty. By BOLTON HALL. Description of what can be accomplished on a small place in the way of gardening, home-making, and addition to financial resources. Were it not for the unimpeachable authorities quoted, its statements as to the possibilities of the "Little Lands" for a living would seem fanciful. Price, \$1.85

Foundations. By W. M. PATTON. A practical treatise explaining fully the principles involved. Numerous descriptions of important modern structures are given in sufficient detail. Includes articles on use of concrete in foundations. Price, \$5.00

Masonry Construction. By IRA O BAKER. Contains results of a great number of experiments, and a large amount of practical data on cost of masonry, pile driving, foundations, culverts, etc., and 97 tables to facilitate estimating. Price, \$5.00

Reinforced Concrete. By ALBERT W. BUEL and CHARLES S. HILL. A treatise for designing and constructing engineers, governed by American practice and conditions. Theoretical discussions omitted, and replaced by practical working formulas, examples of representative structures, and records of practice. Price, \$5.00

The Making of a Country Home. By J. P. MOWBRAY ("J. P. M."). This delightful story showed its universal appeal when published serially, and the volume amply carries out the intention of the author. Besides its practical interest for the thousands of city dwellers who have dreamed of having a country home, the story is one of such reality, humor, and interest as to ensure it the widest circulation in book form. Elaborately decorated. \$1.65

The First Book of Farming. By CHARLES L. GOODRICH. No one interested in farming, old or young, can fail to appreciate this book, for it really gives the fundamental knowledge of how to conduct a farm with the least expense and the largest return. There are 63 full pages of helpful illustrations. The price is extremely low for a work of such value, 63 pages of photographs. Price, \$1.10

Nature Books

American Food and Game Fishes. By DAVID STARR JORDAN and B. W. EVERMANN. Fills a long-felt need in popular scientific works, being a full account of the life-histories and methods of capture of North American food and game fishes. The only book in existence which will enable the amateur readily to identify species new to him. With 10 lithographed color plates, 100 photographs of live fish in the water, and 200 text cuts. Price, \$4.40

Nature Biographies. By CLARENCE M. WEED. This volume is a sort of personal acquaintance with the lives of the more common butterflies, moths, grasshoppers, flies, and so on, the sort of fascinating details of these insect existences which make the reader want to go out and study these every-day marvels for himself. 150 photographic illustrations. Price, \$1.50

The Brook Book. By MARY ROGERS MILLER. A brook is one of the most living and companionable features of the landscape, and few people, even the most ardent nature lovers, realize what an endlessly interesting study its changes and its throbbing life afford. It is a fascinating subject which the author (well known as a teacher, lecturer, and writer connected with the Nature Study Bureau at Cornell) handles with much ability. 16 photographs. Price, \$1.50

Outdoors. A Book of the Woods, Fields and Marshlands. By ERNEST MCGAFFEY. Papers on out of doors, showing a love of nature and keenness of observation and power and beauty of description rarely surpassed. Price, \$1.25

Nature and The Camera. By A. RADCLIFFE DUGMORE. Mr. Dugmore is an expert in the new movement of photographing live birds, animals, fish, flowers, etc. His works brought him so many requests for information, that he has set down here a full and detailed account of his methods. From the choice of a camera to questions of lighting, and to the problem of "snapping" shy birds and animals in their native haunts, every step is explained so simply as to be easily comprehended, even by the beginner. 53 photographic illustrations. Price, \$1.50

To Friends of Conservation!

FORESTRY AND IRRIGATION is preparing to inaugurate an aggressive subscription campaign. The time is ripe—interest in all branches of conservation was never so intense as now—the public is awakening to the gravity of present conditions. We offer

...Dignified Employment...

with good pay to those who work for this magazine.

STUDENTS IN FORESTRY SCHOOLS

are especially wanted. Attractive rates, the highest cash commission, and a magazine of authority in its field. These make our proposition a good one for young men wishing to earn money during the summer vacation.

WILL YOU JOIN US?

For sample copies, terms, etc., address

Forestry and Irrigation

1311 G Street, N.W.

Washington, D. C.

Make Your Unproductive Land Profitable

Don't let a part of your land be idle because of a lack of water. Irrigate it. If there's a running stream or spring on any part of your farm the water can be delivered just where it will do the most good. Simply install a

NIAGARA HYDRAULIC RAM

and start it going. Better than a gasoline engine or windmill. Write for booklet B, and guaranteed estimate. We furnish Caldwell Tanks and Towers.

NIAGARA HYDRAULIC ENGINE CO., 140 Nassau St., New York. Factory: Chester, Pa.

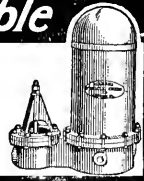

Nominations for Membership

The activities of the National Office of the American Forestry Association are limited chiefly by its resources. These are derived almost wholly from its members in the form of dues. Every member is urged to aid in increasing the membership. Kindly fill out the enclosed blank form, lengthening the list, where possible, by attaching and filling blank sheet. The list should then be sent to

THOMAS E. WILL,
Secretary American Forestry Association,
1311 G Street, Northwest, Washington, D. C.

I hereby nominate the following persons for membership in The American Forestry Association :

Name

Address

.....

.....

Signed.....

THE American Forestry Association

Officers for 1908

President

HON. JAMES WILSON, Secretary of Agriculture

Vice-Presidents-at-Large

DR. EDWARD EVERETT HALE	DR. B. E. FERNOW	
N. J. BACHELDER	GEO. FOSTER PEABODY	GEO. C. PARDEE
RUTHERFORD P. HAYES	ALBERT SHAW	
W. W. FINLEY	J. T. ROTHROCK	
GEO. T. OLIVER	CHARLES R. VAN HISE	

Advisory Board Selected by Affiliated Organizations

SILAS W. GARDNER	H. H. WHELESS	
JAMES INNES	C. H. KEYS	ROBERT C. LIPPINCOTT
GEORGE F. CRAIG	C. A. SMITH	
GEORGE E. STONE	ALLEN CHAMBERLAIN	D. E. KLINE
E. F. SAWYER	F. E. WEYERHAEUSER	KENT SHEPPARD
W. W. KNOX	A. L. HAYES	FREDERICK S. UNDERHILL
ROBERT L. LIPPINCOTT	S. B. ANDERSON	ROBERT A. JOHNSON

Members of Board Designated as Vice-Presidents of Association

N. W. McLEOD	LEWIS DILL	J. T. WYLIE
WILLIAM IRVINE	EDWIN A. START	D. E. KLINE
GEORGE H. HAMPTON	SAMUEL B. VROOMAN	B. W. PORTER

Secretary, THOMAS ELMER WILL, Washington, D. C.

Treasurer, OTTO LUEBKERT, Washington, D. C.

Directors

JAMES WILSON	WILLIAM L. HALL	W. J. MCGEE
GEO. P. WHITTLESEY	GEORGE K. SMITH	PHILIP W. AYRES
JAMES H. CUTLER	WILLIAM S. HARVEY	ROBERT GARRETT
HENRY S. GRAVES	H. A. PRESSEY	LIGON JOHNSON
F. H. NEWELL	ASBURY F. LEVER	FILIBERT ROTH

Application for Membership

To THOMAS ELMER WILL

Secretary American Forestry Association

1311 G Street, N.W., Washington, D. C.

Dear Sir: I hereby signify my desire to become a member of the American Forestry Association. Two Dollars (\$2.00) for annual dues are enclosed herewith.

Very truly yours,

Name _____

P. O. Address _____

.. T H E ..
AMERICAN FORESTRY ASSOCIATION

President—**HON. JAMES WILSON,**
Secretary of Agriculture.

The American Forestry Association was organized in 1882, and incorporated in January, 1897. It now has nearly 7,000 members, residents of every State in the Union, Canada, and foreign countries. From its origin it has been the tireless friend of the forests.

The object of the Association is to promote the preservation, by wise use, and the extension of the forests of the United States; its means are agitation and education; it seeks to encourage the application of forestry by private owners to forest holdings, large or small; and it favors, especially, the establishment and multiplication of National and State forests, to be administered in the highest interests of all.

The Association seeks as members all who sympathize with its object and methods, and who believe that our natural resources constitute a common heritage, to be used without abusing and administered for the common good. Seeking to conserve our supplies of wood and water, the Association appeals especially to wood-producers and users, including owners of wood lands, lumbermen, foresters, railroad men, and engineers; and to those dependent upon equable stream flow, as manufacturers, irrigators, employers of water power, and those engaged in internal commerce.

The Association meets annually in Washington. It publishes, monthly, **FORESTRY AND IRRIGATION**, the magazine of authority in its special field. The list of contributors to this publication includes practically all persons prominent in forest work in the United States, making it alone worth the cost of Annual Membership in the Association.

The dues, covering a subscription to **FORESTRY AND IRRIGATION**, are as follows: Annual—For Annual Members, \$2; for Sustaining Members, \$25; Total, with exemption from all other payments—for Life Members, \$100; for Patrons, \$1,000.

THOMAS ELMER WILL, Secretary.
Address: 1311 G Street, N. W., Washington, D. C.

UNDERWOOD STANDARD TYPEWRITER

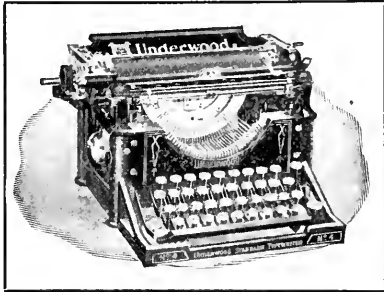

Noted for its

Simplicity of Construction

There are only **THREE**
elements in the
UNDERWOOD

Type-Bar Stroke Mechanism—

**Key Lever,
Connecting Link
and Bar**

Underwood Typewriter
Company, Inc.

New York Anywhere

POSITION WANTED.—ENGINEER, 37 years old, graduate of Cornell University, with four years' experience in hydraulic and irrigation engineering—also business experience—desires position as irrigation engineer. Competent to take charge of any ordinary irrigation project, or would consider place as assistant, if sufficiently attractive.

Address, Box 392, Ithaca, N. Y.

Timber Tract for Sale

FOR SALE—Valuable tract of Spruce, Fir, Hemlock, and Cedar Timber, located in Washington State. 200,000,000 feet of standing timber; railroad, cars, engines, mills, kilns, tools, supplies, etc. Price, \$500,000; half cash. **FENWICK & SPEIDEL Co.**, Buffalo, N. Y.

JUST PUBLISHED

Our Trees

How to Know Them

Photographs from Nature By **ARTHUR I. EMERSON**

With a guide to their recognition at any season of the year and notes on their characteristics, distribution and culture

By **Clarence M. Weed, D. Sc.**

Teacher of Nature-Study in the Massachusetts State Normal School at Lowell.

The purpose of this book is to afford an opportunity for a more intelligent acquaintance with American trees, native and naturalized. The pictures have in all cases been photographed direct from nature, and have been brought together in such a way that the non-botanical reader can recognize at a glance either the whole tree or the leaves, flowers, fruits, or winter twigs, and thus be able to identify with ease and certainty any unknown trees to which his attention may be called.

One hundred and forty illustrations.

Size of book, 7-1/2" x 10"

Cloth, \$3.00 net. Post-paid, \$3.20.

J. B. LIPPINCOTT COMPANY

PUBLISHERS

PHILADELPHIA

Text Books on Conservation

¶ If you are interested in any of the phases of conservation, read the list of publications carried in stock by **FORESTRY AND IRRIGATION** . . .

STUDENTS

will find this list invaluable.

Let us know what you want.

We can fill your order. Address

FORESTRY AND IRRIGATION

1311 G St., Washington, D. C.

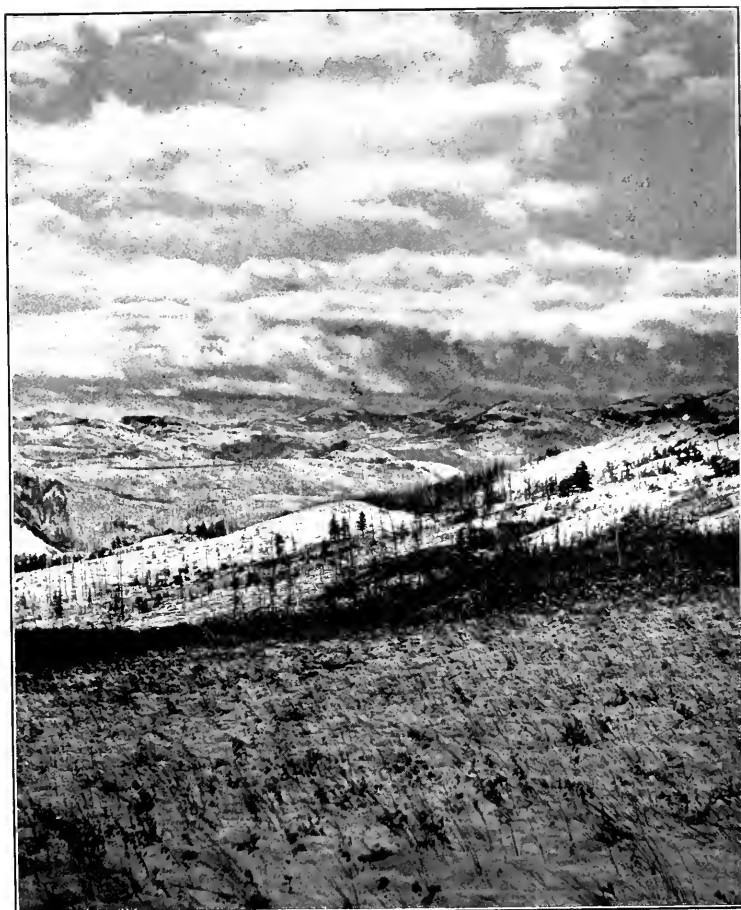

"THE HILLS WHENCE COMETH MY HELP"

Mountain snows that furnish Irrigation water for Arid Land

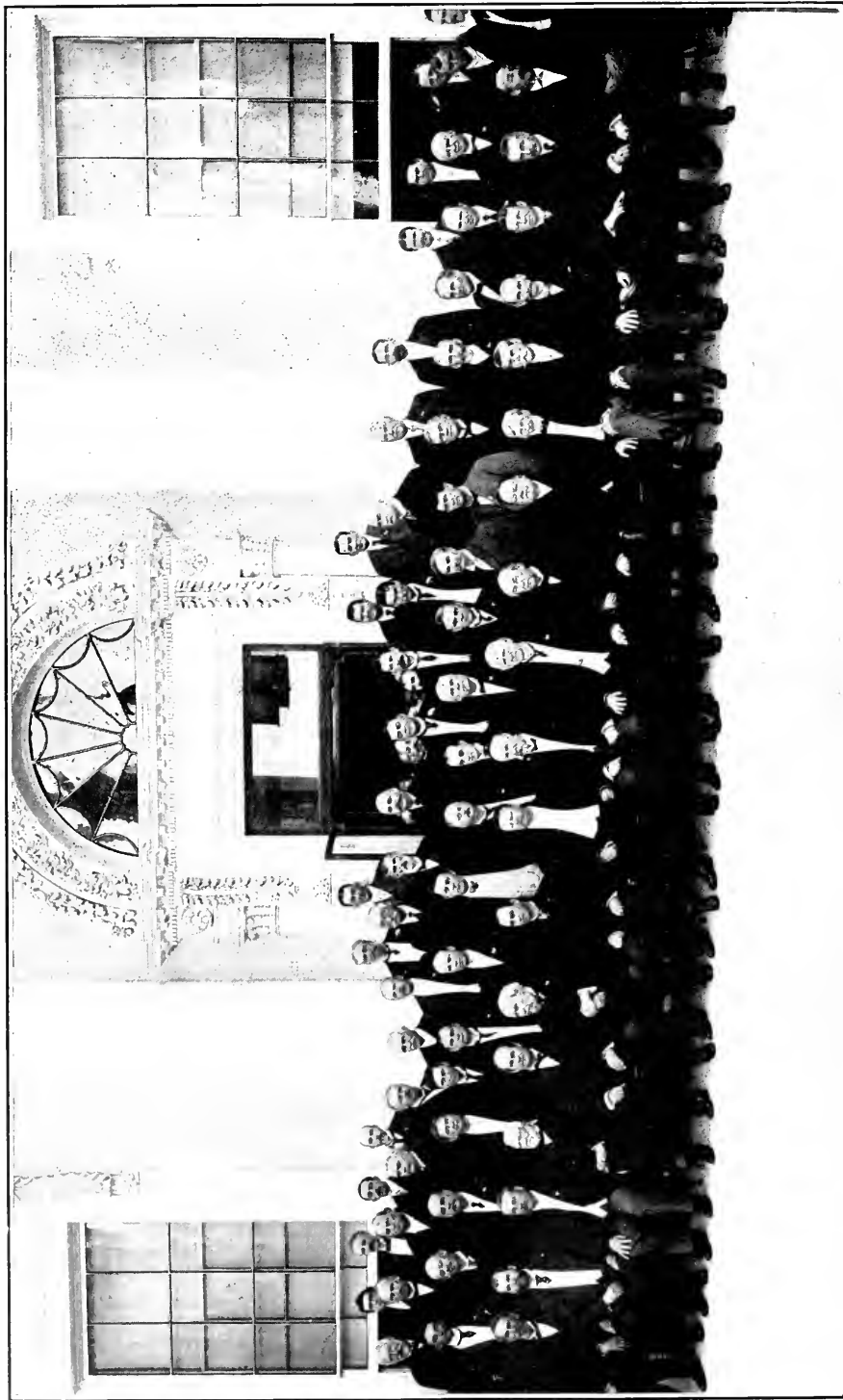

Photo Copyright by Harris & Ewing, Washington

THE WHITE HOUSE CONFERENCE
President Roosevelt, Governors, and conferees on the North Portico of the Executive Mansion



FORESTRY AND IRRIGATION

Vol. XIV.

JUNE 1908.

No. 6.

THE GOVERNORS' CONFERENCE

Historic Gathering at the White House—Executives of Nearly
All the States and Territories Present—Steps Taken
Toward Permanent Organization—The
Story of the Conference

LIBRARY
NEW YORK
BOTANICAL
GARDEN

BY

Frank Glover Heaton, Editor of Forestry and Irrigation.

*There is neither East or West—
Border, nor breed, nor birth—
When two strong men stand face to face,
Though they come from the ends of the earth.*

—Kipling.

IT was a gathering of strong men, that White House Conference—a meeting of the strongest men in the public life of America, called by one of the strongest Chief Executives the Nation has had; and the questions considered were those upon the finding of correct answers to which the abiding prosperity of this, the greatest Nation that has arisen in the world's history, absolutely depends.

"Conservation." That was the keynote of the Conference from the opening address to the close of the final session. Not the miserly hoarding of

the country's resources, but the wise husbanding of timber and coal, of ores and soil, of waters and all the natural wealth which which the Western hemisphere is so richly endowed, and the fullest proper utilization of these resources, that their benefits may be shared equally among the whole people, and that they may be passed on, a practically undiminished capital, to the generations to come.

Crystallized into as brief a paragraph as possible, the sentiment of the Conference was that the work of conservation of all natural resources—

forests, minerals, soils and waters—should be left as largely as possible to the several states, and that a permanent organization of the State Executives should be made, through which the will of the people of the several states shall be expressed, and a comprehensive plan of Nation-wide conservation shall be formulated and carried out by the States, working in concert among themselves and with the Nation.

The tangible results of the Conference, generally speaking, are: The

has the President of the United States met in consultation with the Executives of practically all the states and territories for the consideration of any questions, big or little. And practically every speaker, from President Roosevelt on through the list, emphasized the statement that from the meeting in the East Room of the White House would undoubtedly spring an organization of the Governors that, through its deliberations and the weight of its matured opinions, would exercise, in the years to come, a tre-

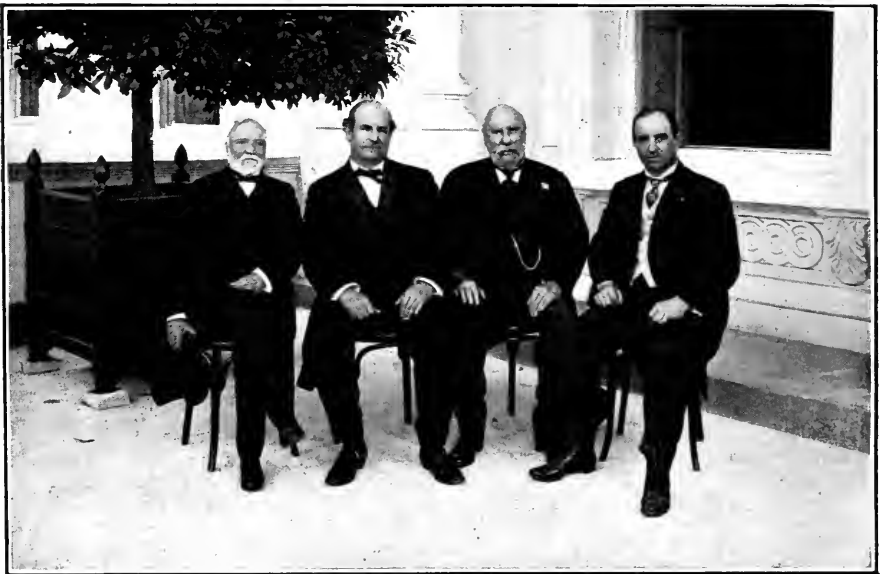

Photo Copyright by Harris & Ewing, Washington

GUESTS OF THE PRESIDENT

Mr. Andrew Carnegie, Hon. W. J. Bryan, Messrs. J. J. Hill, and John Mitchell

formation of a permanent organization of state Executives, and the arousing of a degree of interest among the Governors that resulted in the announcement by several of them that their first official act upon returning to their home states from the Conference will be the appointment of State Forestry Commissions.

From the opening to the close of the Conference stress was frequently laid upon the great historical significance of the gathering, and repeated references were made to the fact that never before in the Nation's history

menhous influence over the destinies and the affairs of the Nation.

With the severe simplicity of its ordinary decoration brightened by draperies of green velvet that overspread almost all the east wall and the platform erected there for the presiding officer, the speakers, and the members of President Roosevelt's Cabinet, the East Room presented an unfamiliar appearance. Two great maps, prepared especially for the Conference, hung on the east wall, one of these maps showing the timber resources of the United States, while the other il-

illustrated the country's mineral deposits. Between these maps, which were the largest, it is said, ever made by mechanical means, an arrangement was provided whereby the different phases of conservation were illustrated by means of superb transparencies. The light for illuminating these transparencies came from a window in the east wall, and the scenes were frequently changed.

On the floor the seating plan had

excellent arrangement of details for making the labors of the Conference as easy as possible.

The membership of this, the initial assembly of what is undoubtedly to develop into one of the most important deliberative and advisory bodies the country has ever known, follows:

Special guests of President Roosevelt:

Hon. William Jennings Bryan, Mr. Andrew Carnegie, Mr. James J. Hill,



Photo Copyright by Harris & Ewing, Washington

SOME OF THE SPEAKERS

Standing—Prof. R. A. Long, J. C. White, and H. S. Putnam
Sitting—Dr. George A. Pardee, J. J. Hill, John Mitchell.

been worked out most admirably. Immediately in front of the platform special chairs for the Governors were ranged in semi-circles, while to the rear and at the sides of these were seats for the Governors' advisers and the other members of the Conference. The problem of seating all the conferees in the limited space was no small one in itself, and its satisfactory working out reflected credit upon the general secretary of the Conference, Mr. Thomas R. Shipp, to whom is also due a share of the credit for the

and Mr. John Mitchell. Owing to his recent illness, former President Cleveland was unable to attend the Conference.

The Governors of the states and territories and their advisers:

Alaska:

Gov. Wilford B. Hoggatt, Sitka.

Maj. W. P. Richardson, U. S. A.; Hon. Dudley N. DuBoise, Nome; Stephen Birch, Veldez.

Arkansas:

Acting Gov. X. O. Pindall, Little Rock.
H. M. Armstead, Little Rock; H. L.

Ponder, Walnut Ridge; Sid B. Redding, Little Rock.

Alabama:

Gov. B. B. Comer, Montgomery.
Hon. R. M. Goodall, Birmingham;
Hon. F. M. Jackson, Birmingham; Hon. W. F. Tebbetts, Mobile.

Arizona:

Gov. Jos. H. Kibbey, Phoenix.
Hon. W. F. Nichols, Willcox; Dwight B. Heard, Phoenix; Hon. B. A. Fowler, Phoenix.

California:

Gov. James N. Gillett, Sacramento.
Hon. Frank H. Short, Fresno; Arthur R. Briggs, President, State Board of Trade, San Francisco; Otto von Geldern.

Colorado:

Gov. Henry A. Buchtel, Denver.
Hon. Earl M. Cranston, Denver; William L. Hartman, Pueblo; Thomas W. Jaycox, State Engineer, Leadville.

Connecticut:

Gov. Rollin S. Woodruff, Hartford.
Dr. Arthur T. Hadley, President, Yale University, New Haven; Col. Norris G. Osborn, Editor, Journal-Courier, New Haven; Chas. Hopkins Clark, Editor, The Courant, Hartford.

Delaware:

Gov. Preston Lea, Dover.
Hon. George Gray, U. S. Circuit Judge, Wilmington; Hon. James Pennewill, Associate Judge, Dover; Benjamin Nields, Wilmington.

Florida:

Gov. Napoleon B. Broward, Tallahassee.
Hon. W. H. Milton, U. S. Senate; Hon. E. H. Sellards, State Geologist, Tallahassee; George F. Miles, St. Augustine.

Georgia:

Gov. Hoke Smith, Atlanta.
John H. Finney, Atlanta; Charleton B. Gibson, Columbus; Chas. S. Barrett, Union City.

Hawaii:

Gov. Walter F. Frear, Honolulu.
Wm. O. Smith; Alonzo Gartley; Ralph S. Hosmer.

Idaho:

Gov. Frank R. Gooding, Boise.
Hon. F. F. Johnson, Wallace; Hon. Fentress Hill, Twin Falls; Hon. E. M. Hoover, Boise.

Illinois:

Gov. Charles S. Deneen, Springfield.
Dr. Edmund J. James, President, University of Illinois, Champaign; Isham Randolph, President, Internal Improvement Commission of Illinois, Chicago; Lyman E. Cooley, Secretary, Internal Improvement Commission, Chicago.

Indiana:

Gov. J. Frank Hanly, Indianapolis;
Henry Riesenberg, Indianapolis; Hon. Frank B. Posey, Evansville; Hon. Joseph D. Oliver, South Bend.

Iowa:

Gov. Albert B. Cummins, Des Moines.
Dr. A. B. Storms, President, Iowa State College, Ames; I. M. Earle, Des Moines; William Loudon, Fairfield.

Kansas:

Gov. Edward W. Hoch, Topeka.
John E. Frost, Topeka; Hon. Eugene F. Ware, Kansas City; John Powers, Marion;

Kentucky:

Gov. Augustus E. Willson, Frankfort.
Col. Andrew Cowan, Louisville; John B. Atkinson, Earlinton; J. W. Porter, President, Kentucky Development Association.

Louisiana:

Gov. Newton C. Blanchard, Baton Rouge.
John M. Parker, New Orleans; Thos. J. Kernan, Baton Rouge; Hon. E. H. Farrar, New Orleans.

Maine:

Gov. Wm. T. Cobb, Augusta.
Ex-Gov. John F. Hill, Augusta; Hon. Edgar E. Ring, Orono; Prof. Austin Cary, Brunswick.

Maryland:

Gov. Austin L. Crothers, Annapolis.
Dr. William Bullock Clark, Johns Hopkins University, Baltimore; Bernard N. Baker, Baltimore; Edward Hirsch, Baltimore.

Massachusetts:

Gov. Curtis Guild, Boston.
Prof. Frank W. Rane, State Forester, Boston; Prof. Kenyon L. Butterfield, Amherst, President, Massachusetts Agricultural College; Prof. George F. Swain, Massachusetts Institute of Technology at Boston.

Michigan:

Gov. Fred M. Warner, Lansing.
Dr. James B. Angell, President, University of Michigan, Ann Arbor; Hon. Chase S. Osborn, Sault Ste. Marie; Charles B. Blair, Grand Rapids.

Minnesota:

Gov. John A. Johnson, St. Paul.
Dr. Cyrus Northrup, President, University of Minnesota, Minneapolis; Ex-Gov. John Lind, President, Board of Regents, University of Minnesota, Minneapolis; Hon. F. B. Lynch, St. Paul.

Mississippi:

Gov. Edward F. Noel, Jackson.
Judge D. M. Miller, Hazlehurst, Miss.; A. M. Pepper, Lexington, Miss.; Dr. J. D. Barkdull, Natchez.

Missouri:

Gov. Joseph W. Folk, Jefferson City.
Dr. William H. Black, Marshall; N.
W. McLeod, St. Louis; Col. James A.
Ockerson, St. Louis.

Montana:

Gov. Edwin Norris, Helena.
Paul A. Fusz, Philipsburg; W. B.
George, Billings; Henry M. Rae, Gilt Edge.

Nebraska:

Gov. G. L. Sheldon, Lincoln.

Nevada:

Gov. John Sparks, Carson City.
B. F. Leete, Reno; C. H. E. Hardin,
Ocean Park, Calif.; James A. Yerington,
Carson City.

New Hampshire:

Gov. Chas. M. Floyd, Concord.
Philip W. Ayres, Concord; Gen.
Charles J. Hamblett, Nashua; Hon. Ir-
ving W. Drew, Lancaster.

New Jersey:

Gov. John F. Fort, Trenton;
Charles L. Pack; Henry B. Kummel;
Wilbur F. Sadler, Jr.

New Mexico:

Gov. George Curry, Santa Fe.
W. C. Barnes; Ralph E. Twitchell, Las
Vegas; George Arnot, Albuquerque.

New York:

Gov. Charles E. Hughes, Albany.
Dr. Nichols Murray Butler, President,
Columbia University, New York City;
Dr. Jacob Gould Schurman, President,
Cornell University, Ithaca; Hon. James
S. Whipple, State Forest, Fish and Game
Commissioner, Salamanca.

North Carolina:

Gov. Robert B. Glenn, Raleigh.
Judge A. Boswell, Charlotte; Hon. C.
H. Arnfield, Statesville; Hon. A. D.
Woods, New Bern.

North Dakota:

Gov. John Burke, Bismarck.
Hon. J. L. Cashel, Grafton; Judge F.
L. Thompson, Cando; Dr. L. S. Platou,
Valley City.

Ohio:

Gov. A. L. Harris, Columbus.
Maj. George B. Fox, Lockland; D. J.
Sinclair, Steubenville; Allen Ripley
Foote, Columbus.

Oklahoma:

Gov. C. N. Haskell, Guthrie.
Geo. W. Barnes, President Commercial
National Bank of Muskogee; J. Y. Calla-
han, Enid; Hon. Thos. H. Owen, Mus-
kogee.

Oregon:

Gov. George E. Chamberlain, Salem.
C. S. Jackson, Daily Journal, Portland;
Hon. B. S. Bean, Chief Justice, Supreme
Court, Salem; F. C. Knapp, Portland.

Pennsylvania:

Gov. Edwin S. Stuart, Harrisburg.
Col. C. A. Rook, Pittsburg; Alba B.
Johnson, Philadelphia; Hon. Robert S.
Murphy, Johnstown.

Porto Rico:

Gov. Regis H. Post, San Juan.
Hon. Toullo Larrinaga, Commissioner
from Porto Rico, Washington, D. C.;
Hon. Beekman Winthrop, Assistant Sec-
retary of the Treasury, Washington, D.
C.; Hon. Geo. W. Davis, Washington,
D. C.

Rhode Island:

Gov. James H. Higgins, Providence.
Dr. William H. P. Faunce, President,
Brown University; E. G. Buckland, Vice-
President, New York, New Haven and
Hartford R. R.; William J. Feeley, Provi-
dence.

South Carolina:

Gov. Martin F. Ansel, Columbia;
Prof. A. C. Moore, South Carolina Uni-
versity, Columbia; J. E. Serrine, Mill
Architect and Engineer, Greenville; J.
C. Hemphill, Editor, News and Courier,
Charleston.

South Dakota:

Gov. Coe I. Crawford, Pierre.
Hon. R. O. Richards, Huron; Hon.
T. S. Everett, Redfield; Hon. Bartlett
Tripp, Yankton.

Tennessee:

Gov. Malcolm R. Patterson, Nashville.
Hon. John Allison, Nashville; Hon.
Floyd Estill, Winchester; Hon. Eldridge
E. Wright, Memphis.

Texas:

Gov. T. M. Campbell, Austin.
Hon. W. Goodrich Jones, Temple;
Hon. Richard F. Burges, El Paso; Hon.
B. M. Baker.

Utah:

Gov. John C. Cutler, Salt Lake City.
Wm. W. Riter, Salt Lake City; Frank
B. Stephens, Salt Lake City; James H.
Mays, Salt Lake City.

Virginia:

Gov. Claude A. Swanson, Richmond.
Dr. E. A. Alderman, President, University
of Virginia, Charlottesville; Hon. James B.
Russell, Winchester; Hon. Rosewell Page,
Beaver Dam.

Washington:

Gov. A. E. Mead, Olympia.
Hon. E. W. Ross, State Land Commis-
sioner, Olympia; Prof. O. L. Waller, State
College, Pullman; Frank H. Lamb, Ho-
quiam.

West Virginia:

Gov. W. M. O. Dawson, Charleston.
Dr. I. C. White, State Geologist, Morgantown; Hu Maxwell, Morgantown; James

W. Paul, Chief, Department of Mines of West Virginia, Charleston.

Wisconsin:

Gov. James O. Davidson, Madison.
Hon. E. M. Griffith, State Forester, Madison; Hon. J. H. Stout, Menomonie; Hon. George A. Whiting, Neenah.

Wyoming:

Gov. Bryant B. Brooks, Cheyenne.
Hon. C. W. Burdick, Cheyenne; George Metcalf, Douglas; Hon. Edward Gillette, Sheridan.

Vermont:

Gov. Fletcher Proctor, Montpelier.
Hon. Joseph A. DeBoer, Montpelier;

American Civic Association, President, J. Horace MacFarland, Harrisburg, Pa.

American Economic Association, President, Simon Patton, Philadelphia, Pa.

American Federation of Labor, President, Samuel Gompers, Washington, D. C.

American Forestry Association, Col. Wm. S. Harvey, Philadelphia, Pa.

American Institute of Architects, President, Cass Gilbert, Washington, D. C.

American Institute of Electrical Engineers, President, Henry G. Stott, New York City.

American Medical Association, President, Dr. Jos. D. Bryant, New York City.

American Institute of Mining Engineers,



AMERICA'S INLAND WATERWAYS

River System of the Nation, to be Developed by Dredging and Canalization

Hon. Jonathan L. Southwick, Burlington;
Hon. Willis N. Cady, Middlebury.

Representatives of national organizations interested in the different phases of conservation:

American Association of Agricultural Colleges and Experiment Stations, President, J. L. Snyder, Lansing, Mich.

American Association for the Advancement of Science, President, T. C. Chamberlin, University of Chicago, Chicago, Ill.

American Academy of Political and Social Science, President, L. S. Rowe, University of Pennsylvania, Philadelphia, Pa.

American Bar Association, President, J. M. Dickinson, Park Row, Chicago, Ill.

American Chemical Society, President, Marston T. Bogart, Columbia University, New York City.

President, John Hays Hammond, New York City.

American National Livestock Association, President, H. A. Jastro, Bakersfield, Cal.

American Newspaper Publishers' Association, President, Herman Ridder, New York City.

American Public Health Association, President, Dr. Richard H. Lewis, Raleigh, N. C.

American Pulp and Paper Association, President, David S. Cowles, New York City.

American Railway Association, President, F. A. Delano, New York City.

American Railway Engineering and Maintenance of Way Association, President, Walter G. Berg, New York City.

American Railway Master Mechanics Association, President, Wm. McIntosh, Jersey City, N. J.

American Scenic and Historic Preservation Society, President, Dr. Geo. G. Kunz, New York City.

American Society of Civil Engineers, President, Chas. MacDonald, New York City.

American Society of Mechanical Engineers, President, M. L. Holman, St. Louis.

American Society for Testing Materials, President, Chas. B. Dudley, Altoona, Pa.

American Statistical Association, President, Hon. Carroll D. Wright, Worcester, Mass.

Atlantic Deep Waterways Association, President, J. Hampton Moore, Philadelphia, Pa.

Brotherhood of Locomotive Engineers, Brotherhood of Locomotive Firemen and Engineers, Brotherhood of Railroad Trainmen, H. R. Fuller, Washington, D. C.

Business Men's League, President, James E. Smith, St. Louis, Mo.

Carriage Builders' National Association, President, J. B. Dort, Flint, Michigan.

Chautauqua Institute, President, Dr. George H. Vincent, University of Chicago, Ill.

Farmers' National Congress, President, B. Cameron, Stagville, N. C.

General Federation of Women's Clubs, President, Mrs. Sarah S. Platt Decker, Denver, Colo.

Geological Society of America, President, Samuel Calvin, Iowa City, Iowa.

Interstate Inland Waterway, President, C. S. E. Holland, Victoria, Texas.

Interstate Mississippi River Improvement and Levee Association, President, Chas. Scott, Rosedale, Miss.

Lake Carriers' Association, President, William Livingston, Detroit, Mich.

Lakes-to-the-Gulf Deep Waterways Association, President, W. K. Kavanaugh, St. Louis, Mo.

Mining Congress of America, President, J. H. Richards, Boise, Idaho.

Missouri Valley Improvement Association, President, Lawrence M. Jones, Kansas City, Mo.

National Academy of Sciences, President, Ira Remsen, Baltimore, Md.

National Advisory Board Fuels and Structural Materials, Vice-Chairman, Robt. W. Hunt.

National Association of Cotton Manufacturers, President, W. D. Hartshorne, Lawrence, Miss.

National Association of Manufacturers, President, James W. Van Cleave, St. Louis, Mo.

National Association of Agricultural Implement and Vehicle Manufacturers, President, Newell Sanders, Chatanooga, Tenn.

National Association of State Universities, President, Chas. R. Van Hise, Madison, Wis.

National Board of Fire Underwriters, Powell Evans, Chicago, Ill.

National Board of Trade, Vice-President, Frank L. Lanne, Philadelphia, Pa.

National Business League of America, A. A. Burnham, Chicago.

National Civic Federation, President, Seth Low, New York City.

National Council of Commerce, President, Gustav H. Schwab, New York City.

National Editorial Association, President, Henry B. Varner, Lexington, N. C.

National Educational Association, President, Dr. E. G. Cooley, Supt. of City Schools, Chicago, Ill.

National Electric Light Association, President, D. Farrand, Newark, N. J.

National Geographic Society, President, Willis L. Moore, Washington, D. C.

National Grange, President, N. J. Bachelor, Concord, N. H.

National Hay Association, President, Chas. J. Austin, New York City.

National Irrigation Congress, President, Frank C. Goudy, Denver, Colo.

National Lumber Manufacturers' Association, President, Wm. Irvine, Chippewa Falls, Wisconsin.

National Rivers and Harbors Congress, President, Hon. Jos. E. Ransdell, Lake Providence, La.

National Slack Cooperage Manufacturers' Association, President, H. M. Schmoltdt, Beardstown, Ill.

National Wagon Manufacturers' Association, President, Richard Carpenter, La Fayette, Indiana.

National Wool Growers' Association, President, Fred Gooding, Shoshone, Idaho.

Ohio Valley Improvement Association, President, Col. John L. Vance, Cincinnati, Ohio.

Society for the Promotion of Engineering Education, President, Chas. S. Howe, Case School of Applied Science, Cleveland, Ohio.

Society of American Foresters, Overton W. Price, Forest Service, Washington.

Trans-Mississippi Commercial Congress, President, J. B. Case, Abilene, Kans.

United Mine Workers of America, President, T. L. Lewis, Indianapolis, Ind.

Upper Mississippi River Improvement Association, President, Thomas Wilkinson, Burlington, Iowa.

Besides these delegates, members of the United States Supreme Court, members of the Cabinet, and members of Congress, together with representatives of the press, made up the personnel of the Conference.

FIRST DAY'S SESSIONS

Called to order at 11 o'clock on Wednesday, May 13, by the President, the session was opened with a reading from the Scriptures by the Rev. Edward Everett Hale, followed by a prayer by the venerable chaplain. Following the invocation, President Roosevelt addressed the Conference in a speech that sounded the keynote of the meeting. The President's address follows:

Governors of the Several States and Gentlemen:

I welcome you to this Conference at the White House. You come hither at my request so that we may join together to consider the question of the conservation and use of the great fundamental sources of wealth of this Nation. So vital is this question that for the first time in our history the chief executive officers of the states separately, and of the states together forming the Nation, have met to consider it.

With the governors come men from each state, chosen for their special acquaintance with the terms of the problem that is before us. Among them are experts in natural resources and representatives of national organizations concerned in the development and use of these resources; the Senators and Representatives in Congress; the Supreme Court, the Cabinet, and the Inland Waterways Commission have likewise been invited to the Conference, which is therefore national in a peculiar sense.

This Conference on the conservation of natural resources is in effect a meeting of the representatives of all the people of the United States, called to consider the mightiest problem now before the Nation; and the occasion for the meeting lies in the fact that the natural resources of our country are in danger of exhaustion if we permit the old, wasteful methods of exploiting them longer to continue.

With the rise of peoples from savagery to civilization, and with the consequent growth in the extent and variety of the needs of the average man, there comes a steadily increasing growth of the amount demanded by this average man from the actual resources of the country. Yet, rather curiously, at the same time, the average man is apt to lose his realization of this dependence upon nature.

Savages, and very primitive peoples generally, concern themselves only with superficial natural resources; with those which they obtain from the actual surface of the ground. As people become a little less primitive, their industries, although in a rude manner, are extended to resources below the surface; then, with what we call

civilization and the extension of knowledge, more resources come into use, industries are multiplied, and foresight begins to become a necessary and prominent factor in life. Crops are cultivated; animals are domesticated; and metals are mastered.

Every step of the progress of mankind is marked by the discovery and use of natural resources previously unused. Without such progressive knowledge and utilization of natural resources population could not grow, nor industries multiply, nor the hidden wealth of the earth be developed for the benefit of mankind.

From the beginnings of civilization, on the banks of the Nile and the Euphrates, the industrial progress of the world has gone on slowly, with occasional setbacks, but on the whole steadily, through tens of centuries to the present day. But of late the rapidity of the process has increased at such a rate that more space has been actually covered during the century and a quarter occupied by our national life than during the preceding six thousand years that take us back to the earliest monuments of Egypt, to the earliest cities of the Babylonian plain.

When the founders of this Nation met in Independence Hall, in Philadelphia, the conditions of commerce had not fundamentally changed from what they were when the Phoenician keels first furrowed the lonely waters of the Mediterranean. The differences were those of degree, not of kind, and they were not in all cases even those of degree. Mining was carried on fundamentally as it had been carried on by the Pharaohs in the countries adjacent to the Red Sea.

In 1776 the wares of the merchants of Boston, of Charleston, like the wares of the merchants of Nineveh and Sidon, if they went by water, were carried by boats propelled by sails or oars; if they went by land, were carried in wagons drawn by beasts of draft or in packs on the backs of beasts of burden. The ships that crossed the high seas were better than the ships that 3,000 years before crossed the Aegean; but they were of the same type, after all—they were wooden ships propelled by sails; and on land the roads were not as good as the roads of the Roman Empire, while the service of the posts was probably inferior.

In Washington's time anthracite coal was known only as a useless black stone; and the great fields of bituminous coal were undiscovered. As steam was unknown, the use of coal for power production was undreamed of. Water was practically the only source of power, save the labor of men and animals; and this power was used only in the most primitive fashion. But a few small iron deposits had been found in this country, and the use of iron by our countrymen was very small. Wood was prac-

tically the only fuel, and what lumber was sawed was consumed locally, while the forests were regarded chiefly as obstructions to settlement and civilization.

Such was the degree of progress to which civilized mankind had attained when this Nation began its career. It is almost impossible for us in this day to realize how little our Revolutionary ancestors knew of the great store of natural resources whose discovery and use have been such vital factors in the growth and greatness of this Nation, and how little they required to take from this store in order to satisfy their needs.

Since then our knowledge and use of the resources of the present territory of the

Yet our fathers, though they knew so little of the resources of the country, exercised a wise forethought in reference thereto. Washington clearly saw that the perpetuity of the states could only be secured by union, and that the only feasible basis of union was an economic one; in other words, that it must be based upon the development and use of their natural resources. Accordingly, he helped to outline a scheme of commercial development, and by his influence an interstate waterways commission was appointed by Maryland and Virginia.

It met near where we are now meeting, in Alexandria, adjourned to Mount Vernon, and took up the consideration of interstate commerce by the only means then avail-



DESTRUCTION OF A WATERWAY
Formation of Silt Bar in a Navigable Stream

United States have increased a hundred-fold. Indeed, the growth of this Nation by leaps and bounds makes one of the most striking and important chapters in the history of the world. Its growth has been due to the rapid development, and alas! that it should be said, to the rapid destruction, of our natural resources. Nature has supplied to us in the United States, and still supplies to us, more kinds of resources in a more lavish degree than has ever been the case at any other time or with any other people. Our position in the world has been attained by the extent and thoroughness of the control we have achieved over nature; but we are more, and not less, dependent upon what she furnishes than at any previous time of history since the days of primitive man.

able, that of water. Further conferences were arranged, first at Annapolis and then at Philadelphia. It was in Philadelphia that the representatives of all the states met for what was in its original conception merely a waterways conference; but when they had closed their deliberations the outcome was the Constitution which made the states into a Nation. (Applause.)

The Constitution of the United States thus grew in large part out of the necessity for united action in the wise use of our natural resources. The wise use of all of our natural resources, which are our national resources as well, is the great material question of to-day. I have asked you to come together now because the enormous consumption of these resources, and the threat of imminent exhaustion of them,

due to reckless and wasteful use, once more calls for common effort, common action.

Since the days when the Constitution was adopted, steam and electricity have revolutionized the industrial world. Nowhere has the revolution been so great as in our own country. The discovery and utilization of mineral fuels and alloys have given us the lead over all other nations in the production of steel. The discovery and utilization of coal and iron have given us our railways, and have led to such industrial development as has never before been seen. The vast wealth of lumber in our forests, the riches of our soils and mines, the discovery of coal and mineral oils, combined with the efficiency of our transportation, have made the conditions of our life unparalleled in comfort and convenience.

The steadily increasing drain on these natural resources has promoted to an extraordinary degree the complexity of our industrial and social life. Moreover, this unexampled development has had a determining effect upon the character and opinions of our people. The demand for efficiency in the great task has given us vigor, effectiveness, decision, and power, and a capacity for achievement which in its own lines has never yet been matched. (Applause.) So great and so rapid has been our material growth that there has been a tendency to lag behind in spiritual and moral growth (laughter and applause); but that is not the subject upon which I speak to you to-day.

Disregarding for the moment the question of moral purpose, it is safe to say that the prosperity of our people depends directly on the energy and intelligence with which our natural resources are used. It is equally clear that these resources are the final basis of national power and perpetuity. Finally, it is ominously evident that these resources are in the course of rapid exhaustion.

This Nation began with the belief that its landed possessions were illimitable and capable of supporting all the people who might care to make our country their home; but already the limit of unsettled land is in sight, and indeed but little land fitted for agriculture now remains unoccupied save what can be reclaimed by irrigation and drainage. We began with an unapproached heritage of forests; more than half of the timber is gone. We began with coal fields more extensive than those of any other nation, and with iron ores regarded as inexhaustible, and many experts now declare that the end of both coal and iron is in sight.

The mere increase in the consumption of coal during 1907 over 1906 exceeded the total consumption in 1876, the Centennial year. The enormous stores of mineral oil and gas are largely gone. Our natural waterways are not gone, but they have been so injured by neglect, and by the division

of responsibility and utter lack of system in dealing with them, that there is less navigation on them now than there was fifty years ago. Finally, we began with soils of unexampled fertility and we have so impoverished them by injudicious use and by failing to check erosion that their crop producing power is diminishing instead of increasing. In a word, we have thoughtlessly, and to a large degree unnecessarily, diminished the resources upon which not only our prosperity but the prosperity of our children must always depend.

We have become great because of the lavish use of our resources, and we have just reason to be proud of our growth. But the time has come to inquire seriously what will happen when our forests are gone, when the coal, the iron, the oil, and the gas are exhausted, when the soils shall have been still further impoverished and washed into the streams, polluting the rivers, denuding the fields, and obstructing navigation. These questions do not relate only to the next century or to the next generation. It is time for us now as a Nation to exercise the same reasonable foresight in dealing with our great natural resources that would be shown by any prudent man in conserving and wisely using the property which contains the assurance of well being for himself and his children.

The natural resources I have enumerated can be divided into two sharply distinguished classes accordingly as they are or are not capable of renewal. Mines if used must necessarily be exhausted. The minerals do not and cannot renew themselves. Therefore, in dealing with the coal, the oil, the gas, the iron, the metals generally, all that we can do is to try to see that they are wisely used. The exhaustion is certain to come in time.

The second class of resources consists of those which cannot only be used in such manner as to leave them undiminished for our children, but can actually be improved by wise use. The soil, the forests, and the waterways come in this category. In dealing with mineral resources, man is able to improve on nature only by putting the resources to a beneficial use, which in the end exhausts them; but in dealing with the soil and its products man can improve on nature by compelling the resources to renew and even reconstruct themselves in such manner as to serve increasingly beneficial uses—while the living waters can be so controlled as to multiply their benefits.

Neither the primitive man nor the pioneer was aware of any duty to posterity in dealing with the renewable resources. When the American settler felled the forests, he felt that there was plenty of forest left for the sons that came after him. When he exhausted the soil of his farm he felt that his son could go West and take up another. So it was with his immediate successors. When the soil-wash from the farmer's fields

choked the neighboring river he thought only of using the railway rather than boats for moving his produce and supplies.

Now all this is changed. On the average the son of the farmer of to-day must make his living on his father's farm. There is no difficulty in doing this if the father will exercise wisdom. No wise use of a farm exhausts its fertility. So with the forests. We are over the verge of a timber famine in this country, and it is unpardonable for the Nation or the states to permit any further cutting of our timber save in accordance with a system which will provide that the next generation shall see the timber increased instead of diminished. (Applause.) Moreover, we can add enormous tracts of the most valuable possible agricultural land to the national domain by irrigation in the arid and semi-arid regions and by drainage of great tracts of swamp lands in the humid regions. We can enormously increase our transportation facilities by the canalization of our rivers so as to complete a great system of waterways on the Pacific, Atlantic, and Gulf coasts and in the Mississippi Valley, from the Great Plains to the Alleghenies and from the northern lakes to the mouth of the mighty Father of Waters. But all these various cases of our natural resources are so closely connected that they should be co-ordinated, and should be treated as part of one coherent plan and not in haphazard and piecemeal fashion.

It is largely because of this that I appointed the Waterways Commission last year and that I have sought to perpetuate its work. I wish to take this opportunity to express in heartiest fashion my acknowledgment to all the members of the Commission. At great personal sacrifice of time and effort they have rendered a service to the public for which we cannot be too grateful. Especial credit is due to the initiative, the energy, the devotion to duty and the farsightedness of Gifford Pinchot (great applause), to whom we owe so much of the progress we have already made in handling this matter of the co-ordination and conservation of natural resources. If it had not been for him this convention neither would or could have been called.

We are coming to recognize as never before the right of the Nation to guard its own future in the essential matter of natural resources. In the past we have admitted the right of the individual to injure the future of the Republic for his own present profit. The time has come for a change. As a people we have the right and the duty, second to none other but the right and duty of obeying the moral law, of requiring and doing justice, to protect ourselves and our children against the wasteful development of our natural resources, whether that waste is caused by the actual destruction of such resources or by making them impossible of development hereafter.

Any right thinking father earnestly de-

sires and strives to leave his son both an untarnished name and a reasonable equipment for the struggle of life. So this Nation as a whole should earnestly desire and strive to leave to the next generation the national honor unstained and the national resources unexhausted. There are signs that both the Nation and the states are waking to a realization of this great truth. On March 10, 1908, the Supreme Court of Maine rendered an exceedingly important judicial decision. This opinion was rendered in response to questions as to the right of the legislature to restrict the cutting of trees on private land for the prevention of droughts and floods, the preservation of the natural water supply, and the prevention of the erosion of such lands, and the consequent filling up of rivers, ponds, and lakes. The forests and water powers of Maine constitute the larger part of her wealth and form the basis of her industrial life, and the question submitted by the Maine Senate to the Supreme Court and the answer of the Supreme Court alike bear testimony to the wisdom of the people of Maine, and clearly define a policy of conservation of natural resources, the adoption of which is of vital importance, not merely to Maine, but to the whole country. (Applause.)

Such a policy will preserve soil, forests, water power as a heritage for the children and the children's children of the men and women of this generation; for any enactment that provides for the wise utilization of the forests, whether in public or private ownership, and for the conservation of the water resources of the country, must necessarily be legislation that will promote both private and public welfare; for flood prevention, water power development, preservation of the soil, and improvement of navigable rivers are all promoted by such a policy of forest conservation.

The opinion of the Maine Supreme bench sets forth unequivocally the principle that the property rights of the individual are subordinate to the rights of the community, and especially that the waste of wild timber land derived originally from the State, involving as it would the impoverishment of the state and its people and thereby defeating one great purpose of government, may properly be prevented by state restrictions.

The court says that there are two reasons why the right of the public to control and limit the use of private property is peculiarly applicable to property in land: "First, such property is not the result of productive labor, but is derived solely from the state itself, the original owner; second, the amount of land being incapable of increase, if the owners of large tracts can waste them at will without state restriction, the state and its people may be helplessly impoverished and one great purpose of government defeated. * * * We do not

think the proposed legislation would operate to 'take' private property within the inhibition of the Constitution. While it might restrict the owner of wild and uncultivated lands in his use of them, might delay his taking some of the product, might delay his anticipated profits and even thereby might cause him some loss of profit, it would nevertheless leave him his lands, their product and increase, untouched, and without diminution of title, estate or quantity. He would still have large measure of control and large opportunity to realize values. He might suffer delay but not deprivation. * * * The proposed legislation * * * would be within the legislative power and would not operate as a taking of private property for which compensation must be made."

The Court of Errors and Appeals of New Jersey has adopted a similar view, which has recently been sustained by the Supreme Court of the United States. In delivering the opinion of the court on April 6, 1908, Mr. Justice Holmes said: "The state, as quasi-sovereign and representative of the interests of the public, has a standing in court to protect the atmosphere, the water, and the forests within its territory, irrespective of the assent or dissent of the private owners of the land most immediately concerned. * * * It appears to us that few public interests are more obvious, indisputable and independent of particular theory than the interest of the public of a state to maintain the rivers that are wholly within it substantially undiminished, except by such drafts upon them as the guardian of the public welfare may permit for the purpose of turning them to a more perfect use. (Applause.) This public interest is omnipresent wherever there is a state, and grows more pressing as population grows. * * * We are of opinion, further, that the constitutional power of the state to insist that its natural advantages shall remain unimpaired by its citizens is not dependent upon any nice estimate of the extent of present use or speculation as to future needs. The legal conception of the necessary is apt to be confined to somewhat rudimentary wants, and there are benefits from a great river that might escape a lawyer's view. (Laughter and applause.) But the state is not required to submit even to an aesthetic analysis. Any analysis may be inadequate. It finds itself in possession of what all admit to be a great public good, and what it has it may keep and give no one a reason for its will."

These decisions reach the root of the

AFTERNOON SESSION

When the afternoon session was called to order President Roosevelt announced that, owing to his multitudinous duties, it would be impossible

idea of conservation of our resources in the interests of the people.

Finally, let us remember that the conservation of our natural resources, though the gravest problem of to-day, is yet but part of another and greater problem to which this Nation is not yet awake, but to which it will awake in time, and with which it must hereafter grapple if it is to live—the problem of national efficiency, the patriotic duty of insuring the safety and continuance of the Nation. (Applause.) When the people of the United States consciously undertake to raise themselves as citizens, and the Nation and the states in their several spheres, to the highest pitch of excellence in private, state, and national life, and to do this because it is the first of all the duties of true patriotism, then and not till then the future of this Nation, in quality and in time, will be assured. (Great applause.)

Following the address of the President, it was suggested that, in order to expedite the work of the Conference, the special statements, or papers, to be presented by the "experts," be limited to twenty minutes; that discussion be limited to ten minutes, and that all resolutions be handed, without reading, to a committee on resolutions, such committee to be charged with the work of formulating the general conclusions of the Conference. In line with this suggestion President Roosevelt proposed Governors Blanchard, of Louisiana; Fort, of New Jersey; Cutler, of Utah; Davidson, of Wisconsin, and Ansel, of South Carolina, as a Committee on Resolutions, and on motion of Governor Johnson, of Minnesota, the suggestion was carried out. Dr. W J McGee, secretary of the Inland Waterways Commission, sat with the committee.

At the conclusion of the morning session the members of the Conference passed out through the Blue Room, where the President met and personally greeted each of the Governors and conferees.

for him to preside over all of the sessions, and that he would call to the chair one or another of the Governors present to act in his place. The

President stated that he would open each session, remaining until after the reading of the first paper. Governor Noel, of Mississippi, was then called to the chair, the President retiring at the conclusion of the paper read by Mr. Andrew Carnegie. Mr. Carnegie's address dealt with the country's supplies of iron and related ores, and, being the statement of perhaps the best posted practical authority in the United States on this subject, it was received with careful attention. The address follows:

You have begun to make history to-day, for never before has the National Governor called all the state Governors into conference. The President has acted upon the axiom that while it is well to follow good precedents, it is better to make them. Washington in 1785 invited the Commissioners of Maryland and Virginia to Mount Vernon, when they conferred at Alexandria upon the joint regulation of the Potomac. This was the first slight revelation of the important interstate problems which lie imbedded in our Federal system. It is no new question with which you have to deal. My province to-day is to ask your attention to the situation as affected by our mineral supplies, chiefly iron and coal.

But let me first state that for all the data, facts, and much else used in this address I am indebted to Government officials of the Geological Survey and other scientific bureaus, the extent and variety of whose knowledge have much impressed me, although I have long known that our Government is celebrated for the range and thoroughness of its investigations and the amount of statistical information it has acquired and keeps up to date regarding the Nation and people. I have heard more than one prominent public man of other lands express admiration for our governmental reports.

Of all the world's metals, iron is in our day the most useful. The opening of the Iron Age marked the beginning of real industrial development. The mining of copper and tin and the making of bronze implements closed the Stone Age in Europe and Asia, but it was not until the smelting of iron started in Africa and spread to Europe that industrial progress began; in all countries the highest civilization has followed the use of iron in the arts and crafts. To-day the position of nations may almost be measured by its production and use.

Iron and coal are the foundation of our industrial prosperity. The value of each depends upon the amount and nearness of the other. In modern times the manufacturing and transportation industries rest upon them, and, given sufficient land area

and fertile soil, these determine the progress of any people. When the United States entered upon its unexampled career the extent and value of our deposits of iron and coal were unknown. It was only through the growth of population, increase of knowledge, and invention, that they gained such value as to render their quantity an important public question.

Iron smelting began with charcoal made in neighboring forests. Electrical smelting by means of water power has only recently been tried. To-day the reduction of our ores and the manufacture of iron practically rest upon the extent and availability of our coal.

When the Republic was founded there were, according to recent expert estimates, approximately 2,000,000,000 tons of coal in the territory now forming the United States. Practically none of this supply was used for over a quarter-century; but during the 75 years from 1820 to 1895 nearly 4,000,000,000 tons were mined by methods so wasteful that some 6,000,000,000 tons were either destroyed or allowed to remain in the ground, forever inaccessible. During the ten years from 1896 to 1906 as much was produced as during the preceding 75 years; while more than 3,000,000,000 tons were destroyed or left in the ground beyond reach of future use. To date the actual consumption of coal has been over 7,500,000,000 tons; the waste and destruction in the neighborhood of 9,000,000,000 tons. If mining were perfected from now forward we might reckon that considerably less than 1 per cent of our original stock has been consumed; but estimating on the basis of the wasteful methods hitherto pursued, nearly 2 per cent of our available supply is gone.

Coal consumption is increasing at an astonishing rate. During the period for which statistics have been gathered, it has doubled during each decade; of late it has more than doubled. In 1907 the production was about 450,000,000 tons. At the present rate of increase the production in 1917 will be 900,000,000 tons, in 1927 1,800,000,000 tons, and in 1937 over 3,500,000,000 tons, or an amount in that year alone nearly equal to the production of the 75 years ending in 1895; and with continuation of the wasteful methods of mining, the consumption and destruction together during that one year would equal our total useful production up to the present date. And at that time—which many of us will live to see—more than an eighth of our estimated original supply will have been consumed or destroyed.

All estimates of future consumption and destruction of coal are liable to error; yet making all reasonable allowance, unless there be careful husbanding, or revolutionizing inventions, or some industrial revolution comes which cannot now be foreseen, the greater part of that estimated 2,000,-

000,000,000 tons of coal forming our original heritage will be gone before the end of the next century, say two hundred years hence.

To each generation the ultimate disappearance of coal is of less concern than current prices. With the working out of seams and fields, plants and transportation facilities are removed or abandoned, and other losses are incurred; and the cost of these in the end increases prices. Already this is felt; it is estimated that by reason of the progressive exhaustion of American fields, coal consumers are to-day paying on an average 10 per cent or 15 per cent more than would be necessary if the supply were unlimited—and the advance must continue with each decade as the supply lessens.

Still more wasteful than our process of mining are our methods of consuming coal. Of all the coal burned in the power plants of the country not more than from 5 per cent to 10 per cent of the potential energy is actually used; the remaining 90 per cent to 95 per cent is absorbed in rendering the smaller fraction available in actual work. In direct heating the loss is less, but in electric heating and lighting it is much more—indeed in ordinary electric light plants hardly one-fifth of 1 per cent, one five-hundredth part, of the energy of the coal is actually utilized. There is at present no known remedy for this. These wastes are not increasing; through the development of gas-producers, internal combustion engines, and steam turbines they are constantly decreasing; yet not so rapidly as to affect seriously the estimates of increase in coal consumption. We are not without hope, however, of discoveries that may yet enable man to convert potential into mechanical energy direct, avoiding this fearful waste. If that day ever comes, our coal supply might be considered unending.

The same spirit of recklessness that leads to waste in mining and in the consumption of coal leads to unnecessary risk of human life. During the year 1907 in the United States the killed and wounded in coal mining operations exceeded 9,000. The danger to life and limb in the mines is increasing far more rapidly than production, because gas becomes more abundant and the work of rescue more difficult as the mines extend deeper or farther from the entrance.

When the Republic was started in 1776 little iron was used. Each family was content with a few score pounds in the form of implements, utensils, and weapons, so that the average annual consumption was but a few pounds per capita. In 1907 alone the production of iron ore in the United States was 53,000,000 tons, or more than 1,200 pounds for each man, woman and child of our 88,000,000 population. And the production is steadily increasing.

The latest trustworthy estimates of our present stock of iron ore are: for the Lake Superior district, about 1,500,000,000 tons;

for the Southern district (including Alabama, Georgia, Tennessee, and Virginia), about 2,500,000,000 tons; and for the rest of the United States, 5,000,000,000 to 7,000,000,000 tons—making an aggregate of about 10,000,000,000 tons.

Our highest-grade ore is that of the Lake Superior district, which yields about four-fifths of the current production. In 1905 its yield was over 33,000,000 tons, in 1906 some 38,000,000 tons, and in 1907 nearly 44,000,000 tons; by the end of the present decade it will average 50,000,000 tons or more. Even without further increase, the known supply will be exhausted before 1940. It is true that there are frequent reports of new ore bodies in this district; but on the other hand, the old bodies generally run far below the estimates.

The total production of iron ores in the United States up to 1890 was some 275,000,000 tons; in the next ten years it was nearly 200,000,000; and in the seven years from 1901 to 1907 more than 270,000,000 tons were produced, or nearly as much as the total for the first century of our history. The aggregate production to date, 750,000,000 tons, is about one-thirteenth of the estimated original supply. At the present rate of increase (doubling each decade) the production in 1918 will exceed 100,000,000 tons, by 1928 200,000,000 tons, and by 1938 it will be over 400,000,000 tons—i. e., in that single year, which many of us may expect to see, an amount approximating the entire production in the United States up to the close of last year. By that date about half of the original supply will be gone, and only the lower grades of ore will remain; and all the ore now deemed workable will be used long before the end of the present century.

Compared with Britain or Germany, our only two important competitors in iron and steel, we were until the past few years in much more favorable condition. Britain then was apparently within twenty years of her end as an important steel producer, owing to exhaustion of her ore supplies. Recent discoveries in Northern Sweden have given her a new lease and also benefited Germany, both of which are already drawing part of their supply from the new mines, which are said to be by far the most extensive ever known. The ores are of excellent quality. It is not improbable that ere long we also in the Eastern States shall be compelled to rely upon these deposits for part of our supply.

While both waste and risk of life in the mining and reduction of iron ore are much less relatively than in coal mining, the advances in price due to progressive exhaustion are large. An example is found in Iron Mountain, Missouri, which forty-odd years ago was declared, even by experts, to be inexhaustible; the entire deposit is gone—work abandoned. The additional cost of ore due to progressive exhaustion of the

bodies of ore can hardly be estimated at less than 10 per cent; this is already felt, and must increase as field after field is exhausted.

Next to iron our most useful metal is copper. It was the only metal used effectively by the natives of North America before Columbus landed; and for over three centuries native copper was mined and wrought by white men chiefly in Indian mines and by Indian methods. The mining and reduction of copper ores has grown up within 50 years; and within a dozen years the copper industry has been revolutionized through electrical application. Although production is enormous and increasing apace, it fails to keep up with the demand, which more than in any other commodity is limited by price. If the current price could be reduced 35 per cent the demand would be doubled or tripled; if it could be reduced 50 per cent copper would replace iron for roofing, cornices, piping, and other constructional purposes so as to raise the demand ten-fold, if not more. While the stock of copper in the ground has not been estimated (miners and operators deeming the supply unlimited, just as a generation ago they thought iron inexhaustible), unless the quantity exceeds the indications, it clearly cannot long withstand the demands which would follow any great reduction in price. Unless it does so, the use of copper cannot seriously check the drain upon our iron resources.

Zinc, lead, silver and other ores abound in our rocks, and their production is steadily increasing. Neither the original supplies nor the time they will last have been estimated; it is known only that one mine or district after another has been worked out, or the depths of the workings so increased as to raise the cost to a prohibitive figure and compel abandonment. The current and avoidable waste in mining and reducing these and the copper ores is estimated by experts to average 30 per cent.

As iron and coal are the basis of industrial values, so gold is the basis of commercial values. Tho there is enough gold-bearing mineral in the United States to give us a powerful influence in maintaining parity of gold, the aggregate supply has not been estimated—indeed it cannot be, since nearly all rocks and earths and even the waters contain gold in various quantities, so that production is controlled wholly by the market price. Our production is large and steadily increasing; tho the increase does not quite keep pace with that of such staples as corn, cotton, wheat, sugar, iron, coal, copper, silver, lead, and zinc. Doubtless the duration of the supply will depend solely upon commercial conditions. The waste in mining and reduction has always been large, ranging from 25 per cent to 50 per cent—indeed it is not uncommon for later miners to get their best returns from working the tailings left by their predecessors.

In view of the sobering facts presented, the thoughtful man is forced to realize, first, that our production and consumption of minerals are increasing much more rapidly than our population; and, second, that our methods are so faulty and extravagant that the average waste is very great, and in coal almost as great as the amount consumed. The serious loss of life in the mines is a feature that can no longer be overlooked. Nor can we fail to realize that the most useful minerals will shortly become scarce, and may soon reach prohibitive cost unless steps to lessen waste are taken in the interest of the future.

I have for many years been impressed with the steady depletion of our iron ore supply. It is staggering to learn that our once supposed ample supply of rich ores can hardly outlast the generation now appearing, leaving only the leaner ores for the later years of the century. It is my judgment, as a practical man accustomed to dealing with those material factors on which our national prosperity is based, that it is time to take thought for the morrow. I fully concur in the opinion of the President that the state of our resources raises one of the most serious issues now before the American people, and hope that this National meeting will lead to wise action.

We are nationally in the position of a large family receiving a rich patrimony from thrifty parents deceased intestate; the President may be likened to the eldest son and the Governors to younger brothers, jointly responsible for the minors; the experts assembled may be likened to the family solicitors. Now, the first duty of such a family is to take stock of its patrimony; the next to manage the assets in such manner that none shall be wasted, that all be put to the greatest good of the living and their descendants. Now, we have just begun to take stock of our national patrimony; and it is with the deepest sense of responsibility imposed upon me by the invitation to this meeting, to the Nation and to coming generations of all time, that I speak as one of the junior solicitors. In my opinion we should watch closely all the assets and begin both to save and to use them more wisely.

Let us begin with iron: We must in all possible ways lessen the demands upon it, for it is with iron ore we are least adequately provided. One of the chief uses of this metal is connected with transportation, mainly by rail. Moving 1,000 tons of heavy freight by rail requires an 80-ton locomotive and twenty-five 20-ton steel cars (each of 40-ton capacity), or 580 tons of iron and steel, with an average of, say, ten miles of double track (with 90-pound rails), or 317 tons additional; so that, including switches, frogs, fish-plates, spikes, and other incidentals, the carrier requires the use of an equal weight of metal. The same freight may be moved by water by means of 100 to 250 tons of metal, so that the substitution

of water-carriage for rail-carriage would reduce the consumption of iron by three-fourths to seven-eighths in this department. At the same time the consumption of coal for motive power would be reduced 50 per cent to 75 per cent, with a corresponding reduction in the coal required for smelting. No single step open to us to-day would do more to check the drain on iron and coal than the substitution of water-carriage for rail-carriage wherever practicable, and the careful adjustment of the one to the other throughout the country.

The next great use of iron is in construction, especially of buildings and bridges. Fortunately the use of concrete, simple and reinforced, is already reducing the consumption of structural steel. The materials for cement and concrete abound in every part of the country; and while the arts of making and using them are still in their infancy, the products promise to become superior to steel and stone in strength, durability, convenience, and economy of use. The cement industry is growing rapidly, largely in connection with the making of iron and steel so that the substitution of the new material will not involve abandonment of plants or loss of invested capital. The hitherto useless slag hills, of which many may be seen around blast furnaces, are now being made directly into cement and yielding high profits. It has become a by-product, the extra cost scarcely more than the former cost of piling the slag away.

A large current use of steel of the highest quality is for battleships, ordnance, projectiles and small arms. Happily there are signs of an awakening of the public conscience and of the sense of national righteousness, whereby civilized nations must be led to adopt those moral standards which already regulate individual conduct; the world is soon to learn that war is not only too disgracefully inhuman but too wasteful to be tolerated, and this serious drain upon our iron ores will cease.

A promising mode of reducing iron consumption is opening through the development of iron alloys. The making of steel was first an accident, and long a secret "art and mystery;" it was not until after the Republic was founded that steel was recognized as an alloy of iron and carbon, and it was only within the memory of men now present that nickel, silver, zircon, tungsten, and other materials were scientifically alloyed with iron to yield those protean modern steels adapted to an ever-increasing range of uses. And the end is not yet; every expert knows that metal alloying is in its infancy.

Among the most abundant materials of the earth-crust are silica, alumina, and carbon compounds, all with more or less affinity for iron; already the alloying of carbon with iron has revolutionized the industrial world, and of late the alloying of silica with iron (in "ferro-silicon," etc.) gives

promise not only of yielding a superior metal but of permitting reduction of siliceous ores hitherto unworkable, while alumina has been alloyed with iron in a useful way. It is not too much to hope that research into the ultimate constitution and relation of these commoner materials will yield both better and cheaper metals than any thus far produced, and that newly discovered alloys will help to relieve the pressure on our mines of iron, copper, zinc, silver, and lead.

We now come to coal. How shall we save that? Current uses—or rather current wastes—offer suggestions: The most serious waste arises from imperfect combustion in furnace and firebox. The waste of 90 per cent and over of the potential energy of the fuel in power-production—which, however, we know not yet how to avoid—is appalling in itself, while the smoke and soot from the chimneys becloud and befoul cities, poison human lungs and prepare the way for pneumonia (one of our worst modern scourges), and initiate all manner of additional wastes. We have already learned that internal-combustion engines and gas-producers double or triple the power per unit of coal, obviate the smoke nuisance and also permit the use of lignite, culm, slack, and inferior coals—in fact, so far as power-production by reciprocal engines is concerned, the days of steam seem to be numbered, although development of substitutes is still in its infancy. The consumption of substitutes is still in its infancy. The consumption of coal in smelting is necessarily large; of late the loss is reduced by using the furnace-gases for power, and by making by-products; yet the chief saving must lie in economy in the use of metals. Much of our coke-making is still extravagant; some ovens use the gases, and all should do so without delay—if necessary, under State regulation, since the people have some rights both in the preservation of their heritage and in maintaining the purity of the air they breathe.

Next to imperfect combustion, the chief waste of coal arises in mining. The early colliers saw no value in coal in the ground, any more than early millers saw value in the flow of the stream; to them coal acquired value only by the labor of mining it, just as to the miller the stream acquired value only as head was produced by the labor of building dam and mill. So the coal taken out in the British and German collieries was a sort of treasure trove; that left in the ground was nobody's loss. Likewise in early American mining the coal mined merely yielded a return for labor, and the pillars and slack and poor coal left in the ground were nobody's affair; it was years after mining began before coal lands were thought to have any other value than as wood-lands or farm-lands. Thus the incredibly wasteful methods were natural

enough; if labor could be saved and profits gained by taking out but a third or a half of the richest part of the seam, leaving the rest to be rendered inaccessible by caving, so be it. No one thought of it as improvident. Now that the coal in the ground is recognized as part, and a great part, of the value of coal lands, self-interest impels the operator to take out all he can, and leads the miner to work close to floor and roof. Bad results may sometimes follow, as in the anthracite region, where the entire forest growth has been stripped and both land and streams ruined to timber the mines, and in those terrible accidents when in removing the pillars of coal the miners are buried. Coal mining cries out for expert knowledge whereby the full yield may be obtained without needless risk or loss; and for wise police regulation whereby life may be protected against ignorance and cupidity.

The most promising check on coal consumption is the substitution of other power. Naturalists tell us that coal is a reservoir of solar energy stored up in ages past, and that the same is partly true also of other chemically complex substances, including ores. The sun-motor still runs; its rays render the globe habitable, and may yet be made to produce power by solar engines or may be concentrated in furnaces—as in the Portuguese priest's heliophore at the St. Louis Exposition, with its temperature of 6,000 degrees F., in which a cube of iron evaporated like a snowball in a Bessemer converter. The sun helps to raise the tides, which some day will be harnessed; and still more practically it raises vapor from the sea to fall as rain and supply our mill-streams and rivers, which it is estimated may some day yield over 30,000,000 horsepower—or more than all now produced from fuel by all our engines combined. Dr. Pritchett is responsible for the statement that on a clear day, when well above the horizon, the sun delivers upon each square acre of the earth's surface exposed to its rays the equivalent of 7,500 horsepower, working continuously. Thus, there is abundance of power lying around us, if we only knew how to harness it. It is only within the past decade that electrical transmission has made water-power generally available for driving machinery, for smelting, and for moving trains, and has at the same time created a new market for copper; yet it is a safe forecast that this method of using solar energy (for such water is as the product of sun heat) will soon affect the constantly increasing drain on our coal. And just as the woods and the ores and the mineral fuels have become sources of wealth and power within our memory, so will become the running waters within a few years!

No practical man can study our mineral supplies without seeing that they are melting away under our national growth at a

geometrically increasing rate, and without realizing that unless the loss is checked his descendants must suffer; nor can he consider ways of preserving the supply without realizing the need of wider and deeper knowledge than we now possess. It was not resources alone that gave this country its prosperity, but inventive skill and industrial enterprise applied to its resources. Individually we have been both forehanded and foreminded. Nationally we have been forehanded chiefly by the accident of discovery by John Smith and Walter Raleigh, but nationally we are not yet foreminded. So far as our mineral wealth is concerned, the need of the day is prudent foresight, coupled with ceaseless research in order that new minerals may be discovered, new alloys produced, new compounds of common substances made available, new power-producing devices developed. The most careful inventory of the family patrimony should be made. I plead for economy, that the next generation and the next may be saved from want—but especially I urge research into and mastery over Nature, in order that two blades may be made to grow where one grew before, that the golden grain may be made to replace woody grass, that crude rocks may be made to yield fine metals.

I urge on the Executives here assembled as our greatest need to-day the need for better and more practical knowledge. It was never more true than now that "Knowledge is power." The states have done much, the Federal Government has done much, individual men have done much for research; in the history of this country knowledge has advanced as never before, and thereby the materials and forces of nature have been brought under control as no man dreamed when the Nation was founded. Yet if our career of prosperity is to continue, it must be on the basis of completer control of national sources of material and power than we have thus far exercised, a control to be gained only by research.

In conclusion, Mr. President and Governors of our states, it seems to me our duty is:

First, conservation of forests, for no forests, no long navigable rivers; no rivers, no cheap transportation.

Second, to systematize our water transportation, putting the whole work in the hands of the Reclamation Service, which has already proved itself highly capable by its admirable work. Cheap water transportation for heavy freights brings many advantages and means great saving of our ore supplies. Railroads require much steel, water does not.

Third, conservation of soil. More than a thousand millions of tons of our richest soil are swept into the sea every year, clogging the rivers on its way and filling our harbors. Less soil, less crops; less crops, less commerce, less wealth.

The way is not new: Washington and his compatriots pushed into the unknown in projecting a Nation on new principles. Franklin grasped a hardly known principal-ity through the Geneva Treaty, and Jefferson seized an unexplored half-continent despite protests of those whose knowledge was even less than his own; Fulton, Morse, Henry, Edison and Beil came to stand as kings among men by pushing into the unknown. To-day the time is ripe for a further advance; our President, with far-sighted patriotism, has arisen to lead effort and action. He deserves, and I am sure will receive, your earnest support and that of all citizens who understand the importance of the problems involved.

The authoritative remarks of the great ironmaster elicited prolonged applause at frequent intervals, and when the twenty-minute limitation prevented the completion of his address unanimous consent to an extension of time was instantly given.

Following the address of Mr. Carnegie, Dr. I. C. White, State Geologist of West Virginia, discussed "The Waste of Our Fuel Resources," his paper being given here in full:

A great geologist once said. "The nations that have coal and iron will rule the world." Bountiful nature has dowered the American people with a heritage of both coal and iron richer by far than that of any other political division of the earth.

It was formerly supposed that China would prove the great store-house from which the other nations could draw their supplies of carbon when their own had become exhausted, but the recent studies of a brilliant American geologist in that far-off land, rendered possible by the generosity of the world's greatest philanthropist, tell a different story. The fuel resources of China, great as they undoubtedly are, have been largely over-estimated, and Mr. Willis reports that they will practically all be required by China herself, and that the other nations cannot look to her for this all important element in modern industrial life.

A simple glance at a geological map of the United States, will convince any one that nature has been most lavish to us in fuel resources, for we find a series of great coal deposits extending in well scattered fields almost from the Atlantic to the Pacific, and from the Lakes to the Gulf, while even over much of New England and the coastal plains, vast areas of peat, the primal stage of coal, have been distributed. But coal of every variety from peat to anthracite is not all of nature's fuel gifts to fortunate America. Great deposits of both petroleum and natural gas occur in nearly

every state where coal exists, and in some that have no coal. What greater dowry of fuels could we ask when we find them stored for us within the bosom of our mother earth in all three of the great types, coal, petroleum and natural gas, only awaiting the tap of the pick and drill to bring them forth in prodigal abundance?

What account can we as a Nation give of our stewardship of such vast fuel treasures? Have we carefully conserved them, using only what was necessary in our domestic and industrial life, and transmitting the remainder, like prudent husbandmen, unimpaired to succeeding generations? Or have we greatly depleted this priceless heritage of power, and comfort, and source of world-wide influence, by criminal waste and wanton destruction? The answer should bring a blush of shame to every patriotic American, for not content with destroying our magnificent forests, the only fuel and supply of carbon known to our fore-fathers, we are with ruthless hands and regardless of the future applying both torch and dynamite to the vastly greater resources of this precious carbon which provident nature had stored for our use in the buried forests of the distant past. The wildest anarchists determined to destroy and overturn the foundations of government could not act in a more irrational and thoughtless manner than have our people in permitting such fearful destruction of the very sources of our power and greatness. Let me enumerate some of the details of this awful waste of our fuel resources that has been going on with ever increasing speed for the last 40 years.

First let us consider how we have wasted natural gas, the purest form of fuel, ideal in every respect, self-transporting, only awaiting the turning of a key to deliver to our homes and factories, heat and light and power. Partial nature has apparently denied this great boom to many other lands. It is practically unknown in France, Germany and Great Britain, our chief competitors in the world of industry. Even wood and coal must first be converted into gas before they will burn, but here is a fuel of which nature has given us a practical monopoly, lavish in abundance, already transmuted into the gaseous stage and stored under vast pressure to be released wherever wanted at our bidding. The record of waste of this our best and purest fuel is a national disgrace.

At this very minute this unrivaled fuel is passing into the air within our domain from uncontrolled gas wells, from oil wells, from giant flambeaus, from leaking pipe lines and the many other methods of waste at the rate of not less than one billion cubic feet daily and probably much more.

Very few appear to realize either the great importance of this hydro-carbon fuel resource of our country, or its vast original quantity. Some of the individual wells, if we may credit the measurements, have pro-

duced this fuel at the rate of 70 million cubic feet daily, the equivalent in heating value of 70,000 bushels of coal, or nearly 12,000 barrels of oil. In my humble opinion the original amount of this volatile fuel in the United States, permeating as it does every undisturbed geologic formation from the oldest to the most recent, rivaled or even exceeded in heating value, all of our wondrous stores of coal.

Suppose that it were possible for some Nero, inspired by a mania of incendiarism, to apply a consuming torch to every bed of coal that crops to the surface from the Atlantic to the Pacific, and that the entire coal supply of the Union was threatened with destruction within a very few years, what do you think would happen? Would our State Legislatures sit undisturbed panoplied by such a carnival of fire? Would the Governors of 30 States remain silent while the demon of flame was ravaging the coal resources of the Republic? Certainly not; there would be a united effort by the Governors and Legislatures of all the States in the Union to stay the progress of such a direful conflagration; even the sacred Constitutional barriers wisely erected between State and Federal authority would melt away in the presence of such an awful calamity, and the mighty arm of the Nation would be invoked to help end the common peril to every interest. And yet this imaginary case is an *actual one* with the best and purest fuel of the country, equal probably in quantity and value for heat, light and power to all of our coal resources. This blazing zone of destruction extends in a broad band from the Lakes to the Gulf, and westward to the Pacific, embracing in its flaming pathway the most precious fuel possessions of a continent. No one can even approximate the extent of this waste. From personal knowledge of conditions which exist in every oil and gas field, I am sure the quantity will amount to not less than one billion cubic feet daily, and it may be much more. The heating value of a billion cubic feet of natural gas is roughly equivalent to that of one million bushels of coal. What an appalling record to transmit to posterity!

From one well in eastern Kentucky there poured a stream of gas for a period of 20 years without any attempt to shut it in or utilize it, the output of which, it has been figured, was worth at current prices more than three million dollars. Practically the same conditions characterized the first 25 years of Pennsylvania's oil and gas history, and the quantity of wasted gas from thousands of oil and gas wells in western Pennsylvania is beyond computation. In my own state of West Virginia, only eight years ago, not less than 500 million cubic feet of this precious gas was daily escaping into the air from two counties alone, practically all of which was easily preventable, by a moderate expenditure for additional casing. When it is remembered that one thousand cubic feet of natural gas weighs

48 pounds, and that 6,000 cubic feet of it would yield a 42-gallon barrel of oil when condensed, so that a well flowing 6,000,000 feet of gas is pouring into the air daily the equivalent of 1,000 barrels of oil, what would our petroleum kings think, if they could see this river of oil (for the equivalent of a billion feet of gas is more than 160,000 barrels of petroleum, and of practically the same chemical composition as benzine, or gasolene) rushing unhindered to the sea? Would they not spend millions to check such a frightful waste of this golden fluid? And would they not be the first to appeal to the national government for aid in ending such great destruction of property? And yet because natural gas is invisible, and its waste is not so apparent to the eye as a stream of oil, or a burning coal mine, the agents of these oil magnates have not only permitted this destruction of the nation's fuel resources to continue, but they have prevented by every means in their power the enactment of any legislation to stop this frightful loss of the best and purest fuel that nature has given to man.

There can be no doubt that for every barrel of oil taken from the earth there have been wasted more than ten times its equivalent in either heating power, or weight even, of this the best of all the fuels, and also that much more than half of this frightful waste could have been avoided by proper care in oil production and slight additional expenditures.

In justice to the great oil-producing corporations, it must be acknowledged that they have not permitted much waste of petroleum except what has been sprayed into the air by their awful waste of gas, and also that their handling of petroleum has been from the beginning a model of business economy and management. The great mistake of the oil producing interests has been in not properly apprehending the enormous fuel value of the natural gas they were destroying, and in not demanding legislation for its protection instead of successfully throttling and preventing it in every state of the Union except one—Indiana. When the people of that great state awoke to the fact that their richest mineral possession was being rapidly wasted, they rose to the occasion, and although it was largely a case of "locking the stable door after the horse had been stolen," they effectually prevented any further useless waste of natural gas. This Indiana statute which has been declared constitutional by our highest courts, says in effect to the oil producers—"You cannot take the oil from the ground where nature has safely stored it, until you provide a method of utilizing the accompanying gas, or volatile oil as well," and it also says to both the producer and consumer of natural gas, that it is against "public policy to waste this valuable fuel and that it will not be permitted to either party." This Indiana statute for the conservation of petroleum and natural gas should be enacted into law in every

state where this precious fuel exists; and why has it not been done? Let the answer be found in the history of my state, where the waste of natural gas has been exceeded only by that of our sister state of Pennsylvania.

For ten years your speaker has appealed in his official capacity as State Geologist to the Legislature of West Virginia to put some check upon this frightful waste of our State's most valuable resource. Three patriotic Governors, including our present able executive, Governor Dawson, have in every biennial message besought the Legislative branch to end this criminal destruction by appropriate legislation, but some unseen power greater than Governors or Legislatures has so far thwarted and palssied every effort to save the state and the Nation this priceless heritage of fuel, so that although five successive Legislatures have attempted to deal with the question in biennial sessions not an effective line has yet been added to the statutes, and at this very hour not less than 250 million cubic feet of gas, and possibly more than double that quantity, is daily being wasted in this one state alone, 80 per cent of which is easily and cheaply preventable.

Why should a few oil producers in their insane haste to get rich quickly, or add to fortunes already swollen beyond safety to the Republic be permitted thus to despoil the entire country of its choicest fuel?

But surely if men have thus permitted the loss of our gaseous fuels, often because they could neither see the substance itself nor realize the extent of what they were doing, certainly they would not be so wasteful of the solid fuels, the coal beds, something they can readily perceive and handle and weigh. The record here is also one to make every citizen of our Nation feel distressed and humiliated, for of the total quantity of coal we have produced since mining for commercial purposes began, amounting to about five billion tons, at least an equal amount and possibly more, has been left in abandoned mines, and irretrievably lost. You who are unacquainted with the details of mining operations, and of the structure of coal beds, will doubtless wonder how such a vast loss of fuel could take place. There are many causes for the existence of this enormous waste in the extraction of coal. Let me enumerate a few of them.

First: The individual coal bed is not all pure coal and this is especially true if it be very thick. Some of it consists of layers of sulphurous or bony coal, rich in carbon, it is true, but containing more ash, sulphur, or earthy material than first-class coal should hold; hence the purchaser objects, and refuses his patronage to the party who sends him coal that is high in ash. There being no market for such coals, the operator leaves this kind of fuel unmined if it be in either the roof or bottom of his coal bed, and if it be interstratified with the pure coal, as it frequently is, he simply

throws it along with other mine refuse into the gob heaps within the mine, or piles it in the hillocks of culm containing shale, clay, and other waste material at the entrance.

The quantity of this impure coal varies from 10 to 50 per cent in nearly every coal bed, and it would possibly average 25 per cent in all the mines of the country. This material is rich in carbon, both fixed and volatile, and when utilized through the agency of producer gas, and the gas engine, will yield much more power than the same weight of the best Cardiff or Pocahontas coal when the steam engine is the agency of conversion. Why should our great manufacturing companies permit one-fourth of our entire coal resources to be thus wasted and permanently lost, when the researches of the Technical Branch of the United States Geological Survey have fully demonstrated the practicability of converting these impure coals into great sources of power? If in all new installations provision were made for the use of gas engines, a large portion of these impure coals could be utilized, and our purer types of fuel preserved for other purposes.

Second: In the mining of coal it is necessary to support the overlying strata over large areas of the mine in order that the coal may be even partially taken out, and hence it is the common mining practice temporarily to utilize about 50 per cent of the solid coal itself, in the shape of supporting pillars for the protection of roadways, air courses, working rooms, etc. On account of accidents, like falling roof rock, "squeezes," "creeps," "crushes," mistakes in mine engineering, bad roof, and other causes, many of these huge pillars are frequently submerged and surrounded with broken rock material, and thus another large portion of every coal bed, the quantity varying from 10 to 50 per cent, is utterly lost, so that approximately 25 per cent more of the nation's coal resources is wasted from these, largely preventable causes.

With 50 per cent of our coal left in the abandoned mines, from which it can never be recovered, except at enormous expense, one would think that the end had come to wanton destruction of our coal resources, but not so.

A third means and one of unknown extent has yet to be considered. Some of the impure layers of coal may have a still larger percentage of earthy matter, and then they become partings of shale, the fossil muds and soils borne into and spread over the ancient peat bogs by the draining streams of geologic time. These partings vary in thickness from a few inches to several feet. When thin, and not exceeding 6 to 12 inches, the usual mining practice is to take them out and secure the coal, but where they attain a thickness of 18 to 24 inches their removal entails too much expense for the production of bituminous coal under present commercial conditions, and hence the parting is not removed and

the underlying or overlying coal, as the case may be, is left in the mine, usually in such a condition as to be practically irrecoverable. These parting shales often occur near the middle of the coal seam, and thus one-half of the bed will remain buried in mine rubbish, with no possibility of ever securing its precious fuel. Very much akin to this is another kind of waste about which we as yet cannot even approximate the extent. It is well known that in very rich coal fields several (3 to 10) beds may overlie each other in the same mountain, separated by from five to 200 feet of rock material. It often happens that the thickest and best of the beds may underlie all the others, and hence will be the first one mined, regardless of the fact that when the overlying strata break down, some and possibly several of the higher coal beds will be so dislocated and disturbed and their areas so permeated with deadly gases from the abandoned mines below that much of this higher coal will be lost. Just how much no one yet knows, but it is feared that the fuel waste from this source will prove large. Of course nearly all this loss could be prevented by mining the higher beds first. Another deadly peril to deep coal mining is an incident of oil and gas production. Many thousands of holes have been drilled through the coal measures to reach the productive oil and gas zones below. Very many of them have found only natural gas, and unless the well was very large or a profitable market near at hand, the casing has been drawn and the well abandoned. It is greatly feared that, in such cases, another great menace will be added to the coal mining industry, since these abandoned oil and gas wells, which penetrate the coal measures, are numbered by the thousand, and no accurate public charts of the same have ever been kept.

The same story of waste of fuel comes from every mining center. The experts of the United States Geological Survey report the quantity of fuel left unmined in the ground all the way from 40 to 70 per cent of the total deposits. I shall not worry you with details from all over the country, but shall illustrate the rapid exhaustion of our fields by special reference to one great district with which many of you are personally familiar.

The mining of bituminous coal, and the manufacturing industries dependent thereon, originated at Pittsburg only about a century ago, and her citizens, as well as all others, may learn a useful lesson by recalling the history of this beginning. The earliest settlers found there cropping high in the steep hills which border the Monongahela River a thick bed of splendid coal. As roadways could not be constructed to the inaccessible cliffs where the coal was first discovered, some other method of securing it was necessary.

At that time the American bison, or buffalo, roamed the vast plains of the middle West in countless millions, and these ani-

mals were so abundant even in the Pittsburg region that their skins were used for conveying the coal from the mines to the factories in the deep valley below, a few bushels of coal being sewed up in each hide and then rolled down the steep slopes. To our forefathers the supply of buffalo appeared "inexhaustible," and yet less than a century of wanton slaughter has practically exterminated this noble animal. This passing of the buffalo illustrates in a striking way what will just as surely happen to vast areas of our fuel resources, great as they are, even within the limits of the present century, unless our people awaken to what they are doing and make a determined effort to stop their destruction. The people generally have been so often told of their "inexhaustible" supplies of fuel that its waste has not impressed them as a problem worthy of serious thought. They have generally believed that its exhaustion was so remote that its consideration even concerned the present only in an academic way. Let us see about that. We shall take for our illustration the Appalachian coal field, which is conceded by all to be the richest in fuel of any on the continent. It is also the most important to the welfare of the country, since it is nearest the seaboard and contains the vast bulk of our good coking coals upon which our pre-eminence in the iron and steel industry depends. With the exception of a few narrow strips close to regions of rock disturbance or folding in our Western country, no first-class coking coals have yet been discovered in the United States outside of this Appalachian Basin.

It has long been recognized by all that the Pittsburg district is located in the heart of the Appalachian field, where fuel of every description is most abundant and most accessible. You will pardon a personal reminiscence which illustrates how an eminent political economist regarded this favored region. It was my good fortune to accompany the lamented Blaine, one of the greatest statesmen that America has ever produced, up the beautiful Monongahela River the last time that he visited his boyhood's home, 20 years ago. He had acquired 1,100 acres of Pittsburg coal lands in the vicinity of Elizabeth, about 22 miles above Pittsburg, and the party stopped there a few hours to permit Mr. Blaine to examine his property, which he termed his "savings bank," since he had acquired it by the occasional purchase of small farms during a period of several years. Being curious to know why he had made an investment of this kind, so far removed from his home in Maine, I asked him how it happened. His reply impressed me deeply because it contained a prophecy. He said that cheap fuel was the most important element in the life of nations, and that in looking the country over he had concluded that there was more of it easily accessible to the Pittsburg region than in any other portion of the country, and hence the Pittsburg district would sometime become the man-

ufacturing center of the world, and therefore that investments in its coal fields could not fail to prove remunerative. The prophecy of that far-seeing statesman was fulfilled much sooner than even he expected, since Pittsburg has certainly held first place among the workshops of the world for the last ten years. It is not generally known that the tonnage originating in the Pittsburg district and passing through it now exceeds that of the four greatest seaport cities of the world, London, New York, Liverpool, and Hamburg combined, so that not only Pennsylvania but every State in the Nation is interested in perpetuating as long as possible this empire of industry which our wonderful natural resources and the genius of the American people have conquered. How long can we hope to maintain this industrial supremacy in the iron and steel business of the world? Just so long as the Appalachian coal field shall continue to furnish cheap fuel and no longer. If the wasteful methods of the past are to continue; if the flames of 35,000 coke ovens are to continue to make the sky lurid within sight of the city of Pittsburg, consuming with frightful speed one-third of the power and half of the values locked up in her priceless supplies of coking coal, the present century will see the termination of this supremacy. Many of you may not credit this statement, so let us do some figuring on the matter as an aid in forecasting the future. All will admit that no portion of the Appalachian field is richer in fuel resources than the Pittsburg district, and if we can estimate approximately how long its fuel will last we will have gauged, in a rough way, the productive life of the Appalachian field.

The Pittsburg Coal Company owned on January 1, 1908, according to its recent annual report, 143,000 acres of the Pittsburg coal bed, or practically one-seventh of the entire acreage of this famous seam remaining yet unmined in Pennsylvania. During the year it exhausted 2,241 acres, obtaining therefrom for all purposes 18,000,000 tons of coal, or an average of 8,000 tons to the acre, leaving in the ground about 5,000 tons per acre of waste and unmined coal. Hence this average of 8,000 tons may be taken as a measure of the total amount of first-class fuel that will be won under present mining methods from each acre of Pittsburg coal yet remaining unmined in the Pittsburg district.

In 1906 Pennsylvania produced 109 million tons of bituminous coal, 84 millions of which came from the five counties of Allegheny, Fayette, Greene, Washington and Westmoreland, which hold practically all of Pennsylvania's Pittsburg coal area. In 1907 Pennsylvania produced 129 million tons of bituminous coal, and in the absence of exact statistics it is safe to say that at least 100 million tons of this product came from the five counties in question, and not less than 95 million tons of it from the Pittsburg seam.

There remains unmined in Pennsylvania only eleven hundred thousand acres of this great coal bed or a total available product of eighty-eight hundred million tons of coal, measured by the quantity (8,000 tons per acre), obtained by the best mining methods of a great corporation during 1907. Eighty-eight hundred million divided by 95 million yields a quotient of only 93 as the number of years this fuel in the Pittsburg seam will last if the present annual production should not be increased by a single ton. But who is there to say that it will not be doubled even within the next decade?

The West Virginia productive area of this great bed is only about the same as that of Pennsylvania, so that this contiguous region can add only a few years to the life of the Pittsburg coal production.

It may be replied that the Allegheny series of coals which underlie the Pittsburg bed may add greatly to the fuel resources of the Pittsburg district. This is an error, as the coals in the Allegheny and Conemaugh series appear to thin away and disappear as commercial propositions when they pass beneath the principal areas of the Pittsburg coal, while the active demand for coal at the seaboard will exhaust all of the productive areas of these lower and thinner coals with our present wasteful mining methods, even before the Pittsburg bed fails.

The productive coal area of the Appalachian basin has been greatly over-estimated in every one of the six great states through which it passes from Pennsylvania to Alabama. The drill of the seeker for petroleum and natural gas, while it has wasted untold millions of precious fuel, has taught one useful lesson, viz: that there is a wide area, 50 to 75 miles in breadth deep down in the center of the Appalachian basin, that is practically barren of commercial coal. This barren region begins with the lower measures just north from Pittsburg, and embracing large portions of the former supposed coal fields of both Ohio and West Virginia, passes southwestward into Kentucky, having a breadth of 25 miles where it enters that state.

To what extent the productive area of Kentucky, Tennessee, and Alabama will be affected by the southward extension of this barren belt, which has already cut the former estimates of Pennsylvania, Ohio, and West Virginia in half, we do not yet know, but certain it is that all the great coal formations, instead of holding productive coal entirely across this basin, as formerly supposed, are productive only as fringes 20 to 30 miles in breadth around the borders of the basin, while the great central trough is practically destitute of valuable coal. Hence, with only a reasonable estimate for increased coal production, if the present wasteful mining methods continue, there will be but little coal for manufacturing purposes within 100 miles of Pittsburg at

the opening of the next century, and practically no cheap fuel left in the entire Appalachian basin with which to maintain our supremacy in the iron and steel trade of the world.

The prospect is not a pleasing one to contemplate. That celebrated word picture of Lord Macaulay in which he describes a future traveler as standing on a broken arch of London bridge, in the midst of a vast solitude, sketching the ruins of St. Paul's, may find its substantial counterpart much nearer home than we could wish. True, the natural wealth of our beloved Union is so great and varied; our riches of soil, of forest, and stream are so vast, if preserved, and their boundless possibilities thoroughly utilized, that we would probably have the advantage of all other nations in the struggle for existence even after our fuel resources have been exhausted; but this is no reason why we should not do everything possible to conserve them so that we may retain, to a remote future, the great benefits which their possession assures.

Honorable Governors of the several states, the questions involved in this discussion are those in which you and your constituents are most vitally interested. Our patriotic President, ever watchful of the Nation's welfare, and of the people's interests, ever alert to guard against dangers from without, or the more insidious foes that would betray the people's liberties from within, has summoned you to a conference more important to the future of our great Republic than any council that has ever before met in the history of our country. Our honored President would protect this Nation not alone from perils on the ocean, but from the graver ones on land. The dangers that confront us on the Pacific as well as upon the Atlantic are serious and of far-reaching importance to the future of our country, and the people's President, under whose wise administration there is happily no North, no South, no East, no West; to whom in his official capacity the rights of all citizens, whether rich or poor, white or black, look alike, will be sustained by a united country in the request which he has made of Congress to provide "big sticks" in the shape of an adequate navy for both oceans as the surest and best guarantee of either peace or respect from the other nations of the earth. But the dangers that confront the great Republic from abroad are as nothing compared to the perils that lurk in the shadows at home. What will it profit this Nation to have won the wreath of industrial supremacy if in our thirst for gold and sudden riches we permit corporate greed, as well as individual avarice and selfishness, to waste and devastate the very sources of our prosperity? For just as sure as the sun shines, and the sum of two and two is four, unless this insane riot of destruction and waste of our fuel resources, which has characterized the past

century, shall be speedily ended, our industrial power and supremacy will, after a meteor-like existence, revert before the close of the present century to those nations that conserve and prize at their proper value their priceless treasures of carbon.

Whatever is possible in the shape of legislation for the protection of our fuel resources should be done by the individual states which you represent. Twenty-nine of the 46 states of the Union produce coal, and 24 of these produce more than a million tons annually, while practically the same number produce vast quantities of both petroleum and natural gas. The percentage of coal left in the ground beyond recovery, as we have seen, varies from 40 to 70 in the different fields, to say nothing of the wasteful and extravagant use of the portion extracted, while the waste of natural gas, the most precious fuel of all, is so vast that no one can even approximate the percentage. The task before you and your constituencies is indeed formidable. The forces of greed and selfishness are so entrenched behind corporate power and influence that to attack them may often appear to you as useless as the labors of Sisyphus. But as you love your states and country, I adjure you to take up this fight for the conservation of our fuel resources, with the determination never to surrender until the forces of greed and avarice, which are so rapidly sapping the very foundations of our country's greatness, capitulate and agree to end the wild riot of destruction that has characterized the past.

Mr. President, I greatly regret that the part assigned me in this discussion has led along such unpleasant lines. The story of the awful waste of our most valuable natural resources is one of such a disgraceful character that its exposition to the world is necessarily mortifying to all patriotic Americans; but a sense of duty to our common country compels that the truth be told, however humiliating to our national pride.

This conference will not have met in vain if it shall result in awakening public sentiment to the peril which overshadows the Republic in this uncontrolled waste and dissipation of our fuel resources. These eminent Governors, whom you have summoned to hear this narrative of rapine and devastation, to many of whom the story is new and almost unbelievable, owe you a debt of gratitude which they can only adequately repay by arousing the citizens in their respective states to such a realization of the gravity of the dangers which follow in the wake of unbridled waste that whatever is possible for legislation may be speedily enacted into law. Forewarned is forearmed, and this conference, which has brought together so many influential citizens from every state in the Union, should not fail to be productive of untold good to the Nation's future.

General discussion of Mr. White's paper was opened by Mr. John Mitchell, for years, and until last January, president of the United Mine Workers of America. Mr. Mitchell has long been known as an eloquent and forcible speaker and writer upon matters connected with coal, mining operations, and mineral fuel supplies, and his brief paper was the statement of a man who has during his life been in actual, close touch with all sides of this most important question.

Mr. Mitchell took issue with those experts who state that one-half the coal of our mines is lost through wasteful or unscientific mining operations. He stated, however, that his personal observation led him to believe that fully twenty-five per cent of the coal was so wasted beyond recovery—through difficult physical characteristics of some of the formations, through pillaring the workings with solid coal for the support of the roofs of tunnels and other workings, through cave-ins, and through the shunning of veins of low-grade coal. Mines operated under any of these faulty conditions, he stated, were, when worked out, left to cave in, and thus the coal remaining in them was permanently lost.

He stated that large coal consuming corporations in America pay about a dollar a ton, at the mines, for their coal supplies, while like corporations in other countries are forced to pay from \$2 to \$3 per ton for their fuel supplies. He said that, while it is vitally important to our industrial well being that large manufacturing concerns be furnished their coal supply at a cost sufficiently low to enable them to compete with manufacturers in other countries, still, in view of the tremendous waste of energy that accompanies the use of cheap fuel, the conclusion is inevitable that this very cheapness is as extravagance, and not an economy. Illustrating this point, he stated that the cheapness of fuel led to improper firing and the use of imperfect furnaces, the result being that three tons of coal are consumed

in creating the power that under proper conditions would be generated by a single ton.

Touching on the shocking loss of life that accompanies coal mining operations in the United States, Mr. Mitchell stated that for every 100,000 tons of coal produced in this country one mine worker is killed and several are injured. Last year, he said, 2,500 coal miners were killed and more than 6,000 were seriously injured in the coal mines of the United States; and he stated that in the foreign countries, where mining is most hazardous, the proportion of those killed to those employed in the mines is from fifty to seventy-five per cent less than in the United States. In conclusion Mr. Mitchell said:

"In our mad rush for spoils and profits we not only waste and destroy those material resources with which God has so bountifully endowed us, but we press forward in the race, sacrificing, unnecessarily, the lives and the comfort of our fellow beings. It seems to me that the time has come when we should stop for a moment and think—not alone of those inanimate things that make for comfort and prosperity, but also of the men, and the women, and the children, whose toil and deprivation have made and will continue to make our country and our people the most progressive and the most intelligent of all the nations and of all the peoples of the earth."

At the conclusion of Mr. Mitchell's talk, Governor John A. Johnson, of Minnesota, who had arisen to make a motion, was urged to the platform, and his extemporaneous talk was listened to with deep interest, outbursts of vigorous applause punctuating his speech at frequent intervals.

Governor Johnson announced that his real purpose in arising was to ask the Conference to listen to Dr. Charles R. Van Hise; but the Conference was not minded to let the Minnesotan off without a speech after he had arisen. Governor Johnson said:

"I have been very seriously impressed in the few hours during which we have been together. It seems to me that if all that has been said is fact, and I assume it to be fact, that the sun of American prosperity has reached the zenith, and that the shad-

ows are beginning to find their places on the other side of the hill. When I realize that this is going to make no particular difference to us of this generation, the great patriotic duty devolves upon us, and upon the people of the country as a whole, to do that which is going to work out some solution of the various problems for the future, whether it be one hundred or two hundred years hence."

Referring to Mr. Carnegie's statement in regard to the approaching exhaustion of iron ore beds, Governor Johnson said:

"I am rather inclined to contradict some of the statements that have been made, if I might be permitted to do so. I am rather a stranger in the realm of iron to contradict any opinion Mr. Carnegie may have. Certainly he ought to know as much on this subject as any other man in the country, except, possibly, Mr. Hill, who I am sure will be glad to take issue with him on certain things. * * * I think some eight or ten years ago Mr. Schwab, who was connected with all of the companies in which Mr. Carnegie was interested, said on the stand that there was something like a billion tons of ore in the Mesaba region. Mr. Carnegie says it is a billion and a half tons. I am sure that if there has been a growth of half a billion tons in eight or ten years, there is little necessity for conservation of that natural resource." (Laughter and applause.)

"In the long run the problem with us is going to be—is even now—an engineering problem. If you will notice on the map, the Father of Waters, the Mississippi, runs almost to the very outer western edge of Lake Superior. The Government has paid out sixty-odd millions of dollars to improve Superior, Huron and the other Great Lakes. I think less than seventy millions of dollars have been invested there, and with this expenditure the Government's engineers have made out of the lake system the greatest commercial waterway in the world. There is nothing like it. Now, if seventy millions of dollars will make out of the lakes such a commercial waterway, what would a few millions, intelligently used, amount to if Lake Michigan, from its southern extremity, were canalized into the Mississippi; if Lake Superior were canalized into the upper portion of the Mississippi, and if the Mississippi were improved? We would be given such a power of distribution as we have never had, and with us this is, after all, the great problem. It seems there are two problems here—not only the conservation of our natural resources, but the development of our industries—and one is just as important as the other. I do not believe the American people want to lock up the iron mines; I do not think they want to lock up the industries of the Middle West or of the country. I believe that what they want is the true, scientific development of all of these resources and indus-

tries; and with such development the future will come pretty near taking care of itself."

Governor Johnson then asked the Conference to listen to Dr. Van Hise, president of the National Association of Universities, and for many years connected with the United States Geological Survey. Dr. Van Hise said:

According to Dr. C. K. Leith the known iron ore resources of the Lake Superior region are about 1,900,000,000 long tons, bearing fifty per cent or more metallic iron. According to Dr. E. C. Eckel the known iron ore reserves of the Southern Appalachians are 2,500,000,000 long tons, bearing thirty-three per cent to fifty per cent metallic iron. Taking into account the difference in metallic content, the amount of iron in the known high grade ores is about the same in each of the two regions. While these two regions contain the great known reserves of iron ore in the United States, the known reserves of the central and eastern states are not unimportant. Also the known reserves of the western states are large, although not to be compared with those of the Lake Superior region or the South.

While the amount of iron ore which has been mined in the United States has been rapidly decreasing during the past twenty-five years, rising from 8,400,000 long tons in 1883 to 48,907,900 long tons for 1907, the discovery of new deposits has gone on at even a more rapid rate, so that it is certain; that for the Lake Superior and the Southern Appalachian regions, together as well as separately, more iron ore is now known to exist than at any previous time in the history of the country.

If the grade of what is called iron ore for the Lake Superior region should be dropped from fifty per cent to forty per cent—and some material is already mined which runs between these figures—the amount of reserves would be enormously increased. But no quantitative statement can be made at the present time in reference to additions which would be thus available.

Also, in the Southern Appalachians, Eckel estimates that the probable amount of iron ore which will become known in the future by deep mining—that is, below the thousand foot level—especially if the percentage of metallic iron be somewhat lowered, will greatly exceed the present known reserves. Indeed, he suggests that future development along this line may amount to three times as much as the present estimated reserves, or 7,500,000,000 tons. This forecast may be too sanguine, and is admittedly more or less conjectural. However, it can hardly be doubted that the quantity of iron ore to become known in the future in the south is enormous.

In considering the material available to the United States we should take account of the supplies in adjacent countries. Mexico is as yet very imperfectly explored. In Canada there are vast areas of wholly unexplored territory. In Cuba, examinations made by Spencer show that the known reserves of iron ore of fair metallic content are very large, and some of the more extensive of these deposits are already controlled by United States capital. Of the South American iron ore resources we are as yet very imperfectly informed.

While the additions to the known reserves of iron ore available to the United States, which are to be made by discoveries in the western United States, in Canada, in Mexico, in Cuba, and in South America, are uncertain, it is hardly possible that the amount will not be very important; but as yet there is no reason to suppose that discoveries in any of these countries, with the possible exception of Cuba, will reveal iron ore deposits comparable in importance to the Lake Superior and the Southern Appalachian districts.

From the foregoing facts it appears probable that for some years to come iron ore available in the United States will continue to be discovered more rapidly than it is exploited, and consequently the total known reserves will increase rather than decrease. Hence the crest for known iron ore reserves of high grade may therefore be some years in the future.

While, therefore, it is safe to say that the available high grade iron ore will be adequate for possibly a century, even if the rate of production further greatly increases, it is to be remembered that as the percentage of iron ore goes down a larger amount of coal is required to obtain a ton of metallic iron, and, therefore, in proportion as our rich ores are exhausted, the draft will become steadily heavier upon the most important of the underground resources—fuel.

Turning now to another metal, copper, so far as I know there has been no systematic attempt to estimate the copper reserves, but it is safe to say that the known reserves of high grade copper are at the present time very much less than they were some years ago. It is true that the copper product of the United States, as well as that of the world, has steadily increased for many years until 1906, when maxima of 410,000 long tons for the United States and 705,000 long tons for the world were reached. The year 1907 shows a falling off from these figures of between 9,000 and 10,000 tons for the United States and between 7,000 and 8,000 for the world. Whether this check is temporary is uncertain, but it suggests that if we have not already reached the crest of production for copper we are nearing it. Indeed the rapid annual increase in the output of copper for the past dozen years has only been accomplished by the exploitation

of increasingly lower grade ores. At the present time it is clear that the crest of known reserves of high grade copper ore has been passed. However, as in the case of iron, the extent of the low grade materials is very imperfectly known, and in the future for a time the output may remain as great as in the past, provided sufficiently low grade ores be worked. But with reference to copper, as with reference to iron, it is to be remembered that the lower the grade of ore the more it costs to produce a pound of metal, and therefore that, as the grade of the ore decreases, the price of the copper must rise. Those who are familiar with the situation know that in any of the great camps, upon the average, it costs more to make a pound of copper than it did a few years ago.

For lead and zinc, gold and silver, it is not possible to make statements even as definite as those concerning copper. These metals are usually developed in the mines only to a limited degree in advance of their exploitation. Therefore there never have been at any one time in many years reserves of the ores of lead and zinc, of gold and silver in sight. There are no great known reserves for those metals in the sense that reserves are known for iron ore. However, exploration and exploitation have gone on together with the result that there has been a steadily increasing output of these metals both for the United States and for the world. Indeed the increase for the last twenty-five years has been remarkable. The percentages of increase for 1907, as compared with 1883, twenty-five years previously, are as follows:

For lead, 150 per cent; for zinc, 537 per cent; for gold, 62.9 per cent; for silver, 21.8 per cent.

Apparently the maximum output for none of these metals has been reached, with the exception of silver, which with the United States has been nearly horizontal for about fifteen years, and for the world has somewhat declined for the last half dozen years, as compared with the previous period of the same length. How long we may expect an increase in the output of lead, zinc and gold is uncertain, but, as in the case of copper, it may be said that the maintaining of an increasing output for the United States and for the world has only been possible by utilization of lower grade ores.

It is a very conservative statement to make that during the last half century from the earth there have been taken more of our metallic wealth than during all the previous history of its exploitation. For some of the metals we may illustrate the marvelous increase since 1850:

From 1810 to 1853 the amount of iron ore exploited in the United States is estimated at 4,500,000 long tons; from 1854 to 1907, more than 640,000,000 long tons. The pig iron product of the world from 1500 to

1850, 350 years, is estimated at about 125,000,000 metric tons; from 1850 to 1906, 56 years, at 1,113,000,000 metric tons, or about nine times as great.

In the case of copper the amount which was taken out before 1850 in the United States is inconsiderable, but in 1906 it reached fifty-eight per cent of the world's production. For the first half of the nineteenth century the copper production of the world was 831,400 long tons, and for the second half 8,675,899 long tons, or more than ten times as much.

The gold production of the world from 1493 to 1850, 358 years, is estimated at 152,779,050 fine ounces, and from 1851 to 1907 at 405,075,135 ounces, or about three times as much.

The increase in the amount of silver mined was not so great as for gold. The estimated silver product from 1493 to 1850, 358 years, is 4,816,939,012 fine ounces, and from 1851 to 1907, 58 years, 5,166,804,675 fine ounces.

The above figures illustrate the point that the exploitation of the base metals, iron, copper, lead, and zinc, was relatively unimportant until the middle of the last century, whereas in the case of the noble metals the amounts exploited before 1850 were important. So far as the progress of the world is concerned, there is no question that the base metals are of immeasurably greater consequence than the noble metals.

Statements similar to those concerning the base metals may be made even more emphatically in reference to coal. Illustrative of this in the United States, the coal production of the year 1856 was 12,293,000 metric tons, whereas for 1907 it was about 492,000,000 metric tons, or more than thirty-three times as great. Similar, although perhaps not so striking, figures might be given for other countries; so that it is safe to say that the amount of coal exploited in the last half century for the world is several times as great as the amount mined during all previous time.

The above statistics show that during the last half century our metallic resources and coal have been drawn upon at a rate which has never before been dreamed of. This revolution has been largely due to the rise of applied science and its application to machinery and transportation. If instead of the last half century the last quarter century only were considered, the enormous drafts upon our metallic resources would seem even more startling. During this period the total value of the annual metallic product of the United States has increased from about \$447,000,000 to over \$2,000,000,000 or more than four times.

Since the great acceleration in the exploitation of our metallic resources has occurred so recently, the yardstick with which we are to project into the future is very short. We do not know whether the acceleration of exploitation of the past

few years will be continued at the same rate, but it seems rather probable that the time is near at hand when the speed of acceleration will lessen. But whatever we may conclude in reference to this matter, we cannot doubt that for many years to come the amount of metals extracted for any one decade will exceed that of the previous decade—that is, that the acceleration will proceed at some rate. Also it has been seen that while an approximate estimate can be made of the reserves which are yet to be developed or discovered in unexplored territory. Hence it is impossible to make any definite forecasts as to the time when the ores of any given metal will be exhausted.

Upon the whole, the foregoing very brief review of the situation does not warrant such extremely pessimistic views as have sometimes been stated in reference to our reserves of iron, lead, copper, zinc, gold, and silver. It is rather probable that we of this generation shall not see any great shortage of these metals. The same may be true for the next generation; but even the most sanguine calculation cannot hold out the hope that the available high grade ores of iron, copper, lead, zinc, gold, and silver, at the present rate of exploitation, will last for centuries into the future. And what are one or two centuries compared with the expected future life of the Nation?

But it may be said that when the metallic ores are mined and reduced the metals are but put into a more available form. In short, that they are capitalized. This is true in large measure for all the metals. It may be very well illustrated by the world supply of gold, now in the treasuries of the banks and circulation among the people, estimated at about \$7,000,000,000. However, it is plain that with the baser metals, lead, zinc, copper, and iron, we are very careless in preserving the existing accumulations. These materials are so handled that the yearly losses are very great. By care and economy the losses could be immensely reduced and thus our capital of metals kept in a relatively unimpaired condition.

Certain it is that it took the building of the world, involving concentration and re-concentration of the metals, to produce the ore deposits. The process of their formation is so slow that so far as we are concerned it may be ignored. We and our descendants are in the position of a man who has in the bank a definite amount of money upon which he may draw during his lifetime. He may be more or less ignorant of the amount which is available in the bank, as we are ignorant of the amount of metallic ores available in the bank of the earth. It is therefore plainly our duty in exploiting the metal ores to do this in such a fashion that the reserves of lower grade products not now available because of market conditions may in the future be exploited. Also it is plainly our duty to use met-

als which have been mined and reduced in such a way that the yearly loss shall be as small as possible. In short, we should keep the capital as nearly unimpaired as practicable. These two duties are plainly before this generation. If they are disregarded our descendants will charge us with wanton extravagance. We shall be in the position of a father who has wasted his patrimony and left a diminished estate to his son.

Following a brief discussion in regard to points of procedure, during which the suggestion was made that Governor Burke, of South Dakota, be made honorary secretary of the Conference, Mr. John Hays Hammond, the celebrated mining engineer, who has the distinction of being the highest salaried private individual in the world, addressed the Conference on the ore and mineral deposits of the country. Mr. Hammond said:

"What has been said of the danger of the rapid depletion of the iron and coal deposits, is applicable, *mutatis mutandis*, to the other mineral deposits of the country.

"In common with every other national industry, that of mining is vitally concerned in the conservation of our natural resources. These discussions show conclusively the interdependence of our national industries. The exploitation of our mines depends, chiefly, upon the costs of labor, power, and supplies; and these costs are determined by the economies attending the development of our other natural resources. Thus, the cost of mining-labor is dependent upon the expenses of living; the cost of power, upon the cost of fuel or the cost of power hydro-electrically generated; and lastly, the cost of supplies depends upon the cost of their production. Therefore, upon the economies effected in the other national industries, depends, reciprocally, the cost of our mineral products. Now, obviously, the lower the cost of mining, the greater the available tonnage of products that can be profitably mined. Indeed, in many of our low grade mines, so-called, the margin between profit and loss is so small that any appreciable increase in the cost of mining involves pecuniary loss and, consequently, the cessation of operations. Furthermore—and this is important—the mines of this character are those from which the major part of our production is derived.

"It has, unfortunately, been the popular custom to refer to large deposits of ore as illimitable and inexhaustible. Such hyperbole characterizes the description of the famous gold deposits of the Transvaal. As a matter of fact, we mining engineers know that these exceptionally extensive deposits will practically be exhausted within a cou-

ple of decades—certainly within a generation. The ever-increasing rapidity of exploitation, consequent upon the exigencies of modern engineering and economic practice, inevitably tends to an alarming diminution of the lives—if I may use that term—of our mineral deposits. *The culmination of our mining industry is to be reckoned in decades, and its declension, (if not practically its economic exhaustion) in generations, not in centuries.* While it is undoubtedly the fact that a very considerable lowering of the working cost, or a correspondingly greatly enhanced value of the mineral products, would prolong the activity of the mining industry, yet the statement I have made, predicated as it is upon the *known mineral deposits*, may be regarded as conservative. Explorations will undoubtedly lead to the finding of new mining fields, but the discovery of the more important deposits will, in all probability, occur in the *comparatively near future.*

"There is no way of revolutionizing our mining methods to attain better results; but they are susceptible, it is true, of greater improvements, and especially so in the metallurgical processes. But even therein the irreducible minimum is not great, compared with the advantage that would result to the mining industry from the conservation of the natural resources of the country.

"In striving, as we engineers are doing, to prevent, as it were, the leakage of water through the bung-hole, we see a large volume flowing out through the broken staves at the other end of the barrel. It is for this reason that you may rely upon the hearty co-operation of the miners of our country in your efforts to conserve the Nation's natural resources, and to perpetuate our national supremacy."

Answering calls from every part of the floor, Honorable Elihu Root, Secretary of State, extemporaneously addressed the Conference. Secretary Root said in part:

"Forty-four sovereign States are represented here, I see by the newspapers; all sovereigns here upon the invitation of the Executive of the sovereign Nation, the United States. No one can over-estimate the importance of maintaining each and every one of the sovereignties of the states (applause), and no one can overestimate the importance of maintaining the sovereignty of the Nation.

"The Nation cannot perform functions of the state sovereignties. If it were to undertake to perform those functions it would break down. The machinery would not be able to perform the duty. The pressure is already very heavy upon the national machinery.

"I feel deeply impressed, however, with

the idea that the forty-six sovereign states, in the performance of their duties of government, are lagging behind the stage of development which the other sovereignties of the earth have reached. As the population of our states increases; as the relations between the people of each state and other states grow more frequent, more complicated, more important, more intricate, what every state does is most important to the people of every other state. (Applause.)

"If you look at the international life of the world you will see that the correspondence between the nations is continually increasing; not in the letter-writing sense, but in the intercommunication and understanding of things that they should do in concert for the benefit of all their people.

"Scores and hundreds of conferences and congresses are being held under government auspices to regulate the action of the different nations of the earth. England and France and Germany and Spain, and all the nations of Europe, are considering the conduct of their governments with reference to the effect which their action shall have upon the people of each other government.

"Now, the states, in the exercise of their sovereignty, in the exercise of the powers reserved to them, rest under the same kind of duty (applause), a duty that forbids the people of any state to live unto itself alone. (Applause.)

"The Constitution of the United States prohibits the states from making any agreement with each other without the consent of Congress; but you can make any number of agreements with the consent of Congress. Why should not the powers that are reserved to the state sovereignties be exercised by those sovereignties, with a wise regard for the common interest, upon conference, upon complete understanding of the duties of good neighborhood, under a firm resolve to make it wholly unnecessary that this continual pressure to force the National Government into the performance of the duties that the states ought to perform should continue? (Applause.)

"I regard this meeting as marking a new departure, the beginning of an era in which

the states of the Union will exercise their reserve sovereign powers upon a higher plane of patriotism and love of country than has ever existed before." (Great applause.)

Secretary Root was followed by Secretary of the Treasury George B. Cortelyou, who made a few happy remarks along the line of Mr. Root's speech.

Hon. W. M. O. Dawson, Governor of West Virginia, took the platform at the close of Secretary Cortelyou's remarks, and spoke on the necessity of conserving the country's resources in coal, petroleum, natural gas, etc. He said that no state in the Union can say that its affairs are of importance to no one save the people within its borders. If the people in Missouri are wasting a part of the common heritage of the whole country, he said, the people of West Virginia, as a part of this common country, are interested in seeing that Missouri stops such waste; and, likewise, if West Virginia wastes the natural resources that are the common property of all the people, all the other states are interested in seeing that the waste in West Virginia is ended.

After some little discussion it was decided that the Governors, governors' advisers, members of Congress, members of the Supreme Court, and members of the Cabinet be given equal privilege in the matter of being heard, and after a motion to this effect had been made by Governor Blanchard, seconded by Governor Hoch of Kansas, and carried, a motion by Governor Hanly of Indiana, to adjourn, closed the first day of the Conference.

SECOND DAY'S SESSIONS

The morning session of Wednesday, May 14, was called to order at ten o'clock, Governor Johnson, of Minnesota, taking the chair when President Roosevelt retired. The session was opened with the address by Mr. James J. Hill.

Mr. Hill was originally scheduled to read a paper on "Transportation,"

and according to the original program his paper was to have been read at the morning session of May 15. This was changed, however, and Mr. Hill's subject was "The Natural Wealth of the Land and its Conservation." It is perhaps not generally known that the great railway magnate is a high authority on this subject, and his pa-

per, in the breadth of information it displayed, was a surprise to a majority of the Conference. Mr. Hill's paper follows:

In some respects the occasion that calls together this assemblage is unprecedented. The dignity and public influence of those present as guests and advisors mark its importance. It is in effect a directors' meeting of the great political and economic corporation known as the United States of America. The stockholders are the 87,000,000 people of this country—the directors are the state and federal officers, whose position brings them in touch with the operation of the whole country. We should not fail to recognize the high note that has been struck and the influence of the interests involved upon the lives of millions yet to be.

* * *

The two-fold significance of this meeting is found in the comparative novelty of its subject matter and of the method by which it has been approached. The subject is the conservation of our national wealth, and a careful study of our national economic resources.

Two years ago, in an address delivered before the meeting of the Minnesota State Agricultural Society, at St. Paul, I reviewed the practical consequences and the statistical proof of that national wastefulness which competent scientific authority had already set down as distinguishing the American people. From data of the highest certainty, no one of which has ever since been called in question, I then forecast some of the conditions certain to arise within the next half century, when the population of this country will have grown to more than 200,000,000. The facts were pointed out not in the spirit of the alarmist, but in order that attention might be directed to the way by which the Nation may escape future disaster. So rapidly do events move in our time, so swiftly do ideas spread and grasp the public mind, that some policy directed to the ends then set forth has already become a National care. It is this policy—the conservation of national resources, the best means of putting an end to the waste of the sources of wealth—which largely forms the subject matter of this Conference. For the first time there is a formal national protest, under seal of the highest authority, against economic waste. * * *

"Of all the sinful wasters of man's inheritance on earth," said the late Professor Shaler, "and all are in this regard sinners, the very worst are the people of America." This is not a popular phrase, but a scientific judgement. It is borne out by facts. In the movement of modern times, which has made the world commercially a small place and has produced a solidarity of the races such as never

before existed, we have come to the point where we must to a certain extent regard the natural resources of this planet as a common asset, compare them with demands now made and likely to be made upon them, and study their judicious use. Commerce, wherever untrammelled, is wiping out boundaries and substituting the world relation of demand and supply for smaller systems of local economy. The changes of a single generation have brought the nations of the earth closer together than were the states of this Union at the close of the Civil War. If we fail to consider what we possess of wealth available for the uses of mankind, and to what extent we are wasting a national patrimony that can never be restored, we might be likened to the directors of a company who never examine a balance sheet.

The sum of resources is simple and fixed. From the sea, the mine, the forest and the soil must be gathered everything that can sustain the life of man. Upon the wealth that these supply must be conditioned forever, as far as we can see, not only his progress but his continued existence on earth. How stands the inventory of property for our own people? The resources of the sea furnish less than five per cent of the food supply, and that is all. The forests of this country, the product of centuries of growth, are fast disappearing. The best estimates reckon our standing merchantable timber at less than 2,000,000,000,000 feet. Our annual cut is about 40,000,000,000,000 feet. The lumber cut rose from 18,000,000,000 feet in 1880 to 34,000,000,000 feet in 1905; that is, it nearly doubled in 25 years. We are now using annually 500 feet board measure of timber per capita, as against an average of 60 for all Europe. The New England supply is gone. The Northwest furnishes small growths that would have been rejected by the lumberman of 30 years ago. The South has reached its maximum production and begins to decline. On the Pacific Coast only is there now any considerable body of merchantable standing timber. We are consuming yearly three or four times as much timber as forest growth restores. Our supply of some varieties will be practically exhausted in 10 or 12 years; in the case of others, without reforestation, the present century will see the end. When will we take up in a practical and intelligent way the reforestation of our forests? * * *

The exhaustion of our coal supply is not in the indefinite future. The startling feature of our coal production is not so much the magnitude of the annual output as its rate of growth. For the decade ending in 1905 the total product was 2,832,402,746 tons, which is almost exactly one-half the total

product previously mined in this country. For the year 1906 the output was 414,000,000 tons, an increase of 46 per cent on the average annual yield of the 10 years preceeding. In 1907 our production reached 470,000,000 tons. Fifty years ago the annual per capita production was a little more than one-quarter of a ton. It is now about five tons. It is but eight years since we took the place of Great Britain as the leading coal producing nation of the world, and already our product exceeds hers by over 43 per cent, and is 37 per cent of the known production of the world. Estimates of coal deposits still remaining must necessarily be somewhat vague, but they are approximately near the mark. The best authorities do not rate them at much over 2,000,000,000,000 tons. If coal production continues

States doubles about once in seven years. It was less than 12,000,000 tons in 1893, over 24,000,000 tons in 1899, 47,740,000 tons in 1906 and over 52,000,000 tons in 1907. The rising place of iron in the world's life is the most impressive phenomenon of the last century. In 1850 the pig iron production of the United States amounted to 563,757 tons, or about 50 pounds per capita. Our production now is over 600 pounds per capita. We do not work a mine, build a house, weave a fabric, prepare a meal or cultivate an acre of ground under modern methods without the aid of iron. We turn out over 25,000,000 tons of pig iron every year, and the production for the first half of 1907 was at the rate of 27,000,000 tons. This is two and one-half times the product of Great Britain. It is nearly half the pro-



Photo Copyright by Harris & Ewing, Washington

"THE HOUSE OF GOVERNORS"

Group of State Executives who took Initial Steps toward forming a Permanent Organization of Governors

to increase as it has in the last ninety years, the available supply will be greatly reduced by the close of the century. Before that time arrives, however, resort to lower grades and sinking of mines to greater depths will become necessary; making the product inferior in quality and higher in price. Already Great Britain's industries have felt the check from a similar cause, as shown in her higher cost of production. Our turn will begin probably within a generation or two from this time. Yet we still think nothing of consuming this priceless resource with the greatest possible speed. Our methods of mining are often wasteful; and we not only prohibit our industries from having recourse to the coal supplies of other countries, but actually pride ourselves upon becoming exporters of a prime necessity of life and an essential of civilization.

The iron industry tells a similar story. The total of iron ore mined in the United

duct of the whole world. And the supply of this most precious of all the metals is so far from inexhaustible that it seems as if iron and coal might be united in their disappearance from common life.

The large deposits of iron ore in this country are now located. For cheap iron we depend upon the Lake Superior district, because of its high grade, the ease of extracting the ore from the mines and its nearness to cheap transportation. At the rate of over 50,000,000 tons per year, our present consumption, it would require over 2,000,000,000 tons to supply the demand for the next 40 years, supposing it to remain stationary. This would approach the end of all the higher grade ore in large deposits now in sight. The product of other workings would be of inferior quality and higher cost and remote from market. But production is certain to increase even more rapidly than in the past. A few

years ago a Swedish geologist prepared for his government a report, stating that the entire supply of the iron ore in the United States would be exhausted within the present century. The United States Geological Survey declared this an overstatement; but here is the conclusion of its own report. I quote the official published document: "Assuming that the demand for iron ore during the present century may range from 50,000,000 to 100,000,000 tons per year, the Lake Superior district would last for from 25 to 50 years more, if it supplied the entire United States. But counting on the known reserves elsewhere in the United States the ore will last for a much longer period, though, of course, it must necessarily show a gradual, but steady increase in value and in cost of mining, along with an equally steady decrease in grade." The most favorable view of the situation forces the conclusion that iron and coal will not be available for common use on anything like present terms before the end of this century; and our industrial, social and political life must be readjusted to meet the strains imposed by new conditions. Yet we forbid to our consumers access to the stores of other countries, while we boast of our increased exports, of that material for want of which one day the nation must be reduced to the last extremity.

We now turn to the only remaining resource of man upon this earth, which is the soil itself. How are we caring for that, and what possibilities does it hold out to the people of future support? We are only beginning to feel the pressure upon the land. The whole interior of this continent, aggregating more than 500,000,000 acres, has been occupied by settlers within the last 50 years. What is there left for the next 50 years? Excluding arid and irrigable areas, the latter limited by nature, and barely enough of which could be made habitable in each year to furnish a farm for each immigrant family, the case stands as follows: In 1906 the total unappropriated public lands in the United States consisted of 792,000,000 acres. Of this area the divisions of Alaska, Arizona, California, Colorado, Idaho, Montana, Nevada, New Mexico and Wyoming contained 195,700,000 acres of unsurveyed land. Little of Alaska is fitted for general agriculture, while practically all of the rest is semi-arid, available only for grazing or irrigation. We have (subtracting these totals) 50,000,000 acres of surveyed and 36,500,000 acres of unsurveyed land as our actual remaining stock. And 21,000,000 acres were disposed of in 1907. How long will the remainder last? No longer can we say that Uncle Sam has enough to give us all a farm.

Equally menacing is the change in quality. There are two ways in which the productive power of the earth is lessened; first by erosion and the sweeping away of the

fertile surface into streams and thence to the sea, and, second, by exhaustion through wrong methods of cultivation. The former process has gone far. Thousands of acres in the East and South have been made unfit for tillage. North Carolina was, a century ago, one of the great agricultural states of the country and one of the wealthiest. To-day as you ride through the South you see everywhere land gullied by torrential rains, red and yellow clay banks exposed where once were fertile fields; and agriculture reduced because its main support has been washed away. Millions of acres, in places to the extent of one-tenth of the entire arable area, have been so injured that no industry and no care can restore them.

Far more ruinous, because universal and continuing in its effects, is the process of soil exhaustion. It is creeping over the land from East to West. The abandoned farms that are now the playthings of the city's rich or the game preserves of patrons of sport, bear witness to the melancholy change. New Hampshire, Vermont, northern New York, show long lists of them. In Western Massachusetts, which once supported a flourishing agriculture, farm properties are now for sale for half the cost of the improvements. Professor Carver, of Harvard, has declared, after a personal examination of the country, that "agriculture as an independent industry, able in itself to support a community, does not exist in the hilly parts of New England."

The same process of deterioration is affecting the farm lands of western New York, Ohio and Indiana. Where prices of farms should rise by increase of population, in many places they are falling. Between 1880 and 1900 the land values of Ohio shrank \$60,000,000. Official investigation of two counties in central New York disclosed a condition of agricultural decay. In one land was for sale for about the cost of improvements, and 150 vacant houses were counted in a limited area. In the other the population in 1905 was nearly 4,000 less than in 1855.

Practically identical soil conditions exist in Maryland and Virginia, where lands sell at from \$10 to \$30 an acre. In a hearing before an Industrial Commission, the chief of the Bureau of Soils of the Department of Agriculture said: "One of the most important causes of deterioration, and I think I should put this first of all, is the method and system of agriculture that prevails throughout these states. Unquestionably the soil has been abused." The richest region of the West is no more exempt than New England or the South. The soil of the West is being reduced in agricultural potency by exactly the same processes which have driven the farmer of the East, with all his advantage of nearness to markets, from the field.

Within the last forty years a great part of

the richest land in the country has been brought under cultivation. We should, therefore, in the same time, have raised proportionately the yield of our principal crops per acre; because the yield of old lands, if properly treated, tends to increase rather than diminish. The year 1906 was one of large crops and can scarcely be taken as a standard. We produced, for example, more corn that year than had ever been grown in the United States in a single year before. But the average yield per acre was less than it was in 1872. We are barely keeping the acre product stationary. The average wheat crop of the country now ranges from twelve and one-half, in ordinary years, to fifteen bushels per acre in the best seasons. And so it is on down the line.

But the fact of soil waste becomes startlingly evident when we examine the record of some states where single cropping and other agricultural abuses have been prevalent. Take the case of wheat, the mainstay of single-crop abuse. Many of us can remember when New York was the great wheat-producing state of the Union. The average yield of wheat per acre in New York for the last ten years was about eighteen bushels. For the first five years of that ten-year period it was 18.4 bushels, and for the last five 17.4 bushels. In the farther West, Kansas takes high rank as a wheat producer. Its average yield per acre for the last ten years was 14.16 bushels. For the first five years it was 15.14 and for the last five 13.18. Up in the Northwest, Minnesota wheat has made a name all over the world. Her average yield per acre for the same ten years was 12.96 bushels. For the first five years it was 13.12 and for the last five 12.8. We perceive here the working of a uniform law, independent of location, soil or climate. It is the law of a diminishing return due to soil destruction. Apply this to the country at large, and it reduces agriculture to the condition of a bank whose depositors are steadily drawing out more money than they put in.

What is true in this instance is true of our agriculture as a whole. In no other important country in the world, with the exception of Russia, is the industry that must be the foundation of every state, at so low an ebb as in our own. According to the last census the average annual product per acre of the farms of the whole United States was worth \$11.38. It is little more than a respectable rental in communities where the soil is properly cared for and made to give a reasonable return for cultivation. There were but two states in the Union whose total value of farm products was over \$30 per acre of improved land. The great state of Illinois gave but \$12.48, and Minnesota showed only \$8.74. No discrimination attaches to these figures, where all are so much at fault. Nature has given to us the most valuable possession ever

committed to man. It can never be duplicated, because there is none like it upon the face of the earth. And we are racking and impoverishing it exactly as we are felling the forests and rifling the mines. Our soil, once the envy of every other country, the attraction which draws millions of immigrants across the seas, gave an average yield for the whole United States during the ten years beginning with 1896 of 13.5 bushels of wheat per acre. Austria and Hungary each produced over seventeen bushels per acre, France 19.8, Germany 27.6 and the United Kingdom 32.2 bushels per acre. For the same decade our average yield of oats was less than thirty bushels, while Germany produced forty-six and Great Britain forty-two. For barley the figures are twenty-five against thirty-three and 34.6; for rye 15.4 against twenty-four for Germany and twenty-six for Ireland. In the United Kingdom, Belgium, the Netherlands and Denmark a yield of more than thirty bushels of wheat per acre has been the average for the past five years. * * *

Our agricultural lands have been abused in two practical ways; first by single cropping, and second by neglecting fertilization. It is fortunate for us that nature is slow to anger, and that we may arrest the consequence of this ruinous policy before it is too late. In all parts of the United States the system of tillage has been to select the crop which would bring in the most money at the current market rate, to plant that year after year, and to move on to virgin fields as soon as the old farm rebelled by lowering the quality and quantity of its return. It is still the practice; although diversification of industry and the rotation of crops have been urged for nearly a century and are today taught in every agricultural college in this country. The demonstration of the evils of single cropping is mathematical in its completeness. At the experiment station of the Agricultural College of the University of Minnesota they have maintained 44 experimental plots of ground, adjoining one another, and as nearly identical in soil, cultivation and care as scientific handling can make them. On these have been tried and compared different methods of crop rotation and fertilization, together with systems of single cropping. The results of ten years' experiment are now available. On a tract of good ground sown continuously for ten years to wheat, the average yield per acre for the first five years was 20.22 bushels and for the next five 16.92 bushels. Where corn was grown continuously on one plot while on the plot beside it corn was planted but once in five years in a system of rotation, the average yield of the latter for the two years it was under corn was 48.2 bushels per acre. The plot where corn was grown gave

20.8 bushels per acre for the first five and 11.1 bushels for the second of these years, an average of sixteen bushels. The difference in average of these two plots was 32.2 bushels, or twice the total yield of the ground exhausted by the single crop system. The corn grown at the end of the ten years was hardly hip high, the ears small and the grains light. But the cost of cultivation remained the same. And the same is true of every other grain or growth when raised continuously on land unfertilized. We frequently hear it said that the reduction in yield is due to the wearing out of the soil as if it was a garment to be destroyed by the wearing. The fact is that soils either increase or maintain their productivity indefinitely under proper cultivation. If the earth is to "wear out," what is to become of the race?

The two remedies are as well ascertained as is the evil. Rotation of crops and the use of fertilizers act as tonics upon the soil. We might expand our resources and add billions of dollars to our national wealth by conserving soil resources, instead of exhausting them as we have the forests and the contents of the mines. For there is good authority for the assertion that the farmer could take from the same area of ground in four years' grain crops out of a total of seven years as much as the whole seven now give him; leaving the products of the other three years when the land rested from grain as clear profit due to better methods.

He can do far more than that by joining stock raising with grain raising. Nature has provided the cattle to go with the land. There is as much money in live stock as there is in grain. Looked at in any way there is money in live stock; money for dairy products, money for beef, money for the annual increase, and most money of all for the next year's crop when every particle of manure is saved and applied to the land.

We need not consider at present really intensive farming, such as is done by market gardeners with high profit, or such culture as in France, in Holland, in Belgium and in the island of Jersey produces financial returns per acre that seem almost beyond belief. What our people have to do is to cover less ground, cultivate smaller farms so as to make the most of them, instead of getting a scant and uncertain yield from several hundred acres, and raise productivity, by intelligent treatment, to twice or three times its present level.

There is more money in this system. The net profit from an acre of wheat on run-down soils is very small; consequently decreasing the acreage of wheat under certain conditions will not materially decrease profits. Here are

some reliable estimates. The price of wheat is given from the United States Department of Agriculture Yearbook.

Yield.	Price.	Market value per acre.	Cost of production, including rent.	Net profit or loss.
20.....	\$0.638	\$12.76	7.89	+ \$4.87
16.....	.638	10.21	7.89	+ 2.32
12.....	.638	7.66	7.89	- .23
10.....	.638	6.38	7.89	- 1.51
8.....	.638	5.10	7.89	- 2.79

I have dwelt upon the conservation of farm resources because of the commanding importance of this industry and because of its relation to our future. Nearly thirty-six per cent of our people are engaged directly in agriculture. But all the rest depend upon it. In the last analysis, commerce, manufactures, our home market, every form of activity runs back to the bounty of the earth by which every worker, skilled and unskilled, must be fed and by which his wages are ultimately paid. The farm products of the United States in 1906 were valued at \$6,794,000,000 and in 1907 at \$7,412,000,000. All of our vast domestic commerce, equal in value to the the foreign trade of all the nations combined, is supported and paid for by the land. Of our farm area only one-half is improved. It does not produce one-half of what it could be made to yield; not by some complex system of intensive culture, but merely by ordinary care and industry intelligently applied. It is the capital upon which alone we can draw through all the future, but the amount of the draft that will be honored depends upon the care and intelligence given to its cultivation. Were any statesman to show us how to add \$7,000,000,000 annually to our foreign trade, it would be the sensation of the hour. The way to do this in agriculture is open. Our share in the increase would not be the percentage of profit allowed by successful trading, but the entire capital sum. On the other side stands the fact that the unappropriated area suited to farm purposes is almost gone, and that we have been for the last century reducing the producing power of the country. Nowhere in the range of national purposes is the reward for conservation of a national resource so ample.

By the fixed rate of increase in the past, we must count upon a population



Photo Copyright by Harris & Ewing, Washington

PROMINENT FIGURES AT THE CONFERENCE

Standing—Secy. Shipp, Gov. Swanson, Chief Forester Pinchot, Gov. Folk
 Sitting—Gov. Willson, Gov. Sheldon. Willson, Sheldon and
 Folk, committee on permanent organization. Swanson,
 and Willson, committee on ways and means

of over 200,000,000 in the United States in the year 1950. The annual increase from natural growth is about one and one-half per cent each year. Adding for immigration only 750,000 a year, which is less than three-quarters of the figures reached in recent years, we shall have about 130,000,000 people in 1925 and at least 200,000,000 by the middle of the century. Where are they to go, how are they to be employed, how fed, how enabled to earn a living wage? The pressure of all the nations upon the waste places of the earth grows more intense as the last of them are occupied. We are approaching the point where all our wheat product will be needed for our own uses, and we shall cease to be an exporter of grain. There is still some room in Canada, but it will soon be filled. The relief will be but temporary. Our own people, whose mineral resources will by that time have greatly

diminished, must find themselves thrown back upon the soil for a living. If continued abuse of the land should mark the next fifty years as it has the last, what must be our outlook? * * *

Not only the economic but the political future is involved. No people ever felt the want of work or the pinch of poverty for a long time without reaching out violent hands against their political institutions, believing that they might find in a change some relief from their distress. Although there have been moments of such restlessness in our country, the trial has never been so severe or so prolonged as to put us to the test. It is interesting that one of the ablest men in England during the last century, a historian of high merit, a statesman who saw active service and a profound student of men and things, put on record his prophecy of such a future ordeal. Writing to an American

correspondent fifty years ago, Lord Macaulay used these words: "As long as you have a boundless extent of fertile and unoccupied land your laboring population will be found more at ease than the laboring population of the Old World; but the time will come when wages will be as low and will fluctuate as much with you as they do with us. Then your institutions will be brought to the test. Distress everywhere makes the laborer mutinous and discontented and inclines him to listen with eagerness to agitators who tell him that it is a monstrous iniquity that one man should have a million and another cannot get a full meal. * * * The day will come when the multitudes of people, none of whom has had more than half a breakfast or expects to have more than half a dinner, will choose a legislature. Is it possible to doubt what sort of legislature will be chosen? * * *

* There will be, I fear, spoliation. The spoliation will increase the distress; the distress will produce a fresh spoliation. * * *

* Either civilization or liberty will perish. Either some Cæsar or Napoleon will seize the reins of government with a strong hand, or your republic will be as fearfully plundered and laid waste by barbarians in the twentieth century as the Roman Empire in the fifth." We need not accept this gloomy picture too literally, but we have been already sufficiently warned to prevent us from dismissing the subject as unworthy of attention. Every nation finds its hour of peril when there is no longer free access to the land, or when the land will no longer support the people. * * *

* Far may this day be from us. But since the unnecessary destruction of our land will bring new conditions of danger, its conservation, its improvement to the highest point of productivity promised by scientific intelligence and practical experiment, appears to be a first command of any political economy worthy of the name.

If this patriotic gospel is to make headway, it must be by just such organized missionary work as is to-day begun. It cannot go on and conquer if imposed from without. It must come to represent the fixed idea of the people's mind, their determination and their hope. It cannot be incorporated in our practical life by the dictum of any individual or any officer of Nation or State in his official capacity. It needs the co-operation of all the influences, the help of every voice, the commendation of Nation and State that has been the strength and inspiration of every worthy work on American soil for 120 years. We return, for our gathering in council and for our plan of action for the future, to the model given us by the Fathers. State and Nation are repre-

sented here, without jealousy or any ambition of superiority on either side, to apply to the consideration of our future such co-operation as that out of which this Nation was born and by which it has won to worthy manhood. Reviving the spirit of the days that created our Constitution, the days that carried us through civil conflict, the spirit by which all our enduring work in the world has been wrought, taking thought as Washington and Lincoln took thought, only for the highest good of all the people, we may, as a result of the deliberations held and the conclusions reached here to-day, give new meaning to our future; new lustre to the ideal of a Republic of living federated states; shape anew the fortunes of this country, and enlarge the borders of hope for all mankind.

Immediately after the conclusion of Mr. Hill's paper, Dr. Thomas C. Chamberlain, President of the American Association for the Advancement of Science, head of the department of Geology, University of Chicago, and editor of the *Journal of Geology*, read a paper on "Soil Wastage." Dr. Chamberlain stated that his studies and investigations have brought him to the belief that the era of the earth's future habitability is vastly greater than we have been wont to think. He stated that it is a familiar deduction of geology that for untold ages rains have fallen on the lands, and soils have grown in depth while the surface has been washed away. Production and removal, he said, have run hand in hand, and yet they have been controlled to such a degree by the adjustments of nature that no part of the surface seems ever to have been so far denuded that plants could not grow on it. More than this, it appears, said Dr. Chamberlain, that the ordinary adjustments of nature make for the increasing fertility of the soil, rather than for depletion. Dr. Chamberlain's address follows:

The invitation to give thought to the resources that affect our future appeals to me with peculiar—indeed almost personal—force, for my studies of the past decade have led to the belief that the era of the earth's future habitability is vastly greater than we have been wont to think. We have grown up in the belief that the earth sprang from chaos at the opening of our era and is plunging on to catastrophe or to

a final winter in the near future. Quite at variance with this, I have come to believe that the earth arose from a regenerative process and that it offers a fair prospect of fitness for habitation for ages yet to come. If this be true, it is eminently fitting that our race should give a due measure of thought to the ulterior effects of its actions.

It is one of the latest conceptions of geology that climatic conditions have been of the same order as at present from early eras, in the large view, in spite of some notable variations, and that this uniformity is the result of a *profound regulative system* which has sufficed to keep the temperatures of the earth's surface and the constitution of the earth's atmosphere within the narrow range congenial to life for a vast period. As a result there has been no break in the continuity of land life since it came into being eras ago. It appears further that the sources of supply of the vital elements are still adequate, and are likely to be so for long ages, that the regulative system is still in effective control, and that a vast future of habitability may fairly be predicted. Whether you are prepared to accept so large a view of the habitable future or not, I trust you will strike hands with me in the conviction that the probabilities of the future are at least so great as to render imperative the serious consideration of our obligations toward it.

Let us turn at once to the basal factor in the problem, the rainfall, the soil, and soil-wastage, the special theme of this hour. The rainfall is an inherited asset, the soil is an inherited asset, even a little soil is an asset, but reckless soil-wastage is a serious error. Soils are the product of the atmosphere and its waters modifying the rock surface. When the atmospheric waters have aided the air in producing soil by rock decay they pass, on the one hand, into plants or back to the surface soil and thence through these again to the atmosphere by evaporation, or, on the other hand, they pass on down to the ground-waters and thence into the streams, furnishing in them the basis for water-foods, of power, and for navigation. Here is a good deed—soil production—followed by a laudable course either up or down with beneficent results in either course. The alternative is to rush away as foul erosive floods on the surface, wasting soil and plant food, gully-ing the surface, choking the ravines, flooding the valleys, silting the pools, filling the reservoirs, sweeping out the dams, barring the streams and clogging the deltas. If it shall be found that all or nearly all the waters should go into the soil and thence into the underdrainage, coming out slowly and steadily by seepage and by springs into the streams, these streams should present nearly ideal conditions for water-food, for water-power, and for river-navigation. The solution of the soil problem may therefore be, in large part, the solution of the whole

complex of problems of which navigation is the last term. It may thus prove to be the *key* problem.

We have as yet no accurate measure of the rate of soil production. We merely know that it is *very slow*. It varies obviously with the kind of rock. Some of our soils are derived from material already reduced to a finely pulverized condition. Such are the lowland accumulations from highland wash. Such also is the glacial drift, rock-flour rasped from the face of the rock by the glacial file and ground up with old soils. Soils may be developed from such a base of half-prepared material with relative rapidity, but observation shows that even on these, when the slope is considerable, wind, wash and cropping remove the surface much too fast for stable fertility. But for average rock, under ordinary favorable conditions, in our range of climate, the usual estimate has been a foot of waste in 4,000 to 6,000 years, which includes channel cutting and bank-undermining. These are too rapid for ordinary soil waste and replacement under our normal conditions. Without any pretensions to a close estimate, I should be unwilling to name a mean rate of soil-formation greater than one foot in 10,000 years on the basis of observations since the glacial period. I suspect that if we could positively determine the time taken in the formation of the four feet of soil next to the rock over our average domain, where such depth obtains, it would be found above rather than below 40,000 years. Under such an estimate, to preserve a good working depth, surface wastage should not exceed some such rate as one inch in a thousand years. If one chooses to indulge in a more liberal estimate of the soil-forming rate, it will still appear, under any intelligent estimate, that surface wastage is a serious menace to the retention of our soils under present modes of management. Historical evidence enforces this danger. In the Orient there are large tracts almost absolutely bare of soil on which stand ruins which imply former flourishing populations. Other long-tilled lands bear similar testimony. It must be noted that more than loss of fertility is here menaced. It is the loss of the soil-body itself, a loss almost beyond repair. When our soils are gone, we too must go, unless we shall find some way to feed on raw rock or its equivalent. The immense tonnage of soil-material carried out to sea annually by our rivers, even when allowance is made for laudable wash, and for material derived from the river channels, is an impressive warning of the danger of negligent practices. Nor is this all; the wash from one acre is often made the waste-cover for another acre, or for several. Sometimes one's loss is another's gain, but all too frequently one's loss is another's disaster.

If the atmospheric waters may not run

off the surface freely without serious menace, where may they go and what may they do consistent with our welfare? The answer lies in a return to the study of the origin and internal work of soils. For necessary brevity, let us neglect all secondary soils, or overlacements, and consider simply the origin and activities of primary soils derived from primary rocks. The action of air and water in producing soil from such rock is partly chemical and partly physical. Certain rock substances are made soluble and become plant food or plant poisons, while others remain relatively insoluble but are reduced to a finely divided state and form the earthy element of the soil.

Some of the soluble substances, thus formed at the base of soils are necessary plant food, while some are harmful; but what is more to the point, all are harmful if too concentrated. There is need therefore that enough water passes through the forming soil, and on down to the groundwater and out through the underdrainage, to carry away the excess of these products. An essential part of the best adjustment is thus seen to lie in a *proper apportionment of the amount of water which goes through the soils*. If this be not enough, the plants will suffer from saline excess; if too much, the plants may suffer from saline deficiency.

When evaporation from the surface is active and prolonged, waters which had previously gone down to the zone of soil-formation and taken up soluble matter, rise again to the surface bringing the soluble matter up and leaving it at the surface on evaporation. Up to a certain point this is favorable to the plant; beyond the critical point, it begins to be harmful, as abundantly shown in the "alkaline" efflorescences of arid regions.

Beside the water that goes through the soil into the subdrainage, and that which runs off on the surface, enough must be held *at all times in the soil during the growing season* to supply the plants, and yet not enough to water-log the soil.

The key to the problem lies in due control of the water which falls on each acre. This water is an asset of great possible value. It should be looked upon as such. It should be computed by every acre-owner as a possible value, saved if turned where it will do good, lost if permitted to run away, doubly lost if it carries also soil values and does destructive work below. Let us repeat the story of its laudable paths. A due portion of this should go into the underdrainage *carrying away harmful matter*; a due portion should go again *up to the surface carrying solutions needed by the plants*; a due portion should obviously go into the plants to nourish them; while still another portion should run off the surface carrying away a little of the leached soil matter. There are a multitude of important details in this complex of actions but they must

be passed by; the great features are clear and imperative.

Experimental studies have shown that, on the average within our domain, *crops can use to advantage all the rainfall during the growing season*, and that, *in most cases, crops are better for all the stored supplies that can be carried over from the non-growing seasons*. This greatly simplifies the general problem, for it justifies the conclusion—to which there are many local exceptions, of course—that the highest crop-values will usually be secured when the soil is made to absorb as much of the rainfall and snowfall as practicable. In securing this maximum absorption and internal soil-work, the run-off, and hence the surface wash, will be reduced to a minimum. It has already been seen that the wash of even this inevitable minimum is likely to be still too great to keep the proper slow pace with soil-generation, when the surface has much slope. Except on very level ground and on lodgment surfaces, there need be no solicitude about a sufficient removal of the soil surface. The practical problem then lies almost wholly in retaining and passing into the soil the maximum of the precipitation. Obviously this gives the minimum of wash to foul the streams, to spread over the bottom lands, to choke the reservoirs, to waste the water-power, and to bar up the navigable rivers. *The solution of the problem for the tiller of the soil essentially solves the whole train of problems.*

How is this control to be effected? As a geologist, I naturally turn first to nature's time-tested processes. Nature has been working on this complex problem of balance between soil formation, soil waste, surface slope, plant growth, and stream development, for millions of years, and we have inherited the result, a magnificent inheritance. The larger part of our domain, when invaded by us, had reached a fair adjustment of slopes to precipitation, was covered with a soil-mantle of fair depth and high average fertility, and was clothed with rich vegetation. There were exceptions to this, and some of these were large, but limitations of time shut out such exceptions here.

Looking at nature's methods for suggestions, we note that a much larger variety of plants are used by nature to cover and protect the soil than we use, and that these have a wider range of adaptation to the special situations where protection is needed. This invites the inquiry whether it is not possible to follow this precedent further than we have done by developing a larger number of profitable plants, among which shall be more that are adapted to protecting the surface, and to growing on slopes specially subject to wash. Forest trees are an important resource of this kind and should be employed as fully as practicable, as will, no doubt, be urged with great cogency by those who discuss the problem



WISCONSIN'S RAVISHED FORESTS
Burned-off White Pine Lands in Douglas County

of forestry. We also have many berry-bearing shrubs, vines and fruit trees, whose employment to the maximum in covering slopes is likewise urged either alone or in conjunction with trees. But, for the greater part, berries and fruits are perishable and have limitations of preservation, transportation, market, etc. But if shrubs could be evolved by modern selective methods whose nut-meats or dry seeds should be suitable for food in place of the watery pulp, and which could be treated much as cereals are, and have similar wide year-round markets, there would be a larger choice of crops to grow in soils subject to wash, and we might secure soil-protection with less crop-limitation. There would then be less need to press the culture of the cereals so far as we do now, and they could be limited more largely to surfaces less subject to harmful soil-loss.

Another marked feature of nature's method is the development of plant-societies, or from our point of view, combination-crops. There can be no doubt that there is much deleterious crowding and repressive rivalry among the natural mixtures of plants, but at the same time, there seem to be associations that are mutually beneficial. No doubt man secures a great temporary advantage by isolating chosen plants and freeing them from competition, but this is clearly at some permanent disadvantage which is partially corrected by rotation, fertilizing, and tith. Cannot a greater ad-

vantage be secured by a larger use of the combination method? It is clear that legumes and cereals are helpful associates in rotation and in some combinations. May not this be pushed so far by skillful selection and proper culture that legumes and helpful associates may replace weeds in becoming the constant and spontaneous associates of cereal crops, so that, while kept in such subordination as to be the servants of the cereals, they may still aid in covering and protecting the soil and thus guard against undue surface loss. Certainly much can be done by such plants, used as fall and spring crops, to cover the soil when specially exposed to wastage.

The full list of tried methods should be pressed into the utmost employment.

Since the chief object is to cause the maximum of rainfall to be absorbed into the soil, it is obvious that all methods of culture and all crops that increase the granularity and porosity of the soil contribute to the end sought. Deep tith to promote soil granulation, and deep-rooting plants to cause root-tubes, are specific modes of great value.

Artificial underdrainage by preventing the water-logging of the soil and by promoting its granulation, assists in absorption and transmission.

Contour cultivation, by arresting the direct descent of the waters on the surface and distributing them along the slopes, when properly controlled aids absorption

and limits surface wash. On the steeper slopes, special devices may be used to supplement contour cultivation, such as strips of grass-land, shrub-land, or trees, alternating with zones of plow-land. Reservoirs at the heads of ravines and at suitable heights in the ravines where surface wash is concentrated, may be used to arrest storm-floods, and if these are connected with lines of tile-drain following contours on either hand, the concentrated waters will be redistributed and at the same time transferred from the surface to the subsoil.

These and similar devices serve to limit the wash of the slopes, but the more radical and permanent remedies will, I think, be found in the development of values in trees, shrubs, vines, and grasses to such an extent that they may be employed almost exclusively in clothing the steeper slopes where wash is most menacing, and where the usual modes of culture that give rise to bare surfaces during portions of the year can scarcely fail to involve a degree of wash which cannot be replaced by soil growth below. Is not the time at hand when trees, shrubs, vines, grasses, and combinations of these, may be so developed and extended in value and availability by modern selective processes that they shall become sufficiently profitable crops to monopolize all the areas where wash threatens the ultimate removal of the whole soil? By such extension of these crops may not the bare-surface culture be so limited to relatively level lands as to cause in these, when intelligently handled, only that degree of surface loss which they can stand without menace to the perpetuity of the soil?

But a critical question remains to be answered: Can such modes of soil-management and crop-selection be made to give reasonable profits? Before we can hope that the millions who till the soil will join effectively in a radical scheme of soil-conservation, it must be made to appear that it will give some reasonable returns at every large stage of its progress; must pay, let us say, in the long run of a lifetime. We may fairly assume that intelligent people will be guided by the total returns of a lifetime, in lieu of beguilement by the ultra-quick returns of forced and wasteful cropping in total neglect of later results. It may be assumed that he who tills a farm from his twentieth to his sixtieth year will find more satisfaction in the summed profits of forty crops of increasing value enhanced by the higher value of his land at the end, even though the margin above cost be no greater, than in the sum of forty crops of decreasing values with a debased value of the land at the end. Our practical problem is therefore so to improve processes, so to increase intelligent management, and so to exalt the point of view, that every step in the processes proposed shall give satisfactory returns for the labor involved. How far this is practicable just now, I must leave to

those whose technical knowledge in the practical art of tilling fits them to answer; but in any event, it seems that this must become so in time; for if the loss of soils proceeds at the present rate and the number of inhabitants continues to increase as now, the value of the residue of tillable land which will remain after a few centuries will so appreciate as to force extreme measures for its conservation. The pitiable struggles of certain Oriental peoples to retain and cultivate the scant remnant of once ample soils is at once an example and a warning. Our escape from this dire struggle should spring from a clearer forevision, a deeper insight, greater technical skill, and indefatigable industry.

Before the discussion of these papers was opened, Hon. James Wilson, Secretary of Agriculture, was called upon by the Conference and responded with a brief address that was crowded in every crisp sentence with hard, common sense.

Secretary Wilson opened his remarks by saying that he did not think it wise for him to say anything to the Conference. "I have been filling up since you came here," he said, "and really you should do the talking and give us instruction. I am one of the servants of the American people, and I am anxious to know what is best to be done for the general good."

Continuing, Secretary Wilson said:

"The paper read by Mr. Hill this morning made a very deep impression upon me. The greatest asset we have in the United States is our soil; we are destroying that as rapidly as we can, and the oldest settled part of the United States has made the most progress in the destruction of our soil (laughter), of which we have a great variety. Down on the Gulf coast the land has been peopled longer than the upper part of the Mississippi Valley. The heavy rainfalls, and the perpetual cultivation and growing of crops have helped erosion, and the soil has been destroyed in that way. It is going off very, very rapidly. The cure is a system of agriculture that will keep the soil filled with plant food, organic matter, humus. That is the cure; that is the way to keep up the soil. Somebody once asked an English gardener how he got such a fine lawn. He had a beautiful grass lawn which attracted attention. He said, 'We weeded, and we weeded; we manured and we manured, for eight hundred years; and that is the way they got it. (Laughter.)'

"Now, jumping from one part of the United States to another—because I am go-

ing to speak but a very few minutes—the people in the grass belt of the Mississippi Valley have ceased to grow crops to so great an extent as they do in some other parts of the country. They grow grass, because they are compelled to. The factory, the railroad, the mine, have taken away the farm help, and farmers are not able to compete with those other institutions in hiring men. So far as the poor land is concerned, the land is being abandoned and is going back to nature; and nature is good to it, if you give her time. But this results, too, in rich land being put in grass.

"Anybody in studying wheat and looking into the production of one of those states that at one time grew fifty million bushels will discover that now they grow scarcely any. Why? It does not pay them. Put wheat up to a dollar a bushel and the state of Iowa will grow fifty million of bushels a year. They will plow up the pastures and grow wheat.

"The people of the Southern states were not able to engage in cattle raising, because nature had planted there an obnoxious tick, and the business was not profitable; but the United States Government has set about destroying that tick, and the effort will succeed. Those people will get cattle; the people will grow grasses; the grasses will fill the soil; erosion will cease, and when they want a great cotton crop they will plow up the soil, as the man in Iowa plows up the pasture to get a corn or a wheat crop. (Applause.)

"Go further west, into what was known as the Great American Desert, and which is to all intents and purposes the American desert now, west of the one hundredth meridian. The Department of Agriculture hunted the world over for plants that grew in dry regions, and along the deserts in Asia and Africa they found such plants. They found a hard wheat; and we had quite an interesting time in getting it introduced, because the miller did not want to grind hard wheat; it took more power. But we heard of fifty million bushels of it last year. (Applause.) It is the richest wheat that grows; there is more nutriment in it than in any other wheat, and to-day it is growing all the way from the Dakotas to the Pacific Ocean.

"But you cannot grow crops forever without legumes. The people out West have a rich land; the disintegrated rock has not been carried away, as in the Southern states, by floods of water, because they do not have floods of water. (Laughter.) When the irrigation problem, under my friend Newell here, lets water on that land it will grow anything, because it is exceedingly rich.

"When you speak of the destruction of a soil it means that you have taken away that part of the plant's food that comes from the atmosphere; and good farming means the keeping of a supply of organic matter in the soil.

"It is well to apply fertilizer if your system of farming is such that you cannot get a pasture. But the people in the Mississippi Valley never have used fertilizers, and, let me tell you, they never will, because there is not enough fertilizer to be had in the market to supply the American farmer. We have got to farm without it; that is what we have got to do. And the people in the dry regions of the West are some day going to supply the cities of the East with wheat from that same dry region. (Applause.)

"We sent men two years ago way up into Northern Siberia to find wheat and legumes for North Dakota. We knew it must be there, because man could not live without legumes; and when we went there we found a clover that lived in the winter, with the thermometer six degrees below freezing; and we found a new alfalfa. We are going to bring this winter wheat and this clover and alfalfa here this summer and take them out to the people west of the one hundredth meridian, and then these people will be ready to farm." (Great applause.)

When Secretary Wilson had closed his remarks, Governor Johnson started a hearty laugh among the politicians present by a humorous application of one of the points made by the Secretary. He said: "I think the Secretary has struck a very happy note in one thing. He has advised a remedy. He says that we must have something from the atmosphere for the enrichment of the soil. I know there are a number of men here who are in politics, and it seems to me that this will give a number of our politicians a steady occupation. If hot air is just as good as cold, we know now what the politicians of the future have got to do."

Mr. Jas. S. Whipple, State Forest, Fish and Game Commissioner of New York, one of the advisers chosen by Governor Hughes of New York, made a short talk on forestry conditions as they exist in the Empire State, and told what that state is doing along the line of forest conservation. Mr. Whipple said:

"We have in the state of New York 41,000,000,000 feet of lumber, board measure, standing, including farm lots and all. The state owns 1,500,000 acres of woodlands, which, under the Constitution, cannot be touched; and therefore that must be deducted from the whole amount. We cut

last year 1,250,000,000 board measure. A simple mathematical calculation will tell us that in twenty-two or twenty-three years, at that rate, not one solid stick will stand in the Empire State, although twenty-seven per cent of our total area is now covered with forests.

"The state's agricultural lands are depreciating in productive value, as has been stated by the Secretary of Agriculture and by Mr. Hill, and the water sources are drying up. The formation of New York is such that most of the water comes from the great upland plateau, extending from the Adirondacks to the foothills of the Alleghanias. In such a state it is especially imperative that the forests be preserved in sufficient quantity, else our agricultural lands will be depleted to such an extent that it will not be practical to farm them. Suppose that in an hour, by reason of some great natural catastrophe, every tree should be swept from the state of New York, what would be the result? Chaos, desolation everywhere, streams dried up, dry creek beds and river beds in July and August, no water for the farm, agricultural products decreased fifty per cent, and price of farms decreased as much, or more.

"Therefore, for the benefit of agriculture alone, to say nothing about the question of a timber supply, which is so imperative, all sensible men ought to read the history of the countries that have demonstrated this fact for a thousand years, and act upon the teachings of that history. They should not sit quietly by and see their forests wiped away and the interests of their country ruined beyond repair—for it takes one hundred years to grow a tree that can be cut down in five minutes. The most imperative thing we have to do is to save the forests of this country. (Great applause.)

"Let me tell you what we are doing in the state of New York. We planted last year 1,100,000 pine trees in the waste lands of the Adirondacks. Look at the history of forestry in your states and in the Nation, and you will see that New York has planted as many trees as all of the states and the National Government combined. Mr. Pinchot sent his forester to our gardens last year, and he said that they are the best in the United States. We have ten or twelve acres, all told, of tree gardens. What of other countries? German has fifteen or twenty tree gardens of two hundred acres each, and they raise 10,000 trees in one little bed, while the Empire State has twelve acres of tree gardens to furnish its trees.

"Coal cannot be reproduced; iron cannot be reproduced; but the forests can be reproduced, and if you preserve the forests by planting, and by careful cutting, you will have water courses, and your water courses will save the forests and save the farms.

"Last year we cut an acreage five times as great as that which was replaced. The rate of cutting is increasing every year, and

I ask you what are we coming to? If we cut last year five times the amount that was replaced, and if we cut this year eight times the amount replaced, and if next year we cut ten or twelve times the amount replaced, how long will it be until we have none left to cut?"

Governor Brooks, of Wyoming, arose to ask the speaker if the work of reforestation done in New York is not entirely under the supervision of the State Forestry Association; and Mr. Whipple replied that such was the case, stating that the New York State Forestry Service has been in existence eighteen years. Governor Brooks asked if it was not a fact that in the Adirondacks many sections have already been cut over three different times; and Mr. Whipple answered that no section in New York had been cut over three times, although some have been cut over twice. Governor Brooks stated that he was under the impression that in the reports of the New York State Forest Commission, issued during Governor Flower's administration, it was stated that certain sections of the Adirondacks had been cut over three times, trees cut being twelve inches and upward in diameter. To this Mr. Whipple replied: "Every green tree on the slopes of the Hudson of twelve inches, or eight inches, or three inches, has been cut, and throughout that entire area erosion is taking place to-day. It has not been cut over three times because after the first and second cuttings nothing was left to cut." Mr. Whipple continued by calling attention to the fact that natural re-seeding of cone trees in American will never be a commercial success. He stated that the hardwoods will re-seed successfully, but artificial propagation of cone bearing trees is a necessity, because of the fact that the planted tree or the transplanted tree will grow in height twice as fast as the tree naturally re-seeded in the forest, this being due to the larger root growth secured with every transplantation. From the commercial side alone, he said, the business of raising coniferous trees is the most profitable

in the whole forestry proposition, as it will pay twice compound interest to any one who will invest his money in it.

Mr. Whipple concluded with the suggestion, which was received with distinct appreciation, that every state in the Union place on its statute books a law exempting from taxation the land dedicated to tree raising.

Hon. John F. Fort, Governor of New Jersey, followed Mr. Whipple with a statement in regard to New Jersey's forestry work. Governor Fort said that New Jersey has purchased within the last three or four years 10,000 acres of land to be maintained as state forest reserves. The New Jersey legislature this year appropriated \$25,000 for the work of the Forestry Commission, and it is the state's intention to purchase from 5,000 to 6,000 acres of land this year, to be added to the previously acquired reserves.

An agreement between state and townships has been made, whereby the townships in which these acquired forest reserves are located, are paid two cents an acre on their taxes from the State Treasury for every acre of taxable land acquired by the state.

Another thing that has been done in New Jersey, Governor Fort said, is the establishing of fire lines along all the railways of the state. A line, ten feet wide, 100 feet from either side of the track is provided for, and it is also provided that persons who will not allow the State to establish such fire lines through forest lands privately owned, shall not have any action against railroads for damages by fire. Where permission is granted to establish fire lines, individuals have their remedy, as now, in case fires occur.

Governor Fort concluded by saying that New Jersey proposes to go on in the work of reforestation and forest conservation, with the intention of making the State Forests playgrounds, as well as sources of profit, for the people of New Jersey and of the United States.

Governor Woodruff, of Connecticut, then introduced Dr. Arthur D. Hadley, President of Yale University, who spoke briefly on the work of the Yale Forestry School. Dr. Hadley said:

"When we first started our forestry school at Yale, eight years ago, things looked darker than they look now. It did not seem as though there was any interest in forestry at all. We worked with Mr. Pinchot, here in Washington, and, acting under his advice, developed a school which should not only teach forest botany, but which should teach forest economy, and forest economy adapted to American conditions. (Applause.) Our fear in the establishment of that school was that there would not be demand enough for the graduates. The numbers have increased until now we are sending out each year from thirty to forty men, trained in the actual business conditions of American forestry, besides giving instruction in summer to a large number of practical forest men in certain of the theoretical parts of the work.

"The growth of demand for these men has been so unexpectedly rapid that I feel sure, if this assembly can manage to tide over the dangerous time of the next twenty years, that after that the thing will take care of itself. The people will get such new conceptions of forestry and the demand for lumber, that, on mere business ground, forest preservation, in expert hands, will take care of itself, as a matter of course. But just now it is for an assembly like this to make the demand, before we reach the dead line, instead of waiting until that comes.

"How can we do it? First, by working in our own state in the way that the Governors in their speeches, and the delegates in their speeches, have shown, and still more, I think, by putting pressure on the National Government in favor of the extension of forest reservation in every possible way. (Applause.) Powerful as we are in our own states, an assembly like this, called by the President, is yet more powerful in carrying the public opinion of the country with it; and we stand here for the principle that our Government should not be a Government for the partial interest of the country, not even a Government for the important interests of the country, but a Government for the permanent interests of the country. (Applause.)

"Second, we have it in our power also, as has been suggested, to make intelligent forestry by individuals more profitable than it is to-day. (Applause.) Suggestions have been made regarding possible tax laws. I shall not try to repeat them. But by the appointment of committees, by the exchange of expert opinions, a body like this can make a great many things that do not quite

pay to-day, and yet are overwhelmingly for the public interest, pay five or ten years hence.

"I believe, gentlemen, that you have it in your power to put this great national work where, twenty years hence, it will take care of itself." (Applause.)

Hon. Robert B. Glenn, Governor of North Carolina, followed Dr. Hadley with an address that wrought the Conference up to a pitch of enthusiasm such as had not been reached through the entire two days' sessions. Governor Glenn's reference to the bills pending in Congress, providing for the establishment of a forest reserve in the Southern Appalachians, were punctuated with crashes of hand-clapping that fairly rattled the chandeliers. He said:

"Mr. President, Governors, and gentlemen of the Conference: In the language of one of the greatest sages and statesmen of this Union, Grover Cleveland (applause), 'a condition and not a theory confronts us to-day.' We have heard from the very able paper of the strong and patriotic President of the United States (great applause) something as to our duty in conserving our resources; and we have heard from the papers of Mr. Carnegie and Mr. Hill that something must be done to preserve the natural resources of this great Union in which we live.

"Now, Mr. President, what has caused the present condition? If you have listened to the papers that have been read you have learned that our forests are being denuded; our water powers are becoming exhausted; our land is being washed away and made worthless; our harbors are filling up; our commerce is being paralyzed; and something must be done to stop this waste, to stop this extravagance and to bring forward a remedy that will enable this great Nation to go forward as it has never done in the past.

"What is the most serious of all these terrible conditions confronting our people to-day? I can answer almost in one word. It is the failure of the people throughout the states to protect the great forest resources of the land in which we live. (Applause.) This is the source and cause of all these other ills of which I have just spoken. The people have been regardless of the future, only living for the present, thinking of themselves and not of their children and their children's children that are going to come after them, as all patriots should think. Vandals are going into our forests and denuding and destroying them, and their hands must be stayed. Vandalism

must be stopped; there must be an end to this waste, or else there can be no hope for our soil throughout the length and breadth of this Nation.

"For this existing condition there must be some remedy; but where must this remedy come from? It must come alike from the states and the Nation, state going hand in hand with state, and the states joining with the Nation. (Applause.)

"Last night at a banquet given to the Governors of this great Nation of ours Speaker Cannon said the township commenced, then the county, then the state, and then came a call upon the Nation for help and succor. The townships of the various states have already acted. We are cleaning out our little creeks and rivers, stopping the waste all we can by indictment and otherwise; we are trying to protect our resources as best we can, but the great arm of the Nation must be used to aid the people of this great section in which we live. (Applause.) A state can control intra-state commerce, but a state is powerless to control inter-state commerce. A state can control intra-state destruction, but a state is powerless to control inter-state destruction. Therefore we must have some means by which we can be brought together, and by which the Government and the states may go hand in hand—to prevent the devastation and the destruction now going on.

"There is a bill now pending in Congress which would bring about this remedy (applause), and I say to the members of the Senate and to the members of the House of Representatives that if they will only pass that bill every state government from Maine to Texas and to the great Pacific Coast will co-operate with this Government in bringing about a condition of things that will build up the great Nation in which we live to-day. (Great applause.)

"We have come before these men from 1899 up to the present time. Five or six times, representing my state, have I been here and knocked at the door of Congress, asking for relief. Each time they said 'next session,' and 'next session,' and 'next session.' When is the next session to come, Mr. President? (Laughter and applause.) Will they wait until all the forests are denuded, until all the rivers are dried up, until commerce is paralyzed? Then we do not want their help. We want it now, and must have it.

"I want to say to this great Convention that it does seem to me that a resolution ought to be passed by this Convention, indorsed by every Governor of every state present, calling upon this present Congress to wait no longer, but even in the short session yet remaining, to pass this bill that means so much to the peace, happiness, wealth, power and glory of this great Nation in which we live. (Great applause.)

"*Vox Dei* is calling for the preservation of the forests for humanity's sake, for

health's sake. *Vox populi* is calling for the prevention of this waste for manufacturing purposes, for electrical purposes, for dam purposes, for commercial purposes—for all



Photo Copyright by Harris-Ewing, Washington

CONFERENCE CHAIRMEN

Govs. Noel, Dineen and Johnson
Secretary Shipp at center in rear

of these purposes. And *vox Dei* and *vox populi* together shall be heard, and must be heard, or else we will get a tribunal that will listen to the demand of this great American Nation, as year after year we come here, urging our members to do their duty to the great land in which we live today. (Great applause.)

"Men, Governors, Governors of the great West, our members have stood by you in your forest preservation; we have stood by you in your irrigation acts (applause); we have stood by you in every single thing for the upbuilding and the glory of this great Nation in which we live. And coming today, voicing the people's voice, the voice of Maine, New Hampshire, Rhode Island, Connecticut, Massachusetts; voicing the sentiment of Pennsylvania, West Virginia, Virginia, North Carolina, Tennessee, South Carolina, Georgia, Alabama, Mississippi, I plead with you and beg of you to come to our relief and join with us in helping to save the country from this waste and devastation. We will plant our crops, we will plant our grasses; but, sir, as long as floods continue to come tearing and rushing down our steep, unforested heights, into the val-

leys and rivers, the crops which we may plant are absolutely worthless.

"In conclusion, I want to answer one remark of Speaker Cannon, and that was this—that there ought to be confederation in the White Mountains, and in the Appalachian chain, and that we ought not to ask help of the Union—that confederation ought to be the means by which this waste is to be stopped.

"I cannot answer for New Hampshire or Rhode Island or Massachusetts, but I can answer for the South. We tried confederation once, and it did not pay (great applause). You told us to come into the Union, and then to ask for anything we wanted; and now that we have come into the Union, and make our request, do not rebuff us the first time we come and ask you for relief. (Great applause.)

"Thank God, as was said yesterday, that there is no North, no South, no East, no West. A Confederate son and soldier stands before you, who would die for his country and his state because he loves it. And that Confederate soldier is just as true to the Union as any man born in the North could possibly be." (Great applause.)

Following Governor Glenn, Hon. James O. Davidson, Governor of Wisconsin, spoke along the same lines. He said that to no state in the Union is the question of conservation of natural resources more vitally important than to the state of Wisconsin. Only a few decades ago, he said, the northern and eastern parts of Wisconsin were one broad forest, broken only by occasional stretches of prairie land. Pine, hemlock, oak, and maple grew in such abundance that it was the state's proud boast that Wisconsin alone could supply the whole country with timber for a century. Amid its great forests were swamps and hundreds of small lakes, from which deep, swift streams rushed to form the rivers that added their volume to the Mississippi. But, with its great forest wealth and its immense water power, Wisconsin, like its sister states, lived only in the immediate present.

"Great lumber companies," said Governor Davidson, "inspired only by an enthusiasm and a greed which knew no bounds, attacked these forests, engaging in a mad race each to strip its territory, to market its lumber first, and then to move forward and continue the destruction. No tree was regarded as too small to escape cutting. Trunks six inches in diameter were cut for

lumber. Millions of young trees and saplings, which were too small to have any commercial value, were crushed by falling timber, or were cut to make room for log-



SOUTHERN YELLOW PINE

Native to the Region of the Proposed
Southern Appalachian Forest

ging roads. Those that escaped the ax of the loggers fell victims to forest fires, the destruction by which can only be counted by the millions of dollars—a further melancholy evidence of the carelessness with which our forests tracts were guarded.

"To-day we are beginning to feel the penalty for this indifference. Our proud position as the greatest timber state of the Union has passed to others. Thousands of acres of land of no value for agriculture have been rendered bare and practically worthless; our swamps are drying up, and as a consequence many of our streams have shrunk to but a small proportion of their former size. The destruction of our forests has taken from us that great regulator of the streams, for with no forests to protect the head water of rivers and to detain the water upon the soil, we have frequent freshets and floods and are confronted with the problem of dealing with rapidly rising and falling stream volume—a condition which has already rendered many of our

one time valuable water powers practically worthless.

"Wisconsin has, however, awakened to its duty to the public; it created the first state forest commission ever appointed by any of the states, and this commission has already developed into a Board whose labors are characterized by a continuous and progressive policy of forest administration. Vast tracts of public lands have been made into state forest reserves. Agriculturally profitable land has been sold and the proceeds used to extend the resources in less fertile soil. The United States Government has added a large tract, aimed to protect the head waters of our large rivers; while lumber companies, at last recognizing the state's wise policy, have dedicated several thousand acres to the forest reserves. Wisconsin has acquired over 300,000 acres, and this acreage is constantly being extended. It has been the policy to concentrate these holdings in counties having the greatest number of lakes feeding into large streams, and in some counties the state now holds ten per cent of the entire land area.

"For the further protection of its water powers, the legislature has authorized corporations to erect series of reservoirs on certain streams, thus producing a uniform water flow throughout the season. The location of such reservoirs and dams, the height of dams, the amount of land which shall be overflowed, and the time and manner in which the stored water shall be released, is determined by the State Board of Forestry; and the law also provides that holders of such storage reservoirs shall be permitted to charge reasonable tolls for water used, provided a certain previously agreed upon storage capacity is realized—such tolls not to exceed a net annual return of 6 per cent on the cash capital actually paid in. The capital of companies such as these, and the rates charged, are under the strict regulation and supervision of the State Railroad Commission.

"Forestry is a new science in America, and no country has greater need for the adoption of its teachings. The state and National Governments still possess millions of acres of rich forests, a part of which should be preserved for the benefit of future generations. The public forests must be protected for the benefit of the public, enlarged as conditions permit. When timber shall have ceased to be possible for fuel purposes, when coal beds have approached exhaustion, it is in our great forest tracts that we will find conservators of the substitute for fuel—water power—and, in addition, such forest tracts will rank as a most prolific source of public revenue."

Upon motion of Governor Folk, the morning session then adjourned.

AFTERNOON SESSION

At the opening of the afternoon session, former Governor Pardee, of California, addressed the Conference. Dr. Pardee had prepared a paper in advance, but on taking the platform he stated that he had consigned his written remarks to his pocket, and that his talk would be purely extemporaneous.

Dr. Pardee stated that on his trip to Washington from California he could not help noticing that the same conditions exist clear across the country; that forests are disappearing, mines are being exhausted, rivers that are naturally great arteries of commerce are deserted, their surface practically unrippled by the wheels of steamboats, and that none of the states which he crossed on his journey seemed to be taking any steps to correct this condition. He stated that Mr. James J. Hill recently told the country that five billion dollars would be required to put the country's railroads into shape to handle all the business that is offered them, and if the population and the business of the country increases in the future as rapidly as it has in the past, that five billion dollars will not do the work. And yet, he said, experts say that one half a billion (\$500,000,000) will put the waterways and the harbors of the country in a condition to handle the excess of the country's commerce.

Continuing, Dr. Pardee said:

"Here before me I see the Governors of almost all the states of the Union. Here in the capital of the Nation sits the Nation's Congress, within reach of your voices, within a few minutes' walk, within five minutes on the cars, by which you can go and tell these legislators what we desire and what the people of this country ought to have, and must have. (Applause.) I notice the instantaneous applause which greets every reference to the country's inland waterways, and I take it that you agree with me that, first of all, the waterways should be preserved. In order to do that the forests must be taken care of, and, as you have been told so many times to-day and yesterday, and will be told to-morrow, the care of our forests is the thing upon which all our

deliberations and all the things we are here to discuss absolutely depend. (Applause.)

"Here, on the platform, five or six pictures will be shown within the next five minutes. These pictures represent the work of the Reclamation Service in the West and Southwest. Out there dams are being built to store the waters of the rivers, so that water may be turned upon the millions of acres of arid and semi-arid lands, where, in time to come, the great civilization of this land, and therefore of the world, will be congregated. There, upon a few irrigated acres, a family of American children may be raised and given the benefit of both country and urban civilization. The time is near when the American people, instead of demanding 160 acres, will be, and must be, content with a much smaller acreage; and it is the work of the Reclamation Service that will bring this about. I am told that the Service has already opened waterways and ditches, which, if joined end to end, would reach from San Francisco to Denver (Applause.) And yet they have only made a beginning. (Applause.)

"Gentlemen, is not the time for talking gone by? Has not the time arrived when the representatives of 80,000,000 people here assembled shall show to Congress and to the people of the country that we must have the things which we are here discussing? (Applause.) That we must have the forests renewed, must have the inland waterways preserved, deepened and made capable of taking care of the country's growing commerce? (Applause.) Must have the arid and semi-arid West and Southwest taken care of, for the overflow of the agricultural population which is now heading, I am alarmed to say, too much to the cities—must have all these things taken care of in a wise and beneficent way? (Loud applause and cheers.)

"Perhaps it would be revolutionary: perhaps it might not be the thing to do; but if I were a governor instead of an ex-governor, I would suggest that my colleagues from the various states meet with the Committee on Agriculture of the House of Representatives, and show that Committee, by the presence of the Governors of forty-four states, that what this Conference talks about it means, and what it means it wants, and what it wants, it ought to have. (Applause and cheers.)

"We have a way of doing things in California. My native city, but two years ago swept by the flames of a great conflagration, lay prostrate in the dust; but within those two years it has almost rehabilitated itself. Here are forty-four Governors who can take themselves to Congress and by their presence and influence have Congress rehabilitate the natural resources of the country which have been so shamefully laid waste." (Loud applause.)

At the conclusion of Dr. Pardee's talk Governor Denceen of Illinois, took the chair, President Roosevelt retiring.

A paper prepared by H. A. Jastro of Bakersfield, Cal., president of the American National Live Stock Association, was read by Mr. William C. Barnes, Mr. Jastro having been taken suddenly ill and being unable to deliver the address himself.

Mr. Jastro's paper was confined in the main to grazing and stock raising conditions in New Mexico, Arizona, and California. In that region, it was stated, there are at present over 8,000,000 head of sheep, nearly 3,000,000 head of cattle, and about 700,000 head of horses and mules, the gross estimated value of which is over \$100,000,000. This live stock is supported almost wholly upon the the open grazing lands in the region mentioned, the grazing area being about 135,000,000 acres. This range, it was stated, is fast being destroyed by unwise and indiscriminate use and abuse. The only exception to this statement that can be noted is on the lands which have been withdrawn for purposes of forest protection, and on such lands a wise and efficient system of management is rapidly and almost miraculously restoring former splendid grazing conditions.

Mr. Jastro's paper referred to the stories of range wars and feuds that are said to have existed between cattle and sheep men from the beginning of grazing on the open range; and reference was also made to the disastrous conditions that have come about through over-grazing and over-stocking the range, resulting in the trampling out and practical extinction of many of the native forage plants.

Referring to conditions governing water supplies, it was stated that it is beyond contradiction that forested slopes surrounding the head waters of streams exert a tremendous influence in equalizing stream flow throughout the year, and thus provide ample irrigation waters during the summer months. The extension of forest re-

serves, and an intelligent conservation of wooded, brushy slopes, has already saved thousands of dollars to the stockmen and the irrigation farmers of the arid and semi-arid regions, he said, and the good results that can be attained by methods such as are followed by the Forest Service and the Reclamation Service can only be measured by the extent of the new work which these Services are enabled to complete.

Mr. Jastro's paper closed with the statement that the entire situation in the arid regions can, at present, best be dealt with by the General Government, and, referring again to grazing conditions, the statement was made that unless a just and equitable law is promptly passed, authorizing Federal protection and control of the public grazing lands, the native grasses will soon be completely trampled out through over-stocking, and hence the beneficial use of such lands by stockmen for grazing purposes will be very materially curtailed.

Hon. Joseph W. Folk, Governor of Missouri, then addressed the Conference, making the initial suggestion that resulted in the inauguration of the movement to form a permanent organization of the Governors.

Governor Folk declared that the Conference would be world-wide in its influence. He said that at no time in the Nation's history would it have been possible for so many Governors to meet together. Prior to the Civil War, he said, transportation facilities were inadequate; and after the war the sectional feeling for so long a time was such as to make a meeting of this kind impossible. "But now," he said, "we have met here together as members of one large family. In looking at the map, I have been impressed with the fact that the states of this Union are, after all, closely connected by blood and in interest. Tennessee, my native state, is largely made up of people from North Carolina and Virginia; Missouri, my adopted state, composed largely of Kentuckians,

Tennesseans and Virginians; Texas, made up, in the main, of Missourians and Tennesseans, and Oklahoma, whose citizens are principally Texans and Kansans. And so it is, all over this broad land; our American states are united by blood, united in purpose, and joined together by patriotic bonds to a common country. (Applause.) It does not matter so much where a man is from as what that man is. In Kipling's words:

"There is neither East or West—
Border, nor breed, nor birth—
When two strong men stand face to face,
Though they come from the ends of the
earth."

After referring briefly to the situation in Missouri as regards coal, iron and other minerals, Governor Folk aroused a tremendous burst of applause by the declaration that "the forestry question is our problem, and it is a problem that we must settle, and settle soon. The waterways question is our problem, and if we do not settle it we will fail of our duty, not only to the present generation, but to those who may come after us."

Continuing in this vein, the Missouri Executive said:

"Governor Glenn this morning spoke of a bill before Congress in reference to forests and waterways. I want to indorse what Governor Glenn said. That bill ought to pass. (Applause.) Governor Glenn spoke of *vox populi, vox Dei*. But there is a new voice in the land—a voice that was not contemplated by the Fathers of this Republic—*vox Cannoni*. (Applause and laughter.) This later voice has often proven more powerful than *vox populi*, and it sometimes seems that it has been thought greater than *vox Dei*.

"We want to put our forests in proper condition to preserve the timber we have, and we want to adopt a comprehensive scheme of reforestation. I am sorry to say that in Missouri we have no State Forester; but as soon as I go back home I intend to appoint a State Forestry Commission. (Applause and cries of "Good! good!") I believe that every Governor ought to do the same thing, and I am sure that every legislature, when it meets, will ratify such action. We want to preserve our forests. I hope I am not treading on forbidden ground, but I have been wondering why, with the necessity for forest preservation, it would not be

a good thing to put lumber on the free list. (Great applause.) I hope this is not heresy. It seems to me that, for every foot of lumber brought to us from another country we preserve a foot of lumber in our own forests." (Applause.)

Governor Folk then turned to the subject of improvement of inland waterways. He referred to the Missouri River, stretching clear across his state. As it is a navigable stream, he said, it belongs to the Federal Government. The states, he said, cannot undertake the work of improving such streams without obtaining the consent of the Government. If the Government does not care to undertake the permanent improvement of the Missouri River, he went on, and if the consent of the Government is granted, Missouri is willing to undertake the work, provided that, by act of Congress, Missouri is given the right to use the water power generated by the river. Applause followed his announcement that Missouri would undertake to do this work and to pay for it out of the revenues derived from the sale of the water power; and not only that, but to run the state government out of such revenues also. And, he stated, he believed that every state through which courses a navigable stream could and would undertake the same work, under similar conditions.

Governor Folk was followed by Governor Osborne, of Michigan, whose announcement that the Senate Committee on Interstate Commerce had favorably reported the bill for the perpetuation of the Inland Waterways Commission brought forth a round of cheers and hand-clapping. Practical results, stated Governor Osborne, were expected from the Conference; and among the practical results already obtained were the announcements by Governor Folk and others that they intended immediately to appoint State Forestry Commissions; and he pleaded for the same action on the part of every Governor present whose state has not already such a Commission.

Governor Cutler, of Utah, then spoke. He said that Utah has at pres-

ent eighteen National Forests, with a total area of 7,415,832 acres, and that it was estimated that in addition to this it would be well to place under Government supervision about 1,500,000 acres of forest lands, all of the forested areas, he said, lying high up in the mountains. About one-half of this latter 1,500,000 acres, he stated, is privately owned, and cannot be obtained by the Government except by purchase. He stated that it is the experience of every one in Utah that, from every point of view, it is desirable that the forest reserves be kept intact. Reforestation, to remedy the devastation wrought in former years by disastrous forest fires, is going on in Utah, he stated, adding that he understood that the Government nurseries of Utah have now over two and a half millions of seedling trees that will be ready for transplanting next year.

In view of the fact that Utah is a state wherein exist very extensive grazing and stock-raising interests, Governor Cutler's advocacy of a law for range regulation was most interesting. He stated that the question of grazing is a vexed one, but that he believes it would be well to restrict the number of head of live stock to be grazed on the ranges and in the National Forests to the actual carrying capacity of such ranges, and that if this is done the ranges, etc., will be maintained in their present good condition. Some measure such as that introduced last winter by Senator Burkett, of Nebraska, providing for Federal supervision of the range, and the establishment of a leasing system, would, he thought, bring about nothing but beneficial results.

Governor Cutler referred to the work of the Reclamation Service on the Strawberry Project, in Utah, saying that he was convinced, after a recent visit to this project, of the wisdom of entrusting such works to the Government. The Strawberry Project will, he said, reclaim 60,000 acres of land, at a cost of about \$40 an acre, but making the land worth over

\$100 per acre; and he said he considered this a good investment. He referred to the efforts of President Roosevelt to save from vandalism the scenic marvels of Utah, by setting aside the land surrounding the three great natural bridges of the State as National Parks, these lands containing also ruins of cliff-dwellers' houses, and canyon walls covered with the hieroglyphic picture-writing of the extinct, unknown races that once peopled the western country. Summing up, he said that it is the laudable desire of President Roosevelt and his associates to do everything possible in the way of conserving those natural resources the country possesses, for the benefit not only of the people who now enjoy them, but also for the generations yet unborn, and he concluded with the declaration that, so far as he was concerned, he intends to give his loyal support in the undertaking.

Governor Gooding, of Idaho, and Governor Norris, of Montana, in brief talks that bristled with figures and coruscated with Western enthusiasm, told of the work that is being done in their States toward reclaiming desert and arid lands. Both spoke of the work of the Reclamation Service in the highest terms; both declared, however, that the work being done by the states, under the Carey Act, was far greater in amount and value than the work of the Government. The plea of both speakers was for the adoption of some plan whereby the states themselves could carry on the work of forest conservation, reclamation, etc., unhindered by the Government. Governor Norris added to the enthusiasm of the session by declaring that he intended to follow the example of Governor Folk and appoint a State Forestry Commission immediately upon his return home.

Dr. James, president of the University of Illinois, told the Conference that the statesmen of the country, from President Roosevelt on through the list, are today taking up and incorporating into the political economy

of the Nation ideas that were advocated by men of science thirty years ago. It was his optimistic opinion, however, that no such waste as had been alluded to by previous speakers had existed in this country; or, if it did exist, it was not really waste, but the simple methods that, instinctively adopted by the early settlers of the country, had proven themselves in the main correct. He said that the fact that farms of the East have passed out of cultivation is not necessarily an indication that those farms have lost their productive power, but, rather, that they have been abandoned because of the opening up of broader fields of usefulness in the regions beyond the Mississippi and the Missouri, and he said he believed that, after all is said and done, the greatest natural resources the country possesses is not its forests, its rivers, its mines or its soil, but in the brains of its people.

Hon. James R. Garfield, Secretary of the Interior, was called upon for a talk, and responded in a manner that drew from the conferees repeated expressions of approval.

Secretary Garfield said that it is only within recent years that the Nation has felt the need of extending, by means other than those nature gave us, the areas where men could build homes. Such necessity, he said, has now arisen; lands that can be farmed, if water for irrigation can be supplied, are being given this water, and the cultivable area of the western states is rapidly being enlarged, this enlargement necessarily tending to wipe out, for some purposes, the boundaries between states. Such obliteration of state lines does not, however, mean that the states are going to lose any of their inherent rights.

Referring to the question of forest reserves in the West, Secretary Garfield said:

"It has been suggested that in the Western forest reserves that which has been attempted by the Federal Government may not be along the right lines. We do not for a moment maintain that the final word has

been said, that the ideal law has been passed, or that the regulations adopted cannot be improved. In regard to the question put by the Governor of Montana—I believe, something to this effect: 'Why should the Federal Government charge in the forest reserves those people who are using the forests; why should not the work in the reserves be paid for by the Government as a whole, rather than by the imposition of charges upon those who use the reserves?'—I will answer that question with another: Why should a great resource, which is owned by the people at large, be used by private interests, by somebody who is looking only to his own benefit, and not the benefit to the people of the whole country? (Applause.) That applies not only in the forest reserves, so far as grazing is concerned, but it applies equally well to the use of the water powers of this country, (Applause), first, in the conservaion, and then in the use of such water powers. (Applause.)

"The people as a whole own these natural resources and it is for them to determine whether the resources shall be used for the benefit of all, or be turned over to be used without regulation for the benefit of whoever may happen first to get a foothold in any special locality." (Applause.)

Secretary Garfield said that as he listened to the addresses, he had reached the conclusion that the keynote was practically the same throughout—that it was simply a question as to how we can best work out the problems that confront us. He stated that his idea of conservation was the highest possible development, year by year, to meet the needs of the country's growing population; such development to be for the people as a whole, and not for the enrichment, by monopolization, of individual or corporate private interests.

Professor Burnett, director of the Nebraska Agriculture Experiment Station, was the next speaker, his address dealing with the topics of soil conservation, the extension of scientific methods of cultivation, and the determination of crops that may profitably be grown under what would ordinarily be considered 'unfavorable conditions. He made a plea for the extension of agricultural education in all of the states in order that the natural resources of the farm may be built up through intelligent handling of the soil.

Mr. W. S. Harvey, of Philadelphia, designated as representative of the American Forestry Association by the Association's president, Hon. James Wilson, spoke on behalf of the American Forestry Association, the Committee on Forestry and Irrigation of the National Board of Trade, and the State of Pennsylvania. He paid a deserved tribute to Mr. Wilson and Mr. Pinchot, stating that he has drawn his inspiration for the protection and intelligent use of the forests and waterways from these two men.

He stated that the Forestry and Irrigation Committee of the National Board of Trade in January, 1906, made a report to Congress embodying information gathered by the Committee from the General Land Office. The Committee was advocating the repeal of the Timber and Stone Act.

He said that under this act 5,000,000 acres of the most valuable timber land belonging to the United States was sold from 1901 to 1906 at the rate of \$2.50 an acre, and that thus, for \$13,000,000, the United States parted with lands actually worth more than \$100,000,000. The law that made this possible, he said, the National Board of Trade and the American Forestry Association has been trying to have repealed, but so far little headway has been made.

Mr. Harvey said that the State of Pennsylvania has acquired for State forest reserves 900,000 acres of land, and the State is planting this year 400,000 white pine seedlings. In the state reserves, Mr. Harvey said, sanitariums for the use of sufferers from tuberculosis were being established, the State having last year appropriated \$600,000 for such sanitariums. This he called special attention to as an admirable feature of the work that is being done by Pennsylvania.

Mr. Harvey read a copy of a dispatch sent on the 5th of May to Speaker Cannon—"a cannon," he said, "that many of us wish might be spiked."—in regard to the forestry question:

"Forest reserves of the South and East are vital for the preservation and perpetuation of our waterways, for transportation and protection of cheap power, and essential to the extension of foreign trade, if we are to maintain the American wage level in competition with other manufacturing nations. The Leever Bill, I believe, is consistent with the Constitutional requirements of the House Judiciary Committee, and satisfactory to the friends of waterways and forests. Will you not exert your influence and power at this psychological time for a wise and perpetually beneficent cause that is earnestly advocated by more than fifty million Americans?"

The country, he said, knows what course Speaker Cannon chose to take.

He commented on the development of water power in the south and east that will be made possible by the establishment of national forests in the southern states and in the New England regions, saying that in the southern states alone development of the maximum possible water power would amount to a saving to the people of the Southern Appalachian and tributary regions of \$45,000,000 annually. He urged that Congress be petitioned so frequently and forcibly that it would be obliged to listen to the voice of the people in behalf of the preservation, conservation, and utilization of the country's great natural resources.

Governor Burke, of North Dakota, and Mr. W. G. Jones, of Texas, contributed to the general discussion, and at 5.25 o'clock P. M., on motion of Governor Noel, the session adjourned.

Following adjournment, and in pursuance of the suggestion made by Governor Folk, a number of the Governors met to take preliminary steps toward perfecting a permanent organization. About twenty Governors took part in this preliminary meeting, and before the meeting came to a close, "The House of Governors" had been launched. A meeting to be held in the coming autumn, either at St. Louis, or Chicago, was decided upon; Governor Swanson of Virginia, and Governor Willson of Kentucky, were chosen as the nucleus of an executive

committee and empowered to appoint five other Governors to act on the same committee; and this executive committee will hold a meeting during the early summer to elaborate further the plans for the first gathering of the new "House of Governors."

In commenting on this organization, Governor Folk, who stands as the father of the movement, said:

"One hundred years from now the House of Governors will be looked upon as one of the greatest factors in the Government and development of the United States. It will cement the states of the Union as they have never been cemented before. The value of the work that such an organization can do cannot be over-estimated. While the body will have no legal standing, and will, therefore, be in no position to dictate what laws shall, or shall not, be passed by the various legislatures, it is, nevertheless, true that recommendations made by the Governors would undoubtedly be enacted into law. In this way, many problems which now prove troublesome, would be solved. We could easily deal with uniform divorce laws, railroad legislation, and other such matters of interest outside the borders of any one state. There will be no conflict between the action of the Conference, in placing the power in the hands of the President to call the next meeting of

Governors to discuss the conservation of natural resources, and that of the committee which proposes to call a meeting of the Governors to discuss all matters of common interest. We will work in harmony, and our object is simply to broaden the scope of the work of the proposed meeting."

As has been stated, Governor Folk really stands as the sponsor for the new movement. He, and others among the Governors, felt that the proposition for assembling a conference of the Governors on call of the President left matters too indefinite; and it was also felt that such conferences as might be called by the President, while they might work efficiently toward handling problems of general conservation, would not feel like dealing with other problems, such as an organization like the House of Governors might wish to take up.

The matter of temporary organization was left in the hands of Governors Willson and Swanson, though it was regarded as practically settled that Governor Folk would be made a member of the permanent executive committee.

THIRD DAY'S SESSION

At the opening of the session of Friday, May 15th, Governor Blanchard read the report of the Committee on Resolutions. He stated that this report is not really in the form of a set of resolutions, but rather was designated to express the views and recommendations of the Conference.

"We, the Governors of the states and territories of the United States of America, in conference assembled, do hereby declare the conviction that the great prosperity of our country rests upon the abundant resources of the land chosen by our forefathers for their homes and where they laid the foundation for this great Nation.

"We look upon these resources as a heritage to make use of in establishing and promoting the comfort, prosperity, and happiness of the American people, but not to be wasted, deteriorated, or needlessly destroyed.

"We agree that our country's future is involved in this; that the great natural resources supply the material basis upon which our civilization must continue to de-

pend, and upon which the perpetuity of the Nation itself rests.

"We agree, in the light of facts brought to our knowledge and from information received from sources which we cannot doubt, that this material basis is threatened with exhaustion. Even as each succeeding generation, from the birth of the Nation, has performed its part in promoting the progress and development of the Republic, so do we in this generation recognize it as a high duty to perform our part, and this duty, in large degree, lies in the adoption of measures for the conservation of the natural wealth of the country.

"We declare our firm conviction that this conservation of our natural resources is a subject of transcendent importance, which should engage unremittingly the attention of the Nation, the states, and the people in earnest co-operation. These natural resources include the land on which we live, and which yields our food; the living waters which fertilize the soil, supply power, and form great avenues of commerce; the forests which yield the materials for our homes, prevent erosion of the soil, and conserve the navigation and other uses of our streams; and the minerals which form the

basis of our industrial life, and supply us with heat, light, and power.

"We agree that the land should be so used that erosion and soil wash should cease, that there should be reclamation of arid and semi-arid regions by means of irrigation; that the waters should be so conserved and used as to promote navigation, to enable the arid regions to be reclaimed by irrigation, and to develop power in the interests of the people; that the forests, which regulate our rivers, support our industries, and promote the fertility and productiveness of the soil, should be preserved and perpetuated; that the minerals found so abundantly beneath the surface should be so used as to prolong their utility; that the beauty, healthfulness, and habitability of our country should be preserved and increased; that the sources of national wealth exist for the benefit of the people, and that the monopoly thereof should not be tolerated.

"We commend the wise forethought of the President in sounding the note of warning as to the waste and exhaustion of the natural resources of the country, and signify our appreciation of his action in calling this Conference to consider the same, and to seek remedies therefor through co-operation of the Nation and the states.

"We agree that this co-operation should find expression in suitable action by the Congress within the limits of, and co-extension with the national jurisdiction of the subject, and, complementary thereto, by the legislatures of the several States within the limits of, and co-extensive with, their jurisdiction.

"We declare the conviction that in the use of the natural resources our independent States are interdependent and bound together by ties of mutual benefits, responsibilities, and duties.

"We agree in the wisdom of future conferences between the President, members of Congress, and the governors of the States on the conservation of our natural resources with the view of continued co-operation and action on the lines suggested. And to this end we advise that from time to time, as in his judgment may seem wise, the President call the governors of the states, members of Congress, and others into conference.

"We agree that further action is advisable to ascertain the present condition of our natural resources, and to promote the conservation of the same. And to that end we recommend the appointment by each State of a commission on the conservation of natural resources, to co-operate with each other and with any similar commission on behalf of the Federal Government.

"We urge the continuation and extension of forest policies adapted to secure the husbanding and removal of our diminishing timber supply, the prevention of soil erosion, the protection of headwaters, and the

maintainance of the purity and navigability of our streams. We recognize that the private ownership of forest lands entails responsibilities in the interests of all the people, and we favor the enactment of laws looking to the protection and replacement of privately owned forests.

"We recognize in our waters a most valuable asset of the people of the United States, and we recommend the enactment of laws looking to the conservation of water resources for irrigation, water supply, power, and navigation, to the end that navigable and other streams may be fully utilized for every purpose.

"We especially urge on the Federal Congress the immediate adoption of a wise, active, and thorough waterway policy, providing for the prompt improvement of our streams and conservation of their watersheds required for the uses of commerce and the protection of the interests of our people.

"We recommend the enactment of laws looking to the prevention of waste in the mining and extraction of coal, oil, gas, and other minerals with a view to their wise conservation for the use of the people, and to the protection of human life in the mines.

"Let us conserve the foundations of our prosperity.

"Respectfully submitted,

"NEWTON C. BLANCHARD.

"JOHN F. FORT.

"J. O. DAVIDSON.

"JOHN C. CUTLER.

"M. F. ANSEL."

Commenting on this report, Governor Blanchard said that the Committee, while endeavoring to make its report broad, liberal, and of national scope, had tried also to limit its declarations to subjects concerning the conservation of natural resources. He said that he had long thought if the Governors of the several States could meet from time to time and exchange ideas on Governmental affairs and affairs of their states, much good would come of it. He said that the problems of conservation were proper subjects for the fullest co-operation between the states of the United State, and on his motion the resolutions were adopted.

Following this, Honorable William Jennings Bryan addressed the conference. He said, in part:

"I hesitate to speak at all, because the Governors who are assembled here repre-

sent constituencies, and those constituencies, well marked, are looking to them for the protection of state interests in conjunction with the development of National interests, and I recognize that a private citizen like myself with no fixed constituency (laughter and applause) speaks, if he speaks at all, either for himself or for a nebulous portion of the Nation. I recognize that such an one is not only under the same obligation that the Governors are, but that he speaks with less authority; and I have been anxious that those who were in official position should discuss these questions and leave to us unofficial visitors the bringing up of the rear end, so to speak, of the discussion. * * *

"I acknowledge my obligation to President Roosevelt for the opportunity which he has given me to participate in this meeting. The Conference marks the beginning of a new era, during which increasing attention will be given to the far-reaching problems involved in the conservation of the Nation's resources. (Applause.) The epoch-making speech with which the Chief Executive opened the first session must exert a powerful influence upon the country at large, as it has upon those who were fortunate enough to hear him. * * *

"I am a strict constructionist, if that means to believe that the Federal government is one of delegated powers and that constitutional limitations should be carefully observed. I am jealous of any encroachment upon the rights of the states, believing that the states are as indestructible as the union is indissoluble. It is, however, entirely consistent with this theory to believe, as I do believe, that it is just as imperative that the general government shall discharge the duties delegated to it, as it is that the states shall exercise the powers reserved to them.

"There is no twilight zone between the Nation and the State, in which exploiting interests can take refuge from both, (great applause), and my observation is that most—not all, but most—of the contentions over the line between Nation and state are traceable to predatory corporations which are trying to shield themselves from deserved punishment, or endeavoring to prevent needed restraining legislation. The first point which I desire to make is that earnest men, with an unselfish purpose and concerned only for the public good, will be able to agree upon legislation which will not only preserve for the future the inheritance which we have received from a bountiful Providence, but preserve it in such a way as to avoid the dangers of centralization. Nothing that is necessary is impossible; and it would be a reflection upon the intelligence, as well as upon the patriotism of our people, to doubt the value of gatherings of this kind. * * *

"I begin with the proposition that it should be our purpose, not only to pre-

serve the Nation's resources for future generations by reducing waste to a minimum, but that we should see to it that a few of the people do not monopolize that which is in equity the property of all the people. (Applause.) The earth belongs to each generation, and it is criminal to fetter future generations with perpetual franchises, making the multitude servants to a favored faction of the population, as it would be to impair, unnecessarily, the common store. (Applause.) I am glad that Secretary Garfield emphasized this point. It is one that must always be kept in mind by the Nation and by the several states. * * *

"I was surprised at the statistics given in regard to our coal and our iron ore. While it is possible that new coal measures and new ore beds may be discovered, we cannot afford to base our conduct upon speculations as to what may yet be discovered. We should begin an intelligent supervision and conservation of that which is known to exist, and I respectfully submit that it is worth while to ask ourselves whether we can afford to offer a bounty to those who are engaged in exhausting the supply of raw materials, which, when gone, cannot be replaced. Surely if there is any importation which we can properly encourage by a free list, it is the importation of those raw materials of which our own supply is limited. (Applause.) And what I say in regard to coal and iron ore is equally applicable to timber.

"It is hardly consistent to discourage the importation of lumber, while we worry about the devastation of our forests.

"Mr. Hill has rendered the Conference a real service in presenting the facts and statistics set forth in his address on land and its cultivation. Few of us, probably, were conscious of the impairment of the crop value of our soil. I am sure that a clear understanding of this subject will lead to a still further enlargement of the work of the Department of Agriculture and to still closer co-operation between the Department of Agriculture and the States in teaching economical methods of agriculture. (Applause.) Already the rapid growth of the agricultural college offers encouragement and I am glad to express my appreciation of the valuable work done by Secretary Wilson and his associates in bringing to our country fruits, plants and grasses suited to the different parts of our country. As the farmer pays more than his share of the taxes and receives less than his share of the direct benefits which flow from national appropriations, it is only justice to him that we shall be liberal in the support of every effort put forth for the improvement of agriculture. (Applause.)

"Irrigation has justified the arguments which led to the inauguration of the work. No one who has witnessed the transformation of the desert into field and gar-

den can doubt the wisdom of the steps that have been taken. Here, as elsewhere, both the Nation and the State can find a field for legitimate activity, and I am sure that there will be a continuation of this work until all of the waters which can be utilized for that purpose have been appropriated. * * *

"The same principle which was invoked in support of irrigation can be invoked in support of drainage. The question is not whether the water should be brought upon the land or taken off the land; it is whether the land shall be made tillable and its wealth-producing qualities utilized. Drainage of the swamps is, therefore, as legitimate a work as the reclamation of arid wastes.

"No subject has been brought out more prominently at this Conference than the subject of forestry, and it justifies the time devoted to it, for our timber lands touch our national interests at several points. Our use of lumber is enormous, but immense as would be the inconvenience and loss caused by the absence of lumber, the consequence of the destruction of our forests would be still more disastrous to the Nation. As has been shown, the timber on our mountain ranges protects our water supply. Not to speak of changes in climate which might follow the denuding of our mountains, the loss to the irrigated country could not be remedied and the damage to the streams could not be calculated. And if this is not enough to arouse the interest of all, I may add that the destruction of the forests on the mountain ranges would in time impair the underflow upon which we rely for our well water.

"The good effects of this Conference are already apparent in the determination expressed by several governors at once to appoint Forestry Commissions and begin such work as the state can do. (Applause.) In this case action is so urgent and the field to be covered so large that both the Nation and the several states can exercise themselves to the full without danger of doing too much. (Applause.) The national reservations already made in the West, and the new reservations that ought to be made, and are likely to be made, in the White Mountains and in the Appalachian Range can doubtless be so administered as to protect national interests without unduly burdening the states in which the reservations are located, or needlessly interfering with the development of the states. No national policy need retard the development of the western states, and their own interest should restrain them from sacrificing future wealth and protection for temporary advantage.

"Lastly, I come to our interior waterways. I shall not defend the improvement of these waterways on the ground that such improvement would help to regulate the railroad rates, although it would aid regulation; for whenever the people are ready,

they will exercise the power which they have. But water traffic is less expensive than traffic by rail, and there are many commodities which can be transported much more cheaply by water than they possibly could be carried by land. I believe it has been estimated that an expenditure of \$500,000,000 on interior waterways would result in a saving of nearly \$200,000,000 annually.

Just a word in conclusion about an investment in permanent improvements. Money spent in care for the life and health of the people, in protecting the soil from erosion and from exhaustion, in preventing waste in the use of minerals of limited supply, in the reclamation of deserts and swamps, and in the preservation of forests still remaining and the planting of denuded tracts—money invested in these and in the development of waterways and in the deepening of harbors is an investment yielding an annual return. If any of these expenditures fail to bring a return at once the money expended is like a bequest to those who come after us. And as the parent lives for his child as well as for himself, so the good citizen provides for the future as well as for the present. This gathering will be remembered by future generations, because they as well as ourselves will be the recipients of the benefits which will flow from this Conference. We have all been strengthened by communion together; our vision has been enlarged and the enthusiasm here aroused will permeate every state and every community." (Great applause).

At the conclusion of Mr. Bryan's address, the peroration of which elicited tremendous bursts of applause, President Roosevelt stepped quickly across the platform and shook the Nebrakan heartily by the hand. When the enthusiasm had subsided, Judge Goudy, President of the National Irrigation Congress, invited all present to attend the sixteenth session of that organization at Albuquerque, New Mexico, September 29th to October 3d.

Hon. B. B. Comer, Governor of Alabama, was recognized and made a short talk, following the President's suggestion that those governors who had not been heard be called on for their contribution to the discussion. Governor Comer dwelt on the resources of Alabama and on the state's waterways, saying however, that his sentiments were much the same as those of Governor Folk, and that he hesitated to take a stand for turning

over the control of waterways and resources to the National Government.

President Roosevelt came into the discussion with a forcible statement along the lines brought out in the remarks of the different governors. Illustrating the stand taken by the Federal Government, the President said:

"My position has been simply that where a privilege, which may be of untold value in the future to the private individuals granted it, is asked from the Federal Government, the Federal Government shall put on the grant a condition that it shall not be a grant in perpetuity. (Applause.) Make it long enough that the corporation shall have an ample material reward. The corporation deserves it. Give an ample reward to the captain of industry, but not an indeterminate reward. (Applause.) Put in a provision that will enable our children at the end of a certain specified period, to say what, in their judgment, should be done with any great natural power which is of use to the grantee only because the people as a whole allow him to use it. It is eminently right that he should be allowed to make ample profit from his development of it, but make him pay something for the privilege, and make the grant for a fixed period, so that when the conditions change, as in all probability they will change, our children—the Nation of the future—shall have the right to determine the conditions upon which that privilege shall then be enjoyed. (Applause.)

"Where that policy can best be carried out by the states, carry it out by the states; where it can best be carried out by the Nation, carry it out by the Nation. My concern is not with the academic side of the question. My concern is in the employment either of the state rights or the principle of National sovereignty, as it will best conserve the needs of the people as a whole. (Applause and cheers.)

Hon. A. E. Mead, Governor of Washington, followed the President, and brought up a subject that had not before been mentioned—the conservation of the resources upon which a very important northwestern industry depends, the fisheries industry. He said that the salmon industry of the northwest is of tremendous importance to the people of that part of the United States, and he spoke for the enactment of laws that would protect that industry, both for the sake of the State of Washington and the territory of Alaska.

Hon. J. Frank Hanly, Governor of Indiana, followed with a series of interrogations, saying that they were submitted as an appeal for information along certain lines of conservation. He wanted to know if the program of conservation meant the imposition of limitations upon production of coal, lumber, etc., and asked, if this is the case, would it not mean putting limitations upon the industrial life of the Nation. He expressed his full sympathy with the purposes of the Conference, and stated that his remarks were made solely for the purpose of gaining information, and not in a spirit of opposition or criticism.

Hon. Augustus E. Willson, Governor of Kentucky, presented some facts in regard to the utilization of natural resources in his State. Referring to Mr. Mitchell's statement in regard to the loss of life attendant upon coal mining operations, he said that one of the big coal companies of Kentucky has produced in the last ten years 1,100,000 tons of coal with the loss of only one life. This coal company, he said, owns or controls great areas of land, and on its land the company, unaided, has planted 1,000,000 black walnut trees and a quarter of a million other trees.

He spoke of Kentucky's interest in the improvement of the country's waterways and said that no other State in the Union realized more fully the importance of a rational and practical development of a system of inland water transportation.

Hon. Edward W. Hoch, Governor of Kansas, expressed the interest of the Sunflower State in the problem of conserving and extending the nation's inland waterways. He said that he had been deeply impressed with the mutuality of interest which had developed in the Conference. "California," he said, "cannot say to Florida or to Colorado, 'we have no need of thee', and Maine cannot say to Texas, 'we have no need of thee'. We are mutual in interest, and this Conference has cemented our Union as nothing has ever done before."

Governor Sheldon, of Nebraska, spoke on the excellent work being done by the agricultural experiment stations in his State. He said that in Lancaster county, Nebraska, for the last five years, the yield of corn has been thirty-five bushels per acre. Yet the corn raised under the direction of the agricultural experiment station located in that county, under the same conditions and the same circumstances, but in accordance with the teachings of science, has yielded seventy-six bushels to the acre for the last five years. He said that these object lessons are something that the farmers of the country cannot argue down or get around; and he continued with a plea for the extension of this line of governmental work. Reforestation and the planting of new forests, he said, was also a vitally important work, and he urged that individual and State co-operation be given the National Government in its work along this line.

Lieut. Governor Davidson, of Texas, spoke on the natural resources of that State and urged the extension of a system of water conservation for irrigation and power purposes in the mountainous regions of western Texas. Mr. William Loudon, Iowa, spoke briefly in a general summing-up of the proceedings of the Conference; and

Mr. Bryan presented the following resolutions.

Resolved: That this Conference records its deep regret that Ex-President Cleveland is prevented by sickness from participating in this historic meeting; and that, extending to him a cordial greeting, it expresses a sincere wish for his speedy recovery."

After a brief discussion, at the close of which it was decided to print the proceedings of the Conference in full, Governor Blanchard said:

"With profound appreciation of the great work that this Conference has accomplished, I do now move that the Conference adjourn sine die."

Before putting the motion, President Roosevelt said:

"Let me extend a word of thanks to all of you, to the Governors and the other guests for coming here. The White House has held many distinguished gatherings in its day. I do not believe it has ever held as distinguished a gathering as this, composed of executives and representatives of the executives of all of the States of the Union. I thank you for coming; and I can assure you that at least no body of guests has ever been more welcome than you have to the White House."

Thereupon, at 1:30 o'clock P. M., the Conference stood adjourned.



THE FOREST LESSON

By ARTHUR CHAPMAN

In order to reforest a part of the Adirondacks, it has been found necessary to import a million young trees from Germany.—Press Dispatch.

THE throb of the ax in the forest went on through a nation vast,
 Like a fevered heart that is beating in measure that's all too fast;
 We gave carte blanche to the woodman, and none stayed the vandal hand,
 And now, to replant our forests, we must send to the Fatherland.

The sawmill shrieked in the mountains, and the sound was borne on the breeze,
 O'er the crash of the falling giants as they splintered the smaller trees,
 And all that was left was silence, where whispered the forests grand—
 And now, to repair the mischief, we must send to the Fatherland.

We have gained some industrial captains—of lumber monarchs a few—
 But somehow they don't quite balance the damage that such chaps do;
 There's naught to make up for those barrens where wantonness set its brand,
 In these days when for forest seedlings we must send to the Fatherland!

—*Denver Republican.*

IMPORTANT ANNOUNCEMENT

The American Forestry Association has recently written its members, urging their aid in securing what an enthusiastic member calls "short term educational subscriptions" to FORESTRY AND IRRIGATION—*i.e.*, six months' subscriptions, at the rate of 25 cents each. The responses daily pouring into its offices have far exceeded its expectations. Members thus co-operating are cordially thanked, while those who have not replied are urged to do so.

As announced, the current issue of FORESTRY AND IRRIGATION is devoted to a report of the White House Conference. To find space, the size of type used has been reduced, and the number of pages increased twenty-five per cent.

That none desiring it may fail to receive a copy of this report, the forms are being held, that another edition

of the magazine may, if needed, be run off.

Trial subscribers should, in every case, receive the June number. Members, therefore, intending to comply with the request made of them in the letter above referred to, should act promptly.

Numbers soon to follow will treat of inland waterways, drainage, water-power, reclamation of arid lands, and other questions connected with the conservation of natural resources. In pushing its educational propaganda, the Association desires to avail itself fully of the deep and widespread interest aroused by the Governors' Conference. Members willing to aid its work can find no better time and no greater opportunity than that afforded by the great gathering so recently adjourned. Let the orders come.

THE DRAINAGE CONGRESS

THE friends of Federal aid to drainage have every reason to feel encouraged at the meeting held by the National Drainage Association in Washington on May 12 and 13. While the Congress was not so largely attended as had been hoped, this is accounted for by the Conference of the Governors, at the White House, and by other gatherings of scientific and professional men in the Capitol at the same time.

The several sessions were replete with general interest; some of the most pronounced advocates of Federal aid to drainage appeared before the Congress, and in no uncertain terms gave assurance to the members of their thorough conviction that the cause will ultimately triumph.

Among those speaking were Senator Clapp, of Minnesota, Senator Newlands, of Nevada, Representative Nelson Steenerson, of Minnesota, and Representative H. R. Burton, of Dela-

ware. Hon. William Jennings Bryan volunteered a most excellent talk, in which he assured the audience of his thorough belief in the cause of Federal aid through the reclamation of overflowed and swamp lands.

Under the call of states, every delegate was emphatic as to the absolute necessity, both from a commercial and a sanitary standpoint, for prompt action by Congress in this great work of internal improvement. There was a slight diversity of opinion as to the best methods of obtaining Congressional action; however, eleven-twelfths of all present were in favor of a bill such as has been formulated by the Secretary of the Interior, and which is known as the Flint Bill.

At all periods of the Congress the utmost harmony prevailed. Every delegate realized that the cause of Federal aid to drainage had made remarkable strides since the first meeting at Oklahoma City, in December, 1906.

It is proposed, during the summer, by the friends and advocates of National drainage, to carry on a vigorous educational campaign, to the end that not only members of Congress, but members of State Legislatures, as well as the people themselves, shall become fully alive to the absolute necessity of securing the passage of the much-needed legislation. It is thought

more than probable that in this work of education several speakers will be placed in the field, for the purpose of spreading the propaganda of "Draining the swamps for homes and health."

The Executive Committee did not determine the place or time of holding the next annual Congress; however, this question is now under advise-

CONSERVATION—WOMAN'S WORK

BY

Lydia Adams-Williams

FROM time immemorial when any great work is to be accomplished—any achievement which vitally concerns the life and the welfare of humanity, any uplift of the children of men in



Lydia Adams-Williams.

A writer and lecturer on Conservation, and who is the first woman to take up this work.

the home or in the broader field, the world—to woman's integrity, resourcefulness, genius and capacity for endurance has the final triumph been due.

Joan of Arc's patriotism and inspiration enabled the peasantry of France to throw off the yoke of English oppression. To Josephine's devotion to her husband and the cause nearest his heart belongs the credit for the victories of Napoleon. To the intuition of Isabella of Spain, to her tenacious grasp of a great idea, to her foresight and her divine sympathy the world is indebted for the discovery of a great continent, for the civilization we enjoy to-day and for the great wealth of resources, the development of which has made us the most powerful nation on the face of the earth.

And as it was the intuitive foresight of a woman which brought the light of civilization to a great continent, so, in great measure, will it fall to woman, in her power to educate public sentiment, to save from rapacious waste and complete exhaustion the resources upon which depend the welfare of the home, the children and the children's children.

This is the inevitable conclusion, for to woman has the practice of saving, of conserving, ever been a paramount issue.

Man has been too busy building railroads, constructing ships, engineering great projects, and exploiting vast commercial and financial enterprises, to take the time necessary to consider the problems which concern

the welfare of the home and the future.

That has been left for woman, and it is conclusively a field where her care and love and devotion to all that makes for the betterment of humanity will find ample scope for work.

Man has always been the maker of money, while to woman has fallen the province of being the saver of money. When the necessity of economy is felt in the home, woman bravely meets the emergency, and plans for and effects the necessary saving.

So in the great national crisis which now confronts us—the necessity for economizing and preserving our fast-disappearing resources for ourselves and our children—woman is found the willing and ready partner to carry on the work.

One has but to attend any gathering of representative women, in convention assembled, to learn that there is an overwhelming sentiment and a consensus of opinion in favor of preserving forests and conserving natural resources.

Many women's organizations have already placed themselves on record as in favor of preserving forests. The District of Columbia Federation of Women's Clubs, with its seventeen affiliated clubs and 4,000 members, was the first woman's organization to adopt resolutions, introduced by the writer on November 30, 1907, indorsing President Roosevelt's policy of conserving the natural resources; while the National Society of the Daughters of the American Revolution followed, a close second.

The General Federation of Women's Clubs, with its 800,000 workers and hundreds of state and local branches, has for several years made a

specialty of work for preserving the forests, upon which the proper conservation of all other natural resources depends. It is conceded that the almost universal sentiment in favor of preserving forests is due to the interest taken in the subject by the women's clubs and the work done by them.

The Conference of Governors on the natural resources, just closed at the White House, was honored by the presence of Mrs. Sarah S. Platt Decker, of Denver, Colo., president of the General Federation of Women's Clubs, whom President Roosevelt especially invited. The recognition thus accorded the women of the country by the President and the other great men of the Nation shows the trend of public opinion and gives evidence of the realization and appreciation of woman's ability along these lines. Mrs. Roosevelt was also an interested listener at the meetings.

The saving of the country's resources will be an assured fact when the women of the country earnestly devote themselves to that work. It is peculiarly woman's work, as the time is short, and as men are slow in action, even when knowing the facts.

Far-reaching results may be accomplished speedily by women educating the men of their families. Then by inculcating in their children the precepts of economy, and then impressing them with the patriotic duty of elevating the Nation to the highest plane of civilization, the entire sentiment of the Nation may be changed by the motherhood of the country in a single generation, and this people converted from the most wasteful and extravagant in the world to the most prudent and conservative.

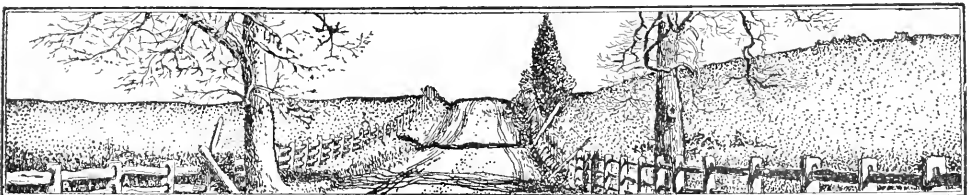

EDITORIAL

Forestry and Irrigation First

The report of the White House Conference, practically complete, is contained in this issue of FORESTRY AND IRRIGATION; and this magazine is the first among periodicals to publish a full account of the meeting of the Governors. Almost the entire magazine is devoted to this report, and the papers, addresses, discussions, etc., are given in the order in which they occurred. Sixteen pages have been added to the magazine in order to do this; and even with such addition it has been found necessary to omit practically all other features, departments, etc., usually found in the magazine. None but papers actually read at the Conference appear in this issue; several extremely valuable ones not delivered because of lack of time, but which will appear in the published report of the proceedings, will be printed later in this magazine.



"A New Departure in Government"

The Governor's Conference has been well styled "a new departure in government." The states of the Union have grown in number from thirteen to forty-six. The Nation has risen from a position in which the governorship of a state or even the mayoralty of an important city was held as a higher dignity than membership in either branch of Congress. Yet never before, in the century and a quarter during which this development has been in progress, have representatives of the states and of the three co-ordinate branches of the National Government met together. As an innovation, if nothing else, the event might well be styled "epoch-making."

Such a coming together reflects strikingly the spirit of the age. This is an era of congresses, conventions, and great concourses. Modern facilities, notably railroads, telegraphs, and daily newspapers, are rapidly uni-

fying the world. For the first time in history it is now possible for men scattered over an area as great, almost, as that of Europe, to come together quickly and inexpensively, to confer, surrounded by "all the comforts of home," to keep in touch, meanwhile, with their ordinary interests, and to return promptly to their regular work. Hence, meetings of bodies, commercial, political, economic, educational, scientific, religious, philosophical, and what-not, are the order of the day. Thus, influenced by the Time Spirit, it was probably inevitable that representatives of all of the states should, sooner or later, be brought together in conference with representatives of the several branches of the Federal Government.

As a factor in developing the National spirit, as against the old time particularism which, once regnant, made the development of the Nation and a true National policy so difficult, such a meeting was doubtless potent. As a factor in developing uniform policies among multiplying and widely separated states, this meeting, with those to follow, may be even more potent. The individualism which so long characterized the American man, has likewise, in large measure, characterized the American state. State policy, state legislation, state administration, has hitherto been, in great degree, a matter of "every tub standing on its own bottom." The result has been divorce laws, labor laws, corporation laws, and the like, strikingly suggestive of a patchwork quilt. While, super-imposed upon this maze of dissimilar and inharmonious state legislation, has been still another system of Federal legislation, making the confusion worse confounded.

But the states are now learning what individuals earlier began to learn; namely, that their relations in a commonwealth are relations not of independence, but of interdependence. Further, as harmony and substantial

uniformity of policy among the business and other organizations mentioned has been found wise, so harmony and uniformity among the states will doubtless also gradually be found wise.

Though convening to consider a specific question, that, namely, of conservation of natural resources, it is noteworthy that the one conference held sees far beyond that single object. Governor Swanson, of Virginia, mentioned extradition, standardization of laws on marriage and divorce, taxation and police power as questions that should be considered at the next conference. The remarks of both President Roosevelt and Mr. Bryan are likewise suggestive of future possibilities with respect to corporation control. Speaking of the respective fields of state and Nation, the President said, "I am trying to find out where one or the other can act, so that there shall be some sovereign power that, on behalf of the people, can hold every big corporation, every big individual, to an accountability so that its, or his acts shall be beneficial to the people as a whole." While Mr. Bryan pointed out felicitously that there should be "no twilight zone" between the domains of state and Nation in which corporations may hide and escape control.

On reflection, it should be evident that if the people of the United States have seriously set themselves to work to control, through their various governments, National and state, their corporations and trusts, no better scheme could be devised than a conference representing all these governments and deliberately formulating a policy, legislative and administrative, whereby this end should be pursued. The familiar process of scudding from state to state, and of oscillating between state and federal jurisdictions, whereby, it is commonly believed, great interests have played hide-and-seek with justice, and snapped their fingers at Government, might, in this way, be seriously discouraged.

Again, the jealousy between state and Nation over the question of respective powers that has proved so serviceable to mighty lawbreakers could, by this method, be settled with the minimum of difficulty. The President declared that, as respects the "academic side of the question" of state and National functions, he cared nothing. "I deal," he said, "with the matter from the standpoint of true popular interest, and therefore my desire is to employ indifferently either the principle of states' rights, or the principle of National sovereignty, whichever in a given case will best conserve the needs of the people." With this view the Conference acquiesced, much to the disgust of at least one newspaper prominently identified with corporate interests. Obviously, when states and Nation cease disputing over which shall or shall not catch the hare, the prospect for catching it will materially improve.

That such conferences, meeting perhaps annually, in future may develop a legislative "third house" naturally suggests itself. This first conference did, in fact, urge action by Congress, as is shown by the following resolution:

"We especially urge on the Federal Congress the immediate adoption of a wise, active, and thorough waterway policy providing for the prompt improvement of our streams and conservation of their watersheds required for the uses of commerce, and the protection of the interests of our people."

Other recommendations, applicable to Congress, were also made.

Conceding the point, however, does it not afford ground for congratulation rather than for regret? The governors are nearer the people certainly than the upper, and probably than the lower house of Congress. Congressmen are in the National Capitol, most of them hundreds, many of them thousands of miles from their constituents. Governors are in their home states, in closest touch with public sentiment. Furthermore, the govern-

ors in conference can only recommend; and for whatever recommendations they may make, they are directly responsible to the voters in their respective states.

The extraordinary harmony of the Conference affords added ground for profound satisfaction. That men coming together from regions so remote and representing interests so multitudinous, diverse, and apparently conflicting should, for three days, have compared views, and concluded with practical unanimity of sentiment, not only testifies to the substantial oneness of the American people, but augurs well for the future of the Republic. The first Conference of Governors has proved an overwhelming success. We may well wish it "many happy returns."



Grants in Perpetuity

Among the most notable utterances made at the Governors' Conference is the following by President Roosevelt:

"My position has been simply that where a privilege which may be of untold value in the future to the private individuals granted it is asked from the Federal Government, that the Federal Government shall put on the grant a condition that it shall not be a grant in perpetuity. Make it long enough so that the corporation shall have an ample material reward. The corporation deserves it. Give an ample reward to the captain of industry, but not an indeterminate reward. Put on a provision that will enable our children at the end of a certain specified period to say what in their judgment should be done with that great natural power which is of use to the grantee only because the people as a whole allow him to use it. It is eminently right that he should be allowed to make ample profit from his development of it, but make him pay something for the privilege, and make the grant for a fixed period, so that when the conditions change, as in all probability they will change, our children—the Nation of the future—shall have the right to determine the conditions upon which that privilege shall then be enjoyed.

"Where that policy can best be carried out by the states, carry it out by the states; where it can best be carried out by the Nation, carry it out by the Nation. My concern is not with the academic side of the question. My concern is in the employment either of the principle of states' rights or the principle of National sovereignty, as

will best conserve the needs of the people as a whole."

What is meant is, in a word, where an individual or corporation applies to Government for a privilege, and this be granted, let the grantee pay for it, and let it be understood that his privilege will last but for a limited time.

Should this proposal be made in the hearing of a "traveller from Mars," we should expect him to say, "Of course; have government privileges in your country ever been granted in any other way?"

To this inquiry we should be compelled to reply that this is exactly the way in which they have not, as a rule, been granted.

In these columns, not long since, (page 182) appeared an editorial entitled "Some Vicious Bills." Here was considered a series of bills before the first session of the present Congress, asking for grants of Government privileges in perpetuity, and offering only nominal compensation.

When our public domain was frittered away, and transferred in kingdoms and empires to railroads, was the above mentioned principle observed? What compensation did the Nation receive? And when will the grants terminate?

Our fast disappearing mineral wealth once belonged to the people; now only the fag end of it is theirs. The remainder has been transferred from them to individuals and corporations. What have the people received in return, and when will the grants end?

The principle enunciated by the President applies with peculiar force to natural resources; and of these, he was, of course, speaking. Natural resources are but an aspect of the earth, the basis of all organic life, human and sub-human. The President's statement suggests some interesting inquiries: Who own the earth? Upon what is their title based? How long will that title hold good?

We have heard of the tramp who was ordered off the duke's land, and

who thereupon inquired into his lordship's title.

"Where did you get this land?"

"From my father," answered the duke.

"And where did he get it?" asked the tramp.

"From his father," answered the duke.

"And where did your first ancestor get it?" asked the tramp.

"He fought for it," answered the duke.

"Then I will fight you for it," answered the tramp, who proceeded to suit action to word.

This whole question of rights to land was learnedly discussed in 1850 by Herbert Spencer in Chapter IX, of his *Social Statics*. He there reached the conclusion that the duke reached. His readers were left to draw, if they chose, the same inference drawn by the tramp.

Jefferson declared that "the earth belongs in usufruct to the generation at any time living upon it." And this apparently is the President's view. The application of this principle will seriously interfere with the time-honored custom whereby generations, long since gone, control, in fundamental ways, the generation living. It will interfere seriously with the process whereby the "dead hand" reaches forth from the grave and rules a living world.

The President's principle will, of course, be challenged. But let the wordy contest come. For wars on the forum may prevent wars on the field. In any event, they clear the air; and, with the modern growth of the trust and special privilege, the air must be cleared if the nation would escape the advent of evil days.



The Appalachian Bill in Congress

In his message of April 27 President Roosevelt said: "Forest reserves should be established throughout the Appalachian-White Mountain region wherever it can be shown that they will have a direct and real connection

with the conservation and improvement of navigable rivers."

On April 20 were introduced into the House the Pollard Bill, H. R. 21220; the Weeks Bill, H. R. 21221; and on April 28, the Lever Bill, H. R. 21357. Epitomes of these three bills appeared in Bulletin No. 39 of The American Forestry Association. No one of the bills was favorably reported.

On May 16, the Senate passed the Brandegee Bill, S. 4825. Its leading provisions follow:

The Secretary of Agriculture is to preserve navigability of navigable streams, to acquire lands more valuable for regulation of stream-flow than for other purposes, and situated on watersheds in Maryland, Virginia, West Virginia, North Carolina, South Carolina, Georgia, Alabama, Kentucky, Tennessee, New Hampshire and Maine. Minerals and merchantable timber may be reserved by owner, to be cut or mined under Government regulations.

The Secretary is to advertise for lands and accept lowest bids. No land must be taken over until State Legislature has consented, and ceded to the United States jurisdiction over offenses against Federal laws. Land titles must be satisfactory to Attorney General.

Five million dollars are made immediately available. The Secretary is to report annually to Congress on lands purchased, with cost.

Small agricultural areas included may be sold by Secretary in eighty-acre homesteads, jurisdiction over land thereupon reverting to State. The Secretary may authorize sale of products of lands acquired.

Lands acquired under this act to be held and administered as National Forest lands, under provisions of Section 24 of Act of March 3, 1891. The State to retain criminal and civil jurisdiction over persons, save for offenses against the United States. Twenty-five per cent of annual receipts from each National Forest to be paid to State for benefit of public schools and public roads.

Secretary may administer and protect private forest lands upon watersheds upon which are forest reservations; owner to cut and remove timber according to regulations agreed upon.

Senator Brandegee accompanied his bill with a fifteen-page supplemental report, Calendar Number 490. This report gives reasons why National Forests are necessary: 1. To protect

the watersheds of navigable streams; 2. To safeguard available water-powers; 3. To improve timber supply; 4. For health and recreation; 5. For purity of water supply; 6. For protection of soil; 7. In the control of floods; 8. The states cannot act; 9. Experiences of other countries show that the Federal Government must do this work; 10. The present a favorable time for action; 11. Proposed action is fundamental to any systematic plan of conservation of natural resources. It indicates the land needing protection, discusses the treatment of the region, the method of acquirement and cost of lands, and epitomizes the history of the movement for Appalachian National Forests.

Senator Teller spoke nearly two hours against the Brandegee Bill, and Senators Daniels and Newlands spoke for it.

On May 21 the House of Representatives passed a bill, H. R. 21986, known as the Scott Bill. Its title is, "A Bill to Enable any State to Co-operate with any other State or States, or With the United States, for the Conservation of Navigable Rivers, and To Provide For the Appointment of a Commission."

Following are the provisions of the bill: The consent of Congress is given for each state to enter into such agreement or compact, not to conflict with any law of the United States, as it may deem desirable or necessary, with any state or states to conserve forests and water supply of states in agreement.

One hundred thousand dollars is appropriated to enable the Secretary of Agriculture to co-operate, when requested, with any state or states by supplying expert advice on forest preservation, utilization and administration, and on reforestation of denuded areas. He is authorized to agree with owners to administer and protect private forest lands upon watersheds of navigable rivers, provided owners cut and remove under regulations for the protection of the forests in aid of navigation. The United States shall not be liable for damage resulting from fire or other cause.

A National Forest Commission, consisting of five Senators and five Representatives, is created to investigate connection between forest preservation on

watersheds of navigable rivers rising in White and Southern Appalachian Mountains, and navigability of said rivers, and to ascertain extent, if any, to which U. S. Government should acquire land, with probable cost, or whether Government should supervise watersheds without purchasing land. The Commission is to report to the President not later than January 1, 1909. It may expend twenty thousand dollars.

Representative Scott, Chairman of the Committee on Agriculture, accompanied this bill with report number 1700, on "Co-operation of States for Conservation of Navigability of Navigable Rivers, etc." In this, he apologized for the delay, extending throughout practically the entire long session, in considering a measure which he concedes has been "widely discussed and has awakened profound interest throughout the entire country." He stated four methods that have been suggested of handling the problem: 1, Exclusive state action; 2, U. S. Government co-operation, by advice and assistance, with states or private owners; 3, The exercise of Federal jurisdiction over privately owned forests on watersheds having connection with navigability of navigable streams; 4, Federal purchase of all lands necessary to protect watersheds of navigable rivers, and exercise over forests of rights and privileges of absolute ownership.

The Bill H. R. 21986 was, he said, drawn to meet in a measure each of these four proposed plans. He then explained the bill and recommended its passage, which promptly followed.

This bill is, of course, highly objectionable to friends of National Forests in the Southern Appalachians and White Mountains. It seeks to shift responsibility from Congress to the States, thus reflecting the view so often expressed by the Speaker. As the *Boston Transcript* puts it, it provides for a Congressional junket, enabling ten statesmen to spend the summer in the mountains, with two thousand dollars of Government money apiece for expenses. It staves off the issue on the assumption that more investi-

gation is needed, when the Congressional ship has already been loaded to the water's edge with information on every conceivable pertinent aspect of the case. Meanwhile, it permits forest slaughter, soil erosion, and stream impairment to proceed.

It is understood that the Senate will ignore this bill. The Southern Newspaper Publishers' Association, in convention at Charlotte, N. C., has recently gone on record, by unanimous vote, for the proposed Appalachian-White Mountain National Forests. Hon. John H. Small, representative from the First district in North Carolina, in an address before the American Cotton Manufacturers' Association at Richmond, Virginia, on May 20, said:

The only agency which can properly preserve these mountain forests is that of the United States. It is utterly impracticable for any single state, and equally so for any confederation of states. Any suggestion to the contrary comes from an enemy and not a friend of this great National resource.

Speaking of "powerful obstacles which block the way," he said:

There are no legislative obstacles so great which the American people in their might cannot remove. This can be done by continuing the propaganda of education so insistently waged by the American Forestry Association, and by your Association, as an active ally.

The feeling of the Cotton Manufacturers is shown by the following resolution, passed unanimously on the same day:

We, the American Cotton Manufacturers' Association, in convention assembled, hereby urge upon the Congress of the United States the passage, at this session, of bill H. R. 21357, or a similar bill, providing for the purchase, in aid of navigation, of forest lands in the Southern Appalachian and White Mountain regions, and also for co-operation between private owners and the Federal Government with a view of preserving the forests on privately owned land for the regulation of stream-flow in aid of navigation.

Congress is expected to adjourn in the week ending May 30th. If so,

and nothing further is accomplished this session, there will still have been gained the passage of an excellent bill by the Senate, and the development of public sentiment which should result in the rebuke at the polls, if not the actual retirement, of congressmen who have dallied with or obstructed a measure so generally recognized as indispensable to national well-being.



Some Western Criticisms.

The following editorial paragraph is quoted from the May 2 issue of *Field and Farm*, published at Denver:

"It listens big to read how a millionaire Senator has bought 12,000 acres of coal land in Colorado; but is it a good thing for the state, or a solace to posterity? The time is coming when the country will be owned, soul and body, by the millionaires."

Has it ever occurred to the editor of *Field and Farm* that in voicing sentiments such as this, and in continuing also to protest against the work of the Government in creating National Forests and mineral reserves (as proposed not long ago by President Roosevelt) a clash of argument occurs that speaks but poorly for the editorial bump of logic?

The proposition to extend greatly the work of the Government in establishing National Forests is, to many in the West, as to the proverbial red flag to the bull. So, too, is the proposition that the several states establish within their borders state forest and mineral reserves, though the latter proposition does not arouse such an intense degree of antagonism as does the former. Probably this is because propositions looking toward the establishment of state forests have been neither frequent nor strongly advocated; but this is by the way.

Now, the question resolves itself to this: A large part of the Western press, and a great majority of the people of the West, are violently opposed to the acquisition by individuals or

private corporations of vast tracts of timber or mineral lands. This is indicated in the paragraph quoted above, and the sentiment expressed therein is fairly representative of the opinions of a good majority of Western men. It is also a fact that the bulk of opposition to the establishment by the Federal Government of National Forests is in the far West. Forest conservation has its friends—and excellent ones, too—in that part of the country lying west of the Missouri River; but the bitter, vituperative and strenuous opposition to the Government's program comes also from that section. It is true, too, that propositions that have been made in the past for the several states to do their own work in establishing forest reserves and reserves of mineral lands—these to be held *in perpetuo* for the benefit of the whole people, and to be taken from the lands owned by the states and lying within their own borders—have likewise met with strong opposition; so strong, in fact, that no serious attempt has ever been made to put such a program into effect.

Now, what remedy do our protesting friends propose? So far we have failed to see or hear of any. All that has as yet come to our attention is a continuous performance of protest against everything. Protest against the segregation under individual or corporate ownership of tremendous tracts of timber and mineral lands; protest against the broadening of the National Forest scheme; protest against the establishment of a state scheme for forest and mineral reserves. And, with all the protest, not even the suggestion of a remedy. Does it not occur to these protestors that, if they have no remedy to offer, it ill becomes them to rail continuously against existing conditions?

There is no room for doubt that if the sentiment of the voting public in

any or all of the Western states were to be vigorously expressed the states would be forced to enact legislation looking toward the preservation and conservation of the natural resources upon or within the lands owned by such states. It requires only the expression of a crystallized public sentiment to secure the adoption of any legislation desired; and the fact that no such crystallization has taken place, and the added fact that proposals to this end have been bitterly opposed, would seem to indicate that the public—that is, the voting public—of the states in question does not want such legislation.

It is an equally patent fact, if one is to judge by expressions of individual and collective opinion and the editorial utterances of the newspapers, that many people of the far West oppose the Nationalization of forests, etc. Nobody denies the right of the Government to set aside National Forests when the land so set aside is Government land; nevertheless, the opposition to the establishment of National Forests continues vociferously, and it is the strongest in the far Western states. There is hardly room for doubt, either, that if the Western states would undertake the work of preserving the remaining forests and caring for them in a wise manner, safeguarding them against exploitation and conserving the timber within them for the fullest possible use, the National Government would have little to do there along the line of forest conservation. But the states will not do this; the objectors within the states are as strongly opposed to such steps as they are to the plan of National Forests. They offer no substitute plan; therefore it would seem "to a man up a tree" as if they had only themselves to blame for the other aggressions and abuses which so arouse their ire.

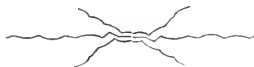

NEWS AND NOTES

Timber Owners Organize to Fight Fires

A most important economic movement of the times, which, as yet, has attracted little attention from the general public, is the organization of timber owners in different sections of the country, for protection against fires. The Washington Forest Fire Association, with headquarters at Seattle, has just elected officers for the year, this organization having 3,000,000 acres of forest under its control. Plans followed by the United States Forest Service for fighting and controlling fires have been adopted. Oregon and Idaho also have organizations of this sort, in the latter state a portion of the expense being paid from taxes received by the State Treasurer. One of the big western railroads has also taken steps to guard its timber properties from fires. Away over on the other side of the continent, the timber owners in Maine have begun to form a similar organization, and preliminary steps in the formation of fire-fighting organizations are reported from other sections of the country. When it is considered that forest fires have destroyed more timber than the lumbermen have cut, the wisdom of such moves is readily apparent.



NOVEL FORESTRY COURSE.

At the Massachusetts Agricultural College this year thirteen students are taking the course in the study of shade trees. This is an elective course of the senior year. It has been given for several years, and includes a study of all the factors which in any way touch on shade trees; for instance, tree warden laws, proper trees for street planting, transplanting and care of trees; the various factors that interfere with tree growth, such as soil conditions, macadamized roads and sidewalks; biological features such as micorhiza, etc.; the effects of drought, winds, lightning, direct and alternating cur-

rents, illuminating gas, and the atmospheric gases. Attention is also given to the study of the fungi affecting shade trees and shrubs, and some practical work in tree filling, chaining and bolting is done, together with treatment of cavities, and proper methods of pruning.



Possibilities for Turpentine in Northwest.

L. W. Hawley, expert on wood distillation for the Forest Service, has just left Washington for Oregon, Washington, Montana and Idaho, to investigate the possibilities of a future turpentine industry in the northwestern portion of the United States.

Mr. Hawley has taken with him a small distillation apparatus, which he will set up at various places in these states, distilling the different woods to determine their value in the production of turpentine. In this manner an accurate idea of the yield of extracts from the various woods can be obtained, and samples of the material will be sent to Washington for analysis and estimation of its value for use in paints, varnishes, and other naval stores.

There are at the present time in the Northwest, several wood distilling plants which are producing various grades of turpentine, wood preserving oils, and materials of a similar nature. It is believed that a careful study of existing conditions in this section will yield results which will give an accurate idea of the possibility of utilizing the enormous quantity of saw mill refuse now going to waste.



Proposed Summer Home for Teachers

Lewis C. Greenlee, for many years superintendent of public schools in Denver, Colorado, and lately elected president of a reclamation and development company owning lands in Routt county, Colo., has evolved a

scheme for providing a summer home and resort for members of the National Educational Association. His company proposes to dedicate to the Association a tract of land in Routt county, upon which members may build, and which will be capable of agricultural development, with the idea of providing a resort where vacations may be spent with as little expense as possible. The land lies along the eastern side of the company's irrigation ditch, running up into the mountains, and offers what is said to be an ideal location for summer residences, cottages or resort hotels. The Moffat Road, now approaching completion, taps the section from Denver, and Routt county affords some of the finest scenery, as well as magnificent farming, gardening and fruit-growing lands, to be found in the Centennial State. The proposition will be made to the Association at its annual meeting in Cleveland, Ohio, this summer.



New National Forest in Kansas

President Roosevelt has just signed a proclamation creating additions to the present Garden City National Forest amounting to 205,107 acres. This proclamation also provides that the original Forest known as the Garden City with the additions shall be called the Kansas National Forest. The additions will bring the area of the Kansas National Forest up to 302,387 acres.

The forest is located in Finney and Kearney counties, in the sandhill region of Kansas, on the Arkansas River. Its creation received the support of the entire Kansas delegation in Congress, and, through petitions, the support of industrial associations and citizens generally of the counties in which this land is situated.

The Kansas National Forest was created mainly for experimental planting, since the rapidly increasing demand for timber in the agricultural

communities adjacent has led the people to believe that this sandhill land, otherwise worthless except for a limited amount of grazing, can be made to produce timber. Fair success has been obtained with black locust on lands similar in character, and it is thought that further experiments will demonstrate that the entire sandhill region south of the Arkansas River can be made to produce timber.

To this end, the Forest Service has made arrangements to plant 65,000 seedlings of valuable hardwood species on this forest this spring. A new planting station at Garden City, to supply trees for future planting on this forest, was established March 1, on a tract of five acres of land which was leased from the County Commissioners of Finney county, for yearly rental of \$1 per acre. The annual capacity of this nursery will be 300,000 trees. The value of timber for fence posts, fuel, and other domestic uses, which it is believed this forest is capable of producing, is almost incalculable in that practically treeless country. It is unquestionable that, if the Forest Service is successful in these experiments, many private individuals will benefit from the results obtained by the Government, and plant trees for domestic purposes in connection with other work on their ranches.

Tree planting experiences in Kansas have been many and varied. Ignorance of proper methods of planting and caring for the trees and the frequent choice of stock entirely unsuited to the region brought many failures during the year following the enactment of the old timber claim law. There have been many successes, however, in tree planting, where landowners have exercised judgment and care in the work, and the fine groves of trees in the western part of the state give promise of the reclamation of much of the great stretch of land lying south of the Arkansas River, known as the sandhills.



**Evergreens,
Forest Trees
and Seeds.**

*Three Millions of White Pine Seedlings and
nearly one ton of Seeds.*

Red Oaks, Linden, Black Locust

ALSO SEEDS

For forest planting on sandy soil I offer several millions Ponderosa and Jack Pines and Northern Red Cedar, and Seeds of same.

Northern Grown Trees and Seeds a Specialty

Mention this paper when you write.

D. HILL, Evergreen Specialist

DUNDEE, ILL.

Read "Irrigation in the United States," by Fredrick Haynes Newell, Director of the Reclamation Service. Price, \$2, postpaid to any address. Address "Forestry and Irrigation," Washington, D. C.

ORCHIDS

ORCHIDS

We are the largest Orchid Growers in the United States. Our Illustrated and Descriptive Catalogue of Orchids is now ready and may be had on application

Orchid Growers
and Importers

LAGER & HURRELL,
Summit, N. J.

The . . . **PAPER** . . . that this publication is printed
on is furnished by

R. P. Andrews Paper Co., Inc., Washington,

Sole Agents in the District of Columbia for the
West Virginia Pulp and Paper Company,
the Largest Manufacturers of Book Paper in
the world.

IF IN NEED, DROP THEM A LINE

In writing advertisers kindly mention FORESTRY AND IRRIGATION

POWDER POINT SCHOOL, Duxbury, Mass.

Preparatory Course in

FORESTRY

Leading to Biltmore and College Course in the subject. It requires hard, earnest application and develops appreciation of nature and powers of leadership.

(M. I. T.)

F. B. KNAPP, S. B.

FOR SALE

SET OF

SARGENT'S SILVA OF NORTH AMERICA

Fourteen volumes in original boxes. Cost \$350 net; offered at \$265 net. Also a number of books on FORESTRY and BOTANY. Address

W. W. ASHE

Forest Service

Washington, D. C.

**Philippine Bureau of
Forestry**

WANTED—Two foresters with field experience. Minimum salary \$1600. Travel expenses allowed, also liberal leave privileges. At least seven months interesting field work per year.

For information concerning travel allowances to Manila. Civil Service rules, health conditions, in fact any information in regard to the Islands, apply to the **Bureau of Insular Affairs**, War Department, Washington, D. C.

GET THIS RIFE Hydraulic Ram



if there is a stream, spring or pond near by and have running water wherever you want it.

PUMPS WATER WITH WATER

works continuously without attention. No expense for power, nothing to get out of order. Raises water 30 feet for each foot of fall. For Home, Farm, Irrigation, and all purposes. Over 7,000 in use. Free Plans and Estimates furnished. Write today.

RIFE ENGINE CO., 2172 Trinity Bldg., NEW YORK

Biltmore Forest School

Biltmore, N. C.



Theoretical and practical instruction in all branches of applied forestry.

The course comprises eighteen months; twelve consecutive months of lectures and field work, and six months of practical experience.

Object lessons within the mountain estate of George W. Vanderbilt, comprising 120,000 acres, where forestry has been practiced since 1895



For further information apply to

C. A. Schenck, Director

COLORADO SCHOOL OF FORESTRY...

Colorado Springs, Colo.

Three years' course in
TECHNICAL AND
APPLIED FORESTRY

Winter Term at Colorado College, Colorado Springs. Summer Term at Manitou Park on the borders of the Pike's Peak Forest Reserve.

TUITION, SIXTY DOLLARS
— A YEAR —

For further particulars apply to
WM. C. STURGIS, Dean

Colorado Springs - - - Colo.

YALE FOREST SCHOOL NEW HAVEN, CONNECTICUT

The course of study in the YALE FOREST SCHOOL covers a period of two years. Graduates of collegiate institutions of high standing are admitted as candidates for the degree of Master of Forestry.

The Summer School of Forestry is conducted at MILFORD, PIKE COUNTY, PENNA.

— FOR FURTHER INFORMATION ADDRESS —
HENRY S. GRAVES, Director - New Haven, Connecticut

FORESTRY AND IRRIGATION

WOODS AND WATERS; SOILS AND ORES.



WHITEWATER FALLS, IN THE SOUTHERN APPALACHIANS

Thorburn's Seeds

We carry a large assortment of seeds of EVERGREEN and DECIDUOUS TREES and SHRUBS, both native and imported, and shall be glad to quote on any that are still unsold.

J. M. THORBURN & CO.

33 BARCLAY STREET

Through to 38 Park Place

Established 1802

NEW YORK

This Solar can be used in hazy weather, when other Solars are useless. Used by the U. S. General Land Office.



Specifications

Needle 2 $\frac{1}{2}$ inches long. Graduations 4 $\frac{3}{4}$ inches long, reading minutes. Power of telescope 20 (with splendid definition, good light, and large field). Variation plate. Level to telescope, clamp and opposing screws. Vertical arc. Fixed Stadia hairs. Extension Tripod. Solar Attachment on side of standards.

Price Complete, \$30 J

Telegraph and Code Word, Mountsolar

Illustrated Catalogue Upon Application

YOUNG & SONS Philadelphia

The PENNSYLVANIA STATE COLLEGE

A thorough and practical undergraduate course in technical forestry, preparing men for all lines of professional and applied forestry.

Special attention is paid to practical field work in surveying, mapping, and forest measurements. One of the largest of the State Forest Reserves is within a short walk of the college.

For information regarding entrance requirements, expenses, etc., address

Department of Forestry

State College, Penna.

PLANE SURVEYING

**A Text-book and
Pocket Manual**

By JOHN CLAYTON TRACY, C. E.
Ass't Professor of Structural Engineering
Sheffield Scientific School of Yale University

16 mo., xxvii + 792 pages, illustrated with line cuts. Morocco, \$3.00

Used in the Yale Forestry School and just adopted in Pennsylvania Department of Forestry

Descriptive Circular on Application

JOHN WILEY & SONS

43 and 45 E. 19th Street
New York City

IMPORTANT BOOKS ON FORESTRY

PRINCIPLES AND PRACTICE OF FORESTRY

- FOREST MENSURATION.** By HENRY SOLON GRAVES, M.A. A complete text book of this important subject and the first written for American Foresters. It deals with the determination of the volume of log, tree, or stand, and with the study of increments and yields. *Price, \$4.00*
- ECONOMICS OF FORESTRY, THE.** By B. E. FERNOW. This volume treats of forests and forestry from the standpoint of political economy, and is designed to furnish a trustworthy basis for formulating public policy. *Price, \$1.50*
- FIRST BOOK OF FORESTRY, A.** By FILIBERT ROTH. An outline of the general principles of forestry, written in simple, non-technical language, designed particularly for the beginner. *Price, \$1.10*
- PRACTICAL FORESTRY, FOR BEGINNERS IN FORESTRY, AGRICULTURAL STUDENTS, AND WOODLAND OWNERS.** By JOHN GIFFORD. A good general description of the principles of forestry with enough technical information to prepare the beginner. *Price, \$1.50*
- HISTORY OF THE LUMBER INDUSTRY OF AMERICA.** By J. E. DEFEBAUGH. The first authoritative work of its kind yet issued, and one which will commend itself alike to the timber owner, lumberman, lumber manufacturer, or merchant, or student of economics. In four volumes bound in half leather. *\$5.00 per volume*
- FOREST PLANTING.** By H. NICHOLAS JARCHOW. An illustrated treatise on methods and means of restoring denuded woodland. *Price, \$1.50*
- FORESTRY.** (Schwappach.) An English translation of "Forstwissenschaft." *Price, 70c*
- HEDGES, WINDBREAKS, SHELTERS, AND LIVE FENCES.** By E. P. POWELL. A treatise on the planting, growth and management of hedges with information concerning windbreaks and shelters. *Price, 70c*
- NORTH AMERICAN FORESTS AND FORESTRY.** By ERNEST BRUNCKEN. This volume, expository in its character, is written in a style intended for the general reader, to whom it should convey a good idea of our forests forestry. *Price, \$2.00*
- PRACTICAL FORESTRY.** By ANDREW S. FULLER. A treatise on the propagation, planting and cultivation, with descriptions and the botanical and popular names of all the indigenous trees of the United States, and notes on a large number of the most valuable exotic species. *Price, \$1.50*
- PRINCIPLES OF AMERICAN FORESTRY.** By SAMUEL B. GREEN. Prepared especially for students in elementary forestry and for the general reader who wishes to secure a general idea of forestry in North America. *Price, \$1.50*
- SEASIDE PLANTING OF TREES AND SHRUBS.** By ALFRED GAUT. Illustrated from photographs by FRANK SUTCLIFFE. This is a new volume in the English Country Life Library. Advice regarding selection and management to get satisfactory effects under adverse influence of closeness to seashore. *Price, \$1.75*
- FOREST MANAGEMENT.** By C. A. SCHENCK. Describes methods here and abroad to bring the most profit from all investments made in woodlands. *Price, \$1.25*
- FOREST MENSURATION.** By C. A. SCHENCK. Treats conditions in U. S. from mathematical and practical standpoint. *Price, \$1.25*
- FOREST UTILIZATION.** By C. A. SCHENCK. First treatise on this in U. S. Covers logging, lumbering, sawmilling, coopersage, paper-making, and description of all industries obtaining raw material from American forests. *Price, \$1.25*
- BILTMORE LECTURES ON SYLVICULTURE.** By C. A. SCHENCK. Written from author's long experience as forester of the Biltmore estate, where sylviculture has been practiced on a larger scale for a longer time than anywhere else in U. S., and where results become more apparent from year to year. *Price, \$2.50*
- FOREST POLICY.** By C. A. SCHENCK. (Second part.) Describes the various States of the Union under following heads: Area; physiography; distribution of forests; forest ownership; use of the forest; forestry movement; forest laws; forest reservation; irrigation. *Price, \$1.25*

PROFESSION OF FORESTRY, THE. By GIFFORD PINCHOT. A pamphlet containing an address on that subject by Mr. Gifford Pinchot; also an address by Mr. Overton W. Price, on "Study in Europe for American Forest Students," and a list of reference publications for students. *Price, 25c*

FOREIGN IMPORTATIONS

- ENGLISH ESTATE FORESTRY.** By A. C. FORBES. An authoritative volume on English forest methods from the pen of a well known forester, that should prove of interest to Americans. *Price, \$3.50*
- FORSTWISSENSCHAFT.** (Schwappach.) *Price, 60c*
- MANUAL OF FORESTRY.** (Schlich.) Five volumes, complete, or separately, as follows (*price, complete, \$18.80*):
- Vol. I. "FORESTRY POLICY IN THE BRITISH EMPIRE." *Price, \$2.40*
 - Vol. II. "SYLVICULTURE." *Price, \$3.20*
 - Vol. III. "FOREST MANAGEMENT." *Price, \$3.60*
 - Vol. IV. "FOREST PROTECTION." *Price, \$4.80*
 - Vol. V. "FOREST UTILIZATION." *Price, \$4.80*
- This is perhaps the most authoritative work that has been issued on the technical side of forestry, translated from the German.
- WOOD.** By G. S. BOULGER. An important new book for arboriculturists and forestry students. A manual of the natural history and industrial applications of the timbers of commerce. Cloth. 82 Illustrations. *Price, \$2.60*
- FAMILIAR TREES.** By Prof. G. S. BOULGER. Written by an eminent botanical authority, yet couched in language easily understood. The coloured plates are the work of celebrated artists, and are truthful and trustworthy in every respect. A special feature is the series of photo-micrographic illustrations of sections of woods. Three volumes. *Price, per volume, \$1.50*

DENDROLOGY, BOTANY, AND IDENTIFICATION OF SPECIES

- MANUAL OF THE TREES OF NORTH AMERICA** (exclusive of Mexico). By CHARLES SPRAGUE SARGENT. A volume that presents in convenient form and with excellent illustrations, authoritative information concerning the trees of North America. It is written in a manner that enables the reader to readily find to what family or species any particular tree belongs. *Price, \$6.00*
- AMERICAN WOODS.** By ROSEYB N. HOUGH. A new departure in the publication of an authoritative work illustrated with actual wood sections of the various species described. Three are given of each, viz.: radial, transverse, and tangential. Issued in ten parts, per part *Price, \$5.00*
- HANDBOOK OF THE TREES OF THE NORTHERN U. S. AND CANADA, EAST OF THE ROCKY MOUNTAINS.** By ROSEYB N. HOUGH. Pictorial description of trunk, leaves, flowers or fruit, section of wood, and map of distribution, with botanical description, and brief other information. *Price, in buckram, \$8.00; in half morocco, \$10.00*
- FLORA OF THE SOUTHERN STATES.** CHAPMAN. This is an excellent key to the flora of the South, complete and accurate in its scope. *Price, \$4.00*
- GETTING ACQUAINTED WITH THE TREES.** By J. HORACE MCFARLAND. A handsome volume, copiously illustrated, and with facts accurately presented in an entertaining way. *Price, \$1.75*
- HOW PLANTS GROW.** By ASA GRAY. An understanding of the way in which a tree grows is of prime importance to the forester, and the matter here presented is accurate and authoritative. *Price, \$1.00*
- PRINCIPAL SPECIES OF WOOD; THEIR CHARACTERISTIC PROPERTIES.** By CHARLES HENRY SNOW. No attempt is made to give exhaustive descriptions of species, but the author presents a mass of information designed for the use and instruction of woodworkers, etc., in a popular style. A host of concise information is brought under each head, and the work is a valuable one. *Price, \$3.50*

These books sent prepaid upon receipt of price indicated, by FORESTRY AND IRRIGATION
1417 G Street N. W., Washington, D. C.

MANUAL OF BOTANY. By ASA GRAY. A key to the flora of the northeastern states, and the most authoritative publication of its nature.

Price, \$1.62; field edition, \$2.00

TREES OF NEW ENGLAND. By L. L. DAME and HENRY BROOKS. This book is a small volume which can be easily put in the pocket and carried in the woods, and at the same time is the best guide to the identification of our New England trees of any of the smaller books yet published.

Price, \$1.50

TREES OF NORTHEASTERN AMERICA. NEWHALL. A good general check list of the more important trees of the northeastern United States.

Price, \$1.75

TREES AND SHRUBS. By C. S. SARGENT. The most thorough and authoritative publication yet issued, and a standard work. The matter is issued in parts, of which there are three already published.

Price, per part, \$5.00

TREES, SHRUBS, AND VINES OF THE NORTHEASTERN UNITED STATES. By H. E. PARKURST.

In this book the author describes the trees, shrubs, and vines of the northeastern United States in a popular way, the book being designed especially for persons who have never studied botany. To these it will appeal as a valuable guide to a familiarity with the salient characteristics of trees, shrubs, and vines.

Price, \$1.50

TREES. A handbook of forest botany for the woodlands and the laboratory. By H. MARSHALL WARD. Vol. I. Buds and twigs. Vol. II. Leaves. Vol. III. Flowers and inflorescences. Three volumes to be added, on Fruits and seeds, Seedlings. Habit and conformation of the tree as a whole.

Price, per volume, \$1.50

PARTICULAR SPECIES AND LOCALITIES

MOUNTAINS OF CALIFORNIA, THE. By JOHN MUIR.

No other person is so well fitted to write of the mountains of California as John Muir, and the volume presented here describes not only the mountains themselves, but the trees that clothe them and the wild life which they harbor.

Price, \$1.85

BOOKS ON IRRIGATION AND DRAINAGE

IRRIGATION IN THE UNITED STATES. By F. H. NEWELL.

The most authoritative and complete work on the subject which has yet been published, by the head of the Government's irrigation work.

Price, \$2.00

IRRIGATION FARMING. By L. M. WILCOX.

A newly revised edition of one of the standard works on irrigation. The principal chapters treat very fully of irrigation, its application, etc., and the volume is profusely illustrated.

Cloth, \$2.00

IRRIGATION FOR FARM, GARDEN AND ORCHARD.

By HENRY STEWART. This work is offered to those American farmers and other cultivators of the soil who, from painful experience, can readily appreciate the losses which result from the scarcity of water at critical periods.

Price, \$1.00

IRRIGATION AND DRAINAGE. By F. H. KING.

While most of the existing books on these subjects have been written from engineering or legal standpoints, this one presents in a broad, yet specific way the fundamental principles which underlie the methods of culture by irrigation and drainage.

Price, \$1.50

IRRIGATION INSTITUTIONS. By ELWOOD MEAD.

A discussion of the economic and legal questions created by the growth of irrigated agriculture in the West, by the Chief of Irrigation and Drainage Investigations of the Department of Agriculture.

Price, \$1.25

LAND DRAINAGE. By MANLY MILES.

A handbook for farmers on the principles and practise of draining, giving the results of his extended experience in laying the drains.

Price, \$1.00

LAND OF LITTLE RAIN, THE. By MRS. MARY AUSTIN.

A nature book of the highest type. The volume is made up of a series of sketches of the human, animal, and plant life found in the region of the Mohave desert, Death Valley, and the Sierras, much of which the average person is likely to consider almost devoid of living things.

Price, \$2.00

OUR NATIONAL PARKS. By JOHN MUIR. If you want to learn about the glaciers, mountain peaks, canyons, and great waterfalls of the West; of the habits of animals from the squirrel to the moose; plant life from the big trees to the wild flowers—in fact be brought face to face with nature's works, this is the book.

Price, \$1.85

TREES AND SHRUBS OF MASSACHUSETTS. EMERSON.

Two volumes. Plain cloth edition has 148 plates. The colored edition has 36 of these in colors.

Price, plain, \$12.00

Price, colored, \$18.00

THE EARTH AS MODIFIED BY HUMAN ACTION. By G. P. MARSH.

A Revision of Man and Nature. Describes changes in the face of the earth caused by man, including desolation of various countries, once thickly inhabited, by removal of forests. Shows importance of maintaining natural balance of forces.

Price, \$3.50

THE LONGLEAF PINE IN VIRGIN FOREST. A Silvical Study.

By C. FREDERICK SCHWARZ. This is a study of the life history of this important forest tree. Intended primarily for foresters and forest students; also for owners and managers of pine timber lands. Deals with the preference or dislike of the species for particular conditions of soil, climate, and environment. Illustrations and six tables.

Price, \$1.25

THE SPROUT FORESTS OF THE HOUSATONIC VALLEY TO CONNECTICUT. By G. F. SCHWARZ.

Illustrated study of forests repeatedly cut over.

Price, 35c

IMPORTATIONS

BEAUTIFUL RARE TREES AND PLANTS. By the EARL OF ANNESLEY.

A description of some of the rarer English trees, shrubs, and vines, illustrated copiously.

Price, \$12.00

FORESTS OF UPPER INDIA AND THEIR INHABITANTS. By THOMAS W. WEBBER.

This volume is an account of the author's life in India during the period shortly after 1857. It contains a vivid description of the country, its people, customs, etc., with some description of its forests and timber wealth.

Price, \$5.00

IRRIGATION ENGINEERING AND CONSTRUCTIVE WORK

DESIGN AND CONSTRUCTION OF DAMS. By EDWARD WEGMANN.

This volume includes an authoritative discussion of the constructive work involved and the principal forms of construction. Masonry, rock-fill, and timber dams are discussed extensively.

Price, \$6.00

IMPROVEMENT OF RIVERS. By B. F. THOMAS and D. A. WATT.

This volume is a treatise on the methods employed for improving streams for open navigation and for navigation by means of locks and dams.

Price, \$6.50

IRRIGATION ENGINEERING. By HERBERT M. WILSON.

This is the fourth edition of Mr. Wilson's popular work, and the revision and enlargement which it has undergone, places it at the forefront of text books on the subject for American students.

Price, \$4.00

ENGINEERING FOR LAND DRAINAGE. By C. G. ELIOTT.

A manual for laying out and constructing drains for the improvement of agricultural lands.

Price, \$1.50

RESERVOIRS FOR IRRIGATION, WATERPOWER, AND DOMESTIC WATER-SUPPLY. By JAMES DIX SCHUYLER.

An account of various types of dams and the methods and plans of their construction, together with a discussion of the available water-supply for irrigation in various sections of arid America, distribution, application, and use of water; the rainfall, runoff, and evaporation from reservoirs, and effect of silt, etc.

Price, \$5.00

WATER SUPPLY ENGINEERING. By A. PRESCOTT FOLWELL.

A treatise on the designing, construction and maintenance of water-supply systems, both city and irrigation.

Price, \$4.00

WATER POWER. By JOSEPH P. FRIZELL. An outline of the development and application of the energy of flowing water. Price, \$5.00

CONCRETE, PLAIN AND REINFORCED. By FREDERICK W. TAYLOR and SANFORD E. THOMPSON. Designed for practicing engineers and contractors; text and reference book for students. Discusses materials, processes, and applications of concrete in construction and specifications. Price, \$5.00

HYDRAULICS. By MANSFIELD MERRIMAN. Purpose of book is to keep abreast of modern progress, and present subject with conciseness and clearness. Gives general principles and discusses flow of water through various kinds of openings and channels. Historical notes and references. Price, \$5.00

FOUNDATIONS. By W. M. PATTON. A practical treatise explaining fully the principles involved. Numerous descriptions of important modern structures are given in sufficient detail. Includes articles on use of concrete in foundations. Price, \$5.00

MASONRY CONSTRUCTION. By IRA O. BAKER. Contains results of a great number of experiments, and a large amount of practical data on cost of masonry, pile driving, foundations, culverts, etc., and 97 tables to facilitate estimating. Price, \$5.00

REINFORCED CONCRETE. By ALBERT W. BUEL and CHARLES S. HILL. A treatise for designing and constructing engineers, governed by American practice and conditions. Theoretical discussions omitted, and replaced by practical working formulas, examples of representative structures, and records of practice. Price, \$5.00

BOOKS ON RELATED SUBJECTS

UTILIZATION OF WOOD WASTE BY DISTILLATION. By WALTER B. HARPER. An important treatise on a subject regarding which the interest is great and the information scarce. Is intended to aid in the establishment and conduct of wood distilling enterprises on a business basis. Price, \$3.00

HANDBOOK OF TIMBER PRESERVATION. By SAMUEL M. ROWE. Intended as a complete practical guide for the operator of a preservation plant, with hints on construction thereof. Price, \$4.00

IN FOREST LAND. By DOUGLAS MALLOCH. The humor, sentiment, and philosophy of the lumber business interpreted by the "Lumberman Poet." A kind of touch with the great outdoors that few books contain. Illustrated in tint, bound in silk cloth and gold stamped. Ideal for gift or library. Price, \$1.25

THE GARDEN

ROSES AND HOW TO GROW THEM. By many Experts. In text, practical; in subject and quality of illustrations, beautiful. Price, \$1.20

FERNS AND HOW TO GROW THEM. By G. A. WOOLSON. The growing of hardy ferns, both in the garden and indoors. Price, \$1.20

LAWNS AND HOW TO MAKE THEM. By LEONARD BARRON. For the first time the subject of lawn seed mixtures is set forth and explained. 32 photographs. Price, \$1.20

HOW TO MAKE SCHOOL GARDENS. By H. D. HEMENWAY. This suggestive little book is a practical manual of school gardening for both teacher and pupil, and supplies the first adequate work of the sort in this country. There are to-day a hundred thousand school gardens in Europe, and the progress of the recent movement in America has been most rapid. This volume is based on actual experience (the author is an authority and director of the Hartford School of Horticulture). Illustrations, 10. Price, \$1.10

HOW TO MAKE A FRUIT GARDEN. By S. W. FLETCHER. An eminently practical work on the subject of fruits for the home. With 182 photographic illustrations by the author. Price, \$2.25

HOW TO MAKE A FLOWER GARDEN. A charming and a practical book by experts on every branch of the subject. More than 200 beautiful photographs. Price, \$1.75

HOW TO MAKE A VEGETABLE GARDEN. By EDITH L. FULLERTON. The only adequate book on the home vegetable garden. 250 photographs by H. B. Fullerton. Price, \$2.20

ART AND CRAFT OF GARDEN MAKING. By THOMAS H. MAWSON. Third edition of this standard, out of print for a year, and now reissued in revised form. Over 100 plans and details of gardens. Methods employed by successful designers carefully analyzed. Characteristic sites in typical districts described and pictured. Price, \$15.00

THE HOME AND FARM

THE COUNTRY HOUSE. By CHARLES EDW. HOOPER. A Practical manual of house building, absolutely invaluable to every one with a country place. It covers every branch of the subject in detail and treats of the garden and its furnishings in connection with the dwelling. 380 photographs and plans. Price, \$3.50

THREE ACRES AND LIBERTY. By BOLTON HALL. Description of what can be accomplished on a small place in the way of gardening, home-making, and addition to financial resources. Were it not for the unimpeachable authorities quoted, its statements as to the possibilities of the "Little Lands" for a living would seem fanciful. Price, \$1.85

THE MAKING OF A COUNTRY HOME. By J. P. MOWBRAY ("J. P. M."). This delightful story showed its universal appeal when published serially, and the volume amply carries out the intention of the author. Besides its practical interest for the thousands of city dwellers who have dreamed of having a country home, the story is one of such reality, humor, and interest as to ensure it the widest circulation in book form. Elaborately decorated. \$1.65

THE FIRST BOOK OF FARMING. By CHARLES L. GOODRICH. No one interested in farming, old or young, can fail to appreciate this book, for it really gives the fundamental knowledge of how to conduct a farm with the least expense and the largest return. There are 63 full pages of helpful illustrations. The price is extremely low for a work of such value. 63 pages of photographs. Price, \$1.10

NATURE BOOKS

AMERICAN FOOD AND GAME FISHES. By DAVID STARR JORDAN and B. W. EVERMANN. Fills a long-felt need in popular scientific works, being a full account of the life-histories and methods of capture of North American food and game fishes. The only book in existence which will enable the amateur readily to identify species new to him. With 10 lithographed color plates, 100 photographs of live fish in the water, and 200 text cuts. Price, \$4.40

NATURE BIOGRAPHIES. By CLARENCE M. WEED. This volume is a sort of personal acquaintance with the lives of the more common butterflies, moths, grasshoppers, flies, and so on, the sort of fascinating details of these insect existences which make the reader want to go out and study these every-day marvels for himself. 150 photographic illustrations. Price, \$1.50

THE BROOK BOOK. By MARY ROGERS MILLER. A brook is one of the most living and companionable features of the landscape, and few people, even the most ardent nature lovers, realize what an endlessly interesting study its changes and its throbbing life afford. It is a fascinating subject which the author (well known as a teacher, lecturer, and writer connected with the Nature Study Bureau at Cornell) handles with much ability. 16 photographs. Price, \$1.50

OUTDOORS. A Book of the Woods, Fields, and Marshlands. By ERNEST MCGAFFEY. Papers on out of doors, showing a love of nature and keenness of observation and power and beauty of description rarely surpassed. Price, \$1.25

NATURE AND THE CAMERA. By A. RADCLIFFE DUGMORE. Mr. Dugmore is an expert in the new movement of photographing live birds, animals, fish, flowers, etc. His works brought him so many requests for information, that he has set down here a full and detailed account of his methods. From the choice of a camera to questions of lighting, and to the problem of "snapping" shy birds and animals in their native haunts, every step is explained so simply as to be easily comprehended, even by the beginner. 53 photographic illustrations. Price, \$1.50

THE

American Forestry Association

Officers for 1908

President

HON. JAMES WILSON, Secretary of Agriculture

Vice-presidents-at-large

DR. EDWARD EVERETT HALE	GEO. T. OLIVER
N. J. BACHELDER	DR. B. E. FERNOW
GEO. FOSTER PEABODY	GEO. C. PARDEE
RUTHERFORD P. HAYES	ALBERT SHAW
W. W. FINLEY	J. T. ROTHROCK

CHARLES R. VAN HISE

Advisory Board Selected by Affiliated Organizations

SILAS W. GARDNER	C. A. SMITH	W. W. KNOX
H. H. WHELESS	GEORGE E. STONE	A. L. HAYES
JAMES INNES	ALLEN CHAMBERLAIN	FREDERICK S. UNDERHILL
C. H. KEYS	D. E. KLINE	ROBERT L. LIPPINCOTT
ROBERT C. LIPPINCOTT	E. F. SAWYER	S. B. ANDERSON
GEORGE F. CRAIG	F. E. WEYERHAEUSER	ROBERT A. JOHNSON
	KENT SHEPPARD	

Members of Board Designated as Vice-Presidents of Association

N. W. McLEOD	LEWIS DILL	J. T. WYLIE
WILLIAM IRVINE	EDWIN A. START	D. E. KLINE
GEORGE H. HAMPTON	SAMUEL B. VROOMAN	B. W. PORTER

Secretary, THOMAS ELMER WILL, Washington, D. C.

Assistant Secretary, FRANK GLOVER HEATON, Washington, D. C.

Treasurer, OTTO LUEBKERT, Washington, D. C.

Directors

JAMES WILSON	WILLIAM L. HALL	W J McGEE
GEO. P. WHITTLESEY	GEORGE K. SMITH	PHILIP W. AYRES
JAMES H. CUTLER	WILLIAM S. HARVEY	ROBERT GARRETT
HENRY S. GRAVES	H. A. PRESSEY	LIGON JOHNSON
F. H. NEWELL	ASBURY F. LEVER	FILIBERT ROTH

Application for Membership

To THOMAS ELMER WILL

Secretary American Forestry Association

1417 G Street N. W., Washington, D. C.

Dear Sir: I hereby signify my desire to become a member of the American Forestry Association. Two Dollars (\$2.00) for annual dues are enclosed herewith.

Very truly yours,

Name _____

P. O. Address _____

The American Forestry Association

President—HON. JAMES WILSON

Secretary of Agriculture

The American Forestry Association was organized in 1882, and incorporated in January, 1897. It now has over 7,000 members, residents of every State in the Union, Canada, and foreign countries. From its origin it has been the tireless friend of the forests.

The object of the Association is to promote the preservation, by wise use, and the extension of the forests of the United States; its means are agitation and education; it seeks to encourage the application of forestry by private owners to forest holdings, large or small; and it favors, especially, the establishment and multiplication of National and State forests, to be administered in the highest interests of all.

The Association seeks as members all who sympathize with its object and methods, and who believe that our natural resources constitute a common heritage, to be used without abusing and administered for the common good. Seeking to conserve our supplies of wood and water, the Association appeals especially to wood-producers and users, including owners of wood lands, lumbermen, foresters, railroad men, and engineers; and to those dependent upon equable stream flow, as manufacturers, irrigators, employers of water power, and those engaged in internal commerce.

The Association meets annually in Washington. It publishes, monthly, FORESTRY AND IRRIGATION, the magazine of authority in its special field. The list of contributors to this publication includes practically all persons prominent in forest work in the United States, making it alone worth the cost of Annual Membership in the Association.

The dues, covering a subscription to FORESTRY AND IRRIGATION, are as follows: Annual—For Annual Members, \$2; for Sustaining Members, \$25; Total, with exemption from all other payments—for Life Members \$100; for Patrons, \$1,000.

THOMAS ELMER WILL, Secretary.

Address: 1417 G Street N. W., Washington, D. C.

WANTED—WORKERS

Hustlers who can and will secure
subscriptions for

Forestry and Irrigation

Young men and young women; students or others. Those interested in
Forestry and the conservation of Natural Resources preferred. To
such we offer pleasant and dignified employment at the
HIGHEST CASH COMMISSION

For terms, etc., address,

Circulation Department

FORESTRY AND IRRIGATION

1417 G Street N. W.

Room D

WASHINGTON, D. C.

Make Your Unproductive Land Profitable

Hundreds of acres too far away from the great irrigation canals can be made profitable at small expense. You can have running water in your house and at your barn. The only things necessary are a running stream or spring on any part of your ground and the installation of a

NIAGARA HYDRAULIC RAM

The U. S. Government is using this pump for irrigation purposes, because it does such good work. It's cheaper than a windmill or gasoline engine. Works continuously without cost. Send for booklet B, and guaranteed estimate. We furnish Caldwell Tanks and Towers.
NIAGARA HYDRAULIC ENGINE CO., 140 Nassau St., New York. Factory, Chester, Pa.



Nominations for Membership

The activities of the National Office of the American Forestry Association are limited chiefly by its resources. These are derived almost wholly from its members in the form of dues. Every member is urged to aid in increasing the membership. Kindly fill out the enclosed blank form, lengthening the list, where possible, by attaching and filling blank sheet. The list should then be sent to

THOMAS E. WILL

Secretary American Forestry Association
1417 G Street Northwest, Washington, D. C.

I hereby nominate the following persons for membership in The American Forestry Association:

Name

Address

.....
.....

Signed.....

What is "Soil Culture"?

What is The New System of "Scientific Agriculture"?

Nothing more than judgment and common sense shown in handling the soils of our western tracts so that the rainfall may be held for immediate absorption by the root fibres of growing crops. It's a system that every farmer—East, west, North or South—can profitably follow. It is the very essence of practical agriculture. It is a distinct revelation to Eastern and Central State farmers who have been depending on 24 to 30 inches of rainfall yearly. They wonder how our Colorado "Scientific" farmers can gather such remarkable crops on lands once called "half deserts."

Happy Prospects. Denver is rubbing its eyes, stirring itself in wonder, gazing in admiration at the great tracts bursting into green and growing crops of alfalfa, corn, wheat and fruits, etc. (*Explanation of cuts below.*) White-faced farm houses, broad-gabled barns, bowing maples, pink-blossomed orchards, dairy farms, wheat and corn fields greet gladdened eyes at every angle. Campbell's "Soil Culture" is making wealth for Colorado farmer and manufacturer, for merchant and implement maker, for mail order concern and local merchant.

"Young Man! Go West," said Horace Greeley. Within a decade or two there will be little "West" left. Hundreds of thousands have heeded the call of the early fifties. Thousands now are heeding our call.

"Hurry to Colorado" Now

Buy with a few hundred dollars one of the cheap tracts now so generously offered. Start to be independent.

Start Small. You can start on a small acreage—40 to 80—at prices running from \$8.50 to \$16 per acre. We don't insist on all cash. A fifth or smaller part is sufficient if you are a settler.

Location. The Bijou Ranch is only 42 miles from Colorado Springs, 65 miles from Denver, 5 miles from two easily reached railroads—the Union Pacific and Rock Island. A new branch of the Rock Island has recently been surveyed thro' the property.

Crops. Alfalfa roots and grows rapidly, sucking up through its great "root pipes" the "sheet water" which underlies the Bijou Ranch. 35,000 acres overlay this great supply of moisture that comes as near as 6 feet to the surface. This is not a lake or open cave, but is the under-soaking of the melting snows from the "earth ridge" formed by the Eastern slopes of the Rockies. This water is easily, in most places, reached by the average hand pump. Corn, wheat, sugar-beets, oats, speltz, rye, potatoes, barley, fruits of all kinds, vegetables, grow under this system of Soil Culture.

New Book, "The New Colorado" Free

Here's a fast passing opportunity. Here are cheap lands, fertile soil, railroads, possibilities for great increase in land values, healthful climate, schools, etc. Embrace this chance. Do it now. Get in line with hundreds of others. Send for our new book—free, yet valuable—"The New Colorado." It's a question-answerer. Shows ten-inch map giving the location of lands, distance from great business centers, markets, shipping points, schools, churches, etc. It tells how much money you'll need to get started; how to figure profits; describes the glorious climate with its sunny days and life-renewing nights, etc., etc.

Write for a copy today to Dept. 17

**The Farmers Land and
Loan Co.,
145 LaSalle St.,
Chicago, Ill.**

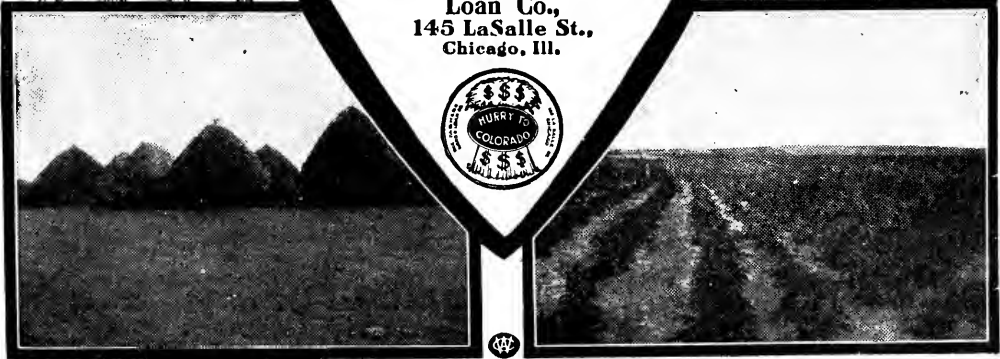

FARMS near the National Capital, suitable for all classes, and purposes, reasonable in price, advantage of best market in the country. Healthy and delightful climate.

Write us for particulars.

NATIONAL FARM AGENCY

1407 N. Y. Ave. N. W.

Washington, D. C.

REAL ESTATE
Bought, Exchanged and Sold

No matter where located, will buy or sell your business or Real Estate for CASH. Real Estate loans at lowest rates.

CLARENCE E. TUCKER

Metropolitan Bank Building

Washington, D. C.

OUR PROPOSITION

to responsible, willing young men and women is a good one. We pay the highest cash commission for subscriptions. The work should appeal particularly to students in schools of Forestry and similar institutions. A postal card request will bring particulars. Address

CIRCULATION DEPARTMENT

FORESTRY AND IRRIGATION

1417 G Street N. W.

Room D

Washington, D. C.

Biltmore Forest School

Biltmore, N. C.

Theoretical and practical instruction in all branches of applied forestry.

The course comprises eighteen months; twelve consecutive months of lectures and field work, and six months of practical experience.

Object lessons within the mountain estate of George W. Vanderbilt, comprising 120,000 acres where forestry has been practiced since 1895.

For further information apply to

C. A. Schenck, Director

Colorado School of Forestry

Colorado Springs, Colo.

Three years' course in
TECHNICAL AND
APPLIED FORESTRY

Winter Term at Colorado College, Colorado Springs. Summer Term at Manitou Park, on the borders of the Pike's Peak Forest Reserve.

Tuition

Sixty Dollars a Year

For further particulars apply to

Wm. C. Sturgis, Dean

Colorado Springs, Colo.

FORESTRY AND IRRIGATION

FRANK GLOVER HEATON }
THOMAS ELMER WILL } *Editors*

CONTENTS FOR JULY, 1908

PORTRAIT OF HON. GIFFORD PINCHOT.....		<i>Frontispiece</i>	
<i>Illustration for "The New Commission," page 380</i>			
THE WORK OF THE SPOILERS—By A. B. Plowman	363		
<i>Illustrated</i>			
THE DEATH OF THE FOREST— <i>Poem</i> —By Lillian H. Shuey.....	369		
WATER CONSERVATION IN ARIZONA—By W. B. Mershon.....	370		
<i>Illustrated</i>			
THE NEXT GENERATION'S REPROACH AGAINST ITS ANCESTORS— <i>Poem</i> —By Richard H. Douni Boerker.....	372		
FOREST TREE NURSERIES—By Q. R. Craft	373		
<i>Illustrated</i>			
THE NEW COMMISSION.....	380		
<i>With frontispiece illustration</i>			
WORK IN A NATIONAL FOREST—By Charles Howard Shinn.....	383		
EDITORIAL			
The Conservation Commission.....	387	Noninate Members	392
"United We Stand".....	388	Conservation of Human Resources.....	392
Mountain Forests and Floods.....	390	The Forestry Fight in Denver.....	392
By Way of Reply.....	396	"Bureaucracy"	393
The Question of Snow.....	391	Government "Taxes"	394
Where There Are No Snows.....	391		
NEWS AND NOTES			
Irrigation Development in Washington.....	395	Government to Study Shelterbelts.....	399
Reclamation Work for Socialist Settlement.....	395	Wood-pulp Report	401
Big Project for Palouse Country.....	397	France's Far-sighted Forest Policy.....	402
American Irrigation Scheme.....	398	The American Nile	403
More Resolutions	398		
THE DRYAD'S LAST STAND— <i>Poem</i> —By Victoria Elisabeth Gittings.....	404		
<i>With decorations</i>			
IN THE DEPARTMENTS			
Washington National Forest.....	406	Forest Service Supply Depot at Ogden.....	409
Reclamation in the Northwest.....	406	Map of the Grant's Pass Quadrangle.....	409
Would Prevent Spring Floods.....	408		
FOREST CONSERVATION—By R. A. Long	410		
<i>Paper read at the White House Conference</i>			

FORESTRY AND IRRIGATION is the official organ of the American Forestry Association. Price, \$2.00 per year, including Annual Membership in the Association. Entered at the Post office at Washington, D. C., as second-class mail matter

Published Monthly at
1417 G STREET N. W. WASHINGTON, D. C.

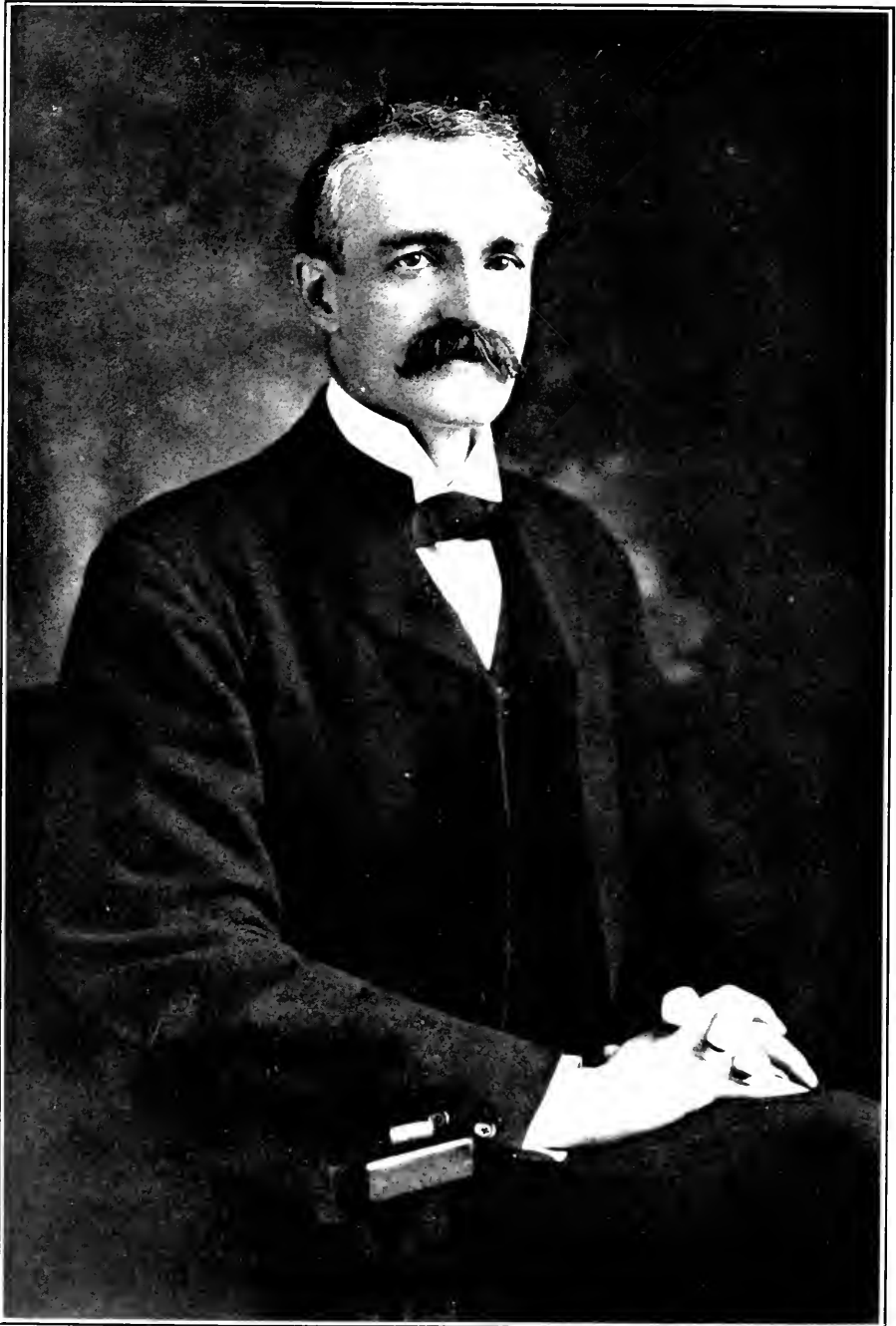

HON. GIFFORD PINCHOT

Chairman of the Executive Committee of the Newly Appointed Commission on the Conservation of Natural Resources

FORESTRY AND IRRIGATION

Vol. XIV

JULY, 1908

No. 7

THE WORK OF THE SPOILERS

How the Finest Hardwood Forests on the Continent, in Western Ohio, Have Been Ravished—The Result

By A. B. PLOWMAN, Department of Botany, Beaver College

IT IS the writer's purpose to record briefly in this paper some of the facts gathered in a study of the forestry conditions in Western Ohio in the summer of 1907.

Here, as everywhere in the United States, probably the most striking fact in connection with the whole problem of timber-supply is the unprecedented advance in the prices of lumber during the last few years. The graph chart, Fig. 1, based upon quotations supplied by one of the largest retail lumber dealers in Western Ohio, will serve to show, better than figures or any mere statement in words the nature of this advance in prices since 1890. The conspicuous feature of this chart is the excessive steepness of the graphs for the last period represented, 1905-1907. This is especially noticeable in the case of plastering lath and cedar shingles. We observe that in the seventeen years covered by the chart, the price of lath has advanced one hundred forty per cent.,

while the price of shingles has increased ninety per cent. But even more significant is the fact that, of the one hundred forty per cent. advance, sixty per cent., or three-sevenths, has occurred in the last two years; and of the ninety per cent. advance on shingles, seventy-four per cent., or nearly five-sixths, is included in the same two years.

Of course these prices are but little, if at all, dependent upon local forestry conditions, but they constitute a highly important element in the local problem of timber supply. And, in passing, it may be remarked that in the region under consideration, there is a rather general belief that the present high tide in timber prices is as largely due to tariff, freight rates, and corporation control as to any actual or threatened failure in the natural supply, either here or elsewhere. Comment is unnecessary.

The territory included in this study is limited to the western tier of coun-

ties in the State of Ohio. These constitute an area about twenty-five miles wide and one hundred eighty miles long, extending from the Ohio River to the latitude of Lake Erie. Practically all of this area lies in the range of graphical activity, and morainic features are conspicuous throughout. The

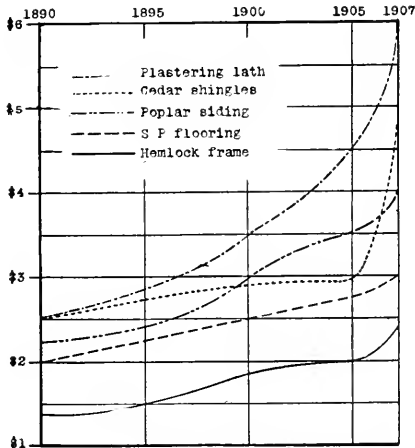

Graph chart of retail prices of lumber in western Ohio.

southern portion, to a little above the middle of Darke County, is a rolling, low hill country, while the northern portion is quite flat. The prevailing soil of the southern portion is a rich red clay, except in the narrow stream valleys, which are made up of a heavy black loam of remarkable fertility. In the northern part the soil is somewhat less fertile, consisting in part of sand, and elsewhere of white clay, which requires expensive drainage to yield the best results for agriculture. The lowest part of the section is, of course, along the Ohio River, where the elevation is about five hundred feet above sea level. Darke County is the highest part, practically all of it being somewhat more than one thousand feet above sea level. The prevailing bed-rock is limestone which crops out very generally in the southern part, and is quarried in considerable quantities for the manufacture of lime, and, also, to some extent for building stone. The rainfall is fairly uniform over the region, amounting to a little more than forty inches per an-

num in the northern portion and a little less than that amount in the southern portion.

The region under consideration constitutes a belt through what was at one time probably the finest hardwood forest in the United States. Here grew, in a high degree of perfection, white and red oak, walnut, hickory, maple, elm, beech, locust, sycamore, wild cherry, cottonwood, poplar, Kentucky coffee-tree and chestnut, not to mention several less valuable kinds of trees. The quality of this timber was the very finest throughout the entire belt.

As in every timber country, the first work of the pioneers in this region was to clear sufficient land in the forest to raise the necessary crops. Much of the finest timber was "deadened," or girdled, and when, after two or three seasons it had dried sufficiently, it was felled in great heaps and burned. Only the straightest most perfect sticks of walnut and oak were used in building the log houses and barns. The sterling quality of this timber is manifest in the remarkably well preserved log structures still standing in considerable



A Typical White-oak Grove

numbers throughout the region. The roofs of these buildings were made of clapboards, rived with frow and beetle from only the finest sticks of oak, and it was not uncommon for such a roof to last for forty years or more. It often happened that several trees would be cut down before a perfect one was found for the making of clapboards; all the others were left to rot where they fell.

During the first half of the last century there was a large demand for tanbark to supply the needs of the growing leather industries of Cincinnati and the neighboring towns. To meet this demand, the oak timber was ruthlessly slaughtered over an area of seventy-five to one hundred miles radius. The fine logs, then useless, were piled together and burned. These old-time

would be better off *without a timber-tree standing in it!*" This is no doubt an extreme case, but there is certainly very little sentiment in the region in favor of forest preservation or renewal. The inevitable result of such an attitude on the part of the people is being reached at a rapid rate. Over most of the region the first-class timber disappeared several years ago, and the



WASTEFUL METHODS OF LUMBERING

Total Clearing of Land is Only Method in Use in Western Ohio

log-rollings, with their attendant barbecues, were the festival occasions of the frontier communities.

To the early settlers these forests constituted the arch enemy, to be driven back and destroyed by ax and fire. Little did these men think of the value of the forests. To them it meant only a fight for life and success against the forces and conditions of nature. Unfortunately, this instinct for timber destruction, born of necessity among the pioneers, has developed among their descendants into a blind, unreasoning mania. One prominent landowner and stockman of Drake County recently expressed the view that "the country

second- and third-class supply is rapidly following.

Immense damage to the timber of this region has resulted from too close pasture of the woodlands. The writer had an opportunity to keep under observation for several years a tract of fine oak timber in which were kept large numbers of hogs. The soil was constantly overturned by the hogs, and many of the smaller roots of the trees were exposed and destroyed. After a few years the trees began to die at the tops, and the owner was obliged to sell the timber for only a fraction of what it would have been worth at the present time if it had been more carefully pre-

served. Close pasturing by cattle and sheep has proved equally destructive in many cases.

From replies to inquiries directed to the Commissioners of several counties it has been learned that in all but two of the counties the local supply of timber has failed to meet the demand for fence posts, barn-frames, etc., for from five to twenty-five years. Naturally this depletion is more complete and of longer standing in the southern part of the zone, in the region of earlier settlement and more dense population. The counties reporting an excess of timber and considerable exportation are Darke and Williams. Darke County is at present shipping out small quantities of oak, walnut, elm, ash and hickory. A leading dealer in lumber in that county estimates the total hardwood cut of Darke County for 1907 at nearly five million feet. He also estimates the present stumpage of the county at over one hundred fifty million feet, which the present writer has reason to believe is too high an amount, even including low-grade culls. As for *first-class timber*, as that would have been interpreted twenty years ago, there is none of it left. Williams County is shipping less, and has probably a smaller supply but it is of somewhat better quality, as it has not been so thoroughly picked over.

The price of white oak timber on the stump last season was reported as from \$20 to \$40 per thousand; the lower prices prevailing in the southern part of our range, the higher prices in the north. The explanation of this is to be found in the fact that the remnant of merchantable timber in the southern part is of very low grade, and rarely of sufficient quantity to justify the installation of local mills. Of significance in this connection is the fact that a large tight-cooperage factory which had operated for several years in Darke County, was forced sometime ago to close down for lack of suitable material. A hardwood lumber dealer of the same county reports a slight falling off in the price of finished hardwood lumber in the last few

years. This would be a most remarkable state of affairs, were it not for the fact that the product has declined in quality even more rapidly than prices on first-class materials have advanced. In like manner we may account for the fact that prices of railroad ties, cord-wood, etc., have advanced less rapidly in this region than the failing supply would seem to warrant.

While the general relation of climate to forests is yet a mooted question, it seems fairly well established that, in the region under consideration, local "blizzards" are more frequent and more severe, while the summer winds are more often dry than they were a generation ago. Spring floods and summer droughts, formerly quite unknown, are growing more common. Many of the hills, denuded of their forests and later of their soil, are now quite barren. Throughout the region the growing of fruit orchards is becoming constantly more difficult. This is, no doubt, due, in part at least, to the increased exposure of the trees to an ever more fickle climate, as well as to the more persistent attacks of tree-infesting insects, which are deprived at once of their natural enemies. For as a consequence of the destruction of the forests the insectivorous birds have been greatly reduced in numbers.

The southern four counties in this range have long been noted for their splendid natural water supply. Along every stream valley the ground-water outcrops at frequent intervals from strata of coarse sand and gravel overlying the limestone. Many of these springs for a hundred years never known to fail, have, since the removal of the back-lying forest, become but "wet-weather springs," absolutely dry in late summer. Over large parts of this area the ground-water level has fallen several feet in the last twenty years, so that wells have had to be dug or drilled to a greater depth to insure a constant water supply. At the same time the problem of drainage is growing more difficult. Small creeks and open ditches, formerly well filled with water the year

around now run almost dry during a good part of the summer, and become choked with a rank growth of weeds which must be removed, else the stream will be completely filled with silt at the next flood season.

Owing to the high fertility and excellent quality of most of the soil in Western Ohio, it seems quite unlikely that there will ever be any extensive plant-

(*Gleditschia triacanthos*), which, when close grown in good soil, is tall, straight, and smooth. This tree makes most excellent fence posts, which easily outlast two sets of oak or cedar posts. The honey locust also grows rapidly on the denuded hills of the region, and would prove a very profitable crop in such situations. The common or black locust (*Robinia Pseudacacia*)



NATURAL REFORESTATION

Mixed Growth That Calipers Six to Eight Inches Eighteen Years After the Land Was Totally Cleared

ing of forests in that region. That reforestation would be an extremely simple matter is at once evident from some of the views accompanying this paper. Two of the views herewith show a small tract of eighteen-year-old growth which sprang up after complete clearing of the land. The original forest was composed mainly of white oak, American elm, walnut, and hickory, and a considerable percentage of ash and honey locust. This tract has afforded pasture for a few cattle, and is in excellent condition. With proper care and a very little improvement cutting, it will in a few years begin to yield good returns. The most rapid growth is made by the honey locust

is very generally distributed over Western Ohio, but its timber is of little value, owing to the destructive attacks of the locust borer. No doubt this tree could be grown with profit if planted in large groves and properly cared for.

As stated before, however, there is but little if any interest shown by the people in the matter of tree planting. It is true that shade-trees are quite commonly planted along the streets of towns and villages, and in public grounds generally, but this practise has not yet extended to the public highways, or even, to any extent, to the rural school-grounds. Most of the counties report a growing interest in Arbor Day among the schools, but that

interest seems for the most part to be only short-lived and ineffective. The trees most commonly planted for shade and ornament are soft maple, American elm, and Carolina poplar. Fortunately most of the region has gotten over the craze for the unsightly *Catalpa bignonioides*. Evergreens are but little known, except for cemetery and lawn decoration. *Juniperus communis* grows

give any attention to preserving and making the most of the farm wood-lot. No precautions are taken to prolong the usefulness of fence posts and timber. From sheer necessity, substitutes for wood in house construction are being introduced. Brick, stone, and concrete blocks are slowly coming into use for this purpose. Fences, until recently built of rails, are now more com-



MIXED SECOND GROWTH

Honey Locust, Ash, Hickory and Walnut. Eighteen Years Old and Five to Seven Inches in Diameter

native to some extent as an insignificant shrub. No doubt the more useful oaks and walnuts would be more generally planted if the people knew how to handle these less tolerant trees successfully.

In no region is there more urgent need of popular education in matters pertaining to forestry and timber supply. For generations these people have been learning and practising the art of forest destruction. Before they can be expected to show an active interest in the preservation and renewal of forests, there must be created in their minds a totally new conception of the whole problem. Very few of the land owners

commonly made of wire. Yet, the shortage of timber and the consequent inconvenience are growing more apparent every year.

The area which we have chosen for study represents in cross section, as it were the conditions of the entire Ohio Valley. For more than a hundred years the people have been striving to get rid of the finest hardwood forests in America. Success has all but crowned their efforts, and they have scarcely begun to realize at what tremendous cost their victory has been bought. Reforestation would be a comparatively easy matter, but the high agricultural value of the land is practically prohibitive.

All that is left for this region to do is to make the most of the remnant of its forests, and to urge upon the Government the absolute necessity of establishing, upon less valuable lands, hard-

wood forest reserves, which, under wise administration, may make up in some measure for the reckless timber destruction in the past at the hands of private owners.



THE DEATH OF THE FOREST

By LILLIAN H. SHUEY

THE fiat went forth from the spoilers—
 The myrmidon sons of men—
 That the forest, the warder of rivers,
 Should pass from the valley and glen;
 The forest, embracing the passes,
 Where the drifting sea-clouds bide,
 Should lie as low as the heather—
 Should die on the mountain side.

And the murmuring groves on the ridges
 Heard in the morning still
 The ax-blows resounding, repeating
 The rumble and roar of the mill.
 The vast forest mourned to the brooklets:
 "Beloved, the hour has come,
 The Day God will drink at thy spring-pools,
 And the voice of thy music be dumb.

"No more wilt thou well to the valleys
 Where children are glad and sweet.
 No more wilt thou mirror their faces,
 And ripple around their feet.
 Farewell! lovely streams, overflowing,
 The grasses thou lovest will fail;
 No more wilt thou gleam for the homestead,
 The orange and peach in the vale."

The birds flew far and were silent,
 The west wind sobbed in pain,
 And bore in the eve her teardrops
 To the barley blooms on the plain.
 The forest stood, lofty, majestic—
 The redwood, and cedar, and pine—
 The forest, preserver of nations,
 The crown of God's great design.

But the deed was done in its madness,
 And the wind-swept mountains bare
 Grieve for the cool, sweet bowers
 And the kiss of raindrops there.
 Men in the parching plain-lands
 Their long rain prayers avow,
 But the bread and the wine are taken,
 And God does not answer now.

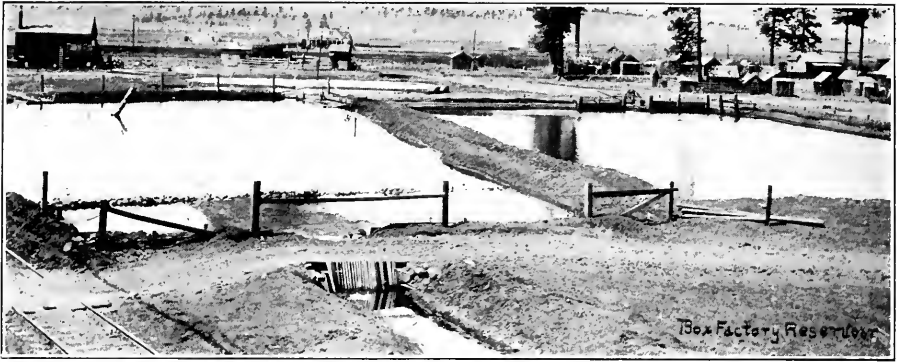

Box Factory Reservoir

WATER CONSERVATION IN ARIZONA

From a Letter from W. B. Mershon, Saginaw, Mich.

ARIZONA is a remarkable country. It is noted for its desert character; yet at the same time it has natural forests and a lumber industry. The desert character of the country is being changed by irrigation, for which extensive reservoirs have been and are being constructed. The illustrations with this article, however, show that reservoirs in Arizona may utilize the scanty water resources of the region in other ways than by irrigation.

The Saginaw & Manistee Lumber Company, a Michigan concern, is engaged in cutting lumber in the neighborhood of Williams, Ariz. For power

the company uses steam, and water is obtained from reservoirs filled by the rain and by the melting of the snow in the mountains. When the company took hold of this enterprise, several years ago, they found themselves confronted with a serious shortage of water. There had been a drought for several years, and everything had dried up. They were compelled to haul water in tank cars from Winslow, via the Santa Fe Railroad. Their water supply in one year cost them \$30,000, and they were considering the abandonment of this piece of lumbering as unprofitable.

The Perrine reservoir, shown among



Causman-Arey Reservoir



Reforestation around Reservoir

the views, had cost \$15,000 to construct. It stood empty, and by reason of lack of water and disintegration, it looked as though it might cost still more.

About four years ago, however, things began to look different in Arizona. There was snow in the mountains in the winter time; and more frequent rains in the valleys cheered the residents. Additional reservoirs were made, and every bit of water conserved where it was possible to do so.

The pictures herewith were taken something over a year ago, and at that time the manager, in sending them to Michigan was able to accompany them with the cheering statement that he believed the water accumulation then on hand was sufficient to last more than a year, even if there were not another drop of rain.

The views are interesting as show-

ing the different classes of reservoirs or catch basins used in Arizona for saving water. Evaporation is considerable in that climate; yet it is believed that these bodies of water will be sufficient to keep steam in the engines during the long drought period. Lumbering in Arizona is said to be a hard proposition, however, all costs being double or more those of more favored localities.

The views are interesting further in showing attractively the growth on the margins of some of these water basins. The growth is the western yellow pine.

These pictures are furnished by Mr. W. B. Mershon, an officer of the lumber company, and a member of the American Forestry Association and of the Michigan Forest Commission.

Mr. Mershon is doing some extensive tree planting on land he owns in Michigan. On bottom lands along a river he is putting out a considerable

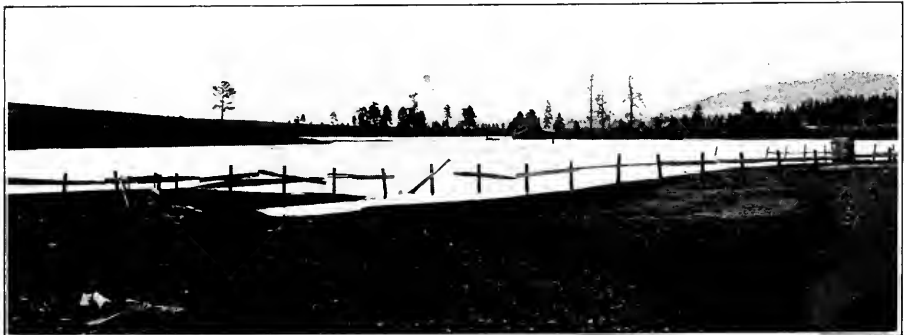

Water Storage in Arizona

quantity of basswood, which, being a rapid grower, native to the locality, and more valuable for its white wood before reaching maturity, may give a harvest sooner than some other species. The white and Norway pine planted on higher land may take seventy years to mature, but Mr. Mershon says that by the time his children are as old as he is there will be so much of value on this piece of land, now waste, that they will appreciate it as a fine legacy.



THE NEXT GENERATION'S REPROACH AGAINST ITS ANCESTORS

By RICHARD H. DOUNI BOEKER, Hanover, N. H.

O Forest! O divine inspiring creation!
 Thou temple of the sylvan gods!
 I love to visit thy secret dells
 And hear thy birds' sweet melody.
 I love the shade of the murmuring pines,
 The fragrant zephyrs and cooling breezes,
 And to sit by the side of the meandering brook,
 As it babbles and warbles its melodious song.

O Forest! O divine inspiring creation!
 Thou temple of the sylvan gods!
 Within whose secluded haunts and glades
 Played the wood-nymphs of ages past;
 Thou, the home of primitive races;
 Thou, inspiration to poets of all ages;
 Indispensable to man and beast;
 Thy time has come, thy race is run.

O Ancestors! Sons of an accursed race,
 Desecrators of our leafy temples!
 Within whose secluded haunts and glades
 The wood nymphs never more shall play!
 O Forest! once the home of primitive races;
 Once the inspiration to poets of all ages;
 Indispensable to man and beast;
 O, grief! O, woe! thy race is run.

O Ancestors! Sons of an accursed race,
 Who have left but desolation in your path!
 Where are the birds, the murmuring pines,
 The fragrant zephyrs, the babbling brooks?
 Down the valley rushes the turbulent flood,
 Over our land sweeps the fire of hell;
 Grim Death is master: Desolation king.
 O, grief, O, woe! 'Tis done, 'tis done.

FOREST TREE NURSERIES

By Q. R. CRAFT

(Illustrations by Courtesy of Mr. G. W. Hill)

THAT the amount of forest planting done each year is increasing is evident from the uniform report of increased sales by the nurserymen. A nurseryman at Aitkin Minn., last year shipped four hundred thousand jack-pine seedlings to Nebraska alone. There are now nine Government nurseries where seedlings are grown for planting on the National Forests, twenty-one state nurseries, and 137 dealers in nursery stock, many of whom grow their own stock.

A great many planters are beginning to grow their own seedlings for planting, and shade screens, preventives for damping off, transplanting, and root pruning are becoming subjects of discussion.

There is considerable difference of opinion as to the comparative merits of high and low screens, and though many favor the former, Mr. David Hill, of Dundee, Ill., after a thorough trial of both kinds, gives it as his opinion that low screens in frames of four feet square, are preferable. It is the practice of Mr. Hill to transplant all conifers when one year old from seed (except those of rapid-growing species, which are sold for special purposes at the age of one year). Then each subsequent spring, until sold, the trees in the transplant rows are root pruned, the pruner being set one-half inch deeper each time. The effect of transplanting is to stimulate root development and make the little trees stocky and hardy. The difference in the trees is noticeable in the accompanying illustrations.

With some nurserymen there is a question as to the advisability of root pruning because of the belief that injury to the root permanently interferes with its natural development, and that

the wounds may invite the entrance of fungi and insects. In answer to an inquiry on this point, A. Knechtel, a New York state forester, writes: "We have done no root pruning of evergreens, but in transplanting hardwoods root pruning has resulted successfully." Concerning the nursery beds, Mr. Knechtel adds:

"The sandy soil is enriched by the free use of black muck and ashes. The nursery is provided with a water tank, from which leads a system of water pipes, so that the trees can be irrigated when necessary. A free use of seed gives fully stocked seed beds. For a bed twelve by four feet, we use three-fourths pound to one pound of pine seed, and one-half pound to three-fourths pound of spruce seed, according to the size of the seed. Damping off is hindered by making the beds with convex surface, and by using screens as a box around the bed instead of boards, so that the trees get a free circulation of air. But the trouble has not been entirely prevented. This year the trees damped off very considerably. The use of sand thoroughly dried and sprinkled on the beds on close, damp days, has helped somewhat. Next year we shall try heated powdered charcoal. We may also devise some means by which a current of air can be passed over the beds artificially on such close days. Burlap is used instead of leaves as a covering for the winter."

As Mr. Perley Spaulding writes, in Bulletin No. 4, just issued by the Bureau of Plant Industry, damping-off diseases are great obstacles to the successful production of tree seedlings. Mr. Spaulding conducted experiments first in the greenhouse and then in the field in the New York State nurseries at

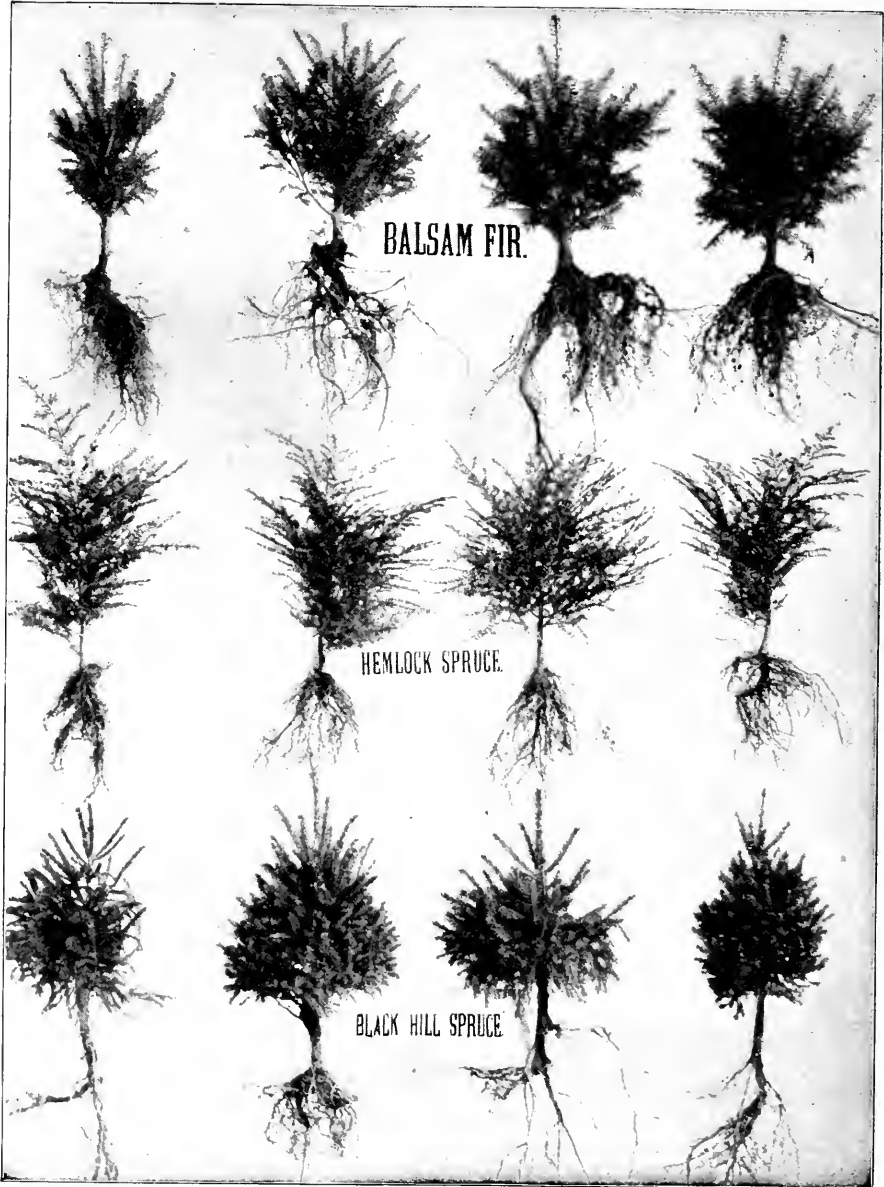

Three and Four Year Old Transplants of Balsam, Hemlock, and White Spruce

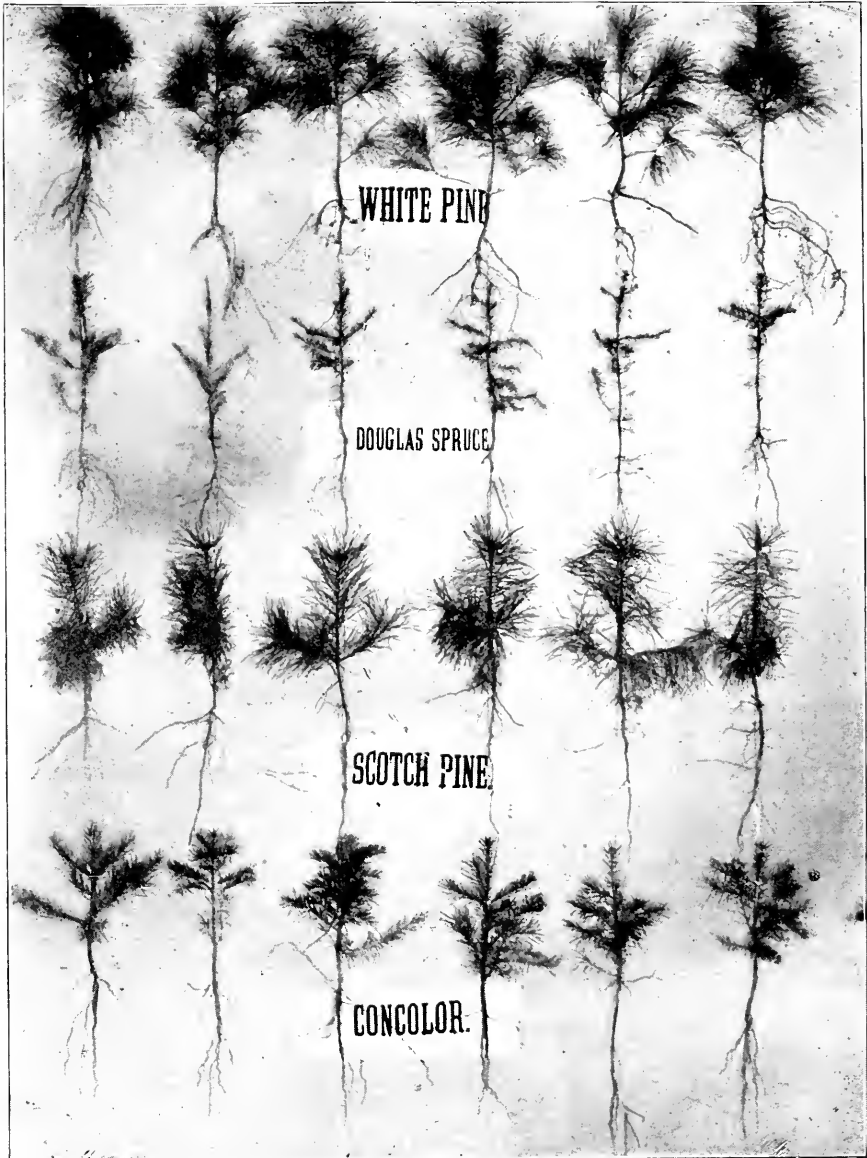

One-year-old Seedlings of White Pine, Douglas Fir, Scotch Pine, and White Fir



European Larch on the Farm of Mr D. Hill, at St. James. Minn.

Saranac Inn and the Vermont nursery at Burlington. The plots used were located in seed beds twelve feet long and four feet wide, each bed being divided into three equal parts, four feet square. The chemicals were used in fine powders, or in solutions, according to their original form and nature. The solutions were applied with an ordinary sprinkling can, while the powders were sifted on the beds with a very simple form of duster, having a perforated bottom, through which the powder was shaken. The solutions were applied to the soil before the seeds were sown, and then again about five days after the seedlings had come up. The powders were applied to the beds only after the seedlings had been up for three or four days. They were applied in very light coatings, which were renewed promptly after each rain. "This renewal," says Mr. Spaulding, "is not necessary except for a period of about two weeks, begin-

ning three or four days after germination, when the seedlings are most susceptible to the attacks of the damping-off fungi."

Sulphur was used in three forms, washed, resublimed, and precipitated; all of which gave favorable results, but the washed sulphur gave the best.

Dry Bordeaux Mixture was discarded because of the time required for its preparation. A mixture of one pound copper sulphate to ten pounds of lime, quickly prepared, proved equally effective. The lime should be slaked with as little water as possible, to obtain a fine powder. The powdered lime should be screened, and the ingredients thoroughly mixed.

Experiments with potassium sulphid and permanganate were devoid of results because of the absence of the disease from the plats treated. The use of formalin was disappointing.

The best results were obtained with



European Larch, Scotch Pine, Austrian Pine, and Black Walnut, Mr. D. Hill's Farm, St James, Minn.

weak solutions of sulphuric acid—one part in five hundred is recommended. It should be applied several days before sowing the seed until the soil is thoroughly drenched, and the treatment repeated after the seedlings come up.

"Flats," or wooden trays, one foot by three feet in size, and three inches deep, with a hole bored in the bottom near either end, offer a threefold advantage to the farmer or other person who wishes to grow a limited number of seedlings:

(1) The trays can be pulled out from under the lath screen and placed where a person can work on either side of it in weeding, or, better still, placed on a box or stand, breast high. Thus the worker avoids the strain on the back in bending over seed beds four feet wide. It will also be practicable for the farmer, on rainy days, to take several flats into a shed or barn and weed them under cover. One season's trial indicates that by the use of flats, the pines can be grown without the protection of a screen, on the north side of a barn or other building, where they receive the sun during the early morning and the late afternoon.

(2) The work of uprooting and packing the seedlings is practically

eliminated. The root apparently attains as great a length in the flat as when it goes down into a seed bed a foot or eighteen inches, but it takes a lateral course a little before reaching the bottom of the flat, so that at the time of transplanting, all that is necessary is to soak the contents of the flat thoroughly and then scoop the seedlings out by double handfuls.

(3) In transplanting to the permanent site from a home nursery no packing is necessary, since the flats can be loaded into a lumber wagon, or if there are more than twenty, on a hayrack, and transported several miles in the hot sun without injury. But the chief advantage is that when the seedlings are old enough for transplanting they are ready, without further preparation, to be loaded for transportation to the field, and if the ground for the plantation is made ready in advance they can be transplanted by two men on a rainy day quickly and with a likelihood of the best success.

The flats are especially suited for school nurseries, where each pupil can have his own flat, and at the close of school take it home where adequate care can be given the trees during the rest of the year.

Table I—Location and operation of National Forest nurseries

Location	When established	Kinds of trees grown	Trees on hand June 30, 1907		Trees furnished previously for planting
			1-year transplants	2-year transplants	
Halsey, Nebr.....	1902	Jack pine, western yellow pine.....	250,000	241,500
San Bernardino, Cal.	1903	Jeffrey pine, Indian cedar, incense cedar, Coulter pine..	150,000	230,000	103,900
Palmer Lake, Colo...	1905	Douglas fir, western yellow pine, Engelmann spruce...	7,800
Ft. Bayard, N. M....	1905	Western yellow pine.....	83,800	23,000	40,500
Santa Barbara, Cal..	1905	Jeffrey pine, Indian cedar, incense cedar, Coulter pine eucalyptus.	127,000	18,500	59,000
Salt Lake City, Utah	1906	Western yellow pine, Douglas fir, Engelmann spruce, Scotch pine, Norway spruce, European larch.	119,000
Ft. Stanton, N. M....	1907	Western yellow pine, Engelmann spruce, Scotch pine, limber pine, Douglas fir.
Las Vegas, N. M....	1907	White fir, Douglas fir, western yellow pine, sugar pine, Jeffrey pine, Scotch pine, Austrian pine.
Garden City, Kans...	1908	Black locust, honey locust, Russian mulberry, cottonwood, hackberry.

FORESTRY AND IRRIGATION

Table II—Operations of some of the State forest nurseries

State	Nurseries		Planting				Area of State forests
	Location	Trees Grown	Trees distributed in State in 1907	Trees planted in State forests	Total number of trees planted in State forests	Young trees in nursery	
Connecticut	Union Tract, Tolland County	White pine	300,000	50,000	400,000	1,000,000	1,400
Hawaii	{ Nuuanu Station { Puuhala Forest { Honolulu	{ Ironwood, blue gum (eucalyptus), black wattle, silk oak. } Black locust, black walnut, catalpa, hickory. } Cottonwood, black locust, honey locust, silver maple, catalpa, ash, elm, Russian mulberry, Osage orange. } White pine, white ash	26,100	30,000	397,687
Indiana	State Reservation, Henrysville, Clark County	Black locust, black walnut, catalpa, hickory.	800,000	300,000	2,000
Kansas	{ Dodge City { Ogallah	{ Cottonwood, black locust, honey locust, silver maple, catalpa, ash, elm, Russian mulberry, Osage orange. } White pine, white ash	83,964	179,500
Massachusetts	Amherst	White pine, white ash	57,400	300,000
Michigan	Roscommon	White, red, and western yellow pine, Norway and red spruce.	65,000	150,000	650,000	2,000,000	39,000
Minnesota	Pillsbury Reserve, Itasca State Park	Norway spruce, white pine	42,800
Mississippi	Agricultural College	Black locust, hickory, Osage orange, catalpa, southern pines.	50,000
New Jersey	Bass River Reserve	White pine	30,000	75,000	25,000	9,867
New York	{ Saranac Inn Station { State Fish Hatchery { Wawayick { Axton	{ White Scotch, red and western yellow pine, larch, spruce, hardwoods. } Catalpa, ash, yellow poplar, white pine, black locust, Norway spruce. } White pine, Scotch pine, European larch, Norway spruce, balsam fir, hardwoods.	450,000	2,633,100	1,674,750	1,548,450
Ohio	{ Wooster { Lancaster { Carpenter	{ Catalpa, ash, yellow poplar, white pine, black locust, Norway spruce. } White pine, Scotch pine, European larch, Norway spruce, balsam fir, hardwoods.	188,016	138,046	512,000
Pennsylvania	{ Greenwood, Huntingdon Co. { Asaph, Tioga Co. { Mount Alto, Franklin Co.	{ White pine, Scotch pine, European larch, Norway spruce, balsam fir, hardwoods. } White pine	215,000	2,388,800	761,000
Vermont	Burlington	White pine	30,000	30,000	350,000

Table III—Trees for forest planting of which seeds and seedlings are sold by more than ten dealers in the United States, and the States in which the dealers are located

State	Number of Dealers	Hardy Catalpa	Box Elder	Black Locust	Silver Maple	Rose, Muhl.	White Ash	White Elm	Honey Locust	Scotch Pine	Black Walnut	Osage Orange	Cotton Wood	Arbutus	White Pine	Norway Spruce	Red Cedar	Eucalyptus	Black Cherry	Bass Wood	Sugar Maple	Aus. Pine	Hackberry	W. Yellow Pine	Jack Pine	Green Ash	White Willow	Euro. Larch	Bur Oak	
California	1																													
Colorado	1																													
Connecticut	1																													
Florida	1																													
Georgia	4																													
Illinois	4																													
Indiana	2																													
Iowa	4																													
Kansas	4																													
Kentucky	1																													
Massachusetts	1																													
Michigan	1																													
Minnesota	6																													
Missouri	1																													
Nebraska	1																													
North Carolina	1																													
North Dakota	1																													
New Jersey	1																													
New York	4																													
Ohio	4																													
Oklahoma	2																													
Oregon	2																													
Pennsylvania	1																													
South Dakota	1																													
Tennessee	3																													
Texas	1																													
Washington	1																													
Wisconsin	1																													
Number of States in which sold	27	20	17	18	17	15	14	14	12	12	12	8	7	12	11	11	14	5	12	11	9	9	10	10	7	4	4	6	5	
Number of Dealers	137	41	41	38	33	32	30	28	25	21	20	18	17	17	16	16	16	15	13	13	12	12	11	11	9	8	6	6	6	

Besides the twenty-eight species given in the table, balsam fir is sold by fourteen dealers; white spruce by twelve dealers; Douglas fir by ten, yellow poplar (tulip-tree), blue spruce and Engelmann spruce by eight; white fir, coffee-tree, bitternut, cucumber-tree, Norway poplar, sycamore, and red oak, by seven; redbud, lincense cedar, pitch pine, and hemlock, by six; white birch, persimmon, beech, American holly, red sweet gum, tamarack, red spruce, sugar pine, and white oak by five; pine and scarlet oak by four; buckeye, Noble fir, lowland fir, sweet birch, chestnut, moosehorn, common catalpa, pecan, red pine, loblolly pine, lodgepole, sweet magnolia, red mulberry, black spruce, silver pine, chestnut oak, and pin oak, by three; yellow birch, white cedar, steelbark hickory, western larch, short-leaf pine, Spanish oak, yellow (black) oak, redwood and big tree, by two; yellowwood, Port Orford cedar, shagbark hickory, black gum, balm of Gilead, and slippery elm, by one.

THE NEW COMMISSION

National Body Named by President Roosevelt to Take Up Work of Conservation of Natural Resources—Make-up of the Commission

FOLLOWING up the suggestion made at the recent Conference of the Governors, held at the White House in May, President Roosevelt has appointed a Commission, which is charged with the work of paving the way for the development of a comprehensive plan for the conservation of the Nation's natural resources. The title of the newly appointed body is "The Commission on the Conservation of Natural Resources;" it is organized in four sections, or divisions, embracing forests, waters, lands, and minerals, and its purpose is to make a thorough examination of the condition of these natural sources of wealth—to take an inventory, as it were—and then to work out a plan whereby the Nation, cooperating with the several states, may undertake the work of conserving and utilizing these resources to the best possible advantage, avoiding, on the one hand, wastefulness and rapid exhaustion, and on the other hand, niggardly methods such as, if adopted, would clog the development of commercial enterprises in so far as concerns the forests, the waterways, the farms, and the mines.

The President's letter appointing the Commission was made public on June 8. In this letter the President goes deeply into the reasons behind the organization of the Commission. He details the various steps that have led up to the organization of a National body that is to formulate plans for a Nationwide system of rehabilitation of all natural sources of wealth, and names the men whom he has selected to undertake this tremendous task. The President's official announcement is here given in full:

The White House

Washington, *June 8, 1908.*

The recent conference of Governors in the White House confirmed and strength-

ened in the minds of our people the conviction that our natural resources are being consumed, wasted, and destroyed at a rate which threatens them with exhaustion. It was demonstrated that the inevitable result of our present course toward these resources, if we should persist in following it, would ultimately be the impoverishment of our people. The Governors present adopted unanimously a declaration reciting the necessity for a more careful conservation of the foundations of our national prosperity, and recommending a more effective cooperation to this end among the states and between the states and the Nation. A copy of this declaration is enclosed.

One of the most useful among the many useful recommendations in the admirable declaration of the Governors relates to the creation of state commissions on the conservation of resources, to cooperate with a Federal commission. This action of the Governors cannot be disregarded. It is obviously the duty of the Federal Government to accept this invitation to cooperate with the states in order to conserve the natural resources of our whole country. It is no less clearly the duty of the President to lay before the Federal Congress information as to the state of the Union in relation to the natural resources, and to recommend to their consideration such measures as he shall judge necessary and expedient. In order to make such recommendations the President must procure the necessary information. Accordingly, I have decided to appoint a commission to inquire into and advise me as to the condition of our natural resources, and to cooperate with other bodies created for a similar purpose by the states.

The Inland Waterways Commission, appointed March 14, 1907, which suggested the Conference of Governors, was asked to consider the other natural resources related to our inland waterways, and it has done so. But the two subjects together have grown too large to be dealt with by the original body. The creation of a commission on the conservation of natural resources will thus promote the special work for which the Inland Waterways Commission was created, and for which it has just been continued and enlarged, by enabling it to concentrate on its principal task.

The Commission on the Conservation of Natural Resources will be organized in four sections to consider the four great

classes of water resources, forest resources, resources of the land, and mineral resources. I am asking the members of the Inland Waterways Commission to form the Section of Waters of the National Conservation Commission. In view of the lateness of the season and the difficulty of assembling the members of the sections at this time, a chairman and a secretary for each section have been designated, and the chairmen and secretaries of the sections will act as the executive committee, with a chairman who will also be chairman of the entire Commission. I earnestly hope that you will consent to act as a member of the Commission, in common with the following gentlemen:

WATERS

Hon. Theodore E. Burton, Ohio, chairman.
 Senator William B. Allison, Iowa.
 Senator Francis G. Newlands, Nevada.
 Senator William Warner, Missouri.
 Senator John H. Bankhead, Alabama.
 Mr. W J McGee, Bureau of Soils, secretary.
 Mr. F. H. Newell, Reclamation Service.
 Mr. Gifford Pinchot, Forest Service.
 Mr. Herbert Knox Smith, Bureau of Corporations.
 Hon. Joseph E. Ransdell, Louisiana.
 Prof. George F. Swain, Institute of Technology, Massachusetts.
 The chief of engineers, U. S. Army.

FORESTS

Senator Reed Smoot, Utah, chairman.
 Senator Albert J. Beveridge, Indiana.
 Senator Charles A. Culberson, Texas.
 Hon. Charles F. Scott, Kansas.
 Hon. Champ Clark, Missouri.
 Prof. I. C. White, State Geologist, West Virginia.
 Prof. Henry S. Graves, Yale Forest School, Connecticut.
 Mr. William Irvine, Wisconsin.
 Ex-Governor Newton C. Blanchard, Louisiana.
 Mr. Charles L. Pack, New Jersey.
 Mr. Gustav Schwab, National Council of Commerce, New York.
 Mr. Overton W. Price, Forest Service, secretary.

LANDS

Senator Knute Nelson, Minnesota, chairman.
 Senator Francis E. Warren, Wyoming.
 Hon. John Sharp Williams, Mississippi.
 Hon. Swagar Sherley, Kentucky.
 Hon. Herbert Parsons, New York.
 Ex-Governor N. B. Broward, Florida.
 Mr. James J. Hill, Minnesota.
 Ex-Governor George C. Pardee, California.
 Mr. Charles McDonald, Am. Society of Civil Engineers, New York.
 Mr. Murdo Mackenzie, Colorado.

Mr. Frank C. Goudy, Colorado.
 Mr. George W. Woodruff, Interior Department, secretary.

MINERALS

Hon. John Dalzell, Pennsylvania, chairman.
 Senator Joseph M. Dixon, Montana.
 Senator Frank P. Flint, California.
 Senator Lee S. Overman, North Carolina.
 Hon. Philo Hall, South Dakota.
 Hon. James L. Slayden, Texas.
 Mr. Andrew Carnegie, New York.
 Prof. Charles R. Van Hise, Wisconsin.
 Mr. John Mitchell, Illinois.
 Mr. John Hays Hammond, Massachusetts.
 Dr. Irving Fisher, Yale University, Conn.
 Mr. Joseph A. Holmes, Geological Survey, secretary.

EXECUTIVE COMMITTEE

Mr. Gifford Pinchot, chairman.
 Hon. Theodore E. Burton.
 Senator Reed Smoot.
 Senator Knute Nelson.
 Hon. John Dalzell.
 Mr. W J McGee.
 Mr. Overton W. Price.
 Mr. G. W. Woodruff.
 Mr. Joseph A. Holmes.

One of the principal objects of the Federal Commission on the Conservation of Natural Resources will be to cooperate with corresponding commissions or other agencies appointed on behalf of the states, and it is hoped that the Governors and their appointees will join with the Federal Commission in working out and developing a plan whereby the needs of the nation as a whole and of each state and territory may be equitably met.

The work of the Commission should be conditioned upon keeping ever in mind the great fact that the life of the nation depends absolutely on the material resources, which have already made the Nation great. Our object is to conserve the foundations of our prosperity. We intend to use these resources; but so to use them as to conserve them. No effort should be made to limit the wise and proper development and application of these resources; every effort should be made to prevent destruction, to reduce waste, and to distribute the enjoyment of our natural wealth in such a way as to promote the greatest good of the greatest number for the longest time.

The Commission must keep in mind the further fact that all the natural resources are so related that their use may be, and should be, coordinated. Thus, the development of water transportation, which requires less iron and less coal than rail transportation, will reduce the draft on mineral resources; the judicious development of forests will not only supply fuel and structural material

but increase the navigability of streams, and so promote water transportation; and the control of streams will reduce soil erosion, and permit American farms to increase in fertility and productiveness and so continue to feed the country and maintain a healthy and beneficial foreign commerce. The proper coordination of the use of our resources is a prime requisite for continued national prosperity.

The recent Conference of the Governors, of the men who are the direct sponsors for the well-being of the states, was notable in many respects; in none more than in this, that the dignity, the autonomy, and yet the interdependence and mutual dependence of the several states were all emphasized and brought into clear relief, as rarely before in our history. There is no break between the interests of state and nation; these interests are essentially one. Hearty cooperation between the state and the national agencies is essential to the permanent welfare of the people. You, on behalf of the Federal Government, will do your part to bring about this cooperation.

In order to make available to the National Conservation Commission all the information and assistance which it may desire from the Federal Departments, I shall issue an executive order directing them to give such help as the Commission may need.

The next session of Congress will end on March 4, 1909. Accordingly, I should be glad to have at least a preliminary report from the Commission not later than January 1, of next year.

(Signed) THEODORE ROOSEVELT.

Commenting on the appointment of this Commission, the *Washington Post* says, editorially, in its issue of June 9:

The President has found a way to carry on the conservation movement without waiting for an indifferent, if not a hostile, Congress to make an appropriation. He has reorganized the Inland Waterways Commission and added to it several important men, including Senator Allison and Representative Ransdell, of Louisiana. He has also appointed a Conservation Commission, consisting of the Waterways Commission and three other bodies, having jurisdiction over forestry, land, and mineral questions. The chairman of this combined commission is Gifford Pinchot, the leading spirit of the conservation movement—the right man in the right place.

It is now in order for the Governors of the states to appoint commissions, which, in their respective spheres, will cooperate with the national commission. The latter will doubtless hold sessions during the summer in various sections of the country, preparing for the long campaign of education that must be conducted if the conservation plan in its fullness is to become a settled policy of the people and of Congress. This campaign can be strongly aided by the state commissions, with their intimate knowledge of local conditions.

One of the first practical obstacles to confront the conservation commission, probably, will be the tendency of Congress to cling to the old manner of doing out appropriations for internal improvements and the old method of making them. At the next session a river and harbor bill will be demanded. The biennial distribution of this peculiarly juicy pork will be the cause of special solicitude on the part of Congressmen anxious to be reelected. It has been proved clearly enough to honest men that the huge expenditures on rivers and harbors are not wisely placed or efficiently used. The money does not go where commerce calls it, nor is it used with thrift and foresight. The army engineers, under whose jurisdiction the money is dumped into the creeks and bayous of the country, do not take a real interest in this part of their work. They perform it honestly, but in too many cases they are only too well aware of the fact that log-rolling in Congress secured the appropriation for projects that should not be undertaken. Many of the projects are reluctantly approved by them, or actually disapproved. They know that these projects are not designed for the public welfare, but merely to obtain money from the Treasury for a certain locality, in competition with other localities. It is not surprising that the engineers take little interest in this country-wide game of grab.

If the Conservation Commission can impress upon the minds of the people that the river and harbor bill is a costly extravagance, it will have laid the foundation for the greater work of internal improvements which will be of actual benefit. When the voters of a Congressional district forego the temptation to secure a big river and harbor appropriation for the sake of contributing to bigger and broader plans for utilizing all the water, land, forest, and mineral resources of their region, the work of the conservation commission will be more than half done.



WORK IN A NATIONAL FOREST

No. 8. The Everyday Ranger

By CHARLES HOWARD SHINN

I HAVE been reading a book written by a man whom I remember, years ago, when he was a short, stubborn, auburn-haired mountain boy, who came to the preparatory department of the newly established University of California. He is now a professor of philosophy—never mind where. In this book he explains with convincing clearness what seem to me the essentially right relations of a man to himself, to his cause, to humanity, and to the universe.

This book sums it all up in the word loyalty, as ultimately defined by him to mean that which says to a man: "The best that you can get lies in self-surrender and in your personal assurance that the cause to which you surrender yourself is indeed good. But your cause, if it is indeed a reality, has a good about it which no one man and no mere collection of men can ever verify. This good of the cause is essentially superhuman in its type, even while it is human in its embodiment, for it belongs to an union of men to a whole of human life which transcends the individuality of any man, and which is not to be found as something belonging to any mere collection of men. Let your supreme good, then, be this: That you regard the cause as real, as good, and that if the cause be lost to any merely human sight, you hold it to be nevertheless living in its own realm—not apart, indeed, from human life, but in the form of the fulfilment of many human lives in one."

Again, he sums it up: "Loyalty is the will to manifest, so far as is possible, the Eternal, that is, the conscious and superhuman unity of life, in the form of the acts of an individual self." Or, as

still more plainly stated by Professor Royce, whose book I heartily commend to all the thinkers in the Forest Service: "Loyalty is the will to believe in something eternal, and to express that belief in the practical life of a human being."

And how is all this related to the plain forest rangers and guards—the men behind the guns? They will not read this philosophy; they will not follow any of the age-old discussions about success, expediency, truth. No! But like the old rover in Stevenson's fable, they will seize their axes and run joyously to die with Odin.

I must admit that long before the "philosophy of loyalty" was made the subject of a book, I tried faithfully to put some such ideas into the minds of rangers—until I found that they were there already, and that their loyalty to the large and growing ideals of a great cause were teaching me much more than I could ever hope to teach them. They were finding out for themselves that "it is better to be a spoke in a wheel than a spoke out of a wheel." They had not become rangers for the pleasure of it, nor for the worldly success, but because, having sworn allegiance, they had "neither eyes to see nor ears to hear," save as the Forest Service commands. But they cannot talk much about it (and how very fortunate that is). I can imagine just what some grizzled old ranger says at the campfire a week after one of our Saturday night meetings:

"The boss gave us a string about loyalty; said to play this game for all there is in it. 'Taint decent to do nothin' else."

I look back to 1902, when I came

into this work. Then we hardly had more than two kinds of rangers—local men, full of local prejudices, who would strain every nerve to take care of their old neighbors; and men from a distance who would cheerfully trample upon all the local customs and usages. One of the first class of rangers used to tell men who wanted posts or shakes or anything else out of the forest, "Go right along, and take what you need; never mind any record; it's a pity if I can't help you out—there's lots left."

In another case the ranger used to tell cattle men (this in the days of free grazing permits): "I don't mind if you run over the number you asked for; drift 'em right in."

This doesn't mean that these rangers were consciously lazy or dishonest; they simply belonged to the neighborhood and they wanted everybody to have a good time.

On the other hand, there was once a ranger whose first announcement when he reached his district was to this effect: "Everything has been too slack here; these mountain people must obey the regulations; office hours are Saturday afternoons, at my cabin." Thence arose the historic statement of an old Sierra mountaineer: "That dude from Santa Cruz telled me not to spit on any piece of Government land without a permit from Washington."

Came into the Service, because of the loyalty of a great multitude, that leaven which leaveneth the whole mass; came a something which has made man after man of the "old guard" of our forests more than willing to seek, through toil and travail of spirit, the highest permanent good of the local communities which they love and of which they are truly a vital part.

In these days our rangers say to those who criticise us: "We know just how you feel; we are plain folks ourselves. But we are very sure that the Service is right. Just wait a little, and try to believe that this thing is coming out in the best way for all of you. Help us fellows to make the Forest a real benefit to everybody."

The outsider, too, the "man from

Santa Cruz," comes in with burning zeal to learn the local needs first of all. He learns to "carry his office under his hat," without disregarding the official side of life. So, little by little, the real men have begun to move together in harmony with the work. Their thoughts rise from "our district" to "our Forest," and then to "our Service." They do not pause there; they become a living part of national issues and fearlessly climb into great spaces among the stars of heaven. The noble cause becomes only one of many noble causes and the end of all is the same—the following of the eternal verities, not for gain, nor honor, nor happiness, but in absolute self-surrender for the sake of that which is.

Because I have found all this in the daily life of guards and rangers to whom my philosophies of life are as Greek, they have taught me more than my favorite books (which for the most part merely restate in some delightful way what one already knows). We began together long ago—rangers and head-ranger—when "a dollar looked as big as a cart-wheel" and if a ranger had one to spare, he lent it along the line, till, three months later, some veteran away up in the blue peaks would suddenly remark: "Here's that dollar you lent Harry, an' Harry lent to Jo. an' Jo lent to that new feller down in the canyon, an' some more I don't remember passed it up, an' that's your dollar. Came in handy, too."

At present many of the rangers have little bank accounts, and they buy better horses and saddles, but the comradeship of the old time remains, and it deepens and broadens with the years. We are learning to pass ideas down the line even more freely than we did those cartwheel dollars.

A ranger is not a man whom you can easily put into a book or story anywhere away from his own country. He is one who has come into the Service for the hope and promise of it, and has staid for the sheer love of it. He learns to bless his lucky stars that the fates led his feet into this path. But nevertheless he finds the Service hard, not in

a low sense, but in a high one: it crowds him constantly toward more care, more "business sense," more knowledge of all sorts of new things. Once, when he was young, the ranger liked to fish—he very seldom gets fishing any more; he even shows the best fishing places to the tourists, and goes off about his business!

Two young rangers lately said to me: "Saturday is a legal holiday, but maybe this piece of work should be finished quick, and if you say so, we won't mind putting in Saturday and Sunday before we move camp."

"But you'd like to take your wives and go back to Chiquito and see the snow peaks and get an inspiration there—and take some trout flies."

"You bet we would!"

I love to note how the real rangers of a Forest wear themselves thin and gray every summer. They come and go, eager-eyed, quiet, giving of their best, responding to every call, though it come at night, though it "kills a horse," or "breaks a few ribs," and by the time the first rains come they are the sort of men whom you do not insult by any gush over their heroism. Instead, you sass them extra hard; you tell them that they sleep too much and eat too often. I was at a fire once where grub was very scarce. We divided up the hard-tack, and labelled each pile "beans," "beef-steak," etc. Said one ranger, with a meditative drawl: "I seen a man eating bacon 'bout a month ago. Anyhow he *said* it was bacon!"

Into such a land of perennial youthfulness the youngster comes, and, if he has any future value, is soon swept out of himself by its vast currents. If not, he shudders and so escapes, with terror in his soul, and with a wild pursuing laughter behind him.

"I never supposed that a ranger had to cut brush and grub stumps and build fence and work like a nigger," said one of the "greenies." "I thought he just rode around under the trees and made outsiders toe the mark."

He was a new guard, on trial; he said this in camp to a group of old boys with whom he had been working. They

were sorry all over for him; they looked at him, solemn-eyed, and regretted the cruelties of the Service. "The boss," they said, "just sticks it on us all the time. We are workin' like slaves—guards an' rangers an' everybody. It's plumb wicked the way we're herded here!"

The new hand felt comforted, and he ambled innocently on: "That heavy brush tears my clothes, and my back aches, and I burned a shoe, and my socks are full of stickers. Then I fell on the barbed wire when I was stretching it, and cut my nose. I tell you what it is, fellows, if the Lord is good to me, I hope I'll never see another inch of barbed wire as long as I live. If I was only back in Peanutville, where I used to live, I could be eating a plate of ice cream this minute instead of working like a dog and having to wash my own clothes Sundays when I might be hearing the band play in the park."

"Too bad! Too bad! Too bad!" said all the old rangers in chorus, and so it went on till shouts of laughter began to fill that mountain camp and the indignant youngster suddenly understood that his point of view had somehow no sympathy.

But the next day one of the most effective of the rangers in the district asked him as they went up the trail together, "How much of that stuff you was preachin' last night did you mean? Of course this is hard work; it has to be. Either leave it mighty pronto, or wrestle with it till you're a man at the game. I've seen lots of young fellows harden up—some of the best of them came in just as green an' useless as you are. Don't you know you hold us back and waste our time, too, on most any job? But it's the price we have to pay up here to get new men started. I heard the boss say once that a real seasoned ranger that had crossed the line was worth his weight in raw diamonds."

"Crossed the line?" said the youngster, "What do you mean by that?"

"Well, the boss says that when a fellow isn't workin' for the pay, or for promotion, and is puttin' in all there is in him, and is married to the work, and

his wife is just as bad as he is, then he has crossed the line into new oceans, under new skies, and has found the real thing. Sounds like poetry, but the boss says it isn't. He says that the idea behind it is just as big and as real as a sugar pine."

The youngster was provoked. "I think that all of you are crazy!" He walked into the supervisor's office that afternoon and explained that the work was unsuited to a person of his attainments. He never knew exactly how it happened, but he signed a resignation blank almost before he knew it, and went back to Peautville.

The rangers followed his career for several years with joyous interest. He clerked, he took money at a circus window, he tried newspaper work, he went to the mines, he was everything by turns, but nothing long. But still one sometimes hears a ranger say to another while they are fighting fire together down in some hot gulch: "Say, Jack, I wish I had a plate of ice cream." And Jack responds: "I wish I could sit in the Peautville park and hear the band play."

Thus the miserable failure of this youth has come to be used by loyal men to the betterment of the Service; not of set purpose, but none the less surely has it become mortar in the walls of the Temple.

Inspectors tell me sometimes that the rangers are different in, say, Oregon, from those in New Mexico. I cannot think that they are essentially different. I think that when the Chief goes around, he sees the essential unities, not the minor differences; he sees that the

Service is a spiritual force that lifts men out of themselves, and makes them living "spokes in the wheel," living wheels in a living engine. He sees men finding themselves, then giving themselves, not to him as leader, but to a Service. And it is not always the strong, the refined, the highly educated who achieve the most complete loyalty to something far greater than themselves. The Chief sees, I think, that whoever, great or small, high or low, from guard to head of division, who holds back anything of himself in either body or soul is not wholly loyal to the Service. And, knowing this, his heart especially goes out—not to me who write of these things, not to any of those who rule as best they may, from the seats of the mighty, but to the rank and file; to the plain Americans, so simple, so in earnest, so troubled about their forms, their reports, their maps; even so much more anxious about Bane's hogs, the shakes for old man Castro's cabin, and those miners up in Tamarack Gulch.

For the Service grows according to the degree in which it inspires the plain everyday people. It not only goes on with increasing energy, but some of its force passes forever into the shaping of greater human issues than even waters and forests. For these, our loved guards and rangers and their wives and children are learning to think and to act more and more helpfully for the betterment of the communities in which they live. To this the communities are learning to respond in like measure. There we can safely leave it.



EDITORIAL

The Conservation Commission

FOLLOWING closely upon the memorable Conference of the Governors, at the White House in Washington, comes the announcement by President Roosevelt of the appointment of a Commission on the Conservation of Natural Resources. In another part of this issue of FORESTRY AND IRRIGATION will be found the President's letter of appointment, together with the list of members of the new Commission.

America—or, to speak more definitely, the United States—has long been known among the nations as a nation of extravagance. Nationally and individually, wastefulness has been a leading characteristic; and, when one comes to think of it, this is a peculiar fact. Descended as we are, from the careful peoples of the Old World, our blood a blending of the blood of Puritans, of Scotch, Irish, English, French, German, Swede, Dutch, and all the other blood-lines of the continent of Europe, it is strange that we should have—and should have earned—such a characterization. Ancestrally we are a saving people; a frugal, even a parsimonious, people; but actually, we are the most improvident—the spendthrift among nations.

It is interesting to trace the development of this spirit of wastefulness—this idea of taking absolutely no heed for the morrow. Coming as we do from races whose every tendency, whose whole training, has been in exactly the opposite direction, it is a wonderful thing to consider that within a single generation the effects of all racial tendency toward thrift is lost—to consider that within much less than the lifetime of an individual we, as a people—of blood amalgamated of every thrifty, frugal race if Europe—have gone as far toward wastefulness as did

our ancestors, through hundreds of years, toward niggardliness.

The very abundance of natural wealth with which America has been endowed is the basic cause of this departure from type. When those frugal ancestors of ours reached the shores of the North American continent they found a land wherein nature had lavished every form of potential wealth she possessed. They found forests of such magnitude and magnificence as to be beyond comparison, so far as their previous experience had reached. They found mines, rivers, soils of such fertility as to astound them; and by the time their children succeeded them, the habit of regarding these resources as inexhaustible had become fixed. Trees and forests existed only to be cleared away, cut down and destroyed to make room for farms; soils were so rich that no idea of conservation or renewal of fertility ever entered their heads; water-powers were so abundant that they were unworthy of mention or of serious consideration. So the forests of the East were destroyed; those of the Middle West went in like manner—deadened, cut down, and burned, in vast holocausts. When, at last, the fertile farms of the East began to lose their fecundity, there was plenty of land left in other regions and the young men were advised to "go West, and grow up with the country." The Nation gave to every man asking for it one hundred sixty acres of as good land as ever lay outdoors; all that was necessary, in order to possess it, was sufficient money to make the trip and pay the trivial fees required.

The vast hardwood forests of the Middle West followed those of the East, going the way of destruction without a hand being raised to prevent. Wood, for fuel, went out of use when

coal began to be mined, and in large sections of the country, natural gas supplanted coal. In the use of all these—wood, coal, and gas—the same spirit of criminal wastefulness prevailed, and now the evil results are becoming manifest. Indeed, to thinking, seeing men, these results have been apparent for years. Who among those who read this ever use wood as fuel, excepting it be while on a camping or vacation trip? But turn your mind's eye back a few years; think of the time when you, reader, lived at home with father and mother, perhaps on the old farm. What was the fuel then? Wood, most likely burned in the old-fashioned fireplace, in the form of great logs. Later came coal, and the grates, coal stoves, and "base burners." Then, for those of you who live west of the Alleghanies and east of the Mississippi, came the gas. Now, you have gone back to coal again. You haven't wood any longer; you wasted the gas, of which there was enough, had it been properly used, to last five hundred years, and now you are burning coal. Two of your candles are gone, and you are burning the third at both ends.

The days when our rivers and waterways were crowded with a vast and ceaselessly busy traffic are well within the memory of living men. Shrunken as it is to a small fraction of its former magnitude, the inland water traffic of the United States is still magnificent. But American heedlessness, American wastefulness, American carelessness has brought this water traffic to its present pitiable state—pitiable as compared to its former immensity. Hillsides ravished with ax and saw and fire, laid bare to the storms and the floods, have vomited their soil into the rivers, there to form bars and shallows that turn former water-highways into successions of pools. Low water, in the Ohio and the Mississippi, the Wabash and the Kanawha, and all the other rivers of the Middle West—to say nothing of those farther east or farther west—lasts now from May to December; the rest of the year the rivers are raging floods, that each year devour more and

more of the land and take a larger and still larger toll of human life and man-made wealth. And it is all our fault; it is all because we Americans have not seen, and will not see, the folly of the course we are following.

Men of science tell us that the coal in our mines is approaching exhaustion, and that a very few hundred years will see the end of the supply. Wasteful methods of mining, wastefulness in consumption, go on unchecked—absolutely unheeded. Who cares? If we lose, in power production, ninety per cent. of our coal, why worry? There will be plenty for us, and "after us, the deluge." Let those who follow us warm themselves by the rays of the sun; let our descendants invent sun motors for transportation and power purposes; we shall not be here to suffer, and if the children of our children are made miserable, we shall not know it. There is your American spirit—a spirit as far from altruism as is the North Pole from the South.

But now this orgy of destruction, this saturnalia of extravagance, is to be ended. The whisperings of a new National policy have been running through the land for years, and at last these whisperings are growing more distinct. A few years ago they began to take definite form—to become coherent and audible, and then we set about preserving, as best we could, the forests that remained to us. Then they grew louder, and the Inland Waterways Commission was born. The fuller note was heard in the Conference of the Governors; and now comes the deep-lunged challenge to the Spirit of Unthrift in the appointment of the Commission for the Conservation of Natural Resources. A new commandment has been given unto the American people, and it is this: "Thou shalt not waste the lands nor the resources that the Lord has given thee."

"United We Stand"

AMONG the most noticeable features of the White House Conference was the idea, often repeated, that no

section of the country should, or can, regard its interests as paramount; that the interests of one section are the interests of all, and that a recognition of this principle is coming and must come if the Nation is to work out the fullest measure of material and spiritual prosperity. Another distinctive note was struck when it was declared that, among the Nation's resources must be counted its scenic beauties. No part of the country, it was declared, has a right to advance its own interests, be they financial or otherwise, at the cost of destroying the beauty of any other section. No section, indeed, has a right to advance its own interests at the cost of destroying its own attractiveness. Pennsylvania has no right to make itself wealthy by turning its hills into honey-combed rabbit-warrens, and its valleys into slag-heaps. Buffalo has no right to make itself wealthy by turning Niagara into a bare, dry precipice, hardly moistened by a few trickling rivulets that have escaped the tunnels of the power plants; and Chicago has no right to build up for herself an inland water commerce by turning back the tide of the Lakes and leaving the harbors of Detroit, Toledo, and other Lake cities without water. The people of the West have no right to ravish their forests as those of the East have already been ravished. The country has learned a lesson from the experience of the East, and it will not permit a repetition of that experience in the only section of the land where forests of any extent remain.

In this connection, the following editorial expression from the Providence, R. I., *Journal*, is expressive of the sane sentiment of the country as regards conservation, and is a just estimate of the importance of the newly-appointed Commission on the Conservation of Natural Resources.

"The estimates of the International Waterways Commission, composed of an American and a Canadian section, as reported to the Parliament at Ottawa, do not threaten obstacles to the development of the Chicago drainage Canal into a navigable stream. This will relieve the fear which has been ex-

pressed on behalf of ports, other than Chicago, on the Great Lakes. It is believed that with a diversion of water to the quantity of ten thousand feet a second Chicago's sanitary necessities will be met for all time, and the largest practicable waterway created; while the lowering of the surface of the Lakes will be only from four to six inches, which will create no embarrassment to traffic thereon. The Government of the United States will be urged to prohibit a greater diversion for the canal. For power purposes, with the preservation of the scenic beauties of Niagara Falls the chief consideration, the joint commission also proposes maximum figures, declaring that 'it would be a sacrilege' to grant privileges beyond the estimates.

"The omission to provide in the Agricultural bill, or elsewhere, for a continuation of the Joint Congressional Commission on Inland Waterways will not be permitted to embarrass the development of the series of enterprises combined in the policy of conservation of natural resources to which the President and the country have set their faces. This neglect on the part of Congress, together with the failure of the Appalachian Bill, reflected in a picayune fashion an opposition, not necessarily to the policy in the abstract, but to details of it which threaten special interests, or are disagreed to by certain local constituencies. Especially have the Mississippi River boomers of the Centre been restless against the broad and conservative program outlined by the Waterways Commission. They are disinclined to have their half-billion dollar scheme delayed for incorporation with like enterprises to constitute and give a genuinely national scope to a single magnificent policy. After careful assimilation of all considerations the President took his stand with the Commission and announced his views in his first message to the Sixtieth Congress. From that hour the Commission has been made uncomfortable. Though not too rashly antagonistic on the floor, Congress was able, with an affectation of contempt that itself was contemptible, to display its feelings by cutting out the sustaining appropriation and all mention of the Commission from its enactments.

"The summons to the Governors for the May conference was undoubtedly a strategical move in respect to this move in Congress, as well as broadly reflecting a purpose to enlist state cooperation for the furtherance of the general policy. That the meeting of the 'House of Governors' aroused a measure of jealousy in the Congressional bosom was made manifest. That the President regarded the situation as precarious and anticipated the action in repudiation of the Inland Waterways Commission was shown by his declaration that he would personally see to it that the Commission was not wiped out of existence. He has made good that pledge by requesting the members of the Commis-

sion to consider themselves as still employed in the service of the Government. Brigadier General Mackenzie, Chief of Engineers of the Army, passes to the retired list, but his successor in the War Department will succeed him, ex-officio, on the board, while Senator Allison, Congressman Ransdell, of Louisiana; Doctor McGee, the Government's chief anthropologist, and Prof. George T. Swain, of the Massachusetts Institute of Technology, are added members. Moreover, the President has given greater consequence to the Commission and prepared for the amplification of its investigations by appointing and associating with it other boards on the collateral projects, forests, lands, and minerals; the quartet constituting the main sections of what will now be known as the National Conservation Commission."

Conservation is a National duty, and we, as a people, shall fail utterly to take advantage of our opportunities if we do not grasp in its fullness this idea.



Mountain Forests and Floods

A WRITER in the *Pacific Sportsman* discusses the subject of mountain forests and floods. He understands that forestry advocates hold that the one grand object in maintaining forests on mountain slopes is to "cause the snow to melt slowly," and thus "preserve the water supply." The position that mountain forests do subserve these ends, he then proceeds to demolish as follows:

1. "The timber has nothing to do with the water supply, but is a result of the water supply.

2. "On the contrary, the trees are a detriment, because they absorb a heap of water after it gets down to them from the peaks. Trees in the mountains make floods in the spring.

3. "Snow in the timber melts too fast. The timber keeps it from drifting. The snow that falls below the timber line is a positive danger rather than a blessing, for the timber shades it until the warm air of spring melts it with a rush, and spring floods result.

4. "The agency which maintains the rivers is the snow in the huge snow drifts above timber line. In the high, sharp valleys of the peaks and pinnacles there are basins, steep rocky sides of cliffs, barren spires, smooth hillsides

where the wind blows like all possessed when a storm comes. Winter snows fall deeper and oftener here than they do in the timber below. The wind blows the snow off the hillsides and piles it into huge drifts in the basins; then the warm winds come, and the rest of the snow on the hillsides above the basin loosens up and comes sliding down into the basin too, tons and tons of it, until the basin is a basin no longer but an enormous snow bank containing acres of surface and anywhere from ten to one hundred feet deep—mostly on the north and northeast side of the mountain proper and away above timber line, where the air is always cool and where the peak shades the snow bank for a good part of the day. That's your reservoir that feeds the living streams of summertime.

5. "As for forest reserves, what we should do is to reserve the mountains *above timber line* from settlement, so the thousands of big snow-filled basins will not be polluted, and tree planting should be carried on in the plains country where trees are needed for fuel, lumber, and the influence they exert on the hot atmosphere of Kansas and Texas to induce rainfall."



By Way of Reply

IN THE first place, forestry people do not hold that the one grand object in maintaining forests on the mountain slopes is "to cause the snow to melt slowly" and thus "preserve the water supply." They lay much stress upon one factor wholly ignored by the unknown writer, viz.: the *rain* which falls upon mountain slopes. They show that rain falling upon a densely forested slope has its force broken by the forest cover, its erosive power thus being reduced; that, up to the point of saturation, it is absorbed by the forest mulch, passed into the underground circulation and released slowly during the succeeding days, weeks, or even longer periods through mountain springs, gradually to feed the streams, maintain an equable flow, and serve the ends of

agriculture, navigation, and manufacture. They show, on the other hand, that the same rain falling upon a slope bared by ax and fire rushes madly to the bottom, sweeping the slope bare of soil, silt, and everything movable, fills the channels of the streams with debris, and produces disastrous floods, to be followed by droughts hurtful to agriculture, navigation, manufacturing, and all other interests dependent upon the streams.

The Question of Snow

THAT masses of snow on mountain sides maintain stream flow, there can be no doubt. The more of such snow, within limits, the better. But why argue that only the snow lying above timber line is desirable? Why not snow below timber line as well? Because it does not "drift?" Even so, is not the water which results from the melting of the snow in the forests absorbed up to the point of saturation, by the forest mulch, passed into the underground circulation, and otherwise handled exactly as rain deposited upon forested slopes?

A great point is made of the assertion that snow lying in the timber is quickly melted by the warm air of summer. Granting, for argument's sake, that this is true; suppose this timber were gone. Would the snow deposited on the same area lie unmelted longer than if the timber were there? Would the spring air be less warm? Would the snow water enter more readily the underground circulation after the slope had been bared by fire to the original rock bottom than it did when the ground was covered by soil, dead leaves, decaying branches, logs, and other forest litter? Instead, in the case of such an area is not every advantage, as regards slow melting and earth absorption, on the side of the forested and against the deforested slope?

Again, as to snow on forested as against snow on deforested slopes. If the unknown writer will turn to Marsh's "The Earth as Modified by Human Action" he will find that deforesting the slopes of the Alps aided

in producing avalanches, first of snow and then of earth. The author points out that the forest aided in holding both snow and soil in place. However, when this conservative influence was removed, great snow fields burst from their moorings and rushed down the mountain sides, leaving desolation and havoc in their wake; only to be followed, in some cases, by huge fields of earth, one such destroying an entire village.

Where There Are No Snows

AGAIN, the anonymous writer devotes his whole attention to the question of forests, streams, snow, and water as connected with the high mountains of the far West. What of the comparatively low mountains of the East and South? He says "If we had no barren high-peaked mountains, we would have no rivers and no timber to preserve." "Timber has nothing to do with stream-water supply." In the East and South "barren high-peaked mountains," such as he is describing, do not exist. According to his theory, we should have in New England and the South, to say nothing of the Great Lake regions, no rivers and no timber at all. However, we have had, in all those regions, a magnificent forest growth and a series of great river systems. In the light of these facts the fallacy of this position becomes at once apparent. In the Southern Appalachians, notably, the snowfall is light, and there are not, as in Wisconsin and New Hampshire, systems of lakes, regularly filled by snowwaters, to feed, in a measure, the rivers through the summer. The one agency that exists here to conserve the streams in summer, standing out sharply and unconfused with any other, is the mountain forest. Facts are stubborn things; what will our writer do with such a fact as this? According to his view, there should not be a river in the entire South. Let him look at the map.

With the writer's naïve acceptance of "the dear old rainfall theory once held in such esteem," as shown by his declarations that trees in the plains country are needed to "induce rainfall" and

"trees in a hot country help to produce rain," we have here nothing to do except to indicate that crudities in several forms are grouped together in his article. His one correct position is the undisputed one that snowbanks in high mountains help to maintain stream-flow in summer. But if the opponents of the policy of National Forests on mountain slopes desire to continue their unequal warfare with its friends, they will find it necessary to produce stronger arguments than those found in the anonymous paper in the *Pacific Sportsman*.



Nominate Members

A STUDY of the statistics of the membership campaign of the American Forestry Association shows that few if any lists are better for solicitation purposes than the list of nominees sent in by members of the Association. These names are evidently carefully selected, and yield, on the whole, excellent results. We again earnestly urge our membership to aid the work of the Association by supplying names of possible members for the use of this office. A large and growing membership adds greatly to the prestige and power of this organization. It furnishes funds with which to prosecute the work, and it raises up a body of friends everywhere to sow the seed from which the ultimate harvest may be reaped.

In the advertising section will be found a blank space entitled "Nominations for Membership." Post-office regulations curtail its size; nevertheless, by pasting on a sheet of paper it may be indefinitely enlarged. Let every member faithfully use this form, and send in the names of all, whether few or many, whom he may believe would be willing to join the Association. And wherever possible let him use his personal influence with these to encourage, or even urge them to join. A few earnest, aggressive, working members, soliciting memberships, can very materially aid the progress of the organization. The existence of the present industrial stringency necessitates in-

creased activity on the part of our friends to insure the maintenance and growth of the Association. Let the nominations pour in, and let the activities of individual members be multiplied!

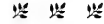

Conservation of Human Resources

IT HAS been suggested that, among our national resources, those of most fundamental moment are human resources; and that, in fact, the reason why we seek to save the land is that we may thereby save the man.

Agencies exist for promoting directly this man-saving work. For example, *The Delineator* conducts through its pages, a "Child Rescue Campaign" for the child that needs a home and the home that needs a child. This work is prosecuted under the supervision of such representative and elect ladies as Mrs. Frederick Rockefeller McCormick, of Chicago; Mrs. William Jennings Bryan, of Lincoln, Nebr.; Mrs. Claude A. Swanson, of Richmond, Va., and Mrs. Robert M. La Follette, of Madison, Wis. Pictures of bright, promising children, for whom homes are sought, adorn the pages of this publication in each issue, while a recent number enumerates, among "Waifs Who Have Become Famous," Henry M. Stanley, Catherine the Good, Alexander Hamilton, Rosa Bonheur, Edgar Allan Poe, and Rachel, the noted actress.

Rome is said to have fallen through "failure in the crop of men." Such efforts as this of the *Delineator* aid in safeguarding America against such a fate.



The Forestry Fight On in Denver

IN DENVER, Colo., which notably since the convention of June 18 to 20, 1907, has been regarded as in some measure the headquarters of the opposition to the National Forest policy, the fight is again on in earnest. The Denver Chamber of Commerce some time ago passed a set of resolutions endors-

ing the forestry policy of the Government. The resolutions were published next day in the papers. A vigorous protest from the anti-forestry people followed. A hearing was next given to the opponents by the Forestry Committee of the Chamber of Commerce. Their leading objections were published on April 25 in a Denver farm paper. Their catch-words are "great feudal estates," "paternalism," "bureaucracy," and "landlordism."

With these gentlemen, a National Forest is a "great feudal estate." The most elementary knowledge of feudalism will dispose of this objection. What is a feudal estate? An area of territory, larger or smaller, practically owned and absolutely controlled by an individual in his own interest. What is a National Forest? An area of territory, larger or smaller, absolutely owned and controlled by the whole people of the United States and administered in their own interest. The Western analogy to the feudal estate is the Scully estate. This is privately owned and privately administered against the interests of the tenants and in the interest of the owner. National Forest critics, however, seem to be finding no fault with such estates. Instead, they seem to prefer them to those publicly owned and administered. Ergo, instead of opposing "feudalism" they seem to be defending its modern analogue.

The term "paternalism" is equally unhappy. It comes from "pater," father. It represents a one-man form of government; originally that of the patriarch (pater, father; arch. ruler); later, of the king, who succeeded him. About 1776 the king was put out of business on this side of the water. A new government followed, described by Lincoln as "of the people, for the people, and by the people."

A people's government is the exact opposite of a paternal government. The National Forests are governed by the people's government. To describe their rule as "paternalistic" is to employ a contradiction of terms; it is to make words meaningless.

The "modern instance" of paternalism is government by the plutocrat; by the Scully, Rockefeller, Harriman, or other "undesirable citizen" of that type. The time has come when we must choose between government by the people and government by the plutocrat. The Denver objectors prefer, seemingly, government by the latter; the people will probably continue to prefer government by themselves.

"Bureaucracy"

AS TO "bureaucracy," or government by bureaus. The type of such government is that of France, under Louis XIV, and Russia, under Czar Nicholas. In other words, autocracy and bureaucracy are twins. The less popular, the more bureaucratic the government, and conversely.

Winter sometimes lingers in the lap of spring; similarly, old institutions sometimes linger under new forms. A measure of bureaucracy may survive in a democracy. The remedy, however, is not the substitution of autocracy. If the United States Post-office is bureaucratic, to turn it over to a private corporation would be to jump out of the frying pan into the fire. The remedy lies in increasing rather than diminishing control by the people.

If critics can point to bureaucratic survivals in the Agricultural Department or its sub-divisions, let them insist upon more, rather than less, popular government.

And popular government, be it remembered, is constitutional government; government by law, not by the mob. Let the critics propose laws that will enlarge the power of the people over their forests and make the administration of these more consonant with the popular will and interest. Until such legislation be proposed, the natural inference will be that the present administration of these great public estates represents not too slightly, but too completely, the interests of the whole American people.

Government "Taxes"

ANOTHER Denver criticism is that the National Forests are handled "at the expense of our Western people, through the imposition of taxes for lumber, grazing, rights of way, fire-wood, and multitudinous special uses." To this policy it objects.

Let us examine this criticism. The American people, some eighty millions, own certain National Forest areas in the far West. Certain other American citizens, a few hundred, or a few thousand at best, live near the National Forests. These near dwellers desire to avail themselves of the utilities named. The eighty millions are willing that, within reason, they shall do so. The users now may use on one of two conditions: Either with, or without pay. The owners say the users shall pay; to this, some of these users evidently object and stigmatize the pay as a "tax." They evidently want the utilities as a gift.

Suppose the eighty millions adopted this policy with respect to the National Forests. Consistency would then require that they should apply the same policy to their other properties. Of these, they own several. In your town, for example, the American people own a public building. Why should they not turn this over to the use of a handful of your leading citizens?

The eighty millions own sundry battle-ships. Why not permit certain distinguished individuals living near the waters where these vessels ride at anchor to use them gratuitously as private yachts?

The eighty millions own an ocean cable in Alaskan waters. Why not donate the free use of this cable to the few Indians and Americans who live near its termini?

The American people own some railroads: For example, in Panama and on certain reclamation projects. These could doubtless be availed of by people living near by, who might ride on them to and from their work, or their pleasure. Why should the Government "hog" them?

At Fort Leavenworth the eighty millions own a big building. It was built for a Federal penitentiary and is so used. It would make an elegant gymnasium or riding school for the "leisure class" living near. Why not convert it to this use instead of excluding these eminent citizens unless they choose to enter in stripes?

The eighty millions own a few buildings—far fewer than they need—in Washington, D. C. Business men residing here could utilize these to excellent advantage for office purposes. Why should they not be permitted freely to do so?

The White House grounds would make an elegant cow-pasture for certain descendants of Ham living hard by. How selfish and cruel of the owners sternly to exclude each and every one of these hungry bovines from this property!

Evidently, the whole policy of the eighty millions regarding the fag end of the United States which still belongs to them is wrong. Whatever it has left it should throw wide open, like the Cherokee Strip or Sisseton reservation, for the man who can get there first. It belongs to the people; is he not the people? Surely, the time has come for a new and "squarer" deal in the management of our public property. The handful of Denver critics who are leading in this fight will live in history with the Adamses, Paines, Henrys, Franklins, and the rest who stood for freedom a century and a quarter ago.



NEWS AND NOTES

Irrigation Development in Washington

FOUR thousand acres of historic ground, surrounding old Fort Okanogan, Wash., northwest of Spokane, is to be put under ditch by J. G. McDonnell and J. B. Vallentine, and it is estimated that the cost of installing the plant will be \$125,000. Water will be taken from the Columbia River.

Water for the tract, to be known as Bridgeport Orchards, will be distributed by gravity from a large reservoir. A pumping plant with a capacity of twenty thousand gallons a minute will be installed, operated by a gas-producer engine of two hundred horsepower. The water will be lifted fifty feet into the reservoir, from which it will be distributed through ditches. The domestic water problem is easily solved, for the reason that water can be reached by boring only a few feet. Four and a half miles of ditches will be dug.

Bridgeport is 738 feet above sea level. A part of the land to be irrigated has been under cultivation for years, and there are several ten-year-old orchards. Some of these have made remarkable yields even without irrigation.

With the exception of the Astoria settlement, made by the elder John Jacob Astor, Fort Okanogan is the oldest habitation of white men in the Northwest. While the land will produce abundantly without irrigation, there have been half a dozen projects started during the last twenty years to put it under the ditch, but all for some reason have ended in failure. Now there is every indication that the district will soon have railroad transportation by the building of the Okanogan Electric Railway Company's line between Nighthawk and Brewster, Wash., by Col. A. M. Dewey, of Spokane, and his associates, and this will mean rapid development. Work on the line seventy-five miles in length, will begin July 1.

The lands are cheap, costing not more than \$50 an acre, this being because of the lack of water and transportation facilities. The Great Northern Railway has completed the purchase of a right of way between Wenatchee and Oroville, and is now asking for an easement across state lands which indicates that it will begin construction of its branch line in the near future. At the same time Congress is busy with the project of making the Columbia navigable. There are also a number of smaller railroad-building projects, which, if carried out, will provide transportation for most of the river between the junction of the Kettle River and the Pend d'Oreille, above which there are now railroad lines. Between Kettle Falls and Wenatchee there is river-boat service.

Based on what is being done at Wenatchee, Yakima, Prosser and Spokane Valleys, where the most intelligent horticulture is followed, it is estimated that a five-year-old tree should average twelve boxes of apples every year. These should sell at from \$1 to \$2. There are from fifty-four to eighty trees to the acre, so the yield of an orchard should be from \$1,200 to \$2,500 an acre. Of course, this is done only when the most modern methods are employed, both as to growing the crop and marketing it.



Reclamation Work for Socialist Settlement

THE Adrian Irrigation Company, founded by James J. Hill, nine years ago, and abandoned after a large expenditure of money, has been resurrected by Spokane people, headed by H. Rosenzweig, president; J. S. Lichty, secretary and manager, and O. L. Waller, acting president of the Washington State College, chief engineer.

H. B. Garrett is assistant engineer and has charge of the work. The company proposes to irrigate five thousand acres of land near Soap Lake, Wash., 112 miles west of Spokane. Most of the promoters are socialists, and the company will be cooperative. The stock is \$75 a share cash, and \$100 on payments. It is distributed among the members, on installments, by paying \$10 to \$20 a month.

The company is incorporated for \$300,000, the stock being divided into three thousand shares at \$100 each. It is the intention to sell \$150,000 worth of the stock, which is considered sufficient to put all the five thousand acres under a high state of cultivation. Practically all of the land will then be set out in orchard. At the completion of the irrigation system, and when all the land is in cultivation, each holder of a share of stock fully paid for may exchange it for an acre of land, to which he will be given a warranty deed and perpetual water rights. However, Mr. Lichty says that not one per cent. of the stockholders will exchange their stock for the absolute title to one acre, for the reason that this would deprive them of their community rights in the personal property of the company, which will be worth several thousand dollars, and also of any share in the big industrial enterprises and municipality that is to be developed in the district.

The company's plan involves the building of an enormous dam, the development of several thousand electrical horsepower, the platting and incorporation of a town, all the stores of which are to belong to the company and sell their goods to the people at cost. The town will be governed according to plans yet to be decided upon, but one important feature of the municipal constitution will be the initiative and referendum.

These things belong to the more distant future, and the promoters do not expect to see them realities in less than five years, because of the expense they involve, but there will be enough activity along other lines during the next

two years. It is expected to have one thousand acres set in orchard by next fall, and water will be available for the larger part of the district next spring. All of the land will be watered by gravity flow during the early part of the season, but after July it will be necessary to pump the water, and for this purpose a large pumping plant will be built. Work on this part of the enterprise is now in progress.

Twenty-five men and teams are digging laterals, deepening the main ditch, building the pumping station and laying the foundation for the dam. The ground will all be ready for cultivation next fall, when the first trees will be planted. Ten miles of the ditch is completed, and the hoisting pump will be installed and the main canal completed and ready to supply water early in June. The company has sufficient capital on hand to insure the completion of the work. The land was bought for \$5 an acre, and the improvements, including the irrigation plant, will cost \$250,000, or \$50 an acre.

Adrian is in the heart of the Big Bend country. The land is volcanic ash covered with sagebrush, and the fact that the entire tract is almost as level as the sea indicates that the soil does not blow or shift with the winds. The elevation of the district is one thousand two hundred feet. The land is along the banks of Crab Creek, a stream of the "desert," as it might be called by those unacquainted with the remarkable fertility of the miles of sagebrush land that stretch away in every direction.

Water for irrigation will be taken from Brook Lake, a deep body of clear water, covering one thousand acres. It is one of the chain of lakes all fed by Crab Creek. These lakes are really only deep chasms in the coulee through which the stream runs. The first of the chain is Long Lake, then Tule Lake, next Little Lake, and the last and largest is Brook Lake. Between these, Crab Creek runs through a deep coulee, and this gulch with its rocky, precipitous banks, will be turned into a vast

reservoir, as will also the lakes themselves.

To accomplish this it will be necessary to build a concrete dam forty feet high at the outlet of Brook Lake. From Long Lake to Brook Lake is a distance of several miles, and the average fall of the land is eighteen inches to the mile, hence the necessity of a high dam to raise the level of the upper lakes and fill the coulee. When the dam is completed several hundred acres of meadow land at the upper end of Brook Lake will be overflowed, and before the project can be carried out this must be purchased.

This, together with the cost of the dam, makes the project too expensive for the present undertaking, and the dam will be made only ten feet high. At this height it will give gravity flow for the entire district during the earlier part of the season, and the auxiliary pumping plant will be used after July. The land to be irrigated is ten miles below Brook Lake, hence about fifteen feet lower in elevation. During the dry season it will be necessary to lift the water sixteen feet.

When the big dam is completed there will be a natural water power available, and this is to be developed. It will be used to light the town, which is to be established by that time, to operate the cannery and perform any other work that may be required. The cannery and a drying-house are to be built next year to take care of the surplus products of the district.

The pumping plant will be located at the mouth of the main ditch and will be operated by an eight-horsepower gasoline engine. The pump will have a capacity of lifting thirty-two cubic feet of water a minute, which is estimated sufficient to irrigate three thousand acres. It will cost \$7,000. The capacity of the plant will be increased in 1909.



Big Project for Palouse Country

FOUR thousand acres of land near Hooper, Whitman Co., Wash., south of Spokane, to be known as Pa-

louse Orchards, owned by the Palouse Irrigation and Power Company, headed by H. C. Peters, president, and L. H. Marsh, secretary, will be put under irrigation within the next twelve months, and it is expected that five hundred acres of this will be ready for this year's crop.

Water for the new district will be taken from the Palouse River, which will be tapped by a canal four miles above Hooper, and brought down one mile below the town, whence a wooden flume twenty-four by thirty inches will carry the water one mile farther down the river to the tract of five hundred acres that is to be watered at once. Later a large flume will tap the canal at the same place as the small one and will be led across to the north bank of the river to carry water down to the other tracts that are to be put under the ditch.

Palouse Orchards is unlike any other irrigation project in the Northwest. Instead of one large and continuous tract on one or both sides of the river, it is a series of tracts lying between the river and the high hills on either side, no one tract containing more than five hundred acres. The land extends down the river ten miles, and is close to the base of steep hills and almost surrounded in patches by the ragged arms of the cliffs that jut out into the valley. The land is volcanic ash and the climate is similar to that of Wenatchee, "the home of the big red apple."

Ample water flows in the Palouse River at the dry season to water all of the land that is to be put under the ditch this year, and perhaps all of the four thousand acres, but the Palouse Irrigation and Power Company, which is promoting the project, will not take any chances on a shortage in water supply. Rock Lake, which is ten miles north of Hooper, is to be turned into a vast reservoir and its waters used in the irrigation project.

This will be accomplished by building a dam across Rock Creek, the lake's outlet. It will require \$1,500 to build a dam to raise the water in the lake

several feet and furnish sufficient water for the land owned by the Palouse Irrigation and Power Company. The lake is ten miles in length and from one-half to three-quarters of a mile in width. This work will be done next year. The company owns the water rights on the Palouse River and on Rock Creek and Rock Lake.

At the point where the main canal taps the Palouse River a dam one hundred feet in length has been built at a cost of \$14,000. This will divert practically all of the flow of the river into the canal during the minimum flow, if it is needed. The dam is solid concrete, its foundation resting on the solid rock in the bed of the river.

In taking the water from the river it has been necessary to tunnel seventy feet through the solid rock, and at that point the flood gates are established, keeping the water under perfect control. During certain months of the year enough water rushes down the channel of the Palouse to water one hundred thousand acres.

Three railroads will operate through the district, and of these the Oregon Railroad and Navigation Company is hauling traffic. The others are the Spokane, Portland & Seattle, and the North Coast Railway. Grading will be completed on the Spokane, Portland & Seattle by June 1, and trains will probably be in operation by the end of the year.



American Irrigation Scheme

ONE hundred thousand dollars will be expended by D. K. McDonald and A. C. Jamieson, of Spokane, in installing an irrigation plant and domestic water system on one thousand acres of land in the Spokane Valley, five and a half miles east of here. Two wells with a combined capacity of eight thousand gallons a minute will be bored, and water for irrigating land will be distributed by means of ditches and flumes. The pumps will be driven by electrical power, the cost of this apparatus being \$10,000. The land will cost \$100,000, and it is expected to have it in readiness

for next spring. Electric lights, telephones, and other conveniences will be installed.



More Resolutions

THE following resolutions were adopted by the Faculty of the School of Agriculture, of the Pennsylvania State College, at a meeting held recently:

Whereas, The great natural resources of this and other states in the Appalachian region are being exhausted rapidly for the purpose of immediate development and profit without proper regard for the future agricultural possibilities of this State; and

Whereas, Investigations of the United States Forest Service have shown that the destruction of the forest cover on our mountains and hills has not only destroyed in large part the lumber industry of the East, and seriously injured mining and manufacturing industries which are dependent upon a regular and permanent supply of timber, but have also shown that the wholesale clearing of forests from the watersheds of streams rising in the Appalachian Mountains has resulted in tremendous and irreparable damage to farms and orchards along these streams. The erosive action of freshets and floods has seriously injured agricultural land upon steep hillsides, and by the covering of bottom lands with gravel and other debris has rendered lands valueless for farming purposes. It has been shown that with a forest cover at the head waters of the streams and upon steep mountain sides the very disastrous floods of recent years could not have occurred. Therefore, be it

Resolved, That the Faculty of the School of Agriculture of the Pennsylvania State College recommend the increase of forest ownership and control by the National Government, and to further this movement recommends the early establishment of the proposed Appalachian-White Mountain Reserves. And be it further

Resolved, That we recommend that measures for reforestation upon our National forests be begun and pushed rapidly forward.

Resolved, further, also, That copies of these resolutions be sent to the Representative in Congress from this dis-

collecting data for the benefit of the agriculturists who are developing the Western plains. At present windbreaks are planted haphazard, one kind here, another there. If one kind is better than another, the government experts think that fact ought to be known,



WINDBREAK

Monterey Cypress Sheltering an Orange Orchard, San Bernardino County, California

trict, with the request that he support, so far as possible, the recommendations herein made.

Government to Study Shelterbelts for Benefit of Farming Interests

UNCLE SAM'S tree-planting and farm experts have just undertaken a practical and scientific study of the use and effect of timber windbreaks and shelterbelts in the agricultural regions of fourteen Western states. This is the first time in this country that a study of this much-discussed question has been undertaken over a wide region under one plan, for the purpose of

and it is believed that the study about to be undertaken will settle the question once for all. It will at least collect such facts never before brought together.

The work will be done by the United States Forest Service. In some states the agricultural experiment stations will cooperate in the studies, and in these cases the Forest Service will provide the necessary apparatus, and the other expenses will be shared half and half by the Government and experiment stations. The investigations will be taken up in five states this year and extended to the other nine as rapidly as the investigations are completed. Four of the states in which the study will be

made this year are Nebraska, Colorado, Oklahoma, and Kansas. The fifth will be either Minnesota, North Dakota, or Iowa. Ultimately the investigations will cover Minnesota, North Dakota, South Dakota, Nebraska, Iowa, Kansas, Oklahoma, Colorado, Texas, New Mexico, Utah, California, Washington, and Idaho.

The sudden ruin that hot winds sometimes bring to growing crops in parts of the West is well known. Blowing strongly across the unobstructed plains, these winds may in a few days blast all hope of even a partial harvest. This is particularly true in the lower portion of the central plains region, and in years of unusually low rainfall. Here the winds most to be feared blow from the southwest or south. In the northern prairie region the former is exposed to the hot "Chinook" wind, which sweeps down from the Canadian mountains. This either dries out growing crops, or, if it prevails before the danger of killing frosts is past, causes loss through urging vegetation forward prematurely. Cold winter winds also do great injury to crops, make the climate more severe for stock and men, and interfere with an even covering of snow upon the ground. This is true from Canada almost to the Gulf.

In Southern California, dry winds from the north and northeast sweep down from the Mohave Desert with destructive results. Coming in June, these winds may reduce the wheat yield of unprotected fields to almost nothing. Windbreaks of eucalyptus and Monterey cypress, now in such common use to protect orange groves and orchards, long ago convinced possessors of highly valuable irrigated land of the value of tree planting for protection purposes.

But there are two sides to the windbreak question. Some prairie farmers declare positively that belts of osage orange, for instance, are a "nuisance." Others cite figures to show positive benefit. Mr. Morris Thompson who lives near Downs, Kans., gives his yield of corn from a field protected on the south by a row of tall cottonwoods as

six bushels per acre more than in places where there is no protection. About fifteen acres are benefited in this way. It is highly improbable that the windbreak occupies sufficient land to offset this benefit.

An Illinois farmer sums up his observations upon this matter thus: "My experience is that now, in cold and stormy winters, wheat protected by timberbelts yields full crops, while fields not protected yield only one-third of a crop. Twenty-five or thirty years ago we never had any wheat killed by winter frosts, and every year a full crop of peaches, which is now rare. At that time we had plenty of timber around our fields and orchards, now cleared away."

The Forest Service proposes to find out just when and how much windbreaks increase the yield of crops. To carry out the plans, much technical work will be necessary. Instruments will be used to measure heat and cold, moisture and dryness, both above and below ground; to register the force of the wind near the windbreaks, and some distance away; to measure light intensity, and take note of the effects of shade; to register frost at different distances from the trees; and to keep account of the effect of the windbreaks on the snow which covers the ground to leeward in winter. Many other measurements and tests will be made, and elaborate data will be collected by experts who will have charge of the study.

Many disputed questions will thus be settled and the data gathered will be placed at the disposal of the farmers who desire it. Doubtless rows of trees between fields sometimes do more harm than good, by casting shade and abstracting water from the soil. Trees may also increase the danger from frost, since the movement of the air lessens that danger. The Forest Service will study all sorts of conditions, including the relative value of windbreaks, consisting of a single row of trees, and shelterbelts, made up of a number of such rows. A windbreak is usually planted for protection alone.

a shelterbelt for both protection and the growing of timber.

Corn will be the crop studied behind the windbreak this year. Trustworthy conclusions cannot be obtained by comparing results from different crops. Each crop makes its own demand upon the soil, so that what would destroy one might do little harm to another. Corn is a particularly good crop to experiment with because it is easily injured by hot, dry winds, will not stand shading, and is very sensitive to frost.

The instruments and apparatus for each state will be read weekly by persons assigned to that duty by the Agricultural Experiment Stations in the respective states. The whole work will be in charge of an expert for the Forest Service at Washington, who will be assisted this summer by three or four persons, also from the Forest Service, who will study general conditions in the states under investigation, in regard to the effect of windbreaks on crops. The work will continue until crops are gathered next fall, when the actual yield of sheltered fields will be measured, and results compared with near-by unsheltered fields. Some of the observations will continue through the winter.

It is expected that the results will be published both by the Forest Service and by the experiment stations which cooperate in carrying out the work.



Wood-pulp Report

A PRELIMINARY report of the consumption of pulp wood and the amount of pulp manufactured last year has just been issued by the Bureau of the Census. The advance statement is made from the statistics collected by the Census Bureau in cooperation with the United States Forest Service.

Many of the figures bring out interesting facts which show the rapid growth of the paper-making and allied industries during the last decade. Nearly four million cords of wood, in exact numbers 3,962,660 cords, were used in the United States in the manufacture of

paper pulp last year just twice as much as was used in 1899, the first year for which detailed figures were available. More than two and one-half million tons of pulp were produced. The pulp mills used three hundred thousand more cords of wood in 1907 than in the previous year.

The amount of spruce used was sixty-eight per cent. of the total consumption of pulp wood, or 2,700,000 cords. The increased price of spruce has turned the attention of paper manufacturers to a number of other woods, hemlock ranking next, with 576,000 cords, or fourteen per cent. of the total consumption. More than nine per cent. was poplar, and the remainder consisted of relatively small amounts of pine, cottonwood, balsam, and other woods.

There was a marked increase last year in the importation of spruce, which has always been the most popular wood for pulp. For a number of years pulp manufacturers of this country have been heavily importing spruce from Canada, since the available supply of this wood in the north-central and New England states, where most of the pulp mills are located, is not equal to the demand. Figures show that the amount of this valuable pulp wood brought into this country was more than two and one-half times as great in 1907 as in 1899. In 1907 the importations were larger than ever before, being twenty-five per cent. greater than in 1906. The spruce imports last year amounted to more than one-third of the consumption of spruce pulp wood. Only a slightly greater amount of domestic spruce was used than in 1906.

Large quantities of hemlock were used by the Wisconsin pulp mills, and the report shows that the Beaver State now ranks third in pulp production, New York and Maine ranking first and second, respectively. Poplar has been used for a long time in the manufacture of high-grade paper, but the supply of this wood is limited and the consumption of it has not increased rapidly.

Wood pulp is usually made by either one of two general processes, mechani-

cal or chemical. In the mechanical process the wood, after being cut into suitable sizes and barked, is held against revolving grindstones in a stream of water and thus reduced to pulp. In the chemical process the barked wood is reduced to chips and cooked in large digesters with chemicals which destroy the cementing material of the fibers and leave practically pure cellulose. This is then washed and screened to render it suitable for paper making. The chemicals ordinarily used are either bi-sulphite of lime or caustic soda. A little over half of the pulp manufactured last year was made by the sulphite process, and about one-third by the mechanical process, the remainder being produced by the soda process. Much of the mechanical pulp, or ground wood as it is commonly called, is used in the making of newspaper. It is never used alone in making white paper, but always mixed with some sulphite fiber to give the paper strength. A cord of wood ordinarily yields about one ton of mechanical pulp or about one-half ton of chemical pulp.



France's Far-sighted Forest Policy

FRANCE has under way a far-sighted forest policy which will require two centuries before the work reaches its greatest efficiency. The plan covers the reforestation of vast tracts of denuded land and the work is in the hands of four thousand trained foresters in the pay of the Republic, and a large number of men employed by the communal governments.

Consul General R. P. Skinner tells how this work is being done by a great nation keenly alive to the necessity of doing it, and determined that it shall be done well, though years and centuries are consumed in the doing. Colbert, in the reign of Louis XIV, exclaimed: "France will perish for lack of wood," and his prophecy was coming true a century and a half later, when the French people awakened to the peril which threatened them, and called a halt.

Their forests were vanishing as are those in the United States to-day, but the depletion had gone even farther than it has yet gone in America. France commenced protecting and restoring its wooded areas nearly a century ago, and has stuck to the task ever since, but so much yet remains to do that Mr. Skinner says in his report:

"The work is slow. It will require probably two hundred years to bring it up to its maximum effectiveness. But the time is foreseen when existing damaged forests will be reconstituted, and when all the waste spaces will be replanted to the point of proper proportion to insure the conservation of the water supply, and to furnish the timber and wood required by the population. The effect upon private landowners of this public work has been most salutary. Where bald mountains have been replanted, very surprising local results are now visible to all observers. This is especially true in the Hautes Alpes, which had the enviable reputation of being the poorest department of France, and is, in fact, one of the few from which the United States has received several thousand French immigrants. There are now many artificially planted forests in this department of twenty-five years' standing, and in the bottomland below, conditions have so improved that a state of general prosperity prevails."

The plan of the French foresters is comprehensive. It embraces the care of forest land, planting of trees, fixation of dunes near the coasts to prevent the drifting of sand upon agricultural land, utilization of water in pastoral and forest regions, and the surveillance of river fishing and fish culture. This comprehensive service extends to every part of the Republic.

The area of the National Forests of the United States exceeds twenty-fold the national and communal forests of France, but the problems are the same. France has been longer at the work and when it began its forests were in a worse condition than ours are now, but no worse than our privately owned

forests will be if present methods continue.

Consul General Skinner concludes his report with the suggestion to those in America who have shown sufficient interest in the matter to write him on the subject:

"If correspondents could penetrate, as the writer has done, the almost inaccessible mountain villages of this country, and there discover the enthusiastic French forester at work, applying scientific methods which cannot come to fruition before two or three hundred years, they would retire full of admiration and surprise and carry the lesson back to the United States."

The American Nile

THE Geological Survey has published (in Water-supply Paper No. 211) a most interesting comparison of the Nile, the Colorado, which has been called the Nile of America, and the Susquehanna. The Nile and Colorado are similar in type, and the Susquehanna is introduced to show the difference in flow between arid and humid regions. The comparison uses a normal year based upon records for the Colorado and Susquehanna, collected by the Survey in the last ten years, and such data as could be found in regard to the Nile. The Colorado is taken as the standard of comparison.

The Nile has 5.7 times the drainage area and the Susquehanna about one-eighth the area of the Colorado.

The rainfall in the Nile basin is 3.8 times greater; that in the Susquehanna basin is 4.5 times greater. The run-off per square mile from the Nile basin is 1.9 times greater; that from the Susquehanna basin is thirty-seven times greater. The ratio of run-off to rainfall in the Nile basin is one-half as

great; that of the Susquehanna basin is 8.2 times greater.

The discharge of the Nile is 10.8 times greater; that of the Susquehanna is 4.5 times greater.

The maximum flow of the Nile is about three hundred fifty-three thousand second-feet, and occurs about the first of September; that of the Colorado is from seventy thousand to one hundred ten thousand second-feet, and occurs in May, June, or July; that of the Susquehanna is from two hundred thousand to four hundred thousand second-feet, and occurs during March, April, and May.

The minimum flow of the Nile is about fourteen thousand five hundred second feet, and occurs about the end of May; that of the Colorado is from two thousand five hundred to three thousand second-feet, and occurs during January and February; that of the Susquehanna is from two thousand five hundred to five thousand second-feet, and occurs in September and October.

The mean flow of the Nile is about one hundred fifteen thousand eight hundred second-feet, of the Colorado about ten thousand seven hundred second-feet, of the Susquehanna about forty-three thousand second-feet.

Estimates of the amount of sediment carried by the Nile and Susquehanna are not given, but the water of the Colorado is said to carry an immense amount, reaching as high as two thousand parts of sediment to one hundred thousand parts of water. Prof. R. H. Forbes, in a bulletin of the Arizona Agricultural Experiment Station, states that "it is estimated conservatively that the river brought down during 1900 about sixty-one million tons of sedimentary material, which, condensed to the form of solid rock, is enough to cover 26.4 square miles one foot deep, or to make about 164 square miles of recently settled submerged mud one foot deep."



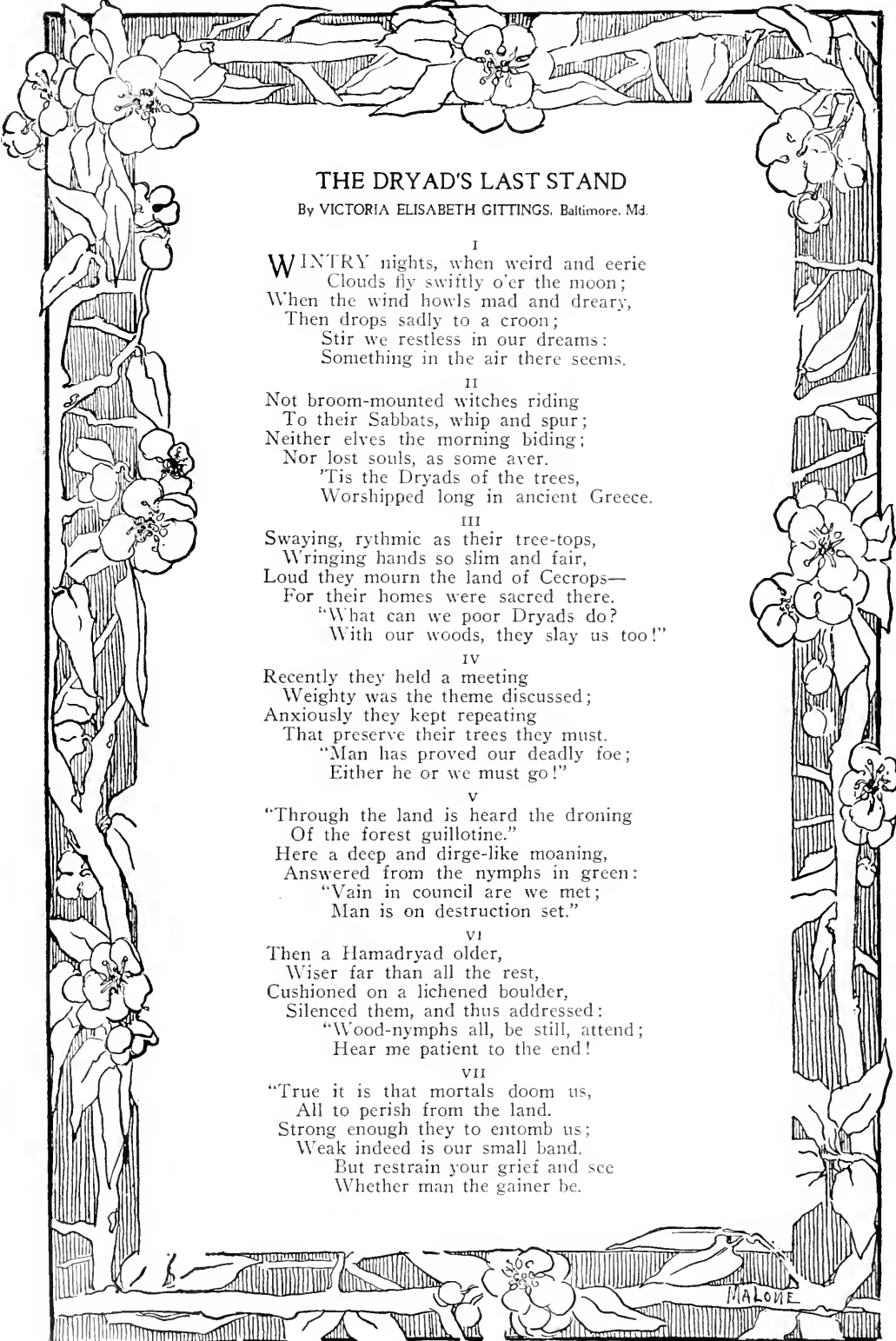

THE DRYAD'S LAST STAND

By VICTORIA ELISABETH GITTINGS, Baltimore, Md.

I
WINTRY nights, when weird and eerie
Clouds fly swiftly o'er the moon;
When the wind howls mad and dreary,
Then drops sadly to a croon;
Stir we restless in our dreams:
Something in the air there seems.

II
Not broom-mounted witches riding
To their Sabbats, whip and spur;
Neither elves the morning biding;
Nor lost souls, as some aver.
'Tis the Dryads of the trees,
Worshipped long in ancient Greece.

III
Swaying, rhythmic as their tree-tops,
Wringing hands so slim and fair,
Loud they mourn the land of Cecrops—
For their homes were sacred there.
"What can we poor Dryads do?
With our woods, they slay us too!"

IV
Recently they held a meeting
Weighty was the theme discussed;
Anxiously they kept repeating
That preserve their trees they must.
"Man has proved our deadly foe;
Either he or we must go!"

V
"Through the land is heard the droning
Of the forest guillotine."
Here a deep and dirge-like moaning,
Answered from the nymphs in green:
"Vain in council are we met;
Man is on destruction set."

VI
Then a Hamadryad older,
Wiser far than all the rest,
Cushioned on a lichened boulder,
Silenced them, and thus addressed:
"Wood-nymphs all, be still, attend;
Hear me patient to the end!"

VII
"True it is that mortals doom us,
All to perish from the land.
Strong enough they to entomb us;
Weak indeed is our small band.
But restrain your grief and see
Whether man the gainer be.

VIII

"When abroad in heat of noon-day,
Vainly will he seek the shade;
Vainly trust his footsteps soon may
Lead him to some sheltered glade.
When for cooling draughts he'll long,
Hushed will be the brook's glad song.

IX

"Poet and his artist brother,
Sick of ocean's monotone,
Will begin to search for other
Subjects in the forests lone.
But of these no trace they'll find—
Save the dead roots left behind."

X

With surprise in growing measure
Did these words the wood-nymphs hear;
Gone, the speaker marked with pleasure,
Were repining sigh and tear.
Then he finished: "Man should weigh
'Gainst his gains, the price to pay!"

XI

"Now, my nymphs, I'm weary dwelling
On man's folly, in good sooth,
Gained my object, all-compelling,
Which was to convey this truth:
That revenge will yet be ours,
E'en though dealt by higher Powers."

XII

"Then your counsel is, O brother,"
Cried a Dryad young and fair,
"That we struggle not, but smother
Love of life in meek despair.
This—your pardon, I entreat—
This is neither wise nor meet!"

XIII

"Now, if we succeed in showing,
Poor, dull-witted man that he
For his own loved race is sowing
Seeds of future misery—
Haply he will pause—take breath,
Think—and stop his work of death."

XIV

Such the cordial, hearty greeting,
Given to this hopeful speech
That when dawn broke up the meeting,
Each nymph pledged herself to teach
Erring man his ways to mend,
That he spare his life's true friend!

IN THE DEPARTMENTS

Forest Service, Reclamation Service, Geological Survey

Washington National Forest

LAST summer the Geological Survey began the mapping of the Mount Baker quadrangle, in the state of Washington. This area lies in the northwestern corner of the Washington National Forest, west of the main range of the Cascades, north of the Skagit River, and south of the British Columbia boundary. It is a region of low valleys, high mountains, heavy timber, and dense brush. Standing as it does almost directly east of the Straits of Fuca, it catches all the precipitation brought in by the moisture-laden winds of the Pacific, and hence it rains much of the time, although there is a so-called dry season from June to September.

The area is covered with a splendid growth of fir and cedar, some of the fir trees being sixteen feet in diameter, while many of the cedars are twelve feet. This forest would be much improved if the ripe, dead, and down timber were removed, thus facilitating the more rapid growth of the young trees. Cutting the timber could easily be accomplished, as the slopes all lead down to railway transportation, a short distance to tidewater and market.

The two main valleys, the Skagit and Nooksack, are low, and an immense number of smaller streams flow into them. All carry large volumes of water over steep gradients and offer unexcelled opportunities for the development of water power, which will undoubtedly sometime be utilized. Two large cement plants at the village of Baker now get their power from side streams above them, using small volume of water under big head, and a large electric plant on the North Fork of the Nooksack furnishes light and power to the city of Bellingham.

Mount Baker, ten thousand eight hundred feet, and Mount Shuksan, nine thousand one hundred feet, are the most prominent peaks in this region. Baker Lake, seven miles east of Mount Baker, and six miles south of Mount Shuksan, is only six hundred sixty feet above the sea.

The glaciers of Mount Baker are among the largest ice fields in the United States proper, and reach down to three thousand five hundred feet above sea level.

Travel in this region is mostly on foot, as roads and trails are few and it is impossible to take animals away from them. Under such conditions the making of a topographic survey is most laborious. The worker must fight his way through brush and over fallen logs and wade ice-cold streams while toiling up or down steep slopes with a pack on his back containing short rations and scanty bedding, sleeping nights at any place he happens to be, always tired, and most of the time hungry, wet, and ragged.



Reclamation in the Northwest

THE great agricultural development now going on in the far Northwest is attracting widespread interest throughout the country. On three of the Government irrigation projects approximately one hundred thousand acres of fine farming land is now ready for settlement. These lands lie under the Lower Yellowstone project, Montana-North Dakota, the Huntley project in Southern Montana, and the Shoshone project in Northern Wyoming. The projects are divided in forty-acre and eighty-acre farms, which are given away to bona fide settlers, who are required to pay only the actual

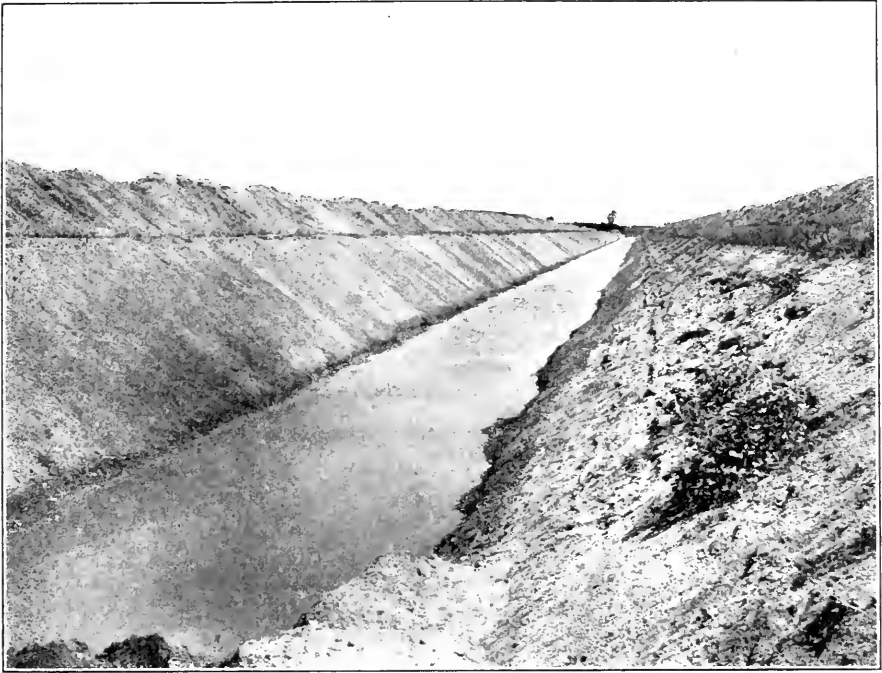

LOWER YELLOWSTONE PROJECT, MONTANA
Finished Portion of the Main Canal. Sixty Miles in Length

cost of building the irrigation works. This cost is divided pro rata among the lands benefited, and is payable in ten annual instalments without interest.

That homeseekers are not overlooking this opportunity is evident. Hundreds of inquiries are being received daily at the office of the Reclamation Service, and trainloads of settlers are hastening to the new fields. Compact farming communities are being established along the canal lines, and villages and towns are appearing as if by magic.

These projects possess many conditions in common. Excellent transportation facilities are afforded by the C., B. & Q., Northern Pacific, and Great Northern Railroads, which connect them with the Denver, Twin Cities, and Pacific coast markets. The irrigable lands are surrounded by a fine free-range country, and alfalfa, the great forage crop of the West, is especially adapted to the soil and climate. The lands lie at an elevation of from three thousand to four thousand feet above

sea level, the climate is healthful and delightful, and the soil is of exceptional fertility. Sugar beets promise to be a profitable crop. A beet-sugar factory is already established at Billings, near the Huntley project, and factories on the other projects are assured as soon as areas large enough to warrant their establishment are cultivated. Cereals, apples, small fruits, and garden vegetables do well, and it is probable that these valleys will develop into excellent dairy countries. Many thriving towns have sprung up along the railroad lines, so that all the farms will be within short distances of shipping points. Cheap fuel is found in the lignite mines of North Dakota and the coal mines and forests of Northern Wyoming.

The lands now open to settlement under the Shoshone project consist of fifteen thousand acres lying about seventy-five miles east of the Yellowstone National Park. The farm units are eighty acres, and the building charge,

\$45 per acre, payable in not less than five nor more than ten annual instalments. In addition there is an annual charge of \$1 per acre for operation and maintenance. One-tenth of the building charge and one year's maintenance and operation fee, or \$5.50 per acre, becomes due at the time of filing.

The Huntley project is situated on a part of the ceded portion of the Crow Indian reservation, and settlers are required to pay \$4 per acre to the Indians, \$1 at the time of entry, and 75 cents annually for four years. The cost of building the irrigation works is \$30 per acre, payable at \$3 per annum for ten years; the payments may be made in five years if desired. The maintenance charge is 60 cents per acre. The first payment of \$4.60 becomes due when the land is filed on.

The cost per acre of water rights on the Lower Yellowstone system has not yet been determined, but water will be available for forty-eight thousand acres in the spring of 1909.



Would Prevent Spring Floods

THE greatest development of water power that has ever taken place in the United States has been accomplished during the last few years on the rivers which drain the Southern Appalachian Mountains, according to an official report on the water resources of this region. It is estimated that there is at least two million eight hundred thousand indicated horsepower developed by the streams which have their headwaters on this watershed, and more than half of this indicated power is available for economic development.

Only a comparatively small part of this has been made use of yet, but the portion that has been utilized has been one of the most important factors in the recent industrial development of the South. In the future the use of this power and its value are bound to increase tremendously. Manufacturing plants are constantly increasing in number in the region, and it is reasonable

to expect that in time the center of the cotton-weaving industry in the United States may be moved from the streams of New England, where it has remained so long, nearer to the source of supply for the raw material.

Moreover, water power, or power originating in the streams, will be more and more in demand here, as everywhere else in the country, on account of the increasing cost of fuel power through dwindling fuel resources of the country. Already the water power costs much less than the fuel, and the difference will inevitably grow greater. One great difficulty of the users of water power, not only in the South, but along the New England streams as well, though possibly to a less degree, is the fact that it cannot be depended upon the year around, but must be supplemented and replaced for some weeks or months every summer by costly fuel power, because the streams run too low to be of service.

More than this, as the years go on mill owners are painfully aware that the low-water periods are growing longer and longer. This is because the forests at the headwaters of the streams are being cut off, with the result that the melting winter snows and the spring rains pour off the denuded and hardened land in devastating floods, sending down for a few weeks far more water than they can use, and, moreover, reducing the capacity and usefulness of their mill ponds by filling them with hundreds of tons of sand and soil which the floods scour off the unprotected upper slopes.

Nowhere are business men wider awake to the danger than in the South. If indiscriminate cutting of the forests on the crests of the watershed can be stopped there is a possibility, according to a recent report of experts, of increasing the development of power up to anywhere from three to thirty times the one million four hundred thousand horsepower at present available. Without it, almost nothing can be done. The method proposed to develop the Appalachian river resources to the total of forty-two million horsepower is

by storage reservoirs, which would catch the surplus waters of the spring and retain them until the summer months, when the mills now have to fall back on fuel or close down.

The United States Geological Survey has kept records of stream flow in the Appalachians for a number of years and recently they made a careful study of the possibilities of storage reservoirs in that region. The Forest Service has published their report under the title "The Relation of the Southern Appalachian Mountains to the Development of Water Power," as Forest Service Circular 144, and will send it free to any one upon application. The experts of the Geological Survey who made the investigation, after picking out reservoir sites and estimating their capacity and the area from which they would receive the run-off, consider the figures given above extremely conservative. Even with only one million four hundred thousand horsepower, the annual return at \$20 per horsepower per year would amount to \$28,000,000. That is equal to a gross income of three per cent. on a capital of about \$933,000,000. These figures seem to justify a considerable outlay of money to achieve the benefits promised.



Forest Service Supply Depot at Ogden

ARRANGEMENTS have been completed by the Forest Service for a central supply depot to be established at Ogden, Utah. Mr. A. M. Smith, who has been property clerk of the Forest Service at Washington for the past year, began the organization of the office about the middle of June, and after July 1 all National Forest supplies will be distributed direct from Ogden.

The establishment of this supply de-

pot at Ogden, a central point in the West, is in accordance with the policy of the Forest Service to do as much of its work in the field as possible. It is estimated that both time and money will be saved by having the distributing point at Ogden instead of Washington. It is expected that Western producers will meet the demands of the depot and cooperate with the Service in making the movement successful and in expediting business. In keeping with the same policy of the Service, a branch of the office of Engineering, which has charge of the extensive permanent works now under way on the National Forests, has been established at Ogden.



Maps of the Grant's Pass Quadrangle

A NEW sheet of the topographic atlas of the United States, known as the Grant's Pass (Oregon) sheet, has been published by the United States Geological Survey. The region covered by the map extends northward from the Oregon-California line to parallel forty-two degrees, thirty minutes, which is about five miles north of Grant's Pass, and from the eastern border of range three W. to the eastern third of range seven W., corresponding to meridian 123 degrees to 123 degrees thirty minutes W. It shows large portions of Rogue River Valley and that of its tributary, the Applegate, as well as the Siskiyou Forest Reserve.

The map is of interest in connection with both forestry and irrigation, as it clearly shows the relation between the two in this part of Oregon. The broad alluvial valleys lying immediately north of the reserve contain many reservoir sites, which may be utilized in the development of irrigation and water power.



FOREST CONSERVATION

Paper Read at the White House Conference

By R. A. LONG

PRESIDENT ROOSEVELT in addressing a body of business men in June, 1903, among other things said: "The forest problem is in many ways the most vital internal problem before the American public to-day," and that "the more closely this statement is examined, the more evident its truth becomes."

I want thus early in my address to lend emphasis to this statement, for coming from such a source and from one so prolific of good deeds pertaining to public matters, and one who has given such careful study and arrived at such wise conclusions concerning so many of the live and vitally important subjects before us in recent years, it should induce our minds to be in a most receptive mood, and if what we have to say is true and practicable, it is advisable that it shall find such lodgment in the minds of our people as will compel action and result in carrying out the purposes for which this conference is called.

Since I was to be honored with a place on this platform I am glad this subject was left for me; for it has to do with a thrilling, throbbing, and beautiful life, which is less true of any of the other subjects to be discussed.

'Tis true, some of our forests, as it were, lay aside their beautiful gowns in the fall, passing apparently into sleep, in which condition they remain until spring, when again they don a garb even more beautiful—not of silk or satin, trimmed with gorgeous ornamentation of man-made goods, but of a kind fashioned by an artist who makes no mistakes, and never fails to please the most fastidious and artistic.

The remainder of our magnificent forests, and much the larger part, continues to wear its mantle of green, not only during the springtime and in the summer days, but defies the frosty fall season and the zero weather of the wintry days. The tree has ever been the symbol of life, strength, beauty, and of rest, and the eye of man cannot continue to look, day after day, upon these stately God-given queens of nature without their charm being reflected in his life, making him a healthier, happier, and better man; and their destruction means not only the removal of our most desirable natural resource, from a practical and utilitarian standpoint, but from the viewpoint of health, morality, spiritual-

ity, and beauty, their loss would be irremediable.

There is much more that might be said on the sentimental side of this subject, but I refrain and pass to the practical side.

I want to lay down, first, the broad proposition that, aside from the soil itself, no other natural resource compares with our forests. Can you think of one that comes so nearly supplying every want of man? From the tender, touching song we hear "There is no place like home"—that place so sacred to every one worthy to wear the title of man—and we know that there is no other resource under the sun that supplies so many homes in every essential as does the tree, especially as applied to the large majority of our people, those whose labors go hand in hand with the prosperity of our nation.

However crude the workman, with only an ax for his tool, he may go into the forest and build a comfortable home in which to live. The leaves and bark of the tree may be converted into clothing for his body, and the nuts and fruits give him sustenance. Look within the house, be it shanty or mansion, and the furniture will remind you of this natural resource.

The ties supporting the great railway systems of this country, and nearly all the buildings connected therewith, are of its product.

The mines—coal, copper, gold, silver—yea, all minerals, from the cheapest to the dearest, require its use for their production and our satisfaction.

Data gathered tells us we are using not less than one hundred sixty-five million cubic feet annually in this direction.

What of the millions and millions of tons of paper on which is printed the news by our great daily newspapers, making it possible for even the poorest inhabitants of all the nations of the earth to keep posted as to the daily happenings of the world?

It is claimed, and I believe truthfully, that at least ninety-nine per cent. of the products of our forests are used for practical and useful purposes; yet of the total quantity of these products but a small fraction is actually utilized, probably three-quarters going to waste.

It is conceded also that forests aid much in the utilization of our rainfall, as the leaves and branches of trees and the accumu-

lation of humus and leaf-mold resist the compacting effect of the raindrops, and hence the soil is kept loose, allowing the water to readily percolate. This covering of loose litter, twigs, etc., absorbs and holds back the precipitation, preventing its disappearing rapidly by surface drainage, goes largely into the ground, and as a subsoil or underground drainage, reappears in the form of springs, which being gradually fed by percolation from above, themselves feed rivulets or streams of perennial character. The snows of winter melt more gradually in forest-covered areas, giving more time for the water resulting therefrom to soak into the ground and pass off through the springs. The streams fed from such sources have a continuous supply to be used for irrigation or such other purposes as man may require.

On the other hand, when the forest lands have been denuded, the rainfall passes rapidly away, and its resulting effect is not long felt or seen excepting by the filling of the channels of the stream by slit, sand, and gravel washed from above, and the result of the waters having spread over the adjacent low lands, destroying crops, improvements, live stock and sometimes even the lives of the inhabitants. It is not unusual in some sections for the fertile valley lands to be destroyed by gravel, stones, and debris carried and deposited by the waters.

Water power exerted through electrical energy, and in operation in so many industries, is impossible without constant and uniform water supply, and this cannot be had except along streams whose head waters have an adequate protection of forest covering; otherwise, the erosion of the soil soon fills the reservoirs, and waters running unobstructed on the surface converge in great torrents, carrying logs and debris of all kinds, surging irresistibly through the river valleys, taking with it dams, gates, power plants, and destroying what it cannot carry away.

Originally the rivers and even the rather small water courses of our country were to a greater or less extent navigable. Their channels were deep, their waters mostly clear and free from sediment and silt. At the present time, owing to the deforestation of the lands along their banks, and especially of their head waters, the breaking up of the sod and the loosening of the soil consequent upon settlement and cultivation of crops, these channels, formerly deep, have been in some instances entirely filled, and everywhere rendered more shallow, until water transportation has ceased and river navigation has become almost obsolete on rivers which were once teeming with commerce.

Our Government is at great annual expense in the construction of levees, dikes, jetties, and other devices to prevent the destructive overflows, and in dredging and deepening the channels in order that sufficient depth of water may be obtained and preserved to encourage the re-establishment and preservation of our waterway navigation,

so that means of transportation, competitive with and supplemental to that furnished by our railroads may be had; a substantial proportion of the money and energy thus expended, if used in the preservation of our forests, would materially better conditions in this regard.

The western half of the United States contains enough fertile land, now barren and unprofitable, only because of insufficient moisture, to support under adequate irrigation a population of probably fifty million people; further than this, as it has been truly said, such population in the West would support a like additional population in the manufacturing districts of the East, and the two would support another large population engaged in the transportation and distribution of the commodities of commerce between them.

The possibility of such irrigation depends largely on the preservation of the forest cover of the mountains, which catches and holds the melting snows, and thus forms the great storage reservoirs of nature.

We have been for many years, and are now, using all our resources of diplomacy, and even almost threatening at times to reinforce it, if necessary, by our naval and military strength, to maintain an "open door" in the Far East for the benefit of our commerce, while at the same time we have only dimly realized the possibilities of building up an empire in our midst, whose yearly requirements of the commodities of commerce would equal the requirements of an equal number inhabitants of the Far East for a generation, and the annual purchasing power of whose productive activities would amount to more than all the goods we could hope to sell through the "open door" in possibly more than a quarter of a century.

We have it upon the authority of the Holy Writ, that a thousand years before Christ the eastern shore of the Mediterranean was the seat of large cities having an extensive maritime commerce. The mountain region bordering east and west, extending for many miles inland, was covered with a dense forest, comprising the cedar of Lebanon, the fir and the sandal wood, covering an area of three thousand five hundred square miles. The inhabitants of Sidon were largely engaged in cutting, hewing, and shipping timbers from the forests of Lebanon, and the seat of Sidon was a great lumber market, and its citizens skilled ax-men.

The cities of Tyre and Sidon were largely constructed of wood; their ships built of cedar, the masts of fir, and oars of oak. Solomon procured all of the timbers used in the construction of the Temple, as well as in other buildings, from the forests of Lebanon by a contract therefor with Hiram, King of Tyre, in whose dominion they lay, and he supplied eighty thousand laborers to assist in cutting and hewing the trees. The timber was loaded into ships and conveyed to Joppa, thence by land to Jerusalem. The region about Jerusalem was fertile, and Solomon

provisioned more than one, hundred fifty thousand men for a period of perhaps twenty years, and supplied Hiram with one hundred fifty thousand measures of wheat, with as much barley, besides one hundred fifty thousand gallons of wine, and a like quantity of oil annually, from which we must understand the country was rich and productive. These forests have all been destroyed, with no renewal thereof, and with their destruction disappeared the fertile soil. The rain-bearing clouds still float above the mountains of Syria, but they pass on over the bare and heated rocks, and the brooks and small streams of Palestine no longer exist, and throughout Syria stone furnishes the only material for building, and wood is as precious as silver.

May it not be true that the destruction of Tyre and Sidon was in great part in consequence of the destruction of these forests, which has rendered that country a barren desert, supplying a scanty sustenance to the sparse population—its beauty, its fertility, its usefulness gone? So the physical geographers assure us.

In "Sinai and Palestine," by Dean Stanley, an authoritative record, appears the following:

"The countless ruins of Palestine, of whatever date they may be, tell us at a glance that we must not judge the resources of the ancient land by its present depressed and desolate state. They show us, not only that 'Syria might support tenfold its present population, and bring forth tenfold its present product,' but that it actually did so. And this brings us to the question which eastern travelers so often ask, and are asked on their return, 'Can these stony hills, these deserted valleys, be indeed the Land of Promise, the land flowing with milk and honey?'"

The effect and influence of forests on the climate, health and water conditions of the country is evidenced by the chronicles of the Mosaic, the Roman and the Greek writers, and many of their far-seeing priests prevented the destruction of the forests. The consecration of groves to religious uses and to various mythological rites connected with them is an evidence of the reverence the ancients had for forests. Homer calls the mountain woodlands the "habitations of the gods, in which the mortals never felled the trees, but where they fell from age when their time had come;" and in his "Tree and Woodland Nymphs," originating in springs, he suggests the intimate relation of forests and springs.

Aristotle, in his "National Economy," points out that an assured supply of accessible wood material is one of the "necessary conditions of the existence of a city."

Plato writes that the consequences of deforestation is the "sickening of the country." Cicero, in one of his philippics, designates those engaged in forest devastation as the enemies of the public interests.

Mesopotamia, one of the most sterile countries in the East, was once praised on ac-

count of its fertility, where, according to Herodotus, "the culture of the grape could not succeed on account of the moisture;" and the Euphrates River, once the source of an ample water supply, is swallowed up in this desert.

Greece shows the progress of a similar decadence. Sicily, once the never-failing granary of the Roman Empire, while it was well wooded, is now entirely deforested and crop failures are the rule. Cæsar and other Roman writers describes the "vast forests" throughout the entire territory. Since then, thousands of square miles have been deforested. Many countries, where the destruction has been most reckless, have taken systematic measures to control the destruction and secure the reproduction of exhausted areas. To this they have been driven, not only by the lack of timber and fuel, but also by the prejudicial effects exerted upon the climate and the irrigation of the country by this denudation.

In Denmark much of the woods, which at one time covered nearly the whole country, having been cut down to make way for agriculture and to supply fuel and timber, the vast area thus bare has become a sandy desert. Parts of Bohemia, Hungary, and Austria have been rendered practically valueless, because the growing forests were destroyed.

In France, the frequent inundations of the last fifty years were caused, as is stated by writers, by the deforesting of the sources of the Rhone and the Saone. Since that time, thousands of acres are annually planted, and where the forests have been restored, the conditions have changed for the better.

In Encyclopedia Britannica, volume 6, page 4, it is said: "Hence, the essential difference between the climate of two countries, the one well covered with forests, and the other not, lies in this, that the heat of the day is more equally distributed over the twenty-four hours in the former case, and therefore less intense during the warmest part of the day; hence the nights are warmer and the days are cooler in wooded districts." And so it is also said, "Nothing is more certain than that forests not only prevent evaporation of moisture by protecting the surface of the earth, but they serve to retain the light clouds which otherwise would be distributed until they contain sufficient consistency to descend in rain or refreshing mists."

In the American Forest Congress in 1905 the Hon. John Lamb quoted the following from Bernard Palissy, which is so pregnant of truth that it will bear repeating: "For when the forests shall be cut all arts shall cease and they who practice them shall be driven out to eat grass with Nebuchadnezzar and the beasts of the field. I have at divers times thought to set down in writing the arts that would perish when there shall be no more wood, but when I had written down a great number, I did perceive that there

will be no end of my writing, and having diligently considered, I found that there was not any which could be followed without wood, and I could well allege a thousand reasons, but it is so cheap a philosophy that the very chamber wenches if they do but think may see that without wood it is not possible to exercise any manner of human art or cunning."

China has paid absolutely no attention to the preservation of her forests; hardly a twig left in what was her great forest fields, while Japan, close by, has fifty-nine per cent. of her total area under forests, and the Government has reserved under its control a very large part of the whole. Compare the conditions of these two countries, side by side, and draw your own conclusions. While practically all other countries are effectually practicing forestry, none of them, I believe, save Sweden and Russia, foresaw the difficulties toward which they were drifting—at least, made any effort to provide against them until they found themselves importing lumber in great quantities.

One nation, Germany, paid out in a single year \$80,000,000, and still their timber reserves are being depleted at a rapid rate. Realizing into what condition she was drifting, she set at work to remedy the evil, and to-day is in the forefront in working out this great problem, and it will not be many years before she will be producing an annual crop equal to her consumption. This is most commendable, but it would have been much less expensive and more businesslike had she have exercised the same judgment and forethought in the matter our leading business men make use of in handling the problems affecting their interests to-day. As is usually true, those spending the most money in the development of an industry obtain the best net results. To illustrate, Germany and France are spending about \$11,000,000 a year and reaping \$30,000,000 net; while we, last year, spent \$1,400,000, receiving \$130,000.

Considering all of the above, coupled with the fact that from the viewpoint of the value of annual production, it stands as the fourth greatest industry in the United States, being exceeded only by, first, food and kindred products, the annual value of which is \$2,845,234,900; second, textiles, annual value \$2,147,441,418; third, iron and steel and their products, annual value \$2,176,739,726; lumber coming fourth, annual value \$1,223,730,336; which pays annually in wages about one hundred million dollars, providing an income and living for something like two million of our people. Can it be passed lightly by without bringing the censure of the generation that will live after us, upon our heads?

But need we say more of the important part forests play in the affairs of our country, or what bearing they have had and are having on the nations of the world? It seems to me we should determine, if we can, the life of our forests under existing condi-

tions and upon the course necessary to their perpetuation.

In January, 1903, I prepared a paper on the subject of stumpage, to be read at a convention of lumbermen. I spent a vast deal of time in gathering the data necessary to its preparation; I took into account only the white and Norway pine of the Lake States the yellow pine of the South, and the timber growing in the states of Oregon, Washington, and California, as they were the only woods entering in any large way into the lumber supply of this country, calculating that long before any of the woods in question had been exhausted, practically all other woods in our nation would have largely passed out of use.

My investigation led me to make a statement that the timber in the Lake States would not exceed sixty billion feet; that within ten years it would probably play no larger part in the lumber supply of this country than did poplar at that time. I see no reason to change that statement unless the effects following our recent panic, which are very depressing on the lumber industry, should continue longer than is now expected.

As to the life of the southern yellow pine, I gave it as my belief, that eighteen years would find it cutting no great figure in our lumber supply. I am more convinced of the correctness of this statement now than I was then. Adding the white pine, yellow pine, and Pacific coast products together, my estimate was that the life for all was forty-one years. I am not so sure as to the amount of timber on the Pacific coast, but I do not believe the total life of all will vary to exceed five years from the date indicated.

Some calculate that substitutes, such as cement, will likely curtail the demands for lumber; judging from the experience of other countries, it will not; even in England, where nearly all of the lumber used is imported, their lumber consumption per capita is increasing at the rate of five per cent. per annum. In France and this country it is increasing at the rate of ten per cent. per capita. But why speculate on our timber supply, a question of such great importance to this nation, when definite information can be had? It is unlike any of our other natural resources. It all stands above the ground and can be estimated with great accuracy. Men and money are the only means necessary for securing this valuable information. The former can be had by supplying the latter. Should a nation as rich as ours hesitate to furnish the means required for information of such great value?

My plan would be to take our timber areas, and, working them by counties, parishes, or townships, make a complete estimate, as if a purchase was to be made; where the timber was practically the same in several counties, townships, or parishes near each other, a careful estimate of one, and a reckoning of others on the same basis, would be sufficiently accurate for all purposes. This would

give us a correct basis to start with, and from which intelligent statements could be made in the future.

The owner of a given piece of property is controlled, as to retention or disposition, largely by the net results that may be obtained at different periods. Carrying charges, or the expense incident to holding a commodity or article of commerce, enter very largely into such calculations. Taxes constitute a large part of such charges, and have no little bearing on the subject under consideration. Instead of timber lands being favored in order to encourage their conservation, not only for the benefit of the owner, but for the use of generations yet unborn, they are not given an even chance with other properties.

The crop of the farmer is taxed when it is ready for the market, and no crop is taxed more than once. A crop of timber is taxed continuously and annually until disposed of. The farmer's crop matures yearly; the crop of the timber owner matures once in about a hundred years.

Let us illustrate: As the value of the timber is less in its earlier years than when matured, we will use fifty years as the average life, basing the value on the matured product. Rice, cotton, and sugar lands in some sections of the South, in close proximity to timber lands, are assessed at about the same prices as timber lands. The rice, cotton, and sugar lands net the owner at least \$7.50 an acre annually after paying taxes and all other expenses. In fifty years the owner would get \$375 off of each acre of his land, besides obtaining enough annually to pay his taxes; the land itself being worth \$50 per acre, making a total of \$425, plus the interest on the money made annually, while the timber owner could not get more than \$120 per acre in the gathering of his entire matured crop, after spending a goodly fortune in building a plant preparatory to its harvest. Again, the cut-over lands are taxed practically their full value, thereby making it burdensome to carry them, much less to spend anything on them for the purpose of reforestation.

The effect of such laws is shown in the state of Michigan, where over six million acres have reverted to the state. A like condition, to a lesser extent, exists in other states. I find the constitutions of several states permit them to exempt such properties from taxation; others permit them to classify; others to either exempt or classify.

And now we come to the vital point of the subject, namely: the conservation and perpetuation of this great resource. In dealing with this subject as it now presents itself to us, it become necessary to dwell on some features that directly and immediately affect the interests of the timber owners. Belonging to that class, we would refer to these features with some embarrassment, did we not feel it had been our purpose, in preparing these thoughts for your consideration, to treat them on broader and more patriotic lines than any exclusively selfish idea would

permit; besides, we believe the thoughts presented will appeal to you as eminently fair and correct, and will of themselves prevent your ascribing to us a selfish motive.

I want to give especial emphasis to the statement that conservation and perpetuation of our forests and unremunerative prices for lumber cannot travel the same road, for conservation means to handle, to treat, to take care of, and save in such manner as to retain the use or benefit of a given product as long as possible. Perpetuation of forests means to so exploit the forests as to make them continuous and perpetual, which can only be done by spending money continuously in planting, seeding, protecting, etc., while *low prices of any commodity means neglect and waste*. This cannot be more forcibly illustrated than by the conditions existing today, as applied to lumber; on account of the low prices now prevailing, the logs making low grade lumber, secured principally from that portion of the tree approaching the limbs, and constituting at least twenty per cent. of the forests, are left in the woods to rot or be burned, because the lumbermen would no more think of using the raw material out of which he could not obtain cost, than the farmer would harvest a crop of faulty corn out of which he could not obtain the cost of gathering.

This leaving of twenty per cent. of our logs in the woods—as applied to the yellow pine industry alone—if we market as much lumber this year as last, means that we will have wasted over three hundred thousand acres of forest land, and so, in order that the product of these low grade logs may take their place in the lumber supply of the world, and our timber saved or conserved, the manufacturer must at least have cost for his low grade lumber, which means a comparatively better price for the better grade; and this need not necessarily mean high priced lumber, but the price must be removed materially from the prices now prevailing, and such as we touch periodically, even in normally good times; for lumber is like every other product, controlled by supply and demand, and if we build mills with sufficient capacity to supply the demand of the country in times of extreme activity, such as we had in 1906 and the first two-thirds of 1907, we will have capacity beyond our requirements in normal times, and under such conditions down go the prices.

On account of such varying and unstable conditions, it will be found difficult, if not impossible, to get the timber owner to enter actively into the methods required for the perpetuation of the forests by spending even the minimum required, which I understand to be about fifty cents per thousand. While this does not seem a large amount, there are concerns making as much as two hundred fifty million feet of lumber per annum, and hence to these, the cost of this item would be \$125,000 per annum. If his or its competitor was pursuing the same practice, all would be

well; if not, he would, for the immediate present, be out that much more money than his competitor, and during dull periods, such as now, when prices were close to the cost line, even for the better grades of lumber, he would hardly feel disposed to contract for such an outlay.

The Government only owning about twenty-two per cent. of our forest area, cannot alone, to any great degree, effect what we are seeking in this conference, so far as forests are concerned. It might, however, accomplish the purpose in one of the following ways:

First. The Government could, by a contractual relation with the owners of the forests where lumbering operations are now being carried on (who constitute at least eighty per cent. of the timber holdings of the United States), provide that conservation and reforestation should be practiced under rules prescribed by the Forest Service, and assess the cost thereof against the timber lands proportionately. These rules should provide that the lumbering operations, so far as conservation and reforestation were concerned, should be conducted under governmental control; that no more timber should be cut than was necessary to supply the current demands, thus maintaining such uniformity of prices as would justify the operator to utilize every log the tree would produce; that only trees of a certain size should be cut; that seed trees, properly distributed, should be left; that the young growth should be protected from fires and other elements of destruction, and it would seem clear that the establishment of such a relationship would certainly accomplish this highly desired object.

Second. A plan might be worked out jointly between the owners of the timber lands, and the Government, by which conservation and reforestation would be practiced along such lines as the Government might lay down, as outlined above, and the timber owners be protected in the prices of all lands cut over and handled under the conditions prescribed.

Whatever plan is adopted must furnish an incentive, a substantial inducement to the timber owner, to forego a present gain for the public good, and in this matter it can only be accomplished by governmental co-operation. And what is done should be done quickly, for the time is fast approaching when our forests will be so nearly gone that it will be too late.

Will the Government avail itself of this golden opportunity to lend its aid to the conservation of this splendid natural resource, in order to supply the timber for future generations; be wise and patriotic enough to provide for the inevitable result that must occur before the middle of the twentieth century, and thereby perform the true function of all good governments in the promotion of the health, wealth, and prosperity of the people? Or, with climatic

changes following the destruction of our forests, shall manufacture die with them, and commerce fail as a natural result of agricultural and manufacturing decadence?

Disclaiming all partisan or political references, and speaking only of economic conditions as we find them, I do not think I should neglect to say that the present demoralizing conditions existing in our commercial and manufacturing life, and the consequent waste and loss incident thereto, and especially incident to the wasteful destruction of hundreds of thousands of acres of timber annually is, in my judgment, due largely to the pernicious effect of that class of legislation which, by its application, has placed an absolute prohibition on every form of agreement looking to conservation; has placed a ban upon all meetings and discussions having for their object the adoption of the most salutary measures for the preservation of this natural resource, and the instant and unfair denunciation of every meeting of the so-called "Lumber Trust," which does not and never did exist; has produced such a condition of mind among lumbermen, that they feel that they can no longer meet together for the general discussion of matters so vitally affecting their interests and the welfare of this nation, without subjecting themselves to the humiliation of a prosecution. This condition in the lumber business has led to the reduction of the wage scale of hundreds of thousands of men, affecting many millions of people; it has left twenty per cent. of the timber in the forest to waste; and unless we have relief, these evils will increase and others will follow in their wake.

Attempts at compulsory competition is our present commercial nightmare. Such competition is not healthy but disastrous, and serves only, in the end, to create the most pernicious monopoly by destroying all competition—it means the survival of the *strongest* and not the *"fittest."*

Is it not sufficient for all that our resources should be conserved and saved for all generations; is it right or just that a great industry should suffer, and generations to live hereafter be deprived of an adequate supply of lumber, in order that a prejudice be vindicated, and the consumer of to-day buy his lumber at less than cost?

And in this connection, it may be well to say that a reduction of our tariff on lumber would at once bring us into direct and disastrous competition with lumber from Canada, where stumpage is cheaper and wages lower, and where the consequent tendency toward wastefulness necessitates corresponding disregard on our part. Waste is loss, and adds nothing to consumption. We want greater consumption, but we should conserve and reproduce, not waste.

The part played by the United States Steel Corporation since its organization, in the maintenance of staple prices, while obtaining a profit and not improperly using its power, is a most substantial demonstration of the

salutary effect of concentrated control of any commodity in the interest of uniform prices and conservatism, without injury to the consumer or harm to any one.

The American people have common sense, are patriotic, and fair, and a full understanding of the real conditions confronting us will appeal to their good sense, and they will support any measure of true relief.

And now, Mr. President, before closing, I want to say again, aside from the soil itself, this is the most important natural resource at the command of the American people to-day. It has its most intensely practical side, but is not by any means devoid of its sentimental side, the absence of which from human breast, leaves one devoid of one of the most beautiful attributes of human kind. One that possesses this finer nature has said:

"A tree is one of nature's words, a word of peace to man;
A word that tells of central strength from whence all things began;
A word to preach tranquility to all our restless clan."

"Ah, bare must be the shadeless ways, and bleak the path must be,
Of him who, having open eyes, has never learned to see,
And so has never learned to love the beauty of a tree."

"Who loves a tree, he loves the life that springs in star and clod,
He loves the love that gilds the clouds, and greens the April sod;
He loves the Wide Beneficence; his soul takes hold on God."

I am happy in the thought of this conference for the purpose of discussing this and kindred subjects, and shall hope that we may not rest satisfied in the thought that there is plenty for our day and generation, for such a thought means selfishness; selfishness means littleness. Anything that is small is prescribed by a very limited circle; and I venture the statement that there is no place of comfort or happiness in the universe of God or the realm of man for such an individual.



HUNTLEY PROJECT, MONTANA

Hauling Sugar Beets to the Factory. Sugar Beets Are One of the Most Profitable Crops of an Irrigated Country

Read "Irrigation in the United States," by Frederick Haynes Newell, Director of the Reclamation Service. Price, \$2, postpaid to any address. Address "Forestry and Irrigation," Washington, D. C.

ORCHIDS

We are the largest Orchid Growers in the United States.

Our Illustrated and Descriptive Catalogue of Orchids is now ready and may be had on application.

Orchid Growers and Importers

LAGER & HURRELL
SUMMIT, N. J.

POWDER POINT SCHOOL, Duxbury, Mass.

Preparatory Course in
FORESTRY

Leading to Biltmore and College Course in the subject. It requires hard, earnest application, and develops appreciation of nature and powers of leadership.

(M. I. T.)

F. B. KNAPP, S. B.

Philippine Bureau of Forestry

WANTED—Two foresters with field experience. Minimum salary, \$1,600. Travel expenses allowed, also liberal leave privileges.

At least seven months' interesting field work per year.

For information concerning travel allowance to Manila, Civil Service rules, health conditions; in fact any information in regard to the Islands, apply to the Bureau of Insular Affairs, War Department, Washington, D. C.

POSITION WANTED.—ENGINEER, 37 years old, graduate of Cornell University, with four years' experience in hydraulic and irrigation engineering—also business experience—desires position as irrigation engineer. Competent to take charge of any ordinary irrigation project, or would consider place as assistant, if sufficiently attractive.

Address, Box 392, Ithaca, N. Y.

Text Books on Conservation]

If you are interested in any of the phases of conservation, read the list of publications carried in stock by FORESTRY AND IRRIGATION

STUDENTS

will find this list invaluable. Let us know what you want. We can fill your order. Address

Forestry and Irrigation

1417 G St., Washington, D. C.

PUMPS WATER

Day and Night Automatically

Low in first cost, easy to install, no expense to operate, any capacity desired for Country Homes, Farms, Dairies, Gardens, Irrigation, Town Plants, Railroad Tanks, etc.

RIFE HYDRAULIC RAMS

Raise water 30 feet for every foot of fall. Satisfaction Guaranteed. Over 7,000 in use. If there is a stream, spring or pond within a mile—

Write for Free Plans and Book.

Get Our Free Trial Offer.

Rife Engine Co.

2172 Trinity Bldg.
NEW YORK



Sent On Approval

TO RESPONSIBLE PEOPLE

Laughlin FOUNTAIN PEN

and

RED GEM

The Ink Pencil

Your Choice of

\$ **1.00**

These Two Popular Articles for only

Post-paid to any address

BY INSURED MAIL 50 EXTRA.

Illustrations are Exact Sizes

Every pen guaranteed full 14 Kt. Solid Gold—cut on right hand may be had in either our standard black opaque pattern, or Non-breakable Transparent, as desired, either in plain or engraved finish, as preferred.

You may try this pen a week, if you do not find it as represented, a better article than you can secure for THREE TIMES THIS SPECIAL PRICE in any other make, if not entirely satisfactory in every respect return it and we will send you \$1.10 for it.

Cut on LEFT is our famous and Popular Red Gem Ink Pencil, a complete leak proof triumph, may be carried in any position in pocket or shopping bag, writes at any angle at first touch. Platinum (spring) feed, Iridium point, polished vulcanized rubber case, terra cotta finish. Retail everywhere for \$2.50. Agents wanted. Write for terms. Write now "lest you forget." Address

Laughlin Mfg. Co.

476 Majestic Bldg.,
Detroit, Mich.



The Pompeian Co.



Importers of highest class Refined Pompeian Olive Oil, and manufacturers of Olive Oil Products. Proprietors of

OLIVKRIM

A pure Olive Oil hair invigorator. Not to be confused with tonics, quinine or other "cures." It contains all the health-giving, nourishing properties of pure Olive Oil—a hair food, not a combination of alcohol and drugs.

OLIVE OILS

Our Pompeian Extra No. 1 Lucca Oil is the finest product of Italian Olive Orchards. Analyzed and endorsed by Prof. H. E. Kalusowski, Dean of the George Washington College of Pharmacy, Washington, D. C.

THE POMPEIAN CO.

702 Fifth Street

Washington, D. C.

WE SELL FARMS

BOOTH'S FARM AGENCY
Cor. Eighth and G Sts. N. W.

We are specialists on Farms and Country Homes in Maryland, Virginia and the District of Columbia.

Our Farm Bulletins contain hundreds of the Best Estates, Fruit Farms, Dairy and Stock Farms, Poultry Farms, Truck and Garden Lands that are on the market at this time near Greater Washington, D. C.

We offer absolutely the cheapest and best homes for the least money in the United States.

Write or call for our Md. or Va. Bulletins, free for the asking, and be convinced. Now is the time to buy Farms and Country Real Estate in and around the National Capital.

BOOTH'S FARM AGENCY

Ouray Building
Cor. Eighth and G Streets Northwest
WASHINGTON, D. C.

1,000 BARGAIN FARMS

YALE FOREST SCHOOL

NEW HAVEN, CONNECTICUT

The course of study in the YALE FOREST SCHOOL covers a period of two years. Graduates of collegiate institutions of high standing are admitted as candidates for the degree of Master of Forestry.

The Summer School of Forestry is conducted at MILFORD, PIKE COUNTY, PENNA.

FOR FURTHER INFORMATION ADDRESS

HENRY S. GRAVES, Director

New Haven, Connecticut

FORESTRY AND IRRIGATION

WOODS AND WATERS ; SOILS AND ORES .

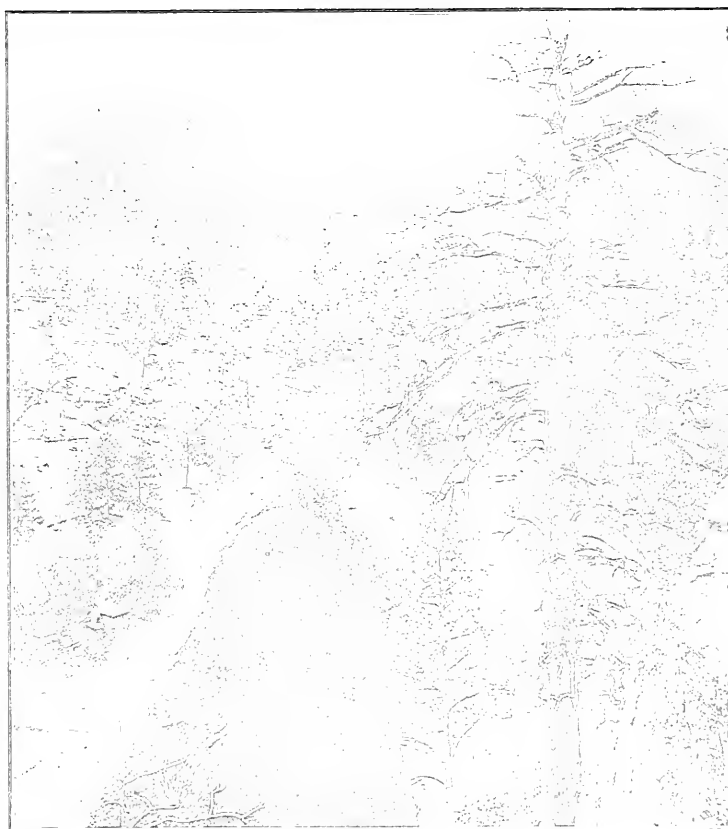

IN THE GILA (S) NATIONAL FOREST



The Greenhouse

This range of greenhouses was erected for the Connecticut Agricultural College at Storrs, Conn., and will be used solely for the practical instruction of the students.

It is of our Sectional Iron Frame Construction, which, because of its great durability, its consequent freedom from repairs, makes a lasting investment.

It is of this same construction that we build our various types of ornamental greenhouses for private grounds. The wide scope of possibilities of this construction make it the ideal one for all other kinds of glass enclosures, such as conservatories, orchard houses, swimming pools, orangeries, and so on.

In our book, "Greenhouses As We Build Them," just published, we devote 72 pages to showing in an interesting, fully illustrated way just such information as you want to know before building. It even goes so far as to devote a few pages to the question of choosing a site for the greenhouse, and gives some half dozen or so examples of the usual and somewhat unusual placing.

This book we want to send you.

LORD AND BURNHAM CO.

Greenhouse Designers and Builders

1133 Broadway

NEW YORK

THESE ARE THE WORST DAYS FOR FLEAS AND LICE! Haedrich's White Cedar Animal Bedding

is the only preventative being used in many of the most sanitary kennels and poultry farms in America. It is carefully made expressly for bedding dogs and animals and nesting pigeons, poultry and caged birds. Lasts longer, is cleaner, and in every way superior to straw, hay and other flea, lice and disease breeding materials. Positively drives out fleas, lice, and all vermin from dogs, fowls, kennels, pigeon and poultry houses. Deodorizes and sweetly scents all enclosures. Prevents "doggy" smell and disease. Improves the coat and gives it the delightful White Cedar Odor. The best for puppies. It is antiseptic, disinfectant and absorbent, absolutely harmless, and perfectly sanitary. Sold only from maker to user in pressed bales of 100 to 300 lbs. each, at 5 cents per lb., f. o. b. our shipping point, upon receipt of price. Shipped by freight, except when ordered by express. Special prices in quantity to large kennels and poultry farms for regular supply. WRITE FOR FREE SAMPLE AND BOOKLET.

A special trial bale of 50 lbs., \$2.75 or a 25-lb. bag, \$1.50

WRITE FOR FREE SAMPLE AND BOOKLET

OUR WOVEN CEDAR PICKET FENCING will save you time and expense. Easily put up. Requires no paint. Lasts for years. Made 3, 4, and 5 feet high. Put up in rolls of 50, 75, and 100 feet. Write for factory prices. We sell direct to you. Millions of feet in use.

DEPT. B

E. M. HAEDRICH (Inventor and Sole Manufacturer)

Mainger & Merchant Bldg., Philadelphia, Pa.

F. E. MEIER

CONSULTING FORESTER

1 Broadway, New York

Timber Estimates. Working Plans. Forest Appraisalment. Tree Planting. Tree Surgery

Advice on profitable handling of woodlots, forest tracts, beautifying country estimates. Work supervised
17 years experience in the United States

PUMPS WATER

Day and Night Automatically

Low in first cost, easy to install, no expense to operate, any capacity desired for Country Homes, Farms, Dairies, Gardens, Irrigation, Town Plants, Railroad Tanks, etc.

RIFE HYDRAULIC RAMS



Raise water 50 feet for every foot of fall. Satisfaction guaranteed. Over 7,000 in use. If there is a stream, spring or pond within a mile—

Write for Free Plans and Book.
Get Our Free Trial Offer.

Rife Engine Co.

2172 Trinity Bldg.
NEW YORK

Real Estate, Farms, etc.

The following advertisements of Real Estate, Farm Lands, Timber Lands, etc., are the announcements of reliable firms and agencies. The Advertising Manager of **FORESTRY AND IRRIGATION** has investigated the announcements in all cases, and feels safe in recommending the advertisers to the readers of the magazine. The services of this department are free to all members of The American Forestry Association and subscribers to this magazine; advice in regard to the purchase of Real Estate advertised in our pages is gladly given, and our readers are urged to make the fullest use of our services in all matters pertaining to the purchase of advertised Real Estate, of whatever character, no matter where it is located.

FARMS AND HOMES IN VIRGINIA

Free from frost 183 days

Plowing season 315 days

Growing season 225 days

WHY NOT MOVE TO VIRGINIA?

where you can buy good level land with buildings, timber, fruit, water, etc., at \$8 per Acre and up! Best climate, health, markets, transportation facilities, churches, schools, active business life.

Our Illustrated Real Estate Herald, with map, tells all about it. Write to-day for free copy.

PLYLE & COMPANY (Inc.), PETERSBURG, VIRGINIA

VIRGINIA INVESTMENTS

J. NELSON GARNETT, Real Estate and Loan Agent, CULPEPER, VA.

High-class Loans and Mortgages our Specialty

Choicest homes and investments of every description in Northern or Piedmont Virginia, the garden spot of the world, and the booming Southland, within sixty miles of Washington.

Write for property list and other information.

Virginia Country Homes

Grain, fruit, dairy, and blue-grass farms for sale in the best portions of the state. Also timber lands.

Climate, social conditions, and nearness to markets, makes this a splendid country in which to locate.

Write for free illustrated register. We solicit correspondence.

H. W. Hilleary & Co.

Charlottesville, Virginia

Winter Home in Florida

Orange-grove with 630 bearing trees, Orange and Grapefruit, 210 acres of land, handsome residence, all modern improvements, splendid outbuildings, all in good repair. First-class packing house. Close to depot. Netted \$3,000 last year. Fishing, hunting, and boating unexcelled. Price, \$15,000. Ten per cent. guaranteed if bought at once. Description, terms, etc., on request.

M. B. Nicol

Manassas, Virginia

A MAGNIFICENT VIRGINIA ESTATE

(Only 87 minutes by rail from Washington.) Contains 1,023 acres, about 500 acres in blue-grass, 200 acres in timothy and other grasses, 200 acres in grain and crops, and about 100 acres in good timber.

160 cattle were fattened on this place last year, and sold for over \$12,000; besides this, there was sold from the place over \$1,200 worth of hay. The corn crop averaged sixty bushels to the acre. A small field of alfalfa was cut three times, and could have been cut another time. There are nearly 500 thrifty bearing fruit trees. The soil is a dark rich loam, well drained. Splendid new residence of eleven large rooms, bath and pantry, all modern improvements, hot and cold water, steam heat and gas. Besides this mansion, there is another 6-room house, three tenant-houses, two sets of farm buildings, five stock barns for hay, etc.

It is not more than one-fourth of a mile from a prominent station on the Southern Railroad, and very convenient to Washington and the northern cities. Acre for acre, this farm is second to no farm in Virginia.

For price and particulars, address

JOHN A. NICOL
Manassas, Virginia

The Peninsula of Virginia

The most favored section of the state. Good lands, fine climate, healthy; good crops and good markets; fine schools, best society. Farmers making big money growing irish potatoes, corn, hay, berries, etc. One man cleared \$100 per acre from potato crop this season, and now has second crop, corn, growing on same land. Hundreds of Western and Northern people already here, and hundreds more coming. It's the best country in the world. Send 5c (stamps) for descriptive literature.

PIEDMONT & TIDEWATER LAND CO., Inc.

Box 79, Williamsburg, Virginia

Summer Homes

Situated at the junction of the C. & O. and the Southern Railway, we have many elegant summer homes for sale in the healthy section of the Piedmont Valley. The home of President Madison has attracted many Northern people of note to settle in this section.

Write us for particulars.

SHACKLEFORD & WARREN

ORANGE, VA.

Great Opportunity

A celebrated estate containing 2,200 acres, located four miles above Yorktown, Va., on York River, is for sale.

Splendid place for Club House, and hunting and fishing preserves. Address,

OLD DOMINION LAND CO.

Newport News, Va.

Timber Lands and Farms

42,116 acres in.....	S. Carolina
8,300 acres in.....	S. Carolina
60,000 acres in.....	West Virginia
48,000 acres in.....	Western N. Carolina
660 acres in.....	N. Carolina
25,880 acres in.....	Georgia
2,000,000 acres in.....	Florida
35,000 acres in.....	Mississippi
30,000 acres in.....	S. Carolina

For Sale by

H. C. HOGGARD & CO.

NORFOLK, VA.

HOMES IN NORTHERN VIRGINIA

Two hundred twenty acre farm, 70 miles from Washington, D. C., in the best fruit growing section of Virginia, one mile from railway station on the Southern Railroad.

Eight hundred apple-trees on the farm. Thirty acres in corn, balance in blue-grass, well watered with running water. Good 8-room house and all necessary outbuildings. Moderate price, easy terms. Apply to

BROWNING BROS.

Real Estate Agents

Falls Church, Va.

BEAUTIFUL VIRGINIA HOMES ON SALT WATER

Handsome 26-room house, two baths. Modern conveniences throughout. Twenty-seven acres, located on point, with salt water on three sides.

SUPERB FISHING AND SHOOTING

Bass, trout, shad, etc., and oysters and crabs abound in the bay. Ducks, geese, swans, and on the uplands quail, woodcock and other game.

Fresh water supplied by two artesian wells. Excellent bathhouses, etc. Churches and schools in sight, and daily mails. For complete description, prices, etc., address,

J. W. ALLISON, JR.

Fredericksburg, Virginia

FOR SALE

One of the finest farms in Northern Virginia, containing 314 acres of blue-grass land. The improvements are as follows: Fine stone house of 14 rooms, large bank barn, double corn-house, ice-house, hen-house, meat-house, 5-room tenant-house, orchard of all kinds of fruit. Every rod of fence is in perfect condition. This is an ideal stock farm for the money. Price, \$20,000. Terms, \$5,000 cash, balance in one, two, three, and four years. This farm is situated near Bluemont, Va.

No. 2.—283 acres, house of 9 rooms; barn for 10 cows and 16 horses, new dairy; a nice spring of water; a living stream through the farm; 80 acres in timber; smooth land and a good quality; in nice neighborhood; four miles from railroad station. Price, \$18 per acre; terms favorable.

Send for our list and we will gladly mail it to you. Address

J. W. BAUCKMAN & SON

Real Estate Brokers

Herndon, Va.

One hundred sixty-five acres, 9-room house, six 6-room houses, four cattle barns, calf barn, machinery, and every convenience for dairy. Improvements cost \$180,000. Price, \$35,000

ANDERSON REAL ESTATE & LAW CO.

Richmond, Va.

Summer homes, hunting preserves, and farms, in Old Virginia. Write,

W. E. LAWSON
Hunston, Va.

Southern Real Estate, especially Virginia. Catalogue free.

GEO. E. CRAWFORD CO
Richmond, Va.

A. O. MAUCK, NORFOLK, VA.

TIMBER LANDS

Virginia, West Virginia, North and South Carolina, Kentucky, Tennessee, Florida, and Georgia.

Timberlands in the South

We offer timber tracts in Virginia, North and South Carolina, and other sections of the South.

First-class Southern Pine and Hardwoods

The tracts are covered with virgin growths of Southern Yellow Pine and Hardwoods, the timber alone being worth the price asked for the lands. Land is all good farming land after it is cleared. All are within a reasonable distance of Charleston. Particulars on request.

O. H. PERRY TIE & LUMBER CO.
Norfolk, Virginia

VIRGINIA

Farms, City Property
Timber and Mineral

LANDS
A Specialty

*Large Tracts for
Colonization*

International Farm Agency

(INCORPORATED)

900 Main Street Lynchburg, Va.

MARYLAND

S. P. SPEERS

Timber and Coal Lands **Southern Pine and Oak**

Nine thousand acres Hemlock in S. E. West Virginia. Directly on railroad, easily accessible by tram road.

OFFICE, 206 LAW BUILDING, BALTIMORE, MD.

Desirable Farms

Near Baltimore, Md., and Washington, D. C.

AUBREY BIRD @ CO.

1105-7 Calvert Bldg., Baltimore, Md.

A Great Bargain

A fine farm of 200 acres in Charles County, Md., 100 acres clear, balance in timber; has a 6-room dwelling, one tenant-house, and all necessary outbuildings; a good orchard; nice meadow that will pasture 25 head of cattle; must be sold at once; owner will take \$2,000; easy terms. (Call for my list of Maryland farms.)

H. BADENHOOP

111 N. Charles St., Baltimore, Md.

WE SELL FARMS

BOOTH'S FARM AGENCY

Cor. Eighth and G Sts. N. W.

We are specialists on Farms and Country Homes in Maryland, Virginia, and the District of Columbia.

Our Farm Bulletins contain hundreds of the best Estates, Fruit Farms, Dairy and Stock Farms, Poultry Farms, Truck and Garden Lands that are on the market at this time near Greater Washington, D. C.

We offer absolutely the cheapest and best homes for the least money in the United States.

Write or call for our Md. or Va. Bulletins, free for the asking, and be convinced. Now is the time to buy Farms and Country Real Estate in and around the National Capital.

BOOTH'S FARM AGENCY

Ouray Building

Cor. Eighth and G Streets Northwest

WASHINGTON, D. C.

1,000 BARGAIN FARMS

FARMS near the National Capital, suitable for all classes, and purposes, reasonable in price, advantage of best market in the country. Healthy and delightful climate.

Write us for particulars.

NATIONAL FARM AGENCY

1407 N. Y. Ave. N. W.

Washington, D. C.

REAL ESTATE Bought, Exchanged and Sold

No matter where located, will buy or sell your business or Real Estate for CASH. Real Estate loans at lowest rates.

CLARENCE E. TUCKER

Metropolitan Bank Building

Washington, D. C.

**TIMBER
FARMS
RANCHES**

Large Tracts For Sale Cheap in Va., No. Car., Tenn., Texas, Calif., Canada. Also farms in N. Y., N. J., Me., Kan., Mo., Ia., Ill., Ind. All Kinds N. Y. City Real Estate

UNITED REALTY CO.
150 Nassau Street NEW YORK

COUNTRY PROPERTY

Timber lands, coal lands, farms, country seats, hotels, factory properties, water powers, game preserves, water fronts on lakes, rivers and salt water, etc., etc.

Archibald C. Foss

39 East 42nd St., N. Y.

Branch Offices:

South Norwalk, Conn.

Millerton, N. Y.

AGRICULTURAL LANDS IN MEXICO

Four dollars an acre. Mexican land now under cultivation is the most productive in the world. Ground will grow plants yielding as high as \$200 per acre with little care or attention. There are 40,000 Americans now living in Mexico, and 800 million dollars of American money invested here. Our free book, "The Mexican West Coast," tells all.

W. F. DAVENPORT

171 Broadway

New York, N. Y.

FOR SALE — FARMS, COUNTRY ESTATES, BUILDING SITES; ALL SECTIONS; WRITE YOUR WANTS. W. F. DAVENPORT 171 BROADWAY, NEW YORK, N. Y.

Philippine Bureau of Forestry

WANTED—Two foresters with field experience. Minimum salary, \$1,600. Travel expenses allowed, also liberal leave privileges.

At least seven months' interesting field work per year.

For information concerning travel allowance to Manila, Civil Service rules, health conditions; in fact any information in regard to the Islands, apply to the Bureau of Insular Affairs, War Department, Washington, D. C.

TIMBER LANDS

We are owners and operators and have options on several hundred of the most desirable TIMBER and MILLING propositions in the United States and Canada, secured previously at HARD TIME prices. We guarantee to sell you desirable timber lands or stumpage at minimum prices on easy terms. Write us your wants.

J. F. WEATHERS & CO.

1326 Broadway

NEW YORK

Sent On Approval

TO RESPONSIBLE PEOPLE

Laughlin FOUNTAIN PEN

and

RED GEM

The Ink Pencil

Your Choice of

\$ 1.00

These Two Popular Articles for only

Post-paid to any address

By INSUREO MAIL 5c EXTRA.

Illustrations are Exact Size

Every pen guaranteed full 14 Kt. Solid Gold—cut on right hand may be had in either our standard black opaque pattern, or Non-breakable Transparent, as desired, either in plain or engraved finish, as preferred.

You may try this pen a week, if you do not find it as represented, a better article than you can secure for THREE TIMES THIS SPECIAL PRICE in any other make, if not entirely satisfactory in every respect return it and we will send you \$1.10 for it.

CUT ON LEFT is our famous and Popular RED GEM Ink Pencil, a complete leak proof triumph, may be carried in any position in pocket or shopping bag, writes at any angle at first touch. Platinium (spring) feed, Iridium point, polished vulcanized rubber case, terra cotta finish. Retail everywhere for \$2.50. Agents wanted. Write for terms. Write now "lest you forget." Address

Laughlin Mfg. Co.

416 Majestic Bldg., Detroit, Mich.

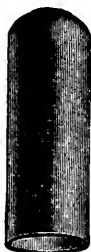

Read "Irrigation in the United States," by Frederick Haynes Newell, Director of the Reclamation Service. Price, \$2, postpaid to any address. Address "Forestry and Irrigation," Washington, D. C.

What is "Soil Culture"?

What is The New System of "Scientific Agriculture"?

Nothing more than judgment and common sense shown in handling the soils of our western tracts so that the rainfall may be held for immediate absorption by the root fibres of growing crops. It's a system that every farmer—East, West, North or South—can profitably follow. It is the very essence of practical agriculture. It is a distinct revelation to Eastern and Central State farmers who have been depending on 24 to 30 inches of rainfall yearly. They wonder how our Colorado "Scientific" farmers can gather such remarkable crops on lands once called "half deserts."

Happy Prospects. Denver is rubbing its eyes, stirring itself in wonder, gazing in admiration at the great tracts bursting into green and growing crops of alfalfa, corn, wheat and fruits, etc. (*Explanation of cuts below.*) White-faced farm houses, broad-gabled barns, bowing maples, pink-blossomed orchards, dairy farms, wheat and corn fields greet gladdened eyes from every angle. Campbell's "Soil Culture" is making wealth for Colorado farmer and manufacturer, for merchant and implement maker, for mall order concern and local merchant.

"Young Man! Go West," said Horace Greeley. Within a decade or two there will be little "West" left. Hundreds of thousands have heeded the call of the early fifties. Thousands now are heeding our call

"Hurry to Colorado" Now

Buy with a few hundred dollars one of the cheap tracts now so generously offered. Start to be independent.

Start Small. You can start on a small acreage—40 to 80—at prices running from \$3.50 to \$16 per acre. We don't insist on all cash. A fifth or smaller part is sufficient if you are a settler.

Location. The Bijou Ranch is only 42 miles from Colorado Springs, 65 miles from Denver, 5 miles from two easily reached railroads—the Union Pacific and Rock Island. A new branch of the Rock Island has recently been surveyed thro' the property.

Crops. Alfalfa roots and grows rapidly, sucking up through its great "root pipes" the "sheet water" which underlies the Bijou Ranch. 35,000 acres overlay this great supply of moisture that comes as near as 6 feet to the surface. This is not a lake or open cave, but is the under-soaking of the melting snows from the "earth ridge" formed by the Eastern slopes of the Rockies. This water is easily, in most places, reached by the average hand pump. Corn, wheat, sugar-beets, oats, speltz, rye, potatoes, barley, fruits of all kinds, vegetables, grow under this system of Soil Culture.

New Book, "The New Colorado" Free

Here's a fast passing opportunity. Here are cheap lands, fertile soil, railroads, possibilities for great increase in land values, healthful climate, schools, etc. Embrace this chance. Do it now. Get in line with hundreds of others. Send for our new book—free, yet valuable—

"The New Colorado." It's a question-answer.

Shows ten-inch map giving the location of lands, distance from great business centers, markets, shipping points, schools, churches, etc. It tells how much money you'll need to get started; how to figure profits; describes the glorious climate with its sunshiny days and life-renewing nights, etc. etc.

Write for a copy today to Dept. 17

The Farmers Land and
Loan Co.,
145 LaSalle St.,
Chicago, Ill.



THE

American Forestry Association

Officers for 1908

President

HON. JAMES WILSON, Secretary of Agriculture

Vice-presidents-at-large

DR. EDWARD EVERETT HALE	GEO. T. OLIVER
N. J. BACHELDER	DR. B. E. FERNOW
GEO. FOSTER PEABODY	GEO. C. PARDEE
RUTHERFORD P. HAYES	ALBERT SHAW
W. W. FINLEY	J. T. ROTHROCK

CHARLES R. VAN HISE

Advisory Board Selected by Affiliated Organizations

H. H. WHELESS	GEORGE E. STONE	W. K. KNOX
JAMES INNES	ALLEN CHAMBERLAIN	A. L. HAYES
C. H. KEYS	D. E. KLINE	FREDERICK S. UNDERHILL
ROBERT C. LIPPINCOTT	E. F. SAWYER	ROBERT L. LIPPINCOTT
GEORGE F. CRAIG	F. E. WEYERHAEUSER	S. B. ANDERSON
C. A. SMITH	KENT SHEPPARD	ROBERT A. JOHNSON

Members of Board Designated as Vice-Presidents of Association

N. W. McLEOD	LEWIS DILL	J. T. WYLIE
WILLIAM IRVINE	EDWIN A. START	D. E. KLINE
GEORGE H. HAMPTON	SAMUEL B. VROOMAN	B. W. PORTER

Secretary, THOMAS ELMER WILL, Washington, D. C.

Assistant Secretary, FRANK GLOVER HEATON, Washington, D. C.

Treasurer, OTTO LUEBKERT, Washington, D. C.

Directors

JAMES WILSON	WILLIAM L. HALL	W. J. McGEE
GEO. P. WHITTLESEY	GEORGE K. SMITH	PHILIP W. AYRES
JAMES H. CUTLER	WILLIAM S. HARVEY	ROBERT GARRETT
HENRY S. GRAVES	H. A. PRESSEY	LIGON JOHNSON
F. H. NEWELL	ASBURY F. LEVER	FILIBERT ROTH

Application for Membership

To THOMAS ELMER WILL

Secretary American Forestry Association

1417 G Street N. W., Washington, D. C.

Dear Sir: I hereby signify my desire to become a member of the American Forestry Association. Two Dollars (\$2.00) for annual dues are enclosed herewith.

Very truly yours,

Name _____

P. O. Address _____

The American Forestry Association

President—HON. JAMES WILSON

Secretary of Agriculture

The American Forestry Association was organized in 1882, and incorporated in January, 1897. It now has over 8,000 members, residents of every State in the Union, Canada, and foreign countries. From its origin it has been the tireless friend of the forests.

The object of the Association is to promote the preservation, by wise use, and the extension of the forests of the United States; its means are agitation and education; it seeks to encourage the application of forestry by private owners to forest holdings, large or small; and it favors, especially, the establishment and multiplication of National and State forests, to be administered in the highest interests of all.

The Association seeks as members all who sympathize with its object and methods, and who believe that our natural resources constitute a common heritage, to be used without abusing and administered for the common good. Seeking to conserve our supplies of wood and water, the Association appeals especially to wood-producers and users, including owners of wood lands, lumbermen, foresters, railroad men, and engineers; and to those dependent upon equable stream flow, as manufacturers, irrigators, employers of water power, and those engaged in internal commerce.

The Association meets annually in Washington. It publishes, monthly, FORESTRY AND IRRIGATION, the magazine of authority in its special field. The list of contributors to this publication includes practically all persons prominent in forest work in the United States, making it alone worth the cost of Annual Membership in the Association.

The dues, covering a subscription to FORESTRY AND IRRIGATION, are as follows: Annual—For Annual Members, \$2; for Sustaining Members, \$25; Total, with exemption from all other payments—for Life Members, \$100; for Patrons, \$1,000.

THOMAS ELMER WILL, Secretary.

Address: 1417 G Street N. W., Washington, D. C.



*One of Mr. Archbold's Trees
After Our Treatment*

DAVEY'S

School of Practical Forestry

Eastern Office
TARRYTOWN, N. Y.

Pruning Spraying Planting
Tree Surgery

☞ Everything in the Care of Trees. ☞ Originators of Tree Surgery and perfecters of its methods. ☞ Experts, not Experimenters. ☞ Nearly half a century of experience makes our work perfect.

"Their need of attention, which you plainly indicated, was a revelation to me, and I feel that your work was thoroughly and efficiently done, and will serve not only to beautify but perpetuate the lives of the trees."
J. S. D. ARCHBOLD

BUYERS

OF

**TIMBER LANDS,
PULP-WOOD LANDS,
WATER POWERS, ETC.**

are invited to make known their wants with fullest particulars

RALPH HERBERT WAGGONER
309 BROADWAY
NEW YORK

I seek to bring BUYER and OWNER together without intermediaries.

I always have in my hands desirable properties at favorable prices.

OWNERS

OF

**TIMBER LANDS,
PULP-WOOD LANDS,
WATER POWERS, ETC.**

Who seek CASH BUYERS are invited to send fullest description, prices, terms, etc.

RALPH HERBERT WAGGONER
309 BROADWAY
NEW YORK

I always have enquiries for good properties at favorable prices.

I seek to bring OWNER and BUYER together without intermediaries.

FORESTRY AND IRRIGATION

FRANK GLOVER HEATON, *Editor*

CONTENTS FOR AUGUST, 1908

VIEW IN THE NEW CLEVELAND NATIONAL FOREST.....	<i>Frontispiece</i>
A PLEA FOR THE NATIONALIZATION OF OUR NATURAL RESOURCES By Henry Riesenbergl.....	419
THE BRANDING OF THE FORESTS— <i>Poem</i> —By "The Poet Lariat".....	425
RAILROAD FORESTRY WORK.....	426
NATIONAL FORESTS REDISTRICTED.....	428
MEMORIAL TO EX-PRESIDENT CLEVELAND.....	432
FORESTRY AT THE BIENNIAL—By Lydia Adams-Williams.....	435
THE NEW COMMISSION AT WORK.....	438
TREES AND THEIR NAMES.....	443
EDITORIAL	
A Remarkable Speech.....	445
The Murderous Guard.....	445
Uniforms for Forest Officers.....	446
Costly Steam Yachts.....	446
The Service Itself.....	447
Changing Our Title.....	448
Our Membership Campaign.....	449
A Word of Credit.....	449
Death of ex-President Cleveland.....	450
Secretary Will's Chautauqua Lectures.....	450
THE FOREST FIRE FIGHTERS— <i>Poem</i> —By Arthur Chapman.....	452
NEWS AND NOTES	
Grand Canyon National Forest Made a Game Preserve.....	453
Arizona's Mountain Forests.....	453
Soldiers Extinguish Fire in Arizona National Forest.....	454
Insure Timber Supply for Montana's Mines.....	454
Production of Precious Stones in the United States.....	455
Body of Slain Forester Recovered.....	455
Declare for Government Regulation.....	456
THE VALUE OF NATURAL SCENERY—By J. Horace MacFarland.....	457
CONSERVATION OF POWER RESOURCES—By H. St. Clair Putnam.....	459
THE WATER-SUPPLY PROBLEM.....	465

FORESTRY AND IRRIGATION is the official organ of the American Forestry Association. Price, \$2.00 per year, including Annual Membership in the Association. Entered at the Post-office at Washington, D. C., as second-class mail matter

Published Monthly at
1417 G STREET N. W. WASHINGTON, D. C.

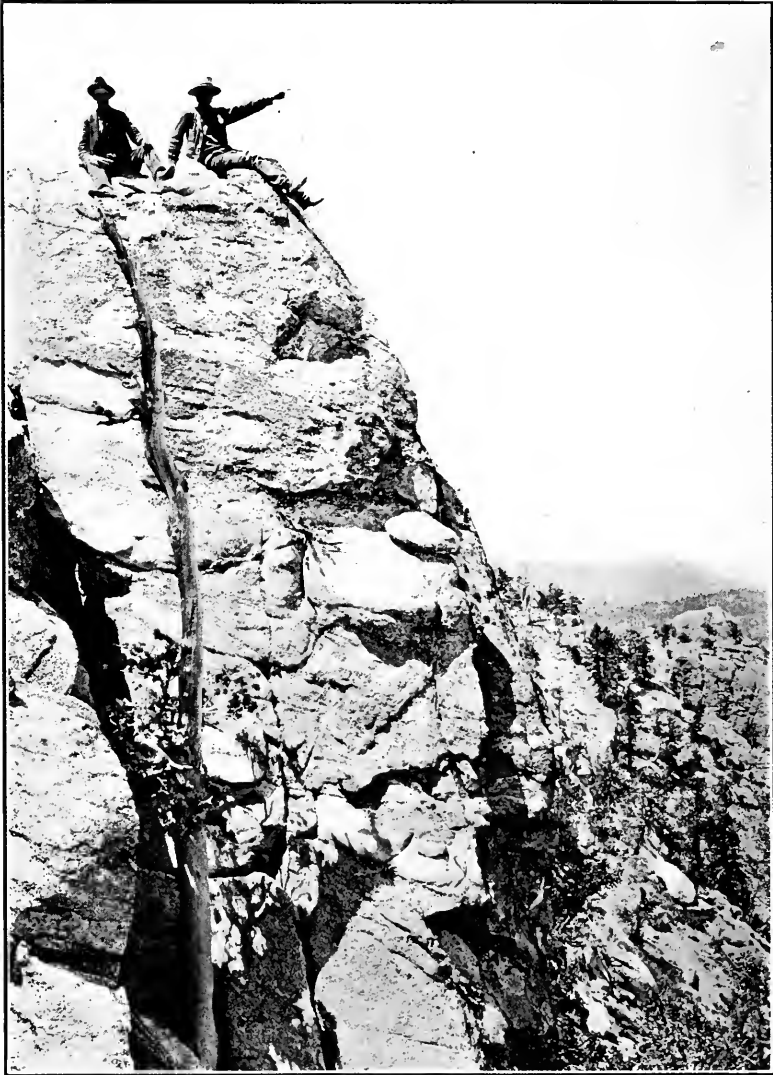

IN THE NEW CLEVELAND NATIONAL FOREST

Taggart Rock, the Summit of Tocquitz Peak, Old San Jacinto, N. F.



FORESTRY AND IRRIGATION

Vol. XIV

AUGUST, 1908

No. 8

A PLEA FOR NATIONALIZATION OF OUR NATURAL RESOURCES

By HENRY RIESENBERG, Indianapolis, Ind.

THERE is growing apace in the world to-day a spirit of cooperation. Men are growing out of the old theory of individualism, which finds expression in such sentiments as "Every man for himself and the devil take the hindmost;" or "What's mine is my own to do with as I please."

At the recent Conference of Governors, held at the White House, it was graphically pointed out that the policy of individualism in regard to our natural resources has brought us almost to the brink of actual exhaustion; every student of the subject is at one in declaring that unless radical action be taken in regard to our forests, minerals, and waterways, the day will soon dawn which will see this country treeless, mineral-less, and waterless. Woe be unto us when that day arrives.

Admitting the hypothesis then—and who will gainsay it?—that our natural resources urgently require conservation the question naturally arises, what steps ought we—the present possessors of these resources—to take in order

best to conserve them, not only for ourselves, but for our children and our children's children?

Quite recently the writer, in a discussion of this topic, took occasion to point out that the several states of the Union and the United States itself, are the owners of natural resources of vast value. These consist of farm lands, arid lands, swamp lands, timber lands, mineral lands, waters, and waterways. As their complete utilization is fundamentally beneficial to the country as a whole, the writer urged the merger of these resources by the states with those of the United States, in order that a comprehensive, adequate, and uniform policy could be adopted for the reforestation of cut-over and burnt-over timber lands; for forestation to protect the headwaters of our streams; for the irrigation of arid lands; reclamation of swamp lands; improvement for purposes of irrigation of all worthy water-courses; for the creation and sale of electrical energy, and for the establishment of model coal, iron, and other

mineral mines, so that an object lesson to private enterprise might be furnished with a view of abrogating the present fearfully wasteful methods of production.

We know from experience that attempts at development on the part of the states as separate entities must be local, incomprehensive, and inadequate; these efforts must absolutely cease at the state boundary lines, although a full realization of results may be attained only by obliterating political divisions. It is quite clear, then, that our natural resources should be developed and conserved in a national way, and national development is possible only by a national agency whose policy it would be to realize for all the people, irrespective of locality, section, or state, the maximum of benefits at a minimum of expense.

Whilst most of us are believers in the theory of States' rights, and but few subscribe to the maxim that a strongly centralized government would be more beneficial for us yet all of us do believe in union, which, carried to its logical conclusion, is cooperation; and in considering a question so vital as the very life of the Nation what grander principle should be invoked than the one which expresses itself in the term cooperation.

President Roosevelt, in his address to the Governors at the White House, pointed out that even "Washington clearly saw that the perpetuity of the states could only be secured by union, and that the only feasible basis of union was an economic one; in other words, that it must be based on the development and use of their natural resources."

The President also pointed out that "whilst our natural resources are not gone, they have been so injured by neglect and by the division of responsibility and utter lack of system in dealing with them, that there is less navigation on our waterways now than there was fifty years ago." And, finally, "In the past we have admitted the right of the individual to injure the future of the Republic for his own profit. The

time has come for a change. As a people, we have the right and the duty to protect ourselves and our children against the wasteful development of our natural resources, whether that waste is caused by the actual destruction of such resources or by making them impossible of development hereafter."

The Resolutions Committee of the White House Conference also stated in its report, made to the Convention, that "We declare the conviction that in the use of the natural resources our independent states are interdependent and bound together by ties of mutual benefits, responsibilities and duties."

The Inland Waterways Commission, in its preliminary report, voiced its conviction regarding the matter thus: "Means should be devised and applied for coordinating forestry, farming, mining, and related industries with the use of streams for commerce and for other purpose." Also, "questions concerning the control of water-power and waterways should be treated as a general question of national extent, while local or special projects should be considered as parts of a comprehensive policy of waterway control in the interests of all the people."

James J. Hill concluded his admirable address at the Governors' Conference by saying: "If this movement is to make headway * * * it needs the cooperation of all the influences, the help of every voice, the commendation of nation and state, and such cooperation as that out of which this nation was born, and by which it was reared to worthy manhood."

Andrew Carnegie, in his paper, likens "this Nation to a large family receiving a rich patrimony from thrifty parents deceased intestate * * * Now the first duty of such a family is to take stock of its patrimony; the next, to manage the assets in such manner that none shall be wasted, that all be put to the greatest good of the living and their descendants."

Prof. Emory R. Johnson, in his "Navigation Resources of American Waterways," says "There is only one



WORK IN A NATIONAL FOREST

Cutting Area, Showing Cordwood Cut from Tops and Limbs. Gila (S) National Forest

power whose authority is as wide as our country, and that is the Federal Government. In the future, but small place in the development and control of water-power and waterways will be given either to the state or to private corporations."

F. H. Newell Chief Engineer of the United States Reclamation Service, states, "The matter of the development of the West is not a state question. We must conserve forests in Wyoming to benefit the arid plains of Idaho. In western Kansas there is the greatest interest in irrigation, and although there are no forests, the rivers that come into Kansas, as the Arkansas, depend for the continuity of their flow on the proper treatment of the woodlands on the mountains in the central part of Colorado," and so forth, "ad infinitum."

The foregoing is sufficient to prove to the unbiased mind that a national agency is absolutely essential to carry on the work of conservation in this

country. If we agree on this, the question naturally arises, what national agency is better qualified to take up and carry on the work than the National Government?

In view of this, then, I advocate that all national resources owned by the states as such should be merged with those owned by the United States; that the National Congress create a new department to be called the Department of National Resources and Public Works, whose head shall be a cabinet minister with the title of Director of National Resources and Public Works; that in this department shall be merged the Forestry Bureau, Mines and Minerals Bureau, Reclamation Service, Navigation Bureau, Geological Survey, etc. This department shall control the development of all natural resources, such as lands, forests, minerals, water-power, and the improvement of waterways; shall also direct such work as irrigation, forestation, reclamation of swamp



FURROW IRRIGATION

Ranchers at Work in the Pecos Valley, near Roswell, N. M.

lands and arid lands, clarification of streams and other similar enterprises. It shall also be empowered to purchase from corporations and private individuals lands for such purposes as above stated, and in addition shall have the power to invoke the law of eminent domain. It may also sell or lease lands, sell timber, sell or lease water-power, sell or lease electrical energy, sell coal and other minerals.

In order that all the states may cooperate fully, justly and equitably in such a plan I recommend that each and every state list its natural resources, the United States doing likewise; that the President of the United States appoint an Appraisal Commission, this commission to appraise at its true value all such resources, and, after such appraisal, the several states and the Federal Government as well, accept such appraisal, and that they severally be given credit for the amounts allotted to each by the commission.

I further recommend that the Department of National Resources and Public Works be administered by a commission, whose head shall be a Cabinet Minister appointed by the President of the United States, this commission to include the Governors of the states and territories of the Union, each of whom shall act as Commissioner from his state to serve during his term of office "ex officio," and without compensation other than the payment of expenses, for the administration of the above-named resources. It is also recommended that majority rule shall apply with this commission, the executive of which having the power only to carry out the mandates of the majority of said commission.

As large sums of money will be needed to carry forward the work of this department, the Congress shall, upon the recommendation of the commission, cause to be issued bonds against these natural resources, pro-

ceeds from such sales to be set aside for the exclusive use of this department.

As, in the course of time, a vast income will inure to this department from the sale and lease of lands, sale of timber, sale of coal and other minerals, sale and lease of water-power, and sale and lease of electrical energy, provision should be made not only to pay the interest on the bonds, but also, in the course of time, to retire them. In addition, I would recommend that all moneys derived from the above-stated sources, over and above that required for the interest and retirement of the bond issues and the maintenance of the several divisions of the department, be distributed annually or biennially to the several states and the Federal Government, paying to each a proper and pro rata share according to the appraised value of the natural resources turned in by each to the general plan.

The above, in brief, is my plan, and much as we may cavil at the radical recommendations made, which differ from our present plan of operation, there is no doubt but what, sooner or later, there will be a general clamor for its

adoption. In no other way can we obtain a true business administration and our natural resources should be regarded, exploited, improved, and conserved on business lines solely. Heretofore, whenever improvements have been made, such as forestation, reforestation, reclamation of swamp lands and arid lands, improvement of waterways and harbors, the work has been carried on in a haphazard, disjointed and inconsistent manner, at an enormous expense to the people of this country, an expense disproportionate to the benefits derived; my plan provides for a unification of efforts, and, what is vastly more important, the expense will be paid for by the improvements made; for instance, streams can be so improved that millions of horse-power of electrical energy will be developed, which should be marketed in a businesslike way, as any other commodity is sold. Timber can be sold annually, reclaimed lands can be sold, grazing lands can be leased, coal can be sold, likewise other minerals, etc. Thus, our resources will be conserved without adding one dollar to the national expense account.

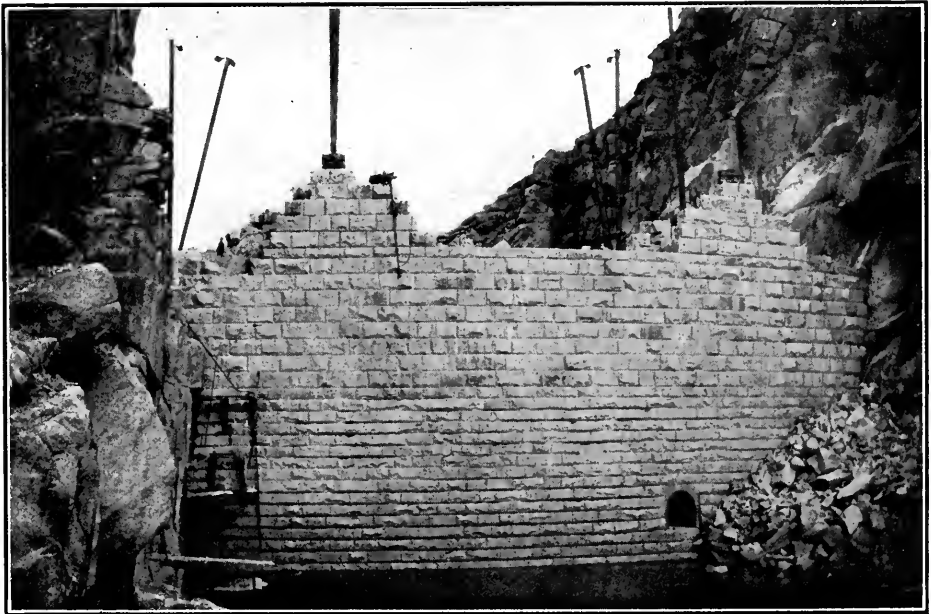

IRRIGATION IN THE NORTHWEST
Upstream Face of the Great "Pathfinder" Dam, in Wyoming



USE OF A NATIONAL FOREST
Cattle Grazing in Shepard Canyon, Gila (S) N. F.

It is almost certain, judging the future by the past, that the states cannot, and individuals and corporations will not, adopt a uniform plan for the conservation of our natural resources, a plan that will work the greatest good to the greatest number. The states cannot be expected to do the essential part of this work; it involves absolutely uniform national activity.

To those of my readers who may question the necessity for such an elaborate scheme as my plan involves, for the conservation of our national resources, I would say, there are many people in this country of ours to whom the question of States' rights is a bugaboo; who fear that the centralization of power in the hands of the Federal Government will tend to undermine our system of government. Whilst, personally, I have no fear that our government will ever decay or be disrupted by any system of control we are likely to adopt for its operation, yet, there are

untold thousands who affect to believe that the placing of additional power in the hands of our Federal Government will tend to its destruction; so, my plan, whilst advocating a national agency, does not involve an absolute surrender by the states of their rights to Federal control; it simply provides a scheme for national cooperation—national partnership, if you will.

A feature that should be borne in mind in behalf of my plan is its absolute non-partisan control; under this plan, the entire matter is taken out of and lifted above mere politics, and we may expect a business administration of our resources such as we positively could not get in any other way.

The country's need is great and pressing; the remedy, therefore, must be adequate even if radical and advanced. To sum it all up, do the American people believe in actual union of the states for the benefit of all, or is union merely a platitude?

THE BRANDING OF THE FORESTS

By the "POET LARIAT"

(On July 1 many of the National Forests were given new names)

COME and listen to my story, all ye Forest Service men,
Once the Forester was sitting in his spacious, lofty den,
And he wiped his sweating forehead as he grabbed his stubby pen,
And he swore by all things sacred that he'd name 'em, there and then.

So he punched a handy button and the messengers they came,
Like a bunch of baseball rooters, when the umpire hollers 'Game!'
And he sent this word to each one of his tried and trusty lads:
"This day we'll have a christening; come and make believe you're dads."

"Make 'em short, and make 'em simple," was the edict of the Chief.
"Chop 'em down to small dimensions, like a goat's tail—short and brief."
"No two deckers—no sky scrapers. One word only, nothing more."
And the workers murmured gently, whispered low—and softly swore.

So they gathered in that aerie where the Chieftain sits in state,
And they puzzled, and they foozled, and each scratched his aching pate.
And they cut 'em and they slashed 'em, and they changed those names about.
Oh, they placed them endways—sideways, and they turned them inside out.

They hunted through the legends of the heroes—young and old.
They delved into the records of explorers brave and bold.
They searched for names of Indians, and of patriots so great,
And they studied o'er the doings of the big men of the state.

So, after weeks of planning, and of scheming deep and dark,
That went back almost into the days of Noah's Ark.
They got those forests branded (sure they burned 'em good and deep).
And the christening was over—then the boys began to weep.

Quoth a "Super" from the Northwest, "'Tis indeed a bitter pill,
When these people on my forest ask me, 'Who was Bonneville?'"
To be forced to own up, honest, "You can search me—don't ask me,"
Mebbe he's from o'er the ocean, from the wilds of gay "Paree."

Oh, they took "Eklaka," "Long Pine," "Slim Buttes," and "Short Pine" too,
And they bunched them up with "Cave Hills," then they named the whole thing "Sioux."
And "Tillamook," and "Umpqua," (names that almost broke your jaw).
Why, they've hitched 'em up together under sibillant "Suislaw."

From the far Blue Mountain region came a query hushed and low:
"Which of the Whitmans is it? For I'm just obliged to know."
Here's a man who wants a permit for to pasture Baalam's ass,
But he swears he's 'feered to graze him upon Whitman's "Leaves of Grass."

Then from the peaks of Idaho there came a fearful yell.
You used to call it "Koo-ten-ai," but now 'tis "Pen d'Oreille."
"Hold on a bit—perhaps you're wrong," a ranger whispered slyly,
"'Tis Irish, sure—a good old name; they call it plain 'O'Reille'."

And so it goes all o'er the West, and even with the ladies,
This christening job has mixed things up and just raised merry Hades.
So take your time, and learn the list, or else you'll lose your standing.
And live to cuss the fatal day that saw this forest branding.

RAILROAD FORESTRY WORK

How the Pennsylvania System Is Planning for a Permanent Timber Supply of Its Own

IN CONTINUANCE of its plans to provide for some of its future requirements in timber and cross-ties, the Pennsylvania Railroad Company has recently completed its spring forestry planting for this year. Including the permanent planting and the stocking of the nursery, there was handled this spring a total of 625,000 young trees. These make, up to the present time, 2,425,000 trees which have been set out by the Pennsylvania Railroad since it undertook tree-planting upon a scientific and comprehensive scale—this constituting the largest forestry plan undertaken as yet by any corporation.

About 460,000 of the seedlings put out this year were conifers, such as Scotch pine, white pine, and Norway spruce, and 168,000 were hardwoods, principally red oak. Nearly 75,000 of the total were grown or handled in the company nursery at Hollidaysburg. The seed sown comprised 250 bushels of acorns and nuts, 370 pounds of other hardwood seeds, and seventy-five pounds of conifer seeds. Three hundred thousand seedlings were permanently planted in land belonging to the company.

Economically to prosecute tree-planting operations on so large a scale necessitates at present the importation of part of the plant material, because European foresters, on account of the degree of perfection to which they have brought their work, and the cheapness of labor, are able to supply certain forest trees for less than they can be purchased at in America. This applies not only to native European species, such as Scotch pine and European larch, but also to our own trees, particularly white pine and Douglas fir.

The Pennsylvania Railroad this spring imported 209,000 seedlings, made up of 150,000 Scotch pine, 25,000 European larch, 25,000 Norway spruce, 5,000 white pine, and 1,000 each of Sequoia, Japanese larch, scarlet oak and Douglas fir. Some of these are not large enough to be planted in their permanent sites, and have been set out in transplant rows in the new forest nursery established this year by the company at Morrisville, Pa., just across the Delaware River from Trenton. Twelve acres have been carefully laid out there as seed beds, transplant beds, and nursery plots. Already the last-named contains 1,500,000 red-oak seedlings, which have come up from acorns put into the ground about April 1. In addition to the oaks, there are, in the nursery plots, thrifty seedlings growing up from five bushels of black walnut, ten bushels of chestnut, and 100 pounds of hickory nuts, which were sowed there. The seed beds have had sowed in them twenty-six pounds of Scotch pine, fourteen pounds of loblolly pine, five pounds of red pine, twenty pounds of European larch, 250 pounds of black locust, and smaller quantities of other seed, such as Norway spruce, yellow poplar, hardy catalpa, and basswood. Three hundred fifteen thousand little trees are in the transplant rows, where they will receive careful attention until large enough to be planted out in their final site.

The few trees mentioned above, which are not primarily suitable for timber production, are part of the stock in the nursery being grown for purposes of landscaping. The company has this year begun the propagation of ornamental trees and plants for beautifying its property, and intends to develop a large amount of shrubbery and hedges for the



WORK IN A NATIONAL FOREST
Lumbering Operations under Forest Service Rules—Young Timber Left Standing

protection and ornamentation of the station grounds and rights of way. This work will be continued until all station grounds and unoccupied spaces on the right of way are parked, that they may afford as much pleasure as possible to the public. Besides reforesting old farmland and other open areas as in the past, the field planting this year has restocked certain areas which were logged during 1907, and has underplanted certain old locust plantations which needed interspersed trees to stimulate their growth in height and to regulate their form development.

In addition, it is believed that the conservative lumbering and the forest

planting, which the company is conducting on its woodlots and farmlands, which are not now needed for other purposes, will serve as an object-lesson for farmers, and provide an incentive to intelligent forest development on the part of the public generally.

It is expected by the Pennsylvania Railroad Company that in case no substitute for the wooden tie is developed during the next thirty-five or forty years, the company will have available a portion of the enormous supply of timber needed for cross-ties, which, at the present time, are becoming exceedingly expensive.



NATIONAL FORESTS REDISTRICTED

PRESIDENT ROOSEVELT has signed executive orders making important changes in the boundaries of practically all of the National Forests in the States of California and Washington. This is another step in the comprehensive plan of redistricting the National Forests in all of the western states.

No addition in forest area is involved in the redistricting plan. The object of the work is to equalize the area of administrative units and to arrange their boundaries in such a manner as to promote the most practical and efficient administration of the forests. It will enable officers of the Forest Service to give prompt attention to all forest business and further the interests and add to the convenience of stockmen, lumbermen, miners, and other users or settlers in the National Forests. The California National Forests which will be affected by this rearrangement are as follows:

The San Gabriel and San Bernardino National Forests will be combined in a new forest to be known as the Angeles. Supervisor R. H. Charlton, who has been in charge of the San Gabriel and San Bernardino Forests will be in charge of this new Forest, with headquarters at Los Angeles, as at present. The Forest is located in San Bernardino, Los Angeles, and Riverside Counties, California, and has an area of 1,360,021 acres.

California is the name given to what was formerly the Stony Creek National Forest, along with a part of the Trinity National Forest, approximately in T. twenty-six, N., R. eleven W., M. D. M. Supervisor Ernest Britten, who has been in charge of the Stony Creek National Forest will be in charge of this Forest, with headquarters at Willows, Cal. The new California Forest is located in Trinity, Tehama, Men-

docino, Glenn, Lake, and Colusa Counties, and has an area of 969,809 acres.

The new Inyo National Forest will include the old Inyo and Sierra (E) National Forests with the White Mountains addition to the Inyo National Forest, beginning approximately on the south side of T. thirty, S., R. thirty-six, E., M. D. M., and extending about twelve miles north of the California and Nevada state lines in approximately T. one, N., R. twenty-five, E., M. D. M. Supervisor A. H. Hogue, who has been in charge of the Inyo and Sierra (E) National Forests will be in charge of this Forest, with headquarters at Bishop. This Forest is located in Mono and Inyo Counties, California, and in Esmeralda County, Nevada, and has an area of 1,501,980 acres.

The Klamath National Forest has been combined with the Goose Neck Addition on the east side, a small part of the Trinity National Forest on the north, and part of the Shasta National Forest on the west, and will continue to be known as the Klamath National Forest. Supervisor R. L. P. Bigelow will continue in charge of this Forest with headquarters at Yreka. This Forest has an area of 2,079,680 acres located in Del Norte, Siskiyou, Humboldt, and Trinity Counties.

Lassen is the name given to the new Forest consisting of the Plumas, Diamond Mountains, and Shasta embracing 1,229,076 acres. It is located in Lassen, Shasta, Tehama, and Butte Counties, and will be under the administration of Acting Supervisor A. H. Kling, with headquarters at Red Bluff.

The new Modoc National Forest is what has been known as the Modoc and Warner Mountains and will embrace 1,165,536 acres. This Forest will continue under the administration of Supervisor C. E. Rachford, with headquarters at Alturas.

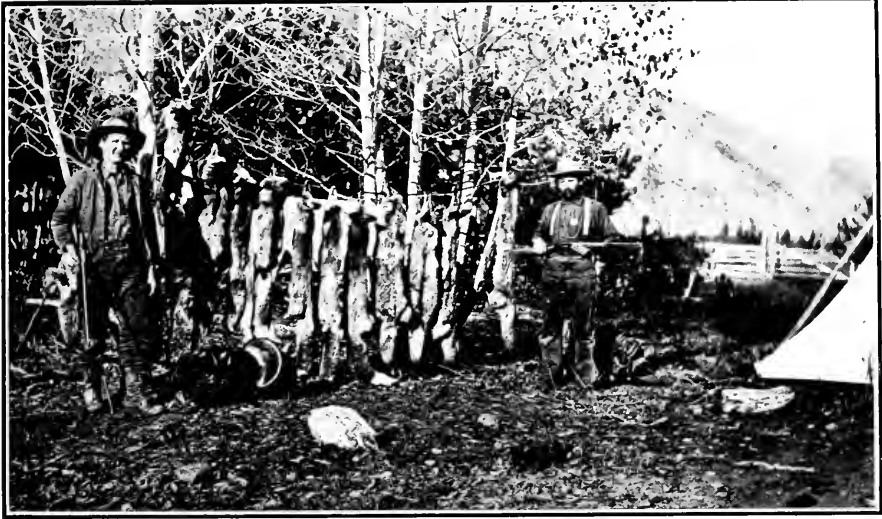

WORK IN A NATIONAL FOREST
 Predatory Wild Animals Killed by Guards and Rangers

A new National Forest, to be known as the Mono, will contain 656,640 acres, and will consist of portions of the Tahoe, Stanislaus, Sierra, and Inyo Forests. It is located in Alpine and Mono Counties. This Forest will be under the administration of Acting Supervisor J. C. Wells, with headquarters at Gardnerville, Nev.

Monterey is the name given to what was formerly the Pinnacles and San Benito National Forests, embracing 514,477 acres. It is located in Monterey, San Benito, and Fresno Counties. This Forest is under the administration of Supervisor N. O. Torstenson, with headquarters at Salinas.

The Plumas National Forest will consist of the Plumas, Diamond Mountain, and a portion of the Tahoe, embracing 1,333,280 acres. It is located in Lassen, Plumas, and Butte Counties, and continues under the administration of L. A. Barrett, with headquarters at Quincy.

The Santa Barbara National Forest, with a small part of the San Gabriel in the northwest corner, and a small part of the San Luis Obispo in the southern part, will remain the Santa Barbara. Supervisor Willis M. Slosson continues in charge, with headquarters at Santa

Barbara. Its area is 1,962,200 acres, located in Santa Barbara, Ventura, and Los Angeles Counties.

The new Cleveland National Forest includes what was the San Jacinto and Trabuco Canyon, and embraces 1,904,826 acres. It is located in Orange, San Diego, and Riverside Counties, and will be under the administration of Supervisor H. A. E. Marshall, with headquarters at San Diego.

The San Luis Obispo National Forest will hereafter be known as the San Luis National Forest. Supervisor E. S. Mainwaring continues in charge with headquarters located at San Luis Obispo. It is located in San Luis Obispo County and has an area of 259,100 acres.

The Sequoia National Forest will consist of the Sierra (S) and will have an area of 3,014,400 acres. It will be administered by Acting Supervisor W. C. Burton, with headquarters at Hot Springs. This Forest is located in Fresno, Tulare, Kern, and Inyo Counties.

The Shasta National Forest and a small part of the Klamath on the west side will continue to be known as the Shasta National Forest. Acting Supervisor H. B. Rider will be in charge of

this Forest, with headquarters at Sisson, Cal., as at present. The area of this Forest is 1,089,280 acres, located in Shasta and Trinity Counties.

The name of the Sierra National Forest, with new additions on west side, beginning, approximately, T. five, S., R. twenty, E., M. D. M., and running in a general southeasterly direction to T. twelve, S., R. twenty-four, E., M. D. M., will not be changed. Supervisor C. H. Shinn will continue in charge of this Forest, with headquarters located at Northfork. This Forest is located in Fresno, Madera, Mariposa, and Tulare Counties, and has an area of 1,911,840 acres.

The Stanislaus National Forest, with a small part of the Sierra (N) in the northwest part, will continue to be known as the Stanislaus. Acting Supervisor R. W. Ayers will be in charge of this Forest, with headquarters located at Sonora. The area of the Stanislaus is 1,114,380 acres, located in Calaveras, Alpine, Tuolumne, and Mariposa Counties.

The Tahoe National Forest, with a portion of the Stanislaus, will continue to be known as the Tahoe National Forest. Supervisor Madison B. Elliot will be in charge of this Forest, with headquarters located at Nevada City. The area of the Tahoe is 1,652,960 acres, located in Sierra, Yuba, Nevada, Placer, Eldorado, Amador, and Alpine Counties.

The name Trinity will be retained for the new Forest which was formerly Trinity National Forest, with a small part of the Shasta in the southwest corner. Supervisor F. H. Hafley will be in charge of this Forest, with headquarters located at Weaverville. The Trinity is located in Humboldt Trinity, Shasta, and Tehama Counties, and has an area of 1,718,400 acres.

The Washington National Forests re-districted are as follows:

The Chelan National Forest will have an area of 2,048,640 acres and will consist of that portion of the Washington National Forest formerly known as the Washington (East). It is located in Chelan and Okanogan Counties. The

Forest will continue to be administered by Supervisor George W. Milham, with headquarters at Chelan, Wash.

Approximately 946,880 acres, comprising the southern portion of the Rainier Forest, will form the new Columbia National Forest. It is located in Lewis, Cowlitz Klickitat, Skamania, and Yakima Counties. The Forest is to be administered by Acting Supervisor Thos. P. McKenzie, with headquarters at Portland, Oreg. Mr. McKenzie is promoted to this position from Deputy Supervisor of Wenaha Forest.

No change is made in the boundaries of the Colville Forest, which has an approximate area of 869,520 acres, located in Okanogan and Ferry Counties. It will also continue to be administered by Supervisor W. W. Cryder, with headquarters at Republic, Wash.

The Olympic Forest also remains without change and has an approximate area of 1,594,560 acres and is located in Clallam, Chehalis and Mason Counties, under the administration of Supervisor Fred Hansen, with headquarters at Hoodspert, Wash.

The Rainier Forest includes the northern part of the old Forest of this name and a small part of the Washington (W), and will have approximately 1,676,160 acres. It is located in Pierce, Lewis, Skamania, Kittitas, and Yakima Counties. This Forest will continue to be administered by Supervisor G. F. Allen, with headquarters at Orting, Wash.

Snoqualmie is the appropriate name which has been given the southwest portion of what was formerly known as the Washington (West), with an area of approximately 1,004,166 acres. It is located in Snohomish and King Counties, and will be administered by Supervisor Burt P. Kirkland, with headquarters at Seattle, Wash.

The Washington Forest will have an area of 1,493,400 acres and will include the northern portion of what was formerly called the Washington (West). It is located in Whatcom, Skagit, and Snohomish Counties. This Forest is to be administered by Supervisor Charles

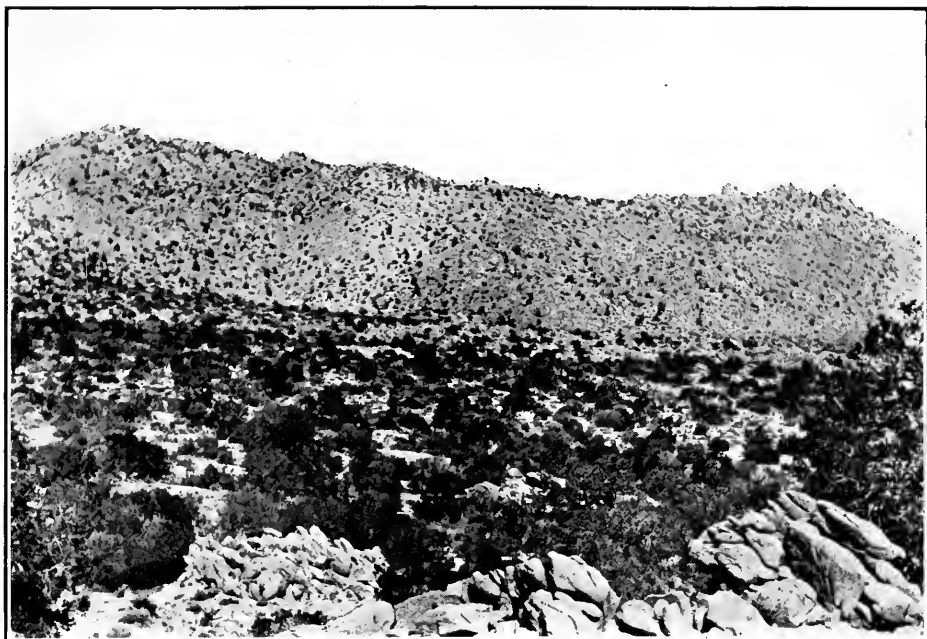

SCENE IN THE NEW CLEVELAND NATIONAL FOREST
Pinon and Juniper on Pinon Flat, at Edge of Colorado Desert

H. Flory, with headquarters at Bellingham, Wash.

The Wenaha Forest remains without change. It contains 813,342 acres, and is located in the States of Washington and Oregon. This Forest will continue to be administered by Supervisor J. M. Schmitz, with headquarters at Walla Walla, Wash.

The Forest to be known as the Wenatchee Forest includes the southeastern part of the former Washington Forest and has an approximate area of 1,378,569 acres. It is located in Chelan and

Kittitas Counties, and will be administered by Supervisor A. H. Sylvester, with headquarters at Leavenworth, Wash.

The Forest Service desires to reduce the area of the average administrative units to approximately 1,000,000 acres. This was not possible in all cases, as is shown by the fact that under the plan of redistricting there will be 144 Supervisors in the United States, who will administer more than 167,000,000 acres of National Forests.



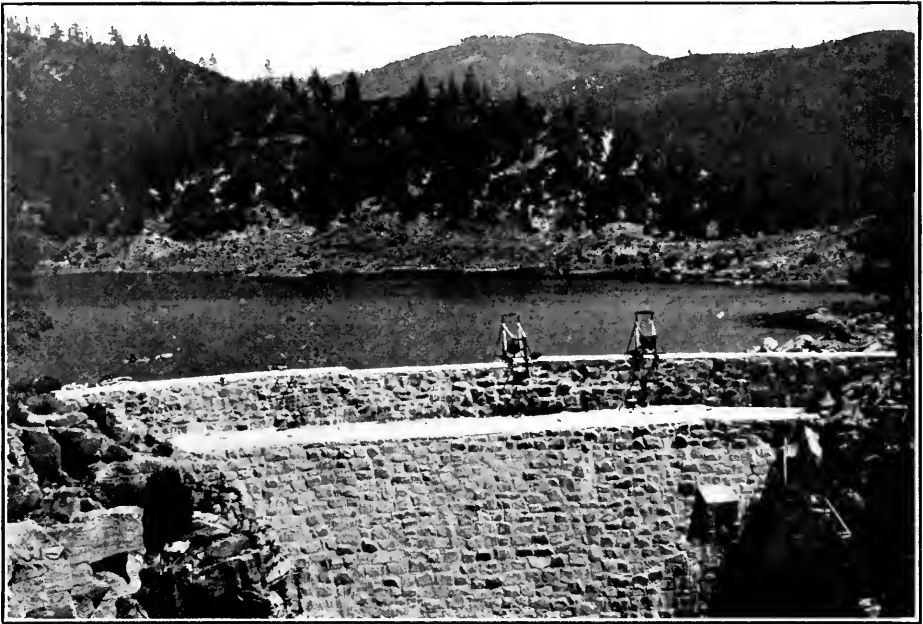

SCENE IN THE NEW CLEVELAND NATIONAL FOREST
Hemeh Reservoir Dam. Altitude, 4,500 Feet

MEMORIAL TO EX-PRESIDENT CLEVELAND

PRESIDENT ROOSEVELT, last month signed an executive order by which the San Jacinto National Forest, in southern California, has been renamed the "Cleveland National Forest," in honor of the President who established it. This Forest is at the same time consolidated with the Trabuco Canyon National Forest.

The President made public the following letter, which he sent to Mrs. Cleveland:

"My Dear Mrs. Cleveland: It has recently been my privilege to sign a proclamation changing the name of the San Jacinto National Forest to the Cleveland National Forest. May I express to you the very great pleasure it gave me to take that action—a pleasure min-

gled with a keen sense of the loss to our country and to our citizens in the death of President Cleveland.

"On February 22, 1897, President Cleveland signed the proclamation creating the San Jacinto Forest Reserve, in southern California. The date, February 22, was no mere accident, since the signature of the proclamation was timed to coincide with the birthday of our first President.

"President Cleveland was one of the first to recognize the need of forest preservation, and the creation of the San Jacinto and other forest reserves, with a total area of 25,686,320 acres, was one of the results of his foresight in this direction.

"Throughout his life he took great interest in conserving the natural re-



SCENE IN THE NEW CLEVELAND NATIONAL FOREST
Seed-collecting Camp in the Strawberry Valley

sources of the nation, and I particularly regretted his inability to attend the meeting of governors in May, because the meeting was in part the fruit of the seed he had sown years before.

"The name of Grover Cleveland will always be prominently identified with the movement to protect the forests of the United States, and it seems to me eminently fitting that one of the forests which he created should bear his name throughout all time.

"Sincerely yours,

"THEODORE ROOSEVELT."

The San Jacinto National Forest, together with twelve others, was created by President Cleveland on February 22, 1897. The recommendation of Hon. David R. Francis, Secretary of the Interior under President Cleveland, reads as follows:

"I respectfully suggest that the 165th anniversary (February 22, 1897), of

the birth of the Father of Our Country could be no more appropriately commemorated than by the promulgation by yourself of proclamations establishing these grand forest reservations."

Eleven of these "reserves," as they then were called, were opposed in the West, and the proclamation creating them was suspended. But investigation showed their necessity and the proclamation was in due time confirmed.

When created the San Jacinto National Forest embraced 737 280 acres. It has, however, been enlarged since and now contains 1,904,826 acres. It is located in Orange, San Diego, and Riverside Counties. The Supervisor in charge is H. A. E. Marshall, whose headquarters are at San Diego.

The Forest policy of the Government was only just forming ten years ago. In 1896, the National Academy of Sciences, at the request of the Government, appointed a National Forest Com-



SCENE IN THE NEW CLEVELAND NATIONAL FOREST
Knocking Seed out of Pine Cones, in the Strawberry Valley

mission to investigate and report upon the inauguration of a rational forest policy for the forested lands of the United States. Mr. Gifford Pinchot, now Forester for the Government, was a member of that Commission, appointed for his well-known familiarity with forest problems, gained by study in this country and abroad. After the Commission had formulated a policy, Government experts from the German Empire and British India were consulted, who made suggestions as to details of organization, and, after several months spent in the Forests, set the seal of their approval upon the general scheme.

But there was a great deal for the public to learn about the true meaning of forestry. At first the Forests were called "reserves," and indeed for some years under a policy of restricted use, and in the absence of technical foresters in charge, resulted largely in lock-

ing up the natural resources. Mr. Pinchot, who took charge of the forestry work of the Government in 1898, worked steadily for the application of the principle of preserving the forests by wise use, and at length his efforts were crowned by success, when the "reserves," now better known as National Forests, were transferred to the Department of Agriculture in 1905.

Mr. Pinchot then found his hands free for the first time to open the Forests to the use of the public. As a result, the cost of administering the National Forests is now balanced by the sale of products, while at the same time, the condition of the Forests, as to timber, range, and stream flow, is steadily improving. The local needs of residents are met and the Forests are made to yield their harvest of wood, grass, and water without depletion. Development has replaced spoliation.

FORESTRY AT THE BIENNIAL

By MRS. LYDIA ADAMS-WILLIAMS

THE ninth biennial convention of the General Federation of Women's Clubs, held at Boston, Mass., from June 22 to June 30, inclusive, was the most enjoyable and the most successful meeting yet held.

Boston's homes, hotels, and thoroughfares were thronged with prosperous-looking, self-possessed and reliant women, wearing the blue badge for which Boston hospitality will long be memorable, and who represented the foremost thought and progress in philanthropic, social, and economic work for the betterment of humanity. The roster shows an attendance of over 1,500 delegates and alternates from every state in the Union, while the visiting club women bring the list up to over 5,000 members who took part in the meetings. The membership of the General Federation of Women's Clubs includes over 800,000 active workers.

Through the efforts of Mrs. B. S. Peterson, of Chicago, chairman of the Forestry Committee of the General Federation of Women's Clubs, forestry was given an important place in the deliberations of the convention. One entire evening was given to the subject; this was followed by a round table and conference which occupied all of the next afternoon.

Interest in forestry and forestry work accomplished formed the theme most frequently heard during Biennial week in the reports of state presidents of clubs, chairmen of committees, and others.

A report sent by Miss Myra Dock, of the Pennsylvania State Forestry Association, was received with enthusiasm. The report was accompanied by an exhibit of growing spruce and pine trees, variously aged, from two to six years, grown at the Mt. Alta nursery.

An earnest worker is Mrs. Wm. A. Johnston, of Topeka, Kans., a director of the General Federation of Women's Clubs, and who organized the first forestry club in the State of Kansas, May, 1903, five years ago.

Topeka is very proud of the work done by this club in transforming a triangle of land adjacent to the best part of the city, which had been used as a dumping ground for tin cans and other rubbish, into an attractive park. A benefit district was formed, the ground was purchased, redeemed of its unsightly features, and turned over to the park commission. The people of the district are willingly taxed for its maintenance.

Another director of the General Federation of Women's Clubs, Mrs. Edward Johnson, of 91 Prospect Street, Providence, R. I., who takes charge of forestry matters which come before the board of directors, is enthusiastic regarding the growing sentiment for forestry and the good results which she predicts will be speedily accomplished.

Among the strong, philanthropic, unselfish workers for our friends, the trees, is Mrs. Lovell White, of California, who came all the way from San Francisco, with a large delegation. Mrs. White is widely known for her unceasing efforts to save the Calaveras Grove of Big Trees in California, which are the oldest living things on the face of the earth, and which are in danger of extinction through private greed. Mrs. White has just been appointed chairman of the State Forestry Committee for California. With Mrs. H. T. French, of Moscow, Idaho, who is vice-president for that state, Mrs. White enjoys the distinction of being honorary vice-president for California of the National Irrigation Congress, which meets at Al-

buquerque, N. Mex., in September. An interesting incident in connection with the visit of the battle-ship fleet to San Francisco was related by Mrs. Lovell White. The civic committee of the Outdoor Art League of the California Club, Mrs. White, chairman, planted sixteen trees named for the sixteen battle-ships anchored in San Francisco Bay. Later these trees will be dedicated to the American navy.

A significant feature of Biennial week was the reports of presidents of state federations, in which forestry work accomplished by the clubs of each state formed an important part.

Selected at random, a few reports follow:

Mrs. Chas. C. Capen, Williamantic, Conn., says: "635,000 forest trees planted in Connecticut."

Mrs. Lorin Webster, Plymouth, N. H., brought assurance of continued faithful work for the establishment of the Appalachian National Forest.

Enthusiastic applause greeted the statement that the first land given in New England to be used for public-school purposes was given by a woman Bridget Graffort, and the Graffort Club of New Hampshire is named for her.

Mrs. F. H. White, of Lewiston, Me., stated that this is a banner year for forestry in Maine, and that interest continues unabated.

"Ten thousand acres in forest reserves, and an appropriation of \$25,000 to buy five or six thousand more acres," is the encouraging report of Mrs. Henry H. Dawson, of Newark, N. J.

Mrs. Edward W. Biddle, Carlisle, Pa., reported intense interest in forestry and that the work is growing steadily.

Mrs. Stoddard Hammond, of Binghamton, N. Y., announces steady progress, and that the Women's Clubs stand eager and ready to do all in their power for forestry.

Mrs. W. B. Burney, of Columbia, S. C., is proud of the forestry work accomplished by the Women's Clubs. She emphasizes the especial need of work in that state.

"Forestry has been cannonized in Vermont," says Mrs. P. F. Hazen, of

St. Johnsbury. The audible ripple of mirth led one to believe that the Women's Clubs had determined to cannonize some one unless forestry action be taken soon. Another earnest worker present from Vermont was Mrs. N. K. Fairbanks.

Professor Rane, state forester for Massachusetts, accompanied by Mrs. Rane, was present at the meetings. Professor Rane's two new books, relating to trees and primary instruction on trees, received general and favorable notice.

Among other distinguished and notable forestry workers present were: George Ward Cooke, of Haverhill, Mass., and Mrs. Mary P. Mumford, of Philadelphia, who introduced forestry in the General Federation of Women's Clubs six years ago.

Mrs. Alice F. Spalding 1016 Middlesex Street, Lowell, Mass., speaks enthusiastically of forestry work accomplished in Massachusetts.

Especially well received were the remarks of Mrs. Mason, former chairman of the State Forestry Committee of New Hampshire, who told of the damage to white birches by tourists and summer visitors, who, from thoughtlessness and ignorance, rather than from wilfulness girdle the trees to secure strips of bark. The bark never grows in, and the wanton act not only injures the looks of the tree and stunts its growth, but shortens its life as well. Through press bulletins and leaflets, it is hoped that education regarding this great evil may become general.

"The balsam fir of New Hampshire is in danger of becoming extinct," said the same speaker, "because of the vast quantities of it ruthlessly gathered by summer visitors."

Mrs. Josiah Evans Cowles, of Los Angeles, Cal., past treasurer of the General Federation and who has just been elected first vice-president, especially deploras the carelessness of hunters and campers, and others in starting disastrous forest fires. "We of the West realize that water is king," said Mrs. Towles. "To have water we must have forests, and to have forests we must

plant trees. If there were no other reason, the planting of trees is a valuable source of revenue."

The chairman of the Indiana State Forestry Committee, Mrs. N. L. Agnew, of Valparaiso, Ind., looks forward to legislation providing for a state tree and for planting forest trees where the land is unprofitable for agriculture, also to a law for the protection of shade and roadside trees, and to the appointment of a tree warden in every town, who shall protect trees from injury by animals, provide wire guards, and otherwise look after the trees in his district.

Among other state chairmen of forestry committees who took part in the forestry conference were: Miss Elizabeth K. Hobbs, of North Berwick, Me.; Mrs. Chas. H. Jolls, of Wyoming, Del.; Miss S. Elizabeth Demarest, 130 Bloomfield Street, Passaic, N. J.; Mrs. Milton Sawyer Woodman, West Lebanon, N. H., and Mrs. C. L. Hilleary, of Indianapolis, Ind.

At the formal meeting on Forestry the speakers were introduced by Mrs. P. S. Peterson.

Mrs. Peterson has devoted many years to practical forestry questions and is an enthusiastic and zealous worker. She has studied the question amid most favorable environment, the Peterson nursery at Chicago and extensive travel through the forests of Norway, Sweden, and Germany has added to her knowledge. She organized forestry work in the Illinois federation, and was the first chairman of Forestry in Illinois. She is the leader of large classes in forestry and tree-study among exclusive clubs in Chicago. Mrs. Peterson stated that for six years the women's clubs of the country had been systematically organized to promote work for forestry.

Mrs. Mary Reilley Smith, a prominent member of Sorosis Club, of New York City, was introduced by Mrs. Peterson as the author of the poem and song, "Scatter Seeds of Kindness," and spoke of the birds as "the sky children." The subject of her essay was: "The

Voice of the Forest." Mrs. Smith said the insectivorous birds belonged to the economic department of nature, and that if they were destroyed, humanity would have a hard time getting along, even if man could exist on earth at all.

She appealed to woman's power to help to right the wrong of the extermination of birds of beautiful plumage because of the ruthless demands of fashion, and said it lay in the ability to choose between a rose and a feather. Mrs. Smith said, "I was once quoted as having said that wearing birds and wings brought wrinkles. I did not say that; I only said I wished it did."

Mr. Enos A. Mills, of Estes Park, Colo., gave a poetic essay on the woods in which he appealed to sentiment to save the trees from destruction. He gave many beautiful and graphic illustrations to show the humanitarian side of our forest friends and his charming word pictures of camp life appealed to all.

At the forestry conference, the discussion was opened by an address on "Waste of Natural Resources, Including Forests, and Need for Conservation," by Mrs. Lydia Adams-Williams, of Washington, D. C., who appealed to the women to take up the work of conservation and to save from profligate waste and destruction the natural resources, including the timber, the water-power, the soil, and the fuel and industrial minerals. Mrs. Adams-Williams referred to President Roosevelt's letter inviting Mrs. Sarah S. Platt Decker to the Governors' Conference, in which the President asked the cooperation of the women of the country in bringing the matter of conservation before the people.

Mr. Enos A. Mills also gave an address before the conference, which contained practical and helpful suggestions. A number of questions were asked from the floor, and a general discussion and short talks by chairmen of forestry committees, or their representatives, brought to a close a very interesting conference.

NEW COMMISSION AT WORK

Permanent Organization Completed at Chicago—Corrected Membership of the Commission—First Work Now Under Way

OVERSHADOWED, in the press dispatches, to a considerable degree by the news of a great national political convention being held at the same time, the executive committee of the National Conservation Commission met in Chicago on June 19 and perfected its organization. The first work of the Commission—that of taking an inventory of the Nation's natural resources—has already been put under way, and a report, to be presented at the meeting to be held in Washington next December, will be made from the findings of this "invoicing" committee.

As finally organized, the membership of the new Commission follows:

WATERS

Hon. Theodore E. Burton, Ohio, chairman.

Senator Francis G. Newlands, Nevada.

Senator William B. Allison, Iowa.

Senator William Warner, Missouri.

Senator John H. Bankhead, Alabama.

Mr. W. J. McGee, Bureau of Soils, secretary.

Mr. F. H. Newell, Reclamation Service.

Mr. Gifford Pinchot, Forest Service.

Mr. Herbert Knox Smith, Bureau of Corporations.

Hon. Joseph E. Ransdell, Louisiana.

Prof. George F. Swain, Institute of Technology, Massachusetts.

Brig. Gen. William L. Marshall, chief of engineers, U. S. Army.

FORESTS

Senator Reed Smoot, Utah, chairman.

Senator Albert J. Beveridge, Indiana.

Senator Charles A. Culberson, Texas.

Hon. Charles F. Scott, Kansas.

Hon. Champ Clark, Missouri.

Mr. J. B. White, Missouri.

Prof. Henry S. Graves, Yale Forest School, Connecticut.

Mr. William Irvine, Wisconsin.

Ex-Governor Newton C. Blanchard, Louisiana.

Mr. Charles L. Pack, New Jersey.

Mr. Gustav Schwab, National Council of Commerce, New York.

Mr. Overton W. Price, Forest Service, secretary.

LANDS

Senator Knute Nelson, Minnesota, chairman.

Senator Francis E. Warren, Wyoming.

Hon. Swagar Sherley, Kentucky.

Hon. Herbert Parsons, New York.

Ex-Governor N. B. Broward, Florida.

Mr. James J. Hill, Minnesota.

Ex-Governor George C. Pardee, California.

Mr. Charles Macdonald, Am. Society of Civil Engineers, New York.

Mr. Murdo Mackenzie, Colorado.

Dr. T. C. Chamberlin, University of Chicago.

Mr. Frank C. Goudy, Colorado.

Mr. George W. Woodruff, Interior Department, secretary.

MINERALS

Hon. John Dalzell, Pennsylvania, chairman.

Senator Joseph M. Dixon, Montana.

Senator Frank P. Flint, California.

Senator Lee S. Overman, North Carolina.

Hon. Philo Hall, South Dakota.

Hon. James L. Slayden, Texas.

Mr. Andrew Carnegie, New York.

Prof. Charles R. Van Hise, Wisconsin.

Mr. John Mitchell, Illinois.

Mr. John Hays Hammond, Massachusetts.

Dr. Irving Fisher, Yale University, Conn.

Dr. I. C. White, State Geologist, West Virginia.

Mr. Joseph A. Holmes, Geological Survey, secretary.

EXECUTIVE COMMITTEE

Mr. Gifford Pinchot, chairman.

Hon. Theodore E. Burton.

Senator Reed Smoot.

Senator Knute Nelson.

Hon. John Dalzell.

Mr. W. J. McGee.

Mr. Overton W. Price.

Mr. G. W. Woodruff.

Mr. Joseph A. Holmes.

The meeting of the Executive Committee was held in the office of the United States Reclamation Service, Federal Building, Chicago, at 12:30 p. m., June 19, 1908. There was present of the Executive Committee: Messrs. Pinchot, chairman; Nelson, Dalzell, Burton, Smoot, McGee, and Holmes; absent: Messrs. Woodruff and Price. There were also present Messrs. Flint, Van Hise, Newell, J. B. White, and Irvine. Dr. McGee acted as secretary pro tem.

After a brief statement of the purpose of the meeting by the chairman, Doctor Holmes suggested Mr. Thomas R. Shipp as secretary of the Commission. The suggestion was supported by Messrs. Newell, Nelson, and McGee; and Mr. Shipp was unanimously elected secretary.

Mr. Burton proposed that the chairman and secretary be authorized to correspond with Governors or other officials of the several states. Senator Flint concurred, suggesting that Governors be asked so to to arrange their communications as to facilitate refer-

ence to appropriate sections of the National Commission. After discussion, the action proposed by Messrs. Burton and Flint was unanimously agreed to.

The chairman suggested the advisability of inviting the Governors of the several states, or representatives to be appointed by them, to participate in a meeting of the National Commission, preferably after an initial meeting in which the organization might be perfected and a plan for a report adopted. The suggestion was approved. After Tuesday, December 1 (10 a. m.) had been selected for the first general meeting of the Commission, the place (preferably in the House Office Building in Washington) to be fixed by the chairman, Doctor McGee suggested either December 8 or December 15 as the time for the proposed joint meeting of the National Commission with the Governors or their representatives. After discussion, in the course of which it was agreed that the Executive Committee should have an outline report ready for discussion at the session of December 1, it was decided without dissent that the chairman should invite the Governors to a joint meeting to be held early in December, at a time and place to be fixed by him.

Mr. Burton suggested that the Executive Committee issue bulletins of progress from time to time, announcing places and dates of meeting, reporting any action taken, and conveying other information of service to the Commission. The suggestion was generally approved and the chairman was instructed to carry it out.

The chairman announced that the President had issued an Executive Order to heads of Departments, instructing them to cooperate with the National Conservation Commission. After general discussion, on motion by Mr. Burton, it was decided that in the collection of information the chairman and secretary of each section shall act in behalf of that section and that the data shall be coordinated by the chairman of the Commission; and by general agreement the chairman was instructed

to secure such assistance as may be required for the preparation of special statements and reports. The suggestion of the chairman that the general reports of the Commission should be brief was approved.

Speaking on behalf of the Section of Water Resources, Mr. Burton gave notice of a proposed European trip, and invited members of the Executive Committee and other commissioners to join him in an inspection of several European rivers in July.

Senator Nelson suggested greatly needed lines of inquiry relating to the public lands, including extent, location, classification, modes of transfer, etc. He pointed out the desirability of carefully considering the methods of disposal of the lands. As a basis of recommendations to the Congress, he urged that the land laws of the United States, and so far as may be those of the several states should be codified. Mr. Newell and others concurred, holding that a reclassification of the public lands as affected by reclamation through irrigation and drainage is urgently required. After discussion of details, it was agreed that the chairman should have a codification of the land laws of the United States along the lines indicated by Senator Nelson commenced at an early day, with a view to a report by December next.

President Van Hise directed attention to the loss of phosphate salts, and suggested that the working of phosphate deposits and exportation of phosphates from the United States should be limited by law, and Doctor Holmes, on behalf of the Section of Minerals, undertook to begin inquiries during the summer with a view to an early report.

Senator Smoot suggested certain special inquiries relating to Forest Resources. The matter was discussed by Messrs. Nelson J. B. White and Irvine, and Chairman Pinchot undertook to have special statements and reports prepared in time for the December meeting.

By general consent the chairman was authorized to communicate with presi-

dents of national organizations concerned in the conservation of resources.

On motion of Senator Nelson, the meeting adjourned.

An inventory of the natural resources of the United States, in cooperation between the National Conservation Commission and the Executive Departments of the Government, is now going rapidly forward. At a meeting with the chairman of the Commission shortly after the organization of the Executive Committee, the chiefs of bureau concerned went over the general plan of work, made valuable suggestions regarding it, and cordially offered active cooperation in the collection of material needed for the preliminary report of the Commission, on January 1. Other chiefs of bureau, who were unable to be present, have since offered their assistance, with the result that the collection of material for the forthcoming report is actually in progress in every bureau concerned.

The compiling of the information furnished by the Executive Departments and from other sources has been placed in the hands of Mr. Henry Gannett, whose wide experience and achievement qualify him eminently for the task. Mr. Gannett, who is now just finishing his work as Assistant Director of the Cuban census has already taken up his duties for the Conservation Commission, and is in daily touch with the bureaus in which the material is being gathered. In order to hasten the work, the President has asked that Mr. Gannett be detailed to him, to assist the Commission, as soon as his duties upon the Cuban census will permit, so that he may devote his full time to the compilation of the material obtained. The President has also addressed to each chief of bureau engaged in the collection of material for the Commission, a letter expressing his pleasure at the enthusiastic cooperation offered, and expressing his sense of the importance of the work.

While much of the necessary material is either already available in the Executive Departments or obtainable by them, the Commission will also gather in-

formation from other authoritative sources. It looks forward to valuable cooperation with the Conservation Commissions of the respective states and with national organizations which were represented at the Conference of Governors at the White House last May. The Commission has announced, through letters to the Governors and to the representatives of these organizations, that it welcomes suggestions and information along the line of its inquiries.

The Commission is emphasizing the need of vigorous work in order that the Executive Committee may have the material collected in final form to lay before the Commission at its first meeting in Washington, on Tuesday, December 1, and likewise for the meeting of the Commission with the Governors, or their representatives, one week later, on Tuesday, December 8.

Cooperation between the states and the National Conservation Commission has become a marked feature of the Conservation movement since the last bulletin was issued. Within less than one month from the date of the President's letter appointing the Commission and advising the Governors that he had done so, the Governors of five states had named Conservation Commissions. These were Governor Norris, of Montana; Governor Chamberlain, of Oregon; Governor Folk, of Missouri; Governor Leo, of Delaware, and Governor Fort, of New Jersey. In addition (Governor Warner, of Michigan, has advised the Chairman of the Commission of the existence of the Forestry Commission of Michigan and also a Commission of Inquiry charged with the duties of securing all information and data possible regarding forestry.

Herewith is given a list of states that have already selected Conservation Commissions:

Delaware:

Conservation Commission—

- Hon. George Gray, Wilmington, Del.
- Hon. Benjamin Nields, Wilmington, Del.

Hon. James Pennewill, Dover, Del.

Michigan:

Forestry Commission—

- Hon. William H. Rose, State Land Commissioner, Grand Rapids.
- Hon. Chas. W. Garfield, Grand Rapids.
- Hon. W. B. Mershon, Saginaw.
- Secy., Hon. Chas. B. Blair, Grand Rapids.

Missouri:

Commission on Forestry—

- Mr. Herman von Schrank, St. Louis.
- Mr. O. L. Monger, Greenville.
- Mr. D. A. Latshaw, Kansas City, Mo.

(Two members yet to be appointed.)

Commission on Waterways—

- Mr. W. K. Kavanaugh, St. Louis.
- Mr. W. K. James, St. Joseph.
- Mr. L. H. Jones, Kansas City, Mo.
- Mr. W. H. Black, Marshall.

Montana:

Forestry Commission—

- Hon. Paris Gibson, Great Falls, Mont.
- Hon. Robert B. Smith, Bigfork, Mont.
- Hon. Lew L. Callaway, Virginia City, Mont.

Oregon:

Conservation Commission—

- Hon. J. E. Teal, Chairman, Portland, Oreg.
- Prof. F. G. Young, Secretary, Eugene, Oreg.
- Mr. J. H. Lewis, Salem, Oreg.
- Hon. J. C. Stevens, Portland, Oreg.
- Hon. W. K. Newell, Dilley, Oreg.
- Hon. Austin T. Burton, Hillsboro, Oreg.
- Prof. J. R. Wilson, Portland, Oreg.
- Hon. Richard Montague, Portland, Oreg.
- Prof. E. R. Lake, Corvallis, Oreg.
- Mr. C. S. Jackson, Portland, Oreg.
- C. B. Watson, Ashland, Oreg.
- Frank J. Miller, Albany, Oreg.
- Mr. J. N. Hart, Baker City, Oreg.
- Mr. Will R. King, Salem, Oreg.

In addition to these the states of New Jersey and Illinois have appointed conservation commissions, but the names of the members have not yet been made public.

The Governors of several other states have announced their intention to appoint Conservation Commissions in the near future. The Governors generally express commendation of the action of the President in appointing the National Conservation Commission and pledge their hearty cooperation in any plans of the Commission for forwarding the Conservation movement. Such cooperation has been promised by Governor Hanly, of Indiana, who announces his purpose to appoint a State Conservation Commission in the near future; Governor Deneen, of Illinois, who says he will soon send in the names of the Conservation Commission he is to appoint; Governor Ansel of South Carolina, who intends to take up the matter of the appointment of a state commission at a very early date; Governor Glenn, of North Carolina, who will recommend to the next legislature of his state action necessary to enable the State Geological Survey to cooperate with the National Conservation Commission in the preservation of natural resources; Governor Noel, of Mississippi, who will urge the next legislature of Mississippi to enact such legislation as will secure the full help of the state toward a wise solution of the important problems involved in the conservation of natural resources; Governor Curry, of New Mexico, who expresses his intention to appoint a strong and representative territorial Conservation Commission; Governor Willson, of Kentucky; Governor Davidson, of Wisconsin; Governor Harris, of Ohio; Governor Guild, of Massachusetts; Governor Swanson, of Virginia; Governor Stuart, of Pennsylvania; Governor Woodruff, of Connecticut; Governor Dickerson, of Nevada; Governor Gillett, of California; Governor Johnson, of Minnesota; Governor Cutler, of Utah, and Governor Sheldon, of Nebraska.

In addition to the cooperation of the

Executive Departments and the Governors with the National Conservation Commission, various organizations which were represented at the White House Conference are offering valuable assistance.

The National Lumber Manufacturers' Association has named a special committee to cooperate with the National Commission and to hold its sessions in Washington. The American Academy of Political and Social Science has appointed a special committee "to offer suggestions and to be of service wherever and whenever possible." This committee is made up as follows:

Dr. Emory R. Johnson, chairman, University of Pennsylvania, Philadelphia, Pa.

Dr. L. S. Rowe, University of Pennsylvania, Philadelphia, Pa.

Dr. S. M. Lindsay, Columbia University, New York, N. Y.

Dr. S. N. Patten, University of Pennsylvania, Philadelphia, Pa.

Dr. John H. Gray, University of Minnesota, Minneapolis, Minn.

The National Board of Trade advises the chairman that it has a Committee on Conservation of Natural Resources, and that it expects to call this committee together and give the National Commission detailed and specific information from the standpoint of the National Board of Trade. The American Paper and Pulp Association offers its cooperation, and through its president announces that the subject will be taken up at its next meeting, the latter part of July. Dr. Ira Remsen, president of the National Academy of Sciences, announces that he will bring the whole matter of the conservation of natural resources to the attention of the Academy at its next meeting and he says he regards it as not unlikely that a committee of the Academy will be appointed to cooperate with the National Commission. Mr. J. B. Dort, president of the Carriage Builders' National Association, says he will be glad to bring the subject of conservation before his organization with a view to furnishing the National Commission specific data in the Association's particular field.

TREES AND THEIR NAMES

SOME kinds of trees have as many aliases as the criminal with the longest police-court record. For many reasons this is most unfortunate. To scientists, the confusion which results when people mean different things by the same word or use different words for the same thing, is intolerable, and therefore they use a carefully devised and carefully guarded system of nomenclature.

The every-day man is apt to be impatient with what seems the pedantic fondness of the botanist for jaw-breaking Latin names, which mean nothing to the uninitiated, when common usage supplies a familiar name. But the trouble is that on the familiar name there is seldom any agreement. Hence many misunderstandings, many friendly disputes, and often failures even of those who know a good deal about trees to distinguish correctly the different kinds of trees and woods.

School teachers are paying more and more attention to nature-study work, and in nature study are paying more and more attention to forest trees because of the general interest in forestry. At best there are difficulties enough in the way for those who have not had special training in forest botany, when it comes to identifying specimens of leaves and twigs brought to them by their pupils. Leaves, particularly, often vary greatly not only in different regions, but also in the same locality, and even from different parts of the same tree. The lack of agreement on the common name adds another complication.

If it were possible to bring every one to accept one name for each kind of tree there would be a decided advantage not only through making it easier to recognize trees, but also through clearing up confusion as to the woods in common use. The makers of popular tree books

have tried to promote uniformity, often by following the usage given preference by the United States Forest Service, which has made a careful study of popular usage to the end that as much authority as possible may be given to the name most widely and commonly used. But unfortunately it is too much to expect that absolute uniformity can ever be brought about.

The trouble is almost always over what the botanist calls the specific name. It is easy enough to tell an oak from a maple, and there ought not to be much uncertainty—though there often is—as to whether a tree is a pine or a spruce. But oak, maple, pine, and spruce are generic names, and each genus includes a number of species. Here begins a confusion which often approaches chaos.

Not only do different localities apply different names to the same species and the same name to different species; in the same locality several different names may be used for a single species, very likely, with false distinctions where no botanical basis for a distinction exists. For instance, a certain oak often called both black and yellow oak used to be split into hand-made lath in early days, and hence got also the name of "lath oak;" but since to make good lath a straight-grained tree was needed, some woodsmen think that a black oak, such as the lath-maker would have selected by its looks, is a different kind of tree from other black oaks. Black oak is also used as a sub-generic term for all the many kinds of oak which, unlike the white oaks, have leaves with bristle-tipped lobes, and take two years to mature their acorns.

Indeed, the local names given to the forty-seven different oaks which form forest trees in the United States are almost without limit. The true white oak, however, the noblest tree of the oak

tribe, seems to have no nickname except in Arkansas, where it is occasionally known as stave oak. But a good many other kinds are also called white oak.

What is called black locust in Pennsylvania is yellow locust in Massachusetts, white locust in New York, red locust in one part of Tennessee and green in another. In Maine it is simply locust, in Louisiana acacia, in Minnesota honey locust, and in Maryland post locust. These many names overlap and are not strictly separated by state lines. On the other hand, the true honey locust (which belongs to an altogether distinct genus from the black locust), is known also as black locust, sweet locust, thorn locust, locust, three-thorned acacia, thorn-tree, honey shucks, piquant amourette, Confederate pintree, and a few other names.

White pine is a tree of so distinguished appearance that it is entitled to one name among lumbermen as well as among botanists. But it does not have it. In both Massachusetts and South Carolina it is sometimes known as Weymouth pine, which is its universal name in Europe. Pennsylvanians occasionally speak of it as soft pine, Tennesseans as spruce, and in other parts of the South it is called Northern pine.

The loblolly pine is a southern tree, and the people of the South have been liberal with names, sometimes applying several in a restricted locality. In North Carolina it is loblolly oldfield, torch, rosemary, slash, shortleaf, sap, Indian, yellow, swamp, and longstraw, each being followed by the word "pine." In Maryland it is longshucks, in Delaware longschat, in Virginia cornstalk, foxtail, spruce, swamp, and others. It is called meadow pine in Florida.

From New England to the Carolinas the tulip poplar is frequently called white wood or tulip tree. Yellow poplar is its usual name in Pennsylvania, West Virginia and Kentucky, and on the market in the form of lumber. It is tulip poplar in Illinois, poplar in Ohio,

white poplar in Indiana, blue poplar in Delaware, hickory poplar in Virginia, popple in Rhode Island, cucumber tree in New York, and canoe wood in Tennessee.

The birches are equally rich in names, and some of the names cling after the lumber reaches market. "Cherry" and "mahogany" furniture may be made from what in Maine is known as sweet birch, but which changes its name at the crossing of almost every state line as the tree's habitat is traced southward.

Scarcely half a dozen of the almost 500 species of forest trees found in the United States are popularly known by their botanical names. A few however, are so known, among them being catalpa and sassafras. But even these suffer through mispronunciation by those who try to speak them. Catalpa is sometimes catawba, and sassafras is badly broken up by those who try to say it. The word itself is a corruption of two Latin words meaning "stone breaker." It is possible that it was so called because its roots sometimes grow in crevices of rocks and may force the ledges apart. Some of the mispronunciations are saxifrax, sassafac, and sassafrac.

When mistakes are made in the identification of wood furnished for building purposes, much embarrassment and trouble often result. Architects, builders, and other users of lumber find that the situation is growing worse each year, because many of the kinds of lumber formerly in heavy supply are now growing scarce and substitutes are gradually taking their places. To meet this one demand of identification of trees by wood structure, the Government has established a laboratory which renders free service to all users of timber. This laboratory is in charge of a trained dendrologist of the United States Forest Service, whose prompt advice may be had by architects, builders and other wood users who send specimens of woods for examination addressed to the Forester at Washington.



EDITORIAL

A Remarkable Speech

NEAR the close of the last session of Congress a Senator from one of the western states delivered a remarkable speech—remarkable from many points of view. The speech was delivered in the course of the discussion over the appropriation for the United States Forest Service, and in it the Senator made so many statements that are at wide variance from the known facts that the speech seems to require attention. Among the statements made in this remarkable utterance were the following:

That Forest guards, rangers, etc., are an arrogant class of government employees; that acts of violence at their hands are of frequent occurrence; that a citizen of the state represented by the Senator speaking had been set upon, on the open highway, and feloniously shot simply because the said citizen refused to give the road to the guard—the citizen at the time being in a vehicle, while the guard was mounted. It was further stated that the Forest Service requires its guards, rangers, etc., to wear a uniform; that the Senator himself had often seen such uniformed guards lounging upon the piazzas of summer-resort hotels, sporting their livery and wearing cocked and cockaded hats; that costly steam yachts were provided—paid for out of Government funds—for the sole use and pleasure of the guards, rangers, and others of the Forest Service. And, finally the statement was made, virtually, that the entire Forest Service is a farce, if nothing worse, and that it is conducted solely for the profit and aggrandizement of certain individuals, actually accomplishing no good whatever, and of no benefit save to a favored few.

This truly remarkable utterance, as

we say, seems to require attention; not because the Forest Service needs defenders—its work shows for itself—but because there are many men, both in public and private life, in the western states, who make a practice of going about the country delivering themselves of these and similar utterances, thereby creating impression that are wholly unjustified by facts. Taking the above statements up *seriatim*, the answers follow:

The Murderous Guard

THE shooting episode spoken of by the Senator has become a classic in the West. During a trip last summer, in which the writer went into half a dozen far western states, he heard this story a score of times. Each time the actors in the drama were differently named, and the location of the shooting was different with each teller of the tale. At last becoming skeptical after having heard of the shooting as happening in Colorado, Wyoming, Idaho, Montana, Utah, and Arizona, the writer set about learning the truth of the story. It was found that there had actually been a shooting affair, in which the aggressor was a forest guard. The shooting occurred on a forest road traversing a National Forest in Idaho, but it was not found that any one was actually shot, the information being that the guard—a man named Wagner—had fired either into the air or into the ground, and the private citizen being uninjured. However, this much was learned: The shooting did occur, and it was done by a forest guard. Wagner, the man who did the shooting, was promptly arrested by forest officers, haled into an Idaho court,

where he was fined, and he was as promptly discharged from the Forest Service as being unfit to hold a position therein. Wagner's connection lasted exactly seven days he being discharged at the end of that time "for the good of the Service." A trivial affair to have been spread all over the West; and it has certainly grown pretty thin in the spreading process.



Uniforms of Forest Officers

AS TO the uniforms to which the Senator takes such violent exceptions. The Senator's statement to the contrary notwithstanding, forest officers are not required to wear uniforms. They may do so if they choose, and in such case very flexible regulations are provided. The uniforms, if worn, are to be of army khaki, olive brown, with numerous and capacious pockets, any style of footwear fancied by the wearer, and the hat—that terrible cocked and cockaded chapeau so forcefully described by the western Senator—is simply the regulation western Stetson—no more and no less. There is no compulsion whatever in this matter of uniforms; forest officers may wear them or not, just as they see fit. No man is disciplined in any way if he chooses to go without a uniform, but it is suggested by the Forest Service, that, for the protection of the general public, some sort of distinguishing uniform is desirable, so that individuals may know with whom they are dealing in matters concerning National Forests. The object is identical with that sought to be served by uniforming mail carriers, policemen, firemen, and other public servants, and the Senator's argument would apply equally well to any of these. If uniforms are so distasteful to the Senator, he should introduce a bill requiring all mail carriers, etc., to discard the odious badge of servitude; there would be exactly as much common sense in such a proceeding as in the demand for

the elimination of a fixed and rigidly required foresters' uniform — besides which, the latter doesn't exist.



Costly Steam Yachts

SEVERAL of the National Forests are located on large bodies of water—lakes, rivers, bays or sounds—around which travel is extremely difficult on account of natural obstructions. Several such forests have been supplied with small launches—none of them even approaching in size a yacht—for use in tours of inspection, trips from point to point, and in case of desperate emergency requiring the presence of several forest officers at a certain point with the least possible waste of time. Now, it certainly does seem to be "stretching the blanket" to the point of uttermost tension to designate a twenty-five foot or thirty-foot launch a "costly steam yacht." Perhaps, however, this may be accounted for by reason of the Senator's unfamiliarity with yachts. Life in the altitudinous fastnesses of some of the western states is not calculated to familiarize one with shipping, to any marked degree; and his reading may have given the Senator the impression that any small boat from a canoe up, is a yacht. "A primrose on the river's brim, a simple primrose was to him," as it were. But these are some of the things the forest officers do with those "costly steam yachts:" They make in a couple of days trips around lakes that, were the trips made by land, would require two weeks; they make hurried dashes and cut off the retreat of poachers, outlaws, and the like, saving local law officers days or weeks of hard riding and comfortless camps; and they make it possible to check forest fires that, allowed to gain the headway they would gain were it not for the little vessels, would destroy thousands of dollars worth of valuable timber. Indeed, one such instance occurred only last summer; the fire, just starting, was extinguished be-

fore it gained any headway at all, and the timber saved thereby is worth more than the total cost of all the launches yet bought by the Service. The fire started in the timber on the hills above the lake; to make the trip around the end of the lake, by land, would have taken the better part of two days; the launch made it across in an hour or so. We might say that steam fire engines are a needless extravagance on the part of a city; the engines stand idle the greater part of the time. But suppose cities were without them?



The Service Itself

FINALLY, is the Forest Service a valuable hard-working, indispensable part of the Government, or is it, as the Senator says, a farce? If it were the latter, we fancy there would be less opposition to it in the West—or anywhere else, for that matter. No organization, of whatever character, that is not more than ordinarily active, and that is not doing a great deal of work, is ever abused. No; the Senator is unhappy in his choice of adjectives. Active, aggressive, even impertinent—when its activities are looked at from the viewpoint of certain equally aggressive western interests—the Forest Service may be, but never farcical. It is doing a work that is perhaps more vitally necessary to the well-being of the whole country than that of any other single bureau of the Government. Only the preliminary steps in the work have as yet been taken; the labors that remain to be performed overshadow the actual accomplished work as Pike's Peak overshadows the foothills. If the forests of the West are to be saved from a fate like that which has already overtaken those of the East, the work of the Forest Service must go on, increasing in scope as it proceeds. How any man who pretends to the ability to think consecutively and to reason from premise to conclusion can say there is no need for the work of the Forest Service, and that the views advanced by it are the babblings of cranks and hare-

brained theorists, passes the comprehension of the writer. Practically the entire State of Michigan was, thirty years ago, covered with a dense stand of timber as valuable as that growing in any of the western states. Where is that timber now? Gone—absolutely and irrevocably gone; stripped to the sand and rocks of the eroded soil. The same is true of the greater part of Wisconsin. Likewise it is true of the mountains of Kentucky and Tennessee. True, too, of Pennsylvania; true of New York, and the New England States. True, also of the South Atlantic States. Is there any reason to believe that western timberlands will fare any better if left unprotected? And when those timber tracts of the West shall have been ravaged and stripped bare, what of the country? What of the farming lands that require irrigation water? What of the grazing lands that must have water? And, finally, what of the great, growing nation that must have timber and lumber?

It will readily be granted that certain individuals, who have a winning way with state officials, would be greatly benefited, financially, if they were unhampered in their operations by Forest Service rules and officials. Certain groups of stockmen in the range and grazing states, likewise, would probably fare better financially, were the Government to remove its hampering regulations—hampering only in so far as to make stockmen pay for the benefits they receive—and abolish the Forest Service. But that the Government will ever do any such thing is not to be thought for a single instant. Rather, the activities of the Forest Service will be increased from year to year; the work of the Reclamation Service will keep pace with it; the new Commission on the Conservation of Natural Resources will add its strength to the work of protection, and the country as a whole will not be long in seeing everywhere the benefits that flow from the work. The little group of westerners who want every tree and every blade of grass that grows on Government ground for their own use will doubtless

keep up their agitation—an agitation as childish as the speech of the western Senator referred to above—but the chorus of approval from the sensible, patriotic men and women of America will drown their feeble pipings in its swelling volume.



Changing Our Title

READERS of FORESTRY AND IRRIGATION will have noticed, on the cover of the last few numbers of the magazine, the forecast of a change in title. In shadow-form the word "Conservation" has appeared across the face of the old name, and this shadow-forecast has grown stronger and stronger until, with this month, the old name passes into the background and is overshadowed by the new. With the September issue of the magazine, the title will be changed completely, and the new one, "Conservation," with the explanatory sub-title, "Woods and Waters; Soils and Ores," will take its place.

There are many reasons for this change of title, and a few words of explanation are due the members of the American Forestry Association and the subscribers and readers of the magazine. For some time it has seemed to those in charge of affairs that the title FORESTRY AND IRRIGATION does not fully cover the ground; that the magazine, as well as the Association, stands for more than these two features of the broad plan of national conservation of natural resources. Waterways and water-powers are to be conserved; soils are to be cared for and kept from wasting into the rivers and the sea; coal, iron ore, and other minerals are to be safeguarded and so used as to insure, both to the present generation and the generations to come, the fullest possible benefits from the mines of the country. And at the same time, the forests of the land must be taken care of, new forests established, devastated tracts covered once more with trees, so that the waterways may become again arteries of travel, rather than choked-up drains or roaring floods. Forested

watersheds and hillslopes mean equable water-flows and clarified streams, that can bear on their bosoms fleets of steamers and barges. The reestablishment of a large water traffic means a lessening of the drain upon the iron mines and the coal beds; so that the plan of forest conservation, carried to its logical conclusion, means more to the nation than any other question that now faces us. Forest-crowned watersheds and forested slopes mean an increased and a continual, rather than an intermittent, flow of water in the streams and the rivers, and they mean, too, prevention of the silting up of the rivers, the mill-ponds, and the harbors into which the rivers empty. These things mean, in turn, the reestablishment of a vast inland water traffic, and this, again, means a lessening of the prodigal drain upon our mines of coal and iron, a lessening of transportation charges, and an incalculable lengthening of the life of the nation's natural resources.

These things being true, it was decided some time ago that it is time for the American Forestry Association to take a definite stand in the forefront of those who demand that a program of conservation be instituted and carried out to the uttermost. Forestry and irrigation are two vital points in the conservation program, but they are not the only points, by any means. The broader idea of conservation embraces forestry, irrigation, and all the other points we have mentioned; therefore, it has seemed fitting that the magazine, the official publication of the American Forestry Association, should indicate in its title the widening scope of the work that is before the Association. Expressions of opinion from individual members of the Association have so far been entirely approving; we invite other members to write us, discussing the change and giving their views as to what the Association and the magazine, under its new title, should stand for. We have mapped out a plan of campaign reaching many months into the future; we are endeavoring to give to our readers a better and a broader magazine than they have ever had be-

fore. The letters of approbation already received testify to the fact that we have not wholly failed in our efforts; now we want others who have not written to give us their views. The magazine belongs to the members of the Association, and we want the members to take an interest in their property.



Our Membership Campaign

SOME time ago each member of the American Forestry Association received a letter giving the details of a plan for increasing the circulation of the magazine, and asking the cooperation of each member in making the plan a success. Later, a second letter was sent to those of the members who failed to respond to the first. The result of these two letters has been the addition to our lists of several thousand new subscribers to the magazine, and the subscriptions are still coming. We have called these "short-term subscriptions," and just here we want to urge every individual member of the American Forestry Association who has not yet done so to let us have his or her response to our letters.

The thousands of new subscribers we have added to our lists by this means are now being solicited to become members of the Association. No better list, for solicitation purposes, could possibly be secured than these new subscribers to the magazine. We have asked that in all cases the names of none but those believed to be in some degree interested in forestry and the general idea of conservation of natural resources be given us, and we have every reason to believe that the members have heeded our suggestion. Now it is our intention to give to these new subscribers—and to the old, as well—a magazine sufficiently interesting and attractive to make them want to ally themselves with the Association and thus take a part in the work that our organization is doing. Within the next few weeks every one of these new subscribers will receive a communication from this office, with an invitation to become a members of the

Association. Present members who have sent in subscriptions can aid in the work of adding new members by calling the livelier attention of those whose names they sent in to our communications. We are beginning to plan for the next annual meeting, and before the time of that meeting we want to add many hundreds of new members to our rolls. This office will do its full share in the work of securing these new members; the magazine will exert every effort to attract and crystallize the interest of those who are now interested in a general way in the subject of Forestry and the broader subject of general conservation, and the members of the Association can help us wonderfully, if they will take the trouble to add the word that may turn the balance and decide the prospective member to become an actual member.



A Word of Credit

WHILE we are on the subject, let us refer again to the "short-term subscribers" mentioned above, and let us give a word of credit where it is certainly due. When our first letters were sent it, it was somewhat of a question in our minds as to how our members would respond. We had never made an appeal of the sort, and we were naturally in doubt. However, the letters were carefully prepared, and, albeit with some misgivings, were sent out. The next morning, almost before the mail had been opened in our office, a member came in with a list of four "short-term subscribers," and the cash to pay for the subscriptions. Our letter had reached this member at 8 a. m.; at 8:45 a. m., she—for the member is a woman—handed in her little list the first to be received. We felt better about the appeal then, for we thought that if even one member responded so promptly, we had everything to hope from the entire membership.

That list of four names was the first we received in answer to our first letter. Since then we have received hundreds of responses, and we have added sev-

eral thousand subscribers to our lists. But that first list is remembered very gratefully; it seemed to us to be an augury of the success of our plan, and such it has proven. Mrs. Lydia Adams-Williams is the member who so promptly answered our letter; hers was the first list we received. There are members of the Association to whom the sending of a list of a hundred or more names would be a mere trifle; there are others, who, in sending in four names, have made a real sacrifice—a sacrifice that demonstrates more fully than many words the deep interest the senders feel in the Association and its work. It is in this latter class that Mrs. Williams belongs. And, somehow, we have wondered many times since that first morning after our letters went out just what some of our wealthy influential and prominent members would think if they knew that the first answer to our appeal came from a woman—and from a woman who could ill afford the response.



Death of ex-President Cleveland

IN THE death of ex-President Grover Cleveland, forestry, and conservation in general, loses a friend. The policy of extension of National Forests—or, as they were called during his administration, forest reserves—was given, during his tenure of office great impetus; in fact, to Mr. Cleveland is due much of the credit for the foundation on a lasting basis of our forest policy. Mr. Cleveland was one of those whom President Roosevelt asked to attend the Conference of Governors, at the White House last May, as special guests of the Executive, and it was with the deepest regret that it was learned that the ex-President would not, on account of impaired health, be able to attend the Conference. An action that struck a popular chord with the members of the Conference was the submission of a resolution of sympathy by Hon. William Jennings Bryan, and this resolution was adopted in a manner as heartily sympathetic as that in which it was offered.

It was Mr. Cleveland who, when President, established the San Jacinto National Forest and others, with an aggregate area of more than 25,000,000 acres. Now it is a most graceful action on the part of President Roosevelt to change the name of the San Jacinto Forest to the Cleveland National Forest, thus making the forest a perpetual memorial to the man who, as President, established it.

Forestry, and the idea of national conservation of natural resources was not a popular subject during Mr. Cleveland's occupancy of office, and the fact that he took such a deep interest, even at that time, in the subject is an added indication of the mental greatness and deep understanding that characterized him. Failing health, in his later years, and other interests that overshadowed much else in his life, prevented his giving much attention to forestry, in a public way, but the work that he did as President, toward the establishment and extension of a National Forest system, stands as a demonstration of his unflinching grasp of great questions of national importance.



Secretary Will's Chautauqua Lectures

SINCE June 16 Secretary Will has been engaged in Chautauqua lecture work in Minnesota, Wisconsin, and Iowa. He is working under the Redpath Chautauqua System, speaking six nights per week before audiences averaging nearly 1,000. His addresses are being fully reported in the press. He carries with him an excellent lantern and a set of beautiful and instructive slides with which his lectures are illustrated. He is also accompanied by an operator to attend to the mechanical features of the work. To many of his hearers the subject is almost new. It receives careful attention, however, and its presentation arouses much interest.

Secretary Will's itinerary, up to July 13, covers the following points: Winona, Minn.; La Crosse, Wis.; West Liberty, Iowa; Cedar Rapids Iowa; Dubuque, Iowa; Eau Claire, Wis.; Inde-

pendence, Manchester, Anamosa, Maquoketa, Belle Plaine, Waverly, Osage, New Hampton, Waukon, Decorah, Cresco, Mason City, Northwood, and Hampton, all in Iowa; Austin and Albert Lea Minn., and Perry and Forest City, Iowa. An address was delivered at each of these points except Dubuque, where the meeting was prevented by the violent storm of June 20. The work closes on August 30, and includes nineteen points in Missouri. A more effective method of breaking new ground and carrying to the people the truth for which the American Forestry Association stands would be hard to devise. The following report indicates the scope of the lecture:

"Our matchless resources have long been our pride. We have thought them inexhaustible. We have used them prodigally and abused them unpardonably.

"To-day two great facts face us. First, is the growth of our population. A half century hence will find on American soil probably 200,000,000 people. Feeding, clothing, and sheltering these would be a problem, even though our resources were unfailing as the widow's cruse of oil.

"But the second fact is more ominous; it is the depletion or exhaustion of those resources. Buffalo, fish, artesian water, natural gas, and oil, are swiftly going or gone. Coal, chief source of artificial heat and power, is the basis of our material civilization. Its volume is estimated as equalling a cube nearly eight miles on the edge. Yet we waste vastly more than we utilize. Further our consumption by decades, once trebling and quadrupling, is still almost doubling. Unless wise economies are promptly adopted another hundred years may be expected to empty our national coal bin.

"Because both of their intrinsic importance and the dependence upon them of other vital resources and interests, our forests are of inestimable value. We consume each year enough lumber to floor the State of Delaware, enough shingles to shingle the District of Columbia, enough lath to load a train

reaching from Chicago to Memphis, enough cooperage stock to build a rick four feet wide and high, and extending from New York City to Colorado, enough firewood to make a one-mile cube, and enough railroad ties to build a railway around the globe with a side track across the Atlantic, while our annual wood bill exceeds a billion dollars. A New York newspaper consumes each three months a forest as large as Central Park, or 843 acres.

"Under present policies another third of a century will probably finish our wood supply. The resulting tragedy challenges human imagination.

"Further, the forest is a grand, natural regulator of stream-flow. With deforestation comes floods, destroying agriculture, commerce, and manufacturing.

"Our inland waters are probably our greatest natural resource. Neglect and railroad hostility have brought them into disuse and decay. But the railroads are now unable to handle our growing traffic, and an irresistible demand has arisen for the rehabilitation of our inland waterways. A national commission has been created to promote this work, but it finds rivers and harbors filling with washings from fields and slopes, while multiplied millions are annually spent by Congress to remove the effects without touching the causes. Of these causes, one of the chief is forest destruction, with resulting erosion.

"Two-fifths of the United States is arid, or semi-arid. This area exceeds that of the Roman Empire. Much of it is irrigable. Its value, reclaimed, will exceed a thousand times the cost of its reclamation.

"On June 17, 1902, Congress enacted the reclamation law, placing in the 'Reclamation Fund' the proceeds of certain public land sales. With this fund, the Government is constructing enormous dams, tunnels, and irrigation works, and converting the desert into a watered garden, the fund being constantly renewed from payments made by settlers upon these lands. Yet the Director of the United States Reclamation Service says: 'The water of this

work comes chiefly from streams rising in mountains. To maintain the supply of this water, it is essential that forests be maintained upon these mountains. To this end, National Forests are indispensable.

"While some of our soils are excessively dry, others are excessively wet. Our swamp area equals the area of New England, New York, and New Jersey. Much of it can easily and cheaply be drained, the resulting profits being vast. Properly tilled, this wet area would support a population equal to that of the United States. Further, sources of disease would, at the same time, be removed.

"A great drainage movement is now on, and legislation is pending in Congress. Yet drainage, like irrigation, is largely dependent upon forestry; for it is necessary not only to remove the excess of water, but to prevent its return. Hence, overflows of rivers must be checked; and, to this end, forests on slopes must be maintained.

"Our National Forest policy marks a wise and beneficent beginning. Such forests mean neither destruction nor yet the withholding from use; but the fullest use to which, in perpetuity, these forests can be put. They make it pos-

sible for us to 'eat our cake and have it, too.' Such forests, however, exist wholly in the West, on the public domain, where they were 'proclaimed' by successive Presidents. They are even worse needed in the East and South, where no public domain exists. Here the land must be bought. This necessitates an act of Congress. Such legislation is contemplated by the Appalachian-White Mountain bill, three times passed by the Senate, but each time blocked by hostile leaders in the House.

"The Southern Appalachian forests contain our last remaining important hardwood stock. As such, they are essential to the nation as a whole, to West and East alike. The East helped the West secure the Reclamation Act. It is ready to help develop the inland waterways. Western help, in turn, is imperatively needed for the establishment of national forests in the Southern Appalachian and White Mountains. Time is precious. The forests are going, while the price of the land is mounting. The American Forestry Association is leading in the fight for this imperatively necessary measure. It solicits the cooperation of every right-thinking citizen."

THE FOREST FIRE FIGHTERS

By ARTHUR CHAPMAN

The wind sweeps off the spire-like peak,
And is whirling the cinders high;
While down in the stifling, deadly reek,
We struggle, and all but die.

We have felled the trees in the fire's path,
Till our hands are bleeding and sore;
But always it speeds, with a hiss of wrath,
And leaps the barrier o'er.

We have fought it back, with blaze 'gainst blaze,
And yet has the foe slipped past;
But slowly we yield, in the choking haze,
Till the victory's won at last.

Small pay do we get, and thanks are gruff,
When we've fought the foe to his knees;
But, after all, the reward's enough,
When we hear the wind in the trees.

—*Denver Republican*

NEWS AND NOTES

Grand Canyon National Forest Made Game Preserve

THE President has signed a proclamation adding approximately 942,400 acres (from lands already included in the Grand Canyon National Forest), to the Grand Canyon National Forest.

The Game Preserve, as previously established, included that portion of the Grand Canyon National Forest lying north of the Grand Canyon, while the new proclamation includes all of that portion of the Forest lying south of the Grand Canyon except the southwest corner of the forest lying on the west side of Cataract Canyon and south of the township line between Townships Thirty-one and Thirty-two north.

This extension of the Game Preserve is in accordance with an act of Congress, approved June 29, 1906, entitled "An Act for the Protection of Wild Animals in the Grand Canyon Forest Reserves," providing "That the President of the United States is hereby authorized to designate such areas in the Grand Canyon Forest Reserve as should, in his opinion, be set aside for the protection of game animals and be recognized as a breeding place therefor."

Section 2 of this act provides, "That when such areas have been designated as provided in Section 1 of this act, hunting, trapping, killing, or capturing of game animals upon the lands of the United States within the limits of said areas shall be unlawful, except under such regulations as may be prescribed from time to time by the Secretary of Agriculture; and any person violating such regulations or the provisions of this act shall be deemed guilty of a misdemeanor, and shall, upon conviction in any United States Court of competent jurisdiction, be fined in a sum not exceeding \$1,000, or by imprisonment for

a period not exceeding one year, or shall suffer both fine and imprisonment, in the discretion of the court."

Section 3. "That it is the purpose of this act to protect from trespass the public lands of the United States and the game animals which may be thereon, and not to interfere with the operation of the local game laws as affecting private, state, or territorial lands."

The extension of the Game Preserve to include the land south of the Grand Canyon is considered imperative in order to protect the game now in existence. There are a few deer, wild turkeys, and grouse, and occasional small bunches of antelope in the vicinity of Cataract Canyon. This country is gradually becoming more and more accessible to hunters. Wild animals have become almost extinct, and the proclamation aims at the protection of the little game which remains.

The Grand Canyon, one of the scenic wonders of the world, has become very popular with tourists and visitors in the West owing to the ease of access and betterment of accommodations afforded by the various hotels along the rim. The protection of the game will add to the interest of tourists, and it is hoped that in the course of time the wild animals may become abundant.



Arizona's Mountain Forests

ARIZONA has the reputation of being a dry, hot country, and much of it justifies this reputation. Those thoroughly acquainted with the territory know, however, that there are mountains in Arizona, and on these mountains precipitation in the form of both rain and snow is surprisingly high. For example, Mt. Graham rises from the desert in southeastern Arizona to an altitude of over 10,000 feet, and its steep

slopes are heavily timbered with Douglas fir, western yellow pine, and Engelmann spruce.

These timbered mountains are blessings to the people of the territory in more ways than one. Streams in which the flow is regulated by the forests run down into the desert where every drop of water is used for irrigation. The forests also supply the people of the region with material for building their houses, for fencing, and with timber.

The timbered portion of Mt. Graham is in a National Forest. This means that the timber can be used, but cannot be abused. For example, the Government has sold to the Mt. Graham Lumber Company, the timber on an area which is estimated to yield 950,000 board feet, and the company is now cutting and sawing it and supplying the agricultural community in the valley of the Gila River with lumber, and the mines of the Globe mining district with timbers.

The company's mill is high up on the mountain side in a little opening in the dense timber. Here, one and a half miles above sea level, the logs are sawed into lumber and a flume seven and one half miles long carries the sawed lumber down through the rough canyon of Ash Creek to the base of the mountain where it can be hauled direct to the ranches where it is to be used, or loaded on cars and shipped to the mines. A flume in Arizona seems out of place, but there is plenty of water on Mt. Graham with which to operate it, and there always will be, for the Forest officers allow only carefully selected trees to be cut, and there will always be a good forest cover on the mountain which will protect the stream flow and supply timber for the future.



Soldiers Extinguish Fire in Arizona National Forest

A STORY of prompt action in suppressing a dangerous fire in the Garces National Forest, Ariz., is told in the three following dispatches which

passed between Supervisor Roscoe G. Willson, of the Garces National Forest, Ariz., and Clyde Leavitt, chief of the office of organization, United States Forest Service, at Washington. Cooperation between the different branches of the Government in administering and protecting the public forest domain is one of the means by which the tremendous annual fire losses have been made a thing of the past.

"Nogales, Ariz., July 5, 1908.

"Forester, Washington, D. C.

"Fire in Tanner Canyon, Huachuca Forest. Assistance troops requested post commandant Fort Huachuca.

"WILLSON."

"Washington, July 6, 1908.

"Willson Nogales, Ariz.

"War Department states Commandant Fort Huachuca instructed furnish all possible assistance extinguish Tanner Canyon fire.

"LEAVITT."

"Nogales, Ariz., July 7, 1908.

"Forester, Washington, D. C.

"Commandant Fort Huachuca wires me fire extinguished by soldiers.

"WILLSON."



Insure Timber Supply for Montana's Mines

IT IS an old story in Montana that the first information in regard to the Butte copper mines was a message to Marcus Daly, which read, "Cattle on the hills are looking well." The mines have more than justified this message, and to-day Butte is known as the greatest copper-producing town in the United States, if not in the whole world. The streets of Butte to-day are alive with teams hauling ore from the mines to the railroad, and timber from the railroad to the mines, for a mine produces a vacancy made by removal which must be partially filled with timber or the mine will cave in, and cannot be worked.

Butte uses 200,000 mining stulls annually. About three-fourths of this

number are secured from the Deerlodge National Forest west of the city. The Allen Company has purchased from the Government the timber which the Forest officers think can be removed with safety to the forest on an area of about 8,000 acres, and it is estimated that they will secure about 50,000,000 feet, board measure, under this one contract. The company also supplies the smelter at Anaconda with converter poles and small cordwood to whomever has need for it. By the time the sale is completed, the Government will have received more than \$250,000 for the timber on this 8,000 acres, and the forest will still be left in a condition to produce more timber for the future needs of the Butte mines and other Montana industries.

The timber is almost wholly lodgepole—a tree of small size, at best, but large enough to supply stulls, lagging, and converter poles. The trees form a dense forest of nearly even sized trees. This renders it impossible to take out only the larger trees, and the Government foresters are allowing the cutting of narrow strips clean, while from the intervening strips of timber left standing only the dead and diseased trees are taken. After a strip is cleared, it will be seeded up with young trees from the strips of timber left standing on either side, and only when this has been completed, probably between ten or twenty years from now, will the remaining timber be cut. When it is cut, the trees then growing on the strips which are now cut clean, will seed up the newly cut areas, and the whole forest will be started afresh.

In this forest as in every other, the greatest danger to the program planned by the foresters is fire, but in the present cutting every precaution is taken to lessen this risk. The brush from the tops of the trees is being piled, and later, when the ground is wet or covered with snow, the piles are burned under the direction of a forest officer. With lodgepole pine this brush burning is also an aid in securing seedlings, for little trees are best started on an area where the mineral soil is exposed. Com-

plete disposal of the brush leaves nothing on which a forest fire may gain headway, and, safe from this greatest danger, the forest is left to supply wood for the future and to regulate the flow of the streams which drain it, and meanwhile, the great mining industry of Butte is securing the timber it must have if it is to continue.



Production of Precious Stones in the United States

THE total value of the precious stones produced in the United States during 1907 is placed by the Geological Survey at \$471,300, as compared with \$208,000 in 1906. This great increase is due chiefly to a very large output of sapphire in Montana, of both the blue and the variegated variety. The total production of sapphire in the United States for 1907 is estimated at \$229,800. Tourmaline is second in importance, and is placed at \$84,120. Among other important gems produced were chrysoprase, to the value of \$45,500; californite, \$25,000; turquoise, \$23,840; spodumene gems (kunzite and hiddenite), \$14,500; varicite, utahlite, and amatrice, \$7,500; rose quartz, beryl, and aquamarine, and garnet, each over \$6,000.

A new gem mineral—benitoite—has been added to the list of known precious stones. This is a titanosilicate of barium, having a blue color and a high refractive index. It is found in San Benito County, California. The reopening of the emerald-hiddenite mine in Alexander County, North Carolina, during 1907, is of interest since the supply of hiddenite for jewelry has become very low.



Body of Slain Forester Recovered

A CABLE from Manila to the Bureau of Insular Affairs states that the bodies of H. D. Everett and T. R. Wakeley have been found and are being brought to Manila for burial. This

report confirms the rumor which reached the United States the latter part of June to the effect that Everett and Wakeley, together with four Filipinos, had been murdered by natives while crossing the Island of Negros. The party had been missing for six weeks at the time the report was received of the assassination.



H. D. EVERETT

Mr. Wakeley was a native of Chicago and was acting as Superintendent of the native schools in the Island of Negros. Everett was a graduate of the literary department of Cornell University and of the forestry department of the University of Michigan. He entered the Forest Service in 1904 and was engaged in various lines of forest work throughout the United States during the succeeding two years, when, at his own request, he was transferred to

the Philippine Bureau of Forestry. Here he received rapid promotion until he became assistant director of the Philippine Bureau of Forestry. The three years which he had contracted to remain in the Philippines had nearly expired and he had just decided to remain with the work another year just before starting for Negros. As part of his official duties, Everett had charge of forestry matters in five islands of the Philippine group, including the Islands of Panay, Negros, Cebu, and Bobol. The party consisting of Everett, Wakeley, and the four Filipinos were engaged in surveying and mapping the Island of Negros and in making an investigation of its natural resources. As soon as the report of the murder of the party reached Manila, Capt. George P. Ahern, Director of the Philippine Bureau of Forestry, started out with a party to make an investigation. The cable just received by the Bureau of Insular Affairs states the result of Captain Ahern's trip.

Everett was a man of unusual ability and his death will be a serious blow to the cause of forestry in the Philippines. He is the son of O. M. Everett, of Malone, N. Y., and was born in 1880.



Declares for Government Regulation

THE Delta County, Colo., Republican convention in its platform declares for "Government regulation as against Government ownership. Liberal appropriations for the improvement of waterways and harbors, under a general plan that shall be comprehensive and just to all portions of the country, the conservation of our natural resources by a proper and effective regulation of their use; liberal provisions to continue the work of reclaiming arid agricultural lands of the West."



THE VALUE OF NATURAL SCENERY

By J. HORACE MACFARLAND, President American Civic Association

Address Delivered at the White House Conference, May 14, 1908

I URGE this august and influential assembly to consider the essential value of one of America's greatest resources—her unmatched natural scenery.

It is well that we should here take full account of the peril to our national prosperity, indeed to our very national existence, which lies in further wasteful disregard of our waning resources of forest and mine, of water and soil. By the possibilities of conservation here discussed, the mind is quickened, the imagination fired. But the glory of the United States must rest and has rested upon a firmer foundation than that of her purely material resources. It is the love of country that has lighted and that keeps glowing the holy fire of patriotism. And this love is excited, primarily, by the beauty of the country. Truly inspired is our national hymn as it sings—

“My native country, thee,
Land of the noble, free,
Thy name I love;
I love thy rocks and rills,
Thy woods and templed hills:
My heart with rapture thrills
Like that above.”

Paraphrasing a recent utterance of Mayor McClellan upon city beauty, I insist that

“The country healthy, the country wealthy, and the country wise may excite satisfaction, complaisance and pride, but it is the country beautiful that compels and retains the love of its citizens.”

We cannot destroy the scenery of our broad land, but we can utterly change its beneficial relation to our lives, and remove its stirring effect upon our love of country. We can continue to convert the fairest land the sun shines upon into a desert of ugliness. Indeed, we are abundantly able to outdo the Sahara itself in desolation, for that vast waste, so singularly like the United States in contour and extent, and once, geologists insist, as well wooded and watered as was our favored land a century ago, has somber dignity in its barrenness—a dignity completely absent from our civilized Saharas of culmbank and ore-dump, from timber slashing and filth-filled river.

Scenery of some sort will endure as long as sight remains. It is for us to decide whether we shall permanently retain as a valuable national asset any considerable portion of the natural scenery which is so beneficently influential upon our lives, or whether we shall continue to substitute for it the unnatural scenery of man's careless waste. Shall we gaze upon the smiling beauty of our island-dotted rivers, or look in disgust upon great open sewers, lined with careless commercial filth, and alternating between disastrous flood and painful drought? Are we to consider and hold by design the orderly beauty of the countryside, or permit unthinking commercialism to make it a horror of unnecessary disorder? Is the Grand Canyon of the Colorado to be really held as nature's great temple of scenic color, or must we see that temple punctuated and profaned by trolley poles? Shall we hold inviolate all the glories of the Yosemite, or are we to permit insidious corporate attacks upon its beauty under the guise of questionable economics? Shall the White Mountains be for us a great natural sanitarium, or shall they stand as a greater monument to our folly and neglect?

It is certain that there has been but scant thought given to scenic preservation hitherto. I remember the contempt with which a lawyer of national renown alluded to the absurdity of any legislation by Congress in preservation of scenery, when, in its wisdom, that body chose to give a measure of temporary protection to a part of Niagara's flood.

Indeed, one of the potent forces of obstruction to the legislation now demanded by the country in scant protection to the almost destroyed mountain forests of the East has expressed itself in a contemptuous sneer at national expenditures for the preservation of scenery!

We meet in a historic place, in a historic city. The Father of our Country was not only greatest in war and in statesmanship, but one of the greatest of his time in esteem of natural beauty, and in the desire to create urban beauty in what he wisely planned as the Federal City. George Washington loved dignified beauty, and the wisdom of his plan has resulted in making a national capital not only admirable in its adaptation to the public needs, but destined, as his plans are carried out, to be beautiful beyond compare.

What is the effect of the scenic beauty of Washington upon the citizens of the nation who come here? Is not their pride awakened, their patriotism quickened, their love of country increased by the dignity of man's effort; for beauty here? Consider wealthy Pittsburg, busy Cincinnati, proud Chicago, with their wasteful smoke, their formless streets, their all-pervading billboards and grime—would one of these serve to stimulate love of country as the national capital?

No, the unthinking and ofttimes unnecessary ugliness of civilization does not foster patriotism, nor does it promote the health and happiness which are at the very basis of good citizenship. When, in looking over the horrors of industrial civilization, William Morris urged humanitarian effort

"Until the contrast is less disgraceful between the fields where the beasts live and the streets where men live,"

he brought out a bitter truth. We have made our cities ugly, for the most part; but we are learning the basis of happy citizenship, and, while we cannot altogether make over these centers of population, we are bringing into them the scenic suggestion as well as the physical facilities of the open country, in the parks. In these parks lies the answer to the ignorant contempt for scenery to which I have alluded; for it is incontrovertible that peace and health and good order are best fostered in the parks including the most natural scenic beauties.

Mr. Chairman, there is, too, a vast economic reason for jealously guarding all of our scenic heritages in America. Visiting a quiet Canadian community on the shore of Lake Ontario a few days since, I was impressed by the number and the beauty of the summer homes there existing. Inquiry brought out the astonishing fact that they were almost exclusively owned by residents of a certain very wealthy and certainly very ugly American city, where iron is king. The iron manufacturers flee from the all-pervading ugliness they have created, and the money earned in complete disregard of the naturally fine scenic conditions about their own homes is used in buying scenic beauty in a foreign country. Perhaps a certain form of protection is here suggested!

It is authoritatively stated that the tourist travel tribute paid annually to Europe exceeds a half-billion dollars, of which vast sum America contributes a full half, getting back a far smaller sum in return travel from all the world. No one will suggest that there is travel to see ugly things, or to look upon wasted scenery, in Europe. No, this vast sum is expended almost entirely in travel to view agreeable scenic conditions, either natural or urban. The lumber king leaves the hills he has denuded into piteous

ugliness, and takes his family to view the jealously guarded and economically beautiful Black Forest of Germany. The coal operator who has made a horror of a whole country, and who is responsible for the dreadful kennels among the culm-banks in which his imported labor lives, travels with his gains to beautiful France, and he may motor through the humble but sightly European villages from whence came his last invoice of workers.

Every instinct for permanent business prosperity should impel us not only to save in their natural beauty all our important scenic possessions, but, also, to fully safeguard the great and revolutionary development almost certain to follow this epoch-making conference. We are assured by experience that the use of our great renewable resources of soil fertility is attended with the continuance of beautiful scenic conditions. The smiling farm, the blooming and glowing orchard, the waving wheat-fields, the rustle of the corn—all these spell peaceful beauty as well as national wealth which we can indefinitely continue and increase.

Can we not see to it that the further use of our unrenewable resources of minerals and primeval forest is no longer attended with a sad change of beautiful, restful, and truly valuable scenery into the blasted hillside and painful ore-dump, ugly, disturbing and valueless?

The waters of our streams must furnish the "white coal" of the future, and electrically turn the wheels of commerce in smokeless economy. Such a change can consider, retain, and sometimes increase the beauty of the scenery; or it can introduce the sacrilegious ugliness of which the American gorge at Niagara is at present so disgraceful an example. The banks of the waterways we are to develop can be made so pleasing as to attract travel, rather than repel it, if we care for this land of ours as a place to dwell in, rather than to flee from.

We cannot, either, safely overlook the necessity for retaining not only for ourselves, but for our children's children, at least a portion of God's glory of mountain and vale, lake, forest, and seaside. His refuge in the very bosom of nature, to which we may flee from the noise and strain of the marketplace, for that renewing of spirit and strength which cannot be had elsewhere. True, we can continue and expand our travel tribute to the better sense of the Eastern World, but that will not avail our toiling millions. "Beauty for the few, no more than freedom or education for the few," urges William Morris, and who shall say that such natural beauty of scenery as we have is not the heritage of all, and a plain necessity for good citizenship?

Every one of us recognizes the renewing of strength and spirit that comes from even a temporary sojourn amidst natural scenic delights. The President has but just returned

from a "week-end" visit to his castle of rest in the Virginia hills. Could he have had equal pleasure in Hoboken? Mr. Carnegie's enterprises built dreadful Homestead, but he finds the scenery about Skibo Castle much more restful!

Who of us, tired with the pressure of twentieth century life, fails to take refuge amid scenes of natural beauty, rather than to endeavor to find that needed rest in a coal-mining village, or in the heart of some sordidly ugly timber slashing? The most blatant economist, who sneers at the thought of public beauty, accessible by right to all, is usually much interested in private beauty of scenery, of home and of person if accessible to him alone! Selfishly and inconsistently he recognizes in his own use the value of the natural resources he affects to despise.

I am convinced that the vast majority of my countrymen hold deep in their hearts sentiments of regard for the glorious natural beauty of America. If to my inadequate words there be any response among those here present, may I but hint at some things that might well result?

First, we must hold inviolate our greater scenic heritages. All the nations visit the Falls of Niagara as the wonder of the Western World, yet we are even now engaged in an attempt to see how closely we can pare its glories without complete destruction. Eminent authorities warn us that the danger line is passed, and that recurrence of a cycle of low water in the Great Lakes may completely extinguish the American Fall. A hundred other water powers in New York and Ontario world together give as much wheel-

turning electric energy, but all the world cannot furnish forth the equivalent of Niagara in beneficent influence upon the minds of men, if held as a scenic heritage. The glory of Niagara to-day hangs by a hair, and millions of incorporated private money seek covetously to cut the hair.

The National Parks—all too few in number and extent—ought to be held absolutely inviolate, as intended by Congress. Intrusions for questionable water-supply needs, against the unselfish protests of those whose love of country cannot be impugned, should not be permitted.

The scenic value of all the national domain yet remaining should be jealousy guarded as a distinctly important natural resource, and not as a mere incidental increment. In giving access for wise economic purposes to forest and range, to valley and stream, the Federal government should not for a moment overlook the safeguarding to the people of all the natural beauty now existing. That this may be done without in any way preventing legitimate use of all the other natural resources is certain.

The Governors of sovereign states here assembled, the many organizations here represented, possess the power and have the opportunity to so change and guide legislation and public opinion as to foster the underlying desire for public beauty, both natural and urban. We have for a century stood actually, if not ostensibly, for an uglier America; let us here and now resolve, for every patriotic and economic reason, to stand openly and solidly for a more beautiful, and, therefore, a more prosperous America!



CONSERVATION OF POWER RESOURCES

By H. ST. CLAIR PUTNAM, LL.B., E.E., Member A. I. E. E.

Consulting Electrical Engineer (New York)

Address Delivered at the White House Conference, May 14, 1908

WITHOUT disparaging other aspects of our progress, it is not too much to say that our time is preeminently the Age of Power. This applies to the world at large, but especially to the United States. Our population is increasing with unprecedented rapidity, but our mineral production is increasing so much more rapidly that this is not inaptly styled "the Age of Metal." Steel, copper, and wood are combined in mechanical devices at a rate increasing so much more rapidly than ore production that we may be said to live in the Age of the Machine; yet that aspect of modern life which most impresses the student of development is the increasing use of mechanical power through

the development of prime motors and the utilization of new power sources. Rapidly as our population advances, it is outrun by metal production, and that in turn by machine building; yet our most rapid progress—the feature in which our advancement exceeds all others—is in the development and use of Power.

Historically considered, the utilization of our power resources has undergone three characteristic phases of development.

In the first, power was produced directly by natural resources such as falling water and wind, and its use necessarily was limited to those places where these natural forces were found. This led to the early

growth of industrial communities in such favored localities as is illustrated by the prosperity of the early manufacturing establishments of New England, grouped about easily available water powers, and in this country it held ascendancy in the manufacturing industries until about 1870.

The second phase was characterized by the development of the steam engine which rendered practicable the utilization of the stored energy in fuel as a source of power. During this period the development of coal mines and rapid growth of our railway systems imparted a tremendous stimulus to commercial enterprises. Proximity of water powers was no longer controlling, and factories were established at points selected by reason of the availability of raw material, labor, transportation facilities, and markets, as well as power supply. As in the first period, however, the power necessarily was used where developed and the size of the plant was limited to the requirements of the individual user.

Electrical transmission of power is the new art which now is resulting in another and radical change in methods of utilizing our power resources, permitting, as it does, development whether by water power or by steam at points most convenient and economical and transmission to the consumer in form adapted to great variety and convenience and use. This new development in applied science calls for reappraisal of the sources from which our power is derived. The size of the power plant is no longer limited to the requirements of the individual user, but the power for entire communities can be supplied from a single station. The enlargement of this field of work newly opened by the electric transmission of power from great distances is now in active and practical development. As a result rapid changes are taking place in the methods of using power. New economics are possible of accomplishment and the resulting effect upon the conservation and utilization of our power resources is of the greatest importance.

Where power is developed from the combustion of coal, wood, oil or gas, our natural resources as such are destroyed and they cannot be replaced, excepting to a limited extent in the case of wood and similar products. The supply of natural oil and gas is limited and uncertain and the amount available is required for special industries. The coal production of the United States for the year 1906 was 414,157,278 tons; for 1907, about four hundred fifty million tons. If the production of anthracite coal is continued at only its present annual rate the supply will be exhausted in sixty to seventy years. Since the beginning of our coal industry the production has doubled approximately every ten years. Assuming that this rate of increase cannot be maintained, but will become constant in about one hundred fifty years, it is estimated that the supply of bituminous coal

will be exhausted in approximately seven hundred years. But that the coal production should become constant even one hundred fifty years hence, implies that our industries must become stationary, unless other power resources are found. We cannot look forward to such a condition with equanimity. Without coal our domestic and industrial life are inconceivable, and our existence in great cities and crowded communities is impossible unless a substitute is devised. The future welfare of the nation requires that all practicable means be employed for the conservation of the supply of coal.

Where power is derived from water, winds, and tides, only energy otherwise wasted is used. The energy thus extracted is added to our assets instead of being a permanent loss as is the case with the combustion of coal. It is now feasible and practicable to develop water powers, wherever located, for electric power. In the aggregate the available water powers of the nation greatly exceed the present power requirements, but unless there is some curtailment in the rate of our development, our water power resources, while being of great magnitude, will not of themselves solve the problem of our future supply of power. The amount of water power available in the United States is not known. Some partial estimates have been made, but these are necessarily approximate, as exact figures can be obtained only after careful survey and study not only of the existing physical conditions, water flow, and available reservoir capacity, but of the practicable auxiliary steam power that can be profitably installed. The power of Niagara Falls has been estimated, by Prof. W. C. Unwin, at seven million horsepower. A partial estimate of the water powers of the upper Mississippi River and tributaries places the available water power at about two million horsepower. The southern Appalachian regions can furnish a minimum of nearly three million horsepower. Both of these estimates can be greatly increased by including the use of regulation reservoirs and auxiliary steam plants. The water powers of New England are more fully developed than elsewhere in the country, though much remains yet to be done. In the Rocky Mountains and the far West there are immense water power possibilities; in the State of Washington alone there are three million horsepower available. Even approximate data upon which to base an estimate of the total amount of available water power in the country is lacking, though a good start in its collection has been made by the War Department and the Geological Survey with the limited means at their disposal. It is probable that the water power in the United States exceeds thirty million horsepower, and under certain assumptions as to storage reservoirs this amount can be increased to 150,000,000 horsepower or possibly more. Much depends upon whether regulation res-

ervoirs and reserve steam plants are included in the estimate. Both have been demonstrated to be practicable and undoubtedly should be considered in any estimate made of the available water power resources of the country.

Using the smaller figure of thirty million horsepower as an illustration, to develop an equal amount of energy in our most modern steam-electric plants, would require the burning of nearly 225,000,000 tons of coal per annum, and in the average steam engine plant, as now existing, more than six hundred million tons of coal, or fifty per cent. in excess of the total production of the country in 1906. At an average price of \$3 per ton it would require the consumption of coal costing \$1,800,000,000 to produce an equivalent power in steam plants of the present type.

The supply of water power is limited, however, when the rapid rate of increase in our power requirements is considered, and great care, therefore, must be exercised to insure the preservation of our water power resources and to secure the maximum practical development.

Using the data furnished by the census returns of 1900, 1902, and 1905 as a basis, and applying the prevailing rate of increase in the industries included in these reports, and adding an equivalent amount for the steam railroads, it is estimated that the total installed capacity of prime movers in all our land industries for the year 1908 approximates thirty million horsepower.

The average load on steam and other engines is much less than their rated capacity, and, owing to the overlapping of loads, it is probable that the total average load does not exceed one-third or one-quarter of this amount.

During the past thirty years the total amount of power used in our manufactories and other industries, as recorded by the census, has doubled approximately every ten years. The fact that substantially the same rate of increase has existed in coal production, railroad gross earnings, freight ton-mileage, passenger mileage and the value of agricultural products as well as in total power consumption, is a striking demonstration of the close inter-relation and mutual dependence of these great factors which, in the aggregate, measure the industrial progress of the nation. Yet the records of power used in small units are far from complete.

We cannot foretell how long the present rate of increase in our industrial enterprises will continue. This will be determined by the general laws which govern industrial development and by the increase in wealth. It is clear, however, that if our power resources are exhausted or wasted, the result will be disastrous.

Of the total estimated power at present produced by prime movers, about twenty-six million horsepower is produced by steam engines, three million horsepower by water motors, and seven hundred thousand horse-

power by gas and oil engines. These figures emphasize the present position of the steam engine in our industrial development, and the relatively much less important place now occupied by water power.

Of the total thirty million horsepower, including the railroads, used in the country, it is estimated that nine million horsepower, or thirty per cent., is now utilized electrically. This remarkable growth has been accomplished in twenty-five years. The use of electric power at the present time is being doubled approximately every five years, as contrasted with the phenomenal doubling of the total power every ten years. If the present rate of increase is maintained, electrically applied power will equal or exceed the power mechanically applied in 1920. This great growth is due to the convenience, earning capacity, and economy resulting from the use of electrically applied power. The significance of this remarkable increase in the use of electric power in manufactories and other industries lies in the market thus provided for the utilization of our water powers, wherever located and whatever their magnitude.

Where coal is the source of power, electric transmission and distribution greatly reduce the amount burned to perform given mechanical work. This results from the substitution of a few large and highly efficient boilers and engines for a larger number of relatively small and uneconomical ones and from the introduction of plant economies and skill in operation not attainable in the smaller plants. A material saving is effected also in the application of the power directly to the work through motors instead of indirectly through inefficient countershafting and belting.

A further material gain also results from the fact that a large plant carrying the load formerly carried, for example, by one hundred small plants is operated under conditions more nearly approximating uniformity of load, and therefore at higher economy.

Greater economy can be obtained, even in our large plants, through the more general use of so-called fuel economizers, superheated steam, higher vacuum, and better combustion under the boilers. We may expect still higher efficiency from the development of larger boiler and engine units. These economizing appliances, which are relatively unimportant in small plants, become of great importance in large plants, and will have still greater influence on steam practice as the price of fuel increases and the cost of capital decreases.

This discussion would be incomplete without mention of the great possible fuel economy that may result from the use of gas and other similar engines. Though engines of this character ante-date the use of the electric motor their development has been slow, and they occupy a relatively unimportant place as power producers. The

ordinary steam engine utilizes not more than four or five per cent. of the heat energy in coal, and our best modern steam electric plants show a heat efficiency not exceeding ten or twelve per cent. With the gas engine and producer gas the heat efficiency can be more than doubled, and still higher efficiency seems probable with higher compression or through the use of other possible improvements. This is a most promising field for development, and it is entirely possible that the gas engine may revolutionize our methods of using fuel for the production of power.

Beyond these gains, which may be considered well within the limits of possible attainment by present knowledge, there stands the theoretical prospect of still greater economies, the possibility of which cannot be denied so long as methods employed in developing energy from coal results in a waste of from seventy-five to ninety-five per cent. of the potential energy which nature has stored in the coal. But the science of the present time does not permit us to assume any radical increase in efficiency of fuel engines beyond the limits which I have indicated and our only safe course is to base our estimate upon the progress of the present time with such reasonable allowance for improved economy as is dictated by recognition of progress of the art along lines now within the horizon of possible science.

Where the water power is the source of supply, electricity promotes economy for reasons identical with the foregoing, except that absence of fluctuation of load is relatively less important, but the great gain which results from electric transmission is the utilization of water powers remote from power markets. Where several water powers along a stream are developed it becomes possible to utilize, in conjunction with the larger and more cheaply developed powers, others which, considered independently, could not be utilized to advantage.

Prior to 1870 the use of water power in manufactures exceeded that of steam power. Water power expressed in percentage of the total power employed has since steadily declined, falling from 48.3 per cent. in 1870 to 11.2 per cent. in 1905. During the corresponding period steam power increased from 51.8 per cent. in 1870 to 78.2 per cent. in 1900. The census of 1900 showed a marked falling off in the rate of increase in the percentage of steam power used as compared with the rate prior to 1890, and this was accentuated in the census of 1905, when the percentage of steam power fell to 73.6 per cent. of the total. This check to the ascendancy of directly applied steam power was due to the introduction of electric power. In 1890 electric power was negligible. In 1900 it constituted 4.8 per cent. of the total. In 1905 this had increased to 11.8 per cent.—a marvelously rapid growth when the aggregate increase of over one million horsepower in five years is considered. If the present rate of increase prevails until

1910 electric power will have reached eighteen per cent. of the total and steam power will have dropped to sixty-eight per cent. If the same rate of increase is maintained until 1930, electric power as applied to the manufacturing industries will exceed the amount of steam power applied direct.

The tendencies illustrated by the changes that have taken place in the methods of utilizing power in manufacturing, apply generally to other industries. The increasing use of power is phenomenal; the steam engine as a source of power is thus far paramount in them all, but the percentage of electrically applied power is increasing at nearly double the rate of increase of the total power used.

The extraordinary growth of the electric lighting industry is familiar to all. Unfortunately the results of the special census of 1907 are not yet available, but the indications are that the five years that have elapsed since the previous census will show phenomenal growth. During these five years the gross sales of the great electric manufacturing companies have doubled, and the proportion of the output consisting of electric power apparatus and generating units of large size has greatly increased. An influential factor in the growth during this period has been the rapid development of long distance hydro-electric power transmission plants.

Since the displacement of horse and cable cars in the cities a few years ago, electric railways have been extended to suburban and interurban districts and are rapidly forming a network over the entire thickly settled portions of the country. In the nature of their traffic many of these roads are scarcely distinguishable from steam railroads, and many railroads are using them as feeders. In a few cases railroads have converted steam operated branches into electric lines.

A beginning is being made in the electrification of our steam railroads. The New York Central, the Pennsylvania, the Long Island, the New York, New Haven & Hartford, the Grand Trunk, the Northern Pacific, the Erie, the Southern Pacific and others have electrified portions of their lines, and most of these are now in successful operation. Many of these roads are extending the electric zone. Thus far most of this work has been induced by terminal requirements, tunnels, heavy grades or other special conditions which emphasize the advantages to be derived from electric operation. The increase in capacity, convenience, and greater earning power as well as the economies resulting from electric operation will stimulate the electrification of steam railroads, just as these factors have stimulated the use of electric power in other industries. The problem presented is larger because of the necessity of interchangeability of equipment, and the development must necessarily be gradual on account of the magnitude of the interests and the large capital expenditures involved. The

railroads are among the largest consumers of fuel, and electric operation, exclusive of the use of water powers, would reduce the coal consumption to less than one-half of that required for similar operation with steam locomotives.

During the past few years, there has been renewed interest in water powers on account of the practicability of their use for the generation of power and the electrical transmission of this power to distant markets. The great hydro-electric development at Niagara was the first large enterprise of this character and has demonstrated its practicability. The census of 1905 gives a partial list of long distance hydro-electric plants developing power aggregating six hundred horsepower, and this list can now be largely increased. Our most desirable water powers are being absorbed rapidly, and it becomes important, therefore, for us to take stock of our water resources and formulate plans for their control and proper utilization.

In the improvements that have been made on navigable rivers too little attention has been given to the development of the incidental water powers. On some waterways, as in several instances on the Mississippi, immense sums of money have been appropriated and expended on especially difficult portions of the river. If this money could have been available in large amounts, instead of by dribblers over periods of many years, water powers of great value could have been developed and the navigation effectively and permanently improved. Unfortunately this has not been our policy. Too often the appropriations have been inadequate for carrying out the work as it should be done, and frequently the work has not followed any well-digested plan.

With the data at hand it is impossible to make an accurate estimate of the amount of power that can be developed incidentally to river navigation. A partial estimate of the power developed at existing Government locks and dams places the amount at 1,600,000 horsepower. This is based on the mean low water discharge for three months. The subject should receive careful consideration. Improvements in navigation should be made only after thorough study of the possibilities of power development. On the other hand, many water powers are on streams that are navigable, or are capable of canalization, and these streams should be developed for power purposes only after careful examination has been made of the possibilities of the stream forming a link in the system of inland waterways.

There are many streams that are not now navigable, or are navigable for only a portion of the season, that can be canalized and converted into streams of great commercial value. The use of our waterways for both power development and navigation causes no conflict; these uses are in fact co-related and their interests harmonious. Where it is necessary to place a dam across a stream to de-

velop power, the slack water so produced, with the addition of locks, renders otherwise impassable stretches of river available for navigation. Every water power development is vitally interested in obtaining a uniform flow of water. This exactly meets the requirements of navigation. The approximate realization of regularity of flow can be attained only by the construction of head-water regulating reservoirs and the preservation of our forests. Every water course that is improved for the production of power and for navigation produces, therefore, vigorous self-interested allies in the cause of forest preservation, head-water regulation and the maintenance of conditions which are favorable to both interests.

Considerations which affect the use of our rivers and streams, as sources of power and for navigation, apply also to canals. Heretofore, canals built for transportation purposes have not been used, to any great extent, for the development of power. In some cases this has been on account of the limited supply of water, but more frequently it has been due to the great difficulty experienced by the animals in towing boats against the rapid current produced in the canal by the flow of water to the water wheels. In recent tests it has been demonstrated that canal boats can be towed by electric towing machines at a much lower operating cost than is possible with animals and that operated in this manner the speed can be greatly increased. The first cost of electric equipment is relatively large, but the change to electric towing will pay handsomely when the volume of traffic is sufficiently large. The traffic required is well within the ultimate capacity of the canal. With electric towing the increase in the rate of current flow introduced by the development of water power on the canal is not a serious impediment to navigation.

There are large areas in the Western States where the soil is of wonderful fertility, but irrigation is essential to the successful growing of crops. The cultivated lands usually lie in valleys and water is carried to them through long and oftentimes wasteful irrigation ditches. In many cases the water could be utilized for developing power on the headwaters of the streams without injury to the irrigation interests, as is illustrated by the excellent work now being done by the Reclamation Service. The development of water power will introduce another party whose self-interests dictates the use of every available method of preserving the volume of water supply, its continuity, and regularity of flow.

In some cases irrigation channels can be converted into canals suitable for at least limited navigation, and where practicable this should be done. Some types of apparatus as now developed for towing canal boats by electricity require but little space along the side of the ditch and can be installed, usually, without additional grading wherever an irrigation ditch can be constructed. Electric tow-

ing cannot be economically practicable, however, unless the traffic reaches a considerable volume. With animal power the additional capital investment is small and is proportional to the amount of business handled. With electric towing the first cost is large and manifestly sufficient traffic must be secured to meet the capital charges before profits can be realized.

What has been said upon the subject of irrigation canals applies to the development of the water supplies for our cities. This work, like irrigation, should be carried out so as to develop the maximum water power possible without injury to the water supply.

The preservation of the purity of water for domestic use is of great importance to the welfare of the nation. A consideration of this subject, as well as of navigable waterways, canals, irrigation and water powers, emphasizes the absolute necessity of competent supervision of the natural water resources of the country.

The flow of water in many streams annually fluctuates between wide limits. The low water periods limit the profitable water power development and the high water periods often cause disastrous floods. On most streams the average rate of flow for the year is many times the minimum flow. It is possible in some cases to utilize a flow approximating the average by constructing controlling reservoirs on the headwaters of the stream. Our Great Lakes form a natural reservoir of this character for the Niagara River. The Upper Mississippi has great natural reservoirs, which assist in regulating its flow and which easily can be made very effective in its control. The notable floods of the Ohio River can be greatly reduced by the construction of controlling reservoirs on its headwaters, which will result in the saving of millions of dollars now annually destroyed. On a stream which I recently investigated the minimum flow furnishes but two hundred horsepower. The construction of a storage reservoir increases the continuous twenty-four hour power that can be utilized to eight thousand horsepower. If storage reservoirs could be constructed on the Susquehanna River, upon which a great water power development is now in course of construction, so as to obtain a uniform flow throughout the year, the available power at this site would be increased from a minimum of 30,000 horsepower to 200,000 horsepower. While it is impracticable to construct reservoirs capable of holding back all flood waters it is nevertheless certain that material gain would result from well-directed efforts along the lines suggested.

On account of the great annual fluctuations now existing in stream flow it has been found profitable to install steam plants supplementing the water power during seasons of low water. This method, on account of its expense, greatly handicaps the full development of our water powers and increases the

amount that must be charged for the power. Under given conditions the most profitable amount of water power to develop and the best size of steam plant to install can be determined with great accuracy. The reserve steam station need not be located at the water power; in fact, it preferably should be located at or near the market for the power when that is distant, as greater reliability and continuity of power supply is thus secured. Headwater regulation would greatly reduce the necessity for such auxiliary steam plants.

Similarly the water power which can be purchased economically by a prospective customer who already has a steam plant in operation can be accurately determined. This amount depends upon the relative cost of generating different portions of the load by steam as compared with the amount charged for the water power supplied. In its economical application this method of operation works out so that the water power plant carries the steady portion of the load where the coal consumption per horsepower capacity is greatest, and the steam plant is called upon to carry the peaks only where the coal consumption per horsepower is least.

In addition to their reserve function in time of low water or flood auxiliary steam plants and inter-connected plants are valuable as insuring the continuity of power supply. If the lines are run overhead, as they must be for long distance transmission in the present development of the art, all electric transmission plants are subject to occasional short interruptions due to storm, lightning or malicious mischief. It is economical and desirable to tie together two or more plants, thus greatly increasing the reliability of service. If one plant or transmission line fails the others can be pushed to take the load. From an engineering standpoint, and from the standpoint of the engineer as well as the power producer, this method of operation has great advantages.

In 1905 the value of the product of our manufactures amounted to \$16,866,706,985; the total receipts of the steam railroads were \$2,325,765,167.

In manufacturing the value of the product was \$1,152 for each horsepower installed and the yearly wages amounted to \$248 per horsepower.

In the railroad industry the gross receipts amounted to \$555, and the yearly wages to \$224 per horsepower, rated on a basis comparable to that used in the census report covering manufactures.

I have selected these two classes of industry for the reason that they use the bulk of the power and illustrate its tremendous productiveness in increasing our wealth.

These figures emphasize the vast financial importance of our power resources and the necessity of their conservation and their intelligent development. Much can be accomplished by the National Government in connection with irrigation of national lands and

the improvement and preservation of navigable waters. The state governments can greatly assist in this work, within their respective territories.

A reliable census of water resources is greatly needed. The Geological Survey has accomplished much in measuring and recording the flow of streams, but the work done is small as compared with that which remains to be done. Obviously in order that records of this character shall constitute a uniform and safe basis for the very large capital investment which must be made in the future, in order that our water power resources shall be properly utilized and our fuel supplies conserved, they should be made under the immediate direction of the National Government.

The National Government can render great assistance also in the research work which it has undertaken into the better utilization of our fuels. Excellent results have been obtained by the able corps of engineers engaged on this work, but when we consider that we are now utilizing but five or ten per cent. of

the heat value in fuels it is evident that much remains to be done.

Power and transportation are the two great physical bases upon which modern industrial development rests. Without power our methods of transportation must revert to a level with those existing in China. Up to the present time, while Nation and state have regulated, and in some degree aided, in the development of transportation, the power resources of the country have been utilized or wasted by the private individual and the corporation with little hindrance, and still less assistance from the constituted authorities. Next to individual enterprise the most essential factor in the development of our national resources is wise governmental regulation so applied as to insure the vigorous working of individual initiative and at the same time prevent the waste by individuals of that which is vital to our national welfare and to secure in the utilization of our natural resources the highest practicable degree of economy which scientific knowledge and engineering skill can attain.



THE WATER-SUPPLY PROBLEM

Its Solution Found in the Increasing Use of Hydraulic Rams and Similar Engines

ELEVATING and conveying water most economically, efficiently, and under all weather conditions, have, from ages back, been the study of those whose purpose is to solve the problems of supplying man's commodities. One of the most perplexing problems of those isolated from public water, wells, springs, or natural reservoirs, is how and by what simple and practical manner they may obtain an efficient water supply suitable for all necessary requirements.

Irrigation has within recent years, turned arid prairies into fertile fields. The enterprising, hard-working farmer need no longer depend on the mercy of

the weather to bring rain to his crops. He can, by his own ingenuity, supply his fields with water. It is possible for him to irrigate his lands not only by natural gravity, with streams from reservoirs, but, also, by elevating the water to fields above the source of supply. This can be accomplished with hydraulic rams, which are made in sizes sufficiently large to supply the ordinary demand in such cases. Among the pumps extensively used for these purposes are the Rife Automatic Hydraulic Rams, as well as other similar engines, all of which are being used for lifting water above the source of supply. Such a ram is a modern develop-

ment of its ancestor—an old-fashioned type—and is of such ingenious construction that it gives the maximum amount of water from the source of supply. Being a machine of many

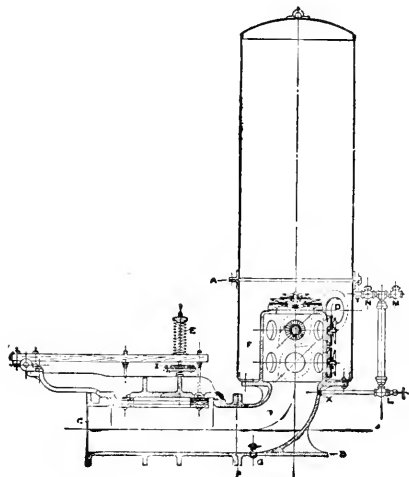

sizes it meets all requirements. It can convey to the housewife what water she needs from a spring any distance from the house; it can supply a whole town with all the water it needs; or it can serve as the agent of conveying to a dry and barren field all the water necessary to irrigate the tract. Such a machine, when once placed to work by falling water—only a fall of two feet is sufficient to convey a stream any distance at an altitude of sixty feet—will run without any further attention day and night, year in and year out, never freezing, never wearing out, and never in need of oiling.

These rams are simplicity itself, and combine the most perfect application of hydraulics known to science. There is nothing to break and nothing to get out of order, and they always deliver an abundant and reliable stream.

A hand pump is out of the question for any amount of work, and a wind-mill runs only in a breeze, and it is worn and subject to repairs, needs oiling, etc. A gasoline engine requires attention, needs fuel and is more expensive. None of these troubles enter into the running of a hydraulic ram, the expense of which operation is *nil*.

This kind of hydraulic ram makes it possible for a number of towns and cities to install a system of waterworks, whereas, under certain conditions, they would have none. All municipalities cannot afford to incur an annual expense of from \$1,500 to \$5,000 for operating a steam plant to run a waterworks, but it becomes very easy for them to lay out about \$10 a year for minor repairs where a hydraulic ram is doing the work. Numerous towns throughout the United States and Canada are using such rams to supply their reservoirs and stand-pipes with water. Fire protection is a most urgent necessity, and, where natural conditions justify it, it is hard to understand how any town can well afford to be without a system of waterworks where the engine in question does the work.

As evidence of the merit found in these machines, it may be stated that the United States Government has adopted some at various points, both for

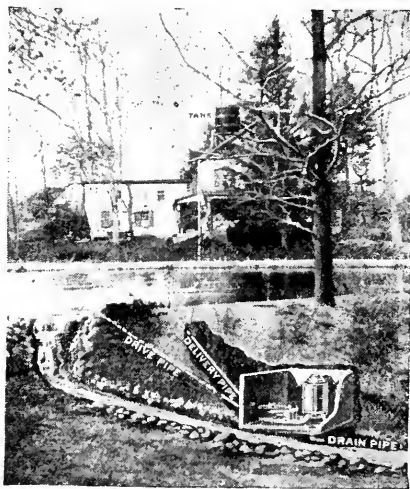

supplying tanks used for fire protection and others for water supply.

The Rife rams, which have now been on the market for nearly fifteen years, are used extensively here and abroad, many having found their way to fields of irrigation in South America, South Africa, and the Hawaiian Islands. The Government operates a number in the Philippine Islands.

Congressional Information Bureau

CLAUDE N. BENNETT, Manager

Attends to business before Congress, the Courts, Patent Office, Interstate Commerce Commission, and all other Departments of the Government at Washington.

Supplies any desired information from the Capital, furnishes advices concerning matters pending in Congress, the Courts or the Departments, and transacts business at Washington for clients anywhere in the world.

Conducts library research along any designated lines.

Has a Legal Department that prepares briefs for lawyers or other clients.

Usefulness demonstrated by ten years' successful experience.

Congressional Information Bureau

BOND BUILDING WASHINGTON, D. C.

This Solar can be used in hazy weather, when other Solars are useless. Used by the U. S. General Land Office.

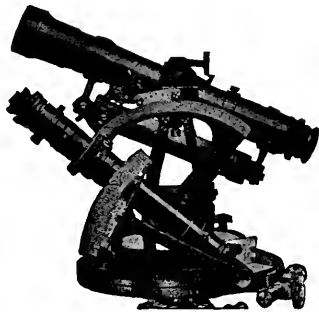

Specifications

Needle $3\frac{1}{2}$ inches long. Graduations $4\frac{1}{4}$ inches long, reading minutes. Power of telescope 20 (with splendid definition, good light, and large field). Variation plate. Level to telescope, clamp and opposing screws. Vertical arc. Fixed Stadia hairs. Extension Tripod. Solar Attachment on side of standards.

Price Complete, \$300

Telegraph and Code Word, Mountsolar

Illustrated Catalogue Upon Application

YOUNG & SONS Philadelphia

The Pompeian Co.



Importers of highest class Refined Pompeian Olive Oil, and manufacturers of Olive Oil Products. Proprietors of

OLIVKRIM

A pure Olive Oil hair vigorator. Not to be confused with tonics, quinine or other "cures." It contains all the health-giving, nourishing properties of pure Olive Oil—a hair food, not a combination of alcohol and drugs.

OLIVE OILS

Our Pompeian Extra No. 1 Lucca Oil is the finest product of Italian Olive Orchards. Analyzed and endorsed by Prof. H. E. Kalusowski, Dean of the George Washington College of Pharmacy, Washington, D. C.

THE POMPEIAN CO.

702 Fifth Street

Washington, D. C.

PLANE SURVEYING

A Text-book and Pocket Manual

By JOHN CLAYTON TRACY, C. E.

Ass't Professor of Structural Engineering
Sheffield Scientific School of Yale University

16 mo, xxvii + 792 pages, illustrated with
line cuts. Morocco, \$3.00

Used in the Yale Forestry School and just
adopted in Pennsylvania Department of
Forestry

Descriptive Circular on Application

JOHN WILEY & SONS

43 and 45 E. 19th Street
New York City

FORESTRY SCHOOLS

can find no better medium through which to make their announcements than

Forestry and Irrigation

It reaches a class of Readers that is reached by no other Publication.

It is *the* Magazine of authority in its special field.

For Advertising Rates, etc., address

Advertising Manager

FORESTRY AND IRRIGATION

1417 G St. N. W.

Room C Washington, D. C.

POWDER POINT SCHOOL, Duxbury, Mass.

Preparatory Course in

FORESTRY

Leading to Biltmore and College Course in the subject. It requires hard, earnest application, and develops appreciation of nature and powers of leadership.

(M. I. T.)

F. B. KNAPP, S. B.

ORCHIDS ORCHIDS

We are the largest Orchid Growers in the United States.

Our Illustrated and Descriptive Catalogue of Orchids is now ready and may be had on application.

Orchid Growers and Importers

LAGER @ HURRELL
SUMMIT, N. J.

The PENNSYLVANIA STATE COLLEGE

A thorough and practical undergraduate course in technical forestry, preparing men for all lines of professional and applied forestry.

Special attention is paid to practical field work in surveying, mapping, and forest measurements. One of the largest of the State Forest Reserves is within a short walk of the college.

For information regarding entrance requirements, expenses, etc., address

Department of Forestry

State College, Penna.

Text Books on Conservation

If you are interested in any of the phases of conservation, read the list of publications carried in stock by FORESTRY AND IRRIGATION

STUDENTS

will find this list invaluable. Let us know what you want. We can fill your order. Address

Forestry and Irrigation

1417 G St., Washington, D. C.

Make Your Unproductive Land Profitable

Don't let a part of your land be idle because of a lack of water. Irrigate it. If there's a running stream or spring on any part of your farm the water can be delivered just where it will do the most good. Simply install a

NIAGARA HYDRAULIC RAM

and start it going. Better than a gasoline engine or windmill. Write for booklet B, and guaranteed estimate. We furnish Caldwell Tanks and Towers.

NIAGARA HYDRAULIC ENGINE CO., 140 Nassau St., New York. Factory: Chester, Pa.

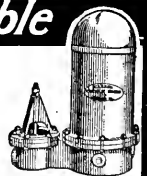

IMPORTANT BOOKS ON FORESTRY

PRINCIPLES AND PRACTICE OF FORESTRY

FOREST MENSURATION. By HENRY SOLON GRAVES, M.A. A complete text book of this important subject and the first written for American Foresters. It deals with the determination of the volume of log, tree, or stand, and with the study of increments and yields. Price, \$4.00

ECONOMICS OF FORESTRY, THE. By B. E. FERNOW. This volume treats of forests and forestry from the standpoint of political economy, and is designed to furnish a trustworthy basis for formulating public policy. Price, \$1.50

FIRST BOOK OF FORESTRY, A. By FILIBERT ROTH. An outline of the general principles of forestry, written in simple, non-technical language, designed particularly for the beginner. Price, \$1.10

PRACTICAL FORESTRY, FOR BEGINNERS IN FORESTRY, AGRICULTURAL STUDENTS, AND WOODLAND OWNERS. By JOHN GIFFORD. A good general description of the principles of forestry with enough technical information to prepare the beginner. Price, \$1.40

HISTORY OF THE LUMBEE INDUSTRY OF AMERICA. By J. E. DEFEBAUGH. The first authoritative work of its kind yet issued, and one which will commend itself alike to the timber owner, lumberman, lumber manufacturer, or merchant, or student of economics. In four volumes bound in half leather. \$5.00 per volume

FOREST PLANTING. By H. NICHOLAS JARCHOW. An illustrated treatise on methods and means of restoring denuded woodland. Price, \$1.50

FORESTRY. (Schwappach.) An English translation of "Forstwissenschaft." Price, 70c

HEDGES, WINDBREAKS, SHELTERS, AND LIVE FENCES. By E. P. POWELL. A treatise on the planting, growth and management of hedges with information concerning windbreaks and shelters. Price, 70c

NORTH AMERICAN FORESTS AND FORESTRY. By ERNEST BRUNCKEN. This volume, expository in its character, is written in a style intended for the general reader, to whom it should convey a good idea of our forests forestry. Price, \$2.00

PRACTICAL FORESTRY. By ANDREW S. FULLER. A treatise on the propagation, planting and cultivation, with descriptions and the botanical and popular names of all the indigenous trees of the United States, and notes on a large number of the most valuable exotie species. Price, \$1.50

PRINCIPLES OF AMERICAN FORESTRY. By SAMUEL B. GREEN. Prepared especially for students in elementary forestry and for the general reader who wishes to secure a general idea of forestry in North America. Price, \$1.50

SEASIDE PLANTING OF TREES AND SHRUBS. By ALFRED GAUT. Illustrated from photographs by FRANK SUTCLIFFE. This is a new volume in the English Country Life Library. Advice regarding selection and management to get satisfactory effects under adverse influence of closeness to seashore. Price, \$1.75

FOREST MANAGEMENT. By C. A. SCHENCK. Describes methods here and abroad to bring the most profit from all investments made in woodlands. Price, \$1.25

FOREST MENSURATION. By C. A. SCHENCK. Treats conditions in U. S. from mathematical and practical standpoint. Price, \$1.25

FOREST UTILIZATION. By C. A. SCHENCK. First treatise on this in U. S. Covers logging, lumbering, sawmilling, cooperage, paper-making, and description of all industries obtaining raw material from American forests. Price, \$1.25

BILTMORE LECTURES ON SYLVICULTURE. By C. A. SCHENCK. Written from author's long experience as forester of the Biltmore estate, where sylviculture has been practiced on a larger scale for a longer time than anywhere else in U. S., and where results become more apparent from year to year. Price, \$2.50

FOREST POLICY. By C. A. SCHENCK. (Second part.) Describes the various States of the Union under following heads: Area; physiography; distribution of forests; forest ownership; use of the forest; forestry movement; forest laws; forest reservation; irrigation. Price, \$1.25

PROFESSION OF FORESTRY, THE. By GIFFORD PINCHOT. A pamphlet containing an address on that subject by Mr. Gifford Pinchot; also an address by Mr. Overton W. Price, on "Study in Europe for American Forest Students," and a list of reference publications for students. Price, 25c

FOREIGN IMPORTATIONS

ENGLISH ESTATE FORESTRY. By A. C. FORBES. An authoritative volume on English forest methods from the pen of a well known forester, that should prove of interest to Americans. Price, \$3.50

FORSTWISSENSCHAFT. (Schwappach.) Price, 60c

MANUAL OF FORESTRY. (Schlich.) Five volumes, complete, or separately, as follows (price, complete, \$18.80):
Vol. I. "FORESTRY POLICY IN THE BRITISH EMPIRE." Price, \$2.40
Vol. II. "SYLVICULTURE." Price, \$3.20
Vol. III. "FOREST MANAGEMENT." Price, \$3.60
Vol. IV. "FOREST PROTECTION." Price, \$4.80
Vol. V. "FOREST UTILIZATION." Price, \$4.80

This is perhaps the most authoritative work that has been issued on the technical side of forestry, translated from the German.

WOOD. By G. S. BOULGER. An important new book for arboriculturists and forestry students. A manual of the natural history and industrial applications of the timbers of commerce. Cloth, \$2 Illustrations. Price, \$3.60

FAMILIAR TREES. By Prof. G. S. BOULGER. Written by an eminent botanical authority, yet couched in language easily understood. The coloured plates are the work of celebrated artists, and are truthful and trust worthy in every respect. A special feature is the series of photo-micrographic illustrations of sections of woods. Three volumes. Price, per volume, \$1.50

DENDROLOGY, BOTANY, AND IDENTIFICATION OF SPECIES

MANUAL OF THE TREES OF NORTH AMERICA (exclusive of Mexico). By CHARLES SPRAGUE SARGENT. A volume that presents in convenient form and with excellent illustrations, authoritative information concerning the trees of North America. It is written in a manner that enables the reader to readily find to what family or species any particular tree belongs. Price, \$6.00

AMERICAN WOODS. By ROBEYN B. HOUGH. A new departure in the publication of an authoritative work illustrated with actual wood sections of the various species described. Three are given of each, viz.: radial, transverse, and tangential. Issued in ten parts, per part Price, \$5.00

HANDBOOK OF THE TREES OF THE NORTHERN U. S. AND CANADA, EAST OF THE ROCKY MOUNTAINS. By ROBEYN B. HOUGH. Pictorial description of 2000 to 2500 pages to each species; photo-engravings of trunk, leaves, flowers or fruit, section of wood, and map of distribution, with botanical description, and brief other information. Price, in buckram, \$8.00; in half morocco, \$10.00

FLORA OF THE SOUTHERN STATES. CHAPMAN. This is an excellent key to the flora of the South, complete and accurate in its scope. Price, \$4.00

GETTING ACQUAINTED WITH THE TREES. By J. HORACE MCFARLAND. A handsome volume, copiously illustrated, and with facts accurately presented in an entertaining way. Price, \$1.75

HOW PLANTS GROW. By ASA GRAY. An understanding of the way in which a tree grows is of prime importance to the forester, and the matter here presented is accurate and authoritative. Price, \$1.00

PRINCIPAL SPECIES OF WOOD; THEIR CHARACTERISTIC PROPERTIES. By CHARLES HENRY SNOW. No attempt is made to give exhaustive descriptions of species, but the author presents a mass of information designed for the use and instruction of woodworkers, etc., in a popular style. A host of concise information is brought under each head, and the work is a valuable one. Price, \$3.50

These books sent prepaid upon receipt of price indicated, by FORESTRY AND IRRIGATION
1417 G Street N. W., Washington, D. C.

*Important Books on Forestry and Irrigation for sale by FORESTRY AND IRRIGATION
1417 G Street N. W., Washington, D. C.*

MANUAL OF BOTANY. By ASA GRAY. A key to the flora of the northeastern states, and the most authoritative publication of its nature.
Price, \$1.62; field edition, \$2.00

TREES OF NEW ENGLAND. By L. L. DAME and HENRY BROOKS. This book is a small volume which can be easily put in the pocket and carried in the woods, and at the same time is the best guide to the identification of our New England trees of any of the smaller books yet published.
Price, \$1.50

TREES OF NORTHEASTERN AMERICA. NEWHALL. A good general check list of the more important trees of the northeastern United States.
Price, \$1.75

TREES AND SHRUBS. By C. S. SARGENT. The most thorough and authoritative publication yet issued, and a standard work. The matter is issued in parts, of which there are three already published.
Price, per part, \$5.00

TREES, SHRUBS, AND VINES OF THE NORTHEASTERN UNITED STATES. By H. E. PARKHURST. In this book the author describes the trees, shrubs, and vines of the northeastern United States in a popular way, the book being designed especially for persons who have never studied botany. To these it will appeal as a valuable guide to a familiarity with the salient characteristics of trees, shrubs, and vines.
Price, \$1.50

TREES. A handbook of forest botany for the woodlands and the laboratory. By H. MARSHALL WARD. Vol. I. Buds and twigs. Vol. II. Leaves. Vol. III. Flowers and inflorescences. Three volumes to be added, on Fruits and seeds, Seedlings, Habit and conformation of the tree as a whole.
Price, per volume, \$1.50

PARTICULAR SPECIES AND LOCALITIES

MOUNTAINS OF CALIFORNIA, THE. By JOHN MUIR. No other person is so well fitted to write of the mountains of California as John Muir, and the volume presented here describes not only the mountains themselves, but the trees that clothe them and the wild life which they harbor.
Price, \$1.85

OUR NATIONAL PARKS. By JOHN MUIR. If you want to learn about the glaciers, mountain peaks, canyons, and great waterfalls of the West; of the habits of animals from the squirrel to the moose; plant life from the big trees to the wild flowers—in fact be brought face to face with nature's works, this is the book.
Price, \$1.85

TREES AND SHRUBS OF MASSACHUSETTS. EMERSON. Two volumes. Plain cloth edition has 148 plates. The colored edition has 36 of these in colors.
Price, plain, \$12.00 Price, colored, \$18.00

THE EARTH AS MODIFIED BY HUMAN ACTION. By G. P. MARSH. A Revision of Man and Nature. Describes changes in the face of the earth caused by man, including desolation of various countries, once thickly inhabited, by removal of forests. Shows importance of maintaining natural balance of forces.
Price, \$3.50

THE LONGLEAF PINE IN VIRGIN FOREST. A Silvical Study. By G. FREDERICK SCHWARZ. This is a study of the life history of this important forest tree. Intended primarily for foresters and forest students; also for owners and managers of pine timber lands. Deals with the preference or dislike of the species for particular conditions of soil, climate, and environment. Illustrations and six tables.
Price, \$1.25

THE SPROUT FORESTS OF THE HOUSATONIC VALLEY TO CONNECTICUT. By G. F. SCHWARZ. Illustrated study of forests repeatedly cut over.
Price, 35c

IMPORTATIONS

BEAUTIFUL RARE TREES AND PLANTS. By the EARL OF ANNESLEY. A description of some of the rarer English trees, shrubs, and vines, illustrated copiously.
Price, \$12.00

FORESTS OF UPPER INDIA AND THEIR INHABITANTS. By THOMAS W. WEBBER. This volume is an account of the author's life in India during the period shortly after 1857. It contains a vivid description of the country, its people, customs, etc., with some description of its forests and timber wealth.
Price, \$5.00

BOOKS ON IRRIGATION AND DRAINAGE

IRRIGATION IN THE UNITED STATES. By F. H. NEWELL. The most authoritative and complete work on the subject which has yet been published, by the head of the Government's irrigation work.
Price, \$2.00

IRRIGATION FARMING. By L. M. WILCOX. A newly revised edition of one of the standard works on irrigation. The principal chapters treat very fully of irrigation, its application, etc., and the volume is profusely illustrated.
Cloth, \$2.00

IRRIGATION FOR FARM, GARDEN AND ORCHARD. By HENRY STEWART. This work is offered to those American farmers and other cultivators of the soil who, from painful experience, can readily appreciate the losses which result from the scarcity of water at critical periods.
Price, \$1.00

IRRIGATION AND DRAINAGE. By F. H. KING. While most of the existing books on these subjects have been written from engineering or legal standpoints, this one presents in a broad, yet specific way the fundamental principles which underlie the methods of culture by irrigation and drainage.
Price, \$1.50

IRRIGATION INSTITUTIONS. By ELWOOD MREAD. A discussion of the economic and legal questions created by the growth of irrigated agriculture in the West, by the Chief of Irrigation and Drainage Investigations of the Department of Agriculture.
Price, \$1.25

LAND DRAINAGE. By MANLY MILES. A handbook for farmers on the principles and practise of draining, giving the results of his extended experience in laying tile drains.
Price, \$1.00

LAND OF LITTLE RAIN, THE. By MRS. MARY AUSTIN. A nature book of the highest type. The volume is made up of a series of sketches of the human, animal, and plant life found in the region of the Mohave desert, Death Valley, and the Sierras, much of which the average person is likely to consider almost devoid of living things.
Price, \$2.00

IRRIGATION ENGINEERING AND CONSTRUCTIVE WORK

DESIGN AND CONSTRUCTION OF DAMS. By EDWARD WEGMANN. This volume includes an authoritative discussion of the constructive work involved and the principal forms of construction. Masonry, rock-fill, and timber dams are discussed extensively.
Price, \$6.00

IMPROVEMENT OF RIVERS. By B. F. THOMAS and D. A. WATT. This volume is a treatise on the methods employed for improving streams for open navigation and for navigation by means of locks and dams.
Price, \$6.50

IRRIGATION ENGINEERING. By HERBERT M. WILSON. This is the fourth edition of Mr. Wilson's popular work, and the revision and enlargement which it has undergone, places it at the forefront of text books on the subject for American students.
Price, \$4.00

ENGINEERING FOR LAND DRAINAGE. By C. G. ELIOTT. A manual for laying out and constructing drains for the improvement of agricultural lands.
Price, \$1.50

RESERVOIRS FOR IRRIGATION, WATERPOWER, AND DOMESTIC WATER-SUPPLY. By JAMES DIX SCHUYLER. An account of various types of dams and the methods and plans of their construction, together with a discussion of the available water-supply for irrigation in various sections of arid America, distribution, application, and use of water; the rainfall, runoff, and evaporation from reservoirs, and effect of silt, etc.
Price, \$5.00

WATER SUPPLY ENGINEERING. By A. PRESCOTT FOLWELL. A treatise on the designing, construction and maintenance of water-supply systems, both city and irrigation.
Price, \$4.00

*These books sent prepaid upon receipt of price indicated, by FORESTRY AND IRRIGATION
1417 G Street N. W., Washington, D. C.*

- WATER POWER.** By JOSEPH P. FRIZELL. An outline of the development and application of the energy of flowing water. *Price, \$5.00*
- CONCRETE, PLAIN AND REINFORCED.** By FREDERICK W. TAYLOR and SANFORD E. THOMPSON. Designed for practicing engineers and contractors; text and reference book for students. Discusses materials, processes, and applications of concrete in construction and specifications. *Price, \$5.00*
- HYDRAULICS.** By MANSFIELD MERRIMAN. Purpose of book is to keep abreast of modern progress, and present subject with conciseness and clearness. Gives general principles and discusses flow of water through various kinds of openings and channels. Historical notes and references. *Price, \$5.00*

- FOUNDATIONS.** By W. M. PATTON. A practical treatise explaining fully the principles involved. Numerous descriptions of important modern structures are given in sufficient detail. Includes articles on use of concrete in foundations. *Price, \$5.90*
- MASONRY CONSTRUCTION.** By IRA O. BAKER. Contains results of a great number of experiments, and a large amount of practical data on cost of masonry, pile driving, foundations, culverts, etc., and 97 tables to facilitate estimating. *Price, \$5.00*
- REINFORCED CONCRETE.** By ALBERT W. BUEL and CHARLES S. HILL. A treatise for designing and constructing engineers, governed by American practice and conditions. Theoretical discussions omitted, and replaced by practical working formulas, examples of representative structures, and records of practice. *Price, \$5.00*

BOOKS ON RELATED SUBJECTS

- UTILIZATION OF WOOD WASTE BY DISTILLATION.** By WALTER B. HARPER. An important treatise on a subject regarding which the interest is great and the information scarce. Is intended to aid in the establishment and conduct of wood distilling enterprises on a business basis. *Price, \$3.00*
- HANDBOOK OF TIMBER PRESERVATION.** By SAMUEL M. ROWE. Intended as a complete practical guide for the operator of a preservation plant, with hints on construction thereof. *Price, \$4.00*
- IN FOREST LAND.** By DOUGLAS MALLOCH. The humor, sentiment, and philosophy of the lumber business interpreted by the "Lumberman Poet." A kind of touch with the great outdoors that few books contain. Illustrated in tint, bound in silk cloth and gold stamped. Ideal for gift or library. *Price, \$1.25*

THE GARDEN

- ROSES AND HOW TO GROW THEM.** By many Experts. In text, practical; in subject and quality of illustrations, beautiful. *Price, \$1.20*
- FERNS AND HOW TO GROW THEM.** By G. A. WOOLSON. The growing of hardy ferns, both in the garden and indoors. *Price, \$1.20*
- LAWNS AND HOW TO MAKE THEM.** By LEONARD BARON. For the first time the subject of lawn seed mixtures is set forth and explained. 32 photographs. *Price, \$1.20*
- HOW TO MAKE SCHOOL GARDENS.** By H. D. HEMENWAY. This suggestive little book is a practical manual of school gardening for both teacher and pupil, and supplies the first adequate work of the sort in this country. There are to-day a hundred thousand school gardens in Europe, and the progress of the recent movement in America has been most rapid. This volume is based on actual experience (the author is an authority and director of the Hartford School of Horticulture). Illustrations, 10. *Price, \$1.10*
- HOW TO MAKE A FRUIT GARDEN.** By S. W. FLETCHER. An eminently practical work on the subject of fruits for the home. With 182 photographic illustrations by the author. *Price, \$2.25*
- HOW TO MAKE A FLOWER GARDEN.** A charming and a practical book by experts on every branch of the subject. More than 200 beautiful photographs. *Price, \$1.75*
- HOW TO MAKE A VEGETABLE GARDEN.** By EDITH L. FULLERTON. The only adequate book on the home vegetable garden. 250 photographs by H. B. Fullerton. *Price, \$2.20*
- ART AND CRAFT OF GARDEN MAKING.** By THOMAS H. MAWSON. Third edition of this standard; out of print for a year, and now reissued in revised form. Over 100 plans and details of gardens. Methods employed by successful designers carefully analyzed. Characteristic sites in typical districts described and pictured. *Price, \$15.00*

THE HOME AND FARM

- THE COUNTRY HOUSE.** By CHARLES EDW. HOOPER. A Practical manual of house building, absolutely invaluable to every one with a country place. It covers every branch of the subject in detail and treats of the garden and its furnishings in connection with the dwelling. 380 photographs and plans. *Price, \$3.30*
- THREE ACRES AND LIBERTY.** By BOLTON HALL. Description of what can be accomplished on a small place in the way of gardening, home-making, and addition to financial resources. Were it not for the unimpeachable authorities quoted, its statements as to the possibilities of the "Little Lands" for a living would seem fanciful. *Price, \$1.85*

- THE MAKING OF A COUNTRY HOME.** By J. P. Mowbray ("J. P. M."). This delightful story showed its universal appeal when published serially, and the volume amply carries out the intention of the author. Besides its practical interest for the thousands of city dwellers who have dreamed of having a country home, the story is one of such reality, humor, and interest as to ensure it the widest circulation in book form. Elaborately decorated. *\$1.65*

- THE FIRST BOOK OF FARMING.** By CHARLES L. GOODRICH. No one interested in farming, old or young, can fail to appreciate this book, for it really gives the fundamental knowledge of how to conduct a farm with the least expense and the largest return. There are 65 full pages of helpful illustrations. The price is extremely low for a work of such value. 43 pages of photographs. *Price, \$1.10*

NATURE BOOKS

- AMERICAN FOOD AND GAME FISHES.** By DAVID STARR JORDAN and B. W. EVERMANN. Fills a long-felt need in popular scientific works, being a full account of the life-histories and methods of capture of North American food and game fishes. The only book in existence which will enable the amateur readily to identify species new to him. With 10 lithographed color plates, 100 photographs of live fish in the water, and 200 text cuts. *Price, \$4.40*
- NATURE BIOGRAPHIES.** By CLARENCE M. WEED. This volume is a sort of personal acquaintance with the lives of the more common butterflies, moths, grasshoppers, flies, and so on, the sort of fascinating details of these insect existences which make the reader want to go out and study these every-day marvels for himself. 150 photographic illustrations. *Price, \$1.50*
- THE BROOK BOOK.** By MARY ROGERS MILLER. A brook is one of the most living and companionable features of the landscape, and few people, even the most ardent nature lovers, realize what an endlessly interesting study its changes and its throbbing life afford. It is a fascinating subject which the author (well known as a teacher, lecturer, and writer connected with the Nature Study Bureau at Cornell) handles with much ability. 16 photographs. *Price, \$1.50*

- OUTDOORS.** A Book of the Woods, Fields, and Marshlands. By ERNEST MCGAFFEY. Papers on out of doors, showing a love of nature and keenness of observation and power and beauty of description rarely surpassed. *Price, \$1.25*

- NATURE AND THE CAMERA.** By A. RADCLIFFE DUGMORE. Mr. Dugmore is an expert in the new movement of photographing live birds, animals, fish, flowers, etc. His works brought him so many requests for information, that he has set down here a full and detailed account of his methods. From the choice of a camera to questions of lighting, and to the problem of "snapping" shy birds and animals in their native haunts, every step is explained so simply as to be easily comprehended, even by the beginner. 53 photographic illustrations. *Price, \$1.50*

These books sent prepaid upon receipt of price indicated, by FORESTRY AND IRRIGATION
1417 G Street N. W., Washington D. C.

Save the Forests

The aid of all patriotic men and women of America is earnestly desired in the work of The American Forestry Association.

If you are interested in the Vital Subject of Conservation of the Nation's Natural Resources, if you realize the country's peril from the exhaustion of those resources, you should become a member of the Association.

We will cheerfully furnish our literature on your simple postal-card request. Or, better still, clip and fill out the blank below and mail it to us.

But Do It To-day.

The American Forestry Association

(Incorporated)

Washington, D. C.

Nominations for Membership

The activities of the National Office of the American Forestry Association are limited chiefly by its resources. These are derived almost wholly from its members in the form of dues. Every member is urged to aid in increasing the membership. Kindly fill out the enclosed blank form, lengthening the list, where possible, by attaching and filling blank sheet. The list should then be sent to

THOMAS E. WILL
Secretary American Forestry Association
1417 G Street Northwest, Washington, D. C.

I hereby nominate the following persons for membership in The American Forestry Association:

Name

Address

Signed.....

"THE CARE OF TREES"

TREE TRUTHS

Large, unhealthy trees worry their owner—if they die they cannot be replaced.

The many physical defects in trees as well as insect and other diseases are sure to conquer—unless remedied.

Insure your trees against damage by an inspection, that you may learn further of any impending dangers, some of which you are perhaps unaware.

Pruning, spraying, tree surgery, fertilizing, etc., are necessary if shade and fruit trees are to be safe and vigorous.

Our little booklet is full of truths which every tree owner should know. Send for it to-day.

MUNSON-WHITAKER COMPANY

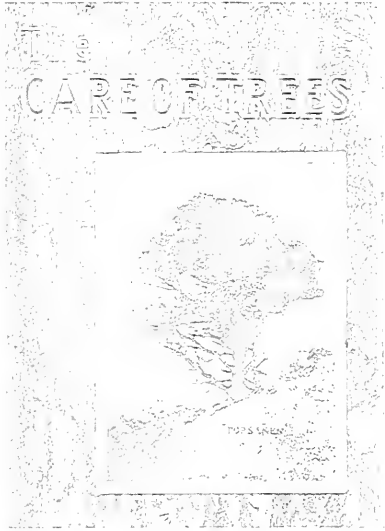

THREE FACTS

By having us inspect your trees you may learn of some serious defect, which unless remedied, will soon cause the tree to be disfigured or die.

If there is work to be done on your trees, our men can do it in the best possible manner.

We have repaired and saved many shade trees as well as insect-infested orchards, and brought them into excellent condition.

You will find our little booklet photographed here—with very interesting and practical. We will be pleased to mail you a copy free of charge on request.

840 TREMONT BUILDING, BOSTON
1104 FLATIRON BUILDING, NEW YORK



How Much Money Can You Save if
You Could be Assured of

ABSOLUTE SAFETY?

Would 6 per cent. interest look attractive to you? Let us tell you about our certificate of deposit plan—You decide whether it is good or not—6 per cent. for your savings, without having to tie them up in a permanent investment, is an opportunity you ought to know about.

We will send full information—Answer every possible question if you will simply

WRITE

The Calvert Mortgage & Deposit Company
1069 Calvert Building
Baltimore, Md.

Thorburn's Seeds

We carry a large assortment of seeds of EVERGREEN and DECIDUOUS TREES and SHRUBS, both native and imported, and shall be glad to quote on any that are still unsold.

J. M. THORBURN & CO.

33 BARCLAY STREET

Through to 38 Park Place

Established 1802

NEW YORK

In writing to advertisers kindly mention FORESTRY AND IRRIGATION

Biltmore Forest School

Biltmore, N. C.

Theoretical and practical instruction in all branches of applied forestry.

The course comprises eighteen months: twelve consecutive months of lectures and field work, and six months of practical experience.

Object lessons within the mountain estate of George W. Vanderbilt, comprising 120,000 acres where forestry has been practiced since 1895.

For further information apply to
C. A. Schenck, Director

Colorado School of Forestry

Colorado Springs, Colo.

Three years' course in
TECHNICAL AND
APPLIED FORESTRY

Winter Term at Colorado College, Colorado Springs. Summer Term at Manitou Park, on the borders of the Pike's Peak Forest Reserve.

Tuition
Sixty Dollars a Year

For further particulars apply to
Wm. C. Sturgis, Dean
Colorado Springs, Colo.

YALE FOREST SCHOOL

NEW HAVEN, CONNECTICUT

The course of study in the YALE FOREST SCHOOL covers a period of two years. Graduates of collegiate institutions of high standing are admitted as candidates for the degree of Master of Forestry.

The Summer School of Forestry is conducted at MILFORD, PIKE COUNTY, PENNA.

FOR FURTHER INFORMATION ADDRESS
HENRY S. GRAVES, Director New Haven, Connecticut

CONSERVATION



**WOODS AND WATERS
SOILS AND ORES**

ANNOUNCEMENT

With this, the September number, the title "Forestry and Irrigation" is abandoned, and the monthly magazine of The American Forestry Association appears under its new and more comprehensive title,

" CONSERVATION "

The same magazine, under the same control, but with an enlarged scope and an ever-widening field of usefulness.

" THE CULT OF CONSERVATION "

By Dr. W. McGee, in this number

SCIENTIFIC WORK BY EXPERTS

America's Foremost Tree Expert

JOHN DAVEY

HIS BOOKS

"The Tree Doctor"
(OLD)

"Davey's Primer on
Trees and Birds"

"A New Era in Tree
Growing"

"The Tree Doctor"
(NEW)

Good for all who have
an interest in trees



HIS LECTURE

"Our Wounded
Friends, The
Trees"

"I wish that ten thousand
committees in the United
States might hear this lec-
ture, for it would mean the
salvation of a million trees."

J. HORACE MCFARLAND,
Pres. Amer. Civic Association

The Father of Tree Surgery

OELRICHS & CO., NEW YORK
TELEGRAPHIC ADDRESS, "OELRICHS"

NEW YORK, July 3, 1908.

Mr. Martin L. Davey,
The Davey School of Practical Forestry,
Tarrytown, Westchester County, N. Y.

DEAR SIR: I am very much pleased with the work on my trees at Scarborough. It has been most intelligently and effectively done. I confess that before you undertook the work on my place I had no conception of the attention and care that trees require.

I desire also to express to you my appreciation of the very efficient workmanship and the courtesy and excellent behavior of your representatives who carried on the work.

I am, with kind regards,
Yours very truly,

GUSTAV H. SCHWARZ.

The value of your trees can not be estimated in dollars and cents. If they are worth keeping at all, they are worth the most skillful attention obtainable. **Nearly half a century of experience makes our work perfect**, and this experience is at your service. In Tree Surgery we stand alone. We can save your shade trees. We can restore the productiveness of your orchards. We can solve your forest problems.

Send for our booklet, "A Great Revelation." It will cost you nothing. We will make an examination of your trees on request.

DAVEY'S School of Practical Forestry

Eastern Office, Tarrytown, N. Y.

The best is none too good in the care of your trees

"THE CARE OF TREES"

Preserve Your Old Trees

Old trees are apt to be in serious need of attention—due to physical defects and insect attacks. Dead wood, cavities, and diseases must be eliminated if the trees are to survive and flourish. Such work is our sole business, and we have perfected it to a wonderful degree. We have saved many trees thought to be beyond help.

For the benefit of estate owners in the middle West we announce that we now have squads of men working in Columbus and Cincinnati, Ohio.

840 Tremont Bldg., Boston
1104 Flatiron Bldg., New York

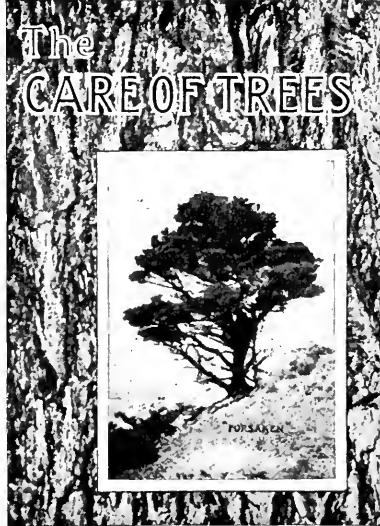

Have Us Inspect Your Trees

An inspection serves as an insurance on the welfare of your trees. We often find valuable specimens in urgent need of help. The cost of inspection is slight and your trees are valuable. The deadly San Jose scale infests nearly all orchards, but we can control it and bring your trees into an excellent condition.

Send for our free booklet "THE CARE OF TREES" photographed herewith. It shows what we do and our fitness for the work.

**MUNSON - WHITAKER
COMPANY**

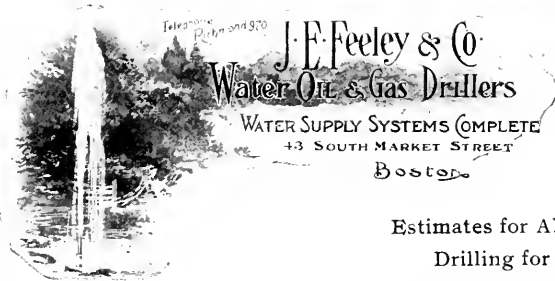

Flowing Well, New Mexico

J. E. FEELEY
F. A. BASFORD

**Test Boring for Minerals
in any part of the United
States or Canada**

Telephone, Richmond 970

Estimates for All Kinds of Pumping Outfits
Drilling for Water, Oil or Gas Wells

J. E. FEELEY & CO.

43 SOUTH MARKET STREET, BOSTON, MASS.

Plant for Immediate Effect

Not for Future Generations

Start with the largest stock that can be secured! It takes over **twenty years** to grow such Trees and Shrubs as we offer.

We do the long waiting—thus enabling you to secure trees and shrubs that give an immediate effect. **Fall Price List Now Ready.**

ANDORRA NURSERIES CHESTNUT HILL
PHILADELPHIA, PA.

WM. WARNER HARPER, Proprietor

Real Estate, Farms, etc.

The following advertisements of Real Estate, Farm Lands, Timber Lands, etc., are the announcements of reliable firms and agencies. The Advertising Manager of **FORESTRY AND IRRIGATION** has investigated the announcements in all cases, and feels safe in recommending the advertisers to the readers of the magazine. The services of this department are free to all members of The American Forestry Association and subscribers to this magazine; advice in regard to the purchase of Real Estate advertised in our pages is gladly given, and our readers are urged to make the fullest use of our services in all matters pertaining to the purchase of advertised Real Estate, of whatever character, no matter where it is located.

FARMS AND HOMES IN VIRGINIA

Free from frost 183 days

Plowing season 315 days

Growing season 225 days

WHY NOT MOVE TO VIRGINIA?

where you can buy good level land with buildings, timber, fruit, water, etc., at \$8 per Acre and up! Best climate, health, markets, transportation facilities, churches, schools, active business life.

Our Illustrated Real Estate Herald, with map, tells all about it. Write to-day for free copy.

PYLE & COMPANY (Inc.), PETERSBURG, VIRGINIA

VIRGINIA INVESTMENTS

J. NELSON GARNETT, Real Estate and Loan Agent, CULPEPER, VA.

High-class Loans and Mortgages our Specialty

Choiceest homes and investments of every description in Northern or Piedmont Virginia, the garden spot of the world, and the booming Southland, within sixty miles of Washington.

Write for property list and other information.

Virginia Country Homes

Grain, fruit, dairy, and blue-grass farms for sale in the best portions of the state. Also timber lands.

Climate, social conditions, and nearness to markets, makes this a splendid country in which to locate.

Write for free illustrated register. We solicit correspondence.

H. W. Hilleary & Co.

Charlottesville, Virginia

FINE DAIRY FARM

IN FLORIDA

160 acres. 12-room house already furnished, together with all the cows and other stock, farming implements, etc. A small orange grove, peach orchard and other fruits. Offered at a great bargain for quick sale, as owner's wife has been paralyzed and must leave.

M. B. NICOL

Manassas

Virginia

A MAGNIFICENT VIRGINIA ESTATE

(Only 87 minutes by rail from Washington.) Contains 1,023 acres, about 500 acres in blue-grass, 200 acres in timothy and other grasses, 200 acres in grain and crops, and about 100 acres in good timber.

160 cattle were fattened on this place last year, and sold for over \$12,000; besides this, there was sold from the place over \$1,200 worth of hay. The corn crop averaged sixty bushels to the acre. A small field of alfalfa was cut three times, and could have been cut another time. There are nearly 500 thrifty bearing fruit trees. The soil is a dark rich loam, well drained. Splendid new residence of thirteen rooms, two bath rooms, over 100 feet of porch, 10-acre lawn, all modern improvements, hot and cold water, steam heat and gas. Besides this mansion, there is another 6-room house, three tenant-houses, two sets of farm buildings, five stock barns for hay, etc.

It is not more than one-fourth of a mile from a prominent station on the Southern Railroad, and very convenient to Washington and the northern cities. Acre for acre, this farm is second to no farm in Virginia.

For price and particulars, address

JOHN A. NICHOL, Manassas, Virginia

11,000 ACRES

TITLES PERFECT

J. F. WEATHERS & COMPANY

Timberland in Alabama on new railroad. Will cut 8,000 feet merchantable lumber. Will sacrifice for quick sale at \$6 00 per acre. Underlaid with 3 seams best coal and fine iron ore.

TIMBERLAND SPECIALISTS
1326 Broadway, New York

WANTED

To purchase yellow pine timber tracts in quantities from ten to one hundred million feet. Would consider a going proposition if there is a large amount of timber in proportion to mill investment. Address, with full particulars,

Box 683

RICHMOND, VIRGINIA

PHILADELPHIA FARM AGENCY

We represent 800 owners of farms near Philadelphia; where farms are cheaper and markets are better than near any large city in this country. I can sell a good 50-acre farm for \$2,500 to \$4,000. Write and tell us your requirements; we have the properties.

E. H. TRENCHARD

Farm Specialist

1230 Arch Street Philadelphia, Pa.

Winter Home in Florida

Orange-grove with 630 bearing trees, Orange and Grapefruit, 210 acres of land, handsome residence, all modern improvements, splendid outbuildings, all in good repair. First-class packing house. Close to depot. Crop sold for over \$3,000 one year. Fishing, hunting, and boating unexcelled. Price, \$15,000. Ten per cent. guaranteed if bought at once. Description, terms, etc., on request.

M. B. Nicol

Manassas, Virginia

ADVERTISERS

of Real Estate, especially Farm Lands and Timber Lands, find CONSERVATION a profitable advertising medium.

BUYERS

of properties of these kinds rely on those whose announcements appear in CONSERVATION. Advertisers must be reliable, else they cannot buy space in this magazine. Our readers know this.

RATES ON APPLICATION

CONSERVATION

1417 G Street N. W. Washington, D. C.

WE SELL FARMS

BOOTH'S FARM AGENCY

Cor. Eighth and G Sts. N. W.

We are specialists on Farms and Country Homes in Maryland, Virginia, and the District of Columbia.

Our Farm Bulletins contain hundreds of the best Estates, Fruit Farms, Dairy and Stock Farms, Poultry Farms, Truck and Garden Lands that are on the market at this time near Greater Washington, D. C.

We offer absolutely the cheapest and best homes for the least money in the United States.

Write or call for our Md. or Va. Bulletins, free for the asking, and be convinced. Now is the time to buy Farms and Country Real Estate in and around the National Capital.

BOOTH'S FARM AGENCY

Ouray Building

Cor. Eighth and G Streets Northwest

WASHINGTON, D. C.

1,000 BARGAIN FARMS

VIRGINIA

Farms, City Property
Timber and Mineral

LANDS

A Specialty

*Large Tracts for
Colonization*

International Farm Agency

(INCORPORATED)

900 Main Street

Lynchburg, Va.

The Peninsula of Virginia

The most favored section of the state. Good lands, fine climate, healthy; good crops and good markets; fine schools, best society. Farmers making big money growing Irish potatoes, corn, hay, berries, etc. One man cleared \$100 per acre from potato crop this season, and now has second crop, corn, growing on same land. Hundreds of Western and Northern people already here, and hundreds more coming. It's the best country in the world. Send 5c (stamps) for descriptive literature.

PIEDMONT & TIDEWATER LAND CO., Inc.

Box 79, Williamsburg, Virginia

Timberlands in the South

We offer timber tracts in Virginia, North and South Carolina, and other sections of the South.

First-class Southern Pine and Hardwoods

The tracts are covered with virgin growths of Southern Yellow Pine and Hardwoods, the timber alone being worth the price asked for the lands. Land is all good farming land after it is cleared. All are within a reasonable distance of Charleston. Particulars on request.

O. H. PERRY TIE & LUMBER CO.
Norfolk, Virginia

MARYLAND

Great Opportunity

A celebrated estate containing 2,200 acres, located four miles above Yorktown, Va., on York River, is for sale.

Splendid place for Club House, and hunting and fishing preserves. Address,

OLD DOMINION LAND CO.

Newport News, Va.

Timber Lands and Farms

42,116 acres in.....	S. Carolina
8,300 acres in.....	S. Carolina
60,000 acres in.....	West Virginia
48,000 acres in.....	Western N. Carolina
660 acres in.....	N. Carolina
25,880 acres in.....	Georgia
2,000,000 acres in.....	Florida
35,000 acres in.....	Mississippi
30,000 acres in.....	S. Carolina

For Sale by

H. C. HOGGARD & CO.

NORFOLK, VA.

One hundred sixty-five acres, 9-room house, six 6-room houses, four cattle barns, calf barn, machinery, and every convenience for dairy. Improvements cost \$180,000. Price, \$35,000

ANDERSON REAL ESTATE @ LAW CO.
Richmond, Va.

HOMES IN NORTHERN VIRGINIA

Two hundred twenty acre farm, 70 miles from Washington, D. C., in the best fruit growing section of Virginia, one mile from railway station on the Southern Railroad.

Eight hundred apple-trees on the farm. Thirty acres in corn, balance in blue-grass, well watered with running water. Good 8-room house and all necessary outbuildings. Moderate price, easy terms. Apply to

BROWNING BROS.
Real Estate Agents
Falls Church, Va.

A SPLENDID OPPORTUNITY

150-acre farm in Maryland, within driving distance of Washington, D. C. Has first-class soil, well suited for all agricultural purposes; a substantial brick mansion, colonial style, of fourteen large rooms, marble mantels, and a cellar under the whole house. All necessary farm buildings, and a large orchard. Price, only \$4,000; must be sold at once.

H. BADENHOOP

111 N. Charles St., Baltimore, Md.

(Call or write for my list of Maryland farms)

FOR SALE

One of the finest farms in Northern Virginia, containing 314 acres of blue-grass land. The improvements are as follows: Fine stone house of 14 rooms, large bank barn, double corn-house, ice-house, hen-house, meat-house, 5-room tenant-house, orchard of all kinds of fruit. Every rod of fence is in perfect condition. This is an ideal stock farm for the money. Price, \$20,000. Terms, \$5,000 cash, balance in one, two, three, and four years. This farm is situated near Bluemont, Va.

No. 2.—283 acres, house of 9 rooms; barn for 10 cows and 16 horses, new dairy; a nice spring of water; a living stream through the farm; 80 acres in timber; smooth land and a good quality; in nice neighborhood; four miles from railroad station. Price, \$18 per acre; terms favorable.

Send for our list and we will gladly mail it to you. Address

J. W. BAUCKMAN & SON
Real Estate Brokers Herndon, Va.

REAL ESTATE

Bought, Exchanged and Sold

No matter where located, will buy or sell your business or Real Estate for CASH. Real Estate loans at lowest rates.

CLARENCE E. TUCKER

Metropolitan Bank Building

Washington, D. C.

COUNTRY PROPERTY

Timber lands, coal lands, farms, country seats, hotels, factory properties, water powers, game preserves, water fronts on lakes, rivers and salt water, etc., etc.

Archibald C. Foss

39 East 42nd St., N. Y.

Branch Offices

South Norwalk, Conn.

Millerton, N. Y.

FOR SALE

Game and Trout Preserve

Sullivan County, New York; 2,300 feet above the sea level, 425 acres, over 300 acres in forest; a lake covering 70 acres, fed by numerous springs located on the premises. Lake stocked with trout; there are also partridge, deer, and other game.

Large four-story house and a two-story cottage, both furnished; fine views; for sale, including furniture, stock, implements, etc. For terms and particulars, address

W. F. DAVENPORT

171 Broadway, New York, N. Y.

FOR SALE - FARMS, COUNTRY ESTATES, BUILDING SITES; ALL SECTIONS; WRITE YOUR WANTS.
W. F. DAVENPORT
171 BROADWAY, NEW YORK, N. Y.

Philippine Bureau of Forestry

WANTED—Two foresters with field experience. Minimum salary, \$1,600. Travel expenses allowed, also liberal leave privileges.

At least seven months' interesting field work per year.

For information concerning travel allowance to Manila, Civil Service rules, health conditions; in fact any information in regard to the Islands, apply to the Bureau of Insular Affairs, War Department, Washington, D. C.

Summer homes, hunting preserves, and farms, in Old Virginia. Write,

W. E. LAWSON

Hampton, Va.

Southern Real Estate, especially Virginia. Catalogue free.

GEO. E. CRAWFORD CO

Richmond, Va.

S. P. SPEERS

Timber and Coal Lands

Southern Pine and Oak

Nine thousand acres Hemlock in S. E. West Virginia. Directly on railroad, easily accessible by tram road.

OFFICE, 206 LAW BUILDING, BALTIMORE, MD.

Desirable Farms

Near Baltimore, Md., and Washington, D. C.

AUBREY BIRD & CO.

1105-7 Calvert Bldg., Baltimore, Md.

FARMS near the National Capital, suitable for all classes, and purposes, reasonable in price, advantage of best market in the country. Healthy and delightful climate.

Write us for particulars.

NATIONAL FARM AGENCY

1407 N. Y. Ave. N. W.

Washington, D. C.

COME TO COLORADO

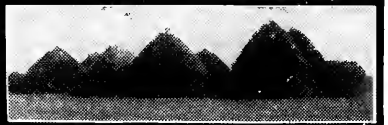

Big Profits In Crops

Don't wait. Here's a big opportunity to own land at a little price. Mighty few such good chances left. Get busy now. Write us for our brand new booklet, "The New Colorado," full of live facts, figures, map, etc., about that great fertile tract in Eastern Colorado, the 35,000 acre Bijou Ranch Lands. They need no irrigation. 65 miles from Denver, 42 miles from Colorado Springs. Rainfall sufficient to raise wheat 35 bushels to acre, speltz 32 bushels, potatoes 200 bushels, corn 35 bushels, oats 79 bushels, etc. Alfalfa four cuttings, 5 tons to acre. (See cut of stacks above.) Glorious climate; healthful and invigorating. 80 acres will earn you \$1000 in twelve months. Small cash payment needful—say \$2 to \$3 per acre—balance in five equal annual installments. Write for the book today. "Hurry to Colorado." Address, Dept. 17.



The Farmers Land and Loan Company,

145 La Salle St., Chicago, Ill.

THE American Forestry Association

Officers for 1908

President

HON. JAMES WILSON, Secretary of Agriculture

Vice-presidents-at-large

DR. EDWARD EVERETT HALE	GEO. T. OLIVER
N. J. BACHELDER	DR. B. E. FERNOW
GEO. FOSTER PEABODY	GEO. C. PARDEE
RUTHERFORD P. HAYES	ALBERT SHAW
W. W. FINLEY	J. T. ROTHROCK

CHARLES R. VAN HISE

Advisory Board Selected by Affiliated Organizations

H. H. WHELESS	GEORGE E. STONE	W. K. KNOX
JAMES INNES	ALLEN CHAMBERLAIN	A. L. HAYES
C. H. KEYS	D. E. KLINE	FREDERICK S. UNDERHILL
ROBERT C. LIPPINCOTT	E. F. SAWYER	ROBERT L. LIPPINCOTT
GEORGE F. CRAIG	F. E. WEYERHAEUSER	S. B. ANDERSON
C. A. SMITH	KENT SHEPPARD	ROBERT A. JOHNSON

Members of Board Designated as Vice-Presidents of Association

N. W. McLEOD	LEWIS DILL	J. T. WYLIE
WILLIAM IRVINE	EDWIN A. START	D. E. KLINE
GEORGE H. HAMPTON	SAMUEL B. VROOMAN	B. W. PORTER

Secretary, THOMAS ELMER WILL, Washington, D. C.

Assistant Secretary, FRANK GLOVER HEATON, Washington, D. C.

Treasurer, OTTO LUEBKERT, Washington, D. C.

Directors

JAMES WILSON	WILLIAM L. HALL	W. J. MCGEE
GEO. P. WHITTLESEY	GEORGE K. SMITH	PHILIP W. AYRES
JAMES H. CUTLER	WILLIAM S. HARVEY	ROBERT GARRETT
HENRY S. GRAVES	H. A. PRESSEY	LIGON JOHNSON
F. H. NEWELL	ASBURY F. LEVER	FILIBERT ROTH

Application for Membership

To THOMAS ELMER WILL

Secretary American Forestry Association

1417 G Street N. W., Washington, D. C.

Dear Sir: I hereby signify my desire to become a member of the American Forestry Association. Two Dollars (\$2.00) for annual dues are enclosed herewith.

Very truly yours,

Name _____

P. O. Address _____

The American Forestry Association

President—HON. JAMES WILSON

Secretary of Agriculture

The American Forestry Association was organized in 1882, and incorporated in January, 1897. It now has over 7,000 members, residents of every State in the Union, Canada, and foreign countries. From its origin it has been the tireless friend of the forests.

The object of the Association is to promote the preservation, by wise use, and the extension of the forests of the United States; its means are agitation and education; it seeks to encourage the application of forestry by private owners to forest holdings, large or small; and it favors, especially, the establishment and multiplication of National and State forests, to be administered in the highest interests of all.

The Association seeks as members all who sympathize with its object and methods, and who believe that our natural resources constitute a common heritage, to be used without abusing and administered for the common good. Seeking to conserve our supplies of wood and water, the Association appeals especially to wood-producers and users, including owners of wood lands, lumbermen, foresters, railroad men, and engineers; and to those dependent upon equable stream flow, as manufacturers, irrigators, employers of water power, and those engaged in internal commerce.

The Association meets annually in Washington. It publishes, monthly, *CONSERVATION*, the magazine of authority in its special field. The list of contributors to this publication includes practically all persons prominent in forest work in the United States, making it alone worth the cost of Annual Membership in the Association.

The dues, covering a subscription to *CONSERVATION*, are as follows: Annual—For Annual Members, \$2; for Sustaining Members, \$25; Total, with exemption from all other payments—for Life Members, \$100; for Patrons, \$1,000.

THOMAS ELMER WILL, Secretary.

Address: 1417 G Street N. W., Washington, D. C.



EVERGREENS 2 to 10 FEET HIGH

You have over 30,000 to select from that have been especially trained for successful transplanting in September. They have been recently transplanted or root pruned; tops pruned in June to make them dense and symmetrical. PINE, CEDAR and HEMLOCK up to 10 to 25 feet high in carload lots.

Now is the time to select from our stock of SHADE TREES which save 10 to 20 years waiting. They are grown 12 to 25 feet apart and prepared for successful shipment.

Will a group of shade trees 25 to 30 feet high make your place more beautiful and comfortable?

FOREST SEEDLINGS AT LOW RATES

Call at the Nursery or send for our beautifully illustrated catalogue and price list

ISAAC HICKS & SON, Nurserymen, Scientific Træmovers
WESTBURY STATION, LONG ISLAND, N. Y.

NEW ENGLAND COUNTRY HOMES

Stock and dairy farms,
Summer Houses at sea-
shore, White Mountains
and Berkshire Hills, from
25 to 1,500 acres of land,
ranging in price from
\$10,000 up to \$150,000.
Will be pleased to give full
description and terms.

George C. Davis

70 STATE STREET, BOSTON

High-grade Country Estates

WATER POWERS

I shall be pleased to correspond with OWNERS (owners only) of WATER POWERS east of the Appalachian Range, where a reliable flow of water will yield 5,000 to 50,000 h. p. under modern methods of development, and where there is a market for power within a radius of say fifty miles.

RALPH HERBERT WAGGONER

309 BROADWAY
NEW YORK

CONSERVATION

OFFICIAL MAGAZINE
OF THE
AMERICAN FORESTRY ASSOCIATION

FRANK GLOVER HEATON, *Editor*

CONTENTS FOR SEPTEMBER, 1908

RECLAMATION WORK IN THE WEST.....	<i>Frontispiece</i>
THE CULT OF CONSERVATION—By W J McGee, LL.D.....	469
WORK ON A NATIONAL FOREST—By Charles Howard Shinn.....	473
Illustrated	
FOREST POLICY OF PENNSYLVANIA—By John L. Strobeck.....	481
Illustrated	
NATIONS' NEED OF FORESTRY WORK—By Mrs. J. E. MacKisson.....	487
Illustrated	
THE PLEA OF THE CITY ELM— <i>Poem</i> —By Marian Mead.....	492
EDITORIAL—With Illustrations	
Change of Title.....	493
Our Duty to Posterity.....	493
Not for To-day.....	493
The Practical View.....	494
Conservation, a World-movement.....	496
Forest Fires.....	498
The Next Annual Meeting.....	500
Another Form of Activity.....	501
THE HEGIRA— <i>Poem</i> —By "The Poet Lariat".....	503
THE APPALACHIAN NATIONAL FOREST ASSOCIATION.....	504
THE NATION'S HERCULEAN TASK—By Claude N. Bennett.....	506
NEWS AND NOTES	
Arizona Benefits from National Forests.....	508
Japan Makes Innovations in Forest Management..	508
Government Maps for Automoblilists.....	509
New Publications.....	510
AS ONE FOREST RANGER VIEWS IT—By Fred. Hanson.....	512
A GREAT FOREST—By John Collins, M.D.....	514

CONSERVATION is the official organ of the American Forestry Association. Price, \$2.00 per year, including Annual Membership in the Association. Entry applied for at the Post-office at Washington, D. C., as second-class mail matter

Published Monthly at
1417 G STREET N. W. WASHINGTON, D. C.

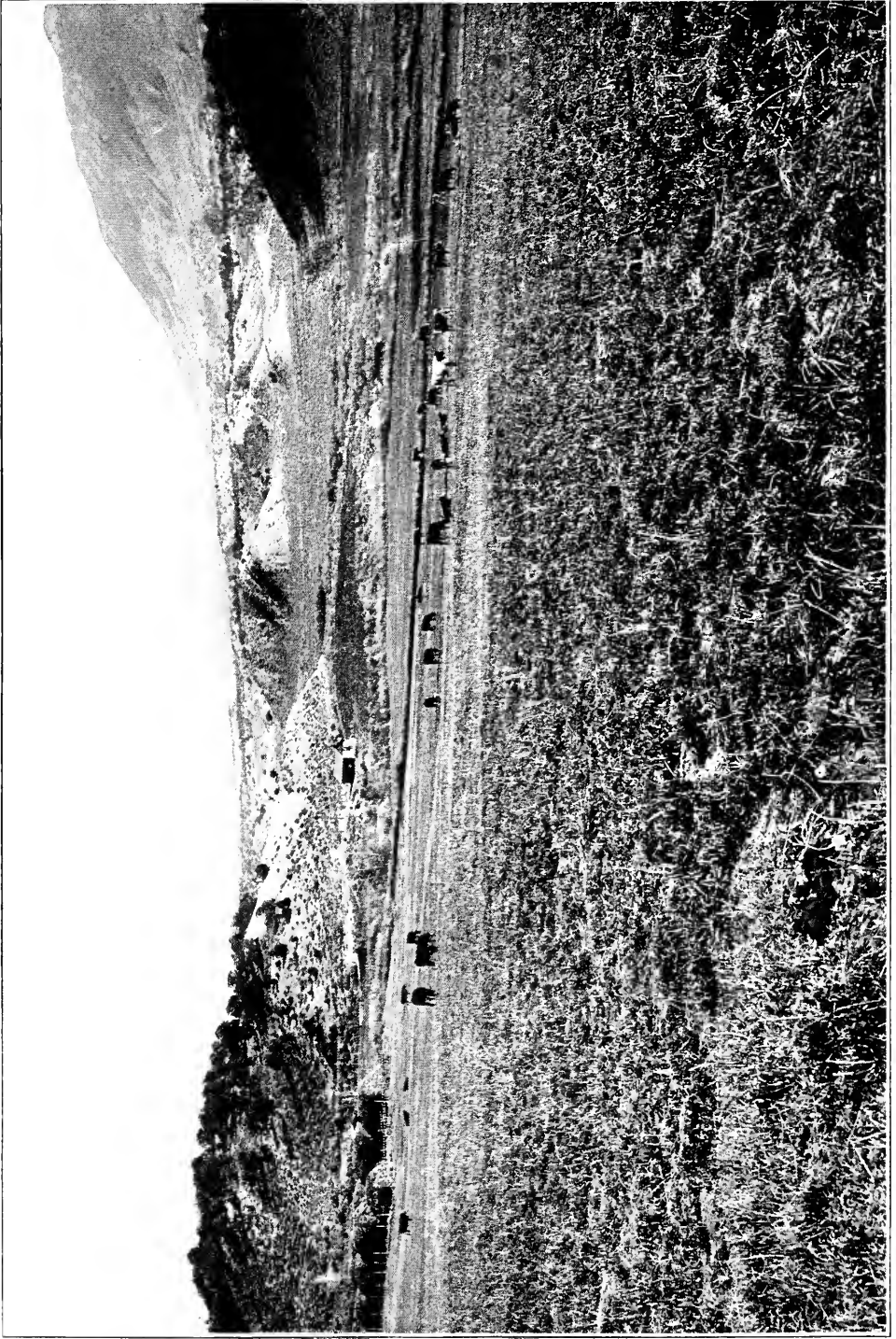

RECLAMATION WORK
Irrigated Hay Ranch on Rifle Creek, Garfield County, Colorado



Vol. XIV

SEPTEMBER, 1908

No. 9

THE CULT OF CONSERVATION

By W J McGEE, LL.D., Erosion Expert, U. S. Bureau of Soils

Member National Conservation Commission, Secretary of the U. S. Inland Waterways Commission

A NEW Patriotism has appeared. It was born of Enlightenment inspired by International Comity. Fittingly, it first saw light in the land in which Enlightenment found birth in the principle of equal rights of all men to life, liberty, and the pursuit of happiness; yet its field of future activity is the world. Its object is the conservation of national resources; its end the perpetration of People and States and the exaltation of Humanity. The keynote of its cry unto the spirits of men is THE GREATEST GOOD TO THE GREATEST NUMBER FOR THE LONGEST TIME.

The house of this Nation was founded on Land. The Fathers saw no value, no means of enrichment in purse or enlargement of character in aught else; even their sons and their sons' sons sowed maxims and sang ballads assuring all the world that "Uncle Sam is rich enough to give us all a farm." Iron was a luxury from Sweden, steel a sybaritic morsel from Sheffield; coal was unknown, except as laboriously burned from willow as a dentifrice, or aspen for the furnace; petroleum and

rock-gas were beyond dreams; forests were obstructions to settlement, the haunt of savages and beasts, and nigh unto a public evil. Every day was Arbor Day on which a youth won praise not by planting but by felling a tree—unless perchance the tree were a cherry and the chronicler of its fall a hero-worshipful Weems. Apart from men and their homes and fields, but a single resource was noted, and that merely as appurtenant to the land—i. e., the estuaries and streams used mainly for carriage and over-sea commerce; which appurtenance happily inspired a Waterways Commission, yielded a Constitution, and established a Nation in a manner none foresaw save possibly Washington.

To the Fathers the Land, with its incidentally appurtenant water, was enough; they wanted little more—and none too much of that! George Rogers Clark and Benjamin Franklin were viewed askance because they brought into the infant country more territory beyond the mountains than the strip for which the Fathers fought along-shore,

SEP 12 1908

and Jefferson was all but sent to Coventry when he bought an empire for a song—just as within our own memory "Seward's Folly" was a synonym for resourceful Alaska, and even within a decade McKinley and Wilson and Day were derided for opening over-sea lines for our teeming growth. Lulled by woodland zephyr and prairie breeze, the pioneer forgot Eden and its penalty in the sweat of his face for the posterity of men; revelling in boundless acres, he even forgot the line of his loins, and cravenly and impotently swore "Posterity be condemned! Let posterity take care of itself!" Thus he blasphemed the blood of those who fought for Land and Liberty, and foolhardily jeopardized the Nation woven of their lives! So patriotism waned.

Yet prosperity spread apace over fair America; for the fruit of the ages was ripe unto harvest. The half of what he did not eat the settler wasted, and most of the rest he turned over to budding trusts to be used in shaping shackles for his own ankles and wrists; so that after thirteen decades of the freedom for which the Fathers fought, certain seven men—none chosen of the people—hold in their hands the industrial and commercial destiny of eighty millions of citizens! So substance was scattered away and tyranny trained up.

A new revolution began—for every revolution is at bottom mental—when citizens saw a decade past that ravage of woodlands sacrifices streams. Already the story is old. There is still wood enough to last half a lifetime at the current increasing rate, and it is growing a quarter as fast as cut; but the homestead spring has dried up, the mill-stream is shrunken to a slimy thread, the old-time dell is torn by storm torrents, the river is beset by bars, the river-side field caves into the flood a rood at a slump, while the richest of the soil washes into the sea at the rate of half a ton each acre-year. Such is the lesson of the disappearing forest; naturally it led first to uneasiness, later to full awakening; and at last to an inventory of resources, and an analysis of their relations.

During the thirteen decades of American independence, domestic iron production has increased from nearly nothing to over 50,000,000 tons per year; the consumption from less than ten pounds to 1,300 pounds per capita. The original stock was some 10,000,000,000 tons; and while only about 750,000,000 tons have been consumed and wasted to date, if the current rate of increase continues the annual production will within thirty years reach more than half that amount—and before the end of the present century our iron will be gone.

When the Declaration of Independence was signed there were in what is now mainland United States about 2,000,000,000 tons of coal—then but a useless black stone, of which little was used until within a century. Already some 9,000,000,000 tons have been wasted and destroyed, and 7,500,000,000 tons have been consumed in ways so wasteful that less than five per cent of its heat value has been turned to useful account. The consumption is increasing beyond belief in any earlier decade; the mere increase in 1907 over the use in 1906 was greater than the total consumption in that Centennial Year (1876) in which America became known as a leader among the world's manufacturing nations. In 1907 some 450,000,000 tons, or over 5 tons per capita for our 84,000,000, were taken out of the ground; and if the current rates of production and increase continue, all will be gone by the end of the next century. And still more woeful is the tale of oil and gas, already largely squandered!

The birthright Land of the thirteen Colonies for which the Fathers fought comprised some 200,000,000 acres, of which a full half was felt forever worthless save for rocks and swamps and trees; but the remaining hundred millions was thought enough for the Nation for all time. With the Clark-Franklin claim allowed at Geneva, Jefferson's Louisiana Purchase, the Florida acquisition, the Oregon discovery and demand (less the spiritless surrender of "Fifty-four forty or fight"), the Cali-

ifornia conquest ratified at Guadalupe Hidalgo, the Gadsden Purchase, and the Texas adhesion, the estate increased tenfold; and each accession brought its greatest enrichment in strengthened national character, as elsewhere told.¹ Of the 2,000,000,000 acres "more or less" of the mainland "lot or parcel," some three-fifths is semi-arid, and arable only in spots; so a mere billion acres is suitable for settlement—of which the most fertile 75,000,000 (a richer heritage than that of the Revolution) is swamp or overflow land, serviceable only after drainage. To-day "Uncle Sam's farm" is virtually gone; no more arable acres remain to be given away. Whenever a vacated parcel is opened to settlement, it is seized in a day by soul-searing gamble or disgraceful rush or paralyzing wait-in-line. Except as Science bids the desert blossom, or commands the field to yield two ears of grain where a blade of grass grew before, the limit of the land has been reached.

When the American Constitution was framed on the foundation of interstate waterways, the rain fell on the just and the unjust alike, little recked by either; now the interstate rain is the basis of prosperity, and a coming foundation for even closer union among the People than that written down in the Constitution. Some 200,000,000,000,000 cubic feet of rain descends from the heavens each year on the 2,000,000,000-acre farm of mainland United States; and with a half or even a third of the acres to receive the boon, were it equably distributed the population and productivity, the manufacturing and merchandizing, might be great as they are—with an advantage in reduced cost of transportation. Nominally, lands sell by the acre or foot; actually the price within ten per cent is fixed by the associated water. In verity the 200,000,000,000,000 cubic feet, or ten Mississippis, of annual rainfall is the sole effective capital of the country; without it the land would be desert, devoid of tree or shrub or other living thing.

More than half (say five-eighths) of all is evaporated to temper climate, form dews, and re-descend elsewhere; a fifth goes down to the sea in rivers; say an eighth is stored for a time as ground-water; the remaining twentieth, or half a Mississippi, is stored or used in the ontosphere—in the living structures and functions of animals and plants. The time of storage is short; an animal may survive a week, a humid-land annual plant six weeks or a tree six months, without renewed supply; springs fail and brooks run dry under a three-months' drought. Were a rainless year to come, half the lesser rivers of America would dry up; within seven such years in succession, the Mississippi and Colorado would cease to flow, and within ten the lake-fed St. Lawrence and Columbia would be no more. While the witchery of water still appeals—and all the more by reason of better knowledge—the days of witchcraft and mystery of waters are numbered; for Science has risen to show the sources of spring and well and brook and river, of flowing sap and pulsing life-blood—and all run back to the life-giving benediction of the clouds. Yet because the grandsires of the Fathers were from riverless islands of ample rains and virtually waterless statutes, they and their sons were slow to see natural wealth in water; and it is the irony of American history that the interstate waters which yielded a Constitution were half-forgotten for a century—before a realization of their value arose, begotten of bitter experience in arid regions. For the deepest impulses of Humanity have been inspired by water in dearth rather than abundance; the altruism of which Civilization is the fruit bloomed first in the world's deserts—and necessarily so—as told elsewhere.² The rivers of America form ways of commerce, virtually abandoned through legislative ineptitude and an administrative apathy now happily ended; and in their natural head lies

¹ "National Growth and National Character," *National Geographic Magazine*, Vol. X, p. 186, 1899.

² "The Beginning of Agriculture," by W J McGee, *The American Anthropologist*. Vol. VIII, p. 350, 1895.

power, far beyond that of the hundreds of millions of tons of coal consumed each year, of which but a fraction is harnessed—and most of that monopolized. Their freshets due to deforestation destroy houses and goods to the value of \$150,000,000 annually; their increasing impurities cost lives in thousands; their myriad feeders lick the cream of the soil from the Nation's fields to the measure of a billion tons a year, cutting down the annual crop-yield grievously—say from \$8,000,000,000 to \$7,000,000,000. The destruction wrought by waters running wild is vast; the half of an average year's loss applied over a decade of judicious improvement would tame them forever, terminate the destruction for all time, and bring the Nation's richest resource under complete control. How long will the folly of sluggardly somnolence continue? How long will the People permit the penny-wise pound-foolish policy to persist? How long—how long!

When the lotus-eaters forgot the travail of the Nation's birth, and condemned their own posterity to perdition unknown, national spirit oozed out of their idle fingertips. They wasted what Nature saved through the ages, scattered that which their sires garnered, ceased to consider the fate or even the fact of posterity—so that the very blood of the birthright Land is become of alien tincture, and homes are given over to foreign Lares and Penates. Thus unity grew lax, and patriotism weakened; standards of morality sank below normal instead of rising steadily as is their wont; and the budding notion of national efficiency was chilled back. Monopoly sought to enslave citizens to its sordid behest, and workers retaliated by restricting their own capacity to that of the most incompetent of their class, whereby actual efficiency—which grows by exercise—was lowered. The industrial twins, Labor and Capital, quarreled and disturbed the national household by their bickerings and the anathemas of

each against the Mother of the other; and from darker corners Anarchy thrust a hideous head. Yet, as deeper darkness presages dawn, the enfeeblement of national spirit but made way for the new era in which Patriotism looms loftier and larger than ever before—and with farther foresight. No longer able to dispense acres equally to all, the National instead affords equal opportunity for all to develop a wider range of resources. To-day there are four foundations for prosperity in lieu of one. The Land remains, and in increased worth by reason of intensive treatment rather than extension of settlement; the Forests accumulated above-ground during the centuries and the Minerals below-ground during the ages have acquired worth through the orderly growth and natural development of the country; and Water is coming within ken as the basis of prime values on which all others must depend, and as an inalienable birthright of the People—a common heritage for the common interest, to be administered by Nation and States jointly as befits its interstate character, but never to be withdrawn or withheld from direct control by citizens for their own common good.

Just as the Land for which the Fathers fought was at once the tangible basis and the inspiration for patriotism in an earlier day, so in this day the birthright Land, the soil-making Forests, the native Minerals, and the life-giving Waters inspire Patriotism anew. Each is well worthy of story and song and shrine; and each inspiration is warmer and the whole are knit in closer union by reason of each other.

In 1776 the Fathers of the United States joined in a Declaration of American Independence; in 1908 the Governors of the United States joined in a Declaration of American Interdependence. The first Declaration marked an epoch in world-progress through extension of free institutions. Can the second do less in its intensifying of the spirit of such institutions?



WORK ON A NATIONAL FOREST

No. 9. Chiefly Concerning Horses

By CHARLES HOWARD SHINN, Supervisor Sierra National Forest

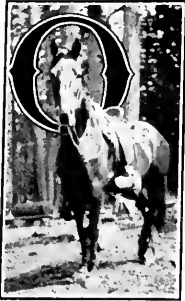

ONCE upon a time a supervisor had a brilliant idea; it was in the holiday season, and in Land Office days. He was so beautifully young that he looked on all those who sat upon far-off thrones of authority as merely mortal like himself, and as just as willing to take a josh. So he put in a regular requisition for half a dozen centaurs "as an experiment of great scientific importance to American forestry." He further specified that he wanted "two white ones, two black, and two bald-face sorrels, all warranted sound in wind and limb."

I have heard it whispered, where inspectors congregate, that this supervisor very nearly lost his position. His request was not considered at all funny; in fact, one dignified official termed it "impudence." My friend got back from the Great Office the proper form, redly stamped "Not in Stock." "No date can be set for the delivery of these articles." There the incident closed without a tragedy.

It is just as well, perhaps, that no centaurs were to be had, because their rating must have troubled the civil service, and their social standing at our annual meetings would have been a problem of fascinating complexity. But how convenient and how effective a few intelligent centaurs of the classic Chironian type could be made up here in Sierra every day in the year.

(I do not mean the gaudy brand of patent-medicine poster centaurs; I mean, of course, those wonderful creatures of whom Maurice Guerin wrote.)

Can it be that none of these mighty and splendid centaurs are left alive in some far-off and mystic Thibetan valley of moonlight and forests to be persuaded forth by some ardent collector from the Department of Agriculture? Professor Hansen has done so well finding new Turkestan alfalfas that perhaps he might be sent after centaurs.

But, in truth, the ranger is the nearest that we are likely to get to those pre-historic centaurs, for very often he and his horse are almost one, and the horse seems the most essential end of the combination. I have no doubt that many of our boys figure more carefully on having enough hay and grain for their horses than they do on buying warm winter flannels for themselves. A very considerable part of our time is unavoidably devoted to saddle-horses, "packs," outfits, stables, pastures, and all that these things imply, include and require.

In the towns and valleys men too often buy horses just as they buy potatoes—for unromantic use. Up here in the mountains men buy more or less of poetry and companionship in even the most shag-bark Indian pony.

Once I noticed at a camp that a certain new ranger was distinctly given the cold shoulder by all the rest. He stood up under it with surprised and bewildered indignation. Of course, in such cases, one can't ask what the trouble is, but I rather thought he had made peppery remarks about camp life. In a little while, when we rode together, I saw exactly the reason; he had several beastly little ways of being mean to his horse, and this it was which had rubbed the rangers the wrong way.

So I took especial pleasure in telling him how it looked to others, and he

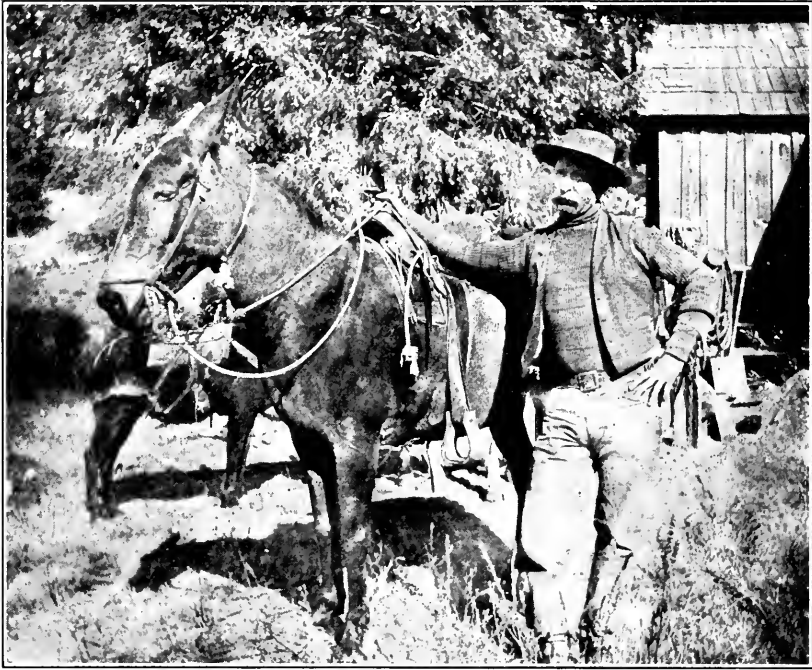

One of the Packers

forthwith mended his trails as best he might, according to his "temperament."

The last word is in quotation marks because even up here we hear it too often. A boy who had had several absurd little quarrels, once made his excuses by telling me that he was "very sensitive," and had a "quick temperament." So he had, too; he had several of them.

But to return to the horses. I think it evident that there has been a decided gain in the last three years, both in the quality of our horses and in our care of them. We really get more work out of our horses, too, and still they keep in better shape. They cost us a good deal more, though, both in purchasing price and in the keeping, for everything has gone away up in cost since the old times. Thirty years ago we bought the finest sort of mountain "mustangs" (as the old-style Spanish horses were called) for \$5 or \$10 apiece—just colts from a band of wild animals. Ten years ago we still bought good saddle-horses for \$25. At the present time we pay \$100, or more, and some of us think

the mustangs were better for hard work. Hay and barley, too, are twice as expensive as they used to be. The boys draw down more pay, but not at all in such a proportion as this. We have fenced pastures, which help us a great deal, but they are rocky and overgrown with brush. Besides, the soil is very poor. What is it, then, that has enabled our men to improve the grade of their horses a little and to take better care of them?

I think that these things arise from the increased certainty of the work, and the growing interest in it which is felt by the men. They are rangers now, but they begin to understand that their children may become trained and educated foresters. They feel safe in buying a colt and in handling him with especial care; they can even breed a colt sometimes; they are easier in mind about the whole thing.

Besides all this, our telephone lines begin to save us many of those heart-breaking all-night rides with worn-out horses, to carry news and ask for orders, at times when the poor animals

may have to turn around in an hour or so and hit the back trails. Our horses begin to have a chance to keep in condition all summer. That is one reason why we are doing our best to put up more telephone lines. We still have district centers up here in Sierra, from which it takes a week to get a reply to a letter! A few days ago we had ten fires all at the same time in our 3,000,000-acre forest. Summer thunder storms and lightning-struck trees started most of them. Our rangers were toiling everywhere; "dead on our feet," as one boy said. "Sixty hours

hard places, where no trails can ever be made, for it is a little and stupid thing to be merely able to follow a plain trail from one point to another. One only does that because energy should not be wasted. But there are times when you and your horse go together "across lots," following water courses, or ridges, or striking through an entirely new country, as if you had been dropped from an air-ship into the midst of a strange continent of Saturn. Then the horse draws strength from your intelligence, and you, if you are wise, learn to use more of his than you had



Rangers and Their Families Breaking Camp

without a nap," as another reported. Several rangers pushed their horses all day and all night, leaving one conquered fire to ride into another district and help the men there. So you may understand why one ranger, when the new telephone line reached his cabin went out and gave all his horses an extra feed of barley, and told them to celebrate the event.

But all the telephones on earth will never do away with the need of meeting men face to face, and so we shall always use horses on mountain trails and through the forests. We shall always have that quiet and perfect understanding between man and horse which only comes from lonely rides in

before thought possible. (At least that is the way that Tiapo and I travel together.)

You and your horse go down into some vast cañon where no trail exists, but which you mean to cross. Pretty soon you dismount and pick your way, your horse following, unled, with little questioning murmurs, and with his heart in his eyes. It is easily possible for you to get him down places that he cannot possibly climb up, and, therefore, if you do not think out a way back, inch by inch, as you go down, you may presently find a hundred feet of sheer granite, and so, being unable to go forward (or backward except on

foot), you may suffer the disgrace of having to abandon your horse!

Remembering all these things, you work down into that half-mile abyss of rocks and trees. You come to places where your horse draws his feet together and whimpers like a frightened child. You coax and explain matters till he slides down somehow. Now and then you tie him to some granite splinter, and go ahead to map the course; you roll rocks out of the way. You go back, talk to your horse; you blind-fold him for the last tremendous effort. And thus you toil together all day long from dawn to dark, and you cross that cañon which no one else has ever crossed with a horse, and you camp in a meadow unknown and lovely, untrampled by cattle, in acres of wild lilies and monks-hood. (Some one asks how you can camp without a pack? You have matches and a saddle-blanket, a tin cup, coffee, crackers, and a can of something or other. No one needs more.)

But after supper you say to yourself: "I seem full of aches; guess I scraped somewhere sliding down those rocks." And you examine yourself and find a dozen or more cuts, scratches, bruises, abrasions, and wrenches. If you were a townsman you would be sent to the hospital, but up here it only amuses you. Then you call up your horse to have a cracker, and you look him over to find that he is batted and spotted all over in much the same way as you are. But neither of you would admit that it was a high price for that cañon.

Some one asks me "was it absolutely necessary to go into such a place? Couldn't one ride around it?" Yes, and no, to both questions alike. There might be a possible power-plant site down there, or a line for a flume, or a new species of tree, you know. Broadly speaking, too, no one can rightly know his forest without conquering dozens of just such places.

"Then why not go afoot on these wild explorations?"

Possibly the horse wanted to go too. Anyhow, you feel afterward that it was a good thing for both of you.

But, returning to the daily routine of our lives, I note that the problems of meadows to camp on and of horse-feed summer and winter seem to grow bigger every year. We have more rangers and more horses. There are more tourists, more cattle-camps, more pressure on our grazing resources. Most of the people who come up here for summer are as nice as can be, but some of them rather crowd things. The rangers tell some odd stories around their campfires. I remember one which has a bearing on several of our minor problems.

There was a professor of social science in some staid and remote institution of learning who once came to California with his wife and sister, bought a lavish outfit, hired a guide, and climbed into one of the national forests, when, as the fates would have it, he came into conflict with a sixty-dollar forest guard.

This guard had fenced in about fifteen acres of meadow, where he camped and went every day to work trails, look out for fires, and generally improve things.

One night, when he came back from a smashing hard time of it, rolling big rocks into a creek to keep it from washing out a trail (and a lot of young pines, besides), he found the social science man and his party camping at his spring, and their eight animals were in his pasture. There was a sign on the gate, "*Property of the United States,*" and the gate was padlocked, but the professor had ordered the guide to make a hole in the fence.

The guard (who has my sympathies) tried to express himself, and suggested other camping places, not far off. But, as he said later, "The professor was a dinky little dude, an' the guide was just a stable boy from San José. But his hosses was extra hungry, because they hadn't had a noon-feed. Came right by lots of grass; an' his women folks were along, an' they

looked tired, too. So, I stood for it, an' helped 'em pack in the morning."

As I heard the story, none of the foregoing was known to the supervisor of that forest, who happened to meet the social science man a few days later. He could not but notice that the professor was entirely out of touch with his environment, that the so-called "guide" was hardly worth choking, and that the ladies of the party evidently expected something to drop. (You will please remember that the social science man had been cavorting around in the region for several weeks, and had had many and peculiar experiences with people.)

The sociologist complained that a forest officer had used a swear-word at him—a real big and naughty word, because he put some horses in a Government pasture. There was plenty of feed there. The impudent officer should be dismissed from the Service. And he presented his card, which the supervisor examined with humble admiration.

Then the supervisor, according to the story, asked everybody to rest in the shade, while he told them about the forest guard, and the regulations.

"This guard," he said, in closing, "whose pasture you took possession of gets \$60 a month, and furnishes his own outfit, which cost him \$175. He helps his mother, and helps send a sister to school. He is developing into a fine, capable American citizen, doing very effective work, on one of the real fighting lines of our civilization. If you and your guide had been alone, you would evidently have been taught a lesson in manners and honesty that might have borne fruit in somewhat more useful public lectures on social science. As it is, you have been treated with extreme forbearance."

Of course, this was the "exception that proves the rule." Almost universal good-will exists between tourists and forest officers, and they help each other in a thousand ways.

Rangers vary much in their horse outfits—the personal element enters broadly into small details. They often, when "green hands," begin with the or-

nate and expensive. They usually end in a severe simplicity of strength and fitness. What they reach at last is "just everyday use" for our mountain wear. It isn't at all the "cowboy rig" of the Southwest, for no roping is required and so the saddle can be much lighter. Then, the riding is different, too. We seem to be feeling our way to a distinctive manner of our own on horseback. A sort of easy alertness and interest in the work that never lets up, that takes no sprees after pay day, and that deals with a great variety of subjects. The man knows, and the horse knows, and both like it. The nervous little Indian ponies are dropping out; we ride stronger, quieter horses than we did five years ago.

The "new chums" come in and at once begin to worry about horse-flesh. Once four or five of them, after much consultation, took leaves of absence, hired horses, and rode over the valley towns till they came back with the most forlorn collection of Rosinantes that wily ranchers and livery stables ever worked off on unsuspecting innocence. They had raw colts with wicked eyes, and staggering, old staggers, welted and collar-sore. These they proceeded to "break," on successive Sunday afternoons in camp, while older rangers smoked, and looked on in great contentment of spirit. One of these, when he could stand it no longer without breaking up into pieces, got me out behind a tree and said:

"That wall-eyed brute that the new fellow from Sonoma is educatin' to a saddle has been on an eight-horse team down in Fresno for 'bout twenty-nine years to my certain knowledge!"

Does any one think that the older rangers should habitually protect newcomers from these things? It cannot be done, and if it could be would hardly prove wise. You must not take away from a young man these drastic and self-illuminating experiences.

For myself, I do remember well that when I was a callow youth of eighteen, teaching my first school, I was beguiled into a series of successive horse trades, in the course of which a hundred-

dollar colt was reduced to a twenty-dollar crowbait of uncertain age, whose temper and countenance were alike, "cut bias." At the time I thought the world was cruel but infinite values, and no end of delight, have I had from it since then. So, I think it passing well to let our new boys find their own horses and learn as they choose in the famous dame-school of Mistress Experience, whose limber birch-rods all of us have known.

I have sat among the rangers, time and time again, asking them about their horses. It will not work; they cannot tell things themselves. But the things sometimes leak out like mountain

"Wouldn't ride this beast, but can't afford a new one."

"He is spoiling your naturally sweet disposition," I remarked.

The ranger grinned: "A loco horse generally makes a loco rider. I wish I had a horse I could care for."

We care almost too much for some of our horses. I know a ranger who ruined two fine colts, worth \$125 apiece. He married and took his young wife back on the ranges, reporting cattle cases. They camped on a meadow where the colts ate wild parsnip roots, and so died incontinently.

"My little wife she cried all that night over her pet colt, only broke that



Forest Inspector Meeting Some Cattle Men

springs in the rocks. You note that one ranger, for instance, has a horse that he watches with extreme care. He carries a pistol, in fact, so as to kill the animal if need be, to save his own life, or that of some one else. The horse is an "outlaw," desperate, treacherous, more than half-crazy at times. Behind all this looms up a story too long for this article.

One ranger whom I asked why he rode that "outlaw," said tersely "When he wants to he can wear out three common horses."

Said another ranger, whose "outlaw" horse was liable to cripple him if vigilance were relaxed a second:

spring, and gentle as a kitten. We had a hard time getting anywhere. We just cached our packs, and rode the old plugs out, and felt bad all the way. I wish the Government could insure our horses."

I know a ranger who owned a very safe and capable horse. One day this ranger tied a long cross-cut saw on the top of his pack, for he was going to saw logs out of the trail. He was an old, experienced ranger, and a fine packer.

Well, the saw worked loose, in part: it slipped, cut the poor horse's hips, and of course he ran. The saw flew loose at one end, swung so violently as the

horse ran that no one dared to run in; it kept on slashing the horse, tore him almost to pieces, cut off one foot, and he fell over.

"My horse whinnied as I came up, asked me to help him, held up his leg; I just pulled my gun and shot him."

Thus one gets both comedy and tragedy in these simple tales of rangers and their horses. In every story up here, one is apt to find that a horse really belongs somewhere. I have seen two old friends drop silently apart for a time, and then, slowly, painfully come together again. It is some colt which both wanted, or a remark about horses,

companion in hard places a faithful horse can be. Read Kipling's "East and West" ballad; read of great Roland in Browning's poem, and the mighty black charger in "Lady Geraldine's Courtship." Think, too, of that desert "stallion shod with fire," in Bayard Taylor's immortal love song. And, of course, you remember John Brent, and his Don Fulano, storming on and on through the Rockies to save life and honor.

Give us time, up here in these great mountains, and perhaps facts shall make such brave tales as these about our horses and our men, and we, too,



Rangers Ready to Start Out

stupidly repeated, which has made the trouble. Then, seeing this rending of old ties, you can understand the earlier races, the tribes of forest-men, who had only swords and horses. You remember legends of tall, golden-haired youths who fought to the death for some splendid warrior-steed! You remember how young Sigurd went to the Meads of Gripir for Grayfell, the Gift of Odin. Up here, in our mountains, we love those ancient tales of men of weapons, and of horses, when the world was new and the stars were near.

Literature and history are crowded with stories that illustrate how good a

shall become legends and inspirations.

It may happen that some ranger's wife, or daughter, or sweetheart, will take an unbroken colt from the pasture, and ride him at full speed up the pass, all fearless, in black midnight, to carry some fateful message, to gather men to stop a forest fire, to follow some criminal, to save some life. Here and there, as the years pass, in Oregon, or Arizona, or California, or elsewhere, all along our chain of forests, men's horses will fall under them, worn out or heart-broken in sudden stress, and so given to the Service by its servants,

as everything else is given, in utter gladness of heart.

When the work of this generation is done, when the place of this new profession is fully established among men, and when even these joyous fighting days of ours appear as remote as the cave-men and hairy mammoths, it may be that here and there in especially favored forests (of which may Sierra be one) there will be traditions still lingering that once, in the Days of the Beginnings, were very strenuous men who rode great horses everywhere, and boldly fought evil, and earnestly created good-will, and so made possible that more scientific forestry of which they had only visions.

Yes! it may even happen that here and there some granite boulders, or some great pine planted 300 years before, on some ranger's grave, will say to all the world: "Here—just here—a nameless ranger laid down his life, just

to help the forest that he loved. Just to maintain the great traditions of the Service." And men, looking, will say to each other: "These were the very foundation stones of the Temple of Forestry. It has been builded upon such lives as these, and on the lives of thousands of others to whom no chrism of martyrdom came, but who were just as faithful. All of them labored on in darkness as in light, in lean years as in fat ones, under withering criticisms, just as earnestly as in the sunshine of public praise. The Temple is builded because men could once run and ride, could fight and laugh, and live more keenly than we in these late days."

Then, saying such things as these, men will envy us of this very year, forgetting our many mistakes. We shall lie among our rocks as Beowulf in his sea-mound, seen from afar, a guide to the ships and a word in the mouths of men.

On the Trail in the High Country

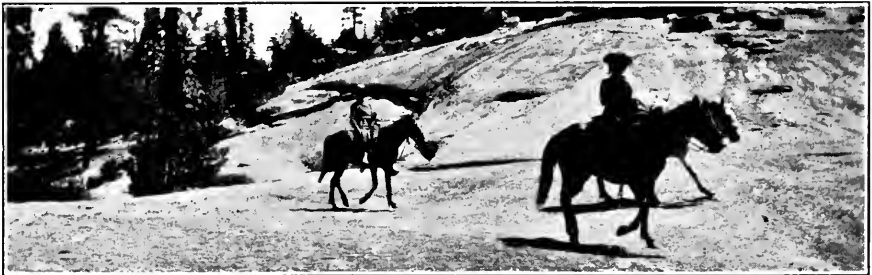

FOREST POLICY OF PENNSYLVANIA

By JOHN L. STROBECK

OWING to the stand Pennsylvania has taken with regard to tree propagation, in accordance with the principles of economic forestry, she now occupies a position the prominence of which is not the least of her assets. I say assets because it is that prominence which acts as a continual incentive to interest with the landowners in forest preservation and reforestation; and what can be accomplished by an aroused public is well known in commercial economy as well as politically.

But it is the intention to review and discuss the policies of the Department of Forestry of the state with regard to the public lands now under the management of the Department, rather than the economic status regarding private lands. The Department has under its management with absolute title 780,000 acres of forest land, with options for purchase on other lands to the extent of 125,000 acres, which represents nearly \$3,000,000 paid-for titles. However, Commissioner Conklin places a conservative estimate of \$5,000,000 as the actual value based on current values of these lands to the state at the present time.

Pennsylvania stands second among the states in the number of acres of state forest land, New York alone exceeding her. But if liberal opportunities continue to be given for the purpose of purchasing forest land, it is a question of only a few years of time before the state will lead in this respect also. In fact, it is the express desire of Governor Stuart, as given in a speech at Bethlehem this summer, that the state continue the purchase of forest land until it has in its possession or control a total of 6,000,000 acres.

Localities where discontent arose when acquisition was first attempted,

are now reconciled in the majority of cases because of the advantage afforded—

(1) To the poor mountaineer, in whose vicinity the greater areas of the Reserves are situated. He secures labor with more ease, since improvement is also necessary under the policies of the state aside from the usual harvesting which was carried on formerly; and harvesting also requires more labor because of the conservative and efficient manner in which it is done. More labor is therefore, the result, and this strikes a responsive chord in this class of people, which ultimately places the Department in their favor.

(2) Because of the advantage afforded the small landowner who can rest in greater security from devastation by fire, owing to his close proximity to state lands, where protection is a noteworthy feature. He also secures an advantage when he is given work by the Department during portions of the year when his labor is not required on his own property. He secures winter labor, when formerly he remained idle during the colder months. He also enjoys grazing privileges on an equality with the large stockraiser, for rates are the same to all, and his allotment is his only so long as he pays the rates. Of course these advantages are not always clear to him, for his interest generally lies locally only; but it is surprising to note how speedily these people are coming to an appreciative frame of mind.

(3) Because of privileges accorded sportsmen. Although restrictions are posted over state lands which require observance, yet they are very reasonable and still more effective, and the sportsman has the additional advantage of avoiding trespassing processes. The game commission, by authority and ap-

propriation of the legislature, has thus far established three game preserves within the state since 1905 for the propagation of game protected by law. The Fish Commission is stocking the streams of the state with various species of fish, and generally, are favoring



Breaking Ground for Nursery at Asaph, Pa.

the Forest Reserves in allotments. The Forest Reserves indeed are fast becoming the sporting grounds of the commonwealth.

(4) Because of the privileges granted in the form of permits to camping parties; picnics being allowed for a day without such permits, although regulations must be obeyed. Thus the population of the cities has privileges which are public and without discrimination.

(5) Because of the advantages given in private commercial economy. The Department has the approbation of the commercial interests of the state in the promulgation and furtherance of its policies. This interest takes a moral as well as a business aspect although the moral aspect finds its adherents in others besides the commercial interests. The business interest sees for its posterity the redemption of a moneyed cause; the moral interest the well-being and pleasures of its descendants; the business interests depend on it for the continuance of commercial aggression, the moral interest for the dependance and stability of human wants.

The commercial interests, of course, include the lumbermen. State Forester Wirt stated the attitude of the lumbermen very effectively after a recent in-

vestigation of the matter when he said: "Lumbermen who operate largely are almost wholly reconciled to the policies advocated by the Forestry Department; the discontent is evident among those who do not understand the proposition."

(6) The farmer is naturally interested more in his woodlot, which question I do not intend discussing. (Let me say that I wish to discuss only the situation with regard to state land and that only in brevity, for fear of extending this article to undue length.) But he also has both the business and the moral interest—business interest for the propagation of trees for the making of fence posts, rails, building material, etc., for the continuity and perpetuity of value of property for himself and descendants, and also that moral interest inherent in the majority of us, namely, the perpetuity of comforts and

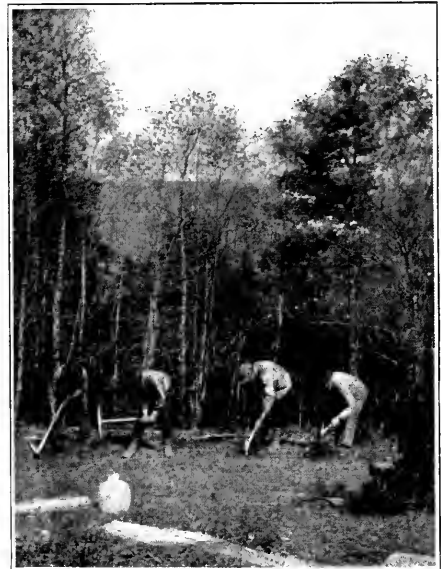

Preparing for Transplanting

benefits of the influence exerted by the forest. Undoubtedly, the farmer views the question of water conservation with the least complacency, for it is he who gets the direct results in this respect, for inundation during flood time is the cause of considerable loss to the farmer



Young Growth, after Land Was Once Lumbered

although few statistics are available on this subject. But cities and towns suffer enormously from this cause yearly, especially Pittsburg and towns in western Pennsylvania. So it can readily be seen that water conservation enters very largely into the arguments and weighs very heavily as a reason for forest preservation. Therefore, it is a question which concerns the state as a whole, and its moral consideration has caused an awakening.

Probably Pennsylvania has not recognized the necessity of conserving her forests at the earliest opportune time, but nevertheless, she is one of the first to give it recognition and undoubtedly foremost in the manner in which she is meeting the problem. Her policy pertaining to management is particularly farsighted and efficient in that she not only sees the advisability of conserving the inherent benefits of the forest, but recognizes the fact that thorough and efficient management is the only means by which this trust of the people can be discharged effectively and profitably; and to this end and for its consumma-

tion the State Forest Academy was established in the year 1903.

The question "Is it the object to educate in the State Forest Academy men for management of the State Reserves, rather than technical experts in the various branches of forestry study?" was put to State Forester George H. Wirt, principal of the Academy, who is also a technically trained forester. He answered emphatically "the former." In fact, the father of the institution, Dr. J. T. Rothrock, had the idea of management uppermost in his mind when he founded the Academy, and to this end the tendency has been most marked, although technical training constitutes a very important and extensive part of the curriculum. It would be an easy matter for the Department to secure men with business ability to manage its reserves, but men of ability with a particular business knowledge must be educated.

The popularity of this movement by the Department can well be gauged by the number of applicants who competed in the examination held at Harris-

burg, July 1 and 2, 1908, for entrance September 1, 1908. It is the intention of the Department to limit the number of students enrolled to thirty, and since students to the number of seven out of a total of twenty-nine, which is the present enrollment, will complete their course of three years, and will be assigned to work on various reserves September 1, there is room for the admission of only eight students this fall. For this number of appointments, fifty-five applicants took the examination, the appointments being given to those who attain the highest average in physical and mental examinations.

The new dormitory is now completed ready for occupancy, or rather half of the proposed plans have been completed. An appropriation of \$15,000 had been received from the legislature of 1907, and this proved insufficient for the erection of a complete dormitory. The Department is awaiting the pleasure of the legislature of 1909 for an appropriation for the completion of the dormitory.

Two classes have been graduated from the Academy so far. They have been assigned to work on different reserves where the work being done is really commendable.

The state has three well-established nurseries at the present time, each in charge of a graduate of the Forest Academy. The Mont Alto nursery is the largest seed-bed nursery in the United States. It is now growing 469,895 two-year-old and 2,250,200 hardy two-year-old white pine seedlings, besides Scotch pine, black walnut, European larch, and hard maple, which makes a total aggregate of over 3,335,000 seedlings. The nursery at Asaph, Tioga County, is making an equally commendable showing. There are at the present time 279,580 two-year-old and 600,000 one-year-old, making a total of 879,579 white pine seedlings in beds in the nursery at the present time, besides a small number of other species.

The nursery at Huntingdon is the smallest of the three, owing principally to labor conditions. But its showing,

comparatively, is on a par with the others. At the present time it is growing 500,200 two-year-old and 500,000 one-year-old white pine seedlings.

For the three nurseries, this makes a total of 1,239,475 two-year-old and 3,350,400 one-year-old white pine seedlings, or an aggregate total of 4,589,875 white pine seedlings. The Mont Alto nursery is the only one in which other species are planted to any appreciable extent. Seed beds of Scotch pine contain about 150,000 seedlings, but statistics of the other species could not be procured separately.

Mention must be made of nurseries in charge of rangers on reserves somewhat remote from the large nurseries. The ranger was formerly busy only part of the year during the fire season, and the remainder of the year he would spend part of his time doing odd jobs which would come under a ranger's duty; the remainder of that time he could not utilize in the interests of his position. The Department, therefore, has seen fit to have rangers who are located advantageously to prepare beds and plant white pine seeds, the first year generally to the amount of five pounds. Of course, they get the proper instructions as to the making of the beds, time of planting, method of planting, etc., and it is proving very profitable, especially in so far as it is a labor-saving proposition for the state and at the same time trains rangers in operations subsidiary to their positions, thus making them more efficient and probably more interested in their work.

These nurseries form the nucleus in which the foremost policy of the Department with regard to direct reforestation centers. Natural regeneration is secured wherever possible, but notwithstanding these operations, it is the intention of the Department to reforest the denuded hillsides and open spaces in the state as speedily as possible. So far, planting has been confined principally to the eastern part of the state. Open spaces and abandoned farm land constitute the greatest area of accessible land for planting in eastern Pennsylvania, since lumbering did not re-

ceive such intensive operation and regeneration progressed under more favorable conditions, thus leaving the hillsides in better condition in the eastern than in the western part. But now since the nurseries are increasing in output, it is expected that planting will be started on an extensive scale next year, especially in the western and central parts of the state. This year about 150,000 seedlings were planted from state nurseries, while the greater bulk of the two-year-old seedlings in the nurseries at the present time will be planted next year. Although white pine is planted more extensively than other species, because of its ready growth under soil and climatic conditions of the state, thus insuring the perpetuation of supply of one of the most valuable woods of this country; yet areas which have qualities peculiar for the growth of other valuable species are planted with those particular species. Thus black walnut is being propagated quite extensively, as is white ash, yellow poplar, and white oak. *Catalpa catalpa* and *Catalpa speciosa* have been tried, but have been found unfavorable to climatic conditions in the state, it being susceptible to injury by late spring frosts.

The policy considered second in importance to tree-planting by the Department is protection, second in importance not because tree-planting is more essential to forest betterment than protection, but that protection is fairly well organized while tree-planting is still in its infancy, thus making it the paramount question to be solved. Protection, however, is the largest item of expense of the Department, and will be the largest item of appropriation to be requested of the next legislature. The building of roads and fire lanes is an expensive operation, particularly over the mountainous contour of western Pennsylvania, also to a lesser degree in eastern Pennsylvania; notwithstanding, the work is progressing rapidly, the more speedily in the eastern and northern parts of the state where alleviation from danger is paramount to the well-being and expected maturity of the

young growth which is the more prevalent. However, it is the intention of the Department to extend these operations over all state forest land just so speedily as efficient management can be secured for the continuance of these operations. We agree that it is going to take a considerable length of time to place the management of these lands upon a scientific basis, for all depends (1) upon the liberality of the succeeding legislature, and (2) upon the speed of maturity of advantages afforded by nature's processes of growth. But the former depends upon the education of the public to the advantages of this advance, and it is encouraging to note the progress in this respect; the latter balances the former in that since appropriations cannot be expected in bulk, the maturity of certain areas to that point where improvement of a certain kind is necessary gives continuous lease of time for succeeding appropriations, and the Department has taken that fact into account and has arranged its policies accordingly.

The idea of ultimate perfection in the ranger system includes the service of one ranger to every 5,000-acre tract of land under state management. To do this, more funds must be secured for their employment. All appropriations of the legislature of the state are specific—each item receiving an appropriation which is intended for that particular purpose; and in that respect, the Department is handicapped with funds not commensurate with their needs for the different items enumerated. But, nevertheless, all funds can be and are used profitably for their specific purposes, but probably not for the purpose which would be of the most advantage.

Rangers are located in regions where fire is the most destructive—namely, in regions where the growth is most advanced and more valuable. The southern and eastern parts of the reserves receive the most attention in this respect. During seasons when fire is probable, special fire wardens are appointed to work in conjunction with the regular rangers. There are at present fifty rangers at work, and

a corps of special fire wardens during fire season varying in number as the necessity for their services is apparent. Telephone connection is maintained by some of them and has demonstrated the advisability of a permanent system, which sooner or later will be installed.

By reason of this protection policy, the loss from fire has been reduced over half since 1902, the loss that year being almost \$350,000. With a continuous decrease of losses in the future, as has been accomplished in former years of state management, it is hoped that before long a minimum in losses from this cause will be attained. With a complete rangers' system and good roads and fire lanes maintained in condition, the Department will be able to accomplish its purpose speedily.

Methods of culture also enter into the policies of the Department, but (1) acquisition of land, (2) tree-planting, (3) protection are paramount and take

precedence in operation. Improvement cuttings are made quite extensively, but they are made generally for profit, although judgment in selection of trees to be cut is exerted and its benefit not lost sight of in so doing. Lumbering is carried on where trees have reached maturity, and also is done as conservatively and scientifically as conditions warrant. Experiments are made as to the burning of slash, the proper felling of trees, methods of transportation, etc., and conservative methods of lumbering generally. Scientific investigations are made of the growth of different species. Investigation as to the growth of rock oak and chestnut on the South Mountain Reserve has been completed lately and is on file in the offices of the Department.

On the whole, the state is making strides in the preservation and propagation of forests which is very apparent and at the same time commendable.



Lumbering in Priest River, Idaho, National Forest



NATION'S NEED OF FORESTRY WORK

A Report Made by Mrs. J. E. MacKisson, Chairman of the Forestry Committee
of the Missouri Federation of Women's Clubs

IN THE United States the science of forestry is a comparatively recent study. The reason, possibly, for the nation's late awakening to the necessity of forest preservation was the fact that in the early days of its history the wooded area was so vast that its timber resources seemed inexhaustible.

When our forefathers established their first settlements in America, it was one vast wilderness. With the exception of the prairie region in the West, the primeval forest extended from ocean to ocean. The pioneer, to make a little clearing for his farm, and to provide fuel and timber for his every-day needs, wielded his ax with relentless hand. Trees were felled by the wholesale and burned on the ground where they lay. The woodman's ax became the symbol of progress. Since, to provide for his necessities, trees must be felled, forest destruction seemed in the line of national development.

Later, when timber began to have a commercial value, a still greater destructive agency came in the person of the lumberman, who, reckless and indifferent, cut without thought of the future's needs. Seeking personal gain, he had no regard for the nation's welfare or the rights of posterity. Extravagance and waste marked his progress through the forests of the East and North, until finally, as a nation, we began to realize that our forest area was being rapidly depleted, and that our annual consumption of forest products far exceeded the supply furnished by the forest's annual growth.

Out of this realization grew that important branch of the government work, the Forest Service, with a definite forest policy, through which it seeks to

perpetually maintain that most valuable of the nation's natural resources, the forest.

What has been true of the Nation in regard to its forests is still the pervading order of things in Missouri, though its awakening to the necessity for forest preservation is still a thing of the future. With a forest growth extensive and valuable in the extreme, the need of forest protection has not been generally realized, as yet. With us, the ax is still the symbol of progress. The average farmer and homesteader feels that every acre of land should be cleared as speedily as possible, not realizing that certain sections of his farm could be devoted more profitably to timber than to corn. The lumberman, thinking only of present personal gain, is making such inroads upon the great forest section south of the Missouri, that, in ten years, our timber supply will be practically exhausted unless measures are soon taken for its protection.

Probably we do not realize the value of Missouri's forest yield. The value of the state's forest products for the year ending December 31, 1906, was \$24,679,476. For the same period, the value of the farm crops (wheat, oats, corn, etc.), was but \$23,378,194, and of the fruit crop but \$6,335,764—both of less value than the forest yield. Yet we speak with pride of our agricultural products and of the big red apple for which our Ozark region is justly famous, and rarely, if ever, refer to the forest, which yearly adds millions to the wealth of our state, and, if wisely used, would continue to add millions through all time to come.

To awaken an interest in this important subject, to educate public senti-



USE OF A NATIONAL FOREST
Sawmill in Operation in Eldorado County, California

ment to an appreciation of the vital relation between forests and human life, to urge definite and speedy action in behalf of forest preservation in Missouri, is the work which the Forestry Committee of the Missouri Federation has to do.

The work of the committee has been greatly hindered by the fact that it has been difficult to get accurate information regarding forest conditions in the state. Investigations along this line had never been made, and information of any but the most general kind was not to be had. During the last year, however, Mr. Samuel J. Record, of the National Forest Service, in cooperation with the Missouri State Experiment Station, at Columbia, made an extensive investigation of the forest resources of the Ozark region, the natural forest section of the state. Upon this investigation and the recommendations resulting, this committee will base its future work.

In Mr. Record's report, his conclusions and recommendations are briefly summarized as follows:

"1. The forest resources of the state are being rapidly destroyed with no thought of their continuation.

"2. The short-leaf pine forests will soon be entirely cut over with no opportunity for reproduction.

"3. The present methods of lumbering are very destructive, and scrub trees are rapidly taking the place of valuable timber.

"4. Forest fires are of too frequent occurrence and should be controlled.

"5. The laws against trespass and timber theft should be more rigidly enforced.

"6. Investigation should be made concerning the various agencies which damage timber, with a view to lessening the injury.

"7. The conservative management of woodlots is practicable and should be encouraged.

"8. Forest planting on prairie regions is very desirable and should be practiced.

"9. The establishment of a Department or Chair of Forestry at the Uni-



USE OF A NATIONAL FOREST

Band of 1,600 Sheep Belonging to D. W. Clark, Grazing in Holy Cross, Colo., National Forest

versity of Missouri is recommended, the instructor to be a technically trained forester, who shall have charge of the forestry work of the state."

According to this expert's opinion, the forest resources of Missouri are exceedingly valuable and special effort should be made to secure their perpetuation, and, as the policy of the past has been almost wholly destructive, the work of the future should be of a constructive nature.

To secure this desired change in conditions, this committee urges club women to take up two closely related departments of work: the encouragement of scientific forestry in the state, and of arboriculture as it relates to the planting and care of trees for shade and ornamental purposes.

Since most of the timber is under private control, the most important work to be done is the creating, by educational and persuasive means, of a senti-

ment favorable to forest preservation. The most effective agencies through which to work are the press, the club, and the public school. Through the press, both the city daily and the country weekly, an educational campaign should be carried on by the district chairman. The information thus carried into every home in the state would, in time, educate the reading public to an appreciation of the state's forest resources and the necessity for their preservation.

Through an observance of Forestry Day in the club and of Arbor Day in the school, this educational work should be continued. In the arrangement of programs, the economic, as well as the aesthetic value of trees should be considered. The value of the day lies not so much in the entertainment afforded or even in the trees planted as in the tree sentiment created and stimulated, that will lead to a bet-

ter understanding of the economic value of the forest and the need of a more conservative use of it.

While conducting this educational campaign, some practical work should be done along the line of arboriculture. The following lines of work are suggested:

1. Street and highway tree planting. There is much of this work to be done.

spring, the tree-butcher and his saw go forth on their work of destruction, under the delusion that this annual mutilation is essential to the life and beauty of the tree.

3. Protection of trees from telephone and electric-light wires. Along this line, there is urgent need of reform work. Wherever the lineman goes, tree-destruction and tree-mutilation in-



FOREST FIRES

Fighting Flames in an Adirondack Forest

Few of our country highways are tree-shaded, and, in the interest of both comfort and beauty, tree planting should go hand and hand with road improvement. Most of the towns have tree-shaded streets, but investigation will reveal the fact that the trees are in need of attention. They have been planted too closely together, are diseased, injured by horses, and mutilated by tree-pruners.

2. Use of proper methods in planting and pruning. Few people know anything about tree-pruning, yet every

evitably follow. Go where you will in the rural districts of Missouri and you will see long stretches of barren, ugly road, with gaunt, wire-strung poles on either side, in place of the beautiful, tree-shaded highways that should be a marked feature of every rural view. In towns and cities, the same conditions exist, and it is time that some restraining measures are taken.

5. Bird protection. Bird preservation is as essential, for economic reasons, as tree preservation.

The work suggested is but preparatory to the chief object which we have in view, forestry legislation. In accordance with the forestry policy suggested by the National Forest Service, your Forestry Committee recommend that a bill, establishing a Department of Forestry at the University of Missouri, be submitted to the next legislature. The instructor in charge of this department should be a technically trained forester, who should have charge of the forestry work of the state.

In order to secure this need legislation, a public sentiment in favor of for-

est preservation in Missouri must be created. In this work club women can give material aid by following the suggestions given in this report.

The forestry question is one of the most important before the people of Missouri to-day. If the existing forests are to be maintained, immediate action must be taken. This work is the Federation's opportunity to do something of lasting benefit to the state, and no effort should be spared during the coming year to arouse an interest in forestry in every section of the state.



WORK IN A NATIONAL FOREST

County Road Building in Pecos River, N. Mex., Forest



THE PLEA OF THE CITY ELM

By MARIAN MEAD. Chicago. Ill.

LONG years, a watchman of the woods, I grew;
The sanctuary of a thousand birds.
Sweetly the cardinal whistled, flashing bright,
Amid my springtide leafage; from my crown
The thrush at morn and eve breathed heavenly prayers;
The merry robin chose me for his nest,
And warred with barking squirrels for his rights.

Then came a day of ruin. Right and left,
The spicy woodland smoked; my comrades lay
Prey to the axe. The busy hands of man
BUILT in our ancient realm a human home.
I only left, with mutilated roots,
And crippled branches, strove to bear myself
As worthy warrior of the ancient world.

I sheltered with my boughs this human brood;
The children laughed to see the squirrels race
Along my rugged trunk; still, in the spring,
The piping oriole glanced from twig to twig,
And painted bluejays cheered the winter hours.
How grateful was my shadowy green in heat!
And all the year beneath the sun and moon
My boughs drank in the common fainting air,
That, by the secret power vouchsafed to me,
I breathe back ever to refresh the world,
Purified, and with healing in its wings.

But now, a weary state is mine. A swarm
Of smoking roofs surround me; noxious airs
Arise from every side; my roots are pent
In case of stone, and no enriching soil
Is given to feed them; scorching winds and dust,
Through the long summer days, my tender leaves
Shriveled and clog; and bring with them a blight
That kills off branch on branch. Even the weight
Of burdensome dead wood they spare me not;
And yearly weaker I, and stronger death.

Man sways my fate, for men my life is given.
Well have I served, and many years might serve.
Must I thus pass, neglected, from my post?
No longer look upon the silent stars,
And breathe the joyful sunshine, gathering thence
Strength for my sweeping limbs, my traceries
Of winter twigs, my burst of springtide bloom.
The summer glory of my towering green,
My shadowy cool, my power to bless mankind?

O, Master, generations yet to come,
Shall they enjoy the wholesome good I give?
Oh, hear this timely plea, and help the sum
Of long years' growth; help noble beauty live!

EDITORIAL

Change of Title

WITH this, the September number of the magazine, the lately-adopted title is used, and the magazine, instead of bearing the words "Forestry and Irrigation" on cover and at the head of its pages, will hereafter be known as CONSERVATION. We believe that under the new title the magazine will have a wider appeal, and will reach a more sympathetic audience than under the old, and we feel certain that its field of usefulness will be vastly increased.

It has been felt for some time that the old title did not express all that the magazine, as well as The American Forestry Association, stands for. As we said, editorially, in the August number, there is more to the broad world-movement for conservation than forestry and irrigation. The protection of the forests, and the reclamation, by irrigation, of the country's arid lands, present two phases of the movement, but only two. To be sure, these phases are the ones that have heretofore taken first rank, but the movement is broadening; for a long time, now, there has been a feeling that other natural resources besides those of the forests and the arid lands require attention. This feeling has, as all thinking men realize, increased in intensity and acquired vigor in the increase, until to-day there is no more vital problem facing humanity than that of how best to conserve ALL the resources of Nature, for the best uses of ALL mankind, not only for to-day, but for ALL time.



Our Duty to Posterity

MORE and more is the fact becoming realized that mankind owes a duty not only to mankind, but to the

children of men. Once upon a time—not so long ago, for that matter—a statesman, whose eyes Time has not opened, remarked, "Posterity be damned! What has Posterity ever done for us?" And a cackle of senile laughter accompanied the words. But, thank Heaven, there are men in this land of ours who have ideas more advanced than those of the statesman quoted here, and such men realize the truth of the statement that the generation of to-day has only a life estate in the resources of Nature—only a brief leasehold—and that to ravish those resources, leaving them exhausted for those who are to come, is as criminally dishonest—only in a far greater and more criminal degree—as to destroy a house that is held on the tenure of a year's lease. The man who, as a renter, would wantonly destroy and lay waste a property he occupied would be prosecuted in the courts; how much more, then, should such an one be punished if he lay waste, ravage, trample down, uproot and destroy beyond repair by those who are to follow him, any of Nature's resources? If it were true as many men have said, that to the present generation belongs the earth and the fullness thereof, and that posterity must take care of itself, what would become of modern civilization?



Not for To-day Alone

MORE and more is it coming to be realized that the conservation of natural resources is not a work to be done merely for the men and women of to-day, or to-morrow, but as well for the generations to come. It is not a work that is to be of direct benefit only to those who are now using these resources, but, if our children and our children's children are not to suffer,



SAFEGUARDING THE FORESTS

Twenty-foot Fire-line Protecting Nursery Belt, Santa Barbara National Forest

the generation of to-day must take steps to save the forests that remain; take steps to reclaim the arid lands; take steps to conserve and to utilize the waters; take steps to develop and to use the water-powers and the water-ways; to conserve the mineral resources—coal, iron, oil, gas, etc.—in short, to waste no iota of the resources of nature, and to develop to the utmost those natural sources of material wealth and comfort that have too long been neglected.



The Practical View

ONCE upon a time—every story that is really a story must begin this way—the Commercial Club of a certain middle western town was confronted with the possibility of the town's losing the use of a beautiful grove of hardwood trees. The grove was situated just at the edge of the town; it had never been made into a

formal park, but, having been cleared and kept in good condition, had been used for years as a picnic ground and for large outdoor gatherings. But, in the fullness of time, the owner of the grove received a good offer for the timber, and was minded to accept the offer. He gave the town first chance, however, and was willing to accept even a lower price for the grove than he could get from the concern that wanted it for the timber that could be cut off it.

The town council, however, failed to act; the delay gave the members of the Commercial Club an opportunity and a special meeting was called, to discuss ways and means of securing the grove for a town park. Nothing resulted from the first meeting; the members and their wives assembled and talked, and at the close of the talk "refreshments were served," as the daily paper remarked. A second meeting, and a third, were held, resulting in nothing but talk and ice cream and cake. At last a quiet, hard-headed old member

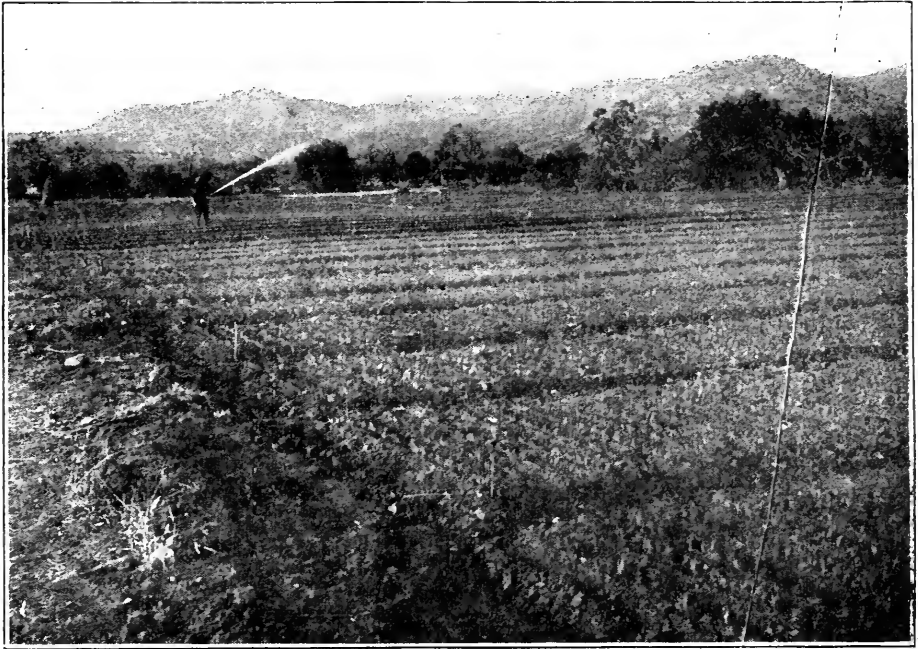

WORK IN A NATIONAL FOREST

View of Transplant Nursery. Transplants of *Pinus Ponderosa*. Gila River N. F., New Mexico

of the club, who had taken no part in the lengthy conversations, arose and remarked:

"Mr. Chairman, Ladies, and Gentlemen: I haven't said anything at these meetings, because it didn't seem as if there was anything for me to say. But I've decided that I ought to take part in this business, and with your permission, I want to ask a few questions."

As the gentleman happened to be the president of one of the banks, a director in the other, the heavy financial backer of the electric interurban line, and a few other things, he was instantly given permission to ask as many questions as he saw fit. So he proceeded.

"I believe these meetings are held to decide on some steps to secure Blank's grove for a town park?"

Yes.

"Mr. Blank has been offered a high price, by a sawmill company, for the timber in the grove?"

Yes.

"He has offered the grove to the town at a figure lower than the sawmill concern offers him for the timber alone?"

Yes.

"And now, we, the members of the Commercial Club, are trying to devise some means of protecting the grove from this sawmill concern and saving it for a town park?"

Yes, indeed.

"Well, ladies and gentlemen, I have attended all our meetings, have listened to a great many speeches, and I have heard a whole lot of eloquent descriptions of the beauty of the grove. I have heard all about what an advantage it would be to the town to have this grove as a public park, and I have helped to pay for a very large quantity of ice cream. I have noticed that we have all been pretty shy on suggestions as to how the town may be enabled to secure the grove, but I haven't seen anybody shy away from

the refreshments. Now, it seems to me that if we want to protect that grove from the sawmill concern and save it for a city park, it's time for us to do something. What we want, it seems to me, is more protection, and not so darn much ice cream."

The conclusion of that speech was



National Forest Use. Cluff Bros.' Angora Goats, on Range in Mt. Graham National Forest, Arizona

lost; nobody ever did know what the rest of it was. But the members of the club got to work, and the grove was secured for a park. To-day it is one of the most beautiful small "breathing spaces" in the whole middle West.

Does any one, anywhere, see the application?



Conservation, a World-movement

HERE in the United States we see only one angle of the conservation movement. We have heard of the condition of our own natural resources, and we know something about what the balance-sheet shows. We know—but are far from realizing—that in the very nature of things these resources are nearing exhaustion, and we are taking some feeble, tentative steps toward more scientifically utilizing

them and stopping the waste. But, with our characteristic Americanism, when we have taken a single step in advance, we stop and look around, calling to the rest of the world to see what we have done.

The fact of the matter is, the rest of the world is doing exactly the same thing, except that it isn't calling upon all creation to take notice. For years the countries of Europe have been doing what we are just beginning to do; Germany and France, Italy, Austria, Hungary, Switzerland, and even, within recent years, Spain—to say nothing whatever of England—have taken steps to conserve forests, to utilize waters, to care for soils; in a word, to take care of and render useful to the highest degree every resource of nature.

The worn-out, denuded and eroded lands of China, too, know to-day a small measure of conservation work, and Japan, most aggressive of Oriental lands, is putting into effect what are, perhaps, the most rigorous protective laws, as regards timbers and forests, as well as other natural resources, of any yet enacted by any nation.

In our own hemisphere we are not alone in the work of conservation. Canada's laws—forestry, mining, etc.—are well known; and Mexico, too, is undertaking on rather an extensive scale the work of caring for her natural resources. The Central American countries are making halting steps along the same lines, while in South America practically every one of the republics has written into its statute books laws having to do with the conservation and preservation of some or all of its natural resources. As long ago as 1880, Argentina passed a law to the effect that no trees should be cut and no bark removed without a concession properly obtained from the Minister of the Interior, and then only subject to rather stringent regulations.

Laws of 1894, 1897, and other years, relate to the conservation and preservation of lands, timber, and grazing, irrigation works, mining, fishing, hunting, the obligatory plantation of sold or leased lands, etc.

The national congress of Brazil is now considering laws for perfecting and making completely modern the control of the lands of the nation. The purpose of these laws is to establish regulations governing forests and waters, with a view to the complete

In Chile, as long ago as 1890, a careful study of the republic's forest area was made, with particular reference to the danger of deforestation. The history of Germany was used, likewise that of the United States; and forest laws were enacted at that time, looking toward the preservation of the remaining forests. Prior to that time laws had been passed offering rewards for tree-planting on private estates, and the work along these lines is being actively pushed at the present time.



USE OF A NATIONAL FOREST

Cordwood Cut on Gila River, N. Mex., Forest on the Cameron Creek Watershed

rational and practical conservation of natural resources.

Paraguay, notwithstanding its great interest in obtaining colonists, and its very liberal policy toward immigrants, yet has in force laws governing the use of the soil and fixing penalties for its abuse. In the granting of all concessions, rules are given governing crop rotation, timber cutting, and the replanting of lumbered areas.

Colombia, Nicaragua, and Guatemala also have taken steps toward the preservation of the forests and the conservation of soils and waters. The monthly bulletins of the Bureau of American Republics contain frequent references to the progressive attitude of the South American states as regards conservation of natural resources, and it is from that Bureau that the above information has been secured.

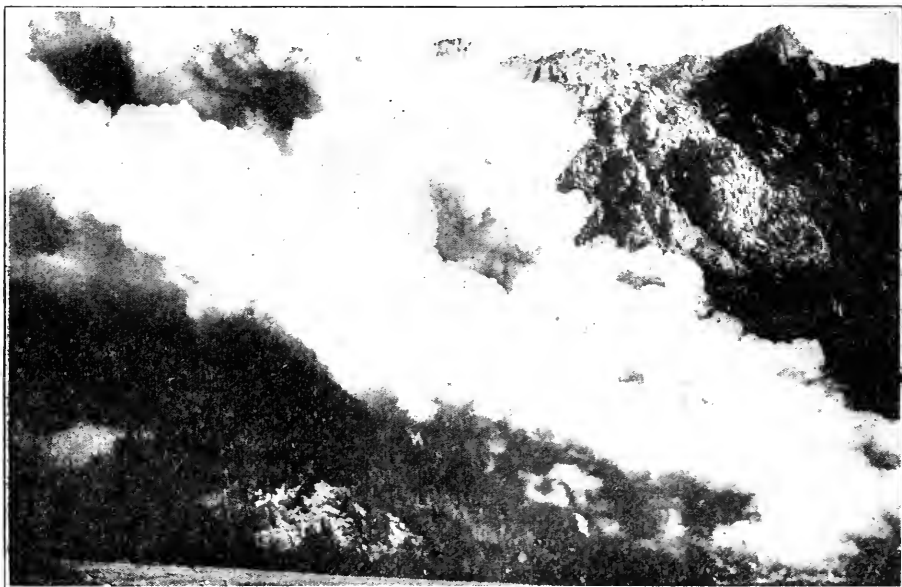

DESTRUCTION OF THE FORESTS

Fire in a Rocky Mountain Forest, Rosebud County, Montana

No; we are not alone in the desire to save our forests, utilize our waters, and waterways and conserve our soils and minerals. We are of a distinguished company, that embraces the thinking nations of the world. The cult of conservation is by no means wholly American; it is altogether cosmopolitan. And there is even a danger that we, as a people, may perhaps lag behind some of those other nations that we have believed to be far less progressive and practical than our own.

Forest Fires

AS THE summer advances the reports of disastrous forest fires become more frequent. From northwest, west, southwest, north, east and all directions, the reports of conflagrations come, until it would seem as if our timber supply, only estimated at sufficient for half a century or so, could not now last over a score of years.

The newspapers were full, a short time ago, of reports of the tremendous loss of standing timber caused by the

great forest fires in Alberta and north-western Canada. Several towns, it was reported, have been wiped out; hundreds of square miles of forest and range lands were burned over; many lives were lost, and the property loss caused by the fire, according to conservative estimates, will amount to \$5,000,000, or more.

In Montana—in the Helena National Forest—another disastrous fire occurred during the early part of August. Reports in the papers stated that this fire was caused by lightning, and lightning was also the cause of fires in the Sierra National Forest. Small fires are reported from other parts of the country; and, as a whole, the months of July and August have been disastrous as regards destructive fires in the forests.

In the case of the great Canadian fire, carelessness seems to have been the principal cause of the tremendous loss. The fire had been smoldering in the brush for days, never seeming to threaten any great blaze, and not being considered threatening enough to require attention. Finally, however, the wind shifted; a heavy gale set in,

blowing the smoldering sparks to a raging ocean of fire that engulfed and devoured everything in its path. The Canadian Pacific Railroad is reported to have lost several million ties, worth more than a million dollars, while the loss in standing timber, in crops destroyed, in the destruction of buildings and improvements, etc., ran the total up to an estimate of over \$5,000,000. Care would have prevented the fire; care in the first place would have prevented its starting at all. Hunters or campers, it is believed, left the embers of their campfire uncovered and unextinguished, and nobody seems to have thought it worth while to put out the small fire that later developed into a holocaust.

The fires on the American side of the border, in Montana, while not nearly so extensive or destructive, still were by no means trifling blazes. These fires,

and were finally controlled with a minimum of loss to the timber. The same was true in the case of the Sierra National Forest fires. Threatening at first, they were fought hard and system-



Fire in an Arizona Canyon

atically, and were put out within a short time.

Fires of this latter origin cannot be guarded against. Lightning rods for every tree in a forest would be rather an expensive proposition, but carelessness on the part of those using a forest can be prevented, to a large degree. National forests are posted at frequent intervals with conspicuous signs warning against the dangers of careless handling of fires; and fire-fighting is a part of the "curriculum" of forest officers. No blaze, no matter how trifling in appearance at the beginning, is ever allowed to gain headway, if it is possible to reach the spot in time; and if the blaze cannot be kept from increasing in volume, through inability



Fire Sweeping an Arizona Mountain

however, were fought from the start. Originating, it is believed, by reason of dead trees being struck by lightning, the fires spread rapidly, but forest rangers and guards were rushed in, the fires were fought systematically,

of the forest force to reach it in time, ceaseless effort is exerted by every available hand—often for thirty-six, or even sixty, hours at a stretch—to extinguish it. The annals of the field force of the Forest Service contain in-

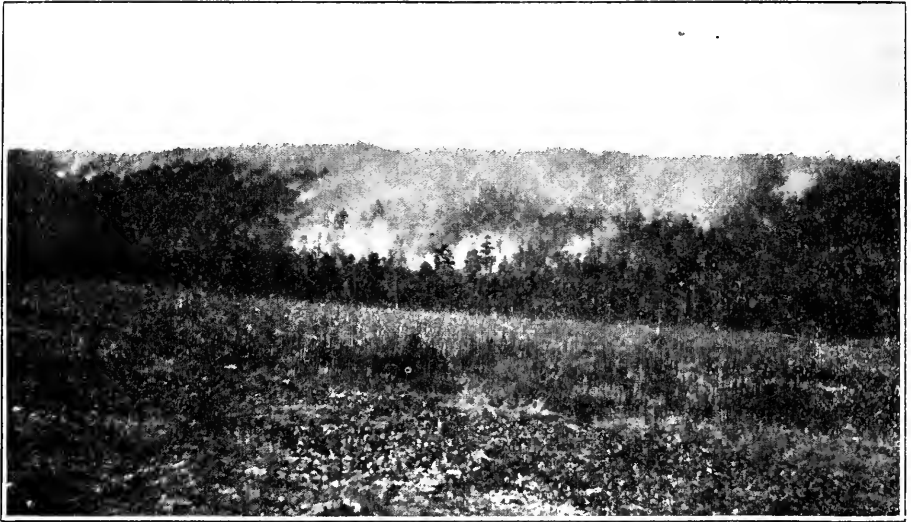

Fire in an Arkansas Forest

numerable tales of hard-fought battles with the flames; battles fought against apparently overwhelming odds and in the face of difficulties that would make the members of a metropolitan fire department quail. In these titanic struggles many a life has been sacrificed, and not a few of the Government's field workers have at last retired from fights of this kind, maimed, scarred, and crippled for life.

A few months ago a well-known writer — Mr. Emerson Hough — in *Everybody's Magazine*, told the story of the work of the Forest Service in the field. His story opened with the words, "My friend, last night somebody burned your house!" The words were startling, but they were absolutely true. Last month somebody burned your house, reader; somebody burned your neighbor's house; somebody burned, during July and August, enough houses to make a good-sized city. Five million dollars' worth of standing timber means a vast amount of sawed lumber; it means lumber enough for several thousand houses. That many homes burned when the flames ravaged the Canadian forests in the Northwest. Flames, at the time of this writing, were raging in the pine and spruce forests of Washington and

Oregon; they were threatening the destruction of the redwood forests of the Yosemite, in California; and from a dozen other points came the story of raging fires and doomed forests. The houses that have been burned, in this wholesale destruction of timber during the past two months, would make a city of 50,000 inhabitants. But still there are those who say "There are plenty of forests; there can never be a timber famine in America; there is no need for even the National Forests we already have." And they oppose the Appalachian Forest plan; they oppose the White Mountain National Forest; they continue, in the West, their opposition to the whole forest program of the Government. When will their eyes be opened?

The Next Annual Meeting

PLANS are now forming for the next annual meeting of The American Forestry Association, the date of which has been fixed by the Executive Committee. The meeting will be held in Washington on January 13, 14, and 15, 1909, and members of the association are urged to begin now their preparations to be present and to

help to make the coming meeting the most memorable in the association's history.

The plans contemplate the elimination of all dry, routine reports; such reports, it has been decided, are to be submitted in printed form, and the time of the meeting is to be given up wholly to the actual, live work of the association. It is the intention to have present some of the ablest speakers on the conservation problem, and to set before the country, in plain English unadorned with flowers of rhetoric, or unmarred with long tabulations of what the Association has done in the past year, exact statements of what is required in the way of taking care of our remaining natural resources. It is the intention to have graphic statements from acknowledged experts, of the exact conditions of the Nation's natural resources, and it is the aim of the Executive Committee to make our coming annual meeting as full of interest—not only to our members, but to the country at large—as was the conference at the White House last May.

It has been suggested that the individual members of the Association send to this office suggestions as to what, in their opinions, should be included in the discussion at the coming annual meeting. These suggestions, it should be borne in mind, should be brief and to the point; and it is hoped, from the mass of suggestions, to work out a profitable, as well as highly entertaining, program. It is the belief of those in control of the Association's affairs that the members should be urged to take a more active part in the work of the organization; and it is thought that by following the plan suggested above, a more active interest can be aroused and held. Suggestions along the lines here suggested will be gladly received, and this office hopes to find its mail well

filled with such suggestions from now to the time of the annual meeting.



Another Form of Activity

A PERSISTENTLY recurring suggestion that comes to the office of the Association in one form or another from all parts of the country is that we should enlarge our activities by adopting a new sort of educational work. The work suggested is that of encouraging the organization of local clubs for the study of forestry and the allied phases of the conservation move-



USE OF A NATIONAL FOREST

Homestead Located in the Black Hills N. F., South Dakota

ment. While at the present time it seems, for many reasons, impossible for the Association to take up, actively, the work suggested, it has seemed that there is more than a small measure of practical value in the idea.

It is suggested that the Association's field of usefulness can be vastly enlarged by the adoption of some plan of this kind. Ours is a nation of clubmen and clubwomen; not a village but has its Browning or Shakespeare club, and the interest in purely social organizations such as these would seem to indicate a fertile field of usefulness for

clubs having as their object the study of the vital economic problem of conservation of natural resources.

Several hundred such clubs, in different parts of the country, would, it is



Homestead Entry in the Black Hills National Forest

believed, inevitably result in the formation, or the crystallization, of a strong public sentiment in favor of the objects for which our Association stands. A healthy local sentiment for forest protection, soil conservation, waterways extension, water-power utilization, etc., would of necessity have an ever-widening influence, and a club organized for the study of problems such as these could not, it seems, fail to exercise a healthy, stimulating, and strongly educational influence upon the sentiment of any community. The helpfulness of a strong favorable sentiment created by an extensive organization of such clubs, welded together by their harmony of interests, could not fail to be a powerful factor in the success of the conservation movement.

An aroused and intense public interest in conservation as a national necessity, must infallibly prove strongly

beneficial in securing needed legislation; and it would appear as if there could be no more effective manner in which to create such a sentiment than through the organization of clubs along the lines here indicated. The pressure that could be brought to bear where most needed, by an effective and solidly welded club membership of several thousand active and interested men and women cannot well be estimated. In certain states, such as those that would be affected by the creation of the Southern Appalachian National Forest, local clubs bound together by a central, state organization, could absolutely control the situation.

We have had in mind for some time to begin the discussion of the club idea, but have heretofore forborne for various reasons. The discussion is now opened, however, and we should be glad indeed to receive any number of suggestions



Homestead in Black Hills National Forest

as to the best methods to pursue in regard to the organization of clubs; such clubs, perhaps, to be welded into state-wide organizations, for the study of the many-phased ques-

tions of conservation of natural resources. Practical suggestions, from practical organizers, will be more than welcome. It may be that by the adoption of some such plan as this, better and more effective work can be done than has ever yet been accomplished;

and we shall hope to see the movement for the organization of local "conservation study" clubs well under way before the time for holding the next annual meeting of the American Forestry Association, next January.



THE HEGIRA

By the "POET LARIAT"

(A large portion of the clerical force of the Forest Service is to be moved into the West this fall and winter, with headquarters in the cities of San Francisco, Denver, Portland, Albuquerque, Salt Lake, and Missoula.)

Oh, they're whis'pring in the corners
 And talking in the hall
 They are scheming and a-planning
 Where to migrate in the fall,
 They are telling one another
 Of the places they like best;
 Oh, the whole blamed outfit's "locoed"
 'Cause we're going out West.

"Have you ever lived in Portland?"
 "Is it wet or is it dry?"
 "Do you think you'd like Missoula?"
 "If you do, please tell me why?"
 "Is the living high in Denver?"
 "Are the ladies there well dressed?"
 Oh, these are burning questions,
 'Cause we're going out West.

"Now I want to go to Frisco,
 Even tho' the earth does quake."
 "Well, I'm wild to see a Mormon,
 So I'd much prefer Salt Lake."
 "Do you think that I'd get homesick?"
 "Are the Frisco fleas a pest?"
 What a turmoil has been started,
 'Cause we're going out West.

"Oh, they say that board's expensive
 In the town of Albuquerque."
 "But you needn't take a street car
 For to reach your daily work."
 "Well, I've heard the living's awful,
 (Now please don't think me silly)
 But really, do they live out there
 On only beans and chili?"
 Oh, such like doubts and troubles
 Daily agitate the breast,
 Of each one in the Service,
 'Cause we're going out West.

THE APPALACHIAN NATIONAL FOREST ASSOCIATION

HAVING just made arrangements with CONSERVATION whereby this magazine becomes the official organ of the association, giving us certain news space each month, it is with pleasure and gratification that the announcement is thus somewhat informally made, of the renewal of the Forest Fight by the Appalachian National Forest Association.

This will be of itself cheering news to our earnest and loyal membership throughout the South, but, coupled with the recent election of Hon. D. A. Tompkins, of Charlotte, N. C., as our new president; with the removal of our headquarters to Washington, the real seat of war; with the present ability of Mr. Finney to retain his connection as secretary and treasurer, it must bring to us some idea of the hard work that lies before us, but bring, at the same time, some vision of the success and the value of the work that must in time crown our patriotic and unselfish efforts.

Our association is a purely voluntary one, organized last December in Atlanta, for the purpose of awakening the South to the importance of forest perpetuation, and exerting southern influences toward the support of legislation for the Southern Appalachian-White Mountain bills, then pending in Congress. Its work of education and publicity in all the Southern States has been of large importance to the forest cause, and has called forth the approval of press and people in a remarkable way.

Our organization, hastily made as it was, capable of doing such work as was accomplished by it, cannot be allowed to lapse, so we have girded our loins for the new campaign that is nec-

essary, and with more time for planning, can, we believe, do better and more effective work for the forests—work that must be done in both the Nation's Congress and in the several states if forest perpetuation becomes a reality.

The selection of Mr. Tompkins means a great deal to us. No man is better or more favorably known in the whole South. He is not only prominently identified with vast and successful commercial enterprises, but he is a promoter of them and of the real interests of the South, in the truest and best sense of the term.

He is a close student of men and affairs, a man of earnest and deep thought on economic questions, a far-sighted patriot who does not know what failure means.

His letter accepting the presidency and outlining the future work of the association, is a clarion call to a duty, which, as he puts it, "cannot be evaded" by the patriotic men and women of the South.

The plan of campaign proposed by the association covers the strengthening of our state organization in each of the Southern States, and the extension of the same into all the Eastern States of the Union. Then we plan to get through a vigorous lecture campaign, a large and active membership of three classes:

First.—From the already organized public and semi-public organizations now in each city, such as chambers of commerce, civic leagues, women's clubs, mercantile associations, and clubs, etc., our hope being that these can be induced to become members of our association in a body, thus helping to support our public work; but more

important than that, giving us the moral support and vast influence that would immediately make themselves felt in needed national legislation. Incidentally, they would, as "city branches" of our association, keep up the local interest and publicity.

This kind of a membership in each important city in each state welded into a "State Forest League," directed, as it could well be by our association, could be made to wield a potent influence for the cause of the forests in the various states in calling for state legislation for the establishment of state forests; for the appointment of state foresters; for the revision of the tax laws on forest areas; for the enforcement of fire laws, and could vastly help in the education of the individual owner of forest lands to a sense of his duty to himself and posterity and to the state.

Then we want an individual membership made up of believers in our work and workers for the conservation idea, of interests identified with the forests or its related subjects, such as lumbermen, agriculturists, power companies, navigation companies, and the like.

And lastly, we want "Sustaining Members," to provide the sinews of war.

And we will get them all, too, and give them value received, for we are going to give them CONSERVATION each month, and all the forest facts in detail, and plenty of work to do besides.

Forestry mass meetings under the

auspices of the leading organizations, are already planned and well under way for Richmond, Lynchburg, and Roanoke, Va., Winston-Salem, and Greensboro, N. C., and other points, and by the 1st of October we shall have our hands full.

We are doing our work on faith—faith in the hearty support both moral and financial—of the people; there seems to be no doubt of the feasibility and practicability of our plans, as they have so far been developed, and no doubt either that our faith in the people is fully justified.

The volume of work, however, grows in the same proportion as the interest grows, and we have a large task before us, the successful accomplishment of which is only possible by and through united and earnest effort.

"Pledged to the Forest Cause," our new motto, means some individual sacrifice; some individual work; much individual earnestness, but it is work that will count largely for future America, and for future generations of Americans, and we believe we shall soon have behind us in our campaign the aggressive spirit of what is termed the "New South," which knows what it wants and will get it.

Very cordially yours,

THE APPALACHIAN NATIONAL
FOREST ASSOCIATION,

JOHN H. FINNEY,

Secretary and Treasurer.

National headquarters, 514 Metropolitan Bank Bldg., Washington, D. C.

DUCKTOWN, TENNESSEE

View Showing the Final Results of Deforestation



THE NATION'S HERCULEAN TASK

Synopsis of a Lecture on the Panama Canal Delivered by CLAUDE N. BENNETT, Manager of Congressional Information Bureau, Washington, D. C., before the Summer School of the South at the University of Tennessee, Knoxville

IN HIS lecture on the Panama Canal before the Summer School of the South, Mr. Claude N. Bennett more clearly fixed the attention of the country upon the assured success of this great waterway than has been done by any other recent deliverance upon this live subject. He showed intimate knowledge of the details, as well as the broad principles of the entire task. He demonstrated rare capacity to put his information into concrete form and to tell his audience just the things that they most wanted to know. His statements have been copied with favorable comment all over the country.

After a brief introduction, in which he said that even the whole month which he had spent in the Canal Zone was too short a period to satisfy the interest which the great work there had aroused in him. Mr. Bennett entered into the subject-matter of his lecture. The Canal Zone, he said, is to-day the busiest place on the map.

Think what the proposition is—cutting a canal through fifty miles of hills and rocks, actually levelling mountains, to unite two great oceans; think of the almost incalculable amount of excavation, the figures to express which well nigh stagger the arithmetician; think of the accessories to be taken into consideration in this tremendous undertaking of cutting a continent in two; think of the building of the Gatun Dam, the greatest dam the world will know; think of the immense locks, each 1,400 feet in length, and you may possibly form an approximate idea of an enterprise which has aroused the nations of the world to wonder.

All this was to be done 2,000 miles from the base of supplies, in a tropical country choked up with the densest vegetable growth, a veritable death-trap of fever, malaria, and all manner of tropical diseases. They had to transport across 2,000 miles of sea all the labor, all the lumber to build the houses, all the supplies to feed an army of 30,000 men, all the machinery to operate with, from a pick to a track-throwing machine.

The building of an Isthmian Canal, a waterway that would unite the waters of the Atlantic with the waters of the Pacific, had been the dream of nations for centuries. The French, under Ferdinand de Lesseps, were the first to make a definite attempt, but even that great engineer, the creator of the Suez Canal had underestimated the tremendous difficulties of the enterprise, and after years of labor, after the expenditure of many millions of money and the sacrifice of many thousands of lives, they had to write failure across their plans. It was reserved for the United States to take up the gigantic task, and the Government of the United States in the brief space of four years has wrought the miracle for which the world waited for centuries. Not that it is finished, for the real work has just reached its middle stage. The United States officials realized that the first thing to do was to make the Isthmus of Panama a place where white men, not natives of the tropical zone, and not inured to that climate, might live. Hence the first thing they undertook was the sanitation of that strip of country, and this in itself was a task so great

that its perfect accomplishment has called forth the grateful admiration of the nations of the earth.

Next in impressiveness to the greatness of the undertaking is the confidence, the colossal fashion in which it is being carried out. There are no doubting Thomases on the Isthmus of Panama. Every official there, from the highest to the lowest, talks and acts and works as if he had a proprietary interest in the canal.

It is pleasing to say to this Southern audience that this great canal which is expected to do so much for the development of the South is being built largely by Southerners. Colonel Goethals, the chief engineer, is from New York. Commissioner Rousseau, the navy man on the Commission, is from Pennsylvania. Former Senator Blackburn, governor of the Canal Zone, is from Kentucky. Colonel Gorgas, the great sanitary expert, is from Alabama. Major Seibert, who has charge of the building of the Gatun Dam, is from Alabama, though born in Georgia and appointed from Iowa. Major Gaillard, who has charge of the Culebra Cut excavation, is from South Carolina. Jackson Smith, who organized and developed the Department of Labor, Quarters, and Subsistence, is from South Carolina. Colonel Hodges, who succeeded Jackson Smith, is from Massachusetts.

The Secretary of War, General Luke E. Wright, who, under the President, has authority over the whole enterprise, is a Southerner, a Tennessean, an ex-Confederate soldier. The President himself is half Southerner—you know his mother is from my home State of Georgia.

Nearly 100 mammoth steam shovels are at work there; there are unloaders and spreaders and track-throwing machines; there are several hundred steam engines, and hundreds of trainloads of material are handled every day. That little fifty miles of track, known as the Panama Railroad, is about the busiest railroad on earth. Three thousand carpenters were at work for years building houses.

There are more than 2,200 buildings of every possible size and shape; twenty-four different types of dwellings alone; office buildings, storehouses, hotels, magazines, and what-not. There are four distinct water systems to supply not only the cities of Panama and Colon, but the entire working force along the line of the canal. There are electric-light plants, railroad shops, ice factories, great bakeries, and all the other utilities that are required to supply the necessities of an army of 44,000, including employees and their families. There is an average working force of about 33,000 men. Of these 7,000 are for the Panama Railroad Company; on the canal there are at work about 5,000 Americans, between 6,000 and 7,000 foreign laborers, and the balance negro laborers.

As to excavation, first, 1,000,000 cubic feet of earth and rock a month was thought to be great work; then excavating 2,000,000 was thought to be wonderful; next, 3,000,000 a month was reached, and now the slogan is that 4,000,000 a month must be reached. Has any one an idea what 3,000,000 cubic feet means? It is a larger bulk than the greatest of the Egyptian pyramids. Three million cubic feet of dirt, if hauled by two-horse wagon teams, would make a string of teams, with a foot of space between them, more than 8,000 miles long.

The Suez Canal was ten years building, between 1859 and 1869. It is about 100 miles long and cost nearly \$100,000,000. We are digging a Suez Canal every year, counting by excavation. The sanitary department cuts and burns or removes 15,000,000 square yards of brush a year, drains 1,000,000 square yards of swamp lands, keeps up 3,000,000 feet of ditches, and fumigates 12,000,000 square feet of living quarters.

As to the cost. The United States paid the French Panama Canal Company \$40,000,000 and the Panama government \$10,000,000. It authorized an expenditure of \$145,000,000 for the construction of the canal. The total amount

expended up to date, including the \$50,000,000, is \$145,000,000. The last appropriation act carried for next year's expenses, \$29,177,000. The total appropriations made to date are \$170,964,468.58. Therefore, within the original total of \$195,000,000 there are left not quite \$25,000,000. It is now supposed that the canal will cost altogether about \$300,000,000. No doubt there are men who will cry out that this is a sheer waste of money. The same kind of men ridiculed the Suez Canal in its beginning as a chimerical scheme, but it has paid from twelve to seventeen per cent. on the investment, and there need be no fear that in this respect history will not repeat itself in the case of the Panama Canal. A careful estimate, based on facts, shows an income of \$100,000,000, during the first ten-year period of the canal's operation.

What the Panama Canal will mean to the world in the way of shortening distances in the matter of transportation and the consequent saving of time and expense in the way of coal consumption and freight costs may be realized when it is stated that the whole distance from New York to San Francisco around Cape Horn, is 13,000 miles. Through the Panama Canal the distance will be only 5,000 miles, a saving of 8,000 miles, a distance equal to two and a half times across the United States. When the battle-ship Oregon made her famous trip from San Francisco to Santiago, it took her sixty-six days. If the canal had then been built she could have made the trip in fifteen days—less than one-fourth of the time. The canal will probably be opened by July 1, 1914.



NEWS AND NOTES

Arizona Benefits from National Forest Administration

A STRIKING illustration of the benefits of forest management by Uncle Sam has just been reported from southern Arizona. In this region fuel of any kind is exceedingly scarce and difficult to get. It is supplied chiefly by Mexicans, who go up into the mountains with burros, cut the fuel from juniper and oak trees, and then take it out in small loads on the burros.

In the past, the ranchers living at the mouths of the canyons in the Dragon Mountains have prevented the Mexicans from reaching the most accessible timber, and perhaps justly so, because promiscuous cutting would unquestionably have damaged the watershed and unsteadied the flow of water in these canyons, on which the ranchers were dependent for irrigation. Since the establishment of the National Forest, however, the cutting of wood has been carefully supervised, and only dead

and mature trees the removal of which would not injure the watershed, have been cut.

Careful cutting of this kind has been allowed in the areas which have heretofore been closed to use, and as a result, the price of wood has actually been reduced in the small towns around the National Forests. For instance, in Pearce, an important mining town nine miles from the Forest, the price of wood previous to the creation of the National Forest was \$8 per cord. It is now only \$6, and this decrease can be wholly attributed to the improved administration of the Forest.



Japan Makes Innovations in Forest Management

JAPAN is the only government in the world which takes upon itself the working of its lumber business, according to Consul-General Henry B. Miller, of Yokohama, in a report in which he

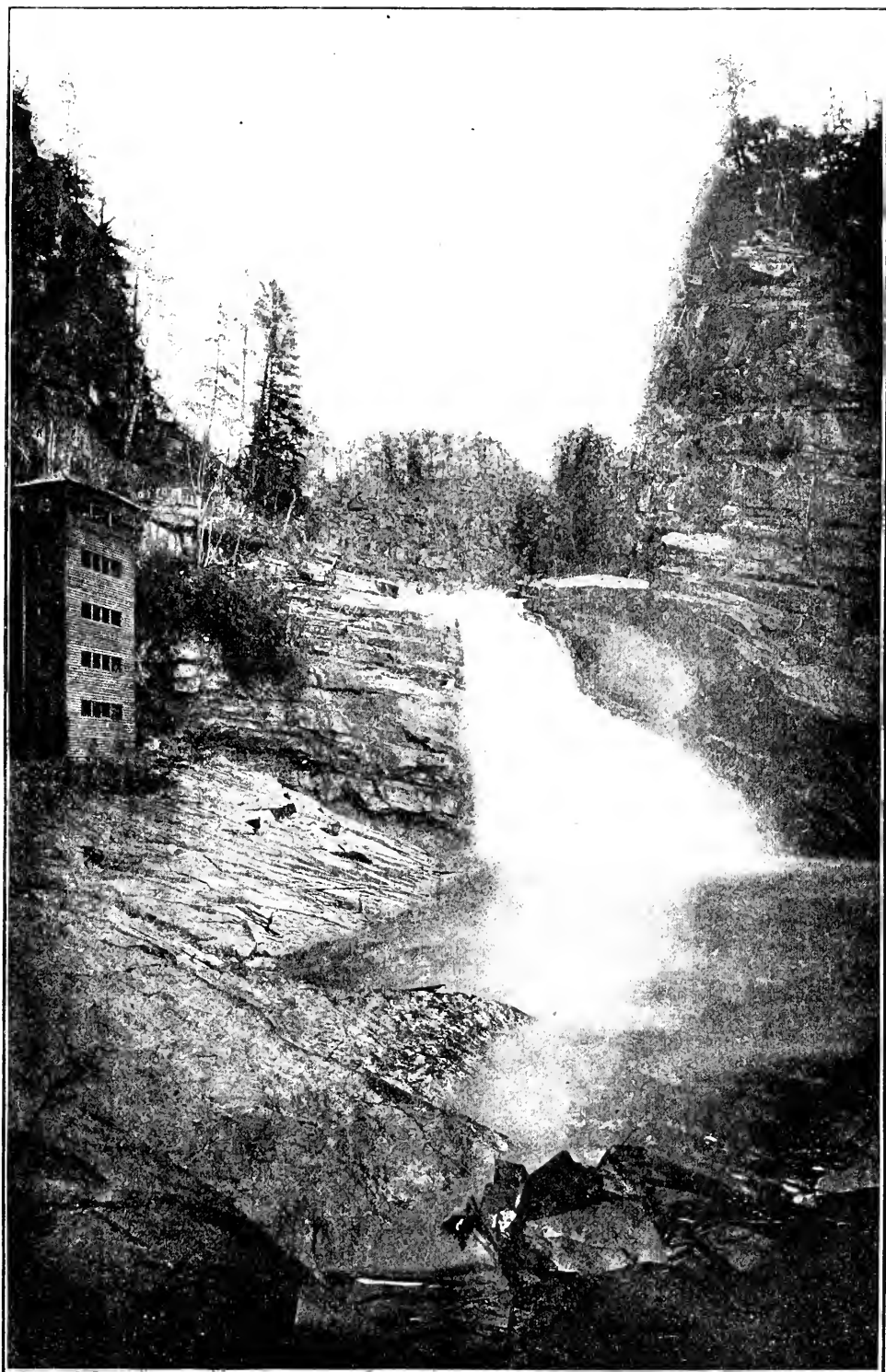

TALLULAH FALLS, GEORGIA
Scene in the Southern Appalachian Mountains

quotes the director of the Japanese Forest Bureau.

The Mikado's government has set apart a quarter of a million dollars to build sawmills and lumber roads, manufacture lumber in remote districts, and put it on the market. Except railroad ties for Manchurian roads the Japanese government exports no timber. It is all needed at home.

Many governments in different parts of the world own forests, but, as a rule, the timber is sold where it stands, and the buyer cuts and markets it. That is the way it is done in the National Forests of this country. The Japanese government, however, proposes to carry on all parts of the work, from planting the trees to selling the lumber after it has been manufactured. The report says:

"Recently an official in the department of agriculture and commerce was sent to the United States, and others to Europe for the inspection of the timber trade and forestry administration. A commission was also sent to India for the same purpose. A specialist on forestry in the same department is to be sent to South America shortly on a similar errand. The latter will thoroughly study the rubber plantations, and, if possible, bring back roots or seeds for planting on the Bonius and Luchu groups.

"The Japanese department of agriculture and commerce, which established a sawmill in Akita prefecture in 1906, making a grant of \$100,000 in that year and \$150,000 in 1907, to develop the business, has obtained a vote of \$150,000 toward the fund for the extension of the lumber business, and new government mills are to be established in Nagano and Aomori prefectures. Before the end of this year there will be nine timber mills in all in Akita, Aomori, Miyagi, and Kumamoto prefectures all worked by the government. In many forests reserved by the government there is a very heavy supply of timber, but these forests are remote from railways, rivers, or seaports, and much expenditure is necessary for opening roads or constructing other means

of transport in order to make such timber available.

District forestry offices will, however, not work mills regardless of profit, as strong competition is going on among them. It is stated that the government mills will only supply their products to merchants in Japan, and the works are not yet progressed to such a stage that the government can export direct. So far, the export of timber by the government mills has been confined to supplying sleepers to the South Manchurian Railway Company."



Government Maps for Automobile Tourists

AUTOMOBILE tourists are beginning to find the topographic maps of the Geological Survey invaluable in laying out routes of pleasure travel. All public roads, as well as all important private roads, are shown on these maps while the contour lines indicating the topography and showing the grades of the roads enable the automobilist to determine accurately the character of the country through which he intends to travel.

These maps are made primarily as bases for the geologic map of the United States which the Geological Survey is constructing, and the fact that they can be employed better than any other maps for non-scientific purposes, such as automobiling, attests their practical value, though this is only one of a very great number of uses to which they are put. No maps, in fact, are so generally used as the Survey's topographic maps. Commercial maps are based on them, and a score of bureaus and departments of the Government use them as bases for special maps or plottings, for determining routes of march or travel, for planning engineering works, and for many other like public purposes.

The topographic map or atlas which will be formed by the combined topographic sheets published by the Survey was referred to last winter by Secretary Garfield, in a report to Congress,

as the "mother map of the country," for it is now the principal source of all other maps. The sheets cover areas termed quadrangles, whose limits are defined by meridians and parallels, and nearly 1,800 of them have already been completed. Some of the states have valued these maps so highly that they have defrayed half the cost of the surveys. The expense of surveying a quadrangle and engraving a sheet ranges from \$3 500 to \$8,000, but after the map has served its scientific purpose to the Government extra copies can be purchased by any one for 5 cents each, or \$3 a hundred, which is simply the cost of paper and printing.

The maps are so detailed and accurate that clever clay modelers have used them as bases for relief or physical maps which were exact miniature reproductions of the regions comprised within the quadrangles, showing every hill and valley in relative steepness, and the lakes, swamps, falls of rivers, etc., as well as all the important works of man.



New Publications

THE United States Geological Survey announces new publications as follows:

Monograph.—XLIX. The Ceratopsia, by J. B. Hatcher, based on preliminary studies by O. C. Marsh, edited and completed by R. S. Lull. 1907. 300 pp., 51 pls. Price, \$1.50.

Bulletins.—324 (Reprint.) The San Francisco earthquake and fire of April 18, 1906, and their effects on structures and structural materials: Reports by G. K. Gilbert, R. L. Humphrey, J. S. Sewell, and Frank Soulé. 1907. 170 pp., 57 pls.

328. The gold placers of parts of Seward Peninsula, Alaska, including the Nome, Council, Kougarok, Port Clarence, and Goodhope precincts, by A. J. Collier, F. L. Hess, P. S. Smith, and A. H. Brooks. 1908. 336 pp., 11 pls.

335. Geology and mineral resources of the Controller Bay region, Alaska, by G. C. Martin. 1908. 141 pp., 10 pls.

337. The Fairbanks and Rampart quadrangles, Yukon-Tanana region, Alaska, by L. M. Prindle; with a section on the Rampart placers, by F. L. Hess, and a paper on the water supply of the Fairbanks region, by C. C. Covert. 1908. 102 pp., 5 pls.

342. Results of spirit leveling in California, 1896-1906. 1908. 172 pp.

343. Binders for coal briquets; investigations made at the fuel-testing plant, St. Louis, Mo., by James E. Mills. 1908. 56 pp.

344. Strength of concrete beams, by Richard L. Humphrey. 1908. 59 pp., 1 pl.

Geologic Folios.—157. Passaic (New Jersey-New York) folio, by N. H. Darton, W. S. Bayley, R. D. Salisbury, and H. B. Kümmel. 27 folio pp. of text, 3 maps, and 1 sheet of illustrations. Price, 25 cents.

158. Rockland (Maine) folio, by E. S. Bastin. 15 folio pp. of text and 5 maps. Price, 25 cents.

Mineral Resources of the United States, 1907.—Advance chapters on cement, bauxite, phosphate rock, and monazite and zircon.

The Geological Survey has a limited number of copies of these publications for free distribution (*except those whose price is stated*), and some have been delivered to Members of Congress for distribution. The Survey cannot give more than one copy to any person and general requests for all the papers cannot be complied with unless a satisfactory reason why every one is desired is given. Payment for sale publications should be made by postal or express money order, payable to the Director, U. S. Geological Survey, or in cash—the exact amount. Checks, drafts, and postage stamps cannot be accepted. Applications sent to the Geological Survey should be addressed to The Director.



AS ONE FOREST RANGER VIEWS IT

From a Personal Letter from Fred. Hanson, Forest Guard, Fifth District
Klamath National Forest, Orleans, Humbolt Co., Cal.

I REACHED this "Ranger Headquarters" March 13; it is 260 miles from Yreka, via Somers Bar and Etna. I made the entire journey with pack-horses. I purchased two good horses and the necessary equipment, costing in all about \$350, and am well prepared for services at my camp and district.

Well, maybe you think I wasn't lonesome for a fortnight, after coming into these mountains and forest from the metropolis! Why, it's sixty-five miles to the nearest railroad, telegraph, and express office, and wagon road. That's not bad, is it? Everything from a needle to a threshing machine is packed in by trail, on muleback and the charge per pound for necessaries is from 4 to 6 cents over and above San Francisco prices.

Our headquarters is built of logs, situated on the trail, four and a half miles from Orleans, the nearest post-office. I have been very busy clearing, building fences, chopping wood, surveying, etc.

To-day, Sunday, I attended an Indian burial. The deceased was quite wealthy in Indian relics and money, considerable of which was buried with her. Her husband perforated her nose and ears and attached pieces of the Indian coins or wampum.

There are but two white women here, Misses Arnold and Reed, who are doing educational and missionary work among the Klamath Indians, and who have been sent out from New Jersey by the Indian Department. They have promised to prepare an article about their experiences with the Indians upon the Klamath and Salmon Rivers.

I am interested in FORESTRY AND IRRIGATION. My associate, Deputy Ranger W. H. Hotellings, has some back numbers of the magazine at his home, across the Klamath, and when I am over there again, I'll look through them.

I feel a great interest in the Forest Service and will do all within my power to promote the work for the good of the administration. I fully realize the great importance of preserving the valuable forests and watersheds in our state, not only, and selfishly, for the present generation, but for the generations that follow us.

And what helps most of all is the enthusiasm and inspiration one receives from the forceful leadership of Supervisor Richard L. P. Bigelow, who takes a personal interest in his men. * * *

Since writing you last I have come to Weitchpec to survey out twelve miles of the western boundary of the Klamath reserve. The Fifth District of the Klamath National Forest comprises twenty townships, or about 460,000 acres of land. There is plenty of salmon and game during the game season. Roughing it, in a country where there is lots of game, pure air, and water, isn't such a bad thing, is it?

On our last survey I captured a pretty little fawn. After fondling it for a while, I laid it under some bushes and watched for the mother. Presently she came trotting along, and, finding her young one safe immediately disappeared again in the thicket.

An Indian near us recently captured two cub bears, about three months old, male and female, brown and black, respectively. They are such cute little pets; I call them the Teddy bears.

For some time past a panther has been prowling around our headquarters, and killing pigs. Last week the dog treed it and our neighbor boy shot it. I found it to weigh 135 pounds, just about the weight of an average man.

This is Sunday. I am writing this letter stretched out on a few quilts in our tent. Well, it's nearly noon, the beans are about cooked, so I'll close.



IN THE SOUTHERN APPALACHIANS

Scene in the Region Whose Remaining Timbered Slopes and Watersheds Thousands Are Working to Save

A GREAT FOREST

By JOHN COLLINS, M.D., Colson, Ky.

THE Ozark National Forest, recently established, is doubtless one of the greatest bodies of hardwood timber on this continent.

Most of the entire Ozark region is or has been one vast forest, while much of it, including Boston Mountain, a large area of hills and mountain is still clothed in its virgin growths. The oaks predominate, but we have almost every kind of wood growth found in this latitude. White oak is by far the most abundant.

The writer located on a 160-acre homestead on Boston Mountain, in 1906, having immigrated from the mountain of eastern Kentucky, a great timber country. A large scope of country near this homestead, in north Pope and south Newton counties, contains much more unappropriated lands than has been entered. This is true of a great part entered. This is true of a great part of the whole forest, so that capital is now invited for investment and development of this great timber wealth, there having been before this too little of deeded lands, the timber on which could be bought to justify the building of railroads to move it. It is the policy of the Government to put the merchantable timber on the market, then to care for the younger growths, and to produce succeeding crops, in anticipation of a wood famine that is inevitable in the near future if not forestalled.

The President's Proclamation, setting forth this Forest, is dated March 6, 1908, previous to which these lands were subject to homestead entry. The absence of railroads, together with the fact that the latent possibilities of the country as an agricultural, and especially as a fruit country, were unknown, have prevented settlement. The peach and the apple—in fact all fruits indigenous here—do remarkably fine. In size, beauty, flavor, and certainty of yield, it is doubtful if any section in the United States could rival this.

The wealth in white oak alone, which abounds in excess of all other kinds in most parts, is remarkable—seemingly almost inexhaustible—millions of fine trees now awaiting the ax and saw, apparently unknown and ignored by the lumbermen of the country.

We want capital to come to us; lumbermen to investigate this rich field; railroads not only to carry away this wealth of timber, but also the magnificent crops of fruits and vegetables so easily produced here—for while fruits excel, still vegetables, including all the common garden truck, potatoes, beans, melons, etc., do remarkably well. The writer has nothing to sell, but has a desire, common to all settlers, for this needed development. Range for cattle and sheep, and most for hogs are abundant.



"PAYMENT CONDITIONAL UPON SUCCESS"
SMOKY FIREPLACES REMEDIED

Twenty years' experience in dealing with the above trouble. Thoroughly trained workmen employed. In most cases work can be done without defacing decorated walls and with little inconvenience to the household

Examinations and estimates without charge within 500 miles of New York
Contracts entered into with the understanding that charges are for results

The following are a few of the many thousands who have availed themselves of my services:

Grover Cleveland, Princeton, N. J.
 W. A. Slater, Washington, D. C.
 Mrs. John Hay, Washington, D. C.
 Princeton University, Princeton, N. J.
 Senator Aldrich, Providence, R. I.
 Clement B. Newbold, Jenkintown, Pa.
 University Club, New York
 Union League Club, New York

Hon. Whitelaw Reid
 Hon. Joseph H. Choate
 J. Pierpont Morgan
 John D. Rockefeller, Jr.
 Col. John J. Astor
 George J. Gould
 Henry Clews
 Joseph Pulitzer

Architects

U. S. Government for:—
 White House, Washington, D. C.
 U. S. Naval Academy, Annapolis, Md.
 McKim, Mead & White
 Carrere & Hastings
 Hunt & Hunt
 Ernest Flagg
 Howell & Stokes

JOHN WHITLEY

Engineer and Contractor

215 Fulton Street, Brooklyn, New York



Before Treatment of Cavities

Don't Let the Old Trees Die

Young trees may not equal the old ones in size and beauty during your life. Insecticides, fertilizers, bolting, pruning, tree surgery, and cavity-filling are only part of the practical means of restoring sick and dying trees to health and beauty. We examine estates, suggest improvements in planting new stock, and direct the work of saving diseased trees and shrubs. Trained assistants equipped with proper tools are furnished when desired. A booklet entitled "The Care of Trees" is sent on request.



After Treatment of Cavities

H. L. FROST & CO., The Pioneer Tree Specialists
 Landscape Foresters and Entomologists
 Arlington, Mass. White Plains, N. Y.

Congressional Information Bureau

CLAUDE N. BENNETT, Manager

Attends to business before Congress, the Courts, Patent Office, Interstate Commerce Commission, and all other Departments of the Government at Washington.

Supplies any desired information from the Capital, furnishes advices concerning matters pending in Congress, the Courts or the Departments, and transacts business at Washington for clients anywhere in the world.

Conducts library research along any designated lines.

Has a Legal Department that prepares briefs for lawyers or other clients.

Usefulness demonstrated by ten years' successful experience.

Congressional Information Bureau

BOND BUILDING

WASHINGTON, D. C.

HOW TO RUN AN AUTO

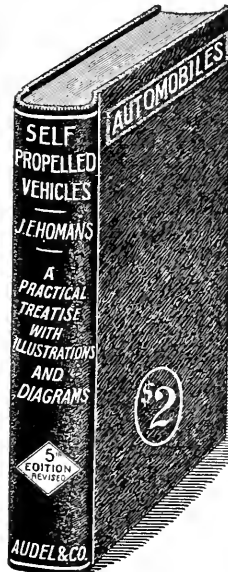

Are You Interested in Automobiles?

If you are, an early purchase of "HOMANS' SELF PROPELLED VEHICLES" will prove a good investment.

This work is now the accepted standard on the practical care and management of motor cars—explaining the principles of construction and operation in a clear and helpful way, and fully illustrated with many diagrams and drawings.

The presentation of subjects has been determined by consideration of the needs of the man behind the wheel. It is clear and concise in its treatment, and comprehensible to the most inexperienced automobilist, at the same time it is so thorough that the expert will learn much from its pages.

Contains 608 pages, over 400 diagrams and illustrations, printed on fine paper, size 5 3/4 x 8 1/2 inches, with generously good binding. Highly endorsed.

This good book will be sent to any address in the world, postpaid, upon receipt of two dollars, or if desired, will be sent on approval to be paid for after examination.

No money in advance required, sign and return
 Theo. Audel & Co., 63 Fifth Avenue, New York
 Kindly mail the copy "HOMANS' Auto" and if
 found satisfactory I will immediately remit
 \$2 or return book to you.
 Name
 Address
 Date
 For

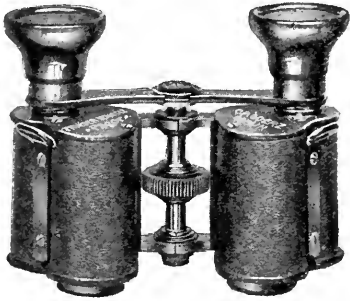

The glass most suitable for the sportsman or the traveler is the

GOERZ "PAGOR" BINOCULAR

It is the smallest and most compact prism glass on the market. It yields clear, sharply defined, beautifully lighted images. It measures up fully to the well-known "Goerz" standard of excellence in every detail of construction.

Made in three magnifications

6x 8x 10x

Get our catalogue at the dealers or direct

C. H. Goerz American Optical Company

New York: 52 Union Square, E.

Chicago, Ill.
1514 Heyworth Bldg.

San Francisco, Cal.
703 Claus Spreckels Bldg.

The Pompeian Co.



Importers of highest class Refined Pompeian Olive Oil, and manufacturers of Olive Oil Products. Proprietors of

OLIVKRIM

A pure Olive Oil hair invigorator. Not to be confused with tonics, quinine or other "cures." It contains all the health-giving, nourishing properties of pure Olive Oil—a hair food, not a combination of alcohol and drugs.

OLIVE OILS

Our Pompeian Extra No. 1 Lucca Oil is the finest product of Italian Olive Orchards. Analyzed and endorsed by Prof. H. E. Kalusowski, Dean of the George Washington College of Pharmacy, Washington, D. C.

THE POMPEIAN CO.

702 Fifth Street

Washington, D. C.

PLANE SURVEYING

A Text-book and Pocket Manual

By JOHN CLAYTON TRACY, C. E.

Ass't Professor of Structural Engineering
Sheffield Scientific School of Yale University

16 mo, xxvii + 792 pages, illustrated with line cuts. Morocco, \$3.00

Used in the Yale Forestry School and just adopted in Pennsylvania Department of Forestry

Descriptive Circular on Application

JOHN WILEY & SONS

43 and 45 E. 19th Street
New York City

The
**PENNSYLVANIA
 STATE COLLEGE**

A thorough and practical undergraduate course in technical forestry, preparing men for all lines of professional and applied forestry.

Special attention is paid to practical field work in surveying, mapping, and forest measurements. One of the largest of the State Forest Reserves is within a short walk of the college.

For information regarding entrance requirements, expenses, etc., address

Department of Forestry
State College, Penna.

FORESTRY SCHOOLS

can find no better medium through which to make their announcements than

Conservation

It reaches a class of Readers that is reached by no other Publication.

It is *the* Magazine of authority in its special field.

For Advertising Rates, etc., address

Advertising Manager

CONSERVATION

1417 G St. N. W.

Room C

Washington, D. C.

POWDER POINT SCHOOL, Duxbury, Mass.

Preparatory Course in

FORESTRY

Leading to Biltmore and College Course in the subject. It requires hard, earnest application, and develops appreciation of nature and powers of leadership.

(M. I. T.) F. B. KNAPP, S. B.

ORCHIDS

ORCHIDS

We are the largest Orchid Growers in the United States.

Our Illustrated and Descriptive Catalogue of Orchids is now ready and may be had on application.

Orchid Growers and Importers

LAGER @ HURRELL
 SUMMIT, N. J.

Text Books on Conservation

If you are interested in any of the phases of conservation, read the list of publications carried in stock by CONSERVATION

STUDENTS

will find this list invaluable. Let us know what you want. We can fill your order. Address

CONSERVATION

1417 G St., Washington, D. C.

Make Your Unproductive Land Profitable

Hundreds of acres too far away from the great irrigation canals can be made profitable at small expense. You can have running water in your house and at your barn. The only things necessary are a running stream or spring on any part of your ground and the installation of a

NIAGARA HYDRAULIC RAM

The U. S. Government is using this pump for irrigation purposes, because it does such good work. It's cheaper than a windmill or gasoline engine. Works continuously without cost. Send for booklet B, and guaranteed estimate. We furnish towers and tanks.

NIAGARA HYDRAULIC ENGINE CO., 140 Nassau St., New York. Factory, Chester, Pa.

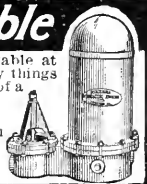

Hardy Shrubbery, Trees, and Specimen Evergreens

In Small and Large Sizes. Our Prices Are the Lowest for Quality Offered. Estimates Given on All Landscape Work. Write for Prices.

W. F. McCORD CO., Nurserymen

Tarrytown, N. Y.

F. R. MEIER CONSULTING FORESTER

1 Broadway, New York

TIMBER ESTIMATES, WORKING PLANS, FOREST APPRAISEMENT, TREE PLANTING, TREE SURGERY

Advice on profitable handling of woodlots, forest tracts, beautifying country estates. Work supervised. Seventeen years experience in the United States.

Read "Irrigation in the United States," by Frederick Haynes Newell, Director of the Reclamation Service. Price, \$2, postpaid to any address. Address "Conservation," Washington, D. C.

This Solar can be used in hazy weather, when other Solars are useless. Used by the U. S. General Land Office.

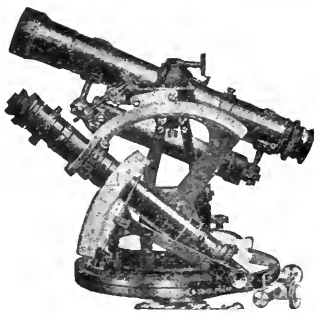

Specifications

Needle 3 1/2 inches long. Graduations 4/4 inches long. reading minutes. Power of telescope 20 (with splendid definition, good light, and large field). Variation plate. Level to telescope. clamp and opposing screws. Vertical arc. Fixed Stadia hairs. Extension Tripod. Solar Attachment on side of standards.

Price Complete, \$300

Telegraph and Code Word, Mountsolar

Illustrated Catalogue Upon Application

YOUNG & SONS Philadelphia



Rife Automatic Hydraulic Ram

(Water Pumped by Water Power)

No Attention — No Expense—Runs Continuously.

**Country Homes—Formal Gardens—
Farms—Town Plants—Irrigation—
Railroad Tanks—Dairies—Etc.**

7,000 in operation. 80% efficiency developed. Catalogue and estimate Free.

RIFE ENGINE CO., 2172 Trinity Bldg., New York

Conservation's Readers

Will confer a favor by mentioning this magazine when writing to advertisers.

Care is always taken to investigate all advertising admitted to these pages. Readers will greatly oblige us by promptly calling our attention to any unfair dealings, and advertisers are also asked to give us the details of any such dealings on the part of those who respond to advertisements.

Our Inquiry Department

Promptly answers any questions in regard to advertisements in these pages.

Write

CONSERVATION

1417 G Street N. W

Washington, D. C.

IMPORTANT BOOKS ON FORESTRY

PRINCIPLES AND PRACTICE OF FORESTRY

FOREST MENSURATION. By HENRY SOLON GRAVES, M.A. A complete text book of this important subject and the first written for American Foresters. It deals with the determination of the volume of log, tree, or stand, and with the study of increments and yields. *Price, \$4.00*

ECONOMICS OF FORESTRY, THE. By B. E. FERNOW. This volume treats of forests and forestry from the standpoint of political economy, and is designed to furnish a trustworthy basis for formulating public policy. *Price, \$1.50*

FIRST BOOK OF FORESTRY, A. By FILIBERT ROTH. An outline of the general principles of forestry, written in simple, non-technical language, designed particularly for the beginner. *Price, \$1.10*

PRACTICAL FORESTRY, FOR BEGINNERS IN FORESTRY, AGRICULTURAL STUDENTS, AND WOODLAND OWNERS. By JOHN GIFFORD. A good general description of the principles of forestry with enough technical information to prepare the beginner. *Price, \$1.40*

HISTORY OF THE LUMBER INDUSTRY OF AMERICA. By J. E. DEFEBAUGH. The first authoritative work of its kind yet issued, and one which will commend itself alike to the timber owner, lumberman, lumber manufacturer, or merchant, or student of economies. In four volumes bound in half leather. *\$5.00 per volume*

FOREST PLANTING. By H. NICHOLAS JARCHOW. An illustrated treatise on methods and means of restoring denuded woodland. *Price, \$1.50*

FORESTRY. (Schwappach.) An English translation of "Forstwissenschaft." *Price, 70c*

HEDGES, WINDBREAKS, SHELTERS, AND LIVE FENCES. By E. P. POWELL. A treatise on the planting, growth and management of hedges with information concerning windbreaks and shelters. *Price, 70c*

NORTH AMERICAN FORESTS AND FORESTRY. By ERNEST BRUNCKEN. This volume, expository in its character, is written in a style intended for the general reader, to whom it should convey a good idea of our forests forestry. *Price, \$2.00*

PRACTICAL FORESTRY. By ANDREW S. FULLER. A treatise on the propagation, planting and cultivation, with descriptions and the botanical and popular names of all the indigenous trees of the United States, and notes on a large number of the most valuable exotic species. *Price, \$1.50*

PRINCIPLES OF AMERICAN FORESTRY. By SAMUEL B. GREEN. Prepared especially for students in elementary forestry and for the general reader who wishes to secure a general idea of forestry in North America. *Price, \$1.50*

SEASIDE PLANTING OF TREES AND SHRUBS. By ALFRED GAUT. Illustrated from photographs by FRANK SUTCLIFFE. This is a new volume in the English Country Life Library. Advice regarding selection and management to get satisfactory effects under adverse influence of closeness to seashore. *Price, \$1.75*

FOREST MANAGEMENT. By C. A. SCHENCK. Describes methods here and abroad to bring the most profit from all investments made in woodlands. *Price, \$1.25*

FOREST MENSURATION. By C. A. SCHENCK. Treats conditions in U. S. from mathematical and practical standpoint. *Price, \$1.25*

FOREST UTILIZATION. By C. A. SCHENCK. First treatise on this in U. S. Covers logging, lumbering, sawmilling, coopersage, paper-making, and description of all industries obtaining raw material from American forests. *Price, \$1.25*

BILTMORE LECTURES ON SYLVICULTURE. By C. A. SCHENCK. Written from author's long experience as forester of the Biltmore estate, where sylviculture has been practiced on a larger scale for a longer time than anywhere else in U. S., and where results become more apparent from year to year. *Price, \$2.50*

FOREST POLICY. By C. A. SCHENCK. (Second part.) Describes the various States of the Union under following heads: Area; physiography; distribution of forests; forest ownership; use of the forest; forestry movement; forest laws; forest reservation; irrigation. *Price, \$1.25*

PROFESSION OF FORESTRY, THE. By GIFFORD PINCHOT. A pamphlet containing an address on that subject by Mr. Gifford Pinchot; also an address by Mr. Overton W. Price, on "Study in Europe for American Forestry Students," and a list of reference publications for students. *Price, 25c*

FOREIGN IMPORTATIONS

ENGLISH ESTATE FORESTRY. By A. C. FORBES. An authoritative volume on English forest methods from the pen of a well known forester, that should prove of interest to Americans. *Price, \$3.50*

FORSTWISSENSCHAFT. (Schwappach.) *Price, 60c*

MANUAL OF FORESTRY. (Schlich.) Five volumes, complete, or separately, as follows (*price, complete, \$18.80*):

- Vol. I. "FORESTRY POLICY IN THE BRITISH EMPIRE." *Price, \$2.40*
- Vol. II. "SYLVICULTURE." *Price, \$3.20*
- Vol. III. "FOREST MANAGEMENT." *Price, \$3.60*
- Vol. IV. "FOREST PROTECTION." *Price, \$4.80*
- Vol. V. "FOREST UTILIZATION." *Price, \$4.80*

This is perhaps the most authoritative work that has been issued on the technical side of forestry, translated from the German.

WOOD. By G. S. BOULGER. An important new book for arboriculturists and forestry students. A manual of the natural history and industrial applications of the timbers of commerce. Cloth. 82 Illustrations. *Price, \$2.60*

FAMILIAR TREES. By Prof. G. S. BOULGER. Written by an eminent botanical authority, yet couched in language easily understood. The coloured plates are the work of celebrated artists, and are truthful and trust worthy in every respect. A special feature is the series of photo-micrographic illustrations of sections of woods. Three volumes. *Price, per volume, \$1.50*

DENDROLOGY, BOTANY, AND IDENTIFICATION OF SPECIES

MANUAL OF THE TREES OF NORTH AMERICA (exclusive of Mexico). By CHARLES SPRAGUE SARGENT. A volume that presents in convenient form and with excellent illustrations, authoritative information concerning the trees of North America. It is written in a manner that enables the reader to readily find to what family or species any particular tree belongs. *Price, \$6.00*

AMERICAN WOODS. By ROMEYN B. HOUGH. A new departure in the publication of an authoritative work illustrated with actual wood sections of the various species described. Three are given of each, viz.: radial, transverse, and tangential. Issued in ten parts, per part *Price, \$5.00*

HANDBOOK OF THE TREES OF THE NORTHERN U. S. AND CANADA, EAST OF THE ROCKY MOUNTAINS. By ROMEYN B. HOUGH. Pictorial description of two pages to each species; photo-engravings of trunk, leaves, flowers or fruit, section of wood, and map of distribution, with botanical description, and brief other information. *Price, in buckram, \$8.00; in half morocco, \$10.00*

FLORA OF THE SOUTHERN STATES. CHAPMAN. This is an excellent key to the flora of the South, complete and accurate in its scope. *Price, \$4.00*

GETTING ACQUAINTED WITH THE TREES. By J. HORACE MCFARLAND. A handsome volume, copiously illustrated, and with facts accurately presented in an entertaining way. *Price, \$1.75*

HOW PLANTS GROW. By ASA GRAY. An understanding of the way in which a tree grows is of prime importance to the forester, and the matter here presented is accurate and authoritative. *Price, \$1.00*

PRINCIPAL SPECIES OF WOOD; THEIR CHARACTERISTIC PROPERTIES. By CHARLES HENRY SNOW. No attempt is made to give exhaustive descriptions of species, but the author presents a mass of information designed for the use and instruction of woodworkers, etc., in a popular style. A host of concise information is brought under each head, and the work is a valuable one. *Price, \$3.50*

*Important Books on Forestry and Irrigation for sale by CONSERVATION
1417 G Street N. W., Washington, D. C.*

MANUAL OF BOTANY. By ASA GRAY. A key to the flora of the northeastern states, and the most authoritative publication of its nature.
Price, \$1.62; field edition, \$2.00

TREES OF NEW ENGLAND. By L. L. DAME and HENRY BROOKS. This book is a small volume which can be easily put in the pocket and carried in the woods, and at the same time is the best guide to the identification of our New England trees of any of the smaller books yet published.
Price, \$1.50

TREES OF NORTHEASTERN AMERICA. NEWHALL. A good general check list of the more important trees of the northeastern United States.
Price, \$1.75

TREES AND SHRUBS. By C. S. SARGENT. The most thorough and authoritative publication yet issued, and a standard work. The matter is issued in parts, of which there are three already published.
Price, per part, \$5.00

TREES, SHRUBS, AND VINES OF THE NORTHEASTERN UNITED STATES. By H. E. PARKHURST. In this book the author describes the trees, shrubs, and vines of the northeastern United States in a popular way, the book being designed especially for persons who have never studied botany. To these it will appeal as a valuable guide to a familiarity with the salient characteristics of trees, shrubs, and vines.
Price, \$1.50

TREES. A handbook of forest botany for the woodlands and the laboratory. By H. MARSHALL WARD. Vol. I, Buds and twigs. Vol. II, Leaves. Vol. III, Flowers and inflorescences. Three volumes to be added, on Fruits and seeds, Seedlings, Habit and conformation of the tree as a whole.
Price, per volume, \$1.50

PARTICULAR SPECIES AND LOCALITIES

MOUNTAINS OF CALIFORNIA, THE. By JOHN MUIR. No other person is so well fitted to write of the mountains of California as John Muir, and the volume presented here describes not only the mountains themselves, but the trees that clothe them and the wild life which they harbor.
Price, \$1.85

OUR NATIONAL PARKS. By JOHN MUIR. If you want to learn about the glaciers, mountain peaks, canyons, and great waterfalls of the West; of the habits of animals from the squirrel to the moose; plant life from the big trees to the wild flowers—in fact be brought face to face with nature's works, this is the book.
Price, \$1.85

TREES AND SHRUBS OF MASSACHUSETTS. EMERSON. Two volumes. Plain cloth edition has 148 plates. The colored edition has 36 of these in colors.
Price, plain, \$12.00 Price, colored, \$18.00

THE EARTH AS MODIFIED BY HUMAN ACTION. By G. P. MARSH. A Revision of Man and Nature. Describes changes in the face of the earth caused by man, including desolation of various countries, once thickly inhabited, by removal of forests. Shows importance of maintaining natural balance of forces.
Price, \$3.50

THE LONGLEAF PINE IN VIRGIN FOREST. A Silvical Study. By G. FREDERICK SCHWARZ. This is a study of the life history of this important forest tree. Intended primarily for foresters and forest students; also for owners and managers of pine timber lands. Deals with the preference or dislike of the species for particular conditions of soil, climate, and environment. Illustrations and six tables.
Price, \$1.25

THE SPROUT FORESTS OF THE HOUSATONIC VALLEY TO CONNECTICUT. By G. F. SCHWARZ. Illustrated study of forests repeatedly cut over.
Price, 35c

IMPORTATIONS

BEAUTIFUL RARE TREES AND PLANTS. By the EARL OF ANNESLEY. A description of some of the rarer English trees, shrubs, and vines, illustrated copiously.
Price, \$12.00

FORESTS OF UPPER INDIA AND THEIR INHABITANTS. By THOMAS W. WEBBER. This volume is an account of the author's life in India during the period shortly after 1857. It contains a vivid description of the country, its people, customs, etc., with some description of its forests and timber wealth.
Price, \$5.00

BOOKS ON IRRIGATION AND DRAINAGE

IRRIGATION IN THE UNITED STATES. By F. H. NEWELL. The most authoritative and complete work on the subject which has yet been published, by the head of the Government's irrigation work.
Price, \$2.00

IRRIGATION FARMING. By L. M. WILCOX. A newly revised edition of one of the standard works on irrigation. The principal chapters treat very fully of irrigation, its application, etc., and the volume is profusely illustrated.
Cloth, \$2.00

IRRIGATION FOR FARM, GARDEN AND ORCHARD. By HENRY STEWART. This work is offered to those American farmers and other cultivators of the soil who, from painful experience, can readily appreciate the losses which result from the scarcity of water at critical periods.
Price, \$1.00

IRRIGATION AND DRAINAGE. By F. H. KING. While most of the existing books on these subjects have been written from engineering or legal standpoints, this one presents in a broad, yet specific way the fundamental principles which underlie the methods of culture by irrigation and drainage.
Price, \$1.50

IRRIGATION INSTITUTIONS. By ELWOOD MEAD. A discussion of the economic and legal questions created by the growth of irrigated agriculture in the West, by the Chief of Irrigation and Drainage Investigations of the Department of Agriculture.
Price, \$1.25

LAND DRAINAGE. By MANLY MILES. A handbook for farmers on the principles and practise of draining, giving the results of his extended experience in laying tile drains.
Price, \$1.00

LAND OF LITTLE RAIN, THE. By MRS. MARY AUSTIN. A nature book of the highest type. The volume is made up of a series of sketches of the human, animal, and plant life found in the region of the Mohave desert, Death Valley, and the Sierras, much of which the average person is likely to consider almost devoid of living things.
Price, \$2.00

IRRIGATION ENGINEERING AND CONSTRUCTIVE WORK

DESIGN AND CONSTRUCTION OF DAMS. By EDWARD WEGMANN. This volume includes an authoritative discussion of the constructive work involved and the principal forms of construction. Masonry, rock-fill, and timber dams are discussed extensively.
Price, \$6.00

IMPROVEMENT OF RIVERS. By B. F. THOMAS and D. A. WATT. This volume is a treatise on the methods employed for improving streams for open navigation and for navigation by means of locks and dams.
Price, \$6.50

IRRIGATION ENGINEERING. By HERBERT M. WILSON. This is the fourth edition of Mr. Wilson's popular work, and the revision and enlargement which it has undergone, places it at the forefront of text books on the subject for American students.
Price, \$4.00

ENGINEERING FOR LAND DRAINAGE. By C. G. ELIOTT. A manual for laying out and constructing drains for the improvement of agricultural lands.
Price, \$1.50

RESERVOIRS FOR IRRIGATION, WATERPOWER, AND DOMESTIC WATER-SUPPLY. By JAMES DIX SCHUYLER. An account of various types of dams and the methods and plans of their construction, together with a discussion of the available water-supply for irrigation in various sections of arid America, distribution, application, and use of water; the rainfall, runoff, and evaporation from reservoirs, and effect of silt, etc.
Price, \$5.00

WATER SUPPLY ENGINEERING. By A. PRESCOTT FOLWELL. A treatise on the designing, construction and maintenance of water-supply systems, both city and irrigation.
Price, \$4.00

*These books sent prepaid upon receipt of price indicated, by CONSERVATION
1417 G Street N. W., Washington, D. C.*

WATER POWER. By JOSEPH P. FRIZELL. An outline of the development and application of the energy of flowing water. *Price, \$5.00*

CONCRETE, PLAIN AND REINFORCED. By FREDERICK W. TAYLOR and SANFORD E. THOMPSON. Designed for practicing engineers and contractors; text and reference book for students. Discusses materials, processes, and applications of concrete in construction and specifications. *Price, \$5.00*

HYDRAULICS. By MANSFIELD MERRIMAN. Purpose of book is to keep abreast of modern progress, and present subject with conciseness and clearness. Gives general principles and discusses flow of water through various kinds of openings and channels. Historical notes and references. *Price, \$5.00*

FOUNDATIONS. By W. M. PATTON. A practical treatise explaining fully the principles involved. Numerous descriptions of important modern structures are given in sufficient detail. Includes articles on use of concrete in foundations. *Price, \$5.00*

MASONRY CONSTRUCTION. By IRA O. BAKER. Contains results of a great number of experiments, and a large amount of practical data on cost of masonry, pile driving, foundations, culverts, etc., and 97 tables to facilitate estimating. *Price, \$5.00*

REINFORCED CONCRETE. By ALBERT W. BUEL and CHARLES S. HILL. A treatise for designing and constructing engineers, governed by American practice and conditions. Theoretical discussions omitted, and replaced by practical working formulas, examples of representative structures, and records of practice. *Price, \$5.00*

BOOKS ON RELATED SUBJECTS

UTILIZATION OF WOOD WASTE BY DISTILLATION. By WALTER B. HARPER. An important treatise on a subject regarding which the interest is great and the information scarce. Is intended to aid in the establishment and conduct of wood distilling enterprises on a business basis. *Price, \$3.00*

HANDBOOK OF TIMBER PRESERVATION. By SAMUEL M. ROWE. Intended as a complete practical guide for the operator of a preservation plant, with hints on construction thereof. *Price, \$4.00*

IN FOREST LAND. By DOUGLAS MALLOCH. The humor, sentiment, and philosophy of the lumber business interpreted by the "Lumberman Poet." A kind of touch with the great outdoors that few books contain. Illustrated in tint, bound in silk cloth and gold stamped. Ideal for gift or library. *Price, \$1.25*

THE GARDEN

ROSES AND HOW TO GROW THEM. By many Experts. In text, practical; in subject and quality of illustrations, beautiful. *Price, \$1.20*

FERNS AND HOW TO GROW THEM. By G. A. WOOLSON. The growing of hardy ferns, both in the garden and indoors. *Price, \$1.20*

LAWNS AND HOW TO MAKE THEM. By LEONARD BARON. For the first time the subject of lawn seed mixtures is set forth and explained. 32 photographs. *Price, \$1.20*

HOW TO MAKE SCHOOL GARDENS. By H. D. HEMENWAY. This suggestive little book is a practical manual of school gardening for both teacher and pupil, and supplies the first adequate work of the sort in this country. There are to-day a hundred thousand school gardens in Europe, and the progress of the recent movement in America has been most rapid. This volume is based on actual experience (the author is an authority and director of the Hartford School of Horticulture). Illustrations, 10. *Price, \$1.10*

HOW TO MAKE A FRUIT GARDEN. By S. W. FLETCHER. An eminently practical work on the subject of fruits for the home. With 182 photographic illustrations by the author. *Price, \$2.25*

HOW TO MAKE A FLOWER GARDEN. A charming and a practical book by experts on every branch of the subject. More than 200 beautiful photographs. *Price, \$1.75*

HOW TO MAKE A VEGETABLE GARDEN. By EDITH L. FULLERTON. The only adequate book on the home vegetable garden. 250 photographs by H. B. Fullerton. *Price, \$2.20*

ART AND CRAFT OF GARDEN MAKING. By THOMAS H. MAWSON. Third edition of this standard; out of print for a year, and now reissued in revised form. Over 100 plans and details of gardens. Methods employed by successful designers carefully analyzed. Characteristic sites in typical districts described and pictured. *Price, \$15.00*

THE HOME AND FARM

THE COUNTRY HOUSE. By CHARLES EDW. HOOPER. A Practical manual of house building, absolutely invaluable to every one with a country place. It covers every branch of the subject in detail and treats of the garden and its furnishings in connection with the dwelling. 380 photographs and plans. *Price, \$3.30*

THREE ACRES AND LIBERTY. By BOLTON HALL. Description of what can be accomplished on a small place in the way of gardening, home-making, and addition to financial resources. Were it not for the unimpeachable authorities quoted, its statements as to the possibilities of the "Little Lands" for a living would seem fanciful. *Price, \$1.85*

THE MAKING OF A COUNTRY HOME. By J. P. Mowbray ("J. P. M."). This delightful story showed its universal appeal when published serially, and the volume amply carries out the intention of the author. Besides its practical interest for the thousands of city dwellers who have dreamed of having a country home, the story is one of such reality, humor, and interest as to ensure it the widest circulation in book form. Elaborately decorated. *\$1.65*

THE FIRST BOOK OF FARMING. By CHARLES L. GOODRICH. No one interested in farming, old or young, can fail to appreciate this book, for it really gives the fundamental knowledge of how to conduct a farm with the least expense and the largest return. There are 63 full pages of helpful illustrations. The price is extremely low for a work of such value. 63 pages of photographs. *Price, \$1.10*

NATURE BOOKS

AMERICAN FOOD AND GAME FISHES. By DAVID STARR JORDAN and E. W. EVERMANN. Fills a long-felt need in popular scientific works, being a full account of the life-histories and methods of capture of North American food and game fishes. The only book in existence which will enable the amateur readily to identify species new to him. With 10 lithographed color plates, 100 photographs of live fish in the water, and 200 text cuts. *Price, \$4.40*

NATURE BIOGRAPHIES. By CLARENCE M. WEED. This volume is a sort of personal acquaintance with the lives of the more common butterflies, moths, grasshoppers, flies, and so on, the sort of fascinating details of these insect existences which make the reader want to go out and study these every-day marvels for himself. 150 photographic illustrations. *Price, \$1.50*

THE BROOK BOOK. By MARY ROGERS MILLER. A brook is one of the most living and companionable features of the landscape, and few people, even the most ardent nature lovers, realize what an endlessly interesting study its changes and its throbbing life afford. It is a fascinating subject which the author (well known as a teacher, lecturer, and writer connected with the Nature Study Bureau at Cornell) handles with much ability. 16 photographs. *Price, \$1.50*

OUTDOORS. A Book of the Woods, Fields, and Marshlands. By ERNEST MCGAFFEY. Papers on out of doors, showing a love of nature and keenness of observation and power and beauty of description rarely surpassed. *Price, \$1.25*

NATURE AND THE CAMERA. By A. RADCLIFFE DUGMORE. Mr. Dugmore is an expert in the new movement of photographing live birds, animals, fish, flowers, etc. His works brought him so many requests for information, that he has set down here a full and detailed account of his methods. From the choice of a camera to questions of lighting, and to the problem of "snapping" shy birds and animals in their native haunts, every step is explained so simply as to be easily comprehended, even by the beginner. 53 photographic illustrations. *Price, \$1.50*

YOU

Can help in the work of caring for the Nation's natural resources, putting a stop to criminal waste, educating the public in regard to the necessity of caring for the resources we have, and replacing those we have lost by

NOMINATING

Use the blank below, adding to it if necessary. Your help is needed—needed by The American Forestry Association; by the present generation; by the generations to come.



WILL YOU HELP?

Nominations for Membership



The activities of the National Office of the American Forestry Association are limited chiefly by its resources. These are derived almost wholly from its members in the form of dues. Every member is urged to aid in increasing the membership. Kindly fill out the enclosed blank form, lengthening the list, where possible, by attaching and filling blank sheet. The list should then be sent to

THOMAS E. WILL
Secretary American Forestry Association
1417 G Street Northwest, Washington, D. C.



I hereby nominate the following persons for membership in The American Forestry Association:

Name

Address

.....
.....

Signed.....

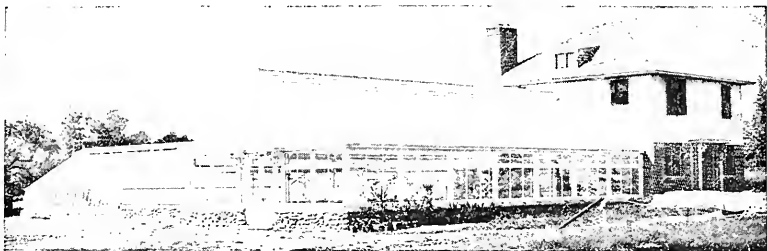

The Greenhouse

This range of greenhouses was erected for the Connecticut Agricultural College at Storrs, Conn., and will be used solely for the practical instruction of the students.

It is of our Sectional Iron Frame Construction, which, because of its great durability, its consequent freedom from repairs, makes a lasting investment.

It is of this same construction that we build our various types of ornamental greenhouses for private grounds. The wide scope of possibilities of this construction make it the ideal one for all other kinds of glass enclosures, such as conservatories, orchard houses, swimming pools, orangeries, and so on.

In our book, "Greenhouses As We Build Them," just published, we devote 72 pages to showing in an interesting, fully illustrated way just such information as you want to know before building. It even goes so far as to devote a few pages to the question of choosing a site for the greenhouse, and gives some half dozen or so examples of the usual and somewhat unusual placing.

This book we want to send you.

LORD AND BURNHAM CO.

Greenhouse Designers and Builders

1133 Broadway

NEW YORK



CERTIFICATES OF DEPOSIT

Run for two years. Issued in denominations of \$100 or more. Fully protected by first mortgages on improved real estate deposited in trust with one of the strongest trust companies in Baltimore. Interest checks at the rate of 6 per cent per annum, mailed every six months

These certificates are not only convenient and absolutely safe, but they may be readily converted into cash at any time—your savings are not tied up indefinitely—yet the interest rate is much larger than you usually get for your savings

We pay 5 per cent. on ordinary savings accounts, withdrawable at any time. Write for the booklet giving full details of this old, conservative company, and its methods of doing business.

In business fourteen years

The Calvert Mortgage & Deposit Company

1069 Calvert Building BALTIMORE, MD.

Thorburn's Seeds

We carry a large assortment of seeds of EVERGREEN and DECIDUOUS TREES and SHRUBS, both native and imported, and shall be glad to quote on any that are still unsold.

J. M. THORBURN & CO.

33 BARCLAY STREET

Through to 38 Park Place

Established 1802

NEW YORK

Biltmore Forest School

Biltmore, N. C.

Theoretical and practical instruction in all branches of applied forestry.

The course comprises eighteen months; twelve consecutive months of lectures and field work, and six months of practical experience.

Object lessons within the mountain estate of George W. Vanderbilt, comprising 120,000 acres where forestry has been practiced since 1895.

For further information apply to
C. A. Schenck, Director

Colorado School of Forestry

Colorado Springs, Colo.

Three years' course in
TECHNICAL AND
APPLIED FORESTRY

Winter Term at Colorado College, Colorado Springs. Summer Term at Manitou Park, on the borders of the Pike's Peak Forest Reserve.

Tuition
Sixty Dollars a Year

For further particulars apply to
Wm. C. Sturgis, Dean
Colorado Springs, Colo.

YALE FOREST SCHOOL NEW HAVEN, CONNECTICUT

The course of study in the YALE FOREST SCHOOL covers a period of two years. Graduates of collegiate institutions of high standing are admitted as candidates for the degree of Master of Forestry.

The Summer School of Forestry is conducted at MILFORD, PIKE COUNTY, PENNA.

FOR FURTHER INFORMATION ADDRESS

HENRY S. GRAVES, Director

New Haven, Connecticut

CONSERVATION



WOOD AND WATERS
SOILS AND ORES



VIEW IN KERN RIVER CANYON, CALIFORNIA

SAVE YOUR TREES

THE MAGNIFICENT TREES WHICH
SURROUND YOUR HOME ARE
WITHOUT DOUBT ONE OF
THOSE PRICELESS LEGA-
CIES TO WHICH THE
PAST HAS MADE
YOU HEIR. IF
THEY DIE, THEY
CAN NOT BE
REPLACED
AT ANY
COST

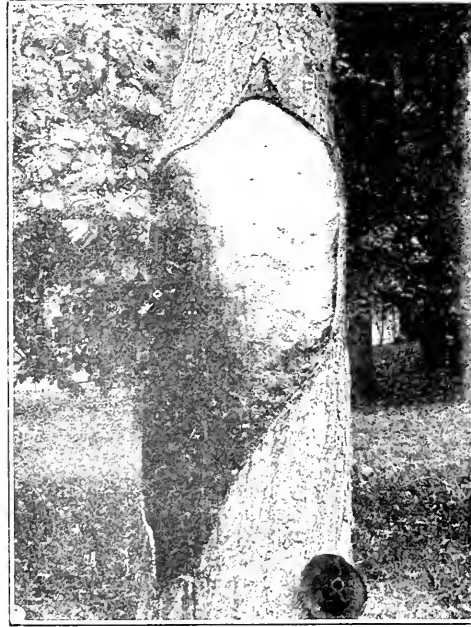
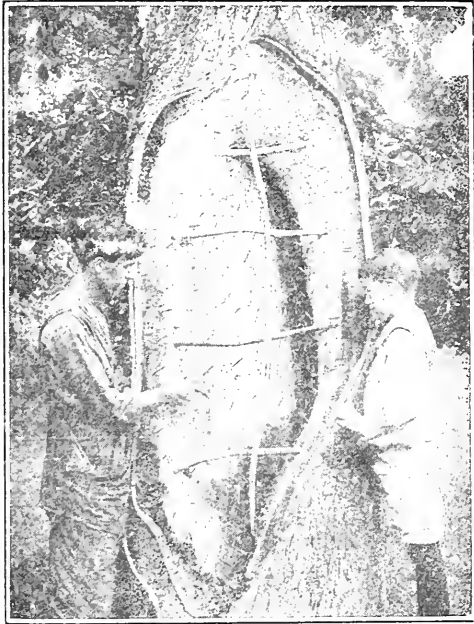

*Your
house can
be
replaced
but
your trees
can not*

PERFECT CEMENT WORK

A magnificent horsechestnut on the estate of Mr. William Rockefeller, showing the methods we used in its treatment. The decay was carefully removed; our own system of water-sheds was used just inside the edges of the cavity; the interior was thoroughly waterproofed; the walls of the cavity were studded with nails to help hold the cement firmly in place; both transverse and longitudinal iron braces were inserted for the double purpose of strengthening the tree and the cement; the cavity was then filled in such a manner as to restore the contour of the tree. The bark will heal completely over the filling, and in time practically conceal all traces of the wound.

B. M. HAWKS, SUPERINTENDENT

Berkmond Hall

Tarrytown, N. Y., April 11, 1907.

Last fall Mr. Davey's men worked on the trees on this estate for several weeks, and their work was very satisfactory indeed. I can cheerfully recommend them. I shall be very pleased to answer any questions.

B. M. HAWKS, Superintendent for Mr. Wm. Rockefeller

TREE SURGERY The name **DAVEY** and the expression **TREE SURGERY** are synonymous. John Davey conceived the idea of tree surgery, his genius made it a science, and his men are qualified as no one else could possibly be to execute it.

Nearly half a century of experience makes our work perfect

DAVEY'S TREE EXPERTS

School of Practical Forestry

Eastern Office, Tarrytown, N. Y.

THE BEST IS NONE TOO GOOD IN THE CARE OF YOUR TREES

Our interesting booklet "A Great Revelation" will be mailed free on request



EVERGREENS 2 to 10 FEET HIGH

You have over 30,000 to select from that have been especially trained for successful transplanting in September. They have been recently transplanted or root pruned; tops pruned in June to make them dense and symmetrical. PINE, CEDAR and HEMLOCK up to 10 to 25 feet high in carload lots.

Now is the time to select from our stock of SHADE TREES which save 10 to 20 years waiting. They are grown 12 to 25 feet apart and prepared for successful shipment.

Will a group of shade trees 25 to 30 feet high make your place more beautiful and comfortable?

FOREST SEEDLINGS AT LOW RATES

Call at the Nursery or send for our beautifully illustrated catalogue and price list

ISAAC HICKS & SON, Nurserymen, Scientific Treemovers
WESTBURY STATION, LONG ISLAND, N. Y.

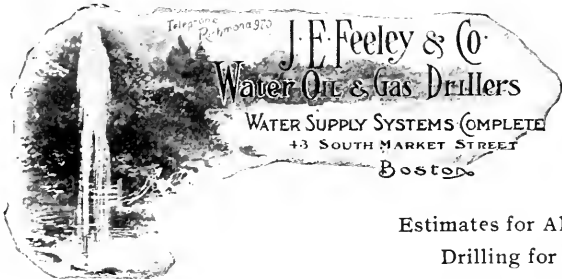

**Test Boring for Minerals,
Water, Gas or Oil in any
part of the United States or
Canada.**

Telephone, Richmond 970

Estimates for All Kinds of Pumping Outfits

Drilling for Water, Oil or Gas Wells

J. E. FEELEY & CO.

43 SOUTH MARKET STREET, BOSTON, MASS.

Flowing Well, New Mexico

J. E. FEELEY
F. A. BASFORD

Plant for Immediate Effect

Not for Future Generations

Start with the largest stock that can be secured! It takes over twenty years to grow such Trees and Shrubs as we offer.

We do the long waiting—thus enabling you to secure trees and shrubs that give an immediate effect. **Fall Price List Now Ready.**

ANDORRA NURSERIES CHESTNUT HILL
PHILADELPHIA, PA.

WM. WARNER HARPER, Proprietor

Real Estate, Farms, etc.

The following advertisements of Real Estate, Farm Lands, Timber Lands, etc., are the announcements of reliable firms and agencies. The Advertising Manager of FORESTRY AND IRRIGATION has investigated the announcements in all cases, and feels safe in recommending the advertisers to the readers of the magazine. The services of this department are free to all members of The American Forestry Association and subscribers to this magazine; advice in regard to the purchase of Real Estate advertised in our pages is gladly given, and our readers are urged to make the fullest use of our services in all matters pertaining to the purchase of advertised Real Estate, of whatever character, no matter where it is located.

VIRGINIA

Rockbridge County, Virginia

offers advantages to the home-seeker equaled by few and excelled by none.

LEXINGTON

the County Seat, is a town of homes; 4,000 people, two large institutions of learning, good high school and graded school. THREE BANKS with over a million dollars of deposits, beautiful scenery, healthful climate.

SAM'L B. WALKER, JR.

FARM, MINERAL, TIMBER, COAL LANDS
LEXINGTON, VA.

Great Opportunity

A celebrated estate containing 2,200 acres, located four miles above Yorktown, Va., on York River, is for sale. Splendid place for club house and hunting and fishing preserves. Address

OLD DOMINION LAND COMPANY

Newport News, Va.

FINE DAIRY FARM

IN FLORIDA

100 acres. 12-room house already furnished, together with all the cows and other stock, farming implements, etc. A small orange grove, peach orchard and other fruits. Offered at a great bargain for quick sale, as owner's wife has been paralyzed and must leave.

M. B. NICOL

Manassas

Virginia

A VIRGINIA BARGAIN

No. 45.—245 acres strong lime-stone and blue-grass land, situated in a fine section of Augusta County, Va. About 2 1/2 miles from N. & W. R. R., about 5 miles from station on C. & O. R. R., about 2 1/2 miles from a station on B. & O. R. R., and about 9 miles from Staunton. Fronts on main road. Well fenced and well watered, and has about 15 acres of good timber. Land is gently rolling and well adapted to both grazing and cultivation.

IMPROVEMENTS: Large old 12-room residence with spacious rooms and halls, large bank barn 50 by 75 feet, stable under barn for 45 head of stock, large hog-pen, granary, hay-shed, carriage-shed, corn-crib, blacksmith-shop, smoke-house, large hen-house, and other outbuildings. About 5 acres of orchard in good bearing, trees about 15 years old. A good tenant house with 5 rooms. All in all, this is a very desirable place.

Price, \$20,000.00, one-third cash, balance on good terms.

R. W. MENEFEE & CO.

Timber Lands and Farms
STAUNTON, VA.

Virginia Country Homes

Grain, fruit, dairy, and blue-grass farms for sale in the best portion of the state. Also timber lands.

Climate, social conditions, and nearness to markets, make this a splendid country in which to locate.

Write for free illustrated register. We solicit correspondence.

H. W. HILLEARY & CO.

Charlottesville, Virginia

The Peninsula of Virginia

The most favored section of the state. Good lands, fine climate, healthy; good crops and good markets; fine schools, best society. Farmers making big money growing Irish potatoes, corn, hay, berries, etc. One man cleared \$100 per acre from potato crop this season, and now has second crop, corn, growing on same land. Hundreds of Western and Northern people already here, and hundreds more coming. It's the best country in the world. Send 5c (stamps) for descriptive literature.

Piedmont & Tidewater Land Co., Inc.

Box 70
Williamsburg, Virginia

Farms and Homes in Virginia

Free from frost 183 days. Plowing season 315 days, growing season 225 days. **Why not move to Virginia** where you can buy good level land with buildings, timber, fruit, water, etc., at \$8 per acre and up? Best climate, health, markets, transportation facilities, churches, schools, active business life. Our **Illustrated Real Estate Herald**, with map, tells all about it. Write to-day for free copy.

PYLE & COMPANY (Inc.), PETERSBURG, VIRGINIA

VIRGINIA INVESTMENTS

J. NELSON GARNETT, Real Estate and Loan Agent, CULPEPER, VA.

High-class Loans and Mortgages our Specialty

Choicest homes and investments of every description in Northern or Piedmont Virginia, the garden spot of the world, and the booming Southland, within sixty miles of Washington. Write for property list and other information.

VIRGINIA

Farms, City Property
Timber and Mineral

LANDS
A Specialty

*Large Tracts for
Colonization*

International Farm Agency

(INCORPORATED)

900 Main Street

Lynchburg, Va.

TIMBERLANDS IN THE SOUTH

We offer timber tracts in Virginia, North and South Carolina, and other sections of the South.

FIRST-CLASS SOUTHERN PINE
AND HARDWOODS

The tracts are covered with virgin growths of Southern Yellow Pine and Hardwoods, the timber alone being worth the price asked for the lands. Land is all good farming land after it is cleared. All are within a reasonable distance of Charleston. Particulars on request.

O. H. PERRY TIE & LUMBER CO.
Norfolk, Virginia

FOR SALE

One of the finest farms in Northern Virginia, containing 314 acres of blue-grass land. The improvements are as follows: Fine stone house of 14 rooms, large bank barn, double corn-house, ice-house, hen-house, meat-house, 5-room tenant-house, orchard of all kinds of fruit. Every rod of fence is in perfect condition. This is an ideal stock farm for the money. Price, \$20,000. Terms, \$5,000 cash, balance in one, two, three, and four years. This farm is situated near Bluemont, Va.

No. 2.—283 acres, house of 9 rooms; barn for 10 cows and 16 horses, new dairy; a nice spring of water; a living stream through the farm; 80 acres in timber; smooth land and a good quality; in nice neighborhood; four miles from railroad station. Price, \$18 per acre; terms favorable.

Send for our list and we will gladly mail it to you. Address

J. W. BAUCKMAN & SON
Real Estate Brokers Herndon, Va.

A FINE LOUDOUN COUNTRY FARM FOR SALE

This farm contains 169½ acres, 2 miles from Leesburg, 1½ miles from Clarks Gap, on the Southern Ry.; there is about 30 acres of corn on the farm, 20 acres in good woodland, balance in grass; this farm produces well, either for grazing purposes or cultivating; well watered with running streams of water, a splendid spring and dairy house convenient to the dwelling, an 8-room dwelling, with nice shade, etc.

There was about 50 tons of hay made on this place this year. There is an extra fine barn, room for 6 or 8 head of horses and 20 cows, corn house and other out-buildings.

This farm has been equipped as a dairy farm and has been run as such until recently, shipping milk to Washington, where there is one of the best markets for milk there is to be found. Any one can run 25 to 30 cows on this farm; by doing so, would have a regular monthly income the year round.

The owner is an old dairy farmer, and offers his services gratis for a week or so to any one wishing to learn the dairy business.

Apply to

HAYWARD & BROWNING, Falls Church, Va.

A MAGNIFICENT VIRGINIA ESTATE

(Only 87 minutes by rail from Washington.) Contains 1,023 acres, about 500 acres in blue-grass, 200 acres in timothy and other grasses, 200 acres in grain and crops, and about 100 acres in good timber.

160 cattle were fattened on this place last year, and sold for over \$12,000; besides this, there was sold from the place over \$1,200 worth of hay. The corn crop averaged sixty bushels to the acre. A small field of alfalfa was cut three times, and could have been cut another time. There are nearly 500 thrifty bearing fruit trees. The soil is a dark rich loam, well drained. Splendid new residence of thirteen rooms, two bath rooms, over 100 feet of porch, 10-acre lawn, all modern improvements, hot and cold water, steam heat and gas. Besides this mansion, there is another 6-room house, three tenant-houses, two sets of farm buildings, five stock barns for hay, etc.

It is not more than one-fourth of a mile from a prominent station on the Southern Railroad, and very convenient to Washington and the northern cities. Acre for acre, this farm is second to no farm in Virginia.

For price and particulars, address

JOHN A. NICHOL, Manassas, Virginia

Timber Lands and Farms

- 42,116 acres in.....S. Carolina
- 8,300 acres in.....S. Carolina
- 60,000 acres in.....West Virginia
- 48,000 acres in.....Western N. Carolina
- 660 acres in.....N. Carolina
- 25,880 acres in.....Georgia
- 2,000,000 acres in.....Florida
- 35,000 acres in.....Mississippi
- 30,000 acres in.....S. Carolina

For Sale by

H. C. HOGGARD & CO.

NORFOLK, VA.

ADVERTISERS

of Real Estate, especially Farm Lands and Timber Lands, find CONSERVATION a profitable advertising medium.

BUYERS

of properties of these kinds rely on those whose announcements appear in CONSERVATION. Advertisers must be reliable, else they cannot buy space in this magazine. Our readers know this.

RATES ON APPLICATION

CONSERVATION

1417 G Street N. W. Washington, D. C.

WANTED

To purchase yellow pine timber tracts in quantities from ten to one hundred million feet. Would consider a going proposition if there is a large amount of timber in proportion to mill investment. Address, with full particulars,

Box 683

RICHMOND, VIRGINIA

One hundred sixty-five acres, 9-room house, six 6-room houses, four cattle barns, calf barn, machinery, and every convenience for dairy. Improvements cost \$180,000. Price, \$35,000

ANDERSON REAL ESTATE & LAW CO.
Richmond, Va.

Summer homes, hunting preserves, and farms, in Old Virginia. Write,

W. E. LAWSON
Hampton, Va.

Southern Real Estate, especially Virginia. Catalogue free.

GEO. E. CRAWFORD CO.
Richmond, Va.

WASHINGTON, D. C.

WONDERFUL BARGAIN

535 acres on beautiful Chesapeake, in southern Maryland; two miles water front, affording splendid opportunity for oystering; 200 acres fine timber; large, old fashioned brick dwelling; six room tenant house; two new tobacco barns, largest in county; several other outbuildings; near wharf, schools and churches and easily accessible from Baltimore and Washington; will take \$9,000, which is less than cost of buildings; other high-class farms and grand old colonial homes, finest in South. Catalogue. Splendid timber propositions.

SOULE REALTY COMPANY

WE SELL FARMS

BOOTH'S FARM AGENCY

Cor. Eighth and G Sts. N. W.

We are specialists on Farms and Country Homes in Maryland, Virginia, and the District of Columbia.

Our Farm Bulletins contain hundreds of the best Estates, Fruit Farms, Dairy and Stock Farms, Poultry Farms, Truck and Garden Lands that are on the market at this time near Greater Washington, D. C.

We offer absolutely the cheapest and best homes for the least money in the United States.

Write or call for our Md. or Va. Bulletins, free for the asking, and be convinced. Now is the time to buy Farms and Country Real Estate in and around the National Capital.

BOOTH'S FARM AGENCY

Ouray Building

Cor. Eighth and G Streets Northwest

WASHINGTON, D. C.

1,000 BARGAIN FARMS

REAL ESTATE

BOUGHT, EXCHANGED AND SOLD

No matter where located, will buy or sell your business or Real Estate for CASH. Real Estate loans at lowest rates.

CLARENCE E. TUCKER

Metropolitan Bank Bldg. Washington, D. C.

FARMS near the National Capital, suitable for all classes, and purposes, reasonable in price, advantage of best market in the country. Healthy and delightful climate.

Write us for particulars.

NATIONAL FARM AGENCY

1407 N. Y. Ave. N. W. Washington, D. C.

MARYLAND

A SPLENDID OPPORTUNITY

150-acre farm in Maryland, within driving distance of Washington, D. C. Has first-class soil, well suited for all agricultural purposes; a substantial brick mansion, colonial style, of fourteen large rooms, marble mantels, and a cellar under the whole house. All necessary farm buildings, and a large orchard. Price, only \$4,000; must be sold at once.

H. BADENHOOP

111 N. Charles St., Baltimore, Md.

(Call or write for my list of Maryland farms)

S. P. SPEERS

Timber and Coal Lands Southern Pine and Oak

Nine thousand acres Hemlock in S. E. West Virginia. Directly on railroad, easily accessible by tram road.

OFFICE, 206 LAW BUILDING, BALTIMORE, MD.

Desirable Farms

Near Baltimore, Md., and Washington, D. C.

AUBREY BIRD & CO.

1105-7 Calvert Bldg., Baltimore, Md.

For additional real estate advertisements see last advertising section.

NEW YORK

Country Property

Timber lands, coal lands, farms, country seats, hotels, factory properties, water powers, game preserves, water fronts on lakes, rivers and salt water, etc., etc.

Archibald C. Foss

39 EAST 42ND STREET, N. Y.

Branch Offices:

South Norwalk, Conn., Millerton, N. Y.

FOR SALE

Game and Trout Preserve

Sullivan County, New York; 2,300 feet above the sea level, 425 acres, over 300 acres in forest; a lake covering 70 acres, fed by numerous springs located on the premises. Lake stocked with trout; there are also partridge, deer, and other game.

Large four-story house and a two-story cottage, both furnished; fine views; for sale, including furniture, stock, implements, etc. For terms and particulars, address

W. F. DAVENPORT

171 Broadway, New York, N. Y.

FOR SALE - FARMS, COUNTRY ESTATES, BUILDING SITES; ALL SECTIONS; WRITE YOUR WANTS.

W. F. DAVENPORT
171 BROADWAY, NEW YORK, N. Y.

PENNSYLVANIA

Philadelphia Farm Agency

WE represent 800 owners of farms near Philadelphia; where farms are cheaper and markets are better than near any large city in this country. I can sell a good 50-acre farm for \$2,500 to \$4,000. Write and tell us your requirements; we have the properties.

E. H. TRENCHARD, Farm Specialist
1230 Arch Street, Philadelphia, Pa.

11,000 ACRES

TITLES PERFECT

J. F. WEATHERS & COMPANY

Timberland in Alabama on new railroad. Will cut 8,000 feet merchantable lumber. Will sacrifice for quick sale at \$6 00 per acre. Underlaid with 3 seams best coal and fine iron ore.

TIMBERLAND SPECIALISTS
1326 Broadway, New York

THE American Forestry Association

Officers for 1908

President

Hon. JAMES WILSON, Secretary of Agriculture

Vice-presidents-at-large

DR. EDWARD EVERETT HALE	GEO. T. OLIVER
N. J. BACHELDER	DR. B. E. FERNOW
GEO. FOSTER PEABODY	GEO. C. PARDEE
RUTHERFORD P. HAYES	ALBERT SHAW
W. W. FINLEY	J. T. ROTHROCK
CHARLES R. VAN HISE	

Advisory Board Selected by Affiliated Organizations

H. H. WHELESS	GEORGE E. STONE	W. K. KNOX
JAMES INNES	ALLEN CHAMBERLAIN	A. L. HAYES
C. H. KEYS	D. E. KLINE	FREDERICK S. UNDERHILL
ROBERT C. LIPPINCOTT	E. F. SAWYER	ROBERT L. LIPPINCOTT
GEORGE F. CRAIG	F. E. WEYERHAEUSER	S. B. ANDERSON
C. A. SMITH	KENT SHEPPARD	ROBERT A. JOHNSON

Members of Board Designated as Vice-Presidents of Association

N. W. McLEOD	LEWIS DILL	J. T. WYLIE
WILLIAM IRVINE	EDWIN A. START	D. E. KLINE
GEORGE H. HAMPTON	SAMUEL B. VROOMAN	B. W. PORTER

Secretary, THOMAS ELMER WILL, Washington, D. C.

Assistant Secretary, FRANK GLOVER HEATON, Washington, D. C.

Treasurer, OTTO LUEBKERT, Washington, D. C.

Directors

JAMES WILSON	WILLIAM L. HALL	W. J. McGEE
GEO. P. WHITTLESEY	GEORGE K. SMITH	PHILIP W. AYRES
JAMES H. CUTLER	WILLIAM S. HARVEY	ROBERT GARRETT
HENRY S. GRAVES	H. A. PRESSEY	LIGON JOHNSON
F. H. NEWELL	ASBURY F. LEVER	FILIBERT ROTH

Application for Membership

To THOMAS ELMER WILL

Secretary American Forestry Association

1417 G Street N. W., Washington, D. C.

Dear Sir: I hereby signify my desire to become a member of the American Forestry Association. Two Dollars (\$2.00) for annual dues are enclosed herewith.

Very truly yours,

Name _____

P. O. Address _____

The American Forestry Association

President—**HON. JAMES WILSON**

Secretary of Agriculture

The American Forestry Association was organized in 1882, and incorporated in January, 1897. It now has over 7,000 members, residents of every State in the Union, Canada, and foreign countries. From its origin it has been the tireless friend of the forests.

The object of the Association is to promote the preservation, by wise use, and the extension of the forests of the United States; its means are agitation and education; it seeks to encourage the application of forestry by private owners to forest holdings, large or small; and it favors, especially, the establishment and multiplication of National and State forests, to be administered in the highest interests of all.

The Association seeks as members all who sympathize with its object and methods, and who believe that our natural resources constitute a common heritage, to be used without abusing and administered for the common good. Seeking to conserve our supplies of wood and water, the Association appeals especially to wood-producers and users, including owners of wood lands, lumbermen, foresters, railroad men, and engineers; and to those dependent upon equable stream flow, as manufacturers, irrigators, employers of water power, and those engaged in internal commerce.

The Association meets annually in Washington. It publishes, monthly, *CONSERVATION*, the magazine of authority in its special field. The list of contributors to this publication includes practically all persons prominent in forest work in the United States, making it alone worth the cost of Annual Membership in the Association.

The dues, covering a subscription to *CONSERVATION*, are as follows: Annual—For Annual Members, \$2; for Sustaining Members, \$25; Total, with exemption from all other payments—for Life Members, \$100; for Patrons, \$1,000, and of the above amount, \$1 is set aside each year to pay the subscription of each member to *CONSERVATION*.

THOMAS ELMER WILL, Secretary.

The American Forestry Association.

THE CARE OF TREES

HAVE US INSPECT YOUR TREES

Old trees are usually in need of attention. An inspection serves as an insurance on their welfare, and is often the means of saving valuable specimens found to be in urgent need of attention. The cost is trifling, and your trees are valuable.

PRESERVE YOUR OLD TREES

The best of care must be given old trees. Dead wood cavities, diseases, and other defects must be eliminated if the trees are to live and flourish. By our inspections and experienced treemen we can produce gratifying results.

YOUR DYING ORCHARD

can, by our pruning, spraying, fertilizing, and general care, be brought into excellent condition and made to bear excellent crops. Do not delay, for the deadly San Jose Scale works rapidly.

We will be pleased to mail you our free booklet on THE CARE OF TREES, which shows the work we do and our qualifications.

The accompanying cuts show an important tree on the estate of Mr. J. A. Jeffrey, Columbus, Ohio, recently saved by us.

MUNSON-WHITAKER COMPANY

1104 FLATIRON BUILDING, NEW YORK
840 TREMONT BUILDING, BOSTON

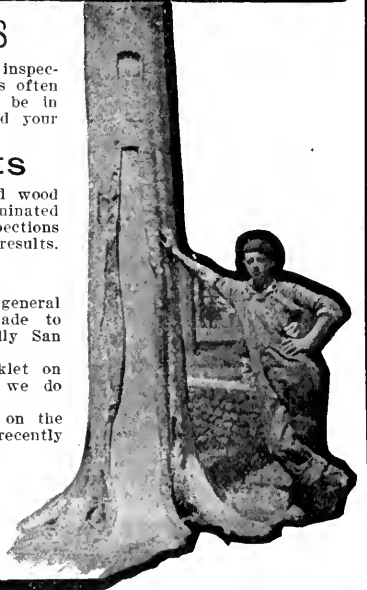

NEW ENGLAND COUNTRY HOMES

Stock and dairy farms, Summer Houses at seashore, White Mountains and Berkshire Hills, from 25 to 1,500 acres of land, ranging in price from \$10,000 up to \$150,000. Will be pleased to give full description and terms.

George C. Davis

70 STATE STREET, BOSTON

High-grade Country Estates

TIMBER LANDS

FOR

INVESTMENT

I sold to a bank president an Adirondacks tract at fifty per cent. more than its owner had paid for it less than a year previous, and the banker was satisfied.

I always have timber properties of inviting character and at inviting prices, and solicit correspondence from investors or those who would buy for operation.

RALPH HERBERT WAGGONER

309 BROADWAY, NEW YORK

CONSERVATION

OFFICIAL MAGAZINE
OF THE
AMERICAN FORESTRY ASSOCIATION

FRANK GLOVER HEATON, *Editor*

CONTENTS FOR OCTOBER, 1908

THE EFFECTS OF EROSION.....		<i>Frontispiece</i>
THE NATIONAL CONSERVATION COMMISSION—By Henry Gannett.....	517	
IRRIGATED LAND OPPORTUNITIES—By G. E. Browne.....	521	
Illustrated.		
THE CHAUTAUQUA AS A PROPAGANDA MEDIUM—By Thomas Elmer Will....	531	
TREE SURGERY AS A SCIENCE—By Martin L. Davey.....	533	
Illustrated.		
A BEGINNER IN FORESTRY—Paper I—By Anne Warner.....	540	
OUR WANING COAL SUPPLY—By Gen. A. Warner.....	542	
THE APPALACHIAN NATIONAL FOREST ASSOCIATION—Secretary's Page...	546	
EDITORIAL		
The Business Side of Conservation.....	548	Louisiana's Proposed Forest Law..... 552
As a Money-saving Proposition.....	548	National Forests in the East..... 554
Reforestation Good Business.....	548	Business Men Should Take Part..... 555
A Permanent Timber Supply.....	549	The Forest Holocaust..... 555
Water Transportation.....	550	Obstructionists Retired..... 558
Water-power and Waterway Extension.....	551	
COMMUNICATIONS		
Varying Views	559	Sweeping Winds
Land Scheme	559	560
NEWS AND NOTES		
A Season of Droughts.....	561	Production of Pig Iron in the United States.... 565
Flood Damage in the South.....	561	Harry Day Everett..... 566
National Conservation League.....	562	The New Mexico Coke Industry..... 567
For Automobileists' Information.....	562	Oil Field Investigations in 1907 and 1908..... 567
Interested in Conservation.....	563	Interest of Women in Conservation..... 568
Tan-bark Supply Failing.....	563	Leading Nations Import Much Lumber..... 569
Information Desired.....	564	The Waters of the Great Lakes..... 570
NAVIGATION RESOURCES OF AMERICAN WATERWAYS—By Emory R. Johnson, Ph.D.		572

CONSERVATION is the official organ of the American Forestry Association. Price, \$2.00 per year, including Annual Membership in the Association. Entry applied for at the Post-office at Washington, D. C., as second-class mail matter

Published Monthly at
1417 G STREET N. W. WASHINGTON, D. C.



THE EFFECTS OF EROSION

The creek formerly flowed close to the base of the hills on the right. Its course now is over 100 yards wider, in many small channels. Erosion of the alluvial lands continue with every freshet, and several houses have been washed away in spring floods. Cane Creek, Mitchell, Co., N C.

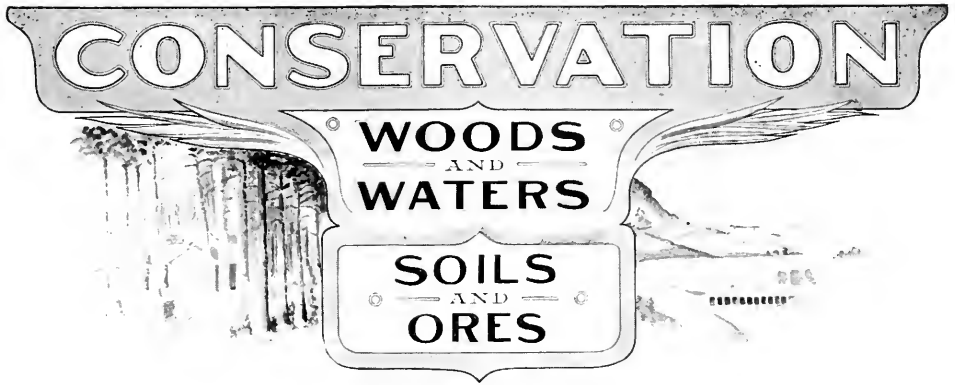

Vol. XIV

OCTOBER, 1908

No. 10

THE NATIONAL CONSERVATION COMMISSION

LIBRARY
NEW YORK
BOTANICAL
GARDEN.

What It Is Doing

By HENRY GANNETT, Geographer, U. S. Geological Survey

(EDITOR'S NOTE.—Mr. Gannett's official designation is Geographer of the U. S. Geological Survey. For several years past he has been assigned to the Census Bureau, and is now practically in charge of the Cuban census. At President Roosevelt's request, he was assigned to the statistical work connected with the work of the National Conservation Commission, because of his superior qualifications and ability. At the completion of the Cuban census Mr. Gannett will devote his entire time to the work for the National Conservation Commission.)

THE National Conservation Commission was formed for the purpose of conserving our natural resources: to reduce waste; to encourage proper and economical use; to increase the supply of such things as can be increased; to induce substitutions of one substance for another when desirable—in short, to encourage all possible measures for making our natural resources go as far as possible.

Naturally, the first step in such a work is to learn just where we stand—to take an inventory of our natural resources—to find out how much timber, iron, coal, land, water, water-power,

etc., we have to draw on, and the rate at which our supplies are being used, and will probably be required in the future. To all this is naturally added the study of the amount and sources of waste and destruction.

With these matters are naturally associated the study of means of economizing, which is, of course, the ultimate end and aim.

The information sought by the Commission is being supplied by various government bureaus, nearly all those engaged in scientific or semiscientific work being more or less fully enlisted in its service.

The inquiries of the Commission naturally resolve themselves into four classes, following the work of the four committees composing the Commission. They relate to *Land, Water, Forest, and Mineral*:

Under *Land*, it asks for the policy and results of the public land system, and what changes in the land laws are desirable. This important matter has been taken up by the law office of the Interior Department. It asks whether there is a tendency toward monopolization of lands, whether farm, timber, or mineral lands, and the causes for such tendency, if it exists. The answer is being sought from several sources: the Bureau of Corporations, the Geological Survey, the Census, and by circular from the farmers.

A question of the greatest importance is whether our soils, as a whole, are being exhausted. This question is answered by a comparison of the yield per acre of certain major crops, at different times. To answer this question we have the statistics of the Census, and those of the Bureau of Statistics of the Department of Agriculture. If it has diminished in fertility, why has this occurred? How can soil erosion be reduced. To what extent is increased production per acre likely to be needed, and how can it be brought about? These questions have been submitted for opinions to the Bureaus of Soils, Plant Industry, and the Office of Experiment Stations of the Department of Agriculture.

Regarding the public range, the Commission asks its condition, the causes of this condition, and the methods by which it can be improved. The grazing division of the Forest Service is at work on this subject.

Concerning swamp and overflow lands, their extent and ownership are sought—also how much has been reclaimed, at what cost and with what financial result. Questions are also asked concerning the possible amount which can be reclaimed, with estimated cost and probable results or profits. This whole subject has been proposed to

the Office of Experiment Stations and to the Hydrographic Branch of the Geological Survey.

Under the general subject of Water, and specifically Irrigation, the Reclamation Service is at work upon the following matters: The amount of land under irrigation. An estimate of the additional land that may be irrigated. Do present laws promote irrigation fully and wisely, and what modifications of law are desirable? The relations of irrigation to forests, navigation, water-power, water supply, drainage, and floods.

The underground water supply is being studied by the Hydrographic Branch of the Geological Survey.

The Weather Bureau has furnished full data concerning rainfall, and that office, in cooperation with the Hydrographic Branch of the Geological Survey, will furnish data concerning the flow of streams, with areas of stream basins. The same offices, in cooperation, are preparing information concerning floods, the specific questions asked being: Are floods increasing, and if so, why? To what extent are flood waters wasted? How much damage do they occasion? To what extent could flood waters be stored, at what cost, and at what saving?

The entire subject of water in its relation to transportation has been undertaken by the Bureau of Corporations, which has already made extended studies on this subject. Concerning this matter the Commission seeks the following information: Whether river navigation has diminished. If it has, the reasons for it. The advantages of an adequate system of inland waterways. How they can be fully utilized for traffic. In addition to the above, many minor subordinate matters are asked for.

The subject, Water-power, has been nearly all turned over for investigation to the Hydrographic Branch of the Geological Survey, with some cooperation from the Bureau of Corporations. The information desired is as follows: The developed and undeveloped water-

powers. Whether developed powers are put to their full use. How far can coal be saved by substitution of water-power. The Bureau of Corporations cooperates with the Hydrographic Branch in obtaining information on the following subjects: Are water-powers being consolidated, and to what extent are water-powers owned by corporations subject to governmental control?

Nearly the entire matter of forests has been placed in the hands of the Forest Service. The Bureau of Corporations is cooperating in obtaining the amount of standing timber and the Census is obtaining the cut of lumber and the amount used as firewood. The matters confided to the Forest Service are as follows: The extent of our original forests. The amount of standing timber remaining. The annual cut. Past and present prices of products. Present rate of growth. How the productiveness of our forests can be increased. How long the present supply will last. What foreign sources of supply are in sight. How our forest resources, consumption and prices and uses of forest products compare with those of other countries. How the cost of our forest administration compares with that of other countries. How far foreign methods of forest administration are suited to conditions in this country. Sources of waste and how they can be reduced. The relations between forests and stream flow. The relation of forests to industry and civilization. What measures must be adopted to perpetuate our timber supply. Of the above, the annual cut is obtained each year by the joint work of the Census and Forest Service.

The entire subject of Minerals has been undertaken by the Geological Survey. The Commission desires to know, as nearly as possible, the amounts of ores and minerals in the ground. The amount mined each year, which is obtained annually by the Geological Survey. Probable duration of the supply. Nature and extent of waste in mining, extraction and use, and methods of preventing or lessening it. How the du-

ration of these resources can be extended.

In addition to the above, the Commission seeks information on the conservation of life and property in mining; the losses by fire and their prevention, both of which subjects have been undertaken by the Geological Survey.

The Bureau of Statistics of the Department of Agriculture has furnished data concerning the losses among live stock by disease, exposure, etc.

The Fish Committee has furnished information concerning the annual catch of fish, the condition of supply, and the work or restocking.

The Biological Survey has furnished information concerning the condition and distribution of game, the annual destruction and natural increase, the useful and deleterious birds and mammals.

The Bureau of Entomology is preparing data concerning the damage done by insects to the forests, to crops, and to manufactured goods.

The Bureau of Statistics, Department of Commerce and Labor, sounds a note of warning to the effect that our exports of bread stuffs and meat have passed high-water mark, and will probably decline henceforward, as we consume more and more of them.

In much of this work the Census and the Bureau of Statistics of the Department of Agriculture have aided materially in mailing circulars and in receiving and tabulating the results.

Everywhere, throughout the government service, the Commission has found the heartiest and fullest cooperation. In most cases, the heartiness of the interest shown extended to a study of the inquiries and their emendation and extension by the chief of the bureau consulted, through his full knowledge of the subject. Moreover, in very many cases, the information sought by the Commission is precisely that which should have been obtained long ago by the bureaus concerned, but its collation has been delayed by the pressure of more immediate duties, and the bu-

reus concerned have, therefore, welcomed this demand, as a reason for doing these things.

All this information is asked for by October 16. Some of it is already in the hands of the Commission, and it is

believed that practically all of it will be in hand by that date. It will then be abstracted and from it a brief report will be prepared for submission to the Commission at its meeting on December 7.

A STUDY IN EROSION

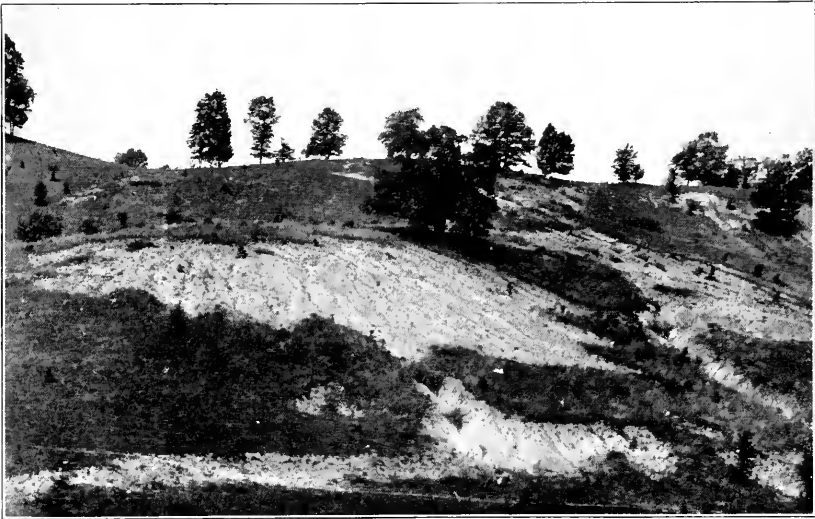

Before these fields were shorn and tilled
Full to the brim our rivers flowed;
The melody of waters filled
The fresh and boundless woods;
And torrents dashed, and rivulets play'd,
And fountains spouted in the shade.

—William Cullen Bryant

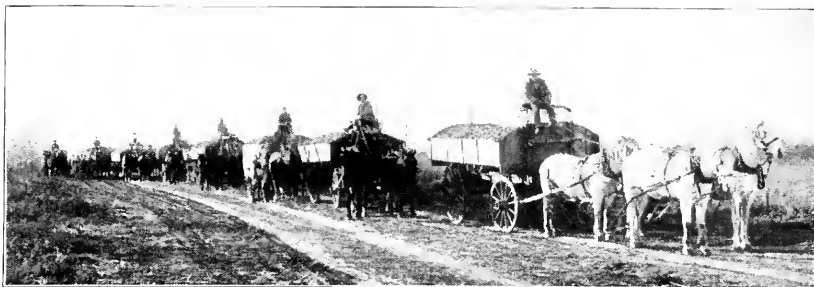

PRODUCT OF IRRIGATED LAND
Hauling Sugar Beets to Factory, near Billings, Mont.

IRRIGATED LAND OPPORTUNITIES

By G. E. BROWNE

THE net profit of \$500 to \$1,000 per acre on fruit lands, and \$50 to \$75 per acre on alfalfa, rye, oats, and winter wheat lands, seems impossible. It looks more impossible when one travels for hundreds of miles throughout the western states and sees nothing but sage-brush lands surrounded by hills and mountains. The fact of the matter is, this land is worthless unless water can be applied. There are many hundreds of thousands of acres of irrigated lands that are settled upon, and many thousand acres that are being developed at the present time. There are also thousands of acres that will eventually be irrigated, but there are vast tracts that never can be, due to the fact that some land is not profitable to put water on, owing to the lay of the land, the rocks, and oftentimes the undesirable slopes. However, this latter class is also desirable, as it is exceptionally good in most cases for sheep and cattle grazing, and when these territories are located near irrigated tracts, the tendency is to keep the cattle close to where feed can be bought.

How can any person make a mistake by investing in irrigated lands? The average forty-acre tract in any irrigated district will yield as large a profit

as 160 acres in the eastern or middle-west states. Most of the land being opened in Idaho, Wyoming, Colorado, and Montana can be bought for \$35 per acre with water rights, and the buyer has from four to eight years to pay for the same. This is virgin soil, and the sage brush signifies that the land has never been robbed of any strength. The soil is exceptionally deep in the best irrigated tracts, and in two years with almost any crop, this land will pay for itself. With a small amount of money, any person can become independent in this new country, where the climate is ideal, and where there are more opportunities to the square yard than to the square mile in the East or Middle West. While fruit raising in the above-named territory has not been developed to as high a state, the possibilities are undeniable. It has been proven that all kinds of fruits except the citrus species thrive in the Northwest, and yield prolifically. At the present time the irrigated lands that have been put on the market recently, and settled, are put into alfalfa and grains, although there are many settlers who are also putting some of their acreage into orchard.

The Yakima, Wenatchee, and Hood River districts, and also the districts

near Spokane, are the great apple territories of the world. Fruit raising here is very highly developed and, in fact, the orchards are a wonderful sight. The orchardist has fruit raising down to a science. The fruit trees are held back from bearing until about the fifth year, and the trees themselves look far different from the scrawny and rank-looking apple trees that are found in the eastern states. The orchards are second only in beauty to the great mountains which surround them. While

of the country come to these districts trying to contract for the fall fruit. The fruit raisers claim that \$3.50 per box for the apples they raise is a low price, for all land which will grow this wonderful fruit commands a price of from \$25 to \$150 per acre before development, according to the location. With water this land is worth \$300 to \$400 per acre. This same land with fruit trees two years old will bring from \$500 to \$600 per acre, and bearing orchards, which are about

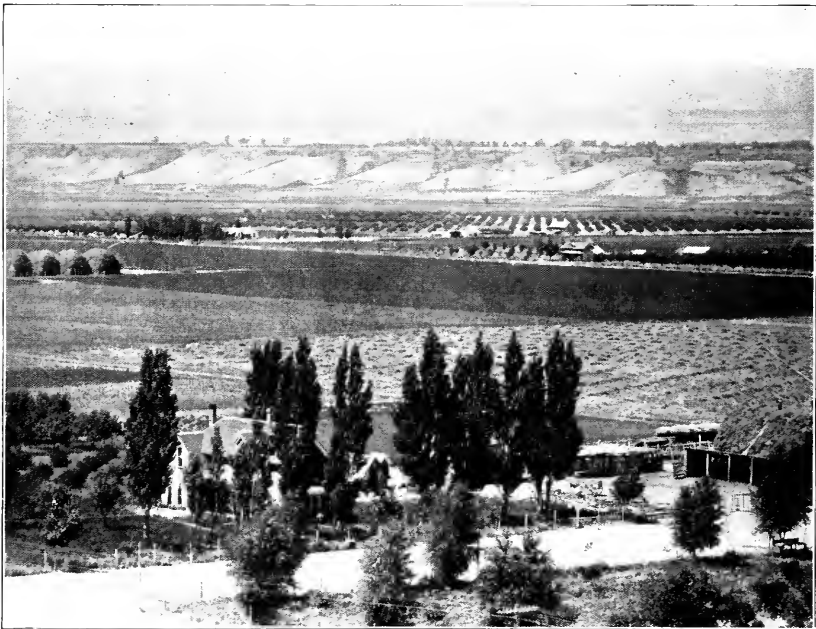

IRRIGATED LAND

Scene in Grand Valley, Colo., Showing Irrigated Crops

there are other tracts which yield great crops of apple fruit, the above-named districts have the reputation, and at the present time the growers here command the highest prices. All apples are packed in boxes which contain about a bushel. Before shipment is made, they are inspected by the Fruit Growers' Association, and it is a proud boast that there never has been a poor or wormy apple shipped from these best districts. The growers receive from \$1.75 to \$3.50 per box, and in the early spring commission men and buyers from all parts

impossible to buy at the present time, are held from \$1,200 to \$2,500 per acre. The first question any person will ask is "are not the values of the land too high, and is there not danger of an over-production?" From the closest study, there will never be an over-production of first-class apples, but where "seconds" are often raised and shipped, there may at some future time be a little over-production in this grade. However, at the present time there is no over-production in any grade of western apples. In the best or-



SCENE ON THE HUNTLEY PROJECT
Wool Going to Market, Billings, Mont.

chards, however, the growers try not to raise any "second" apples. By looking at the land values very closely, it is the general opinion that these same values which some people consider high at the present time, will increase each year. The demand for apples is growing, and especially so for the first-class No. 1 apple. Land that will grow this hardy apple is limited, so the orchards now bearing are conceded to be good investments. A greater part of the best apple orchards in the West are now productive orchards. However, the esti-

mated increased production for the next four or five years will be about twenty per cent. per year. The demand in the last five years for first-class apples has increased thirty-five per cent. per year, so in comparing these two items it is certain that the demand will continue to increase over and above the supply. There is hardly a person that owns over twenty acres of orchard land, and very many tracts are divided into ten and five acre allotments, which clearly goes to show the great value of even a five-acre tract of this desirable fruit land

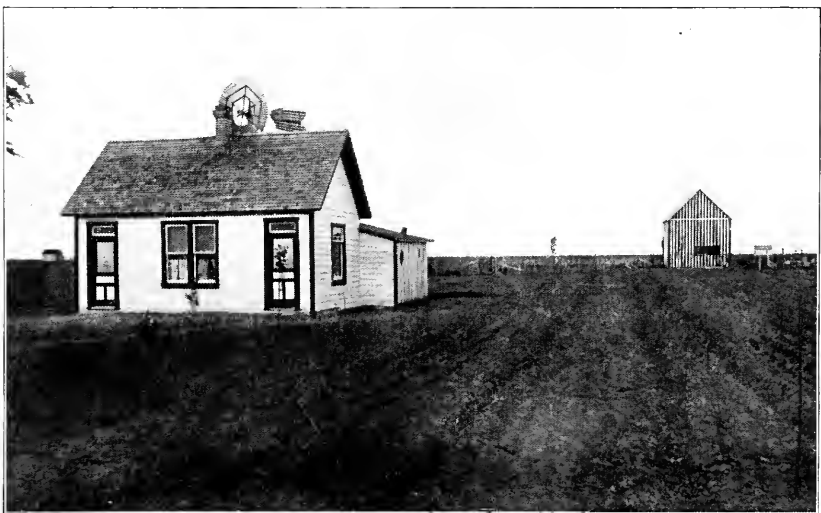

A HOMESTEAD IN IDAHO
Typical Rancher's House, on the Minidoka Irrigation Project



Potatoes in Young Orchard, Uncompahgre Project.

At the present value of orchard land in Washington and Oregon, it takes a great deal more capital to make investments in this territory. While this fruit land is a wonderful investment in the above-named places, and while the apples raised here cannot be equaled in any place known, the prices of the land are somewhat too high for the class of American investors with a limited amount of money.

While Idaho, Wyoming, Colorado, and other sections where irrigation is carried on at the present time raise nearly any kind of fruit, their apples are not the hardy and keeping apple which is grown in Washington and Oregon. Elegant apples are raised, which are known as the "Christmas apple," but which after this season become soft, and have not the keeping qualities which make the northern



Apple Orchard, Uncompahgre Project

apples so famous. This is proven to be due to the mild climate the year round. The land values in these places will never reach the value of the northern fruit lands, but in comparison to the price paid for the land, any investments here are surely good. In the first place, land in Idaho and the surrounding territory, with water rights, is selling far below the same land in

falfa can be readily sold to the ranchers who occupy the hills and mountains during the summer months, and who are in the market during the fall for their winter feed.

The territory west of Colorado is in its infancy. People by the thousands are taking up land, there are opportunities in every line, and all the small towns are increasing in population and



GRAPES ON IRRIGATED LAND

Small Vineyard on Payette-Boise Project, Idaho. Climate and Soil Well Adapted to Grape Culture

Washington and Oregon, and for that reason alone you cannot expect the high values. However, small fruit such as prunes, plums, grapes, cherries, peaches, pears, apricots, and most all berries, make an excellent yield. Sheep, cattle, and hog raising in this territory where grains and alfalfa are raised, is really the best and most profitable investment. Grains and alfalfa can be raised to great advantage, and are very essential to the sheep, cattle, and hog industry. Profits in fattening hogs and cattle are enormous. If the settlers do not own their own stocks, all their hay and al-

wealth accordingly. The people are congenial, and the life is ideal. There has never been an opportunity for a safer investment for a person with moderate means than at the present time in the great irrigated tracts in the West. The irrigation projects are for the benefit of the masses, and as each district is opened the land is taken up immediately by the people who realize and appreciate the great benefits that can be derived from its wonderfully productive soil. There are some irrigation projects which are not equal to others, but there is only one thing for



Irrigated Wheat Ranch in Colorado

people making investments to watch closely, and that is the water supply. This one thing is the all-essential for this land. Any one taking acreage should look at the water supply very closely, the reservoirs and the dams, and especially the flumes and ditches. The government has completed, and is now completing some excellent projects.

Private corporations have done wonders for the country. A close observer will look to the supply of water, seeing that the same is ample at all times, whether it is from the mountain reservoirs or the rivers. One thing is certain that there has never been a failure due to irrigation in the West. While I believe all the irrigating companies at



Irrigation Gardening in Montana



BLACK LOCUST TREES ON IRRIGATED LAND

Row of Three-year-old Trees on Payette-Boise Project, Idaho. Climate and Soil Seem Well Adapted to This Species, and Annual Growth Is about Five-eighths of an Inch

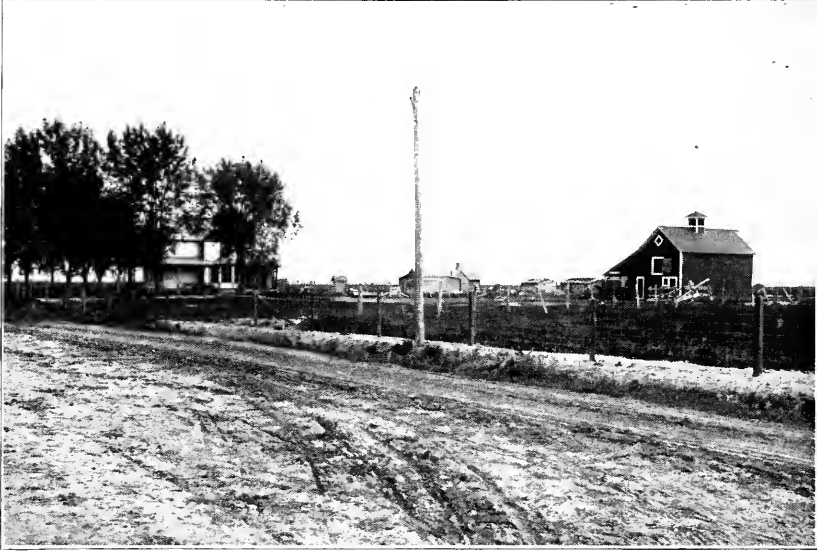

Typical Home on Irrigated Ranch in Montana

the present time are responsible, and in best shape for giving results to home seekers, there may be some projects in the future, due to some great boom, that will not stand the test. There are many acres of land that it would be ut-

terly impracticable to put water on. The different ways of obtaining water are either by damming the rivers and raising the water to such a height that the same can be put on the land, or by constructing reservoirs in the hills and



Stacked Alfalfa on an Irrigated Ranch in Idaho

mountains to hold the water as the snow and ice gradually melts off the mountain tops. However, along the rivers there are a great number of tracts which obtain their moisture by pumping water from the streams upon the land. Probably one of the greatest irrigating systems in the West is in the Lewiston-Clarkston Valley in Idaho. In a portion of this valley the water is carried in pipes under the ground, and land is irrigated by turning hydrants

is certain. All the land needs is water. They have the weather, the sunshine, and the soil, and by adding the water to these narrow valleys, which are merely pockets in the mountains, one can raise wonderful crops, and net large returns per acre. This is what makes even a ten-acre tract a priceless possession. The soil is a volcanic ash; it is very fine and compact, and there is very little evaporation from the same when water is applied. The irrigating



How Potatoes Grow under Irrigation in Colorado

and putting the water on in this manner. This is surely a very convenient and practical way, although the water charges are higher.

Nearly every one visiting these different tracts, or hearing of the same, will ask, "how can they raise such large crops on this soil, and reap such large returns from a single acre?" In explaining this I will say that there is no excuse for crop failure. Excessive rains and floods never come; the sunshine, which makes all vegetation grow to the highest state of perfection where water is applied, is not interrupted by cloudy weather, therefore, your success

or reclaiming the areas in the West has been going on for sometime. However, it never reached large proportions until the Reclamation Act was passed by Congress in June, 1902. Since that time the government has promoted some twenty-five or more projects, and thousands of people have made their homes on these lands, and still other thousands are moving to these new sections to reap the benefits which there await them. While you may say that the irrigation projects throughout the West are in their infancy, you will find that the simple irrigation projects have nearly all been taken up, and the gov-

ernment has been devoting its time to the more difficult engineering problems. As time goes on all irrigating problems will be more difficult engineering feats, and the area of land that will be put under water will be much less in acreage. Values will constantly rise, and while there are thousands of opportunities in the West at the present time, in a few years from now the same people that are investing at this time will see their land double and treble in

value. The people in the East and Middle West are just beginning to realize these advantages and in one tract that was opened the first of June in southern Idaho, if every person had been given land that applied for the same, each would have received about four acres. This is one fact that goes to show the tendency of the times, and this same tendency is growing day by day, as the people are becoming familiar with western possibilities.

IRRIGATED SHEEP RANCH

Feeds 17 Head per Acre, and Could Support 23 Head. Payette-Boise Project, Idaho



THE CHAUTAUQUA AS A PROPAGANDA MEDIUM

By THOMAS ELMER WILL

A WORD as to the Chautauqua as a medium through which to reach the people with the truth The American Forestry Association desires to propagate.

The Chautauqua Assembly was founded in 1874, largely through the efforts of Reverend, now Bishop, John Heyl Vincent, at Lake Chautauqua, New York.

Like many other good things, the Chautauqua, both as an idea and an institution, grew. Chautauqua literary and scientific circles were established throughout the country. In these, students pursued courses of reading, culminating with academic degrees. Increasing multitudes made annual summer pilgrimages to the home of the institution, Lake Chautauqua.

With the growth in numbers, however, came increasing difficulty for Chautauqua patrons to avail themselves of the advantages of the great parent assembly. In time was born the idea that, instead of making it necessary for the mountain to come to Mohammed, Mohammed should go to the mountain. In other words, local Chautauqua assemblies were established at various points throughout the country.

The writer well remembers attending one of these little, local Chautauquas which had pitched its tents and tabernacles in a canyon of a pioneer settlement in north central Nebraska about 1890. Distinguished clergymen, lecturers and teachers were brought many hundreds of miles, and gave to the people there clustering on the very edge of civilization the best thought and highest inspiration of the more populous centers. For a number of years, this local Chautauqua was one of the great features in the life of this community, and was talked of from its adjournment one year to its assembly the following year.

Such local Chautauquas multiplied. They now flourish, especially, in the territory between eastern Ohio and Colorado. Wisconsin, Minnesota, Iowa, Nebraska, Kansas, and Missouri are among the leading Chautauqua states.

Local Chautauquas have, in cases, organized permanently, bought land, and erected tabernacles for assembly purposes. Like theaters and schools, they now constitute a regular feature of the entertainment and educational life of the communities in which they are found.

Quite recently the Chautauqua has made a new departure. Its organization and ownership have become not local but central; instead of being fixed to one spot, it travels, like a circus.

The type of this latter form of Chautauqua is the Redpath Chautauqua System. It experimented with the new plan in the summer of 1907; it developed it to large proportions in the summer of 1908. During the past summer the Redpaths maintained six Chautauqua outfits, each comprising a crew, railway car, large assembly tent, and smaller tents. The institution is owned by the corporation known as the Redpath Chautauqua System. Crew, car, and tents were, in each case, in charge of a superintendent. They went into a town on Monday, operated six successive days, morning, afternoon, and evening, and then moved by rail to another town where they repeated the process and, to a greater or less extent, the same program. Certain speakers and teachers stayed with a given tent through the season, meeting practically the same audience daily for six days. Another type of speaker, however, spoke on Tuesday at one Chautauqua, on Wednesday at another, and so on through the week, oscillating back and forth among the six Chautauquas, perhaps for several weeks; in cases, throughout

the entire season of eleven weeks. He might give the same lecture or entertainment at each point visited, or he might vary it. The season began at Winona, Minnesota, on June 16, and ended at Salisbury, Missouri, on August 30.

Continuing eleven weeks, and serving six towns per week, the Redpaths held sixty-six Chautauquas in the summer of 1908. Of these, two were in Wisconsin, six in Minnesota, nineteen in Missouri, and thirty-nine in Iowa. On rare occasions, a session was broken up by a violent rainstorm. As a rule, however, eighteen sessions were held in each town visited. Tickets cost \$1.50 each. Single admission was charged for at a higher, variable rate.

The writer began at the beginning and stayed to the end of the Redpath season. He visited each of the sixty-six towns and spoke at sixty-four. At two, Dubuque, Iowa, and Savannah, Missouri, though present and ready, he was hindered from speaking by furious rainstorms. He carried with him a handsome set of slides and a first-class lantern and outfit. He was accompanied by an operator, who attended for the most part to lantern, curtain, baggage, and the like.

The audiences addressed at these sixty-four meetings were conservatively estimated at about 1,000 each. In addition, much space—commonly from one column to two columns—was given by the local press to reports of the lecture on conservation. Thus the number reached through the press was probably very much larger than the number reached in the tents. Marked copies of papers reporting the lectures were also quite commonly sent to the representatives and senators of the states in which the lectures were given. To most of the hearers, the subject of general conservation and even that of forestry seemed practically new. Earnest expressions of approval were, however, constantly heard, some auditors declaring the conservation lecture to be worth the entire price of the one-week season ticket to the Chautauqua.

Among the speakers with whom the writer was privileged to associate on this tour may be mentioned the Rev. Samuel Parkes Cadman of Brooklyn; Dr. John S. Carson, of Brooklyn; Hon. David A. De Armond, congressman from Missouri; Judge Lee S. Estelle, of Omaha; Thomas Brooks Fletcher, of Cleveland; Rev. Samuel Garvin, of Kansas City; Dr. Thomas E. Green, of Chicago; Gov. Warren G. Harding, of Ohio; Gov. E. W. Hoch of Kansas; Capt. Richmond Pearson Hobson, of Alabama; Judge Ben B. Lindsey, of Denver; Mr. George L. McNutt; Opie Read, of Chicago; Senator Robert L. Taylor, of Tennessee; and Dr. E. A. Winship, of Boston. A majority of these men spoke in high terms of the importance of the writer's mission. An officer of the Redpath Chautauqua System said the lecture was the type of what, in his judgment was ideal Chautauqua work—solid instruction on a vital theme, combined with a measure of entertainment.

As a medium for presenting forestry and allied truths to the ear and eye of the people who make up the bone and sinew of the common life, the Chautauqua has no equal. A certain contingent comes merely to be entertained, and may not stay to the end of a solid lecture. The great majority will, however, listen intently to every word. Seed may thus be sown which will, in time, bear a rich fruitage. Hence, no more important work could be done by the Association than to cultivate the Chautauqua field.

In closing, the writer may mention a personal experience. On August 25 he spoke at Carrollton, Missouri, the county seat of Carroll County. As a boy, he had lived in that county and now returned to it for the first time in thirty-one years. With feelings probably similar to those of Goldsmith, author of "The Deserted Village," he visited the home of his childhood, to find it reduced to a corn field; one of the few traces still remaining of the old home site being the newly-made stump, over three feet in diameter, of a magnificent maple tree planted by his father nearly forty years ago.



Cemented Cavity

TREE SURGERY AS A SCIENCE

By MARTIN L. DAVEY

Davey's School of Practical Forestry



Cavity Healed

TO HIM who has seen the glorious health of trees in the wild woodland, where nature is the caretaker, the necessity for a science that deals with the weaknesses and infirmities of the individual tree may come as a great revelation. He sees the vigorous trees survive, and the weak ones perish, and he conceives the idea of the "survival of the fittest," from which he concludes that when a tree dies, its death is inevitable. Though erroneous, the conclusion is a natural one, and it is not until he has seen the decline of some favorite tree, one, perhaps, that has shaded his home for generations, that he wonders what might be done to save it.

The care of trees is not new. In a crude way, it has been practiced for centuries; and it remained crude until about half a century ago, when the science of tree surgery was conceived.

Like all the movements that have sprung into being, tree surgery is the result of an idea. McCormick felt the pulse of the farming industry, and it was slow. He recognized the great need of labor-saving machinery and he set to work to meet that need. Then came his reaper, which soon demonstrated its possibilities. Its advent quickened the agricultural pulse, and with other similar inventions has served to raise the business of farming to its modern plane of a science.

In like manner, tree surgery was developed. Some fifty years ago a young man breathed the inspiration to leave the old English farm where his early years had been spent, and find his life's

work among trees and flowers. After the customary careful manner prevalent there, he served his apprenticeship in one of the large English nurseries. Not long after this he felt the call of the New World, and making his way hither, settled in a little town in Ohio. There his work with trees began in earnest; but, in following the course of his training, he recognized its limitations, and set about to remove them. The young man's name was John Davey, and his were the ideas which have so completely revolutionized the methods used in the care of trees. It was evident to him that the ordinary methods were not sufficient. Trees were rapidly going to pieces; their lives were shortened by adverse circumstances; "tree-butchers" were everywhere; ignorance of tree life was almost universal. But the worst trouble was that the people hardly realized the seriousness of the situation. To them a tree was almost an inanimate object—a mere feature of the landscape, like the little brook that rambled through the fields, or the lofty cliff that jutted from the mountain side; a thing that existed rather than lived.

But the tree lives, thought Mr. Davey; it has a life as real as our own, subject to certain fixed laws, which, if recognized, will insure its health, and lengthen its life, but which, if violated, will bring about its decline and premature death.

It is truly fascinating to study the principles which govern the life of a tree, and the conditions under which it

thrives or decays. In the tree there is a circulation that is as real and vital, and necessary to its existence, as that in the human body. The tiny feeding rootlets take up the liquid food from

orous, but if one is destroyed, the other perishes. The transformation of the sap into tree-food is extremely interesting. This takes place in the leaves, where the sap is spread out to the action of the sun and the atmosphere. The oxygen, which is so necessary to our existence, is exhaled, and the carbon dioxide, so dangerous to human life, is absorbed and combined with the elements in the sap, to make the food with which the tree builds.

With this understanding of the principles involved in the life of the tree, let us consider the troubles that arise from their violation, and which it is the business of the tree surgeon to remedy. In general, they include the following: cavities, splitting crotches, dead branches, destruction of the roots, and unfavorable root conditions, insect pests,

the soil, and send it up through the cells of the wood fiber to the leaves, where it is transformed into the tree-food, and returned under the bark, in what is known as the cambium layer, building as it goes, and finally again reaching the little rootlets that are so necessary to the life of the tree. The tree breathes; it breathes through its leaves, and through its bark, and through its roots. It has its time of rest and activity. There is a wonderfully interesting reciprocal relation between the roots and the leaves. The roots are the organs that take up the food, and the leaves are those that digest it. If the roots are healthy there is plenty of food to digest; and if the leaves are healthy, there is an abundance of material from which to build. Each is dependent on the other; if both are healthy, the life of the tree is vig-

and general diseases, fungus growths, gas and electricity, clinging vines, the over-thickness of the top, interfering



A TYPICAL CAVITY

Cherry Tree on Estate of W. B. Thompson, Yonkers, N. Y. Note Front and Rear Openings



A TYPICAL CEMENT FILLING

Same Tree as Above. Contour of Tree Preserved

branches, lack of sunshine, and other conditions unfavorable to the leaves.

Perhaps the one deserving first consideration is the cavity and its treat-

ment. The causes which produce cavities are almost innumerable, but the most common are the following: improper trimming, splitting of weak crotches, gnawing by horses, bruises caused by lawn mowers and other implements, the raising of the bark by lightning, and, not infrequently, the lacerations caused by the climbing-spurs used by telephone men, and, sad to say, by the ordinary "tree-butcher." It may safely be said that as long as the bark, including, of course, that on the roots, remains perfectly sound and whole, there will be no cavities; therefore, whenever the bark is destroyed and the wood fiber is left unprotected, there will be a cavity. Fully half the work of the tree surgeon is undoing the damage that some one else has done. One of the worst troubles which he encounters is the result of improper trimming. When the average man cuts off a limb, he generally does so where the diameter is the smallest, necessarily leaving a stub; or he may leave the stub under the impression that the decay will be so much the slower. And in those rare cases where the cut is made properly, it is seldom that he uses any precaution to keep the wood from decaying while the bark is healing over the wound. All cuts should be made flush with the limb or trunk from which the branch is taken; but, in order to understand the reason for this, it is necessary to take into consideration the circulation of the tree, and the way in which it heals. As a matter of course, where there are no leaves there can be no circulation; and where there is no circulation there can be no healing. Where the end of a limb is taken off, the circulation is destroyed in that part of the tree, the bark dies back to the main limb or trunk, and the stub decays till it falls out and leaves a cavity. The same thing is true when the

top of a tree is cut back improperly. The stubs invariably decay, unless the cut is made down close to a good, live branch, sloping away from that branch, and protected by some method of water-proofing.

The method of treating a cavity, as devised by Mr. Davey, is extremely comprehensive. It is based on exactly the same principles as those of dentistry. First of all, the decayed matter is carefully removed back to good, healthy tissue. The walls of the cavity are then thoroughly water-proofed and studded with nails driven in, which serve to hold the filling firmly against

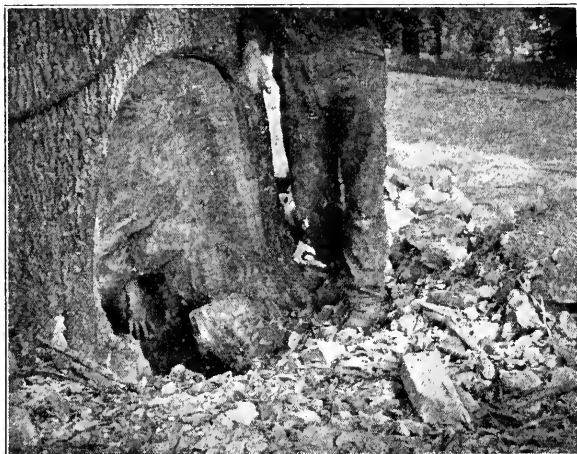

A WATER-SHED

Ash Tree on John D. Rockefeller Estate, Tarrytown, N. Y., showing Water-shed around Cavity

the sides. Drain-tubes are always put in at the bottom of the cavity, extending to the outside of the tree, so that in case water gains entrance from any unforeseen cause, it may be carried off, and the cavity remain dry. Wherever the tree is especially weak because of the cavity, steel braces, both longitudinal and transverse, are put in for the purpose of reinforcement. Water-sheds are invariably used, to keep the moisture out; these consist of deep V-shaped grooves extending from the inside of the top, along both sides of the mouth of the cavity, and out at the bottom, over a ledge that slopes upward and inward. Then the filling of

cement is put in and tamped into place; and after it has set sufficiently, it is shaped in such a manner as to preserve the contour of the tree, and permit the bark to heal entirely over it. In some cases the extra precaution is taken of placing a zinc cap over the cement, fitting it inside the edges of the bark.

The thoroughness of this method is at once apparent, and the thousands of trees which have been thus treated bear

which, though less expensive, was only a temporary makeshift, quickly corroding and tearing loose from the tree as it swayed in the wind, and leaving the cavity open and unprotected as before. Think of a dentist simply placing a piece of tin over an unfilled cavity in a tooth!

It was once thought impossible to render the filling of a cavity permanent and effective; this idea was based

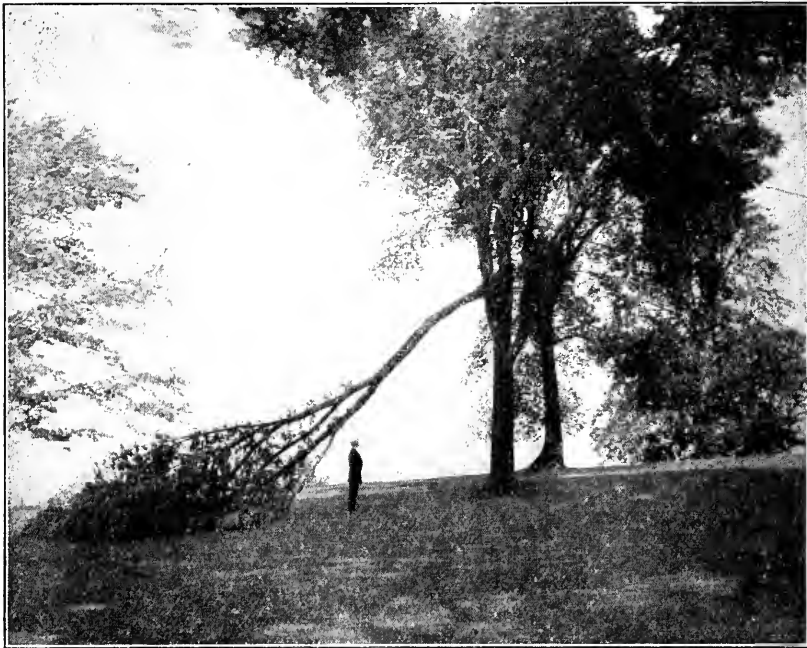

THE RESULT OF NEGLECT

Weak, Unsupported Crotches Are Dangerous. Loss of Branch Destroys Symmetry and Beauty of Tree

eloquent testimony to its effectiveness. How striking, then, is the analogy between this method of treating a cavity and the modern system of dentistry; both are based on the same three principles; the decayed matter must be entirely removed; the cavity must be prepared in such a manner that the filling will stay permanently in place; and moisture and all foreign substances must be absolutely excluded. This method is a striking improvement over the antiquated system of merely cleaning out a cavity superficially, and tacking over the outside a piece of tin,

on the supposition that the growth of a tree was on the inside, and that in consequence the cement would eventually be forced out. But as a matter of fact there is absolutely no growth on the inside of a tree, which acts as a physical support. The entire growth takes place immediately under the bark, and if the filling is properly put in, so that it is entirely inside the growing tissues, the bark will heal completely over it, eventually encasing it within the body of the tree.

Another very common trouble which the tree surgeon meets in his work is

the splitting crotch, which to his skilled eye often presents a serious danger which the casual observer would never suspect. It is perfectly natural for the weak crotch to exist in some trees; the varieties most subject to this weakness are the elm, the soft maples, the linden, and the beech. It is sometimes found in other varieties, but more seldom. It may be caused by cutting back the leader and forcing out the two lateral buds when the tree is young. Its

heavy winds and the consequent admission of more water. All this while the tree continues to heal on the outside, making the pouch more extensive. The operation continues until one of the branches becomes too heavy to be longer supported, and is torn off in a windstorm. The method devised by Mr. Davey for the treatment of such cases is most effective. It consists of the chain and lag-hook, with the addition, in serious cases, of a double-



THE CHAIN AND LAG-HOOK SYSTEM

Weak Crotches Made Secure. Maple on Estate of George Lauder, Jr., Greenwich, Conn.

treatment is complicated, and demands the utmost care, especially in the advanced stages. When the limbs have attained a sufficient size and weight, the swaying in the wind causes a slight splitting between the diverging branches. Water is thus admitted and starts the process of decay. Although the tree seeks to protect itself by healing over the outside of the crack, it merely forms a pouch for the water, and the decay continues with increasing rapidity, because the tree becomes weaker by the repeated splitting in the

headed bolt between the branches, and bolts through the sides of the water-pouch. The chains and lag-hooks are used in many cases for their preventive value. It is invariably the rule where trees of this kind are treated, to tap the pouch between the limbs, and preserve an opening by means of one or more drain-tubes. The split itself is caulked in such a manner that the bark will heal over it; however, it is sometimes necessary when the split is very bad to excavate as with other cavities and fill in the same manner, although

this is an extremely critical undertaking.

The roots of the tree must receive careful consideration. The general health of the tree will also indicate the health of the roots. It is too often true that in carrying out landscape designs the roots are cut off, and the tree left high and dry. The death of the tree, or at least of part of it, is under these conditions inevitable. Or it may be that the roots have been buried; which is just as sure to cause the destruction of the tree. It is absolutely necessary that the roots of the tree receive air and water and nourishment, as it is for the human body. It may be that the tree has become sod-bound, which produces the same result. In order to take care of these conditions, the proper method is the digging of a circular trench out under the edge of the branches, making it as the occasion may require, from three to six feet deep by about two wide. In this trench tile is placed for the purpose of aeration and watering. The trench is then filled with a mixture of good, nourishing tree food. In this manner it is often possible to save both the sod and the tree.

The question of insect pests and general diseases, including fungus growths, has been so thoroughly discussed by all the government and state authorities that it is hardly necessary to do more than mention it in passing. However, it is of the utmost importance to give these matters consistent and careful attention, especially as regards spraying.

The evil effects of electricity are noticed only at infrequent intervals. But the escape of gas in the soil is most deadly. Its presence for any considerable period means certain death for the tree, and the only possible way to remedy the trouble is to stop the leak, remove all the poisoned soil, and replace it with good rich earth.

Vines in most cases, after they have attained to any size, are detrimental to

the health of the trees, and the skilled tree surgeon will almost invariably recommend that they be destroyed, unless the tree itself has gone too far to be saved. In many cases the top of the tree is altogether too thick, and must be thinned out to produce the best results. This is especially true in the case of fruit trees. Interfering branches must be removed or else bolted together so that they cannot rub, as the chafing of the branches invariably destroys the bark, and decay is the result. Trees are often planted too close together, and this results either in the stunting of the weaker ones, or a lack of symmetry in all.

In all life, health is the normal condition. Nature designed us to be well, and the laws which govern life are simple. At the same time, she attaches severe penalties to their violation; and these penalties, unchecked, mean decline and death. It is just as true with the tree as with human life; to meet success, one must know the laws of nature, and act in harmony with them. Ignorance or disregard of these laws are evident wherever the unskilled hand touches a tree. Why should a tree die at fifty years, or a hundred years? It cannot be called old, when there are other trees of the same kind, ranging in age from 300 to a thousand years; and there are trees in existence which have reached 5,000 years or more. To the average man the life of a tree and the principles which govern it have been a sealed book; and we have permitted neglect and abuse to be heaped upon our trees which we could never be persuaded to tolerate in any other living thing. The need for the tree surgeon is apparent; the good which he is accomplishing is immeasurable; and the calling ranks in nobility with those other great sciences which have for their province the betterment of life in whatever form.



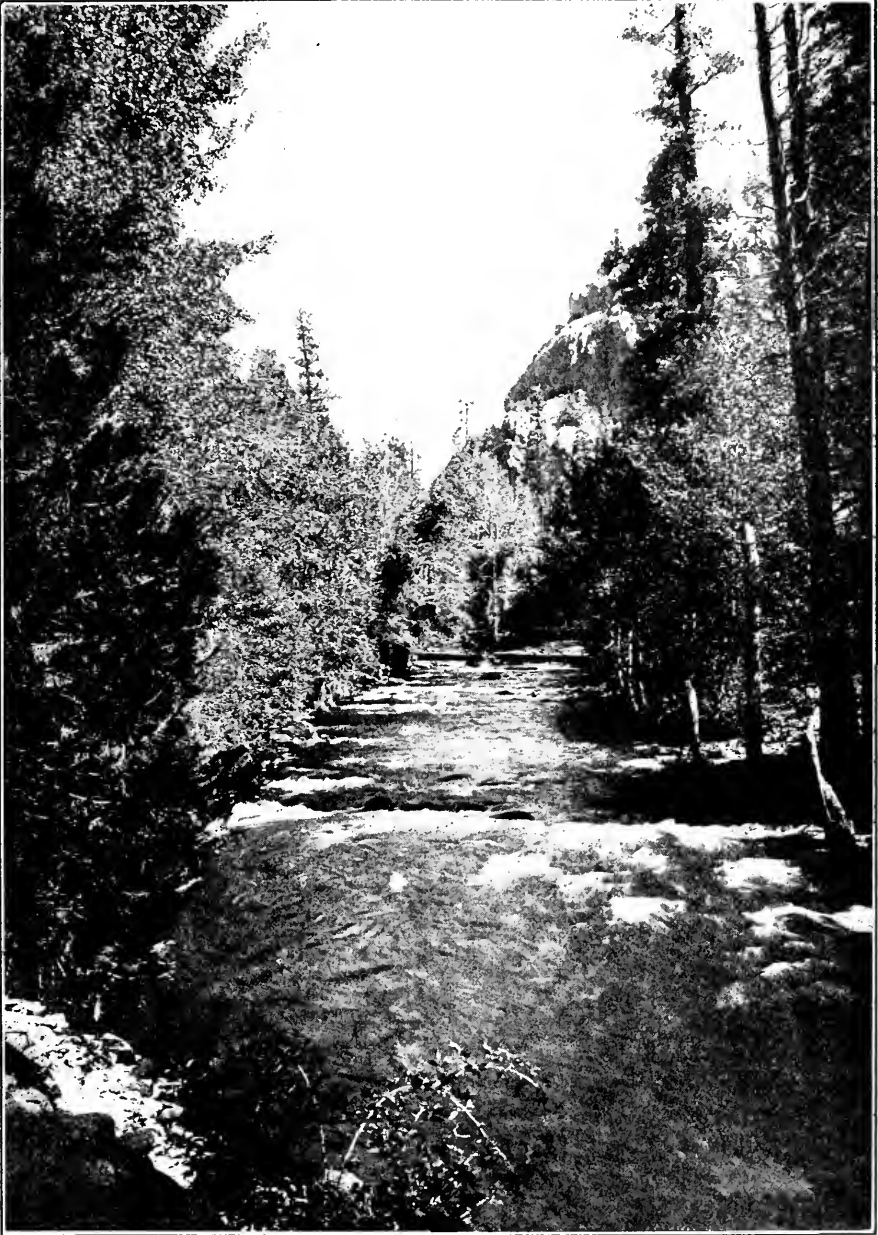

VIEW IN SIERRA NATIONAL FOREST

Kern River Canyon, about Four Miles below Little Kern Lake, and near the Mammoth Power Project of the Edison Electric Company

/ / / /

A BEGINNER IN FORESTRY

BY ANNE WARNER

(Book Rights Reserved)

Paper 1

I AM very ignorant, but I am going to learn. There is always something interesting in the ignorance of those who intend to grow wise. Those already wise are interested because they are conscious how much is to be learned; and those equally ignorant like to observe the struggles of their fellow in evolution. Therefore, I am going to write out the steps—the first steps—of my own personal progression. Perhaps it will amuse the ones who know it all anyway, but it is not for them that I shall trouble to write; it is for the others—the others who know no more than I do myself (at present). I shall write for them in the hope that they, too, may be led to learn.

In the first place, then, I must begin by telling where I am to go to school. Lichtenberg is the place, and it is paradise. When I came abroad to look for a place in the country, yet near a town, where everything should be pure country, except that there must be all the comforts of town, where I could have plenty of rooms and yet not be charged over three shillings a day, and

where there must be a forest handy—well, no one thought that I could find it. I hunted from Berlin to Munich, and even farther, cross-country, and I found it—as I never doubt that I shall find anything if I set out to look for it.

The Gasthof lies in the edge of the Harz; the view from my windows is over a sea of cultivated fields, dotted with fifteen picturesque little villages; the comforts are all here, the beer is ideal, my stove is equally good, and the forest is so close that when we cross the road behind the house we enter it at once. "We" are "She" and I. "She" is a wood-fairy and all the teacher that I have so far. The forester is in Thuringia for a fortnight—when he comes home he will teach me gladly. Until then I have a German lexicon, and as it doesn't give pictures of the leaves, and does give all the names in Latin, it is very little good to me.

You are to understand that I am well grounded in the theories and ideals of the subject. I know all its bearings on history, commerce, and progress. I have learned by heart all the deficiencies of bad management and just what

is bound to occur if we don't stop and think. I know all this quite well. But it is of the forest out there on the other side of the road that I am ignorant. I spend hours in it daily, and we strive like two untrained deaf mutes to make out something of one another's meaning, but I cannot understand.

Why, in the middle of the mile of mixed trees, do we find a whole hill-side of pines? Is it true that the moss under the pines is different from the moss under the mixed trees, or do we only fancy so, or is it only accident? Is there a rotation in crops with trees, or why, when there is not one oak in the forest, did they plant the whole last clearing to oaks?

The roads are splendid in every direction; they are of broken rock, with sand and gravel crushed in with a road-roller. The underbrush is all cleared out, and the carpet of dead leaves is only broken by patches of moss. The prettiest mushrooms grow everywhere; some are exactly like edelweiss, and some are pink. There are pink-shelled snails, too, and great red snails without shells. The fairy very justly observes that when one goes barefoot she notices snails and mushrooms much more than when wearing shoes. What I notice more than anything else is the unspeakable order of it all; not a dead tree, not a broken branch—all is so quiet, so still, so clean.

For miles along these hills it is all

“planted wood,” as the Germans say, and all is in the same order. And yet one rarely sees a workman. Deer, yes, and rabbits often, but hardly ever a man. Perhaps in August there is no need to give the trees attention—that is another thing that I must learn.

There is one very interesting tree among them all. In the midst of the forest, on the crown of the ridge stands a ruined castle where Barbarossa and all the rest have often come and gone. Mausfield besieged it and took it and wrecked it, and on the mounds of its ruin very large trees have grown and been cut down. But the strangest tree of all lies across the way from the old entrance. I thought at first that it was a mound with trees growing upon it, but the fairy pointed out to me that the mound itself was a tree, vast and hollow. Around the top of the hollow the old shell bunches, as if to cover some sort of ancient scars, and out of each bunch springs a thriving tree, six to ten inches in diameter, which seems in some odd way to serve itself through the medium of the roots of the old stump. It is so odd. One sees willows do something like this, but this tree is not a willow. I don't know what it is.

Oh, I have much to learn. Even this huge old tree must have its lesson when I can read it. I want so much to learn. I sympathize as I never did before with Alfred the Great. And *he* learned.

(To be continued)

OUR WANING COAL SUPPLY

By GEN. A. WARNER

EVERY man of intelligence and any scientific knowledge must agree with the President in the supreme importance of preserving our natural resources; and this importance was last spring emphasized by perhaps the most celebrated gathering ever assembled at the White House. It seems to be conceded that first in importance of our natural resources to be preserved are our forests. It is, however, to the extent and rapid exhaustion of our coal fields that the writer wishes especially to direct attention. Many years of the earlier life of the writer were spent in geological examinations in the Appalachian coal fields, from northern Pennsylvania through West Virginia, Ohio, Kentucky, Tennessee, and Alabama, following the line of the earlier investigations of H. D. Rogers in Pennsylvania and William B. Rogers in Virginia. The great reports of these two early geologists have been the foundation of all later surveys. Later the writer became interested in different sections of this greatest of coal fields, by extensive drillings and shaft openings, and early came to the conclusion that the number and extent of the workable beds of coal in nearly the whole of the Appalachian field had been greatly over-estimated.

Later examinations by eminent geologists confirm this view. Prof. I. C. White, state geologist of West Virginia, in his excellent report on the coal deposits of that state, cuts down previous estimates of the area of workable coal from 15,000 square miles to possibly less than 10,000, and limits the area of the greatest and most valuable beds of coal perhaps in the United States, namely, the great Pocahontas and New River beds, to 600 to 700

square miles. Again, the extensive drillings that have been made in recent years show that in reality the valuable coal beds throughout the most of the Appalachian field are actually contained within a marginal belt from twenty to thirty miles wide on the eastern and western sides of the field in the states of Kentucky, West Virginia, Ohio, and the western side of Pennsylvania, a large elliptical area within these limits containing no workable seams of coal. The western side of the field in Pennsylvania embraces the Monongahela and Conemaugh series, and contains, in the Laurel Hill and Chestnut Ridge synclinals, perhaps an exception to this structural limitation of workable coals. But it is nevertheless estimated that the soft coking coals contained in these synclinals, and westward in the Pittsburgh seam, will be practically exhausted in twenty-five to thirty years; certainly in less than fifty years at the present rate of consumption.

If the Appalachian basin is viewed longitudinally any geological map will show that it narrows down as it extends into Tennessee and Alabama, and in Tennessee is divided by an anticlinal ridge formed by an uplift of lower limestones, which divides the coal area into two or more basins and limits the area of coal.

The question of the thickness of the coal measures and the number of workable beds is of the greatest importance. If a vertical section could be made that would expose to view the thickness of each of the five great divisions agreed upon by the later geologists—the Dunkard on top, the Monongahela, carrying the great Pittsburgh seam, the Conemaugh, the Allegheny, and the Pottsville, down to the floor of the whole

basin, it would be easier to see how the coal measures are divided vertically as well as longitudinally. In such an exposure it would be seen that only the lower beds, or those contained in the Allegheny and Pottsville divisions, extend into Tennessee and Alabama; it would also show that but few coal beds extend evenly over wide areas, an exception being the great Pittsburg seam. It would also show that good seams of coal are seldom found side by side, or layer upon layer in the same section. But let us come to the main problem. How long will it take to exhaust the several parts of these fields? Beginning with Alabama: At the rapid rate at which the coal in this valuable field is being mined, there cannot be much left in forty years, and yet a senseless clamor is made to have certain rivers improved so that this coal can be shipped out of the country! Considering the relation of this coal to iron ore that will last probably 150 to 200 years, and perhaps longer (as one is known to extend all through the Clinton formation) the shipment of any of the coal out of this field ought to be prohibited by law. Tennessee has less coal in quantity; but being for the most part of good quality, it is being rapidly mined by the Tennessee Coal and Iron Company for its own use, and by numerous other companies for the general market, and twenty-five to thirty-five years will see but little left, and long before that time the price will have advanced to the monopolistic limit.

It is then, to the coals found in the upper series in Kentucky, West Virginia, eastern Ohio, and Pennsylvania that we must look for our supply in the later years of the century. But when we see how rapidly certain of these coals—the Pittsburg, the upper Freeport, equivalent to the Cambridge of Ohio, and what is left in veins in the Pottsville series in Ohio and Pennsylvania—are going now by lake and rail to supply the demand in the North and Northwest, it really becomes an alarming problem to determine what even the next generation will do for fuel.

The coals of Indiana and Illinois are all needed in the Middle West, and will be mined out to supply these markets before the century is half out.

But let us turn again for a moment to the 600 to 700 square miles of the Pocahontas and New River beds and see what is going on in this, the most valuable part of the Appalachian field, and, all told, perhaps more valuable than any other, even than the anthracite field. Already this coal is being shipped as fast as trains can carry it to different parts of the country, and to the Atlantic coast, to supply, not only our own navy, but the navies of other countries, and to supply the markets of the world. And now new railroads are being hurried into the field to compete for this traffic. How long will the field last under these conditions? One item will shed light on this question. The large steamships that now ply the ocean use approximately 100 tons of coal an hour, or over 2,000 tons a day, or 10,000 tons in crossing the ocean. An acre of coal will afford on an average 1,000 tons for every foot in thickness, or 4,000 tons for a vein four feet thick, which is rather over than under the average thickness in the New River field. The rest is a matter of computation. Why, then, should there be such a rush to get this most valuable coal out of the United States?

Turning to the anthracite field, it is well known that at the present rate of exhaustion, there will be little of this field left in fifty years, and long before that time the price will almost certainly be whatever the owners of the field agree on. What will Philadelphia New York, all New England, all the eastern part of the country, then, do for fuel? They cannot hope for relief from the Appalachian field, for there will be little left to draw on from there. And yet to so momentous a question, 999 persons out of a thousand will answer: "That is as long as I shall live." In the language of Puck, "What fools these mortals be."

I do not touch upon the great fields in Wyoming and other mountain states, as these fields have not yet been thoroughly surveyed, and these coals can hardly come to eastern markets.

There is another most important phase of the coal question that has heretofore received all too little attention, and that is the reckless and wasteful way mining in all fields is carried on. Under present methods only from two-

thirds to three-fourths of the coal is taken out. The rest is left in the mines as pillars, or otherwise. From twenty to forty cents a ton more, while the field is being worked, would save practically all the coal. But for manifest reasons this cannot be done in one field alone. Legislation is required to stop this waste of a substance without which man cannot live. And the legislation must come from many states at the same time, or from the United States.

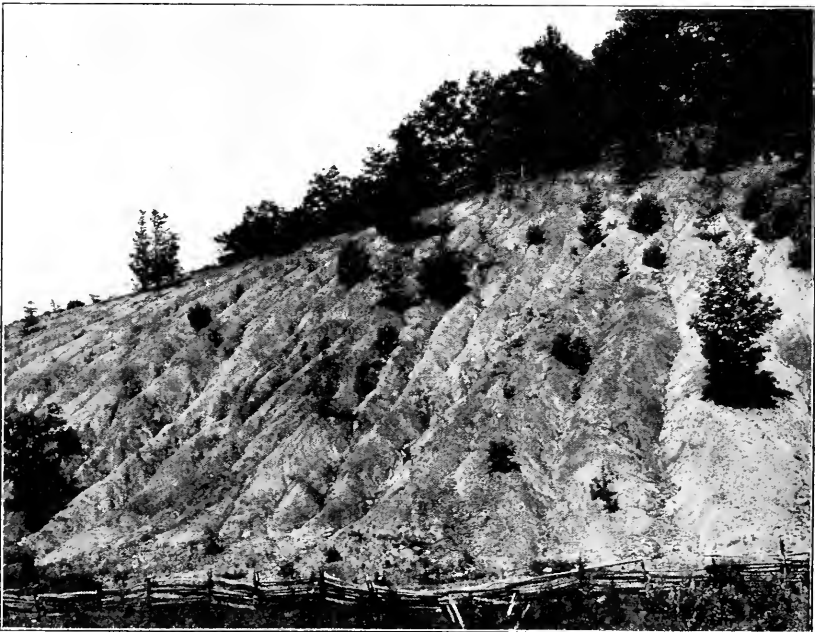

THE EFFECTS OF EROSION
Denuded and Washed-out Slope in Western North Carolina

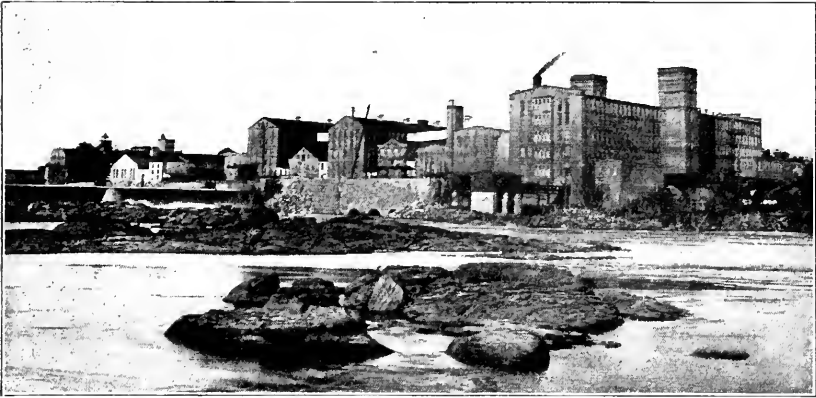

WATER-POWER DEVELOPMENT
Cotton Mills at Columbus, Ga., on the Chattahoochee River

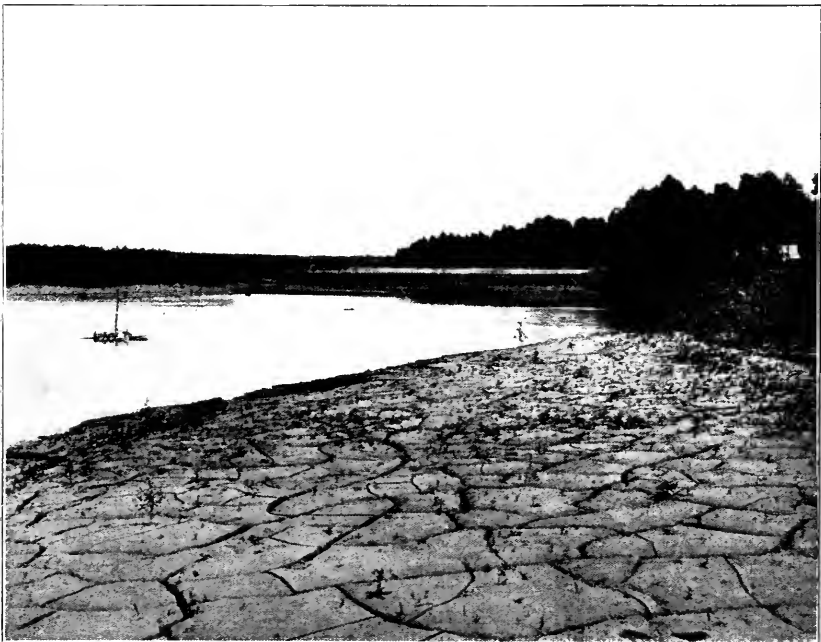

THE WASTE OF THE FIELDS
Silt Bar Deposited on the Banks of a Navigable Stream. Washed Down by Floods from the Fields, and Must Be Removed by Dredging. Mississippi River

APPALACHIAN NATIONAL FOREST ASSOCIATION

TWO important meetings have been held by the Association during September in the inauguration of its plan to obtain an active membership; one in Lynchburg, Va., on September 17, and in Richmond, Va., on the 22d inst., in both places before appreciative and earnest audiences. These meetings are deemed by us of great importance, because they are considered by us as demonstrating, not alone the interest of the people in the forest cause, but as proving the practicability of our plan for obtaining a membership made up of organized clubs, etc., already equipped for work as it were, and, therefore, capable of giving influential and aggressive aid to our campaign. They show that our plan for organizing a branch of our Association in each southern city is practical; they show that these branches can be better organized into a State Forest League; they show that the people are keenly alive to the vital questions which are involved, and most clearly of all show that the earnest and thoughtful man and woman, want to be put to work on some practical lines that will accomplish results.

The Lynchburg meeting was held under the joint auspices of the Lynchburg Board of Trade, Woman's Club, Retail Merchant's Association, and Civic League. It had been thoroughly advertised by the energetic and capable Secretary of the Board of Trade, Mr. J. A. Faulkner, and a representative audience assembled at the Y. M. C. A. Auditorium to greet Mr. Fred G. Plummer, of the Forest Service, and Mr. John H. Finney, Secretary of our Association. Mr. Long, a prominent Lynchburg attorney, presided most capably.

Mr. Plummer dealt with the work of the Forest Service and its administrative features, illustrated by beautiful lantern slides, it was a running comment on conditions and practices, and was most entertainingly presented and enthusiastically received. Mr. Finney dealt with the need for forest extension by the government, along the lines of a definite forest policy, urging of course, the acquisition of the Appalachian and White Mountain area, as of supreme importance, and then taking up the state work that must be done in cooperation with the government and with individual owners, told graphically the plans of the Association for furthering the work.

His address also covered the history of the fight for this Appalachian forest, and vigorously scored the politicians who have heretofore prevented action by Congress. At the conclusion of the speaking, the audience unanimously passed a resolution endorsing the work of the Association, pleading its cooperation, and the four organizations voted to join the Association in a body.

A particularly gratifying result was the gift by Mrs. Cora L. Mosby, of Lynchburg, of fifty acres of land as the beginning of the "Virginia State Forest."

From this gift, we feel, must come large results, for we are convinced that there must be other patriotic women and men in Virginia whose generosity and patriotism must get stimulus and inspiration from this gift to her state by a noble woman.

The Richmond meeting, held under the Chamber of Commerce in their assembly hall, was equally interesting and instructive.

Mr. Henry W. Wood the vice-president of the Chamber, presided, and eloquently presented the subjects and the speakers, Mr. F. G. Plummer, and Mr. John H. Finney. The subjects chosen by the speakers were the same as in Lynchburg, and were ably handled, to the enjoyment of the select audience present.

The papers had given much space to the meeting, and strong editorial comment made both before and after the lectures on the importance of the subject.

Among the audience, was Congressman John Lamb, a member of the Agricultural Committee of the House of Representatives, who briefly followed Mr. Finney in a speech which severely "roasted" Speaker Cannon, declaring that the movement for the acquisition of the Appalachians had been blocked by his committee appointments. "Uncle Joe did it," he declared, "but the time will come when he won't be there." Captain Lamb strongly endorsed the speeches of Mr. Plummer and Mr. Finney, reminding his hearers that the work was not only one for the present, but for the good of posterity.

Resolutions were unanimously adopted endorsing the Association and pledging to its aid the Chamber of Commerce, Business Men's Club, Woman's Club, the Civic Improvement League, and the Traveler's Protective Association.

The Association has planned similar meetings, probably handled by the same speakers, at Danville and Roanoke, Va. ;

Winston-Salem, Charlotte, Greensboro and other North Carolina points; Rome and Athens, Ga.; Montgomery, Ala., etc., and is almost daily in receipt of requests for speakers.

It is naturally a tremendous work, one that we feel we must continue; but it is work that must have, to be successful, the individual conscience of our membership. We feel that the influences which these meetings are enlisting and setting in motion are to result in large consequences—for the good of the whole Nation. We are beginning, as a people, to understand the need of the forests and the vital concern of the individual in their proper conservation. Such costly object-lessons as the recent floods in the South; the present costly forest fires in all sections of the country; the existing drought conditions in Pennsylvania and adjoining states, vividly portray the future of America without its forests, and tell the story, appalling though it be, more eloquently and more forcibly than any words of ours.

Once get the thinking man or woman educated to real conditions and to the necessity of work on his or her part, and the blind indifference of Congress and the opposition of the Speaker and his committees will be swept aside with a force which cannot be gainsaid, and the forests shall be saved.

We are, indeed, "pledged to the Forest Cause."

THE APPALACHIAN NATIONAL
FOREST ASSOCIATION.



EDITORIAL

The Business Side of Conservation

IT IS a fact not readily understandable that the preservation and conservation of our natural resources has not, heretofore, seemed to have any particular appeal to the mass of business men of the United States. In fact, it is true, and has been true for a great many years—ever since the inception of the conservation plan as applied to our forests, in particular—that college-bred men, scientists and the like, have waged the battles, while hard-headed, practical “men of affairs” have jeered and obstructed. Of course, this is not universally true; but as a general proposition it cannot be gainsaid. College professors, men of science—the class of men for whom your average “business man” has a hearty and ill-concealed contempt—have been the ones to tell the world what will be the inevitable result if a continuance in the course of reckless waste and extravagance as regards timber, etc., unless their warnings were heeded; the men who “dream,” as the hard-headed ones declare, have for years and years been telling these “practical men of affairs” to what they were coming, and to what they were bringing the land, by their “practical” exploitation of all of nature’s resources. It is a healthy symptom to see that these same practical men are beginning to realize that the dreamers dreamed true; and it augurs well for the cause of conservation in general to know that at last the business sense of the country has been awakened.



As a Money-saving Proposition

LOOKING at the matter solely from the practical side, the grossly material view-point, it seems strange that this awakening has been so long defer-

red. For instance, Pittsburg has for years been subjected to disastrous annual floods, during which the business section of the city, and Allegheny, have been laid waste and prostrated under sweeping torrents of water from the Ohio and the Monongahela and Allegheny rivers. At any time it would have been entirely practicable to do away with the flood visitations; at any time in the past quarter century it would have been an easy matter for the business element of Pittsburg to secure legislation looking toward the reforestation of the watersheds of these rivers; at any time in that period it would have been easy for this business element to pave the way for the inauguration of a policy of reservoir building, the damming of valleys and the storage of flood waters that have been wasted—worse than wasted, indeed, because of the millions of dollars of damage these waters have done. But no; the business element taking the fatalistic view-point, or the criminally careless one, did nothing; the denuded hillsides and mountainsides have remained largely as the ravaging lumberman left them; the waters have been permitted to pour unobstructed into the valleys and lay waste the towns, the villages, and the cities, and the damage done has been charged, probably, to profit and loss, or to “visitations of Providence.” Scripture says, “The wages of sin is death.” Carelessness, heedlessness, ignorance, is sin; and the wages of either of these is likewise death—death to the individual, or to the community, or to material well-being and prosperity.



Reforestation Good Business

FROM even the solely utilitarian, present-day view-point, a general policy of reforestation—together with a

rigidly adhered-to policy of forest conservation—is good, sound business. The reforestation of denuded slopes, mountainsides and watersheds is the only sure preventive of floods. Floods wash away, destroy, and lay waste, annually, property to the value of millions upon millions of dollars. If, therefore, even twenty-five per cent. of this waste can be prevented by reforestation, it would seem as if the “sound business sense” of a community would not hesitate a second to adopt such a policy. But there are other equally sound reasons for adopting such a policy—reasons sounder by far than those upon which rest the present industrial development of the country. Railroads require ties; mines have to be timbered; city building calls for lumber; farmers must have at least measurably fertile soil; and upon a prosperous, permanent and contented farming element rests the ultimate prosperity of any community or state. If the supply of railroad ties, let us say, in Pennsylvania, is approaching exhaustion, it becomes necessary for the roads to seek their ties farther away, and the same is true as regards the mines. The farther away the timber supply is, the more it must necessarily cost to secure it. Everybody who has built, in the past few years, knows how the price of lumber has increased. And, as regards the farmer and his “worn-out” farm, the reports of the immigration officers of the Canadian northwest make interesting reading. Hundreds and thousands of American farmers have, well within the last decade, moved across the border, leaving their “worn-out” farms for the virgin soils of Alberta, Manitōba, or British Columbia. Railroads and factories cannot easily follow the example of the farmers; but even factories may close down permanently, and railroads are no strangers to receiverships. With a permanently prosperous farming community a state will have prosperous factories and industrial concerns—the two go hand in hand; and with these, the railroads have plenty of business. Now, for the words “worn out,” as applied

to farms, write “washed away,” and you have it. Farms, the top soil of which has all been carried into the rivers and down to the sea, cannot produce crops, and so the farmers are compelled to go elsewhere. And with the going of the farmers—the extinguishment of a permanently prosperous agricultural population—goes the basic principle of industrial or any other prosperity. Protect the forests and you protect the farms; protect the farms and you retain the farmers; retain the farmers and you maintain the prosperity of the community—it is as simple and as obvious as that two and two make four.



A Permanent Timber Supply

AND not alone from this side can it be unanswerably argued that it is sound business sense to preserve the forests and to reforest the stripped slopes and watersheds of the land. Take the following illustration: A young man starts in life with \$10,000, invested so as to bring him six per cent. a year. Now, this young man cannot, or does not want to get along on \$600 annually, so he uses his income and, yearly, trenches upon his principal to the amount of an additional \$600. The second year he must draw still more heavily upon his capital; he cannot do with less than \$1,200 per year. And so, at a steadily increasing rate, his capital is wiped out, until, in a few years, he has neither income nor capital. Your “practical business man” would call this young man a fool, and he would be right. But this very thing is what the sensible business men of the country have been doing for a long time. Let the \$10,000 represent the original timber supply of, say, Pennsylvania; let the six per cent. represent the natural annual production, and let the \$1,200 stand for the annual consumption of timber. Or apply the illustration to the country at large. Now, instead of making steady, year by year inroads on the forests, it would have been as easy to provide for a perma-



WATER-POWER UTILIZATION

Plant of Columbus River Co., in Muscogee County, Georgia, on Chattahoochee River, which Heads in the Southern Appalachians

ment timber supply, by securing legislation that would prevent forest wastage, despoliation and the total stripping of timber from vast tracts. Instead of using the income—the natural reproduction—and a part of the capital—the original forest—each year, put the capital to work—take care of existing forests, and provide for new ones. If such a plan had been adopted in Pennsylvania fifty years ago, what would now have been the condition of the state? And what would, to-day, be the value of a permanent and adequate timber supply to the state? Mr. Practical Business Man, suppose you answer!

Water Transportation

NO THINKING man will deny that a comprehensive, well-developed system of water transportation would be wonderfully beneficial to the inland commerce of the United States. But to have a system of waterways, we must first have the water. There is plenty of water; but, under present conditions,

it comes too much in bunches. At one season we have raging, swirling yellow torrents, while at another we have sand bars, shallows, and silt reefs. How can this condition be modified? Simplest matter in the world. Five words will explain: forest and flood water reservoirs. Let us reforest the denuded hillsides, mountain tops and watersheds, so that the storm waters, the melting snows, and the spring rains will not carry down with them, in their mad rush the stones, gravel, sand, and silt, but will pass somewhat gradually down from the hills. Then let us dam the valleys at whose bottoms lie the feeders of the larger rivers; let us equip such dams with gates for regulating the flow of the water into the streams; let the reservoirs be of sufficient capacity to restrain any ordinary flood; and then let us so regulate the outflow of water from them as to maintain a navigable stage even in seasons of serious drought. We can then improve existing waterways, and plan and execute new ones, until the country is covered with a network of canals and streams made navigable by man; our



WATER-POWER ON A SOUTHERN RIVER

Typical Reservoir, Dunlap Dam of the North Georgia Power Co., on the Chattahoochee River at Gainesville, Ga.

railroads can be reserved for the transportation of perishable freights and passengers, our coal supplies can be conserved—and the freight rates on heavy merchandise can be materially lowered. If the application of this idea to the state of Pennsylvania alone, and to the Ohio River only from Pittsburg to Louisville, cost a hundred millions of dollars, it would still be well worth doing, and would still pay good returns on the investment.



Water-power and Waterway Extension

IT IS also beyond doubt—a very easily demonstrable fact—that the sale of water-power created by reservoirs such as are spoken of here would be a source of large income to the state. It is, in fact, easily conceivable that the returns from such sales would provide funds for the maintenance of the entire system. It is not easy for the untechnical mind to grasp the immensity of this phase of the matter, or to con-

ceive of the tremendous income—both in sale of power and in saving of coal consumption—that could readily be secured. Of course, long-distance transmission of electrical power is still a wasteful process; but with industrial concerns so thickly centered as they are in Pennsylvania—still using that state as an example—no serious obstacle would have to be overcome from that cause. It is no great matter to conduct electrical power two, or twenty, or fifty miles; it can be done commercially at a good profit. Much more so then, can it be done when the distance of transmission is only a very few miles, or nothing at all. If Pennsylvania will undertake the construction of a system of storm-water reservoirs and all-the-year-round waterways, and carry the plan through to completion and utilization, she will do these things: She will insure a permanent timber supply for the state; she will insure a permanently prosperous rural community and, therefore, the same sort of business community; she will put her coal supply in a position where it need never

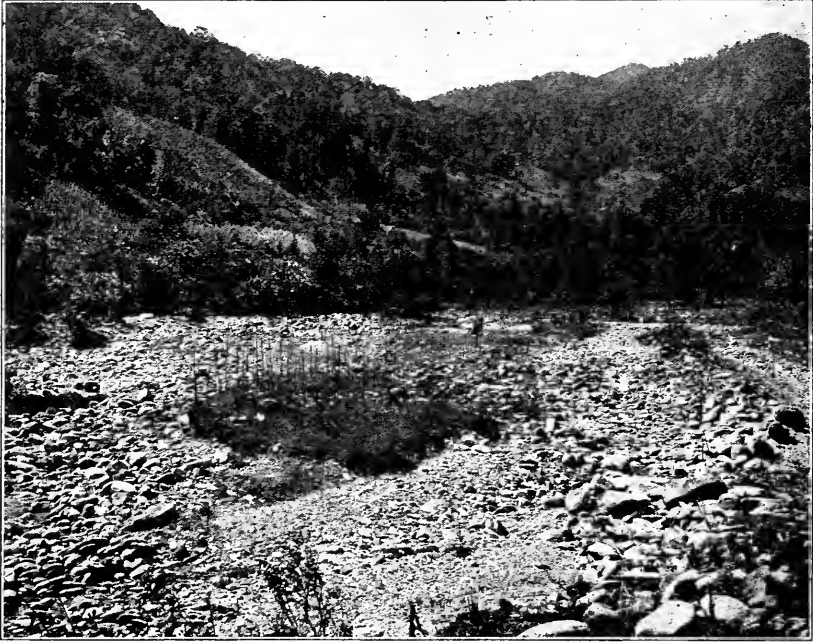

THE DESTRUCTION OF FARMING LANDS

Alluvial Bottom, Ruined by Flooding. Soil Gone, Nothing Left but Gravel and Stones. Land Worthless
Swain County, North Carolina

again be worried about; she will prevent the annual loss by floods of millions of dollars of real property and hundreds of lives; and she will do it all at no actual cost to herself—the income from the investment will pay the upkeep and leave a handsome balance of profit. If the hard-headed business men of Pittsburg would turn their attention in this direction, instead of toward the formation of billion-dollar trusts and the upbringing of sons to make a laughing-stock of Pittsburg and America in general, or to fill Mattoon and similar places, it would be a better argument for their business sense.

Louisiana's Proposed Forest Law

FROM recent expressions in the Southern press it appears that an erroneous impression exists in regard to the proposed forest law now pending in the Louisiana legislature. Different newspapers and periodicals in the South

have interpreted the provisions of the bill to mean that no timber whatever under twelve inches in diameter at four feet above the ground is to be cut under any conditions. If this was the intention of the bill, it would be well if it were defeated, as no such provision would be either just or practical. But this is not the intention of the measure, and the publications which have so construed it have fallen into error.

By the terms of the proposed statute the cutting of trees under twelve inches in diameter, four feet from the ground, is forbidden, it is true but only under certain conditions. The provisions of the bill do not apply to those who in good faith wish to clear the land for agricultural purposes, those who need the timber on the ground for roads, ditches, or construction purposes, or those who intend to use the wood for domestic purposes. Furthermore, lumbermen will be required to fell trees in such a way as to cause the least damage to young timber, and the refuse from lumber operations must not be



AN "ABANDONED" FARM

Deeply Eroded Gullies on a Slope Formerly Cultivated. Slowly Growing Up to White Pine

left where its presence will invite fires or in any other way endanger young trees. The law provides likewise for thinning timber stands so as to promote forest growth and prevent overcrowding and deadening, but such thinning is to be conducted under strict regulations and is not to be taken as an excuse for violating the spirit of the law. The penalty for violations of the proposed law is a fine of twenty-five to one hundred dollars for each offense, to which may be added imprisonment; and each tree cut in violation of the law is made to constitute a separate offense.

The proposed law not only defines and delimits offenses and names penalties, but also sets forth the reasons why the law is thought advisable. Timber is becoming scarce, it says, and ought not to be needlessly wasted. Forest destruction will carry with it other evils beside a dearth of wood. It will cause destruction, soil erosion, and increase floods and drought to the damage of the whole people. Furthermore, the forests should not be wholly cut

down, because they assist in obstructing the progress of disastrous tornadoes.

A recent ruling of the Supreme Court of Maine declares that that state may lawfully restrict the clearing of privately owned forest land, if it is shown that the general public would be endangered by such clearing. While following the lines of the opinion rendered by the Maine Supreme Court, Louisiana's proposed law goes still further in the same direction. It is worthy of note that the two states which have been first to take so advanced a stand in the matter of forest protection are 1,500 miles apart, and their forests are not at all alike in character. They have different soils, climates with few points in common, crops of wholly different kinds, geography and topography of opposite extremes; yet to each of these states has come a full realization of the immense importance of the forests and how absolutely essential their protection is to the continued prosperity of the people.



WATER-POWER UTILIZATION

Dam and Power House of North Georgia Power Co., on the Chattahoochie River, Georgia

National Forests in the East

THERE is a perceptible drift of sentiment in the East at the present time in favor of the establishment of the Southern Appalachian and White Mountain National Forests at the earliest practical moment; and it appears probable that by the time Congress convenes in December this sentiment will have crystallized to such an extent as to make it possible to secure favorable action by both branches of the national legislature. Publications that in the past have been either opposed to the establishment of the two forests mentioned, or very lukewarm in support of the proposition, are almost daily becoming more favorable; while the trend in the case of individuals is still more pronounced. The educational work that has been done by the American Forestry Association, the new Appalachian National Forest Association, various commercial clubs, and similar organizations, and the large body of the press that has for years steadily supported the idea of national forests for the East, is bearing good fruit, and there is

every reason to hope that at the coming Congressional session crowded as it is sure to be with other work, there will still be found time for favorable action in this vitally important direction.

It would appear as if the developments of the present campaign have aided materially in bringing members of Congress to a realization of the public stand on this eastern forest question. All through the campaign voters in various parts of the East have been demonstrating in unmistakable fashion their approval of the proposal for the government to acquire, by purchase or otherwise, the tracts embraced within the boundaries of the two proposed forests; and not even the distractions of a national campaign have been sufficient to draw attention from this subject. Representatives and senators alike have come to a pretty full realization of the fact that the people generally in the regions affected desire above all things the establishment of the Southern Appalachian and White Mountain National Forests, and it is believed by many who are competent to judge from surface indications that the opposition to

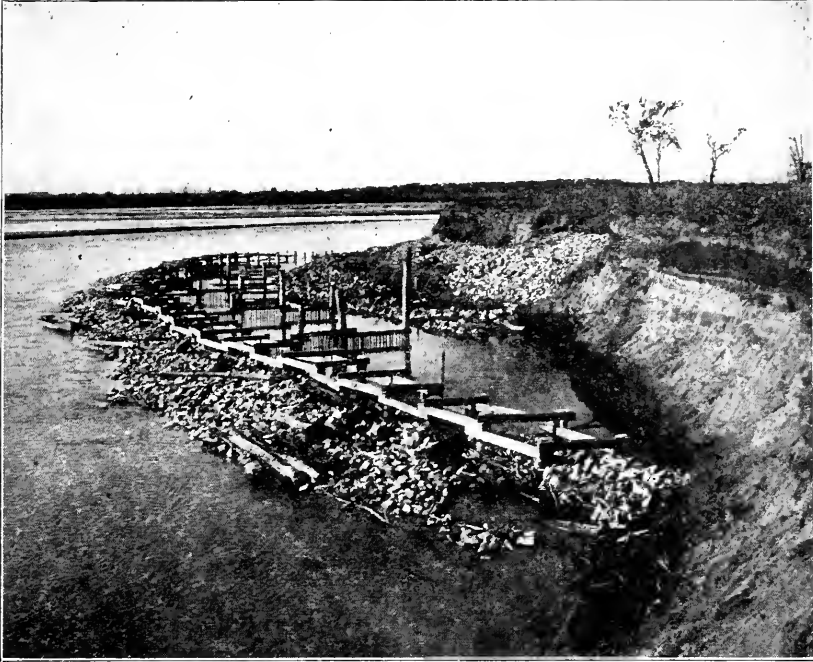

GUARDING AGAINST EROSION

"Rip-rap" and Framework on Mississippi River. Protecting Bank from Washing and Caving Away

the establishment of the forests will be powerless to prevent favorable action at the next session.

Business Men Should Take Part

IN ORDER to make doubly sure of such favorable action, however, it is necessary that business men and business organizations, such as commercial clubs, etc., should take a positive stand and voice their opinions in decided language. So far as we know, no commercial organization in the East has as yet opposed the establishment of these two national forests; but there has in many instances been a lack of positive approbation and decided utterance on the part of such organizations. If the business bodies and the business men of the sections affected will between now and November 3 take a determined and decided stand in favor of immediate enactment of measures that will provide for the establishment of the

two forests, and will take the trouble to let their opinions be known and fully understood by their representatives, or by candidates who are to be voted for on November 3, it seems certain that the establishment of the forests will be provided for. It will not do however, to relax effort; a continued program of educational work and uninterrupted demand for the enactment of such a law is vitally necessary, and this program should not be discontinued with the election. It should go right on, following the general election, until Congress convenes, and should be continued by able and tactful representation during the sessions of Congress and until the bills for such establishment have finally passed both houses.

The Forest Holocaust

THE long season of rainless weather, the tinder-like condition of woods and fields, which affects prac-



WHY THE FARMS GROW POOR

Bed of Silt Washed Down from the Fields by Floods, and Deposited on River Bank, to be Removed by Dredging

tically the entire country, has brought its inevitable concomitant, a series of forest fires unparalleled in their destructiveness. Stretching across the continent from Minnesota to Maine, and reaching down the Atlantic seaboard as far as New Jersey; crowning the hills and peaks of the Adirondacks and the Catskills with smoke wreaths and coronets of flame; ravaging the little remaining pine timber of Wisconsin and Michigan, and searing the hills and valleys of Pennsylvania, the fires have swept on their way, until a record has been set for the summer of 1908 that for wide-spread destructiveness has, perhaps, never been exceeded.

Estimates by men high in authority in the Forest Service, and by equally distinguished authorities in other branches of the government—these estimates compiled from painstaking reports made by agents right on the spot—for the week of September 21 and the preceding week, placed the damage caused by these fires at \$1,000,000 per day. A million a day going up in the smoke from our burning forests! If

this amount of destruction was wrought by flames in any city in the land, the newspapers of the whole country would herald the fact under double-column headings! But in the case of the forest fires the newspapers print the story as a routine item of news; if the fires continue, as they have continued throughout this season, the news becomes more and more unimportant with each day, the items grow smaller and appear on inside pages, until finally the news is not considered worthy of publication at all. But the destruction continues; each day a million dollars worth of forests from our already rapidly diminished timber resources go up in smoke; and each day the whole nation—every man woman, and child in the United States—is further impoverished!

In the two weeks ending September 22, half a score or more of towns and villages were totally destroyed by flames from the burning forests! Towns in Minnesota; towns in northern Michigan; towns in Wisconsin; towns in Maine; in the Adirondacks, and in



FIGHTING A FOREST FIRE

Running a Fire Line around a Dangerous Blaze on a Montana National Forest

Pennsylvania and New Jersey, have either been destroyed or so seriously threatened that the inhabitants fled for their lives.

These fires east of the Mississippi River have raged almost unchecked for weeks. Drought conditions existing over the entire country have helped the progress of the flames; while the unorganized, unsystematic, and somewhat aimless efforts to extinguish the fires have been well-nigh fruitless. The lack of precaution in preventing fires getting out; the inability to apprehend, and the disinclination to prosecute offenders against public safety, have helped to increase the destruction of the woods.

Conditions are different in the West, and particularly in the government forests. Fires have broken out during the past summer in national forests from the Canadian line to Arizona; from Colorado to California. In one of the western national forests the supervisor reported a short time ago that at one time fourteen fires were burning. Another supervisor reported twelve fires at one time in the forest under his charge. Fire fighting is a part of the business out there, however, and none of these fires attained any

really serious proportions or did any great amount of damage. In most cases the fires were extinguished within twenty-four hours after they were discovered; while in no case reported were the fires burning longer than forty-eight hours after they started. Forest guards, rangers, and other national forest officers make the fighting of fires a part of their regular employment during the summer months. Fire patrols are constantly on the alert to discover blazes just starting, while conspicuous notices are posted all over national forests warning against the danger of fire and setting forth the Forest Service rules in the premises. Out there, when a fire starts it is speedily extinguished with the minimum of damage; east of the Mississippi River, where there are no national forests, the fires rage practically unchecked for weeks, destroying timber and other property at the rate of \$1,000,000 per day! If there were no argument but this in favor of the speedy establishment of the Appalachian and White Mountain national forests, under Forest Service administration, it would seem to the casual observer that those forests should be established at once, and not only those forests but others in the Adirondacks,

the Catskills, the White Mountains, in Maine, in the forested mountain regions of Pennsylvania, and every other eastern state.

Obstructionists Retired

THE fact that several of the house and senate "undesirables" have been retired to private life during the past summer is surely indicative of an aroused and healthy public sentiment. Jenkins, of Wisconsin; Ankeny, of

clearly in sight. Speaker Cannon himself is having the fight of his life in the Danville, Ill., district, and there is a good chance that the Speaker may be forced to remain at home at the close of his present term of office. Reports from Illinois indicate that the Speaker of the House has his back to the wall, and it is certain that he has this summer been forced into the hardest fight of his political career. It was hoped by campaign managers that Mr. Cannon would be able to give some of his time to the National Campaign Committee, and that he would be in a position to make speeches at many points in the East and Middle West; but the fight waged against him by the decent element of his district and the state of Illinois at large, that fight being led by the authorities of the Methodist Church, has kept the Speaker close at home, mending his own fences, instead of allowing him to lend his aid in the National campaign. Recent reports of Mr. Cannon's utterances in the conduct of his present campaign, quote

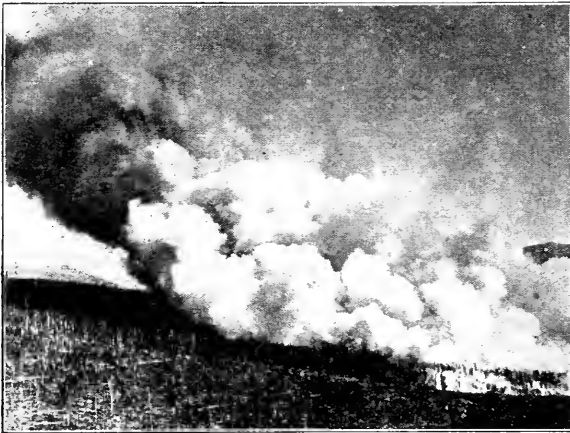

Forest Fire in Colorado

Washington; Long, of Kansas, and others have met with the down-turned thumbs in the political arena, and will be in a position to obstruct necessary and publicly-demanded reforms but a short time only. A reorganization of the House Judiciary Committee—that graveyard of legislation—is made necessary by the retirement of Representative Jenkins; and it is not at all unlikely that still other retirements will occur at the coming election. Voters all over the country have this summer demonstrated a marked ability to think, and with the coming of a thinking electorate the political extinguishment of men like those mentioned above is

him as resorting to his characteristic billingsgate and abusive profanity, and it is more than intimated that this course has alienated many voters who otherwise would have supported him. If the report is true, it is an unmistakable indication of the fact that Mr. Cannon realizes the seriousness of the fight in which he is engaged, and that he is, to use a slang expression, "on the run." It is to be hoped that those who are actively opposing him will keep him in that condition from now until the conclusion of the campaign. It would indeed be an augur of great things for the nation if Mr. Cannon's constituents were to keep him at Danville from now on.



COMMUNICATIONS

Varying Views

ILLUSTRATING the varying views entertained by individuals and corporations in regard to the question of forest conservation, etc., the accompanying letters recently received are interesting. They were written in reply to letters soliciting memberships in the American Forestry Association:

Little Rock, Ark.

Gentlemen: Yours asking me to contribute a certain amount of money for the preservation of the forests, etc., at hand. In response will say it seems to me that the large concerns that are depleting the forests and are receiving large revenues from the same should be the ones to meet this expense. In other words, millions of dollars have been made in this manner by wealthy concerns, and they are the ones who should be burdened with the taxation."

Respectfully yours,

Watertown, N. Y.

Gentlemen: I am in receipt of your circular letter. Our concern is very much interested in forestry and in forest reproduction, but in the face of all the agitation now going on and the very strenuous efforts being made by the American Publishers' Association to force through Congress the immediate removal of the tariff on paper and pulp without any investigation or hearing granted the paper manufacturers, we do not care to invest in forestry or anything else pertaining to paper manufacture.

Should the tariff on paper and pulp be removed we will be forced to cut off our own forests, without any regard to forest reproduction or anything else—cut off every stick that can possibly be used in making pulp and paper. After having exhausted our own forest, if we continue the manufacture of paper, we must move to Canada.

Until this tariff question is settled we do not care to consider anything in the way of forestry. If the tariff is removed we propose absolutely to denude every acre of forest we own.

Yours very truly,

In neither case does it seem advisable to use the name of the writer; but the expressions, we believe, will be interesting to our readers.

Unfortunately, there are too many concerns—as well as individuals—who hold the same opinions as those expressed in the second of these letters. On the other hand, there are similar concerns who take a different stand. Another big paper company takes the view that the best way in which to utilize forest properties is to cut timber according to forestry rules and regulations. In consequence, it is maintaining and will maintain a permanently valuable property, which will yield a steady income. This is in accordance with German experience. To our correspondents we would say, read the Forest Service Bulletin on "What Forestry Means;" also read another Forest Service publication, "Experience of the German Government." Both will prove enlightening.

Land Scheme

MR. PERCY P. VYLE writes from Gainesville, Fla.: "The question of wood is becoming a serious problem in the phosphate region. One of the phosphate companies has had the Forest Service examine a vast area of their cut-over land, which may be considered feasible for reforestation. Between the turpentine, lumber and phosphate industries, the forests of Florida are rapidly disappearing. When these industries get through with the

land, above and below, it will be truly deserted by God and man—even the buzzards will skim over the sun-baked, man-upheaved land for fairer hunting.”

Sweeping Winds

MR. JOHN A. STOUGHTON, of Hartford, Conn., writes us:

“Only this morning a man living near Hartford casually remarked about

the changed conditions in his vicinity, owing to the cutting off of a belt of woodland near his home, allowing the winds to sweep in parching blasts over the fields, which had previously been protected. To me it appears wise to stimulate every landowner to cultivate forests, even in a small way; for the aggregate average in a few years would be immense and of incalculable value both from a climatic and pecuniary point of view.”

FIRE FIGHTING ON A NATIONAL FOREST

Extending a Fire Line so as to Cut Off the Progress of the Flames. Systematic Work Makes It Possible to Handle Fires in an Expeditious Manner



NEWS AND NOTES

A Season of Droughts

FROM the Middle West, the West, and Northwest come reports of long-continued and damaging droughts—a peculiar condition, it would seem, to those who only a few weeks ago read of the destructive floods that raged in the south and southeastern parts of the country. In the early part of September the drought conditions in western Pennsylvania and West Virginia became so serious as to interfere with industrial activity. Several plants of the Frick Coke Company were compelled to shut down, owing to shortage of the water supply; while at Morgantown, W. Va., the big plant of the American Sheet and Tinplate Company was forced to suspend operations for the same cause. Scores of lumber, coal and coking plants in the two states mentioned were also compelled to close down for longer or shorter periods because of lack of water; while Johnstown, Pa., has been practically without water for some weeks, owing to the total drying-up of two of the large reservoirs supplying the town.

In the Middle West the drought conditions have been equally severe and long-continued. In the section surrounding Laporte, Ind., and contiguous territory, on September 13, the farmers joined in all-day services, praying for rain. Through Indiana, Ohio, Michigan, Wisconsin, Iowa, and on west to the Rocky Mountains, the drought also prevailed, doing great damage and paving the way for destructive fires, insect plagues, and a host of evils. Reports for the irrigated lands of the West indicate that not in a great many years has there been such a pronounced shortage of water for irrigation purposes; while, in the middle western regions,

farmers hauled water in barrels, for distances of several miles, to supply their live stock.



Flood Damage in the South

NOT in years has the South been visited with as serious and disastrous floods as those that swept the streets of Augusta, Ga., and other Southern cities a few weeks ago. Damage to the amount of several millions of dollars was done by floods in Georgia alone; while neighboring states suffered almost equally appalling loss. While the West and the Middle West suffered from drought and forest fires, the South was being plagued with inundations that swept away property to the value of millions, and caused the loss of scores of human lives. The same conditions are responsible for the floods in the South and the drought in western Pennsylvania and West Virginia, namely, the deforestation of the mountain slopes. Pennsylvania's annual flood loss runs into the millions of dollars, and the South is rapidly coming to a similar condition. Spring and winter floods annually ravage Pennsylvania, sweeping away in a few days property amounting in value to far more than would be the cost of inaugurating and maintaining a thorough and practical system of mountain-slope reforestation and water conservation by means of flood-water reservoirs; while the establishment of a comprehensive system of such reservoirs would do away with conditions such as have lately forced the suspension of scores of mills and factories that have been compelled to close down on account of lack of water. Floods at one season—inundations that ravage an entire region and wash away millions of dollars in property and other mil-

lions of dollars in soil and humus—and scorching droughts at other seasons; this is the invariable history of a country from which the forests have been stripped.



National Conservation League

WITH Walter L. Fisher, of Chicago, as president, President Roosevelt as honorary president, and William Jennings Bryan, and William H. Taft as honorary vice-presidents, the National Conservation League has been organized. The National Rivers and Harbors Congress has taken the initiative in the movement for welding into a coherent whole the various conservation organizations of the country, and the membership of the newly-formed league will eventually embrace all such bodies, those of a local scope as well as those whose field of activity is the whole nation. The league idea has been under more or less serious consideration for a long time, but the impetus that has at last resulted in its formation was given by the White House conference last May. The purpose of the league are given in its declaration of principles, which follows:

“Whereas it is of the utmost importance that the natural resources of the nation shall be comprehensively and vigorously developed and utilized for the promotion of the public welfare without waste, destruction or needless impairment, and subject always to their intelligent conservation and the effective preservation of the rights and interests of the future generations of our people.

“Now, therefore, to secure the recognition and support of these principles by the people and by their representatives, we hereby unite in a national conservation league, and adopt for ourselves the following, taken directly from the declaration unanimously adopted by the Conference of Governors convened by the President of the United States in the White House at Washington, May 13, 14, and 15, 1908.

“We do hereby declare the conviction that the great prosperity of our country rests upon the abundant resources of the land chosen by our forefathers for their homes and where they laid the foundation of this great nation.

“We look upon these resources as a heritage to be made use of in establishing and promoting the comfort, prosperity, and happiness of the American people, but not to be wasted, deteriorated, or needlessly destroyed.

“We agree that our country's future is involved in this: That the great natural resources supply the material basis upon which our civilization must continue to depend, and upon which the perpetuity of the nation itself rests.

“We agree that this material basis is threatened with exhaustion.

“We agree that the land should be so used that erosion and soil-wash shall cease, and that there should be reclamation of arid and semi-arid regions by means of irrigation and of swamp and overflowed regions by means of drainage; that the waters should be so conserved and used to promote navigation, to enable the arid regions to be reclaimed by irrigation and to develop power in the interests of the people; that the forests which regulate our rivers, support our industries and promote the fertility and productiveness of the soil should be preserved and perpetuated; that the minerals found so abundantly beneath the surface should be so used as to prolong their utility; that the beauty, healthfulness, and habitability of our country should be preserved and increased; that sources of national wealth exist for the benefit of the people, and that monopoly thereof should not be tolerated.

“We declare our firm conviction that this conservation of our national resources is a subject of transcendent importance which should engage unremittingly the attention of the nation, the states and the people in earnest cooperation.

“We agree that this cooperation should find expression in suitable action by the Congress and by the legislatures of the several states.

“Let us conserve the foundations of our prosperity.”



For Automobilists' Information

IN THE September issue of this magazine occurred a mention of the fact that automobilists are beginning to find the topographic maps issued by the United States Geological Survey of great help in laying out tours or lines of travel. For the information of many correspondents who have written the editor asking for information regarding these topographic maps, it may be



AN "ABANDONED" FARM

Hillside Erosion and Gullies. Where the Top Soil Has Been Washed Away. No Soil, No Farm
Catawba County, North Carolina

said that letters addressed to the Geological Survey, Washington, D. C., asking for information, will receive prompt answers. The Survey will advise all inquirers in regard to maps already issued, as well as those shortly to be published, and will give all details as to how the maps may be of help to tourists, just what regions they cover, how to secure them, etc.

Interested in Conservation

THE West Virginia Board of Trade announces that its fourth annual meeting will be held in Clarksburg, W. Va., on November 10 and 11, next. It is also announced that at this meeting forestry, and the general subject of conservation of natural resources will receive much attention, and that the board intends to forward the cause of the forests and other natural resources in every way possible. At the last meeting, held in Elkins, W. Va., Mr. William L. Hall, associate forester of the

Forest Service, delivered a comprehensive and interesting address on "The Appalachian National Forest. At that time the board adopted resolutions providing that a committee be appointed which should prepare and submit to the governor of West Virginia, for his consideration and for action by the state legislature, a bill or bills outlining a state forest policy and providing for state forest reserves and forest protection. The resolutions also favored the establishment of the proposed Appalachian National Forest, and urged the senators and representatives from West Virginia to vote for the speedy establishment of the proposed forest.

Tan-bark Supply Failing

FIGURES lately compiled by the Census Bureau, with the assistance of the Forest Service, would seem to indicate that the American supply of tan bark is decreasing. A loss in val-

ue in the 1907 consumption of tan bark of \$281,846, is noted, as compared with 1906; while the total production of bark fell off 156,941 cords, or 11.4 per cent. decrease from 1906. A decrease in value and an increase in cost, delivered to the tanneries, etc., is also noted, while the use of extracts and chemicals in tanning is noted, 35,510,130 pounds more of such extracts and chemicals being used in 1907 than in 1906. A summary of the Census Bureau's advance outline follows:

In point of value, the reported consumption of these commodities in the tanneries of the United States in 1907 was slightly less than the reported consumption in 1906, the decrease being from \$21,487,393 to \$21,205,547, a loss of \$281,846, or 1.3 per cent. The total quantity of tan bark consumed decreased from 1,371,342 cords to 1,214,401 cords, a loss of 156,941 cords, or 11.4 per cent. The value of tan bark decreased from \$12,774,071 to \$11,555,874, a loss of \$1,218,197, or 9.5 per cent., while the average cost per cord delivered at the tannery advanced between the two years from \$9.32 to \$9.52, a gain of \$0.20, or 2.1 per cent. The total consumption of extracts was substantially larger in 1907 than in the preceding year, the increase being from 329,389,405 pounds to 364,899,535 pounds, a gain of 35,510,130 pounds, or 9.7 per cent. In total value this material advanced from \$8,713,322 to \$9,649,673, a gain of \$936,351, or 9.7 per cent.

The two general movements in the tanning industry which have characterized its development during recent years are clearly disclosed by the figures. The growing scarcity of barks and native extracts and, in a measure as a result of this, the increasing use of chemicals as tanning materials, is evident from the fact that the total outlay for barks and native extracts was smaller in 1907 than in 1906, although as a rule the average cost per unit of these commodities increased. That the supplanting of barks by extracts continues at a rapid rate, and that this is incidentally effecting a change in the industry with respect to its location and the size of the average plant is apparent. The greater ease and economy with which extracts can be transported as compared with the handling of barks is resulting in a tendency to locate the tannery more with regard to an advantageous marketing of products and less with regard to the source of materials. A number of small plants reporting in 1906, and using bark exclusively, have either closed down permanently or removed from the more remote districts where supplies of bark were available to more advantageous shipping points, and substituted

extracts or chemicals for barks as the principal tanning materials. This trend of the industry is indicated in the decreased number of establishments reporting in the later year, the statistics for that period covering 583 plants, while those for 1906 covered 627 active tanneries. Of the total number of plants reporting in the later year, 121 used tan bark exclusively, 122 extracts exclusively, and the remaining 340 both barks and extracts, as tanning materials. As in the preceding year, hemlock bark was used more extensively than any other, the consumption in 1907 amounting to 815,840 cords, and constituting sixty-seven per cent. of the total of all barks. Oak bark ranked next to hemlock, with 349,594 cords, while chestnut and other kinds were consumed in minor and relatively unimportant quantities.

The leading extract in both years in point of consumption was quebracho, and according to the reports the consumption of this material increased from 133,508,306 pounds in 1906 to 145,324,677 pounds in 1907, a gain of 11,816,371 pounds, or 8.84 per cent. Chestnut extract ranked second in both years and increased from 128,535,018 pounds to 134,819,100 pounds, a gain of 6,284,082 pounds, or 4.7 per cent. These two extracts combined formed 79.6 per cent. of the total of this class of materials in 1906, and 76.8 per cent. in 1907, while quebracho extract alone formed substantially the same percentage of the total in both years, namely, 39.8 per cent. in 1907 and 40.5 per cent. in 1906. A slight decrease is noted in the average cost per pound of quebracho extract in 1907, while a small advance was made in that of chestnut extract. The consumption of hemlock extract increased from 34,405,978 pounds to 40,133,524 pounds, a gain of 5,727,546 pounds, or 14.3 per cent., with little change in the average cost per pound. The quantity of oak extract consumed was practically the same in the two years, being 30,192,151 pounds in 1906 and 30,830,291 pounds in 1907, while the average cost per pound advanced slightly, the increase being from \$0.02 to \$0.021.



Information Desired

UNDER date of August 27 the United States Forest Service sent out the following letter, requesting detailed information along certain lines, the Service having been requested to undertake the investigation by the National Conservation Commission recently appointed by President Roosevelt. The letter in full is printed herewith, and members of The American Forestry Association, as well as all other readers of CONSERVATION, are re-

quested to communicate to the Forest Service any facts in their possession which may throw any additional light on the various phases of the question of relation of forest covers to water supply. The letter follows:

United States Department of Agriculture, Forest Service, Washington,
Office of the Forester,

August 27, 1908.

The National Conservation Commission appointed by the President as a result of the conference of the governors held last May, has asked the Forest Service to furnish information regarding our forest resources and their relation to other natural resources. One of the most important subjects in this connection is the relation of forests to the water supply in all its phases—irrigation, water power, navigation, and the supply for towns and cities. The Forest Service is planning to take up a detailed study of this problem in cooperation with the Weather Bureau, the Reclamation Service, and the Geological Survey. In order, however, to secure immediate information for the commission and to supplement the field work of the Forest Service, which will necessarily be confined to somewhat limited areas, the following questions are being asked of competent observers throughout the United States who are known to be interested in the problems which concern our national welfare:

1. Have any instances come under your notice where the removal of the forest cover from a certain watershed has had any definite effect upon the flow of the streams which take their rise there, and if so to what extent? Please give the dates, as nearly as possible, the exact location of the watershed, and describe, as nearly as you can, the topography, the rock, the soil, and the kind of forest removed.

2. Have you observed any relation between the condition of watersheds and the silting up of rivers, ponds, and reservoirs?

3. Do you know of any specific instances where the destruction of the forest cover upon watersheds which

furnish water for the use of towns or cities can be held responsible for the breaking out of epidemics?

4. Do you know of any specific cases where springs have dried up after destruction of the forest cover, or where they have returned with its restoration? Please give the dates, as nearly as possible, the exact location of the spring, and describe the topography, the rock, the soil, and the character of the forest which was removed or which has sprung up again.

5. Do you know of any instances where artesian wells have dried up, or where they have begun to flow again? Can any connection be traced between this and the condition of the catchment basin? Give the dates as nearly as possible, the location of the catchment basin, and describe the topography, rock, soil and the general forest conditions.

6. Can you suggest the names of any persons who would be in a position to give additional facts?

Any information which you can give along these lines will be greatly appreciated by both the Conservation Commission and the Forest Service. As early a reply as possible is desired in order that the material may be used by the commission in its report November 1. I enclose a franked envelope for reply.

Very truly yours,

W. F. Cox,
Assistant Forester.

Production of Pig Iron in the United States

THE pig-iron production of the United States in 1907 amounted to 25,781,361 long tons, as compared with an output of 25,307,191 tons in 1906, and of 22,992,380 long tons in 1905, according to a statistical report just published by the United States Geological Survey. The smallness of the increase shown in 1907 over 1906 is due to the falling off in demand and production during the last quarter of the year. If the rate of output of the first half of

the year had been maintained the total production of pig iron in 1907 would have been 27,000,000 tons.

Statistics of the production of pig iron have not hitherto been collected independently by the United States Geological Survey. The figures published in its annual reports on mineral resources having been furnished by Mr. James M. Swank, the general manager of the American Iron and Steel Association. In January, 1908, however, in order to ascertain the value of the pig-iron output, circular letters were sent to all the producers asking them to furnish to the Survey confidential information as to stocks on hand December 31, 1906, marketed production, total receipts from sales free on board at furnace during 1907, and stocks on hand December 31, 1907. The managers of only three furnaces, rated at an average annual output of 35,000 tons each refused or failed to comply with this request, and the total production reported to the Survey differs by only about four-tenths of one per cent. from the total output reported by Mr. Swank—25,781,361 long tons.

The following table gives the quantity and value of pig iron produced in the United States in 1907, by states:

Quantity and value of pig iron produced in the United States in 1907 by states

State	Quantity (Long tons)	Value
Alabama.....	1,686,674	\$30,100,000
Illinois.....	2,547,768	52,229,000
New Jersey.....	373,189	7,554,000
New York.....	1,659,752	33,097,000
Ohio.....	5,250,687	106,387,000
Pennsylvania.....	11,348,549	234,952,000
Tennessee.....	393,106	7,542,000
Virginia.....	478,771	8,963,000
Colorado.....	468,486	11,628,000
Missouri.....		
Connecticut.....	19,119	663,000
Massachusetts.....		
Georgia.....	55,825	1,181,000
Texas.....		
Indiana.....	758,590	18,820,000
Michigan.....		
Minnesota.....	830,845	16,833,000
Wisconsin.....		
Kentucky.....	830,845	16,833,000
Maryland.....		
West Virginia.....	25,781,361	529,958,000

Harry Day Everett

AT THE Forester's Conference, held in the office of the Bureau of Forestry of the Philippine Islands on July 29, the following resolutions in memory of Harry Day Everett, the young Forester who was murdered by natives of the island of Negros, on May 11 last, were adopted:

By the death of Harry Day Everett, Forester, and Chief of the Division of Forest Administration, the Philippine Bureau of Forestry loses one of its most efficient and faithful workers.

Mr. Everett first became interested in the subject of forestry during the latter years of his academic course at Cornell University. After his graduation in 1903 as Bachelor of Arts, he entered the University of Michigan, from which institution he received the degree of Master of Science of Forestry in 1904. From 1902 to 1904 he spent his summer vacations with field parties of the United States Bureau of Forestry, and upon completion of his studies at Michigan entered the service as a forest assistant.

In 1905 Mr. Everett transferred from the Forest Service of the United States to the Bureau of Forestry, Philippine Islands. Soon after his arrival in the Philippines he was placed in charge of forest district No. 8, embracing the Visayan Islands. On the reorganization of the bureau in 1907 he was made chief of the division of forest administration. During the absence of the director of forestry in the United States, from August, 1907, to April, 1908, Mr. Everett was placed in charge of the affairs of the bureau. The duties of acting director he relinquished on the return of the director. Shortly afterwards he left for Iloilo to prepare for the expedition on which he was killed. He had for some time desired to finish his work in Southern Negros, which, when done, would complete his forest studies and forest map for the Island of Negros. Together with work previously accomplished in Negros, the results of this expedition were intended

for a bulletin on the forest conditions of that island.

According to the best information available, Mr. Everett had already made one journey across Negros from Cabancalan on the west coast to Bais on the southeast coast, and had started to return to Cabancalan by the way of Tolon on the southern coast. About three or four days inland from this town, at the sitio of Pamari, on May 11, the guide, assisted by his followers, drugged Mr. Everett and party, while asleep, by means of fumes of a narcotic plant, and then murdered them. Therefore be it

Resolved, That the Director of Forestry, and members of the Bureau of Forestry assembled in conference on this 27th day of July, 1908, express our appreciation of the services, efficiency, and character of Mr. Everett, whose personality and accomplishments will leave their mark on the future personnel and work of this bureau; and be it

Resolved, That this conference extend to his family in their hour of affliction, our deep sympathy for their loss, a loss which we as his associates, who knew him both personally and professionally so thoroughly feel; and be it

Resolved, That a copy of this testimonial be sent to the bereaved family, the *Manila Times* and *Cablenews-American*, CONSERVATION, Washington, D. C., *Forestry Quarterly*, Ithaca, N. Y., and the Alumni Associations of the University of Michigan, and Cornell University, and Gifford Pinchot, Forester, United States Department of Agriculture, Washington, D. C.

✻ ✻ ✻

The New Mexico Coke Industry

NEW Mexico is assuming considerable importance as a coke producer, according to E. W. Parker, chief statistician of the United States Geological Survey, notable progress having been made during the last three years.

In 1903 there were but two coke-making establishments in the Territory, with a total of 126 ovens, and the

production amounted to 11,050 tons. In 1904 the number of establishments was increased to three, the number of ovens to 234, and the output to 58,259 tons. In 1905 the same number of establishments reported 258 ovens completed and 489 building, and the production amounted to 89,638 tons. In 1906 four establishments with a total of 571 completed ovens and 450 building, produced 147,747 tons of coke. Of the ovens building in 1906, 325 were completed in 1907, increasing the total number of completed ovens to 896, and the production of coke increased to 265,125 tons.

The increase in 1907 advanced the territory from sixteenth to fifteenth place in the rank of the coke-producing states and territories, and gave New Mexico a larger percentage of increase than any other state or territory except Kansas. In Kansas, however, the production of either year was insignificant. The increase of New Mexico's coke production in 1907 over 1906 was 117,378 tons, or 79.45 per cent., in quantity, and \$397,541, or 89.8 per cent. in value. The average price per ton increased from \$3 in 1906 to \$3.17 in 1907. One of the establishments, having a bank of fifty ovens, was idle during the year.

Of the 446,140 tons of coal converted into coke in the territory in 1907, all except 2,498 tons was washed slack.

Mr. Parker's statistical report on the coke industry has just been published by the Survey as an advance chapter from "Mineral Resources of the United States, Calendar Year 1907." Copies of this report may be obtained by addressing the Director of the Geological Survey at Washington, D. C.

✻ ✻ ✻

Oil Field Investigations in 1907 and 1908

WORK in the various oil fields of the country by members of the United States Geological Survey was carried forward much more actively during 1907 than in any previous year. In California Ralph Arnold and Robert Anderson extended the general investi-

gations which they have had in progress to the Coalinga field; in Wyoming C. W. Washburne and Deane Winchester investigated the occurrence of oil and natural gas in the Bighorn field; in Colorado the geology of the Rangely oil field was studied by Hoyt S. Gale; in Utah the occurrence of oil at Virgin City was investigated by G. B. Richardson; and in Pennsylvania, where co-operative work was carried on with the State Survey, M. J. Munn studied the oil fields of the Clarion, Carnegie, and Sewickley quadrangles, and Charles Butts those of the Warren quadrangle.

As a result, in part, of the field work of recent years the United States Geological Survey has published the following bulletins bearing on the oil areas of the country:

238. Economic geology of the Iola quadrangle, Kansas, by G. I. Adams, Erasmus Haworth, and W. R. Crane. 1904.
250. The petroleum fields of the Pacific coast of Alaska, with an account of the Bering River coal deposits, by G. C. Martin. 1905.
256. Mineral resources of the Elders Ridge quadrangle, Pennsylvania, by R. W. Stone. 1905.
265. Geology of the Boulder district, Colorado, by N. M. Fenneman. 1905.
279. Mineral resources of the Kittanning and Rural Valley quadrangles, Pennsylvania, by Charles Butts. 1906.
282. Oil fields of the Texas-Louisiana Gulf Coastal Plain, by N. M. Fenneman. 1906.
286. Economic geology of the Beaver quadrangle, Pennsylvania, by L. H. Woolsey. 1906.
296. Economic geology of the Independence quadrangle, Kansas, by F. C. Schrader and Erasmus Haworth. 1907.
300. Economic geology of the Amity quadrangle, in eastern Washington County, Pa., by F. G. Clapp. 1907.
304. Oil and gas fields of Greene County, Pa., by R. W. Stone and F. G. Clapp. 1907.
309. The Santa Clara Valley, Puente Hills, and Los Angeles oil districts, southern California, by G. H. Eldridge and Ralph Arnold. 1907.
317. Preliminary report on the Santa Maria oil district, Santa Barbara County, Cal., by Ralph Arnold and Robert Anderson. 1907. (Out of stock.)
318. Geology of oil and gas fields in Steubenville, Burgettstown, and Claysville quadrangles, Ohio, West Virginia, and Pennsylvania, by W. T. Griswold and M. J. Munn. 1907.
321. Geology and oil resources of the Summerland district, Santa Barbara County, Cal., by Ralph Arnold. 1907. (Out of stock.)
322. Geology and oil resources of the Santa Maria oil district, Santa Barbara County, Cal., by Ralph Arnold and Robert Anderson. 1907.
340. F. Investigations relating to petroleum and natural gas in 1907, by Ralph Arnold, G. B. Richardson, C. W. Washburne, and A. R. Schultz. 1908.
350. Geology of the Rangely oil district, Colorado, by H. S. Gale. 1908.
357. Geology and oil resources of the Coalinga oil district, Fresno and Kings counties, Cal., by Ralph Arnold and Robert Anderson. (Preliminary report.)

Preliminary announcement of the results obtained in the field examinations of 1907 have been published as Section

F of Bulletin 340, which contains the following chapters: Miner ranch oil field, Contra Costa County, Cal., by Ralph Arnold; Petroleum in southern Utah, by G. B. Richardson; Labarge oil field, central Uinta County, Wyo., by A. R. Schultz.

The following investigations will be carried on during the field season of 1908:

Continuation of work in California oil fields, by Ralph Arnold.

Comprehensive studies of the Mid-Continent field, by J. A. Taff and W. J. Reed.

Occurrence of oil in the Foxburg quadrangle, Pennsylvania, by G. H. Ashley and M. J. Munn.

Preliminary examination of the oil pools at Belle Isle and of the Caddo field, Louisiana.

Occurrence of oil in the vicinity of Florence Colo., by C. W. Washburne, and in the Boulder field, Colorado, by G. C. Martin.

Interest of Women in Conservation

THE following communication from Mrs. Frances Shuttleworth, corresponding secretary of the Women's National Rivers and Harbors Congress, is another indication of the intense interest that is taken by women generally, and clubwomen in particular, in the conservation movement:

EDITOR CONSERVATION:

I am writing to congratulate you on the splendid magazine you are now publishing in the interests of our natural resources. Particularly am I interested in all articles that touch on waterways and forests. As you may know, the Women's National Rivers and Harbors Congress was organized in Shreveport, La., on June 29 last, to promote as one problem the development of all practicable waterways and the extension and conservation of forests. This Congress aims to cover the nation with a net work of information that will in time bring men and women to a full realization of our country's possibilities



IN KERN RIVER CANYON

Where Power Projects Are Under Way that Are Expected to Develop Electrical Energy to the Amount of at Least 50,000 Volts as a Beginning

for permanent prosperity with such development and extension, and to demonstrate unmistakably the rapid and sure decadence of the country unless the national government takes the conservation of these resources in hand, and, with expert care and supervision and liberal appropriations, looks vigorously to their pressing needs. We believe that, with this sort of conservation of waterways and forests by the national government, with the states and individuals giving earnest cooperation as they realize that it is the government's right and duty to preserve our material prosperity, the result will largely cover the conservation of all other resources.

What I want to ask you is this: As we are so nearly allied in purpose—in part wholly so—would you care to aid our propaganda and yours by printing some of the notes of our progress? We should be glad to send the material to you; our organization must be your organization's half-sister. Awaiting

your reply, while we again assure you of our heartiest endorsement and appreciation of CONSERVATION, I am,

Cordially,

(MRS.) FRANCES SHUTTLEWORTH,
Cor. Sec. Women's National Rivers and Harbors Congress.
Shreveport, La.

Leading Nations Import Much Lumber

FEW people have the slightest conception just how important a part timber and unmanufactured wood play in the trade between the world's great nations, and doubtless it is news to many to learn that the lumber importations of the various countries amounts to \$285,600,000. This is according to estimates for the whole world, compiled by Dr. Ernest Friedrich, of the German Commercial High School at Leipzig.

Notwithstanding the fact that it finds its own supply dwindling, the United States furnishes about twenty per cent.

of the lumber imported by other countries. Austria-Hungary furnishes nineteen per cent., Russia sixteen per cent., Canada thirteen per cent., Sweden eighteen per cent., Finland ten per cent., and Norway and Roumania a small quantity.

The countries importing wood are those on the highest economical plane, which were themselves in earlier times densely wooded, but whose forests have been denuded to a greater or less extent to make room for agriculture and other industries, says Vice-Consul James L. A. Burrell, of Madgeburg, in a report to this government. Only four per cent. of the territory of Great Britain is covered with forests, and during the year 1906 that country imported lumber to the value of \$135,561,750. Germany has still twenty-six per cent. of its territory covered by forests but imported in 1906 lumber valued at \$61,285,000. Belgium and the Netherlands, that have but eight per cent. forest lands, Denmark, that has seven per cent., France and Switzerland, with a small percentage, are all compelled to import lumber.

Besides these countries, those lands lying on the dry western side of the sub-tropical zone lacking forests are forced to import wood. Egypt imports wood and coal to the value of about \$16,660,000 annually; Algeria, Tunis, Spain, Portugal (with only three per cent. forest land), Italy, Greece (with nine per cent. forest land), the eastern part of Asia, British South Africa, the western part of Chile and Peru, the Argentine Republic, and Australia, all poor in wood, are dependent upon import.



The Waters of the Great Lakes

MORE than four million people, living in a hundred cities, obtain water for domestic and industrial uses from the great inland seas on the northern boundary of the United States; and boiler water for the enormous land and water traffic that joins these cities to one another and to the rest of the world

is derived from the same source. The chemical composition of these waters is therefore a matter of great interest to both sanitarians and chemical engineers, and a study of that composition is also valuable because the comparative equable condition of the lake waters allows them to serve as a standard for comparison with other waters in the northern region.

About two years ago the United States Geological Survey began a study of the waters of the Great Lakes in connection with a rather extensive investigation of the economic value of surface waters in the United States. For a year a 1-gallon sample was collected each month from each lake at a point where the water would probably represent the normal quality of the discharge. Samples of Lake Superior water were taken from St. Mary's River just above the locks at Sault Ste. Marie, Mich.; the Lake Michigan samples were collected from a ferry-boat in the Straits of Mackinac; St. Clair River was sampled in midstream at Port Huron, Mich.; Lake Erie was sampled at the Buffalo (N. Y.) water-works intake; and St. Lawrence River was sampled at Ogdensburg, N. Y., since no important streams enter between that city and Lake Ontario. The waters were shipped in special containers to the water-testing laboratory of the Survey at Washington, D. C., and were analyzed from one to three months after date of collection. Suspended matter was removed before the samples were evaporated, and standard methods of water analysis were followed when practicable.

Mr. R. B. Dole, under whose direction the analyses were made, states that the most noticeable feature in a cursory examination of the analytical data is the slight variation in the concentration of the waters from month to month, the total variation, as shown by the dissolved solids figures, being only eighteen parts per million, or fifteen per cent. As rivers of ordinary size may vary 200 to 300 per cent., and even large rivers, like the Mississippi, may

change fifty per cent. in their mineral content during the year, this annual fluctuation of fifteen per cent. is very small. The average monthly fluctuation in the discharge of the Great Lakes is considerably more than fifteen per cent., ranging from forty per cent. in St. Mary's River to twenty-seven per cent. in St. Lawrence River at the foot of Lake Ontario. The chemical composition of the water does not, therefore, bear a fixed relation to the quantity of water discharged. Mr. Dole gives as the probable reasons for this comparative steadiness in concentration the absence of large tributaries and the low ratio between the areas of the drainage basins and the lake surfaces.

Though the lake waters do not change greatly from month to month, they differ a great deal from one another in concentration. Lake Superior is least strongly mineralized; Lake Michigan is twice as high in total solids, and Lake Huron is but little less mineralized than Lake Michigan. Lakes Erie and Ontario are practically alike in mineral content, holding about two and one-half times as much solids in solution as Lake Superior. Reason for the striking difference in the lake waters is found in the character of the geologic formations in the drainage basins tributary to them. The crystalline and igneous rocks—granite, schist, gneiss, and basalt—that predominate all around Lake Superior, are not easily soluble, and hence the lake receives few affluents bearing large quantities of dissolved matter; Lake Michigan and Lake Huron, on the other hand, re-

ceive drainage from limestones and sandstones of the sedimentary series and contain much greater proportions of mineral matter. Dilution by the softer water of Lake Superior probably accounts for the fact that Lake Huron water is less mineralized than that of Lake Michigan. It is probable that forestation, sedimentation, and relation of rainfall to run-off also affect the relative composition of the lake waters.

Comparison of the analyses of the lake waters with those of tributaries to the system shows, according to Mr. Dole, that the lakes are almost invariably softer than their affluents. The reason for this difference is apparent: As the lake surfaces are large in proportion to their corresponding land drainages a great part of the rain falls directly into the lake waters and dilutes them; on the other hand, rain falling upon the land becomes more or less impregnated with mineral salts before it reaches the lakes in the normal run-off. This fact has an important relation to the industrial consumption of the waters, and shows the importance of locating intakes outside of the influence of tributary streams.

A study of all the data at hand leads to the conclusion that the lake waters may be specially recommended for industrial and domestic uses wherever they can be economically obtained. They are low in mineral content and normally free from turbidity, and the nature of the dissolved constituents is such that they can be used for boilers and for most other industrial purposes without purification.

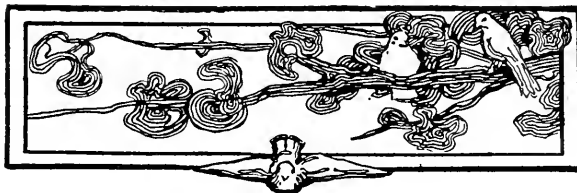

NAVIGATION RESOURCES OF AMERICAN WATERWAYS

By EMORY R. JOHNSON, Ph.D.

Professor of Transportation and Commerce, University of Pennsylvania, Philadelphia

THE primary purpose of this paper is to describe the water transportation system within the United States, to state what has been spent upon improving our waterways, to give the facts regarding the present use of our lakes, canals, and rivers, to point out and account for the progress of the coastwise and Great Lakes commerce, and to explain the decline of the traffic upon canals and upon most of our rivers. In order to add to the significance of the data regarding the United States, the mileage and traffic of the inland waterways of England, France, and Germany are given. The discussion closes with a summary of the facts and conditions that indicate a larger use of American waterways in the future.

The inland waterways of the United States comprises about 25,000 miles of navigated rivers, a nearly equal mileage of streams that can be made navigable by the improvement of their channels and the regulation of the flow of their waters, the five Great Lakes with a combined length of 1,410 miles, and 2,120 miles of operated canals. In addition to these rivers, lakes, and canals there are 2,500 miles of sounds, bays, and bayous, capable of being converted by means of connecting canals aggregating less than 1,000 miles in length, into a continuous and safe inner route for the coastwise traffic of the Atlantic and Gulf. The waterways in our country—rivers, canals, lakes, and coastal channels—have an aggregate length of between 55,000 and 60,000 miles, and only about half of the entire mileage is now used for navigation.

Considering the great length and undoubted value of our inland waterways, comparatively little has been done to make them commercially useful. The most effective work has been done in improving the harbors and channels of Lakes Superior, Michigan, Huron, and Erie, where natural depths of eight and twelve feet have been increased to twenty-one, with the result that the freight now shipped on the Great Lakes—75,000,000 tons in 1903—is three times what it was in 1890. The traffic passing the St. Mary's locks rose from a million and a quarter tons in 1880 to seven and a half millions in 1889, and to forty-one and a quarter million tons in 1906, an increase of

3,200 per cent. This commerce on the Great Lakes has been made possible by total congressional appropriations of less than a hundred million dollars.

The total appropriations made by Congress from the beginning of 1907 for the rivers of the Mississippi Valley amount to \$208,484,720. This seems to be a relatively large sum; but it should be remembered first, that over \$17,000,000 of this total were expended—and wisely spent—upon the Mississippi River between New Orleans and the Gulf and had reference rather to maritime than to inland commerce; and second, that on some rivers, particularly the Mississippi, appropriations have been largely spent in levee construction and other work which, while indirectly helpful to navigation, was intended primarily to prevent the rivers from destroying the lives and property of those living on or near its banks. With the exception of the Ohio (including the Monongahela and Kanawha) and Mississippi and a few other large rivers, relatively little has been expended since 1890 by the Federal Government in bettering river navigation. When we consider that the United States has spent during the past hundred years in regulating, improving, and extending our system of natural waterways only four and one-half per cent. of the amount private capitalists have invested in the construction of railways, our Congressional appropriations for the betterment of inland navigation seems to have been conservatively small.

In the canalization of rivers the United States is making some headway, portions of twenty-three streams having been canalized to an aggregate length of 1,520 miles in 1906. This, however, was a gain of but 442 miles over the figures of 1880. When only the more important rivers shall have been adequately canalized there will be several times 1,500 miles of slackwater navigation.

The United States operated twelve canals in 1906 with a combined length of 78.10 miles. These, however, were constructed to overcome obstructions to lake and river navigation and were not independent waterways. In 1907 the Hennepin Canal, from the Mississippi River at Rock Island, to the Illinois River at its great bend, was put in operation

by the United States, and this waterway, ninety-six miles long, is the first of its kind to be managed by the Federal Government. Nearly all of the canals in the United States belong to the states or to corporations. The only really important state canal is the Erie, now being modernized by the people of New York.

The highly valuable reports of the United States Commissioner of Navigation contain classified information regarding documented American vessels, the aggregate tonnage of which is about six and a half million tons; but there is an equal tonnage of undocumented craft not included in the tables published by the Bureau of Navigation. Comparatively few people are aware of the fact that American shipping has a total tonnage of over 13,000,000 tons gross register.

The Bureau of the Census has about completed a report on "Transportation by Water" in the United States in 1906. This, like the preceding report of that bureau, which was made in 1889, seventeen years ago, is a valuable document exceptionally complete as regards American shipping, but necessarily less satisfactory regarding passenger and freight traffic, for the simple reason that full and accurate information regarding traffic cannot be obtained until machinery shall have been provided for the systematic and daily recording of freight and passenger movements.

In calling attention to the relatively small amount of information concerning transportation by water obtainable from the regularly published official reports of the Federal Government, there is no thought of criticizing the bureaus by which those reports are compiled and issued. The powers those bureaus possess and the scope of their activities are fixed by law. Congress decides what data the public shall have regarding our navigation resources, and the use made of those resources. As the Inland Waterways Commission states in its preliminary report, this "information is essential to an intelligent treatment of the inland waterways, and it is desirable that means be employed to obtain it;" and the Commission wisely includes in its recommendations "the adoption of means for ascertaining regularly all facts relating to traffic on the inland waterways, and for publishing the same in a form suitable for general use."

According to the report on "Transportation by Water" recently made by the Bureau of the Census, American craft of all classes, exclusive of those in the fishing fleet and those owned by the Federal Government, numbered 39,083, and had a combined tonnage of 13,072,755 in 1906. Of this total there were 1,441 registered vessels—those employed in foreign commerce—and their tonnage amounted to less than a million (939,486) tons gross. Thus the craft constructed for domestic trade included 37,642 vessels, with a tonnage of 12,133,269. In ad-

dition to this there was a fleet of 6,910 vessels with a total tonnage of 196,132, employed in catching and transporting fish, and a great host—82,443—of small boats and launches used in the fishing industry.

The census taken in 1906 shows that there were 37,321 vessels actively employed in domestic and foreign commerce of the United States, of which total 20,032 were operated from the Atlantic and Gulf coast, 2,537 on the Pacific coast (including Alaska), 2,990 on the Great Lakes and St. Lawrence, 9,622 on the Mississippi River and its tributaries, and 2,140 on our other inland waters. The gross tonnage of the Great Lakes' fleet was 2,392,863, 18.4 per cent. of the total for all American merchant craft in 1906; the tonnage of boats and barges—mainly coal barges—on the Mississippi and its tributaries was 4,411,967, 34.2 per cent. of the total; and the tonnage of the craft on other inland waters was 259,491, or 2.01 per cent. of all American shipping. The tonnage of the river and canal craft thus amounted to 4,671,458, or 36 per cent. of the total of all active American shipping.

The freight shipped on the Great Lakes in 1907 amounted to 83,498,171 tons; the total for the previous year—the one covered by the census report—was 75,610,690 tons, which was 42.6 per cent. of the total freight, exclusive of harbor traffic, handled upon American waterways coastwise and inland. The traffic of the Mississippi River and its tributaries in 1906 was 19,531,093 tons, or eleven per cent. of the total. On the other inland waterways the freight aggregated 3,716,765 tons, or 2.1 per cent. of the total. The combined traffic on the Great Lakes and our other inland waterways in 1906 was 98,858,548 tons, 55.7 per cent. of the total water-borne domestic commerce of the United States.

Such was the traffic in 1906. Comparisons with the previous census of 1889 will show where progress has taken place and what waterways have gained and what have lost in tonnage. The most rapid growth has been in the commerce of the Great Lakes, which rose from 25,266,978 tons of shipments in 1889 to 75,610,690 tons in 1906. The port-to-port traffic of the Mississippi River and its tributaries in 1906 amounted to 19,531,093 tons of freight. There was also handled locally in and about the harbors 8,327,548 tons, making a total of 27,856,641 tons for the rivers of the Mississippi Valley. In 1899 the figures were 29,401,409, there having been a decrease of 1,544,768 tons in the seventeen years. The freight handled on the other inland waterways of the United States experienced a very large decline during this period, the total tonnage of freight carried having fallen from 11,221,224 tons in 1889 to 3,944,655 tons in 1906.

In order to make the statement of traffic complete the passenger business must be included. The highly efficient steamers of the

lake lines carried 14,080,146 passengers in 1906; the figures for 1889 were 2,235,993, the increase during the seventeen years being 529.7 per cent. There was also an increase of thirty per cent. in the passenger traffic handled on the Mississippi River and its tributaries, the figures for 1889—10,858,894—having risen by 1906 to 14,122,241. It should be noted, however, that this increase was due more largely to the growth in short-distance travel and in ferry traffic than to an increased patronage of the river steamboats operated over the longer routes. The passenger traffic on the other inland waterways of the United States in 1889 is not known, but it amounted to something less than two millions (1,877,889) in 1906.

A comparison of the United States with some of the leading countries of Europe as to the extent to which the navigation resources of each country have been developed, and as to the traffic uses made of inland waterways will contribute to a clearer appreciation of the facts concerning the United States.

Great Britain.—Although Great Britain is of small territorial area and has not followed the policy adhered to by the continental countries of retaining the inland waterways as public highways to be developed by the government, the mileage and traffic of her streams and canals are by no means insignificant. The total coast line of Great Britain, 3,900 miles in length, is supplemented by about 4,000 miles of canals and improved rivers. The traffic on these inland waterways, exclusive of the coastwise maritime commerce, amounted to 37,426,886 tons in 1898, the latest year for which official Board of Trade statistics are obtainable.

The five principal estuaries of England—the Mersey, Humber, Wash, Thames, and Severn—are connected by nineteen through canal routes. Nine of these through routes reach Severn ports, nine have London termini, ten reach Liverpool, and five terminate at Hull. The traffic is most active on the canals in central and northern England. The 642 miles of waterways in this highly developed industrial district moved 23,500,000 tons of freight in 1898. The canals reaching Birmingham had 7,750,000 tons of traffic.

The water resources of Great Britain have come to be such a valuable asset to the country that the supply and the uses of water must be carefully guarded. If the streams are to be maintained as navigable waterways, if the municipalities are to have an abundant supply of pure water, the mining companies must not be permitted to continue their reckless waste of water; the disposal of sewage must be carefully planned so as to prevent the pollution of the streams; and if the valuable fisheries in the tidal and fresh-water portions of the rivers are to be preserved, careful regulation will be neces-

sary. In a word, the necessity for a permanent waterways commission is becoming apparent.

France.—France has developed her inland waterways more systematically and completely than has any other of the larger European countries. Three thousand sixty-two miles of canals are now in operation, and 4,500 miles of her rivers—largely as the result of canalization—are used for navigation. Prior to 1880, the greater portion of the English freight business of the country was handled on the waterways. Since then the development of the railroads has naturally enabled them to exceed the waterways in tonnage; but the waterways have, none the less, transported a steadily increasing tonnage. During the twenty years from 1885 to 1905 the freight tonnage rose from 19,573,000 to 34,030,000 metric tons. The ton mileage of the water-borne traffic amounted to 3,178,000,000 in 1905, and was more than double the total for 1885. All the waterways of the country, with the exception of 160 miles (seventy-five of which are owned by the city of Paris) are public ways improved and maintained by the state. Their use is free, tolls having been abolished in 1880.

Germany.—The policy of Germany in the development of her inland waterways is peculiarly instructive. The canals and navigable rivers of that empire, not including the tidal portions of the rivers navigated by sea-going vessels, have a total length of about 7,600 miles, of which about 6,250 miles may be considered to be commercially important. Three-tenths of the 6,250 miles consist of canals and slack-water river navigation, and seven-tenths of river courses improved without the construction of dams and locks. The railway mileage of the country is 34,000, somewhat over six times the length of the waterways actively used for commerce.

The tonnage of the shipments and receipts of freight transported on the German waterways in 1875 was 20,800,000 metric tons. The figures for 1905 were 103,400,000 metric tons, there having been an increase of nearly 400 per cent. The ton mileage of this water-borne commerce in 1875 was 1,812,500,000, and in 1905, 9,375,000,000—a gain of over 400 per cent. The ton mileage of the railroad freight traffic in 1875 was 6,812,500,000, and in 1905 the total was 27,875,000,000. The gain in the railroad traffic was far greater absolutely; but the percentage of increase in water traffic was larger, although the length of the waterways in 1905 was not much greater than in 1875, whereas the railway mileage had more than doubled during that period.

The density of traffic on the German waterways much exceeds that on the railroads. The number of tons carried one mile per mile of waterway rose from 290,000 in 1875 to 1,500,000 in 1905; the corre-

sponding figures for the railways were 410,000 tons carried one mile per mile of line in 1875, and 800,000 in 1905. The relative importance of the traffic of the railways and waterways in Germany is shown by the fact that twenty-five per cent. of the total ton mileage of rail and water traffic in 1905 was water borne, and seventy-five per cent. moved upon rails. Thirty years earlier the waterways had twenty-one per cent. and the railroads had seventy-nine per cent. of the combined ton mileage.

These brief references to England, France, and Germany suffice to show that the United States has as yet done less than has been done by her leading industrial and commercial rivals in the development and use of inland waterways, if we except—as of course we ought—the chain of Great Lakes which have no counterpart in any other country. Whether it is desirable that the United States should follow the example of France and Germany as regards inland water transportation is a question to which the American people are now giving serious thought. There can be no uncertainty as to the importance of the transportation services performed by our coastwise shipping, and by the fleet operated on the Great Lakes. The coastwise and Great Lakes traffic is rapidly growing; but upon our canals and many of our rivers, traffic languishes or declines.

Is it wise, it may be asked, for the United States to spend money in constructing canals and improving our rivers, and if so, under what conditions and to what extent? This is too large a question for one to attempt to answer fully in a short paper, the primary purpose of which is to present data rather than to draw conclusions; but some indication as to what policy may best be adopted may be given by calling attention briefly to the causes that account for the decline in canal and river traffic and by stating certain facts which seem to indicate that well-developed inland waterways may assist largely in the future economic progress of our country.

The causes accounting for the decline in the traffic upon our canals and rivers have been so clearly stated by the President in his address and in his special message of February 26, 1908, transmitting to Congress the preliminary report of the Inland Waterways Commission, and the same subject has been so fully presented in that report that a detailed discussion of those causes seems unnecessary.

The primary reason for the decline in the use of canals of such small dimensions and river channels so shallow as to permit the use only of craft capable of transporting 100 to 200 tons of cargo, is to be found in the very success which the railways of the United States have had in providing cheap transportation for heavy and bulky commodities. In no other country of the world have rail transportation costs been reduced

to such a low figure. The ability of our railroads to handle this class of traffic so economically has resulted not only from the genius of the American people in the use of machinery to do man's heavy work, but also, and more largely, from the fact that by far the greater share of the tonnage of American railroads consists of such bulky commodities as coal, iron, ore, lumber, and grain, which can be handled not only in car-load lots, but in train-loads, and which, from the very size of our country, must be moved long distances in order to reach the manufacturing centers of the United States and the primary markets within and without our borders.

In many other countries it has been found more economical to do the heavier transportation work by making large use of waterways, and to develop the railway traffic more particularly with reference—and this is especially the case with England, France, and Germany—to the speedy movement and schedule delivery of parcels, packages, and general commodity freight. This organization of the transportation service by rail is possible where there is a division of the transportation work between the railroads and waterways, and it results in the close co-ordination of railroad freight traffic with the wholesale and retail trade. It enables merchants and manufacturers to reduce capital costs and warehousing expenses to a minimum. It meets the needs of densely populated and highly developed industrial countries such as France and Germany, and especially of such a country as Great Britain, for, although the inland waterways of Great Britain are, as a whole, less carefully developed than are those of France and Germany, a large share of the domestic commerce of the United Kingdom is carried by water. The navigation services which most countries can secure only by means of inland waterways, the island of Great Britain, with its 3,900 miles of tidal coast, obtains from the surrounding ocean—the best of all highways.

Such an organization of the business of transportation as has been worked out in the three European countries just mentioned, does not result in as low average freight rates by rail as prevail in the United States; but the cost of wholesale and retail distribution and of many manufacturing activities are undoubtedly less than they would be were the people of Europe served almost entirely by railroads and not by railroads and waterways. Our dependence upon railroads, almost exclusively, for the movement of bulky commodities long distances even at low average rates, while we at the same time neglect the development and use of our inland waterways, does not necessarily mean that we have organized our work of production and distribution in the most economical manner. Indeed, there can be little doubt that as social and indus-

trial conditions in the United States approach more closely those prevailing in Europe, we shall find it increasingly desirable to provide ourselves both with well-developed waterways for handling much of our bulky traffic and with railroads more efficient than present conditions permit them to be in the handling of package freight. We, as well as Europe, will find it profitable to minimize capital and warehousing costs.

The construction of canals and the improvement of rivers in the United States have progressed slowly, in part at least, because the Federal Government has in the past left to the states the work of canal building, and, to some extent, the canalization of rivers. Several of the states, after having made costly mistakes in the execution of their earlier works of internal improvement, have been disposed to leave to private capital the creation of such waterways as special business interests might find it profitable to establish. In many instances the states have thought best to dispose of their waterways to the railroad companies, which have generally found it unprofitable to maintain both rail and water routes. The policy of leaving the development of water transportation to any considerable extent, either to the states or to private corporations, is now realized to be wrong in theory and unsatisfactory in practice.

The states are manifestly incompetent to carry out the improvement of our national waterways, such as the Mississippi, Ohio, Missouri, and Columbia rivers. Their development has always been a national concern. The construction of such waterways as the Erie and Panama canals are clearly works that private capital is neither able nor disposed to execute. The great State of New York has the financial ability and economic incentive to reconstruct the Erie Canal; but its route is so clearly national that the waterway should have long since been taken over and enlarged by the Federal Government.

The experience of our own country and of other nations shows conclusively that waterways should be public ways—that their execution and maintenance should be by the Government. The entire network of American waterways should be improved and extended systematically by one authority, and with reference to the economic and social needs of the entire nation. There is only one power whose authority is as wide as our country, and that is the Federal Government. In the future but small place in the development and control of waterways will be given either to the states or to private corporations.

There can be no doubt that the inland

waterways of the United States will be more extensively used in the future than they have been in the past. The reasons for this are numerous and conclusive:

1. The internal commerce of the United States is growing rapidly and is certain to increase with accelerating speed. The demands for transportation facilities are expanding so swiftly as to make it apparent that the products of our farms, mines, forests, and factories cannot secure ready and economical transportation unless at least the larger water routes of the country are adapted to the needs of commerce.

2. The necessity for the development of our waterways is emphasized by the fact that any considerable future reductions in the costs of rail transportation are improbable. Indeed, for reasons that have already been stated in this paper, the service of American railroads may be expected to be developed in the future more and more with reference to handling commodities expeditiously and in small units. That is what is taking place in other countries; there is no reason to suppose that our experience will differ greatly from theirs. The economy of employing both railroads and waterways for the performance of the transportation services becomes greater in every country with the increase in population and the development and specialization of industry.

3. American waterways will, in the years to come, be utilized more for navigation, because we are certain, sooner or later, to conserve and use the entire water resources of the country simultaneously not only for navigation, but also for irrigation, for water-power, and for supplying our urban populations with pure water. Moreover, the growing necessity for controlling our streams so as to make possible the reclamation of our vast areas of reclaimable lands will tend to hasten the time when our principal waterways will be so regulated as to be serviceable for navigation.

In the past we have permitted the reckless destruction of our forests, and it has been our practice to let the streams spread their floods destructively over their valleys and hurry their surplus water to the sea. We cannot long afford to be so wasteful of one of our greatest natural resources. We ought to, and we shall, reforest our wild mountain areas, we shall hold back the flood waters to irrigate our arid lands, to turn the wheels of industry, to maintain the channels of navigation, to give the towns and cities their water-supply, and to equalize the seasonal flow of our rivers so that neither flood nor low water shall be a recurring menace to life and property.



"PAYMENT CONDITIONAL UPON SUCCESS"

SMOKY FIREPLACES REMEDIED

Twenty years' experience in dealing with the above trouble. Thoroughly trained workmen employed. In most cases work can be done without defacing decorated walls and with little inconvenience to the household

Examinations and estimates without charge within 500 miles of New York
Contracts entered into with the understanding that charges are for results

The following are a few of the many thousands who have availed themselves of my services:

Grover Cleveland, Princeton, N. J.
 W. A. Slater, Washington, D. C.
 Mrs. John Hay, Washington, D. C.
 Princeton University, Princeton, N. J.
 Senator Aldrich, Providence, R. I.
 Clement B. Newbold, Jenkintown, Pa.
 University Club, New York
 Union League Club, New York

Hon. Whitelaw Reid
 Hon. Joseph H. Choate
 J. Pierpont Morgan
 John D. Rockefeller, Jr.
 Col. John J. Astor
 George J. Gould
 Henry Clews
 Joseph Pulitzer

U. S. Government for:—
 White House, Washington, D. C.
 U. S. Naval Academy, Annapolis, Md
 McKim, Mead & White
 Carrere & Hastings
 Hunt & Hunt
 Ernest Flagg
 Howell & Stokes

Architects

JOHN WHITLEY

Engineer and Contractor

215 Fulton Street, Brooklyn, New York



Before Treatment of Cavities

Don't Let the Old Trees Die

Young trees may not equal the old ones in size and beauty during your life. Insecticides, fertilizers, bolting, prunin', tree surgery, and cavity-filling are only part of the practical means of restoring sick and dying trees to health and beauty. We examine estates, suggest improvements in planting new stock, and direct the work of saving diseased trees and shrubs. Trained assistants equipped with proper tools are furnished when desired. A booklet entitled "The Care of Trees" is sent on request.

H. L. FROST & CO., The Pioneer Tree Specialists
 Landscape Foresters and Entomologists

Arlington, Mass.

White Plains, N. Y.



After Treatment of Cavities

Congressional Information Bureau

CLAUDE N. BENNETT, Manager

Attends to business before Congress, the Courts, Patent Office, Interstate Commerce Commission, and all other Departments of the Government at Washington.

Supplies any desired information from the Capital, furnishes advices concerning matters pending in Congress, the Courts or the Departments, and transacts business at Washington for clients anywhere in the world.

Conducts library research along any designated lines.

Has a Legal Department that prepares briefs for lawyers or other clients.

Usefulness demonstrated by ten years' successful experience.

Congressional Information Bureau

BOND BUILDING

WASHINGTON, D. C.

HOW TO RUN AN AUTO



Are You Interested in Automobiles?

If you are, an early purchase of "HOMANS' SELF PROPELLED VEHICLES" will prove a good investment.

This work is now the accepted standard on the practical care and management of motor cars—explaining the principles of construction and operation in a clear and helpful way, and fully illustrated with many diagrams and drawings.

The presentation of subjects has been determined by consideration of the needs of the man behind the wheel. It is clear and concise in its treatment, and comprehensible to the most inexperienced automobilist, at the same time it is so thorough that the expert will learn much from its pages.

Contains 608 pages, over 400 diagrams and illustrations, printed on fine paper, size 5 3/4 x 8 1/2 inches, with generously good binding. Highly endorsed.

No money in advance required; sign and return
 Theo. Audel & Co., 63 Fifth Avenue, New York
 I'm truly mail me copy "Homans' Auto" and if
 found satisfactory I will immediately remit
 \$2 or return book to you.
 Name.....
 Address.....
 Date.....
 For.....

This good book will be sent to any address in the world, postpaid, upon receipt of two dollars, or if desired, will be sent on approval to be paid for after examination.

GOERZ LENSES

are made by skilled workmen according to latest scientific methods. Every lens is as near perfection as a photographic lens can be. The Stigmatism is completely corrected, and at full opening every lens will cover sharply to the very edges the size of plate for which it is intended.

No other lens has such a world-wide reputation; but it is not for its reputation that you buy a "GOERZ"—it is for the satisfaction of having a lens that knows no limitations, that will do all the work of other lenses *better* and then do work that could not be done *at all* with them. This is why you should equip your camera or kodak with a Goerz Lens.



WRITE DEPT. 3 FOR OUR LENS CATALOGUE, WHICH ALSO DESCRIBES OUR FULL LINE OF FIELD GLASSES, XL SHUTTER, ANSCHUTZ CAMERA AND OTHER ARTICLES OF OUR MANUFACTURE.

Our catalogue "de luxe," a most complete book of information on lenses, is sent for nine cents to cover postage.

Our lenses may be obtained through all good photo dealers or direct.

C. H. Goerz American Optical Company

52 Union Square, E., New York

Heyworth Bldg., Chicago

Second Edition, Revised, with Additions

Snow—The Principal Species of Wood. Their Characteristic Properties

By CHARLES H. SNOW

Dean of the School of Applied Science, New York University

Large 8vo, xi+203 pages, figures in the text, 37 full-page half-tones. Cloth, \$3.50

Circular giving complete table of contents and sample pages mailed on request, or the book may be seen at the leading book stores or dealers in architectural supplies

Order through your bookseller, or copies will be forwarded postpaid by the publishers on receipt of the retail price.

JOHN WILEY & SONS
43 and 45 East 19th St., New York City

This Solar can be used in hazy weather, when other Solars are useless. Used by the U. S. General Land Office.



Specifications

Needle $3\frac{1}{2}$ inches long. Graduations $4\frac{1}{2}$ inches long, reading minutes. Power of telescope 20 (with splendid definition, good light, and large field). Variation plate. Level to telescope, clamp and opposing screws. Vertical arc. Fixed Stadiaairs. Extension Tripod. Solar Attachment on side of standards.

Price Complete, \$300

Telegraph and Code Word, Mountsolar

Illustrated Catalogue Upon Application

YOUNG & SONS Philadelphia

ADDITIONAL REAL ESTATE ADVERTISEMENTS

Continued from First Advertising Section

VIRGINIA

TWO TIMBER BARGAINS

No. 45.—14,000 acres, iron and timber land, in Bath and Rockwell Counties, Va. Second-growth timber, some merchantable; land lies well and is good grazing land for sheep or cattle. \$1.25 per acre.

No. 46.—41,576 acres in Bath, Highland and Augusta Counties, Va. *Best virgin tract of white oak now standing in Virginia.* All easy logging proposition, 10 to 12 miles from C. & O. Ry. Road would have a water grade on Mill Creek—all easy grades. 160,000,000 feet saw timber, 75 per cent. of which is white oak of finest quality, besides tan bark, ties and other timber. Owner would consider offer of \$8.00 per acre.

Prospective Investors, Look This Over!

J. W. Guinn, Goshen, Virginia
Timber Lands, Farms and Summer Resorts

OHIO

Farms and Timberlands

No. 4.—200 acres near Akron, Ohio. 25 acres of virgin hardwood timber. Soil gravelly loam. Large country house, hardwood finished; four other buildings, all in excellent condition, and two barns. Price \$55.00 per acre.

No. 16.—50 acres of good timber, white and red oak (first growth). Two miles from station. *Terms reasonable. Send for full list.*

F. A. Leeser, Akron, Ohio

PENNSYLVANIA

Beautiful Summer Home
On Trolley Line

110 acres rich soil in high state of cultivation; 9 room house, 2 barns and necessary outbuildings, some good timber, nice orchard, fine stream of water through farm. This farm has never been rented. Owing to the death is offered for sale. It fronts on Meadville Conneaut Lake and Linesville trolley line. About 1½ miles from Exposition Park, Conneaut Lake, and ¼ mile from station on Bessemer R. R.; 1 mile to high school, church, and store. Price, including crops, pair horses, a number of cattle, all tools and equipments, \$6,500. Best bargain offered in Crawford County. For further information, apply to

VET. L. BROWN CO., Timber, Coal and Farm Lands
Rooms 207-8 331 Fourth Ave., Pittsburg, Pa.

COLORADO

COME TO



COLORADO

Big Profits In Crops

Don't wait. Here's a big opportunity to own land at a little price. Mighty few such good chances left. Get busy now. Write us for our brand new booklet, "The New Colorado," full of live facts, figures, map, etc., about that great fertile tract in Eastern Colorado, the 35,000 acre Bijou Ranch Lands. They need no irrigation, 65 miles from Denver, 42 miles from Colorado Springs. Rainfall sufficient to raise wheat 35 bushels to acre, speltz 32 bushels, potatoes 200 bushels, corn 35 bushels, oats 79 bushels, etc. Alfalfa four cuttings, 5 tons to acre. (See cut of stacks above.) Glorious climate; healthful and invigorating. 80 acres will earn you \$1000 in twelve months. Small cash payment needful—say \$2 to \$3 per acre—balance in five equal annual installments. Write for the book today. "Hurry to Colorado." Address, Dept. 17.



The Farmers Land and Loan Company,
145 La Salle St., Chicago, Ill.

WEST VIRGINIA

A. G. WYNKOOP

Fine farms, fine orchards, ore, coal and timber lands for sale

CHARLES TOWN, JEFFERSON CO., W. VA.

CONSULT CONSERVATION'S Information Bureau if in search of advice as to the purchase of timber lands or farm lands advertised in this magazine. Our services are *free* to our readers.

VIRGINIA

Tall Timber *and* Grazing Farms

I HAVE for sale a 2,300 acre tract of white oak timber (every acre of which is well timbered) four miles from C. & O. Railroad. This is the prettiest, tallest, straightest, biggest and healthiest white oak that can be found in the United States.



It lies comparatively level, all slopes very gently in one direction, thus making it one of the cheapest logging propositions in the country. This tract will cut 12 M feet to the acre and will run 85 per cent. white oak, the balance being poplar and hickory of the finest quality.

For further particulars, address

T. M. GATHRIGHT

*Coal, Iron Ore and
Timber Land*

COVINGTON, VIRGINIA

OKLAHOMA

Oklahoma Lands and Properties

Farm Lands, Timber Lands, Coal Lands, Oil Lands

Oklahoma was opened to settlement 19 years ago, and now has ninety-five towns and cities with populations of 1,000 to 40,000.

Oklahoma Guarantees Bank Deposits

Oklahoma has 10,000,000 acres of bottom lands—virgin soil.

Oklahoma has the largest oil and gas field in America.

New country seat with 70 acres; adjoins growing young town; improvements cost \$10,000.

Splendid two-story brick block near depot; pays 15% on its price.

Write for wants and other information

PORUM REAL ESTATE & LOAN CO.

PORUM, OKLA.

The World's Greatest Poultry Paper

THE FEATHER

Only 50 cents a year

THE FEATHER'S LIBRARY

No. 1. **DISEASES OF POULTRY.** By D. E. Salmon, D.V.M. Fully illustrated. Paper, 50 cents; cloth, \$1.

No. 2. **THE FEATHER'S UP-TO-DATE POULTRY HOUSE.** Paper, 25 cents.

No. 3. **THE AMERICAN FANCIER'S POULTRY BOOK.** Profusely illustrated. By Geo. E. Howard. Paper, 50 cents; cloth, \$1.

No. 4. **PLYMOUTH ROCKS.** Colored illustrations. By T. F. McGrew. Paper, 50 cents; cloth, \$1.

No. 5. **WYANDOTES.** Colored illustrations. By T. F. McGrew. Paper, 50 cents; cloth, \$1.

No. 6. **POCKET MONEY POULTRY.** By Myra V. Norys. Paper, 50 cents; cloth, \$1.

No. 7. **THE EGG QUESTION SOLVED.** By T. F. McGrew. Paper, 25 cents; cloth, 50 cents.

No. 8. **HOW TO GROW CHICKS.** By T. F. McGrew. Paper, 25 cents; cloth, 50 cents.

No. 9. **THE HOMING PIGEON.** Illustrated. Paper, 25 cents; cloth, 50 cents.

No. 10. **THE FEATHER'S PRACTICAL PIGEON BOOK.** By J. C. Long. Paper, 50 cents; cloth, \$1.

No. 11. **MONEY IN SQUABS.** Profusely illustrated. By J. C. Long and G. H. Brinton. Paper, 50 cents; cloth, \$1.

No. 12. **THE FEATHER'S PRACTICAL SQUAB BOOK.** By W. E. Rice. Paper, 50 cents; cloth, \$1.

No. 13. **PERFECTED POULTRY OF AMERICA.** By T. F. McGrew and Geo. E. Howard. Illustrated by Louis P. Graham. Cloth, \$2.50.

SPECIAL OFFER

Our latest book, **THE PERFECTED POULTRY OF AMERICA**, and **THE FEATHER** for one year for the price of the book alone, \$2.50.

THE HOWARD PUBLISHING CO.

714 Twelfth Street Northwest

Washington, D. C.

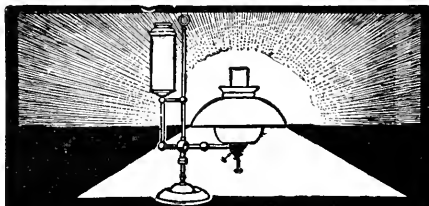

**THE "BEST" LIGHT
Outshines the Sun.**

It's pure white light makes day of night. Costs less than kerosene; six times more powerful than electricity. Examined, tested and permitted by underwriters' association. CATALOG FREE.

NO DIRT -- NO WICK -- NO SMOKE -- NO SMELL
Agents wanted. Exclusive territory, good commission paid
THE BEST LIGHT COMPANY,
Sole Owners of Original Patents. 242 E. 5th St., Canton, Ohio.



MEXICAN PECAN-OKAS CANDY

Registered U. S. Patent Office

A new candy—original with us—wholesome, satisfying. Made of freshly shelled Pecan Nuts and carefully blended sugars. Rich in nutriment—sustaining—healthful. Pecan Nuts contain practically all of the important nutritive elements. Our blend of sugar adds the necessary properties to make a perfect food. We will send you a box (nearly 2 pounds) any place in the world, all charges prepaid, for a dollar bill mailed at our risk.

BROWNLEY'S, Dept. K, 1203-5 G St. Washington, D. C., U. S. A.

**Philippine Bureau of
Forestry**

WANTED—Two foresters with field experience. Minimum salary, \$1,600. Travel expenses allowed, also liberal leave privileges.

At least seven months' interesting field work per year.

For information concerning travel allowance to Manila, Civil Service rules, health conditions; in fact any information in regard to the Islands, apply to the Bureau of Insular Affairs, War Department, Washington, D. C.



**GET
THIS**

RIFE

Hydraulic Ram

if there is a stream, spring or pond near by and have running water wherever you want it.

PUMPS WATER WITH WATER

works continuously without attention. No expense for power, nothing to get out of order. Raises water 30 feet for each foot of fall. For Home, Farm, Irrigation, and all purposes. Over 7,000 in use. Free Plans and Estimates furnished. Write today.

RIFE ENGINE CO., 2172 Trinity Bldg., NEW YORK

To Readers of Conservation

WE ARE completely overhauling, correcting and revising the mailing list of this magazine. In the course of this work we have found several errors—a very natural condition when the rapid growth of our circulation is taken into consideration. In order to have the list absolutely accurate, we ask every reader, subscriber and member of the American Forestry Association to advise us if his or her magazine is properly addressed. Changes of address may have been overlooked; "stop" orders may have escaped us. If there is anything wrong, please let us know immediately. The prompt attention of all readers is urged. Address:

CONSERVATION

Circulation Department

Washington, D. C.

Hardy Shrubbery, Trees, and Specimen Evergreens

In Small and Large Sizes. Our Prices Are the Lowest for Quality Offered. Estimates Given on All Landscape Work. Write for Prices.

W. F. McCORD CO., Nurserymen

Tarrytown, N. Y.

F. R. MEIER CONSULTING FORESTER

1 Broadway, New York

TIMBER ESTIMATES, WORKING PLANS, FOREST APPRAISEMENT, TREE PLANTING, TREE SURGERY

Advice on profitable handling of woodlots, forest tracts, beautifying country estates. Work supervised. Seventeen years experience in the United States.

Read "Irrigation in the United States," by Frederick Haynes Newell, Director of the Reclamation Service. Price, \$2, postpaid to any address. Address "Conservation," Washington, D. C.

FORESTRY SCHOOLS

can find no better medium through which to make their announcements than

Conservation

It reaches a class of Readers that is reached by no other Publication.

It is *the* Magazine of authority in its special field.

For Advertising Rates, etc., address

Advertising Manager

CONSERVATION

1417 G St. N. W.

Room C

Washington, D. C.

The PENNSYLVANIA STATE COLLEGE

A thorough and practical undergraduate course in technical forestry, preparing men for all lines of professional and applied forestry.

Special attention is paid to practical field work in surveying, mapping, and forest measurements. One of the largest of the State Forest Reserves is within a short walk of the college.

For information regarding entrance requirements, expenses, etc., address

Department of Forestry

State College, Penna.

POWDER POINT SCHOOL, Duxbury, Mass.

Preparatory Course in

FORESTRY

Leading to Biltmore and College Course in the subject. It requires hard, earnest application, and develops appreciation of nature and powers of leadership.

(M. I. T.)

F. B. KNAPP, S. B.

ORCHIDS

ORCHIDS

We are the largest Orchid Growers in the United States.

Our Illustrated and Descriptive Catalogue of Orchids is now ready and may be had on application.

Orchid Growers and Importers

LAGER & HURRELL
SUMMIT, N. J.

IMPORTANT BOOKS ON FORESTRY

PRINCIPLES AND PRACTICE OF FORESTRY

FOREST MENSURATION. By HENRY SOLON GRAVES, M.A. A complete text book of this important subject and the first written for American Foresters. It deals with the determination of the volume of log, tree, or stand, and with the study of increments and yields. Price, \$4.00

ECONOMICS OF FORESTRY, THE. By B. E. FERNOW. This volume treats of forests and forestry from the standpoint of political economy, and is designed to furnish a trustworthy basis for formulating public policy. Price, \$1.50

FIRST BOOK OF FORESTRY, A. By FILIBERT BOTT. An outline of the general principles of forestry, written in simple, non-technical language, designed particularly for the beginner. Price, \$1.10

PRACTICAL FORESTRY, FOR BEGINNERS IN FORESTRY, AGRICULTURAL STUDENTS, AND WOODLAND OWNERS. By JOHN GIFFORD. A good general description of the principles of forestry with enough technical information to prepare the beginner. Price, \$1.10

HISTORY OF THE LUMBER INDUSTRY OF AMERICA. By J. E. DEFEBAUGH. The first authoritative work of its kind yet issued, and one which will commend itself alike to the timber owner, lumberman, lumber manufacturer, or merchant, or student of economics. In four volumes bound in half leather. \$5.00 per volume

FOREST PLANTING. By H. NICHOLAS JARCHOW. An illustrated treatise on methods and means of restoring denuded woodland. Price, \$1.50

FORESTRY. (Schwappach.) An English translation of "Forstwissenschaft." Price, 70c

HEDGES, WINDBREAKS, SHELTERS, AND LIVE FENCES. By E. P. POWELL. A treatise on the planting, growth and management of hedges with information concerning windbreaks and shelters. Price, 70c

NORTH AMERICAN FORESTS AND FORESTRY. By ERNEST BRUNCKEN. This volume, expository in its character, is written in a style intended for the general reader, to whom it should convey a good idea of our forests forestry. Price, \$2.00

PRACTICAL FORESTRY. By ANDREW S. FULLER. A treatise on the propagation, planting and cultivation, with descriptions and the botanical and popular names of all the indigenous trees of the United States, and notes on a large number of the most valuable exotic species. Price, \$1.50

PRINCIPLES OF AMERICAN FORESTRY. By SAMUEL B. GREEN. Prepared especially for students in elementary forestry and for the general reader who wishes to secure a general idea of forestry in North America. Price, \$1.50

SEASIDE PLANTING OF TREES AND SHRUBS. By ALFRED GAUT. Illustrated from photographs by FRANK SUTCLIFFE. This is a new volume in the English Country Life Library. Advice regarding selection and management to get satisfactory effects under adverse influence of closeness to seashore. Price, \$1.75

FOREST MANAGEMENT. By C. A. SCHENCK. Describes methods here and abroad to bring the most profit from all investments made in woodlands. Price, \$1.25

FOREST MENSURATION. By C. A. SCHENCK. Treats conditions in U. S. from mathematical and practical standpoint. Price, \$1.25

FOREST UTILIZATION. By C. A. SCHENCK. First treatise on this in U. S. Covers logging, lumbering, sawmilling, cooperage, paper-making, and description of all industries obtaining raw material from American forests. Price, \$1.25

BILTMORE LECTURES ON SYLVICULTURE. By C. A. SCHENCK. Written from author's long experience as forester of the Biltmore estate, where silviculture has been practiced on a larger scale for a longer time than anywhere else in U. S., and where results become more apparent from year to year. Price, \$2.50

FOREST POLICY. By C. A. SCHENCK. (Second part.) Describes the various States of the Union under following heads: Area; physiography; distribution of forests; forest ownership; use of the forest; forestry movement; forest laws; forest reservation; irrigation. Price, \$1.25

PROFESSION OF FORESTRY, THE. By GIFFORD PINCHOT. A pamphlet containing an address on that subject by Mr. Gifford Pinchot; also an address by Mr. Overton W. Price, on "Study in Europe for American Forest Students," and a list of reference publications for students. Price, 25c

FOREIGN IMPORTATIONS

ENGLISH ESTATE FORESTRY. By A. C. FORBES. An authoritative volume on English forest methods from the pen of a well known forester, that should prove of interest to Americans. Price, \$3.50

FORSTWISSENSCHAFT. (Schwappach.) Price, 60c

MANUAL OF FORESTRY. (Schlich.) Five volumes, complete, or separately, as follows (price, complete, \$18.80):

Vol. I. "FORESTRY POLICY IN THE BRITISH EMPIRE." Price, \$2.40

Vol. II. "SYLVICULTURE." Price, \$3.20

Vol. III. "FOREST MANAGEMENT." Price, \$3.60

Vol. IV. "FOREST PROTECTION." Price, \$4.80

Vol. V. "FOREST UTILIZATION." Price, \$4.80

This is perhaps the most authoritative work that has been issued on the technical side of forestry, translated from the German.

WOOD. By G. S. BOULGER. An important new book for arboriculturists and forestry students. A manual of the natural history and industrial applications of the timbers of commerce. Cloth. 82 Illustrations. Price, \$4.20

FAMILIAR TREES. By Prof. G. S. BOULGER. Written by an eminent botanical authority, yet couched in language easily understood. The coloured plates are the work of celebrated artists, and are truthful and trustworthy in every respect. A special feature is the series of photo-micrographic illustrations of sections of woods. Three volumes. Price, per volume, \$1.50

DENDROLOGY, BOTANY, AND IDENTIFICATION OF SPECIES

MANUAL OF THE TREES OF NORTH AMERICA (exclusive of Mexico). By CHARLES SPRAGUE SARGENT. A volume that presents in convenient form and with excellent illustrations, authoritative information concerning the trees of North America. It is written in a manner that enables the reader to readily find to what family or species any particular tree belongs. Price, \$6.00

AMERICAN WOODS. By ROMEYN B. HOUGH. A new departure in the publication of an authoritative work illustrated with actual wood sections of the various species described. Three are given of each, viz.: radial, transverse, and tangential. Issued in ten parts, per part Price, \$5.00

HANDBOOK OF THE TREES OF THE NORTHERN U. S. AND CANADA, EAST OF THE ROCKY MOUNTAINS. By ROMEYN B. HOUGH. Pictorial description, two pages to each species; photo-engravings of trunk, leaves, flowers or fruit, section of wood, and map of distribution, with botanical description, and brief other information. Price, in buckram, \$8.00; in half morocco, \$10.00

FLORA OF THE SOUTHERN STATES. CHAPMAN. This is an excellent key to the flora of the South, complete and accurate in its scope. Price, \$4.00

GETTING ACQUAINTED WITH THE TREES. By J. HORACE MCFARLAND. A handsome volume, copiously illustrated, and with facts accurately presented in an entertaining way. Price, \$1.75

HOW PLANTS GROW. By ASA GRAY. An understanding of the way in which a tree grows is of prime importance to the forester, and the matter here presented is accurate and authoritative. Price, \$1.00

PRINCIPAL SPECIES OF WOOD; THEIR CHARACTERISTIC PROPERTIES. By CHARLES HENRY SNOW. No attempt is made to give exhaustive descriptions of species, but the author presents a mass of information designed for the use and instruction of woodworkers, etc., in a popular style. A host of concise information is brought under each head, and the work is a valuable one. Price, \$3.50

*Important Books on Forestry and Irrigation for sale by CONSERVATION
1417 G Street N. W., Washington, D. C.*

MANUAL OF BOTANY. By ASA GRAY. A key to the flora of the northeastern states, and the most authoritative publication of its nature. *Price, \$1.62; field edition, \$2.00*

TREES OF NEW ENGLAND. By L. L. DAME and HENRY BROOKS. This book is a small volume which can be easily put in the pocket and carried in the woods, and at the same time is the best guide to the identification of our New England trees of any of the smaller books yet published. *Price, \$1.50*

TREES AND SHRUBS. By C. S. SARGENT. The most thorough and authoritative publication yet issued, and a standard work. The matter is issued in parts, of which there are three already published. *Price, per part, \$5.00*

TREES, SHRUBS, AND VINES OF THE NORTHEASTERN UNITED STATES. By H. E. PARKHURST. In this book the author describes the trees, shrubs, and vines of the northeastern United States in a popular way, the book being designed especially for persons who have never studied botany. To these it will appeal as a valuable guide to a familiarity with the salient characteristics of trees, shrubs, and vines. *Price, \$1.50*

TREES. A handbook of forest botany for the woodlands and the laboratory. By H. MARSHALL WARD. Vol. I, Buds and twigs. Vol. II, Leaves. Vol. III, Flowers and inflorescences. Three volumes to be added, on Fruits and seeds, Seedlings, Habit and conformation of the tree as a whole. *Price, per volume, \$1.50*

OUR NATIONAL PARKS. By JOHN MUIR. If you want to learn about the glaciers, mountain peaks, canyons, and great waterfalls of the West; of the habits of animals from the squirrel to the moose; plant life from the big trees to the wild flowers—in fact be brought face to face with nature's works, this is the book. *Price, \$1.85*

TREES AND SHRUBS OF MASSACHUSETTS. EMERSON. Two volumes. Plain cloth edition has 148 plates. The colored edition has 36 of these in colors. *Price, plain, \$12.00 Price, colored, \$18.00*

THE EARTH AS MODIFIED BY HUMAN ACTION. By G. P. MARSH. A Revision of Man and Nature. Describes changes in the face of the earth caused by man, including desolation of various countries, once thickly inhabited, by removal of forests. Shows importance of maintaining natural balance of forces. *Price, \$3.50*

THE LONGLEAF PINE IN VIRGIN FOREST. A Silvical Study. By G. FREDERICK SCHWARZ. This is a study of the life history of this important forest tree. Intended primarily for foresters and forest students; also for owners and managers of pine timber lands. Deals with the preference or dislike of the species for particular conditions of soil, climate, and environment. Illustrations and six tables. *Price, \$1.25*

THE SPROUT FORESTS OF THE HOUSATONIC VALLEY TO CONNECTICUT. By G. F. SCHWARZ. Illustrated study of forests repeatedly cut over. *Price, 35c*

IMPORTATIONS

BEAUTIFUL RARE TREES AND PLANTS. By the EARL OF ANNESLEY. A description of the rarer English trees, shrubs, and vines, illustrated copiously. *Price, \$12.00*

FORESTS OF UPPER INDIA AND THEIR INHABITANTS. By THOMAS W. WEBBER. This volume is an account of the author's life in India during the period shortly after 1857. It contains a vivid description of the country, its people, customs, etc., with some description of its forests and timber wealth. *Price, \$5.00*

PARTICULAR SPECIES AND LOCALITIES

MOUNTAINS OF CALIFORNIA, THE. By JOHN MUIR. No other person is so well fitted to write of the mountains of California as John Muir, and the volume presented here describes not only the mountains themselves, but the trees that clothe them and the wild life which they harbor. *Price, \$1.85*

BOOKS ON IRRIGATION AND DRAINAGE

IRRIGATION IN THE UNITED STATES. By F. H. NEWELL. The most authoritative and complete work on the subject which has yet been published, by the head of the Government's irrigation work. *Price, \$2.00*

IRRIGATION FARMING. By L. M. WILCOX. A newly revised edition of one of the standard works on irrigation. The principal chapters treat very fully of irrigation, its application, etc., and the volume is profusely illustrated. *Cloth, \$2.00*

IRRIGATION FOR FARM, GARDEN AND ORCHARD. By HENRY STEWART. This work is offered to those American farmers and other cultivators of the soil who, from painful experience, can readily appreciate the losses which result from the scarcity of water at critical periods. *Price, \$1.00*

IRRIGATION AND DRAINAGE. By F. H. KING. While most of the existing books on these subjects have been written from engineering or legal standpoints, this one presents in a broad, yet specific way the fundamental principles which underlie the methods of culture by irrigation and drainage. *Price, \$1.50*

IRRIGATION INSTITUTIONS. By ELWOOD MEAD. A discussion of the economic and legal questions created by the growth of irrigated agriculture in the West, by the Chief of Irrigation and Drainage Investigations of the Department of Agriculture. *Price, \$1.25*

LAND DRAINAGE. By MANLY MILES. A handbook for farmers on the principles and practice of draining, giving the results of his extended experience in laying tile drains. *Price, \$1.00*

LAND OF LITTLE RAIN, THE. By MRS. MARY AUSTIN. A nature book of the highest type. The volume is made up of a series of sketches of the human, animal, and plant life found in the region of the Mohave desert, Death Valley, and the Sierras, much of which the average person is likely to consider almost devoid of living things. *Price, \$2.00*

IRRIGATION ENGINEERING AND CONSTRUCTIVE WORK

DESIGN AND CONSTRUCTION OF DAMS. By EDWARD WEGMANN. This volume includes an authoritative discussion of the constructive work involved and the principal forms of construction. Masonry, rock-fill, and timber dams are discussed extensively. *Price, \$6.00*

IMPROVEMENT OF RIVERS. By B. F. THOMAS and D. A. WATT. This volume is a treatise on the methods employed for improving streams for open navigation and for navigation by means of locks and dams. *Price, \$6.50*

IRRIGATION ENGINEERING. By HERBERT M. WILSON. This is the fourth edition of Mr. Wilson's popular work, and the revision and enlargement which it has undergone, places it at the forefront of text books on the subject for American students. *Price, \$4.00*

ENGINEERING FOR LAND DRAINAGE. By C. G. ELLIOTT. A manual for laying out and constructing drains for the improvement of agricultural lands. *Price, \$1.50*

RESERVOIRS FOR IRRIGATION, WATERPOWER, AND DOMESTIC WATER-SUPPLY. By JAMES DIX SCHUYLER. An account of various types of dams and the methods and plans of their construction, together with a discussion of the available water-supply for irrigation in various sections of arid America, distribution, application, and use of water; the rainfall, runoff, and evaporation from reservoirs, and effect of silt, etc. *Price, \$5.00*

WATER SUPPLY ENGINEERING. By A. PRESCOTT FOLWELL. A treatise on the designing, construction and maintenance of water-supply systems, both city and irrigation. *Price, \$4.00*

These books sent prepaid upon receipt of price indicated, by CONSERVATION

WATER POWER. By JOSEPH P. FRIZELL. An outline of the development and application of the energy of flowing water. Price, \$5.00

CONCRETE, PLAIN AND REINFORCED. By FREDERICK W. TAYLOR and SANFORD E. THOMPSON. Designed for practicing engineers and contractors; text and reference book for students. Discusses materials, processes, and applications of concrete in construction and specifications. Price, \$5.00

HYDRAULICS. By MANSFIELD MERRIMAN. Purpose of book is to keep abreast of modern progress, and present subject with conciseness and clearness. Gives general principles and discusses flow of water through various kinds of openings and channels. Historical notes and references. Price, \$5.00

FOUNDATIONS. By W. M. PATTON. A practical treatise explaining fully the principles involved. Numerous descriptions of important modern structures are given in sufficient detail. Includes articles on use of concrete in foundations. Price, \$5.00

MASONRY CONSTRUCTION. By IRA O. BAKER. Contains results of a great number of experiments, and a large amount of practical data on cost of masonry, pile driving, foundations, culverts, etc., and 97 tables to facilitate estimating. Price, \$5.00

REINFORCED CONCRETE. By ALBERT W. BUEL and CHARLES S. HILL. A treatise for designing and constructing engineers, governed by American practice and conditions. Theoretical discussions omitted, and replaced by practical working formulas, examples of representative structures, and records of practice. Price, \$5.00

BOOKS ON RELATED SUBJECTS

UTILIZATION OF WOOD WASTE BY DISTILLATION. By WALTER B. HARPER. An important treatise on a subject regarding which the interest is great and the information scarce. Is intended to aid in the establishment and conduct of wood distilling enterprises on a business basis. Price, \$3.00

HANDBOOK OF TIMBER PRESERVATION. By SAMUEL M. ROWE. Intended as a complete practical guide for the operator of a preservation plant, with hints on construction thereof. Price, \$4.00

IN FOREST LAND. By DOUGLAS MALLOCH. The humor, sentiment, and philosophy of the lumber business interpreted by the "Lumberman Poet." A kind of touch with the great outdoors that few books contain. Illustrated in tint, bound in silk cloth and gold stamped. Ideal for gift or library. Price, \$1.25

THE GARDEN

ROSES AND HOW TO GROW THEM. By many Experts. In text, practical; in subject and quality of illustrations, beautiful. Price, \$1.20

FERNS AND HOW TO GROW THEM. By G. A. WOOLSON. The growing of hardy ferns, both in the garden and indoors. Price, \$1.20

LAWNS AND HOW TO MAKE THEM. By LEONARD BARON. For the first time the subject of lawn seed mixtures is set forth and explained. 32 photographs. Price, \$1.20

HOW TO MAKE SCHOOL GARDENS. By H. D. HEMENWAY. This suggestive little book is a practical manual of school gardening for both teacher and pupil, and supplies the first adequate work of the sort in this country. There are to-day a hundred thousand school gardens in Europe, and the progress of the recent movement in America has been most rapid. This volume is based on actual experience (the author is an authority and director of the Hartford School of Horticulture). Illustrations, 10. Price, \$1.10

HOW TO MAKE A FRUIT GARDEN. By S. W. FLETCHER. An eminently practical work on the subject of fruits for the home. With 182 photographic illustrations by the author. Price, \$2.25

HOW TO MAKE A FLOWER GARDEN. A charming and a practical book by experts on every branch of the subject. More than 200 beautiful photographs. Price, \$1.75

HOW TO MAKE A VEGETABLE GARDEN. By EDITH L. FULLERTON. The only adequate book on the home vegetable garden. 250 photographs by H. B. Fullerton. Price, \$2.20

ART AND CRAFT OF GARDEN MAKING. By THOMAS H. MAWSON. Third edition of this standard; out of print for a year, and now reissued in revised form. Over 100 plans and details of gardens. Methods employed by successful designers carefully analyzed. Characteristic sites in typical districts described and pictured. Price, \$15.00

THE HOME AND FARM

THE COUNTRY HOUSE. By CHARLES EDW. HOOPER. A Practical manual of house building, absolutely invaluable to every one with a country place. It covers every branch of the subject in detail and treats of the garden and its furnishings in connection with the dwelling. 380 photographs and plans. Price, \$3.50

THREE ACRES AND LIBERTY. By BOLTON HALL. Description of what can be accomplished on a small place in the way of gardening, home-making, and addition to financial resources. Were it not for the unimpeachable authorities quoted, its statements as to the possibilities of the "Little Lands" for a living would seem fanciful. Price, \$1.85

THE MAKING OF A COUNTRY HOME. By J. P. MOWBRAY ("J. P. M."). This delightful story showed its universal appeal when published serially, and the volume amply carries out the intention of the author. Besides its practical interest for the thousands of city dwellers who have dreamed of having a country home, the story is one of such reality, humor, and interest as to ensure it the widest circulation in book form. Elaborately decorated. \$1.65

THE FIRST BOOK OF FARMING. By CHARLES L. GOODRICH. No one interested in farming, old or young, can fail to appreciate this book, for it really gives the fundamental knowledge of how to conduct a farm with the least expense and the largest return. There are 63 full pages of helpful illustrations. The price is extremely low for a work of such value. 63 pages of photographs. Price, \$1.10

NATURE BOOKS

AMERICAN FOOD AND GAME FISHES. By DAVID STARR JORDAN and B. W. EVERMANN. Fills a long-felt need in popular scientific works, being a full account of the life-histories and methods of capture of North American food and game fishes. The only book in existence which will enable the amateur readily to identify species new to him. With 10 lithographed color plates, 100 photographs of live fish in the water, and 200 text cuts. Price, \$4.40

NATURE BIOGRAPHIES. By CLARENCE M. WEED. This volume is a sort of personal acquaintance with the lives of the more common butterflies, moths, grasshoppers, flies, and so on, the sort of fascinating details of these insect existences which make the reader want to go out and study these every-day marvels for himself. 150 photographic illustrations. Price, \$1.50

THE BROOK BOOK. By MARY ROGERS MILLER. A brook is one of the most living and companionable features of the landscape, and few people, even the most ardent nature lovers, realize what an endlessly interesting study its changes and its throbbing life afford. It is a fascinating subject which the author (well known as a teacher, lecturer, and writer connected with the Nature Study Bureau at Cornell) handles with much ability. 16 photographs. Price, \$1.50

OUTDOORS. A Book of the Woods, Fields, and Marshlands. By ERNEST MCGAFFEY. Papers on out of doors, showing a love of nature and keenness of observation and power and beauty of description rarely surpassed. Price, \$1.25

NATURE AND THE CAMERA. By A. RADCLIFFE DUGMORE. Mr. Dugmore is an expert in the new movement of photographing live birds, animals, fish, flowers, etc. His works brought him so many requests for information, that he has set down here a full and detailed account of his methods. From the choice of a camera to questions of lighting, and to the problem of "snapping" shy birds and animals in their native haunts, every step is explained so simply as to be easily comprehended, even by the beginner. 53 photographic illustrations. Price, \$1.50

These books sent prepaid upon receipt of price indicated, by CONSERVATION
1417 G Street N. W., Washington D. C.

To Members of the American Forestry Association

We need your help. The Association of which you are members needs your help. The cause of conservation of natural resources needs your help.

Nominations for Membership

Now is the time to nominate. Use the blank below, adding to it when necessary, and send in your lists. Little remains of 1908; help to make a fine showing, in new members, for the year.

Do It Now—Lest You Forget!

Nominations for Membership

The activities of the National Office of the American Forestry Association are limited chiefly by its resources. These are derived almost wholly from its members in the form of dues. Every member is urged to aid in increasing the membership. Kindly fill out the enclosed blank form, lengthening the list, where possible, by attaching and filling blank sheet. The list should then be sent to

THOMAS E. WILL
Secretary American Forestry Association
1417 G Street Northwest, Washington, D. C.

I hereby nominate the following persons for membership in The American Forestry Association:

Name

Address

Signed.....

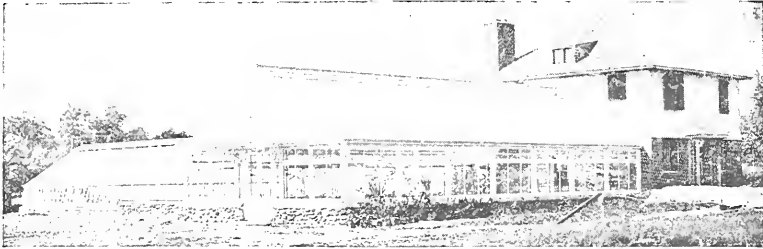

The Greenhouse

This range of greenhouses was erected for the Connecticut Agricultural College at Storrs, Conn., and will be used solely for the practical instruction of the students.

It is of our Sectional Iron Frame Construction, which, because of its great durability, its consequent freedom from repairs, makes a lasting investment.

It is of this same construction that we build our various types of ornamental greenhouses for private grounds. The wide scope of possibilities of this construction make it the ideal one for all other kinds of glass enclosures, such as conservatories, orchard houses, swimming pools, orangeries, and so on.

In our book, "Greenhouses As We Build Them," just published, we devote 72 pages to showing in an interesting, fully illustrated way just such information as you want to know before building. It even goes so far as to devote a few pages to the question of choosing a site for the greenhouse, and gives some half dozen or so examples of the usual and somewhat unusual placing.

This book we want to send you.

LORD AND BURNHAM CO.

Greenhouse Designers and Builders

1133 Broadway

NEW YORK



DON'T SPECULATE

The man who works for his money can't afford to take risks with it—

Six per cent., without risk, is a lot better than the faraway possibilities of 12 or 20 per cent.

The 6 Per Cent. Certificates of Deposit issued by this company are absolutely non-speculative. They are issued by a strong, conservatively managed company and are secured by first mortgages on improved real estate—the soundest of all security, deposited in trust in one of the largest trust companies in this City. These Certificates run for 2 years—but may be converted into cash at any time on a 5 per cent. basis.

Our Savings Accounts, withdrawable at any time, without notice. We pay 5%. Write for the booklet today.

Calvert Mortgage & Deposit Company
1069 Calvert Building BALTIMORE, MD.

Thorburn's Seeds

We carry a large assortment of seeds of EVERGREEN and DECIDUOUS TREES and SHRUBS, both native and imported, and shall be glad to quote on any that are still unsold.

J. M. THORBURN & CO.

33 BARCLAY STREET

Through to 38 Park Place

Established 1802

NEW YORK

Biltmore Forest School

Biltmore, N. C.

Theoretical and practical instruction in all branches of applied forestry.

The course comprises eighteen months: twelve consecutive months of lectures and field work, and six months of practical experience.

Object lessons within the mountain estate of George W. Vanderbilt, comprising 120,000 acres, where forestry has been practiced since 1895.

For further information apply to
C. A. Schenck, Director

Colorado School of Forestry

Colorado Springs, Colo.

Three years' course in
TECHNICAL AND
APPLIED FORESTRY

Winter Term at Colorado College, Colorado Springs. Summer Term at Manitou Park, on the borders of the Pike's Peak Forest Reserve.

Tuition
Sixty Dollars a Year

For further particulars apply to
Wm. C. Sturgis, Dean
Colorado Springs, Colo.

YALE FOREST SCHOOL NEW HAVEN, CONNECTICUT

The course of study in the YALE FOREST SCHOOL covers a period of two years. Graduates of collegiate institutions of high standing are admitted as candidates for the degree of Master of Forestry.

The Summer School of Forestry is conducted at MILFORD, PIKE COUNTY, PENNA.

FOR FURTHER INFORMATION ADDRESS

HENRY S. GRAVES, Director

New Haven, Connecticut

CONSERVATION



**WOODS AND WATERS
SOILS AND ORES**



DEATH OF A FOREST GIANT

SAVE YOUR TREES



NATURE'S RESPONSE

Do you realize the wonderful significance of the picture shown above? Do you appreciate the fact that it portrays the victory of Life over Death? Have you thought that in every living organism there is a constant struggle between these two forces; that once Death secures a foothold, the chances of Life grow correspondingly less with each succeeding year?

The tree shown above was completely hollow, and the decay was spreading rapidly. It was placed in our hands for treatment. We carefully prepared the cavity and filled it for the two-fold purpose of excluding the moisture, and preserving the contour of the tree, so that the bark would heal over it. The space between the hands of the man in the photograph indicates how much it has healed already. In a short time the filling will be entirely encased by the bark, and all traces of the wound will gradually disappear. The health of the tree is restored.

This is Nature's response.

Have you examined the wounds in *your own* trees, and do you realize the danger that each one threatens? It is not natural for them to exist; but *they are there*, the result of neglect or abuse. It is our business to remedy these defects, and we have made a success of our business. We are backed by nearly half a century of experience, and this experience is at your service. In Tree Surgery we stand alone. Results count. We get results. Others have profited by our experience; why not you? For example:

Hathaway, P. O., Tannersville, N. Y., July 11, 1907.

Mr. Martin L. Davey, Tarrytown, N. Y.

DEAR SIR: I write to say that the treatment of the trees that you have undertaken on my place has been thoroughly satisfactory, and I should certainly advise anyone having trees needing care to consult with you at the earliest opportunity.

Yours truly,

V. EVERIT MACY.

Send for our booklet, "A Great Revelation"
It's interesting, and will cost you nothing

DAVEY'S

School of Practical Forestry

Eastern Office, Tarrytown, N. Y.

Your house can be replaced, but your trees can not

In writing to advertisers kindly mention CONSERVATION



EVERGREENS 2 to 10 FEET HIGH

You have over 30,000 to select from that have been especially trained for successful transplanting in September. They have been recently transplanted or root pruned; tops pruned in June to make them dense and symmetrical. PINE, CEDAR and HEMLOCK up to 10 to 25 feet high in carload lots.

Now is the time to select from our stock of SHADE TREES which save 10 to 20 years waiting. They are now 12 to 25 feet apart and prepared for successful shipment.

Will a group of shade trees 25 to 30 feet high make your place more beautiful and comfortable?

FOREST SEEDLINGS AT LOW RATES

Call at the Nursery or send for our beautifully illustrated catalogue and price list

ISAAC HICKS & SON, Nurserymen, Scientific Treemovers
WESTBURY STATION, LONG ISLAND, N. Y.

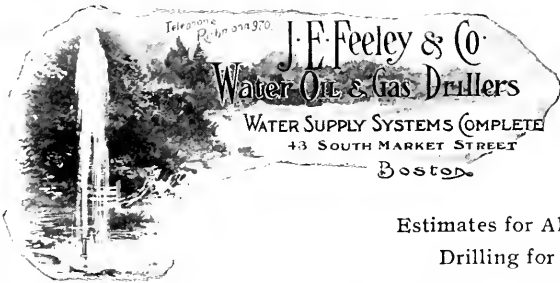

Flowing Well, New Mexico

J. E. FEELEY
 F. A. BASFORD

**Test Boring for Minerals
 Water, Gas or Oil in any
 part of the United States or
 Canada**

Telephone, Richmond 970

Estimates for All Kinds of Pumping Outfits
 Drilling for Water, Oil or Gas Wells

J. E. FEELEY & CO.

43 SOUTH MARKET STREET, BOSTON, MASS.

Plant for Immediate Effect

Not for Future Generations

Start with the largest stock that can be secured! It takes over **twenty years** to grow such Trees and Shrubs as we offer.

We do the long waiting—thus enabling you to secure trees and shrubs that give an immediate effect. **Fall Price List Now Ready.**

ANDORRA NURSERIES CHESTNUT HILL
 PHILADELPHIA, PA.

WM. WARNER HARPER, Proprietor

SCHOOLS OF FORESTRY

Colorado School of Forestry

Colorado Springs, Colo.

Three years' course in Technical and
Applied Forestry

Winter Term at Colorado College,
Colorado Springs. Summer Term
at Manitou Park, on the borders of
the Pike's Peak National Forest.

Tuition Sixty Dollars a Year

For further particulars apply to
WM. C. STURGIS, Dean
Colorado Springs, Colo.

Biltmore Forest School

Biltmore N. C.

Theoretical and practical instruction in all branches of applied forestry.

The course comprises eighteen months; twelve consecutive months of lectures and field work, and six months of practical experience.

Object lessons within the mountain estate of George W. Vanderbilt, comprising 120,000 acres, where forestry has been practiced since 1895.

For further information apply to
C. A. SCHENCK, Director

YALE FOREST SCHOOL

NEW HAVEN, CONNECTICUT

The course of study in the YALE FOREST SCHOOL covers a period of two years. Graduates of collegiate institutions of high standing are admitted as candidates for the degree of Master of Forestry.

The Summer School of Forestry is conducted at MILFORD, PIKE COUNTY, PENNA.

FOR FURTHER INFORMATION ADDRESS

HENRY S. GRAVES Director

New Haven

Connecticut

The
**PENNSYLVANIA
 STATE COLLEGE**

A thorough and practical undergraduate course in technical forestry, preparing men for all lines of professional and applied forestry.

Special attention is paid to practical field work in surveying, mapping, and forest measurements. One of the largest of the State Forest Reserves is within a short walk of the college.

For information regarding entrance requirements, expenses, etc., address

Department of Forestry
 State College, Penna.

POWDER POINT SCHOOL, Duxbury, Mass.

Preparatory Course in
FORESTRY

Leading to Biltmore and College Course in the subject. It requires hard, earnest application, and develops appreciation of nature and powers of leadership.
 (M. I. T.) F. E. KNAPP, S. B.

FORESTRY SCHOOLS

can find no better medium through which to make their announcements than

Conservation

It reaches a class of Readers that is reached by no other Publication.

It is *the* Magazine of authority in its special field.

For Advertising Rates, etc., address

Advertising Manager

CONSERVATION

1417 G St. N. W.

Room C

Washington, D. C.

To Readers of Conservation

WE ARE completely overhauling, correcting and revising the mailing list of this magazine. In the course of this work we have found several errors—a very natural condition when the rapid growth of our circulation is taken into consideration. In order to have the list absolutely accurate, we ask every reader, subscriber and member of the American Forestry Association to advise us if his or her magazine is properly addressed. Changes of address may have been overlooked; "stop" orders may have escaped us. If there is anything wrong, please let us know immediately. The prompt attention of all readers is urged. Address:

CONSERVATION

Circulation Department

Washington, D. C.

Real Estate, Farms, etc.

The following advertisements of Real Estate, Farm Lands, Timber Lands, etc., are the announcements of reliable firms and agencies. The Advertising Manager of CONSERVATION has investigated the announcements in all cases, and feels safe in recommending the advertisers to the readers of the magazine. The services of this department are free to all members of The American Forestry Association and subscribers to this magazine; advice in regard to the purchase of Real Estate advertised in our pages is gladly given, and our readers are urged to make the fullest use of our services in all matters pertaining to the purchase of advertised Real Estate, of whatever character, no matter where it is located.

VIRGINIA

Rockbridge County, Virginia

offers advantages to the home-seeker equaled by few and excelled by none.

LEXINGTON

the County Seat, is a town of homes; 4,000 people, two large institutions of learning, good high school and graded school. **THREE BANKS** with over a million dollars of deposits, beautiful scenery, healthful climate.

SAM'L B. WALKER, JR.

FARM, MINERAL, TIMBER, COAL LANDS
LEXINGTON, VA.

A MAGNIFICENT VIRGINIA ESTATE

(Only 87 minutes by rail from Washington.) Contains 1,023 acres, about 500 acres in blue-grass, 200 acres in timothy and other grasses, 200 acres in grain and crops, and about 100 acres in good timber.

160 cattle were fattened on this place last year, and sold for over \$12,000; besides this, there was sold from the place over \$1,200 worth of hay. The corn crop averaged sixty bushels to the acre. A small field of alfalfa was cut three times, and could have been cut another time. There are nearly 500 thrifty bearing fruit trees. The soil is a dark rich loam, well drained. Splendid new residence of thirteen rooms, two bath rooms, over 100 feet of porch, 10-acre lawn, all modern improvements, hot and cold water, steam heat and gas. Besides this mansion, there is another 8-room house, three tenant-houses, two sets of farm buildings, five stock barns for hay, etc.

It is not more than one-fourth of a mile from a prominent station on the Southern Railroad, and very convenient to Washington and the northern cities. Acre for acre, this farm is second to no farm in Virginia.

For price and particulars, address

JOHN A. NICHOL, Manassas, Virginia

FLORIDA ORANGE GROVES

pay very handsomely. Colory and truck is the quick road to wealth in Florida. The climate in central southern Florida cannot be beaten for health or pleasure. If you have weak lungs or throat, go to Florida and live out of doors all the winter, fishing, boating, hunting and eating fruit.

If you want to join a party to camp on Cape Swatiska for a few months, write us for particulars, enclosing stamp.

If you want a good investment, we will send you a full description of some valuable property. We can furnish you Florida property from \$600 to \$50,000. For \$10,000 to \$15,000 you can buy a nice grove that will bring you a good income for life. Citrus fruits net from 10 per cent. to 50 per cent. on the investment, according to the attention given them.

If you would like to join a Co-operative Colony write us for particulars. If you want success join our Club and we will help you. If you have attained success in life and want to help others unite with us.

The Swastika Success Club, Manassas, Va.

The Swastika Success Magazine, only 25 cents a year. The best published for the money

A VIRGINIA BARGAIN

No. 15.—245 acres strong lime-stone and blue-grass land, situated in a fine section of Augusta County, Va. About 2 1-2 miles from N. & W. R. R., about 5 miles from station on C. & O. R. R., about 2 1-2 miles from a station on B. & O. R. R., and about 9 miles from Staunton. Fronts on main road. Well fenced and well watered, and has about 15 acres of good timber. Land is gently rolling and well adapted to both grazing and cultivation.

IMPROVEMENTS: Large old 12-room residence with spacious rooms and halls, large bank barn 50 by 75 feet, stable under barn for 45 head of stock, large hog-pen, granary, hay-shed, carriage-shed, corn-crib, blacksmith-shop, smoke-house, large hen-house, and other outbuildings. About 5 acres of orchard in good bearing, trees about 15 years old. A good tenant house with 5 rooms. All in all, this is a very desirable place.

Price, \$20,000.00, one-third cash, balance on good terms.

R. W. MENEFEE & CO.

Timber Lands and Farms
STAUNTON, VA.

Virginia Country Homes

Grain, fruit, dairy, and blue-grass farms for sale in the best portion of the state. Also timber lands.

Climate, social conditions, and nearness to markets, make this a splendid country in which to locate.

Write for free illustrated register. We solicit correspondence.

H. W. HILLEARY & CO.

Charlottesville, Virginia

The Peninsula of Virginia

The most favored section of the state. Good lands, fine climate, healthy; good crops and good markets; fine schools, best society. Farmers making big money growing Irish potatoes, corn, hay, berries, etc. One man cleared \$100 per acre from potato crop this season, and now has second crop, corn, growing on same land. Hundreds of Western and Northern people already here, and hundreds more coming. It's the best country in the world. Send 5c (stamps) for descriptive literature.

Piedmont & Tidewater Land Co., Inc.

Box 70
Williamsburg, Virginia

Farms and Homes in Virginia

Free from frost 183 days. Plowing season 315 days, growing season 225 days. **Why not move to Virginia** where you can buy good level land with buildings, timber, fruit, water, etc., at **\$8 per acre and up?** Best climate, health, markets, transportation facilities, churches, schools, active business life. **Our Illustrated Real Estate Herald**, with map, tells all about it. Write to-day for free copy.

PYLE & COMPANY (Inc.), PETERSBURG, VIRGINIA

VIRGINIA INVESTMENTS

J. NELSON GARNETT, Real Estate and Loan Agent, CULPEPER, VA.

High-class Loans and Mortgages our Specialty

Choicest homes and investments of every description in Northern or Piedmont Virginia, the garden spot of the world, and the booming Southland, within sixty miles of Washington. Write for property list and other information.

VIRGINIA

Farms, City Property
Timber and Mineral

LANDS
A Specialty

*Large Tracts for
Colonization*

International Farm Agency

(INCORPORATED)

900 Main Street

Lynchburg, Va.

TIMBERLANDS IN THE SOUTH

We offer timber tracts in Virginia, North and South Carolina, and other sections of the South.

**FIRST-CLASS SOUTHERN PINE
AND HARDWOODS**

The tracts are covered with virgin growths of Southern Yellow Pine and Hardwoods, the timber alone being worth the price asked for the lands. Land is all good farming land after it is cleared. All are within a reasonable distance of Charleston. Particulars on request.

O. H. PERRY TIE & LUMBER CO.
Norfolk, Virginia

TWO TIMBER BARGAINS

No. 45.—14,000 acres, iron and timber land, in Bath and Rockwell Counties, Va. Second-growth timber, some merchantable; land lies well and is good grazing land for sheep or cattle. \$1.25 per acre.

No. 40.—41,576 acres in Bath, Highland and Augusta Counties, Va. *Best virgin tract of white oak now standing in Virginia.* All easy logging proposition, 10 to 12 miles from C. & O. Ry. Road would have a water grade on Mill Creek—all easy grades. 160,000,000 feet saw timber, 75 per cent. of which is white oak of finest quality, besides tan bark, ties and other timber. Owner would consider offer of \$8.00 per acre.

Prospective Investors, Look This Over!

J. W. Guinn, Goshen, Virginia

Timber Lands, Farms and Summer Resorts

THE American Forestry Association

Officers for 1908

President

HON. JAMES WILSON, Secretary of Agriculture

Vice-presidents-at-large

DR. EDWARD EVERETT HALE	GEO. T. OLIVER
N. J. BACHELDER	DR. B. E. FERNOW
GEO. FOSTER PEABODY	GEO. C. PARDEE
RUTHERFORD P. HAYES	ALBERT SHAW
W. W. FINLEY	J. T. ROTHROCK
CHARLES R. VAN HISE	

Advisory Board Selected by Affiliated Organizations

H. H. WHELESS	GEORGE E. STONE	W. K. KNOX
JAMES INNES	ALLEN CHAMBERLAIN	A. L. HAYES
C. H. KEYS	D. E. KLINE	FREDERICK S. UNDERHILL
ROBERT C. LIPPINCOTT	E. F. SAWYER	ROBERT L. LIPPINCOTT
GEORGE F. CRAIG	F. E. WEYERHAEUSER	S. B. ANDERSON
C. A. SMITH	KENT SHEPPARD	ROBERT A. JOHNSON

Members of Board Designated as Vice-Presidents of Association

N. W. McLEOD	LEWIS DILL	J. T. WYLIE
WILLIAM IRVINE	EDWIN A. START	D. E. KLINE
GEORGE H. HAMPTON	SAMUEL B. VROOMAN	B. W. PORTER

Secretary, THOMAS ELMER WILL, Washington, D. C.
Assistant Secretary, FRANK GLOVER HEATON, Washington, D. C.
Treasurer, OTTO LUEBKERT, Washington, D. C.

Directors

JAMES WILSON	WILLIAM L. HALL	W. J. MCGEE
GEO. P. WHITTLESEY	GEORGE K. SMITH	PHILIP W. AYRES
JAMES H. CUTLER	WILLIAM S. HARVEY	ROBERT GARRETT
HENRY S. GRAVES	H. A. PRESSEY	LIGON JOHNSON
F. H. NEWELL	ASBURY F. LEVER	FILIBERT ROTH

Application for Membership

To THOMAS ELMER WILL
Secretary American Forestry Association
 1417 G Street N. W., Washington, D. C.

Dear Sir: I hereby signify my desire to become a member of the American Forestry Association. Two Dollars (\$2.00) for annual dues are enclosed herewith.

Very truly yours,

Name _____

P. O. Address _____

The American Forestry Association

President—**HON. JAMES WILSON**

Secretary of Agriculture

The American Forestry Association was organized in 1882, and incorporated in January, 1897. It now has over 7,000 members, residents of every State in the Union, Canada, and foreign countries. From its origin it has been the tireless friend of the forests.

The object of the Association is to promote the preservation, by wise use, and the extension of the forests of the United States; its means are agitation and education; it seeks to encourage the application of forestry by private owners to forest holdings, large or small; and it favors, especially, the establishment and multiplication of National and State forests, to be administered in the highest interests of all.

The Association seeks as members all who sympathize with its object and methods, and who believe that our natural resources constitute a common heritage, to be used without abusing and administered for the common good. Seeking to conserve our supplies of wood and water, the Association appeals especially to wood-producers and users, including owners of wood lands, lumbermen, foresters, railroad men, and engineers; and to those dependent upon equable stream flow, as manufacturers, irrigators, employers of water power, and those engaged in internal commerce.

The Association meets annually in Washington. It publishes, monthly, *CONSERVATION*, the magazine of authority in its special field. The list of contributors to this publication includes practically all persons prominent in forest work in the United States, making it alone worth the cost of Annual Membership in the Association.

The dues, covering a subscription to *CONSERVATION*, are as follows: Annual—For Annual Members, \$2; for Sustaining Members, \$25; Total, with exemption from all other payments—for Life Members, \$100; for Patrons, \$1,000, and of the above amount, \$1 is set aside each year to pay the subscription of each member to *CONSERVATION*.

THOMAS ELMER WILL, Secretary.

The American Forestry Association.

THE CARE OF TREES

HAVE US INSPECT YOUR TREES

Old trees are usually in need of attention. An inspection serves as an insurance on their welfare, and is often the means of saving valuable specimens found to be in urgent need of attention. The cost is trifling, and your trees are valuable.

PRESERVE YOUR OLD TREES

The best of care must be given old trees. Dead wood cavities, diseases, and other defects must be eliminated if the trees are to live and flourish. By our inspections and experienced treemen we can produce gratifying results.

YOUR DYING ORCHARD

can, by our pruning, spraying, fertilizing, and general care, be brought into excellent condition and made to bear excellent crops. Do not delay, for the deadly San Jose Scale works rapidly.

We will be pleased to mail you our free booklet on **THE CARE OF TREES**, which shows the work we do and our qualifications.

The accompanying cuts show an important tree on the estate of Mr. J. A. Jeffrey, Columbus, Ohio, recently saved by us.

MUNSON-WHITAKER COMPANY

1104 FLATIRON BUILDING, NEW YORK
840 TREMONT BUILDING, BOSTON

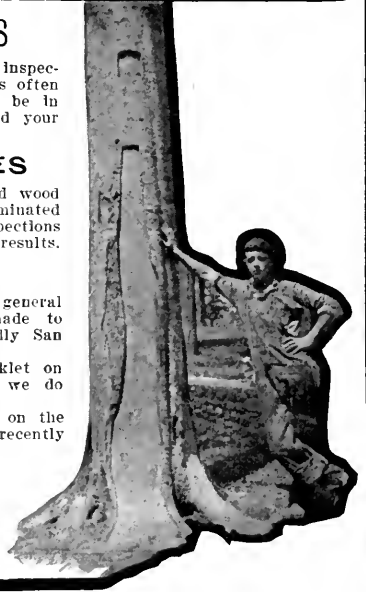

NEW ENGLAND COUNTRY HOMES

Stock and dairy farms, Summer Houses at sea-shore, White Mountains and Berkshire Hills, from 25 to 1,500 acres of land, ranging in price from \$10,000 up to \$150,000. Will be pleased to give full description and terms.

George C. Davis

70 STATE STREET, BOSTON

High-grade Country Estates

TIMBER LANDS

FOR

INVESTMENT

I sold to a bank president an Adirondacks tract at fifty per cent. more than its owner had paid for it less than a year previous, and the banker was satisfied.

==

I always have timber properties of inviting character and at inviting prices, and solicit correspondence from investors or those who would buy for operation.

RALPH HERBERT WAGGONER

309 BROADWAY, NEW YORK

CONSERVATION

OFFICIAL MAGAZINE
OF THE
AMERICAN FORESTRY ASSOCIATION

FRANK GLOVER HEATON, *Editor*

CONTENTS FOR NOVEMBER, 1908

A WESTERN IRRIGATION PROJECT.....	<i>Frontispiece</i>	
THE FRAUDULENT HOMESTEADER—By Alfred L. Thayer.....	579	
Illustrated		
THE BLIGHT ON CHESTNUT TREES—By John Mickleborough, Ph.D.....	585	
Illustrated		
THE SIXTEENTH NATIONAL IRRIGATION CONGRESS.....	589	
With photographs		
THE NATURAL MOVEMENT OF WATER IN SEMI-ARID REGIONS.....	596	
By W J McGee, LL.D.		
<i>Paper read at the Sixteenth National Irrigation Congress</i>		
THE LAKES-TO-GULF CONVENTION AT CHICAGO.....	601	
THE TRANS-MISSISSIPPI COMMERCIAL CONGRESS.....	607	
By J. B. Case, President, 1907-08		
CONVENTION OF THE OHIO VALLEY IMPROVEMENT ASSOCIATION.....	611	
DROUGHTS AND FLOODS—By John H. Finney.....	615	
Illustrated		
A BEGINNER IN FORESTRY—Paper Two—By Anne Warner.....	618	
COMMUNICATIONS—		
The Fall Web-worm.....	620	Eucalyptus Growing..... 624
Two Essays.....	621	
EDITORIAL—With Photographs		
The Forest Fires.....	625	Fire Protection a Business Proposition..... 628
Thirty Years' Fire Damage.....	625	The Hydro-electric Power Interests..... 630
Estimate Not Excessive.....	625	Interest of Public School Pupils..... 633
Other Features of Loss.....	626	The Conservation Program in Politics..... 634
Fire Losses of 1907.....	627	Anti-forest-fire Congress..... 635
NEWS AND NOTES—		
Important Meetings in Washington.....	636	Irrigation Notes from Washington..... 637
Work of the Comcoctent Forestry Association....	636	A Pioneer in National Irrigation and Forestry... 638
"A Primer of Conservation".....	636	

CONSERVATION is the official organ of the American Forestry Association. Price, \$2.00 per year, including Annual Membership in the Association. Entered as second-class matter August 1, 1908, at the Post Office at Washington, D. C., under the Act of March 3, 1879

Published Monthly at
1417 G STREET N. W. WASHINGTON, D. C.

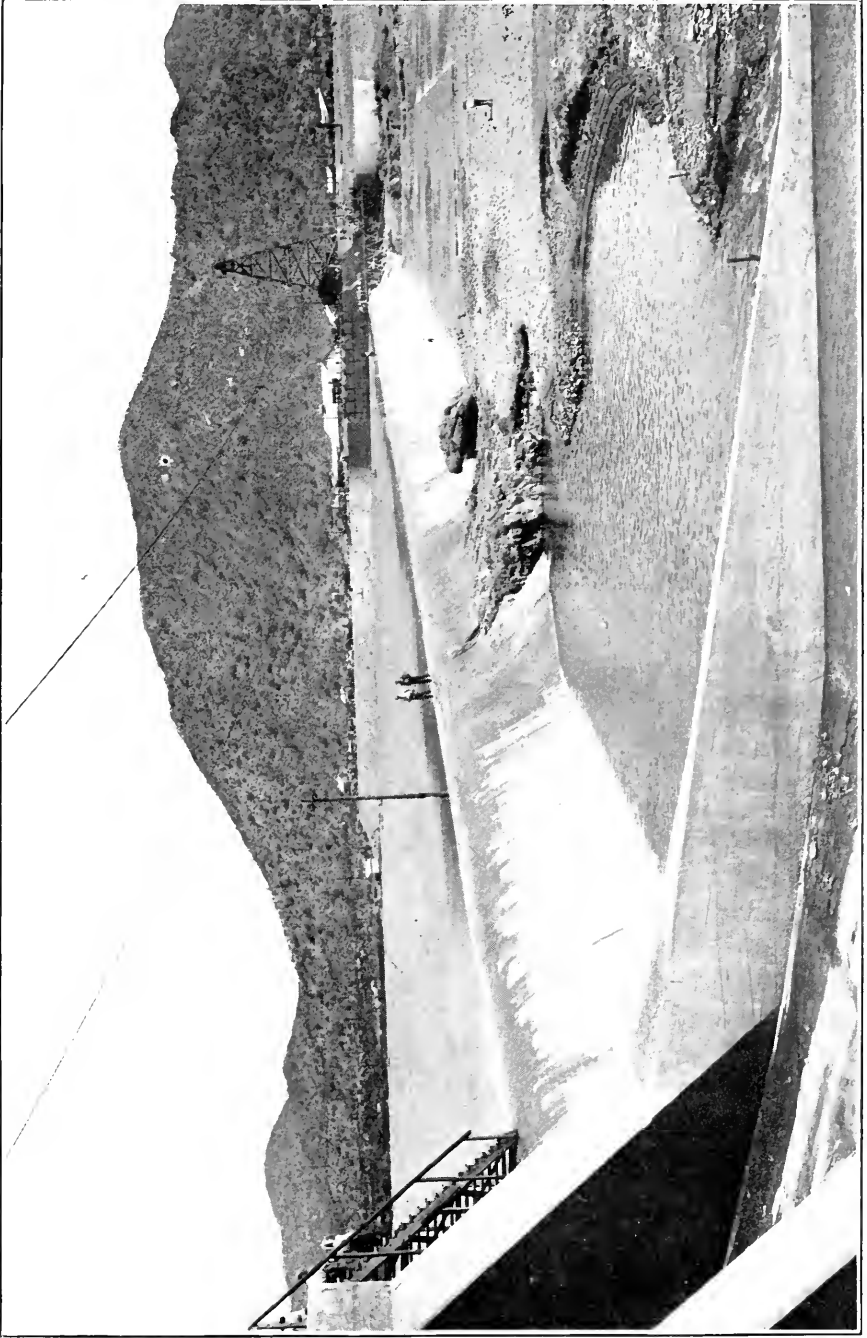

A WESTERN IRRIGATION PROJECT

Dam, Power Plant, and Intake of Main Irrigation Canal. Projects Such as This Are Annually Reclaiming Thousands of Acres in the Arid West and Causing the Desert to Blossom Like a Rose

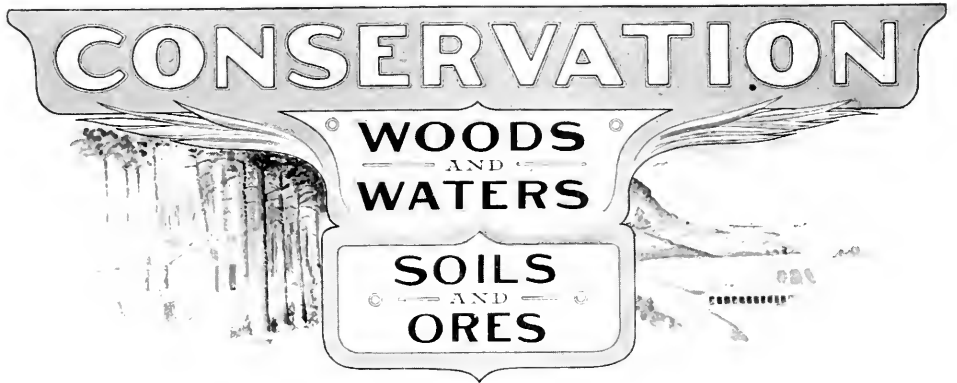

Vol. XIV

NOVEMBER, 1908

No. 11

THE FRAUDULENT HOMESTEADER

By ALFORD L. THAYER

PLAY on the heart-strings of a man until you strike the lost chord of his better self: that part of him grown indifferent and callous in the struggle of money making, and he may confess the weakness of his wrongs upon which you attack him. He may tell you the secrets of years, buried within him, and perhaps through tears, may walk entirely out of his old mercenary career into a decent, honorable life.

In making investigations of the fraudulent homestead and timber claims within the boundaries of the National Forests in the West, I have in almost every district, discovered two distinct types—the person who deliberately sets about to defraud the Government out of 160 acres of land, and the party who has been the victim of a professional locator, working in the interests of some large corporation. The Government has no room on its public lands for a timber thief; Uncle Sam has a great heart that forgives the man who has been betrayed by cunning plans of those higher up who are playing the "big timber game."

I recently called on a shingle weaver, living with his wife and five children in a small house just outside of Everett. I asked him whether he was the same party who was attempting to hold a homestead claim in the Cascade mountains, forty miles from that city. He said he was, and was very much astonished when I explained to him the regulations. Of course he had not complied with the requirements of the homestead law, and offered the usual excuse.

"Why, hundreds of people in this country have taken up claims back in these mountains, and have never been on the land."

"But," I argued, "because thousands of acres of valuable timber have been illegally acquired in the past, is it a reason for continuing such a plundering system in the future?"

"No, but I can't see why you pick me out. My boss at the mill and his lawyer said I could work there, and hold this claim down. They ought to know, for they have had experience before in these cases."

"Have you read the homestead law?" I inquired, storing in my memory what

he had just said, but ignoring the statement.

"No, I should say not. What do we have attorneys for? My boss sent me out with the company cruiser to see the land, go over it, stay out there for a couple of nights, and then the lawyer

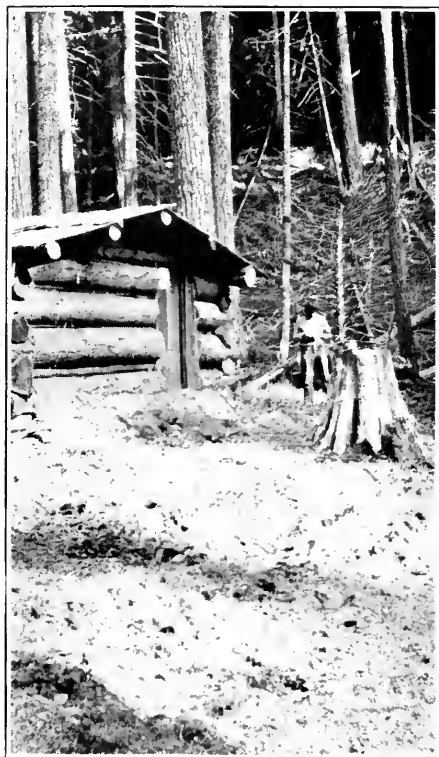

FRAUDULENT HOMESTEAD

This 160-acre Claim in Washington Has Six Million Feet of Red Fir and Cedar on It

fixed up the papers and told me what to say when I went to the land office. I tell you right now, I ain't going to give it up, for the boss has been to big expense, and if I back down, he may fire me."

Poor wretch, led by the nose, harnessed into the cart of subjection, and blindly violating the law, depending entirely upon his "boss" and lawyer to protect him in case of trouble. And yet, hundreds of people have successfully made entries on public lands and secured patents under just such pretexts of complying with the law.

After a long and strenuous argument the man was finally compelled to see his serious position with the Government, and relinquished his rights and title to the land, with the understanding that I would make an effort to prevent his "boss" from discharging him.

I called next morning on this timber "king" in his beautiful private office, looked him square in the eye, and said quietly:

"Your man Brown has relinquished his homestead claim located by your timber cruiser because he has failed to comply with the law. He is afraid you will become angry with him, and discharge him from your employ. Please do not let this happen. You are not in position to take any such action against him. Do you understand?"

He glared for a moment into my face as if he would gladly mutilate my features, then slowly paled, and sat forward in his heavy leather chair. His voice was low and strained.

"I understand. Brown shall keep his place. I hope this is the end of the matter."

I bowed myself out without saying much, for I knew this man would sooner or later have to face a federal grand jury, and I did not wish to commit myself. To-day this same man is spending his time in a United States prison, thinking over some of the errors of his ways. Such has been the end of a busy, prosperous but unscrupulous life.

And now comes the story in brief of one of the most noted and remarkable timber locators and public land robbers in the Northwest. There are but few characters like this man in the history of fraudulent claims in this country.

Cascade Bill, omitting the rest of his name for fear of offending him, is a stoutly built, short, burly fellow with one eye, steel gray, and a wealth of fierce black whiskers. For twenty years he has been a professional timber locator in the Index, Washington country, the heart of the Cascade Mountains,

thirty-seven miles from Everett. Index is a picturesque mountain town, with towering peaks around it, and is the great gate entrance to most of the claims taken in that region. Cascade Bill dropped into that country from California with a pretty good knowledge of the Benson-Hyde system, and some ideas of his own. He located with his wife on a tract of land, built a cabin and several outbuildings, cultivated a patch of potatoes, and proceeded to put his "system" into execution.

And so it came to pass that hundreds of people, mostly hard-working, ignorant Swedes, Danes, and Germans, began to swarm into Index, lured by the inducements thrown out by their friends already snugly settled on million-foot timber homestead tracts of 160 acres. Cascade Bill, with his gang, would meet the new victims at the train upon its arrival at Index, conduct them up the trail, and over the "Settlers' Bridge" (about which I will tell later) constructed across the Skykomish River, a beautiful mountain stream, dashing in a swift, tumbling fashion along the edge of the town, and skirting Cascade Bill's land on the east. After a three-mile walk between magnificent firs and stately cedars, drinking in the crystal air, and listening to the lavish descriptions of the timber and "chances" to make a "stake" out of the homestead "business," the new arrival is quite willing and anxious to part with his ready cash as soon as he is "located."

After a good "feed," for Mrs. Bill is a capital cook, and a sound night's rest, the victim was conducted to his "land," and Cascade Bill showed him what were supposed to be the corner stakes and witness trees. It so happened, however, that the would-be homesteader, knowing little or nothing about such matters, was perhaps shown the corner stakes of some claim already settled on. The wily locator was careful to keep "locaters" far enough apart on the land, so that when the cabins were built they would be at a respectable distance from each other.

Then the party would pay over to Cascade Bill \$325 as a locating fee, or all the cash he had on hand, and give his note with "certain agreements" on its face for the balance. "It comes high," says the one-eyed man, "but I ain't takin' no chances for nothin'."

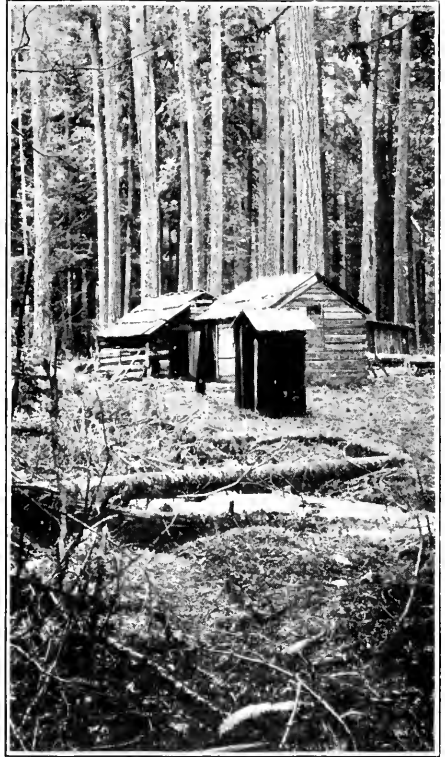

A VALUABLE "CLAIM"

160-acre Tract in Washington, with Five Million Feet of Timber, Worth about \$25,000

And so for years this state of affairs went merrily on, and hundreds of poor people were filched out of hard-earned money, and located on land, some of which had been "located" as high as ten times before. Cascade Bill actually showed four men the timber on the east forties of his own claim, and ingeniously piloted them around trails, covering the same ground until they had tramped over 160 acres of land, then "located" them on his own land. The innocents took his word for it, and built cabins which to-day stand on the claim originally squatted on by Cascade Bill.

But all good things come to an end in time, and so when I arrived on the scene with two big husky rangers, to make investigations of the land frauds in that section, Cascade Bill was at first panic stricken. He knew it would now only be a question of a short time until his crooked work would be exposed, but like all rascals he had disposed of his money lavishly, on the "come easy, go easy" system, until he had little left but the notes of his victims, an occasional fee for a short time, and generally a comfortable "cargo" of Index whisky. Then he was afraid to leave his homestead claim for any length of time, as he had never offered even a filing (in order to keep his land off the records, so that he might juggle it in the fashion stated above), for fear some person might "jump" his claim. On the other hand the old grizzled mountaineer saw the "handwriting on the wall," and dreaded to think of iron bars and striped suits.

So Cascade Bill fumed and stormed at the bar over his whisky, and threatened that if "that damned inspector did not 'come in,' he would scatter his brain matter about the sidewalks of Index." I paid no attention to the statements issued from this timber "baron," and proceeded to "break" into his ring. Three days of terrifically hard work, and some good results: Cascade Bill suddenly changed his tune, and became diplomatic. With three of his right-hand men he called on me at the hotel, and was very gracious. His smile was a painful effort, and did not add to the beauty of his already distorted features, caused by his blind eye. He held out his clammy hand, and sprawled into a rocker, chewing tobacco like a cow her cud. He beamed on my two rangers, who ignored the honor, and stationed themselves near me, in close proximity to their six-shooters. The fact seemed to get out that Cascade Bill was a "dead shot," and the boys were loath to gather up my gray matter, and ship me in sections back to Washington. Of course I was amused, but concerned, not to say interested, in

this character who had collected homestead fees to the amount of something like \$25,000 in the twenty years he operated in that country.

Cascade Bill found that his threats had failed to drive us from the work we had been detailed to do, and changed his tactics. He outlined a generous plan by which we could all make a nice "rake off" and still hold our positions. I declined with thanks, and he switched again, and asked me to partake of Sunday dinner with his wife and himself. I accepted in haste, for this would give me an opportunity I wanted greatly, to meet and talk to a woman whom I understood wrote all of her husband's letters, acted in fact as his private secretary, for Cascade Bill could neither read nor write. The rangers were greatly worried over my going alone to this man's cabin up in the woods, but I arranged to have them near by, and instructed them by means of a signal that would not be noticed by the locator or his wife, that I could give in case I needed them. They were to remain in hiding until after the dinner hour, then saunter leisurely in, as if they had accidentally happened that way.

I was on hand next day on schedule time, and Mrs. Bill made a great fuss over me. She fumed and sputtered as most fat people do, over the dinner, but finally we sat down to a very excellent repast, with chicken as the principal feature. Everything moved smoothly, and our conversation became quite animated on various subjects, until coffee appeared. I noticed a queer odor about it the moment Mrs. Bill placed the cup beside me. I also noticed the woman was unusually pale, despite her red face. Then I detected a rather greenish scum appearing on the top of the coffee, and decided that I would only make a pretext of drinking it. You see, I was on the lookout for almost anything to happen, and knew that Cascade Bill had some "ax to grind" by that invitation. The old man eyed me cautiously, and noticed I did not drink the coffee.

"Drink up, and I will show you about the place," he insisted.

I thanked both of them graciously, but I said I never drank coffee, and we left the table. I thought the locator looked disappointed. I urged Mrs. Bill and her husband to exhibit their garden and other "improvements," and managed to get them outside without disturbing the debris of the dinner. Then I gave the signal for the boys, and soon they sauntered quietly in. In a moment, while one of the rangers was engaged with Cascade Bill and his wife over a peculiar species of berry that grew in the mountains, I managed to get the other ranger aside, and instructed him to get into the cabin unseen, if possible, and empty the contents of that coffee cup into his canteen.

This feat was dextrously performed, and we soon left the claim, after expressing ourselves pleased with the call, and myself with the dinner. Sufficient to relate, that after an analysis of the coffee by an expert, it was found to contain one-half ounce of rat poison. Thus does man escape the traps set for his downfall. I was very grateful that the manufacturer had inserted an odor into his poison. I often wonder what Cascade Bill said to his wife about it after I left their hospitable roof.

I went on with my work of investigation, and turned up startling and lurid tales about this man and his dark deeds. As fast as the deceived homesteaders gave up their land, they unfolded their troubles to me, and were willing witnesses as to his treachery. Space will not permit me to repeat one-tenth of these stories, but the history in brief of Cascade Bill's creation of the "Settlers' Bridge" should not be overlooked.

None of the claims in question could be reached by a single roadway, as they were located between two steep mountain walls, with no highway entrance to the outside world. The railway crept through a narrow strip of right of way, following the river banks into the town

and out of it. Index is perhaps one of the very few towns in the United States having no roadway in or out of it to the country outside.

Therefore, when Cascade Bill first located in this timber fairyland, one of his first acts was to build a suspension

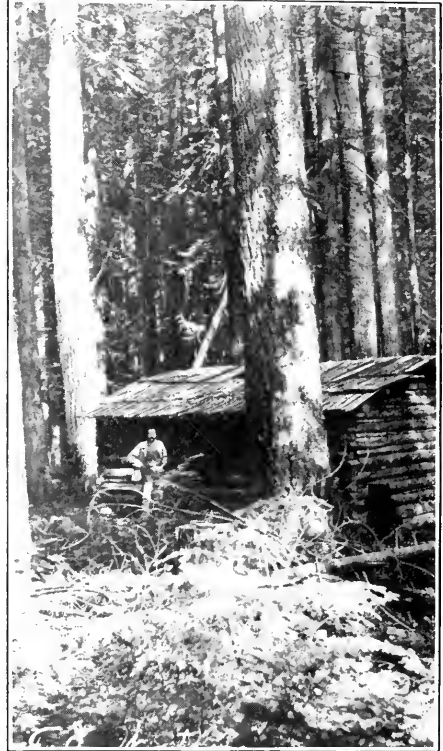

ANOTHER RICH "CLAIM"

This 160 Acres Contains Nearly Ten Million Feet of Valuable Timber

foot bridge across the river. It was constructed of wire cables and short planking, closely set, with timber archways at either end. The bridge is said to have cost originally \$500. From each new settler crossing that bridge to fame and fortune, the old locator collected \$10, as his or her share of building that structure. It is carefully estimated that Cascade Bill located in the neighborhood of 1,200 persons in the twenty years he carried on his system in that country. Thus he realized the fabulous profit of \$11,000 on his original investment.

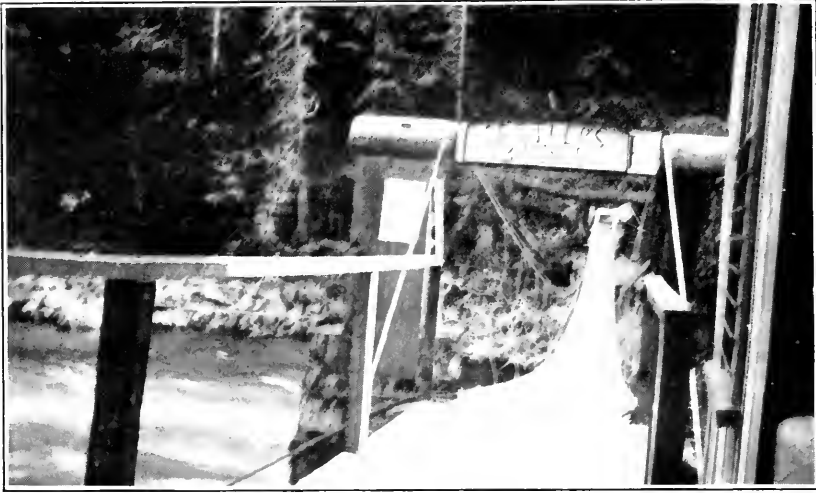

THE SETTLERS' BRIDGE

A Profit of Nearly \$20,000 Was Made on This Bridge, which Cost, Originally, about \$500

And this is not all. Most of these homesteaders located in the vicinity left their claims during the severe winters, and sought residence in the surrounding towns. But Cascade Bill remained on his claim all winter, for there was money in it. About once a month, he dictated a letter to nearly every settler, informing him or her, that a storm had damaged the bridge to such an extent that it would have to be repaired immediately.

He explained that each man or woman's share of the expense would be about \$5. It is said that, in the fifteen years he practiced this scheme, he collected about \$8,000 for repairs to a bridge, which people in Index told me never was damaged but twice in that time, and then was repaired in a half day at a cost of about \$50.

But Cascade Bill soon met his Waterloo, as murder came out. He came home fearfully intoxicated one night in December, kicked his faithful spouse out of doors, locked her in the woodshed, and threw in after her the bones his dog had not touched that night. The next morning he temporarily disappeared, and one of our rangers found the woman in a half-dead condition from cold and hunger, two days later, attracted by her pitiful

cries for help, as he passed near the claim to a ranger station close by.

We took the woman in charge, and after she had fully recovered, she told us one of the most heart-rending stories of abuse that I have ever listened to. A complete separation and divorce followed, and on the condition that she would testify against her husband in land matters, I agreed not to push the poison case against her.

The shadow of prison walls hover grimly over the wasted form of Cascade Bill to-day, and his dreams can only be of the ill-gotten gold he took from the ignorant poor who trusted and listened to him. The guards say that he turns restlessly in his sleep, and mutters something about "fine location," and a "fee of \$325." In a distant northern city his wife, old and gray, is toiling out her few remaining years over a sewing machine, and shedding a tear now and then for the man who came to her many years ago in the excellence of his young and promising manhood, and asked her to be his wife. She can only live over in her memory again a few happy years before he began his downward course, and who envies this isolated woman the little comfort she may gain from a few stray golden thoughts of the buried past?

THE BLIGHT ON CHESTNUT TREES

By JOHN MICKLEBOROUGH, Ph.D., Brooklyn, N. Y.

IN THE summer of 1905, the native chestnut trees in the New York Zoological Park gave evidence of the presence of a very destructive disease. It was soon discovered to be the work of a deadly fungus. Dr. William A. Murrill of the New York Botanical Garden, made a careful study from living trees, twigs and pure cultures and published his observations in June, 1906, and in September of that year gave a scientific description, placing the fungus under the genus *Diaporthe* and from its characteristic habit this new species was appropriately named *parasitica*.

Botanical relations.—The fungi are spore-bearing plants and are regarded as higher than the fresh water and marine algæ or seaweeds, and lower in organization than the mosses or ferns. The fungi include such plants as moulds, mildews, rusts (on plants), mushrooms, and yeasts. The class of the fungi with which we are now concerned are known as the sac fungi or Ascomycetes. Probably 50,000 species of fungi are known to science, and of this number more than 15,000 species belong to the sac fungi. The order of the Ascomycetes to which *parasitica* belongs is termed *Prenomycetes*. More than 110 species of *Diaporthe* have been described. Most of these species are saprophytes—that is, they subsist on dead or decaying tissues. One species, at least, is a parasite, and its only host seems to be our native chestnut trees.

Method of growth.—The spore, carried by the wind, on the feathers of a bird, or in the fur of a squirrel, finds a lodgment where the bark is abraded and immediately develops the threads or filaments, technically called mycelium threads, which constitute the vegetative body of the fungus. The de-

struction begins by a spore gaining access through an opening in the bark to the cambium or thin-walled cells which make new wood on one side and new bark on the other. As the spore develops beneath the bark, there are innumerable thread-cells which grow up and down and especially around the branch or trunk. The tree, or twig, or branch, is now at the mercy of the parasite. In one or two seasons at most the girdle is complete, and all nutriment is effectively cut off from all parts beyond the place of the infection. The girdling is as complete as if one had taken an ax or a saw. During July and August of 1907, and also during the summer of 1908, many branches of chestnut trees showed signs of decay and the green leaves of spring withered long before the frosts of autumn had touched the foliage. By degrees the young bark changed its color from an olive-green to a dull reddish-brown. On the older trees the discoloration of the bark is not apparent, but in the deep fissures evidences of the presence of fungus may be seen. By skilful tapping with a hammer, any one may distinguish the dead from the living bark on the oldest trunks. Where the fungus has been at work, the sound is a tone lower and somewhat muffled and has not the characteristic sound coming from the healthy bark. There is a dead layer between the bark and the wood of the trunk.

But there is another stage of growth to be considered. It is the fruiting body, solely for the purpose of producing spores and perpetuating the species. As the fungus grows, it also matures by sending out through the pores of the bark small oval pustules. These are the fruiting bodies or spore-producing bodies of this parasite. Each



WORK OF THE CHESTNUT FUNGUS

Trees Killed by the Disease which Is Rapidly Destroying the Chestnut Timber of the East

pustule, the size of a small pea, yellowish in color, may enclose several tiny flasks with long necks opening on the outer surface. These flasks are lined with a number of sacs, each containing eight spores. It would take about 500 of these tiny sacs to measure one inch, if placed end to end. About 3,000 of these spores, end to end, would measure one inch. These sacs filled with spores are the resting stage and carry the parasite over the winter months. Early in spring innumerable spores, of another kind and size, are produced in long thread-like masses directly from the mycelium threads. A partition is thrown across the end of a thread and it becomes a spore. Thus spore after spore is produced from the same thread by a process called "abstriction." The sac spores are fertilized spores and the second kind of spores are the asexual ones. There are two distinct kinds of spores, different in origin, but the same in power, each kind capable of producing a new plant. Spores are produced by countless millions.

Geographical distribution.—In October, 1907, woodchoppers were set at

work to cut down all the chestnut trees in Prospect Park in the city of Brooklyn, N. Y. The park has an area of 516 acres, of which about 110 acres are natural woodland. During last winter over 1,400 trees were felled and cut into cord wood. Brooklyn has another park on its eastern border of 536 acres, most of which is natural woodland, and there are in it from 3,000 to 5,000 chestnut trees—many are dead and probably not one can be saved.

The writer delivered an address to the students in the State Normal School at Trenton, N. J., on Arbor Day, May 1, 1908, and an examination of chestnut trees in the vicinity of Trenton gave ample proof of the ravages of the *Diaporthe parasitica*. On Staten Island, on property adjacent to Sailors' Snug Harbor, the disease exists in malignant form. From personal inspection of the forests in the northern part of Somerset County, New Jersey, and also Morris County, very many of the chestnut trees were badly infected. In the localities examined in these two counties, the chestnut growth was very abun-



THE BLIGHT ON CHESTNUT TREES

This Blight Has so Far Confined Itself to the East, where It Threatens Soon to Destroy All the Chestnut Timber Standing. Picture Taken in Forest Park, Brooklyn, N. Y., in June, 1908

dant, the chestnut trees being two to one over any other kind of tree.

The microscope revealed the spores taken from chestnut trees as far north in the Hudson Valley as Newburg. Beyond this point the limit has not been ascertained. During the past summer a careful examination was made on each side of the Kaaterskill Cove in the Catskill Mountains and the chestnut trees were found to be not infected. The trees in the Hudson Valley at Palenville were found to be in a healthy condition. A visit to Hudson City and Athens gave opportunity to examine the growth on each side of the river, but evidently the disease has not yet penetrated so far inland. From reports the infection has appeared in the neighborhood of Philadelphia and in western Connecticut.

Extent of damage.—A conservative estimate would place the extent of damage at not less than \$10,000,000. It is difficult to estimate the value of a tree. The writer examined a beautiful chestnut tree, just north of Catskill City. The trunk two feet above the ground measured fourteen feet six inches in circumference, and the line from the tips of the branches directly opposite was over 100 feet. The owner would not take \$50 for that one tree.

Remedy.—Various suggestions have been made to save infected trees. Spraying with fungicide mixtures, such as bordeaux has not produced satisfactory results. The growing mycelium threads of the parasite are beneath the bark. It is purely a hypophloeous growth and thus escapes the effects of the spray. Some of the thread-like masses of summer (conidial) spores would be washed away, but other bundles of spores will exude from the same pustules. Experiments with arsenical compounds commonly known as insecticides have

not been efficacious. Neither Paris green nor London purple is of any appreciable value.

The cutting away of infected parts and coating the wound with tar is not productive of good results. It would require a most careful microscopic examination to determine how far back to cut, for the reason that the thread cells of the fungus have penetrated beyond the discoloration of the bark. The cutting remedy is not only expensive, but impracticable from the difficulty of determining all points of infection from the trunk to the outermost tips of all the branches. And when the surgical operation has been complete what kind of symmetrical tree is left? Suggestions of injecting a fluid beneath the bark, and into the roots of the tree have been made and reports of such trials are at hand, but in no case has an experiment been successful in staying the ravages without at the same time injuring the tree. A remedy that is as injurious as the work of the parasite is not worthy of consideration. The ground about the tree has been saturated with liquids containing various ingredients, and again nothing worth reporting has resulted from the effort.

Insect pests may be held in check in various ways. Birds devour the eggs and the larvæ. While the larvæ are feeding upon the leaves or boring through the wood poisonous sprays and fumigation may be resorted to for their extermination.

Although a remedy is not at hand, yet man has overcome greater problems. Certainly the problem is now demanding prompt attention since the entire chestnut growth of this country is seriously threatened. There is great consolation in the fact that, so far, all other forest trees have been immune.

THE NATIONAL IRRIGATION CONGRESS

Sixteenth Session, Albuquerque, N. Mex.

NEARLY 900 delegates attended the Sixteenth National Irrigation Congress, the first session of which met at Albuquerque, N. Mex., on September 29. The Congress was one of the most interesting and successful that has ever been held, and the interest, both from a scientific and a popular standpoint, was well sustained throughout the entire meeting.

Messrs. A. P. Davis and C. J. Blanchard represented the Reclamation Service at the Congress; Dr. W J McGee, Secretary of the Inland Waterways Commission, read an extremely interesting paper, while others on the program were: Governor Curry, of New Mexico; former Governor L. Bradford Prince, of New Mexico; Mr. John Barrett, Director of the Pan-American Bureau; Mr. Geo. C. Anderson, the well-known Colorado engineer; Mr. A. L. Fellows, of Colorado;

Mr. C. M. Mott, of Minnesota; Judge D. C. Beaman, of Denver, who is prominently identified with large corporation interest in Colorado.

The fight for the next Congress was a spirited struggle between Spokane, Wash., and Pueblo, Colo., the former city finally winning out. Officers elected for the Seventeenth National Irrigation Congress are:

President, Geo. E. Barstow, Texas; First Vice-president, Col. D. H. Loveland, California; Second Vice-president, R. E. Twitchell, New Mexico; Third Vice-president, I. D. O'Donnell, Montana; Secretary, B. A. Fowler, Phoenix, Ariz.

The members of the permanent Board of Control are: Geo. E. Barstow, Fred J. Kiesel, W J McGee, B. A. Fowler, with one vacancy remaining to be filled.

The resolutions follow:

REPORT OF RESOLUTIONS COMMITTEE

The Sixteenth National Irrigation Congress takes note with great satisfaction of the recent progress in irrigation and in other uses of waters, and records its high appreciation of the fact that greater progress has been made in this direction during the years since the congress has been an active factor in public affairs than during all the earlier years of our country's history. Great as this progress has been, there is need for continued action on the part of this organization and of the citizens who have combined to render the successive congresses successful. In some measure, indeed, it seems clear that the organization has barely passed the threshold of its career of usefulness to the people of our great West.

The leading sentiments growing out of this congress are expressed in the following resolutions:

Resolved, That we signify appreciation and approval of the work of the Federal Government largely in accordance with the

recommendations of past congresses; that we particularly commend and indorse the work of the Reclamation Service in extending the usefulness of the waters of the arid region, thereby increasing our population and production, and multiplying homes on the land, together with the work of the Forest Service, especially in its relation to the protection of the headwaters, the prevention of floods and the regulation of streams; that we indorse and approve the work of the United States Geological Survey, particularly in the Hydrographic and Topographic branches, and strongly urge on the Congress a more liberal support of these branches of the public service; that we approve and commend the work of the Bureau of Soils in its soil surveys, and especially in its demonstration of the adaptability of soils to particular crops throughout the arid region, and urge on the Congress the extension of this branch of the service on a larger scale; that we commend the operations of the Bureau of Plant

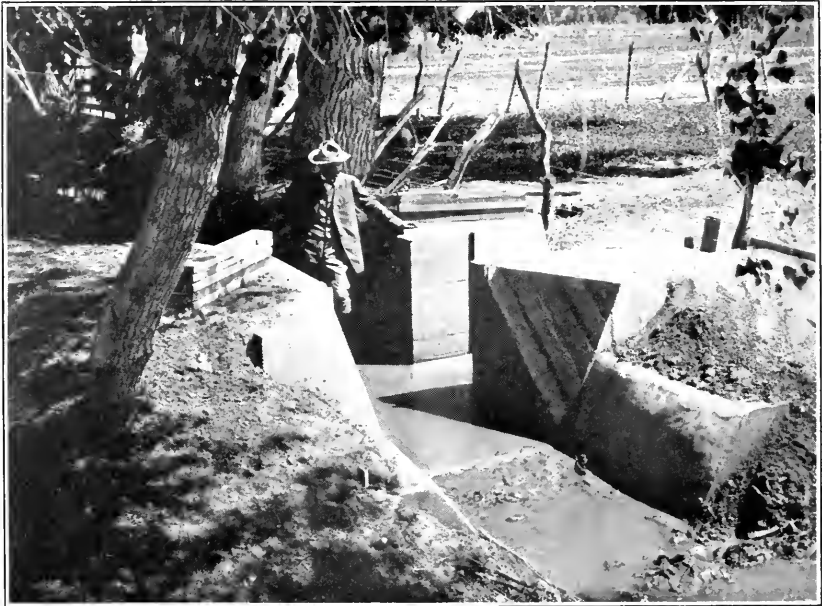

IRRIGATION WORK IN THE WEST

A Concrete Distribution Structure on the Salt River (Ariz.) Project

Industry in the introduction of improved crop plants adapted to arid conditions; that we approve the work of the Weather Bureau and urge more extended determinations of rainfall and climate throughout the western United States; that we indorse and approve the work performed in the offices of Drainage and Irrigation Investigation in the Department of Agriculture; that we commend the plans adopted by the Federal Government for a more complete use and coordination of our living waters for irrigation, water supply, power and navigation, to the end that this great resource may be the greatest good to the greatest number of our people; and that we favor the movement toward the wiser use and conservation of all of our natural resources recently started by the President of the United States and the governors of the several states at the instance of the Inland Waterways Commission.

Whereas, an accurate knowledge of soil conditions is essential to the profitable development of irrigation and agriculture in the arid region, and whereas the Bureau of Soils of the United States Department of Agriculture is supplying this as rapidly as appropriations will permit, therefore, be it

Resolved, That the Congress of the United States is respectfully urged to support the work of the bureau with a liberal appropriation.

Whereas, the Congress of the United States, at its fifty-fifth and fifty-sixth sessions, reduced the appropriation for the topographic and water resources branches of the

United States geological survey from \$350,000 to \$300,000, and from \$200,000 to \$100,000, respectively, and whereas the work of these branches of the public service is especially vital to the development of the arid region because of the necessity of accurate predetermined knowledge of the water supply available for irrigation, and the topographic conditions controlling its use; therefore, be it

Resolved, That this congress respectfully and emphatically urges that these appropriations be restored to the original amounts at the coming session.

That this congress recognizes the growing importance of the development of electric power, not only for the purposes of lighting, manufacturing, and commerce, but also in aid of irrigation by pumping from subterranean sources. Developments already accomplished in this direction warrant the assumption that, in the not far distant future the lands irrigated by water pumped from such sources will equal, if they do not exceed, lands irrigated from the natural flow of streams. The development and use of our streams for the generation of electric power not only aids and increases irrigation directly, but is beneficial in many other ways. First, it renders possible and profitable the construction of reservoirs in the high mountains, withholding excessive floods, thus aiding reclamation and also conserving this injurious flow which is later added to the beneficial flow of water available for irrigation. Second, it is the one great source of supply immediately available for lighting, heat and



A NORTHWESTERN IRRIGATION TOWN
View of Hermiston, Oreg., on the Umatilla Project. Irrigation Brought This Town into Being



A COLORADO IRRIGATION CANAL
Detailed View of Completed South Canal on the Uncompahgre Project

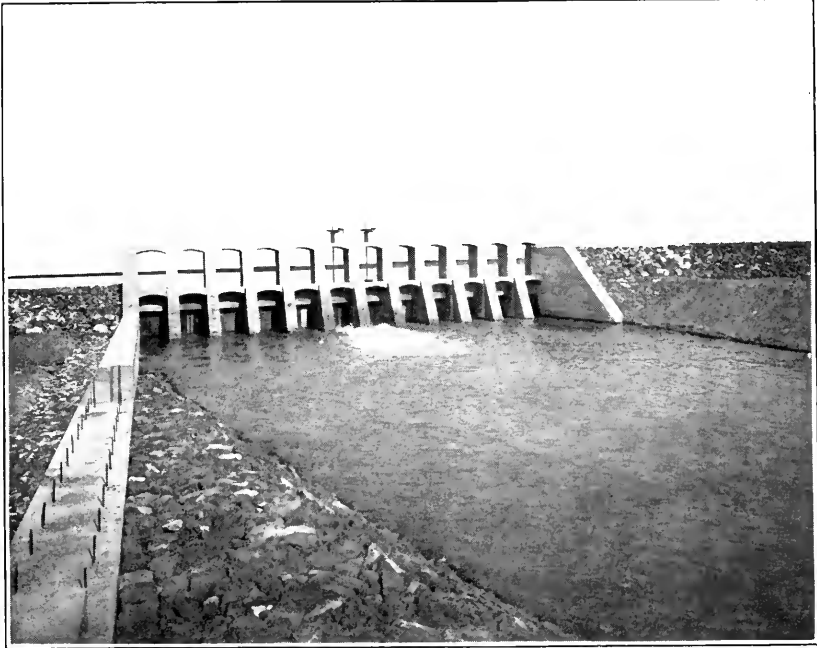

A BIG IDAHO DITCH

Headworks on the Main South Canal of the Minidoka Project

power, as a substitute for other fuels, thus limiting the rapid destruction of our forests and also conserving and saving our supplies of coal and other fuels. Third, the use of electricity for pumping renders it possible permanently to reclaim and irrigate vast sections of our arid lands otherwise impossible of irrigation or reclamation. Fourth, its extensive development will cheapen and extend manufacture and commerce, thus affording an immediate home market for the products of our irrigated farms and also cheapen transportation to other markets. Therefore, be it

Resolved, That the necessary rights of way and rights for the construction of reservoirs and other uses of the public lands, for the development of electric power, should be aided and encouraged in every reasonable way, and all such rights and uses should be granted and allowed upon equal terms with similar rights granted for the direct purpose of irrigation. Such uses being public uses subject to the control of the state, should continue so long as the right to the beneficial use of the water and the duty to supply the power continue under state laws. And no burdensome charges or discriminations should be exacted or imposed as a result of which such beneficial developments may be delayed and the investment of capital therein prevented and the cost increased to the customer.

That the national government, as a part of

the comprehensive national policy of internal improvements for river control and regulation and the construction of inland waterways and utilization of water power, and for the enlargement to the utmost possible extent of the area of the country available for agriculture and homes on the land, and for the protection of those homes from either flood or drought, shall build not only levees and revetments where needed, and drainage works for the reclamation of swamp and overflowed lands, but shall also preserve existing forests, reforest denuded areas, plant new forests, and build the reservoirs and engineering work necessary to safeguard against overflow, and save for beneficial use the flood waters that now run to waste.

That a census of the standing timber in the United States should be authorized by Congress, and that the states should be urged to cooperate with the nation for the preservation and enlargement of our forest resources, by the adoption of uniform forest laws and systems for forest protection, and the preservation and right use of the forests, and that forestry, irrigation, drainage, flood protection, water storage, and river regulation and control for navigation and water power should be regarded as one great inter-related subject in all legislative and executive policies.

That power made available by national irrigation works, when once applied to pumping or other duty connected with irrigation,



IRRIGATION IN KANSAS

The Great Eastern Ditch, on the Garden City Project

should be regarded as appurtenant to the land, and we urge the enactment of laws to this end.

That in indorsing the work of the United States Reclamation Service, we especially commend the plan of cooperation between the settlers and the Federal Government whereby settlers receive credit on their water rights in exchange for labor and material.

That we heartily commend and urge the continuation of the work of the United States Geological Survey in the investigation of the artesian and other underground waters of the arid West.

That we approve and urge the continuation of the wise policies of the states and counties in saving life and preventing suffering in the arid region by providing desert wells and water-saving devices, by erecting permanent guide boards and by providing penalties for their removal or defacement, and by protecting springs, wells, and water-holes from contamination under severe penalties; and that we favor the cooperation of the United States Geological Survey with the states and counties in locating and maintaining these water sources and in disseminating accurate information concerning them, through maps and reports.

That in commending the reclamation act of 1902, we express our satisfaction with recent demonstrations of the large importance of underground waters; and that we favor the utilization of this great resource for irrigation just as the surface waters are utilized,

using pumps and other water-raising devices as adjuncts and parts of the irrigation works.

That we favor and urge upon Congress the early repeal of the Timber and Stone Act, to the end that the accumulation of the public timber lands in the hands of a few great corporations may be avoided.

That we strongly urge upon Congress the speedy creation of the Southern Appalachian and White Mountain natural forests.

That this congress heartily indorses the policy of the present administration in its efforts to preserve timber lands throughout the Union, and we earnestly recommend to the several states their cooperation in the work of preserving the forests in their borders, and recommend in every state the creation of state and national forest plantations, sufficient to supply the demand for wood and timber of the people of such state. While appreciating the importance to the West and the entire country of the protection of our forest by every adequate means, we favor the highest utilization for all economic purposes of all our public lands.

We therefore recommend that an adequate appropriation be made at the next session of Congress for the use of the hydrographic division of the geological survey to determine by experiment, measurement and observation the practical effects of grazing and lumbering on the supply of water for irrigation, and on the erosion of soil, and silting up of streams and reservoirs, and we recommend that such investigations extend over the en-

ture watersheds both in and out of national forests, and that such investigations be prosecuted simultaneously throughout all the states and territories in the arid and semi-arid West.

The importation of free tropical sugar in competition with our home product would be destructive of the domestic industry. We therefore urge our Representatives and Senators to earnestly oppose the enactment of any legislation that would allow such competition.

That we favor the adoption of vigorous measures in each of the trans-Missouri arid and semi-arid states and territories to secure the creation of immigration bureaus,

That whenever large tracts of land suitable for agriculture and which are not natural forest, and which are not intended to be made forest and which are not necessary or proper for the preservation of the forest or the watershed or water supplies for the purposes to which they have been devoted, lie within forest reserve boundaries, such tracts should be restored to entry as public land.

That we urge the Congress of the United States to amend the so-called Carey act, so as to make it apply to the territories as well as states.

That it is desirable that this congress shall cooperate so far as it may be able, with the National Conservation Commission for the



AN ARIZONA IRRIGATED RANCH

Canal at the McQueen Ranch, in the Salt River Valley, near Mesa, Ariz.

supported by liberal appropriations, in order that reliable and official information may be available for the benefit of homeseekers.

That this congress expresses its appreciation and indorsement of the tree-growing movement being promoted by the Federation of the Tree Growing Clubs of America.

That it is the sense of this congress that such legislation should be had, in justice to the Forest Service and claimants to property rights within national forests, as will provide for a review at the instance of any party affected, by a competent tribunal, of controversies relating to homestead entries, or forest control or regulation, or arising from any action, regulation, or the ruling of forest officers.

promotion, and accomplishment of its purposes, and the president of this congress is authorized and directed to appoint a committee to be known as the conservation committee of the National Irrigation Congress, which shall consist of the president of this congress and four other members, to be appointed by him, to cooperate and aid the National Conservation Commission in its objects and purposes in so far as they coincide with the objects and purposes of this congress.

That in harmony with the report of the special committee authorized by the Fifteenth Irrigation Congress, we urge the importance of holding an early session of this congress,

at Washington, D. C., and authorize the president of this congress to appoint a committee of three, to communicate with state and territorial legislatures, with a view of securing appropriations and of taking such other steps as may be necessary to effectuate the purposes of this resolution, such committee to report at the seventeenth session of this congress.

Whereas, the members of our National Congress at Washington should be familiar with the sentiments which find expression in the resolutions adopted by the National Irrigation Congress at its annual sessions. Now, therefore, be it

teous care for the welfare and comfort of the delegates;

To the governments of France, Brazil, Chile, Canada, Cape Colony, Germany, Italy, and Mexico for the interest and recognition shown in the appointment of delegates to the congress;

To the press of the city, territory, and country for the consideration shown in the reports of the proceedings;

To Frank C. Goudy for the frank and impartial manner in which he has presided over the deliberations of the congress, and

To B. A. Fowler, the efficient secretary of the congress;

To W. S. Hopewell and R. E. Twitchell,

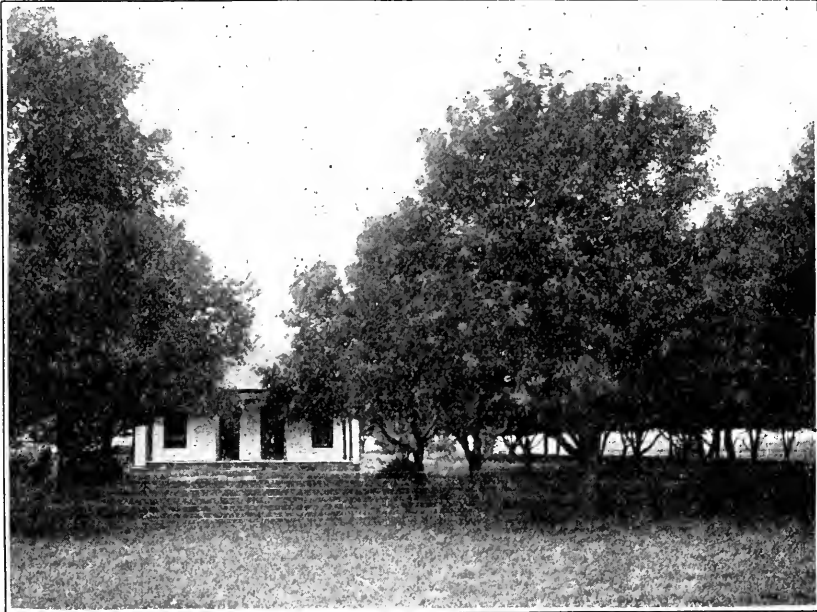

A KANSAS FARM

Shade Trees and Orchard on the Garden City Irrigation Project

Resolved, That the president of the National Irrigation Congress be empowered to appoint a committee of five to be designated as the Congressional Committee, whose duty it shall be to present the resolutions adopted by this congress to the National Congress at the session following their passage by this congress and to urge their importance and the necessity of their recognition by the National Congress.

Resolved, That the congress extends its sincere thanks to the territory of New Mexico, and the city of Albuquerque, its commercial organization and citizens for the hearty welcome and generous hospitality which have been extended to the members of this congress; also

To Governor Curry, and to the other officials of the territory and city for their cour-

teous care for the welfare and comfort of the delegates;

To Miss Caroline Strong, the conductor, to the quartet, and to the chorus of ladies and gentlemen who furnished the excellent musical program for the congress; also

To John J. McClellan, the author and composer of the Irrigation Ode;

To the Mexican Government for the presence of the Regimental Band, of the state of Chihuahua;

To the Atchison, Topeka & Santa Fe Railroad Company for its enterprise and effort looking to the success of the congress.

That this congress requests that the report of the proceedings of its sessions be published within thirty days.

NATURAL MOVEMENT OF WATER IN SEMI-ARID REGIONS*

By W J MCGEE, LL.D

Secretary, U. S. Inland Waterways Commission

THE average annual rainfall on mainland United States is estimated at thirty inches; the aggregate at 200,000,000,000,000 cubic feet. This is the yearly boon from the heavens, the virtual source of every industry, indeed of habitability. Without it the land would be bare rock or sun-scorched sand; the lower atmosphere without the tempering influence of the moisture would range from below freezing to boiling temperature from night to day; and no living thing could exist.

This annual water supply, as our primary resource, may be counted our capital. Without it no other resource would possess the slightest value. Of it the amount varies slightly from year to year; yet there is no more. It may be used or wasted; in the end, if we are wise, it will all be used, regulated, and controlled in such manner as to yield the greatest good to the greatest number for the longest time.

Taking mainland United States as a whole, our 200,000,000,000,000 cubic feet of liquid capital may be expressed as ten Mississippis. About one-fifth of all, equivalent to two Mississippis, flows through waterways into the sea, while five or six Mississippis in quantity are evaporated to temper the air, form dews, and in part redescend as rains or snows. A part of the remainder seeps into the soil below the surface, or permeates deeper rocks; and it may be estimated that something like a tenth of the whole, or an equivalent of a Mississippi, is utilized in plant growth and in animal assimilation. It is this frac-

tion which is of most immediate and general use to mankind.

The distribution of the natural supply varies with seasons; it varies still more widely with regions. Approximately two-thirds of the aggregate amount falls on the eastern two-fifths of the country; the remaining third on the lion's share of our territory lying west of the ninety-fifth meridian—for the average west of that meridian is only about eighteen inches, while that of the eastern fraction is some forty-eight inches. Within the larger western area the range is greater than in the east—from over sixty inches on the northwestern coast down to less than one-tenth of that in certain arid spots of the southwest. The distribution by what may be called function is also wider in the larger western area.

In defining the natural functions of the water resulting from rainfall, it should be noted that scarcely anywhere in the United States is the rainfall excessive, i. e., greater than can be used beneficially by growing plants, living animals, and intelligent men (as is the case in certain tropical countries); nearly everywhere it falls below the aggregate best adapted to organic development. Thus eastern United States might produce more abundant crops, develop greater industries, and sustain a larger population with a well-distributed rainfall of sixty inches than it is able to do with the mean precipitation of forty-eight inches. With a rainfall of sixty inches, and with other climatical features as they are, probably half of the aggregate would evaporate.

*Read before the National Irrigation Congress at the sixteenth session, held in Albuquerque, September 23-29, 1908.

when its function would be to temper the atmosphere, form dews, etc.; probably another quarter would flow into the seas, and might be utilized for navigation, power, etc.; while the greater part of the remaining quarter might be utilized in vital and chemical functions (including plant growth), all subject to more or less definite human control.

Throughout the western three-fifths of the country the precipitation is far less than that required for the highest organic growth—except in so far as human genius and creative capacity can improve on the processes of nature. Here probably no more than a tenth of the rainfall runs back to the sea; excluding the northwesternmost districts, in which the precipitation is high, probably no more than a twentieth so leaves the land. The evaporation is larger than in humid lands, probably exceeding three-fifths and possibly three-fourths of the rainfall; it would be far greater were there more water to evaporate; and the quantity evaporated is not enough to temper the atmosphere completely, so that dews are scant and the daily range of the thermometer is wide. Probably less than a tenth, perhaps no more than a twentieth, of the total rainfall remains available for the most important function of all, i. e., the sustenance of organisms, including plants, animals, and men.

Neglecting the loss by deep seepage and a few other minor factors, the great functions of water are (1) evaporation to temper the atmosphere; (2) returning to the sea, thereby removing excess of earth-salts and affording facilities for navigation and power; and (3) entering into chemical combinations largely in organic growth. The portions of the water involved in these functions are sometimes denoted the fly-off, the run-off, and the cut-off; and other things equal the benefit to plants, animals, and men, is proportionate to the cut-off. Now, in all portions of the country the fly-off and the run-off are greater, and the cut-off proportionately less, than required for highest productivity; and in the larger western portion the distribution is much less fa-

vorable than in the smaller eastern portion. Such are the primary natural conditions; yet, especially in deserts, both nature and man have improved on these conditions in ways affording greater promise to prospective human development than can be found in any other direction—the promise that the desert shall blossom as the rose, and that the people of our vast semi-arid regions shall in good time guide the ship of state and direct our moral emprise.

In a state of nature, the running waters of arid regions comport themselves differently from those of humid lands. In the latter it is the law of running water to gather into streams which make for themselves channels and gradually shape the entire land in forms permitting the water to flow down to the sea with greater ease and swiftness. Not so in arid districts; here it is the law of running water not to gather into streams, but to spread into sheets facilitating soakage and evaporation into the thirsty soil and air, so that the water tends to remain on the land instead of flowing seaward; and during the ages these sheet-floods tend so to shape the land surface as progressively to reduce the run-off seaward, and progressively increase the ratio of water retained. It is this peculiar law of running water, coupled with the slow but ever acting work of the winds that yields the distinctive forms of arid landscapes—those combinations of far-stretching plains with rugged and precipitous ranges wide-scattered between, giving the effect of lost mountains buried to shoulders in their own debris. At last railway engineers are learning the law of the desert water—they are finding that to make culverts useful on the gently sloping plains they must build out wing-dams to concentrate the sheet-floods, which, on passing the obstructions, quickly spread again. Such is nature's device in arid regions for retaining water on the land rather than throwing it quickly back into the sea; plants and animals have unwittingly learned of it; and it behooves mankind

first to learn and then to improve on nature's ways.

In the driest portions of our vast semi-arid region the plants are peculiar. Among the prevailing types, leaves are few and small, or else unfold quickly during the rainy season to wither at once when that short season passes. Such typical desert forms as the cacti never leaf at all; they are virtual reservoirs of water, retained by a glazed epidermis, and distributed throughout tissues largely of starch and cellulose abounding throughout in chlorophyll—that marvelous substance which enables plants to absorb the energy of light, and by some obscure alchemy to convert it into vital power. In a word, the desert plants are *par excellence* water-conserving organisms; they are nature's devices for making the best and largest use of a scant water supply. By nature's methods these plants and their associated animals have been evolved together through the bitter strife for existence against the common enemies of sun and sand.

The vital processes of the desert organisms are adapted to the retention and utilization of water. The gigantic sahuaro and titanic sahuasa absorb water literally by barrels, fattening enormously during and after each rain; the nopal and the cholla drink by the bucketful and the bisnaga by the gallon, perhaps for the benefit of animals and men during the next dry season. They can hardly take water direct from the air, since their glazed skins are impervious, but their rootlets suck liquid from the soil and perhaps draw moisture from the air permeating it; and it is probable that during prolonged rainless periods they convert a part of their own starch and cellulose into the water required for vital circulation. Similarly, the animals of deserts have become adapted to life with less water and taken at less frequent intervals than the animals of humid lands; certain desert mice indeed living for months and years absolutely without drink through digestive decomposition into water and carbonic acid of the starch contained in the seeds on which

they subsist. Such are among nature's ways of making the best and largest use of the scanty water supply of arid regions.

In our great Southwest the aborigines adapted themselves to the arid conditions in a manner nothing less than marvelous to the anthropologist. At a period some three to five centuries before Columbus came (before certain exterminating intertribal wars arose), the region traversed by the Southern Pacific Railway between El Paso and Bakersfield sustained an aboriginal population probably three to ten times greater than the present mixed population sustained in part by imported products. In the magnificently irrigated Salt River Valley the modern ditches are less extensive and reach a less extended area than the ancient acequias; while prehistoric repesos and temples and houses dot deserts where now no man lives. These ancients were largely agricultural folk; their descendants survive in the Papago Indians of the farther deserts, and in part in the Pueblo peoples of the mesas; and it cannot be questioned that they were populous throughout this hard region by reason of their success in adjusting themselves to natural conditions and ways of nature, and making the largest and best use of their scanty water supply. The devices retained by their survivors are too many for telling in an hour; yet they are well worth study, and it behooves modern man entering on the conquest of the deserts to first learn and profit by and then improve on their methods.

A single lesson may be drawn in passing from the customs of desert folk on this continent and others. Just as the plants and animals of our deserts grew up in mutual adaptation and inter-adjustment through common strife for survival against sun and sand, so the native tribesmen entered into the same solidarity; and the plants and animals and men strove together. One effect was to establish a community of feeling, centered on water as the chief source of life, the most precious of all commodities; and those tribes and

groups and pairs enjoyed the best chance of survival who most generously interchanged this priceless boon. So arose that altruism which distinguishes all the higher types of mankind from all lower types; and it was thus in accordance with natural law that the world's civilization naturally and necessarily arose in the world's deserts. Thereby is history's tale verified and justified; for the world's greatest inspirations have been born where the intensity of life and of human motive is greatest—and the desert germs have spread and blossomed throughout the entire world to the benefit of all mankind.

During recent decades the examples of other dwellers in arid lands have been followed with advantage in our country. The fig and the date and durum wheat have been introduced, and dry-farming has been adopted; and thereby the habitability and productiveness of our greater western territory has been increased. Yet it is worth while to inquire whether the most promising line thus far opened is not that of directly improving on nature's devices in our southwestern districts—of Burbanking cacti and other plants, and by extending the field of invention into vitality, progressively recreating the natural fauna and flora along the lines started by nature but at a more rapid rate. The work of our desert laboratories has but begun; yet already they are pointing the way toward almost unlimited improvement among organisms adapted to arid environments. The pre-Columbian natives produced figs from thorns; now comes MacDougal, getting grapes from thistly cacti. And it is not too much to hope that their methods, coupled with extension of irrigation up to the full capacity of the rainfall, will largely reconstruct the flora and fauna of the arid lands and greatly enrich the same arid regions. The ideal to be kept in mind is that so clearly indicated by

the natural movement of waters in arid districts—the retention, conservation, and full utilization of the entire rainfall. The fly-off can hardly be reduced, though with every increase in vegetal covering it can be better utilized, and may even be made to produce more abundant dews if not increased local rainfall; the storm run-off can be and should be checked, leaving only enough to carry away excess of earth-salts; and the effective cut-off can and should be increased somewhat in quantity and greatly in efficiency.

Nor is this the end; for when the people of the arid and semi-arid territory make conquest of land and water for their own benefit, they will bring even greater good to the rest of the Nation in clarified views of relations, of the real bases of National prosperity. It is in the nature of things that inhabitants of arid lands first come to realize the priceless value of water as the prime necessary of life; and their customs, and eventually their laws, grow wise and beneficent. Had our country been settled from the Southwest instead of the Northeast, we should have had a more judicious body of statute and a more widely applicable common-law than now; and it is not too much to hope that the most significant chapters of human history will be repeated, and that the inspirations and beneficences begotten in arid lands will again make their influence felt—and that our National culture and statecraft may be bettered through the intensified vitality and exalted spirit of our deserts. Some day the wisdom of Arizona and New Mexico will be infused into our Constitution, not by amendment, but by interpretation and common judgment; and with it will come a closer union of States than that which first made our colonies a Nation, a union based on that fundamental resource that gives value to all the rest.



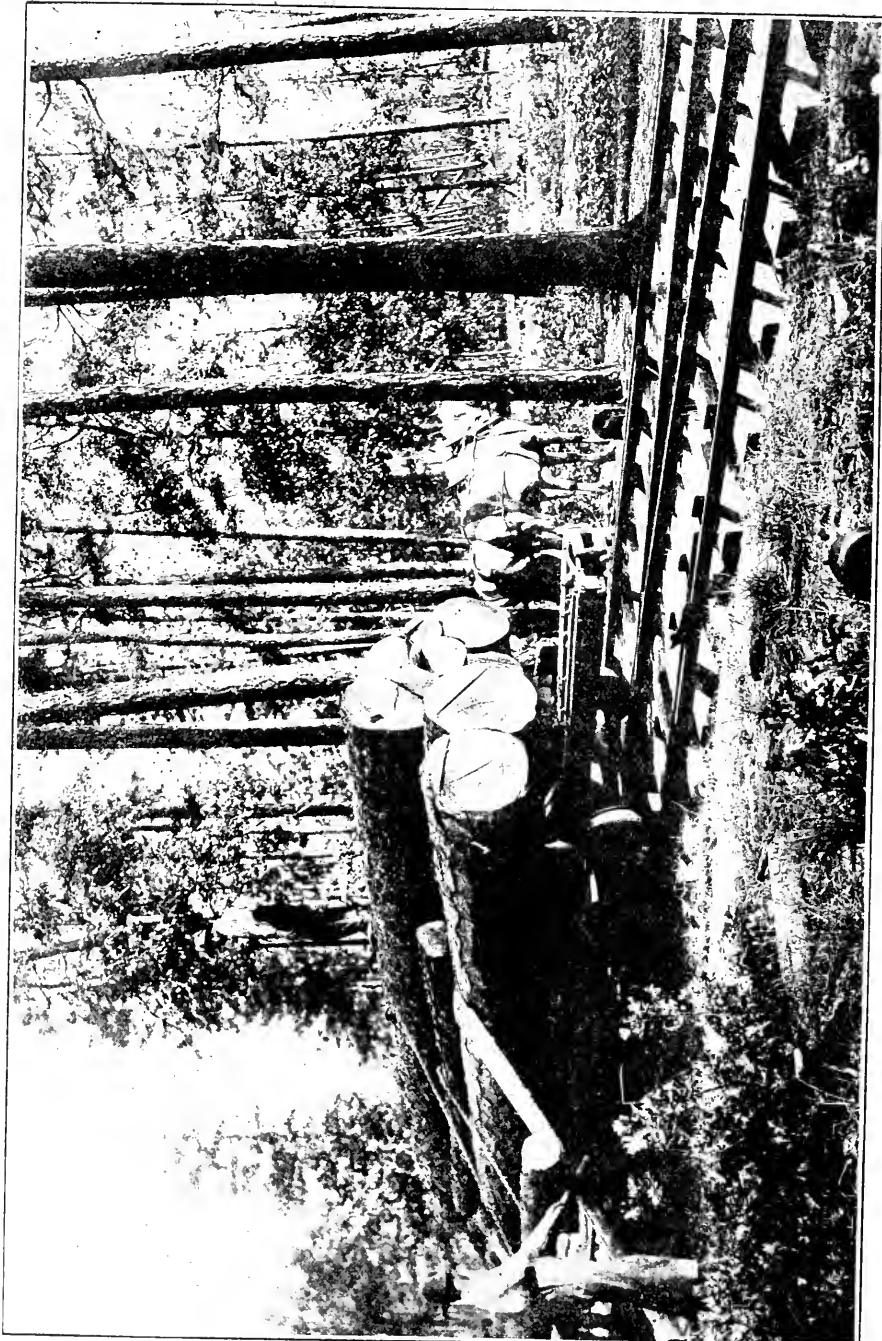

LUMBERING IN THE SOUTH
Skidding Long-leaf Pine Logs in a Louisiana Lumber Camp

THE LAKES-TO-GULF CONVENTION AT CHICAGO

THE third annual convention of the Lakes-to-Gulf Deep Waterway Association, held in the Auditorium Theater, Chicago, October 7-9, was notable in several respects. In the first place it is claimed to be the largest waterway convention ever assembled in the United States, the official roster comprising some 4,300 delegates from forty-four states; and in the second place, it brought together for the first time in American history, the Presidential candidates of the two great political parties to occupy the same forum, and essentially the same platform so far as concerns the paramount issue now before the American people—that of improved transportation through waterway development. It was even more notable in that, for the first time in such an assemblage, no effort was made to solicit the favor of Congressional leaders, or to get any public men on record; the position assumed being that of citizens representing a majority of the people determining in convention the lines of policy which the people demand shall be carried out. Conformably with this position, the address of the President was one of the broadest and most stalwart utterances ever made in a waterway convention; while the resolutions framed by a committee drawn from some thirty states and unanimously adopted by the entire Convention are far and away the most comprehensive, constructive, and vigorous thus far framed in the waterway interests of either the interior or the country at large.

After assembling on the morning of October 7, the address of President Kavanaugh (printed in later paragraphs) was delivered; it was followed

by a notable report submitted by Secretary Saunders. At eleven-thirty Judge William H. Taft was introduced and received a stirring ovation. He delivered a scholarly and effective address, indicating the need for waterway improvement on a comprehensive scale, pointing out the defects in the methods hitherto pursued, and explaining the policy of the present and prospective administration regarding the complete control and utilization of running waters for navigation and all related purposes by methods involving cooperation between the Federal Government and states. The address elicited great enthusiasm.

The afternoon was devoted to an inspection of the great sanitary drainage canal connecting Lake Michigan with the Illinois River, by means of special trains and barges provided by the Chicago Association of Commerce, the host of the convention. Delegates and other guests (including ladies) filled four special trains on the Santa Fe Railway.

No exercises were set for the evening by the association; but several of the officers and delegates, including the Governors, Senators, and Representatives in attendance, were guests at the fourth annual dinner of the Chicago Association of Commerce, in the Auditorium Hotel, in celebration of the rebuilding of Chicago since the fire of 1871. This function was made especially notable by the presence at the same board, at either side of President Richard C. Hall, of Judge William H. Taft, and Hon. William J. Bryan, as chief speakers.

During the morning session of October 8 a most effective paper, emphasizing the necessity for waterway improve-

ment and urging that the work be done by direct Federal appropriation, rather than on a bond basis, prepared by James J. Hill, of the Great Northern Railway, was read by Congressman Rainey. At eleven-thirty Hon. William J. Bryan was introduced and received a striking ovation. He delivered an eloquent address, urging the pressing necessity of waterway improvement on a comprehensive plan comprising the conservation of all natural resources relating to the running waters, and indicating the definitely constructive policy for which he stands. The address evoked enthusiastic applause.

The feature of the afternoon session was an address by Hon. Gifford Pinchot, Chairman of the National Conservation Commission, on the subject of "Waterways and the Conservation Movement." Mr. Pinchot defined conservation as the application of common sense to the common good, and explained in detail the necessity of proceeding along broadly constructive lines in the improvement of our waterways in such manner as to secure for the people of the country generally the full commercial and industrial benefits to be derived from the control of the waters, themselves ranking among our richest resources. The address received close attention, and evoked emphatic expressions of approval. The remainder of the afternoon was devoted to five-minute talks by delegates, which did much to crystallize sentiment and determine the character of the convention.

The evening was devoted to a reception in the Coliseum, at which Hon. John Temple Graves delivered an eloquent address, strongly commending the waterway movement.

On Friday morning several committees reported that on nominations recommending the reelection of the former officers, which was done with enthusiasm; the list including Mr. W. K. Kavanaugh, of St. Louis, President; Vice-presidents from the interior states; Mr. W. F. Saunders, of St. Louis, Secretary; Mr. George H. Mon-

roe, of Peoria, Treasurer; a Board of Governors chosen from the interior states, and an Advisory Council, consisting of the executives of the commonwealth's most affected by the project for a lakes-to-gulf deep waterway.

The election was followed by the address of Col. John A. Ockerson, of the Mississippi River Commission (U. S. Delegate to the International Congress of Navigation, recently held in St. Petersburg), entitled "What Europe is Doing with Waterways." The speaker pointed out that while our railway facilities are superior to those of Europe in economy, this advantage is more than counterbalanced by the greater distance of freight movement in America; and that Europe is so much better advanced in waterway development as to give this country object lessons which must be first followed and then carried further if our commercial supremacy is to be maintained. He was followed by Mr. Theodore P. Shonts, President of the Chicago and Alton system paralleling the line of the lakes-to-gulf deep waterway (also President of the Interboro Rapid Transit System of New York, and formerly Chairman of the Panama Canal Commission) in an address on "The Future of Rail and River Transportation." Mr. Shonts held, as does Mr. Hill of the Great Northern, Mr. Harri- man of the Illinois Central, Mr. Finley of the Southern, and all other leaders among the railway systems paralleling the Mississippi and its tributaries, that the improvement of navigation in, and the restoration of commerce to these rivers will not only be advantageous to the railways, but that it is imperatively required in order that the railway systems may be made of the highest value to the people of the country traversed by them. Both addresses evoked great applause.

The consideration of the report of the resolutions committee was assigned for the afternoon session; but on a vote it was called for during the morning session and was submitted by the chair-

man, Mr. Alexander Y. Scott, of Mississippi. It was accorded a most favorable reception, many of the paragraphs being roundly applauded; and after brief expressions of commendation it was unanimously adopted. After authorizing the President to appoint a committee of fifty to lay the resolutions formally before the President of the United States, the Vice-president and the Speaker of the House of Representatives, the convention adjourned to reassemble in New Orleans in November, 1909.

During the afternoon the delegates were accorded a unique treat by the members and friends of the Chicago Association of Commerce, in the form of an automobile ride of forty miles along the lake front and through the leading parks and business districts of the city—the unique character of the event lying in the fact that there were 1,000 automobiles in the procession, following a line some five miles long.

The address of President Kavanaugh follows in full:

A paramount issue confronts the people of the United States. In technical English this issue may be expressed in the question: "Shall our Natural Resources be Conserved and Developed?" With equal truth, this issue may be expressed in the broader question: "Shall our National Prosperity be Promoted and Perpetuated?" For the conservation and development of our natural resources equals the promotion and perpetuation of our National prosperity.

It is a noteworthy fact that this issue has become paramount since the creation, two years ago, of this, the Lakes-to-the-Gulf Deep Waterway Association, whose principal object is the development of those great natural resources, the Mississippi and its tributaries.

Other organizations of citizens have helped to raise this issue. Much has been done by different river improvement associations of the interior and the Pacific coast; by the Atlantic Deeper Waterways Association, created a year ago, along lines similar to those of this association; by the Trans-Mississippi Congress, the National Irrigation Congress, the Upper Mississippi River Association, the Missouri River Improvement Association, the Ohio River Improvement Association, the Arkansas and Red Rivers Improvement Associations, and especially by the National Rivers and Harbors Congress, whose field is the entire country. We dispare no other organization, no other move-

ment. All are needed, and we cordially invite cooperation. Yet it is a fact that this association was more largely instrumental than any other in securing for the great policy of waterway improvement the unqualified support of the National administration, and the equally vigorous support of all the leading political parties. Hence this association may fairly claim a large measure of the credit for that paramount issue which has arisen for decision by the American people.

The field of this association is a favorable one. Occupying the very heart of the country, it has become so rapidly the real center of the country's growth, activity, wealth, and power, that many have failed to follow its progress. In area, it is one-half the United States; in number of states, it exceeds a score, including all those commonwealths which are richest in agricultural and mineral output; in population it has grown more rapidly than any other section of the country, until to-day in the states drained in whole or in part by the Mississippi with its tributaries and by the other rivers flowing into the Gulf on the south or the Great Lakes on the north, live fully one-half of the citizens of the Nation; and reckoned by the proportion of free holders and independent producers, it includes much more than one-half of the Nation's effective population. The time has come for these citizens, the bone and sinew, the brain and intelligence of the Nation, to speak for themselves, for their interests, for their posterity, for *the Fate of the Nation, yea, that of civilization and enlightenment, rests in the hands of the sturdy sons of this, the Great Mississippi Valley.*

The Interior Empire is drained by the greatest river of the Continent, one of the greatest in the world, the mighty Father of Waters, which, with its tributaries, reaches from our Northern boundary to our Southern limits, and from the Alleghany Mountains on the East to the Rocky Mountains on the West.

In early days, settlement of the Great Valley was rendered possible by navigation of the main river, the Ohio, and other tributaries. At a later time, the Missouri, Arkansas, Red, White, and other rivers opened the way to settlement and development of the vast area, stretching to the foothills of the Rocky Mountains. So long as pioneer conditions continued, all the larger rivers were freely navigated, albeit with the difficulty which pioneers expect to overcome, and which they have the heart and the strength to overcome—else they would not be pioneers. Half a century ago, even one-third of a century ago, the Mississippi and its mighty affluents carried steam packets, barges, and other water craft in hundreds. The rivers were the chief theater of activity throughout the interior; they made our commerce and production; they brought culture; they made our Nation. Then the reaction came. When the pioneers tired of striving against obstructions,

many of them increased by settlement, they appealed to the Nation for assistance in overcoming the obstacles—in maintaining a river commerce sufficient to meet the needs of the growing population and production. Now, we are hopeful and progressive American citizens, yet we are not *blind*. To-day we must realize that the appeal to the Nation fell on deaf ears. The Nation did not respond. As the President of the United States recently said, there is less commerce on the Mississippi and its tributaries to-day than there was fifty years ago. The great packets and busy barges are gone. Their disappearance marks the blackest chapter in the history of the American Nation—a chapter of National indifference or incompetence, of bitter disappointment, deep discouragement, and serious loss to the people. To-day the strength of the Nation lies in the interior. How much greater would that strength have been had the National councils performed their duty and afforded proper facilities for commerce!

The decline in our transportation cannot justly be charged to any particular agency, such as the railways; for as a matter of fact, railways and waterways are and always should be complementary agencies for the carriage of freight and for other traffic—and it is especially gratifying to note that since this Association was created, the leading railway men of the Nation have signified approval of the waterway policy, and have been among the most effective workers in this association.

But why have the National authorities failed? Surely not because of fear of imposing a tax on industry and property, for the indifference, the failure to supply adequate transportation facilities, has always been and is to-day a heavier tax on the energy and enterprise of our people than any other; in fact, heavier than all others combined. Growing communities need and can bear a just taxation; but no community or country deserves or can bear up under the taxation of indifference and incompetence.

What is true of the Mississippi Valley is in some measure true of every section of the country. The rivers of the Atlantic, Pacific, and Gulf coasts require development. Our canals, once a great means of enrichment of the country, should be restored. We, of this Association, are sought and encouraged with the valuable efforts of other sections to find relief from that burden of taxation pouring out of a dilatory and indifferent waterway policy; yet we hold—and we challenge any and all to dispute our claim—that since the Mississippi is our greatest river, draining half our country and sustaining half our population, it must be the central feature of any plan for waterway improvement. We, of this Association, therefore urge the adoption of a broad and vigorous policy of Waterway improvement. Let it begin with the Mississippi and let other rivers and other

sections follow as rapidly as practicable; let us, as citizens of the common country, unite with those of other sections in advocating a broad policy, and let us urge on them the wisdom of joining us in our demand for a plan of waterway improvement, beginning with our main trunk line; and let us make it clear that we no longer beg nor crave the indulgence of the Nation, but that as constituents of the Nation and a majority in numbers, we *demand* that the National duty be performed, and that promptly! What we need, and what this association seeks, is a broad and sound National policy of waterway improvement, and a definite purpose in carrying out this policy.

Experts declare that our waters form our richest resources, giving value to all the rest. They tell us that our waterways cannot properly be improved without at the same time improving the lands on which the waters gather, improving the forests about the headwaters of streams, and reducing the drain on the iron and coal now required to transport by expensive agencies the abundant products of our fertile fields and rich mines.

We concur in every claim for the conservation of our resources and repeat the demand in the interest of this association and the states it represents; yet we insist that any and all plans for the conservation of our natural resources must and shall begin with the improvement and proper utilization of our waterways for the purpose of navigation and commerce.

Let us not be understood to lay undue or excessive blame on the Nation for the decline of our navigation—the failure of our water transportation. This would be glaringly unjust in view of the chief result attending the work of this association. At the instance of the Board of Governors of this association—a board than which none other was ever more courageous, devoted and self-sacrificing—the President of the United States appointed the Inland Waterways Commission to perfect the plan on which this association was already at work. On the joint recommendation of that Commission and this association, the President of the United States a year ago visited the Mississippi, and, for the first time in the history of the country, made it clear that the administrative branch of the Federal Government is determined to enter into and carry to successful completion a broad policy of waterway improvement just as rapidly as the legislative branch will permit. Nor can we forget that since this association was created, a large number of National Senators and Representatives, together with the state governors and legislators, have signified their adhesion to that policy, and have undertaken to see that it is carried out. These wise and devoted statesmen are too many to be mentioned now, their names, with those of the President and his Cabinet, will form the roll of honor in

this, our second great American Revolution—a revolution against the tyranny of transportation.

Let the great army of delegates gathered here to-day imbibe this revolutionary spirit, and let each carry back from this convention to his post of duty sufficient enthusiasm to assure the election of candidates for Congress who are willing to pledge themselves to work for the great policy of waterway improvement!

Following are the resolutions adopted:

This, the third Lakes-to-the-Gulf Deep Water Convention, the largest waterway convention ever assembled in the United States, including some 4,000 delegates from forty-four sovereign states of this Union, representing the commercial, agricultural, manufacturing, and mercantile interests of the entire Mississippi Valley, and having deeply in mind and at heart the prosperity and welfare, not only of the People of the Mississippi Valley, but of the whole Nation, and realizing that the moral and spiritual stamina and growth of the Nation as a whole depends upon the material welfare and prosperity of the individual citizen, do hereby—

Resolve and Declare: To promote the general welfare is recognized by the Constitution of the United States as one of the fundamental principles of government.

The general welfare of the People of the United States can best be promoted by establishing the commerce of the country on a sound basis, and by so enlarging it that agricultural and mineral resources may be developed to the end that production and manufacturing may be encouraged and that all other lines of independent business may be increased.

Easy and adequate transportation, effective between producer and consumer, and for carrying the abundant produce of the country to the seaboard for shipment abroad, is the first essential for the development of the commerce of the United States; and the responsibility for this development rests on the general government.

It has been demonstrated during the past ten years that when business conditions in the United States are normal, the transportation facilities afforded by the railways are utterly inadequate; and it is stated by the great traffic managers of the railways that the development of railway facilities cannot keep pace with the increased demands upon them. The leading railway authorities, including prominent officials of all the great lines which parallel the Mississippi, declare that water transportation must be developed to supplant the railways in order that the freight of the country may be handled properly and promptly.

Under the Constitution the regulation of commerce between the States devolves on the general government, and under those deci-

sions of Chief Justice Marshall, which are universally accepted as our best interpretation of constitutional powers, the control of waterways and the regulation of navigation also rest with the general government, and neither States nor private capital can be permitted under the Constitution to assume these duties.

The duty, therefore, devolves on the general government to give to the country adequate transportation facilities by developing the navigable waterways of the country into complete freight-carrying usefulness. This duty should be recognized by the Congress at once, and the waterways should be made efficient freight-carriers, otherwise the United States cannot maintain commercial equality with those other nations of the world now equipping their waterways as freight-carriers and considering their railways and waterways as complementary agencies; and in no other way can this country derive benefits equaling those of other countries from the building of the Panama Canal.

The all-important question of transportation is a paramount issue. If it be found that the current revenues of the government are insufficient for carrying out vigorously and on a broad plan the development of our waterways, the Congress should secure funds for that purpose by providing a sufficient bond issue.

The interior valley comprises approximately half the area of the United States. It is 2,500 miles in length and 2,000 miles in width. Within its boundaries lie the greatest producing states of the Union. The arms of this great river system form the boundary lines of twenty-one states, and over 20,000 miles of possible navigation. This vast valley produces three-fourths of our foreign exports. Within this valley live half the people of the entire United States; and the voice of its citizens must be heard. The foreign commerce of this important portion of the United States should go direct in American bottoms to foreign ports. Harness the rivers of this fruitful valley, and we shall have a cheap and effective means of transportation; and a mightier impetus will be given to the ship-building industry than could be given by any subsidy other than the moderate expenditure required for the permanent betterment of channels.

This convention does, therefore, declare the opening of a deep channelway connecting the Great Lakes on the north with the Gulf of Mexico on the south to be an imperative duty of the general government; and that this work should be immediately begun and completed as speedily as possible.

Any plan for the inland waterway development so imperatively necessary to the material welfare of the valley should comprise a main trunk line in the form of a strait connecting Lake Michigan with the Gulf of Mexico by way of the Illinois and Mississippi rivers. The development of this trunk line

should begin at once. The improvement of the branches of this main line, such as the Upper Mississippi with its tributaries; the Ohio with its leading tributaries, including the Tennessee and Cumberland; the Missouri; the Arkansas; the Red, the White, and other rivers; and the interstate inland waterway of Louisiana and Texas, should proceed simultaneously with the development of the principal line.

The deep waterway is practically complete from Chicago to Joliet through the courage and enterprise of the single city of Chicago, which has by the expenditure of \$55,000,000 created a deep channel across the main divide between the waters of Lake Michigan and those of the Mississippi. A special board of survey, composed of United States engineers, reported to Congress in 1905 that the continuation of the deep waterway from Joliet to St. Louis was feasible, and would cost only \$31,000,000. The state of Illinois, assuming that the Federal Government will take the responsibility of completing the waterway to the Gulf, is about to cooperate to the extent of \$20,000,000. The delegates to this convention heartily congratulate the great commonwealth of Illinois and the splendid city of Chicago on their initiative, and express the hope and belief that their example will influence other States to lead to similar effective cooperation.

A special board of survey, composed of United States engineers, was through the efforts of this association created by Congress last year, to survey the deep waterway route from St. Louis to the mouth of the Ohio, and to report to Congress the feasibility and cost of the waterway. That board will report during the winter; and we, the delegates to this convention, demand that when this report is made, Congress shall at once provide funds sufficient to begin operations in a large and effective way.

The broad plan for improving all the waterways for navigation should take account of all other uses of waters and benefits to be derived from them by the people; should consider the conservation of the natu-

ral resources of the country in their relation to commerce and navigation; should extend to forest preservation, reservoirs and other means of stream control, and the maintenance of the level of our Great Lakes in such a manner as not to interfere with their navigation and commerce; should consider floods and their prevention, together with irrigation and drainage; should take account of bank-revetment, levee-building, and other means of protecting the bottom lands and increasing their productivity; and should contemplate regulation of terminals with a view to rendering rail transportation and water transportation complementary and jointly useful to the people of the country.

This convention is in hearty accord with the movement for the conservation of the natural resources of the country, and heartily approves the efforts of the National Rivers and Harbors Congress in seeking to develop the waterways of the Nation.

Fully realizing the importance of the proposed constitutional amendment unanimously submitted by the legislature of the State of Illinois to be voted on the third of November, and recognizing in it a practical step in the direction of the realization of this project; and also recognizing in it the first great movement by any state in the matter of the conservation of its natural resources, we approve said constitutional amendment and commend it to the favorable consideration of the voters of Illinois.

We, the delegates in this Convention assembled, representing half the people and three-fifths of the productive energy of the United States, do hereby demand that a definite and vigorous policy of waterway improvement, beginning with the Lakes-to-the-Gulf Deep Waterway, be promptly adopted and put into operation by the National Government. To the enforcement of this demand we pledge our individual effort and our united support; and we pledge our personal honor, each for himself and to each other, to support no candidate for public office who will not unqualifiedly indorse and maintain that policy.

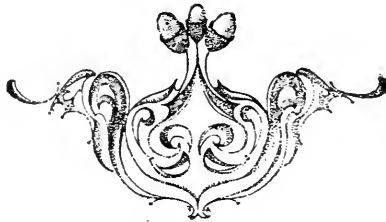

THE TRANS-MISSISSIPPI COMMERCIAL CONGRESS

By J. B. CASE, President, 1907-1908

THE nineteenth annual session of the Trans-Mississippi Commercial Congress held at San Francisco October 6-10 was marked by an unusual enthusiasm and had the attendance of one of the most representative bodies of businessmen ever gathered in the West. Among its striking features was a message of greeting from President Roosevelt, the presence of his personal representative, W. H. Wheeler, of the State Department, addresses by John Barrett, of the South American Republics Bureau, and C. J. Blanchard, of the Reclamation Service.

The theme of the session was greater markets for the West and the need of more transportation facilities.

The Trans-Mississippi West has grown amazingly in fertility as better methods of agriculture have opened larger areas and have made the old areas produce more abundantly. Then the government has come in with its wonderful reclamation service and has awakened the sleeping desert. The work as a whole rivals the Panama Canal in the labor and expense involved. The employment of 16,000 men and the expenditure of \$1,250,000 every month are but incidents in the service. Already the canals completed reach a total of 1,815 miles—as far as from San Francisco to Kansas City. Homes have been made for 10,000 families, where before was barren land. In the past five years \$33,000,000 has been spent, and the enterprises already planned will add more than a hundred millions to this sum. Nor is this money spent in one locality. In New Mexico one of the largest dams in the world is being constructed. In California and Nevada great reservoirs

and irrigation plants are being built. In western Kansas, the beet-sugar raisers have a \$250,000 plant for pumping to the surface the "underflow," found a few feet beneath the top soil of the Arkansas River valley that ditches may be filled and crops made certain. On seven great projects involving the expenditure of \$51,000,000 and the reclamation of over a million acres, the benefit is directly to the Northwest. These projects lie in North and South Dakota, Montana and Washington. In these states lands that have been considered worthless except for the coarsest kind of grazing, are being transformed. No private enterprise could undertake the vast plans being carried on by the government. It has excavated forty-seven tunnels, with a total length of eleven miles. Among its accomplishments are ninety-four large structures, 675 headworks, flumes, etc.; it has built 375 miles of wagon road in mountainous country, has 727 miles of telephone lines, has manufactured in its own mills 90,000 barrels of cement, and in its own saw-mills has cut over 3,000,000 feet of lumber. All this indicates a work of the first magnitude. It will be returned many fold to the nation.

Out of this remarkable advancement of the Trans-Mississippi country comes one great problem that overshadows all others. Important as are the various interests which we are trying to build up, and close as are they to our national life, the present-day question before the Trans-Mississippi country is that of transportation for its constantly rising abundance of production. The one thing the farmer and the miner want to know to-day is how to get the

material he produces most cheaply and most directly to a world market. Only two methods are open, by river transportation and by railway. There are no vast inland seas, no great bays or lakes to furnish a passage for all this wealth of grain and minerals. There are rivers that flow for hundreds of miles, but offer only an indifferent method of transportation. It is pleasing to see that the government is taking an interest in the possibilities of this form of transportation and that the waterways are receiving attention. It has been one of the efforts of this congress to urge and secure assistance along this line. The government owes it to the people who occupy these fertile acres to give every possible aid in deepening and broadening the rivers that can carry our products to deep waters. It owes to these states and territories a more determined effort than ever before to improve the western harbors to which may be shipped western products. The great granary and mineral territory of the United States is going to have its rights in waterway improvement, or know the reason why.

In making these improvements the Trans-Mississippi country is most interested in those streams and harbors that touch our own states. We are particularly desirous that the navigation of the Missouri and lower Arkansas rivers be improved until there shall be a worthy advance to the transportation of our western products. Along these streams are growing cities and improved farms, and the government owes it to the men who are making a prosperous country of what was once open plain that they be given every possible encouragement.

However, only a comparatively small portion of the Trans-Mississippi country can be reached by navigable streams. We must depend upon the iron rail as a highway to market for the greater portion of our products. The railroads came into the western states and found them a trackless desert. To-day the most splendid limited trains in the world flash across well-improved and wonderfully devel-

oped areas. Trans-continental lines connect the Pacific coast with the Atlantic seaboard. North and south lines reach from the Dakotas down to the Gulf. Branch lines tap the interior and haul away the grain from the lonely prairie elevator. The railroads have transformed the Trans-Mississippi country. But every year at harvest time we hear the recurring cry of too few cars and too few engines. The prairie elevator is filled to the roof day after day, with no cars ready to haul away the grain. New towns spring up and are unable to secure freight because of the congestion at central points. Down in the corn-raising districts this fall you will see hundreds of thousands of bushels of corn heaped on the open ground, because transportation is lacking. The country has developed faster than railroad building has gone on.

Not until we study the statistics of the Trans-Mississippi country do we realize the importance of this need. When the Commercial Congress was organized, there were but 15,000,000 people here to-day there are 25,000,000. The value of farm property was given by the government census as \$2,137,000,000; to-day it is \$19,898,000,000. The production of the farms in the United States this year is estimated at \$7,500,000,000, of which fully fifty per cent. comes from the Trans-Mississippi country, an increase of 100 per cent. in the past fifteen years. The mining industry has increased in even greater proportion. While these tremendous growths have been taking place in the value and production of the Trans-Mississippi territory, the transportation facilities have not increased in any such measure. In 1888, the railroad mileage was 68,057 miles. The statistics for last year—which are the latest available—give to this territory 102,286 miles. This increase of less than sixty per cent. is far below the needs of the richly productive area that these lines serve. It is evident to the student of commercial affairs that we need tens of thousands of miles of new railway in order to handle properly the tremen-

dous and growing output of our farm lands and mines.

Here and there a commonwealth has a mistaken idea of its own needs and attacks the railroad as an enemy, when it should have considered it an associate in its development. It is a poor policy on the part of individuals or of a community to hinder those things that make the present-day progress. Thousands of communities to-day would have railroads if the builders of great lines were not afraid of what may come in the way of hostile legislation. Hundreds of communities need a railway station in order to grow as they should. The Trans-Mississippi country ought to have thousands of miles of new railway in the next year, and the men who are most familiar with its needs and opportunities realize this most completely. It makes no difference whether these new lines are built by old-established railway corporations or by new ones. The railroad to-day is run on principles of straightforward business and all must come under the same regulation. But the thing is that more lines should be built, more country should be opened, more facilities should be given to sections that have thus far exceeded the ability of transportation lines to accommodate their needs.

All this is a part of the work of the Trans-Mississippi Commercial Congress. It is the direct road to prosperity and needs but a greater market in order to allow the Pacific coast opportunity to expand to its full needs. I am convinced that the Reclamation Service is going to transform California. I have visited many of the projects, and their works are marvelous. Already nearly \$20,000,000 outlay is planned for the territory immediately tributary to Los Angeles and something like \$75,000,000 for the Trans-Mississippi territory.

I am in favor of expending \$200,000,000, if necessary, in order that

every drop of water falling on the western lands may be utilized in increasing fertility. There is but one California, with climate, soil and surroundings that make an ideal spot.

The Western States have developed faster than the transportation facilities and the markets. The population and business have grown more than 100 per cent. in the past fifteen years, while the railway mileage has increased only sixty per cent. Ten thousand miles of new railway track could be used in the next year west of the Mississippi.

We need particularly a South American outlet, and I am endeavoring to secure a national commission of western business men to visit South American countries and interest them in California's fruits and wines and in the products of other Western States. We ought to have all of that trade, especially when the Panama Canal is opened, from both coasts of South America. The proposition is received with approval throughout the West and will come in excellently with the Pan-American Congress which it is proposed to hold in San Francisco two years hence.

Three thousand business men are members of the Trans-Mississippi Congress and their work during the coming year will be in the direction of greater irrigation, reclamation, transportation and trade expansion.

The coming year of the Trans-Mississippi Commercial Congress promises to be a very successful one. A committee has been appointed, consisting of the president ex-president, and members of the executive committee, to call on the incoming President of the United States soon after November 3 and secure a promise that he will attend the session in Denver, August 15, 1909. If successful, it means that the twentieth session will be the largest in the history of the Congress.



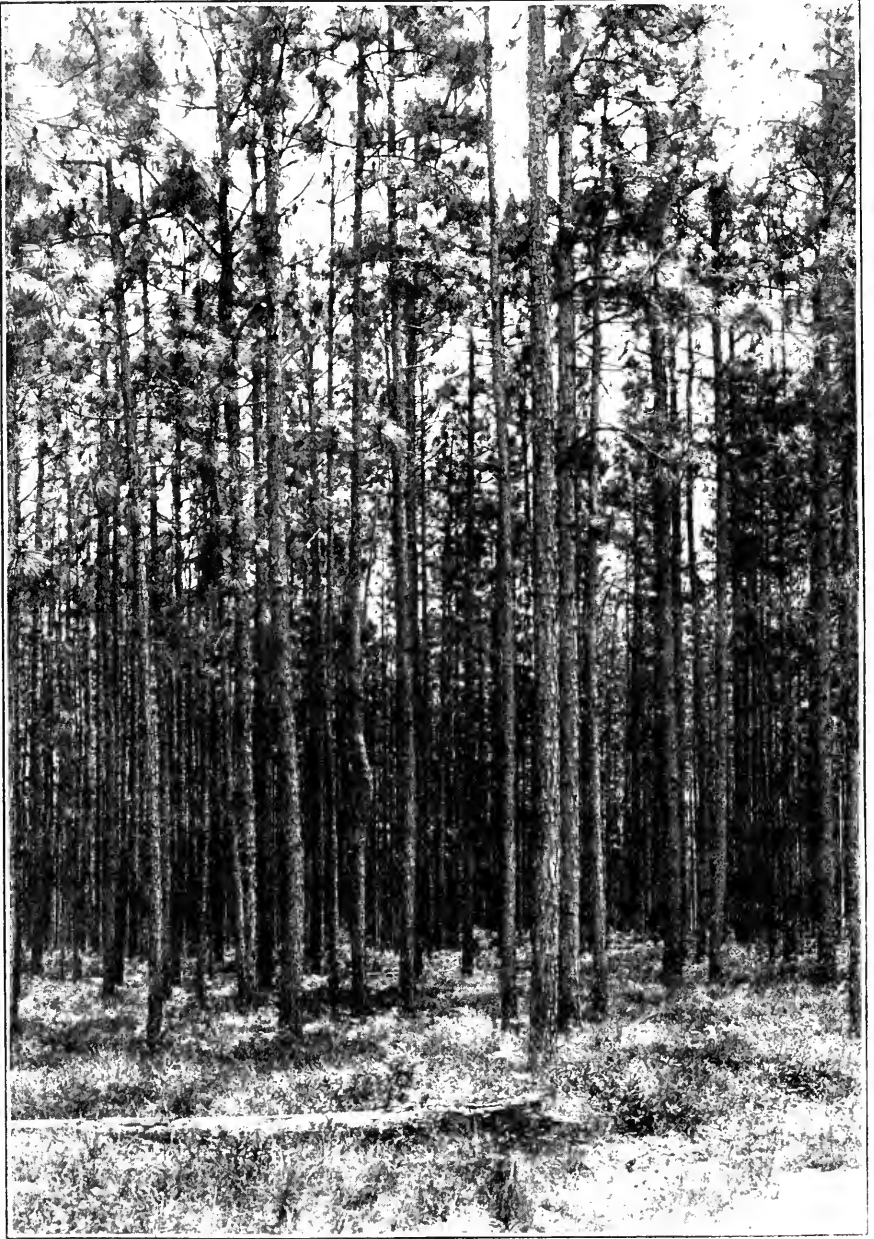

IN A SOUTHERN FOREST

A Close Stand, about Forty Years Old, of Southern Yellow Pine, near Savannah, Ga.

CONVENTION OF THE OHIO VALLEY IMPROVEMENT ASSOCIATION

THE Fourteenth Annual Convention of the pioneer association of citizens to promote river improvement was held at Louisville, Ky., October 22-23, in the Seelbach Hotel. The meeting was an enthusiastic one, largely on account of the feeling that the long-awaited fruition of hopes and labors is at hand. The annual report of President Vance, which followed the opening exercises, showed the affairs of the organization to be in a gratifying condition; it and the address of Hon. Joseph E. Ransdell, President of the National Rivers and Harbors Congress, were the features of the morning session. Mr. Ransdell outlined the development of the recent waterway movement, beginning with the organization of the Ohio Valley Improvement Association, and directed attention to the constant aid and encouragement this Association has given other organizations of kindred aim, including the Rivers and Harbors Congress.

The afternoon session was devoted to addresses by Maj. William L. Sibert, U. S. Engineer Corps; Mr. W. K. Kavanaugh, President of the Lakes-to-Gulf Deep Waterway Association; Mr. George W. Theiss, Mr. Alfred K. Nippert, and others; and the evening session to addresses by Hon. F. B. Posey, of Indiana, and Mr. A. B. Lipscomb, with an illustrated lecture on the Locks and Movable Dams of the Ohio River, by Capt. J. Frank Tilley. The session of Friday was occupied by reports of the secretary, Capt. J. F. Ellison, with reports of committees (including that on resolutions), brief addresses giving assurances of support by Representative Swager Sherley, of the Louisville District, and several other members of Congress with more

extended addresses by Hon. Albert Bettinger and Dr. W. J. McGee; the session closing with the election of officers and selection of Cincinnati as the place for the Fifteenth Annual Convention in 1909. During the afternoon the delegates and guests, through the courtesy of the Louisville Executive Committee, made a trip through the harbor and examined the government work in progress on the movable dam at the Falls of the Ohio.

Mr. Bettinger summarized the legislation, surveys, and other procedure leading to the present plan for improving the navigation of the Ohio by means of a series of fifty-four movable dams, extending from Davis Island to Mound City, designed to give a nine-foot stage, at an aggregate estimated cost of over \$63,000,000. Six dams have been completed and eight are under way, of which two will be completed within a year. He also outlined "the new policy of waterway improvement." The Association has contributed much to the creation of sentiment in favor of a departure from the old methods. The evils of indiscriminate approval of projects, insufficient provision of funds to carry them promptly to completion, the lack of a comprehensive plan of river improvement, insufficient number of engineers, have all been so much discussed that a mere mention of them is sufficient. What principles should guide the future action of Congress in these matters? President Roosevelt, in his message to Congress February 26, 1908, transmitting the report of the Inland Waterways Commission said:

No project should be begun until the funds necessary to complete it promptly are provided, and no plan once under way should be changed except for grave reasons. Work

once begun should be prosecuted steadily and vigorously to completion. We must make sure that projects are not undertaken except for sound business reasons, and that the best modern business methods are applied in executing them. The decision to undertake any project should rest on actual need, ascertained by investigation and judgment of experts, and on its relations to great river systems or to the general plan, and never on mere clamor.

The improvement of our inland waterways can and should be made to pay for itself so far as practicable from the incidental proceeds from water-power and other uses. Navigation should, of course, be free. But the greatest return will come from the increased commerce, growth and prosperity of our people. For this we have already waited too long. Adequate funds should be provided, by bond issue, if necessary, and the work should be delayed no longer.

In his recent address to the Lakes-to-the-Gulf Convention, held in Chicago early this month, Hon. Wm. H. Taft said:

A plan should not be adopted until fully confirmed by expert opinion and careful investigation, but when it is adopted, when its utility is made certain, then it is neither economy to the Government in the matter of expenditure nor is it a benefit to the people to delay the furnishing as rapidly as it can be economically expended of the full amount of money needed to make the improvement a useful and completed thing.

The achievement of these great ends cannot, however, be worked out through Congress without a radical departure from the course of procedure heretofore employed. No projects should be approved without the most careful consideration as to their feasibility and usefulness. When the execution of an approved project has once been determined on, it should be carried to completion as rapidly as possible, so that the people's investment may be made to bring returns at the earliest possible moment.

During my term as Secretary of War, I had occasion to appoint, under the provisions of an act of Congress, a board of engineers to examine and report upon the Ohio River improvements, both upon a six and a nine foot basis, and upon its feasibility and advisability. The board, after a thorough examination, unqualifiedly reported that the improvement be made to a depth of nine feet. One-fifth of the work has been done under previous reports and approvals, but the rate of progress was such that one-half a century would not see its completion.

A policy which brooks such delay is wasteful, if nothing worse.

You will observe, therefore, that measured by all the principles of the

new policy, the Ohio River project is ripe for such action by Congress as will provide all the funds necessary for its completion as rapidly as the work can be prosecuted. A stage of nine feet cannot be provided from Pittsburg to Cairo, except by the construction of all the dams. The engineers have stated that all the dams can be put under construction at the same time. The corps of engineers should be increased by additions from civil life, or the whole work placed in the hands of a special commission, in which the corps of engineers shall be represented. The Panama Canal will be completed in 1915. The Ohio River can be completed at the same time. The cry "From Pittsburg to Panama" should become a reality.

The delays thus far may be charged to official waste, but henceforth such delays will be a crime! The work should be completed or abandoned. Congress, in its wisdom, may do either. The latter course would cause such a public uprising in protest as was never heard of before. The commerce of the country is clamoring for more transportation facilities.

Major Sibert indicated the commercial importance of the Ohio if made practically available for navigation, outlined the methods and policies of the corps of engineers, and illustrated the dilatory progress. The lock at Davis Island was finished in 1885; the first appropriation for the second lock built was made in 1902, seventeen years after the completion of the first; while the Isthmian Canal should be completed in less than seven years. He discussed adversely the relations between forests and river improvement, bringing out the well-known fact that flood-heights do not sensibly increase with deforestation, and questioning the feasibility and desirability of flood prevention by means of reservoirs; all under the conventional policy of restricting river improvement to engineering works and ignoring the general control of the water, the regulation of regimen, the adjustment of terminals, etc. After referring favorably to a recent article by Col.

H. M. Chittenden, he urged, with respect to forestation the prevention of erosion and floods, and other features of river control: "Do not permit yourselves to enter into league with any of these generalities; if there is any one element of our natural resources that can wait to be conserved and take no chance of being lessened in quantity or being controlled by a few individuals, it is the water that falls from the heavens."

Dr. McGee emphasized the commercial importance of the great valley drained by the Ohio. Comprising nearly 200,000 square miles in area, with a population considerably above 10,000,000 and a wealth approaching \$25,000,000,000, it is comparable with old-world nations, and might form a nation of itself were it not the heart of a greater nation. With a mineral production approaching and an agricultural production exceeding \$1,000,000,000 annually, and a manufacturing production approaching \$5,000,000,000, it must at present rates pay something like \$1,000,000,000 annually in transportation charges to place its productions in the markets of the world; and reckoned on any reasonable basis the excess of this tax over what would be required if the Ohio were navigable readily as the lake route could hardly be less than \$100,000,000, certainly not less than the \$64,000,000 required for completing the improvement under the approved plans already under way for eighty-four years, and likely to continue at the

present rate forty or fifty years longer. In other words, the Ohio Valley loses each year in excessive transportation charges more than the entire cost of improving the river permanently. It is the business of the Inland Waterways Commission, not to take up engineering projects under way, but to ascertain why, after an expenditure of hundreds of millions of dollars in improving the rivers, the boats are not running on them, and then to point out how the waste can be checked. In the case of the Ohio the chief obstacles to navigation have been: (1) commercial, and (2) physical. The leading commercial obstacle has been railway competition, which is now diminishing; the leading physical obstacles arise in the increasing number and duration of floods and low waters resulting from settlement and deforestation, and the concurrently increasing cost of adequate landings and other terminal facilities, though there has been little change in flood-height, since the rise is normally limited by the natural flood-plain. The increase in flood frequency is shown by a table extracted from data collected by Mr. William L. Hall of the United States Forest Service; from which it appears (1) that if the period covered by records on the Ohio and its principal tributaries be divided equally, the number of floods was much greater during the second half of each period than during the first, and that in nearly every case the duration of floods was also

River	First and second period of record	Mean precipitation	Number of floods	Total days	Average days	Flood point	Danger point
		<i>Inches</i>				<i>Feet</i>	<i>Feet</i>
Ohio, at Wheeling, W. Va.....	{ 1882-1894—13 yrs..	38.66	46	143	11.00	} 22	} 36
	{ 1895-1907—13 yrs..	38.03	59	188	14.40		
Monongahela, at Lock No. 4, Pa...	{ 1886-1896—11 yrs..	39.76	30	55	5.00	} 20	} 28
	{ 1897-1907—11 yrs..	39.27	52	100	9.09		
Cumberland, at Burnside, Ky.....	{ 1890-1898—9 yrs..	46.27	32	89	9.90	} 25	} 50
	{ 1899-1907—9 yrs..	41.42	43	102	11.33		
Allegheny, at Freeport, Pa.....	{ 1874-1890—17 yrs..	40.13	39	92	5.41	} 16	} 20
	{ 1897-1907—17 yrs..	35.28	53	131	7.70		
Tennessee, at Chattanooga, Tenn..	{ 1875-1890—17 yrs..	52.10	32	164	9.65	} 24	} 27
	{ 1891-1907—17 yrs..	45.01	33	143	8.41		
Muskingum, at Zanesville, Ohio...	{ 1887-1897—10 yrs..	36.87	17	73	7.30	} 15	} 25
	{ 1898-1907—10 yrs..	35.17	41	171	17.10		
Numerical average difference	3.27	14	36.5	3.30

greater during the later half; and (2) that in every case the precipitation within the drainage basin was less—in several cases materially less—during the later half of the period. The number of low waters, and the duration of the low-water periods were augmented in even more notable degree during the later subperiods, though the records are less complete. In all cases the change accompanied extensive deforestation. Were the preparation of a plan of improving the Ohio under the new policy adopted by the President and Secretary of War now in question, it is probable that a preference would be given to a system of fixed dams and locks, since such a system would tend toward a more complete control of the water, and hence toward counteracting the steady growth of the physical obstacles

to navigation; but the question of plan has been settled—a good enough plan has been adopted, and the only sane course is to carry out that plan vigorously, promptly, and effectively. Meantime, the efficient scientific bureaus in the Departments of the Interior and Agriculture may safely be trusted to devise and put in execution those nonengineering plans required to control and retain the water in such manner as to prevent floods, keep the channels clear of sediment, and insure a sufficient volume of water to meet the needs of navigation even during extraordinarily dry seasons.

For the ensuing year nearly all the old officers were reelected, including Col. John L. Vance of Columbus, as president, and Capt. J. F. Ellison of Cincinnati, as secretary and treasurer.

HIGH WATER ON THE OHIO RIVER

Car Tracks, Railroad Yards, and Warehouses Flooded in One of the Manufacturing Cities of the Upper Ohio Valley



DROUGHTS AND FLOODS

By JOHN H. FINNEY, Secretary of The Appalachian National Forest Association

NO SEER, looking ahead a decade and prophesying concerning the future of America without its forests, could well have drawn a more vivid imaginative picture of conditions than the actual recital in the daily press in the past few weeks of forest fires throughout the country and of droughts in Pennsylvania, Ohio West Virginia, etc., setting forth the tremendous money damage, the loss of life; the paralysis of business, the serious menace to the health of the people caused by them; where the supply of water was so short that it became a more profitable crop than produce; when baseball was being played in what was the bed of the Ohio River; where dried-up streams had become vast open sewers and were being sprinkled with lime to prevent an epidemic of disease;

where prayers were being daily offered for rain!

These conditions, due to a shortage of water, appalling though they be, tell but a part of the forest story; the other part is told by the disastrous flood conditions which the South was experiencing at the same time; a story that has to do with too much water, but told to the same accompaniment of loss in money and human lives.

Surely, if a forest preservation lesson is needed to make us heed the conditions which our present policy means to future America, these occurrences under our own eyes and touching the material welfare of our own neighbors and friends ought to be realistic enough to drive the lesson deep into our hearts and consciences.



A FLOODED CITY

Scene on River Avenue, Pittsburg, During an Inundation. Floods at One Season, Droughts at Another, because the Forests Are Gone

That both sides of the story are due to our recklessness of cutting and waste of the forests can hardly be questioned by thinking men.

The recent southern flood in August and September covered a wide area in North Carolina, South Carolina, and Georgia, the principal damage being done along the Cape Fear, the Yadkin, the Catawba, the Broad, and the Savannah rivers and their tributaries. The

running from six to eight miles an hour, and lasting for a period of forty-eight hours, the flood covering an area from east to west of five miles from North Augusta Highlands to a point beyond Horse Creek.

With all communication with the outside world practically cut off—wires down, no street-car service, no electric or gas lights, without fire protection, and short of water, except the twenty-

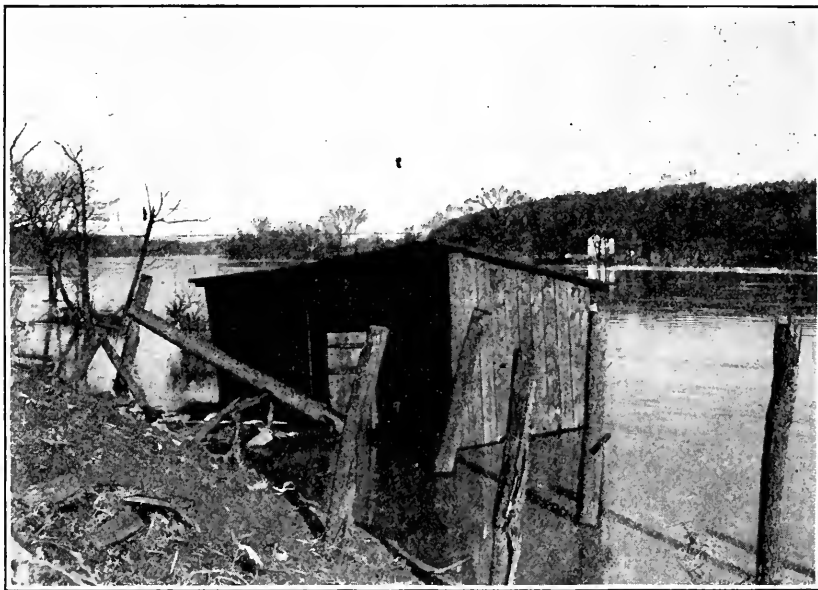

IN A FLOOD-SWEPT REGION

House Washed Down the River by High Water, During a Flood in Allegheny County, Pennsylvania

damage done to crops and low grounds, by washouts of roadways, and railroad rights of way, railroad bridges, county bridges, and by losses in the various cities affected is not short of \$25,000,000, with a lamentable loss of nearly a hundred human lives.

The worst flood in the history of the Savannah River overwhelmed Augusta in the early morning hours of August 26th, the high-water record of the worst previous flood, that of 1888, being exceeded by two feet before midnight of the 26th, at which time the height of the water over the street-car tracks on the principal thoroughfare, beautiful Broad Street, was two feet,

five miles of red and raging torrents that swept over her and submerged her to the farthest foothills; with hundreds of people homeless; business and traffic entirely suspended, is it necessary to go into further details to bring the horrors of the scene more closely home to you?

Augusta's experience is in part duplicated in Columbia, S. C., and other less important points in the section affected, and along all the streams are striking evidences of the power of the unrestrained and angry waters that will take many months and many millions to restore to normal condition.

There should be no story without a moral. This one carries a striking one

in the conclusion that the forest covering is needed and must be had. A glance at the map will show at once that all the streams named have their headwaters in the Southern Appalachians and are necessarily affected by the destruction of the forest in that region. How strikingly true this is can be best shown by the statements recently made by City Engineer Twiggs, of Augusta, that "The power canals in Augusta have filled up from silt more in the past eighteen months than in thirteen years previously;" the character of the silt showing clearly its mountain origin. And this is borne out by the testimony of A. M. Schoen, Chief Engineer of the Southeastern Underwriter's Association, in his report on the Augusta flood in the following impressive warning: "Furthermore, there is reason to believe that heavy freshets in rivers taking their rise in the Southern Appalachians are to be anticipated more frequently in the future than in the past, owing to the rapid cutting away of the

timber on the watersheds comprising the drainage basins of these streams, which means an increasing probability of such occurrences as that which overwhelmed Augusta."

Wherein lies common sense regarding this whole matter? Is it not along the line of the immediate establishment of the Appalachian-White Mountain National Forest, and the adoption of a definite forest policy by the National government covering the whole country, as the first step, and does it not point out the work that the states themselves must do within their own borders and with their own citizens toward a rational policy of perpetuation of their own forests—a policy that can be carried out only by themselves?

If the lesson is learned and heeded, we should have, as promptly as Congress can pass the bill, the Appalachians, and a State Forest in every Southern state that will in time insure them against such damage as is herein chronicled.

ONE OF PENNSYLVANIA'S PERIODICAL FLOODS

Wreckage of a Steel Bridge, on the Pennsylvania Railroad. Crossing Deer Creek, in Allegheny County
Three Lives Were Lost in the Wreck, besides a Locomotive and Five Cars



A BEGINNER IN FORESTRY

By ANNE WARNER

Paper Two

I BEGIN to wonder if, in the caring for trees so that they may produce railroad ties, houses, and other truly artificial necessities, we haven't lost sight of the whole basic principle of Forestry. The real need of trees is so that weary mortals may get out of houses and off of railroad ties, and back to one of the greatest pleasures of life—the pleasure of just being alive—the pleasure of becoming a child in heart—the pleasure of being happy without knowing why.

The place where I am is small, not much frequented, totally ignored by Herr Baedecker, and the most of the inhabitants of the village are the simplest peasant folk, men and women who work in the fields and go home at night in long, uneven ranks, seven or eight together, each carrying his or her rake, hoe, or shovel. There is a domain, or large landed estate, and the woods belonging to the estate come as strictly under the forester's rule as if they were government property. The whole countryside is covered with beautiful forests—mainly "self-planted." The forester has explained to me that, when there is a good growth of young trees after the cut, they let them alone, only concerning themselves with the thin places or the places where the soil is evidently not fitted for the young trees springing there. The soil in this vicinity is chalky and the lay of the land makes me want to study geology—when I don't want to study mushrooms, botany, astronomy, or any other one of the new-old primitive sciences which press powerfully to the fore when one comes under the forest's scepter.

The desire to know the answer to the riddle is that the riddle here is so big. The great plain of Northern Germany lies straight outspread beyond me as I write. Wide and flat, dotted with villages, fertile, with rich upper soil. The ocean once rolled to the foot of this hillside, and, ages earlier, all the rocks of which the hill and all those around are made, was formed in its depths. Now, this is the riddle: All the rocks are strata, plainly defined, and without exception they are all tipped almost perpendicularly on end. The slant is invariable, and the ends of the strata have a sharp little twist just beneath the soil. The soil on these rocks is only one or two feet deep and is first sand and then the rich black of vegetation. Such a big riddle to me.

The foresters interest me greatly. Men who care for the growth of 150 years and who cherish the life in that which will come to its end in 2050 or thereabouts, must have some traits which any American may well find interest in studying. The forester here tells me that he loves his vocation, and I can understand that no man would choose it who did not love it, because of all vocations it would be the least possible to give a living to an indifferent follower. I went with him the other day to see his knife mark out the superfluous saplings and I soon learned the two rules that saved or condemned: health at the root, and whether or not the young top formed part of the cover overhead. The cover overhead must be continuous or else grass grows beneath, and grass is not allowed in German forests. I mean, of course, as a general thing—there are large open

spaces every little way, places where the sun streams in and illuminates the whole scene with a radiant, heavenly glory, that makes the legend of St. Hubert most easily believed.

I spoke once of the exquisite "order" of the German woods, and I must speak of that again. As I said before, this is no frequented resort, no show-place, and yet the woods-paths, the little bridges, the tiny stone culverts, the wide, even macadamized roads for wood transport—everything is in what we might call "most beautiful order." The dead branches and twigs belong to the poor to gather for the first two days after storm or wind. We see them coming home—old men and women—their loads bound on their shoulders—just as they have come for thousands of years. They go quietly by piles of neatly stacked cut-wood to be taken to town and sold when the men shall have time, and the cut-wood remains undisturbed until that time. The absolute sturdy honor and honesty of the poor man in Europe is quite as much to each nation's credit as the care they give to their trees. To my eyes it links somehow to the spirit that leads the market women to leave her full basket outside the church door and go in to pray. We shall come to that spirit in future centuries; we laugh at it now because it is as easy to laugh as it is to give the California trees over to the executioner—but—a long way ahead—we shall not laugh. We shall pray, too, in that day—we shall give cast off wood to the poor, instead of heaping it together to burn forthwith; we shall have a reverence for what has grown old in service, and we shall be as willing to furnish schools for our trees as for our children. Some few out of each thousand know now how close is the unseen bond between the trees that we are trying to guard and those same children. It is closer yet

between the trees and those children's children. And between our trees of to-day and the third generation hence it may well be vital.

One little word more and then I shall have filled my space and must end. I want to tell of a curious way, the like of which I never saw before.

For about a quarter of a mile along the highway there runs on one side a wide strip of land laid off in rows of parallel trees (parallel with the road) planted about ten feet apart, but with deep hollows running lengthwise between. The trees have had their tops cut in the old French fashion until the new sprouts form a thick cover overhead, the whole too low to walk upright through. I was very curious about this way and could not think by whom or for what purpose it could possibly have been made.

So I asked the forester, and he told me that the way used to stretch around the angle and down the hillside to the manor-house barns, and that it was planted centuries since and kept filled in as the old trees died, so as to provide a covered shelter for the herds and flocks which were driven daily through the wood and out to the pasture land on the other side. The herds and flocks are not so plenty now, and the way itself has been curtailed, but when it rains we go in under its close green shelter and—like many moderns who think the sun takes a year to go carefully and kindly around our little earth—thank the old Lords of the Manor for having thoughtfully saved us a wetting.

I hope next time to write something of the old forest history of Germany—something of the days when the kaisers or koenigs gladly gave forests away if the receiver would just kindly measure them and save the crown the trouble of working out the problem of its own generosity.



COMMUNICATIONS

THE FALL WEB-WORM

EDITOR CONSERVATION :

We have heard much concerning the gipsy moth and brown-tail moth of the East, but this pest, the "fall web-worm," shown in the accompanying photograph, is so familiar to our gaze that we see no more harm in them than in the English sparrow. In many parts of New York State, the

the country. The average tree will die after five consecutive years of defoliation. Alarmed at their increase, and at the lack of attention to their ravages, the writer has made the pest a special study during this last season.

They follow in the wake of the English sparrow, and are most numerous where there are the least trees. On



NESTS OF THE FALL WEB-WORM

upper portion of Pennsylvania, and all the upper half of Ohio the trees are covered with them. They are seen on the rose bushes and shrubs of almost every lawn and dooryard. The cemeteries have them, and the woodlands are becoming devastated by them. In five years they have increased a thousand to one; increasing by geometrical progression—in fifteen years—there cannot be a living tree in the regions named nor in many other portions of

the way to Alabama, in August, the writer found that they disappeared just above Dayton, Ohio, and there were but few through Kentucky and Tennessee; but the writer met a gentleman in Huntsville, Ala., who said they were quite numerous down the eastern coast line, clear to Florida.

The reason why people are not more concerned over the ravages of this caterpillar is presumably, that it is considered a local pest; but it will soon be

a national one, and spraying is entirely out of the question. How could hundreds of thousands of acres of forest be sprayed? And if they could, only a part of the worms would be destroyed.

The restoration of our birds is our only hope. It is significant that these worms' nests are most numerous nearest the human abode. There are reasons for this; our songsters, the small insectivorous birds, are buffeted and driven away by that foreign vagabond, the English house-sparrow; and should a bluebird, oriole, or wren succeed in hatching a brood near a human habitation, the little fledgling usually drops to the ground, in its first effort at flight, and is grabbed by a cat. The Audubonists have ascertained that there are some 50,000,000 cats in the country, and that they destroy on an average, fifty young birds each, or 2,500,000,000 useful birds annually! The crows are multiplying at an enormous rate of speed, and they do little else in the nesting season than to rob small birds' nests to feed to their own young. The young bird is a dainty bit for the snake, and the hawk has a piercing eye. Our valuable birds are disappearing at the rate of at least ten per cent. annually.

Good people of America, something must be done at once to restore the birds. A paper is prepared, summarizing the food habits of our small birds, accompanied by a petition blank for their restoration.

We ask that every reader of CONSERVATION send for the pamphlets and commence work at once. Take them to your clubs; put them into the hands of school teachers. Full instructions are given.

Please remember it "takes money" to do printing, and we ask you to enclose a stamp to pay postage.

Address, John Davey, Kent, Ohio,

✻ ✻ ✻

Two Essays

EDITOR CONSERVATION:

The enclosed article, the valedictory address of Miss Ellen M. Hastings, of Elk River, Minn., High School,

is to my mind a unique piece of forestry literature, not so much because of any new information which it contains, but from the novelty of its source and its fresh, wholehearted and concise treatment of a broad national topic. It seems to me that we can ill afford to let the spirit of young America therein displayed go unnoticed, since that is the spirit and generation whose interest and support we want to enlist to carry forward the movement for the conservative use of our natural resources. I venture to say that that address, linked as it was with the personal interest of every member of the audience in the speaker, and borne to them in the spirit of such an occasion as that, was a factor of more potentiality for lasting impressions than a score of similar addresses delivered by the most enlightened propagandist. The author is not personally known to me, but I am nevertheless interested to see all such endeavors encouraged.

LOUIS S. MURPHY.

Thompson, Mont.

MISS HASTINGS' VALEDICTORY ESSAY

The forests; what do they mean to us? Do they not embody strength, beauty, protection, inspiration? What would our environment here be without the woods? A desolate prairie, bleak in winter, and dazzling and torrid in summer. Would we be content to see our oaks gradually disappear, until we might look across an interminable space, with only the frail habitations of mankind to obstruct our view? No; a thousand times no! If we, a very small part of the whole, can begin to realize the importance of the preservation of forests, how much more ought our great, progressive, and far-seeing nation to realize the momentous value of the advancement of forestry.

When the early colonist settled along our eastern coast he found it covered with forests. These furnished him lumber for his home, and fuel. His old respect, matured in the old world, was fostered. From a friend the forest soon changed to an enemy. Did it not shelter his deadly enemies, the Indians and wild beasts? Did it not prevent the pursuit of agriculture? Naturally he assumed the attitude that the forests must be destroyed if civilization was to advance.

As his descendants moved westward they continued to meet and to destroy the dense forests, maintaining, long after there was the faintest cause, the attitude rightfully assumed by the first settler.

Before this destruction was begun the forests covered all this country except the plains west of the Mississippi. East of the Mississippi were the white and southern pine, which have supplied the generations with lumber; the hardwood forests of oak, ash, hickory, and gum. West of the Mississippi and the plains were the Rocky Mountain evergreen forests and the Pacific coast forests of redwood and firs. These were probably the richest forests in the world. Not only did they represent a vast, untold wealth in lumber, but they also had a direct and tremendous effect upon the productivity of the land.

The roots of the forest form a great sponge which, as a natural reservoir, holds the water at the earth's surface. Where water for irrigation is the "life blood" of a community, the first and greatest necessity is a forest at the source of the streams.

The forests also have a great influence over the climate. It has been proven by many observations that the temperature within the forest in the winter is several degrees higher than in the open, and in the summer is several degrees lower. This moderation is due to the moisture of the forest cover.

Besides these inestimable effects upon the vital interests of the entire country there are the local uses. In the mountains the forests are safeguards against snow slides and floods. On the open prairies or by the sea they afford protection against winds and storms.

Seemingly unconscious of the future and with the same idea of our ancestors, we are still destroying in hours what it will take centuries to produce.

What has been done with this mass of wealth and power? The greater part of it has been used in supplying the ever-increasing demands of our growing nation. Although concrete and metal have replaced lumber in some ways, it is still an undisputable fact that they have not reduced the demand for hardwood. While they are finding substitutes for wood in construction, they are also substituting it for other functions. Recently great areas of spruce timber have been purchased by pulp and paper manufacturers. Already the pulp mills are meeting a very large part of the paper demands of this country.

Every year large tracts of splendid forests have also been criminally destroyed. This devastation has been carried on by forest fires. In the early years this method of destruction was encouraged because of its rapid and thorough results. Now, although the United States Government is taking every precaution against these fires, men called "timber pirates" succeed in burning large areas in order to obtain the "dead and down" timber. Had the destruction of this vast wilderness of trees affected only the lumber resources of the nation the result would have been sufficiently appalling. The destroying of the forests, has, in many cases, caused

the disappearance of rivers and streams which had their headwaters in the forest reservoir. Even now, while representatives from the valley of our "Father of Waters" are knocking at the doors of Congress for a one hundred million dollar appropriation to deepen the channels of this great river for a navigable highway, we can hear the echoes of the axes and the crash of the quivering giants as they fall to the ground. *Fell the forests, dry up the reservoirs of the river's headwaters, then ask for one hundred million dollars to deepen its channel!*

The same source accounts for change in climate from moderation to extremes, and for the increase of destructive storms and floods.

If this reckless destruction continues, how are we going to maintain waterways or check floods? Where are we going to obtain lumber and fuel for the innumerable demands? Surely we do not expect to devise substitutes for all its natural resources or to import it for its artificial uses. Yet if this devastation goes on as at present, within a short time we will be entirely without the most useful servant to man, except the earth itself.

With these facts facing us, the broad-minded men of this nation are awakening to the realization of the tremendous significance of forestry. They are considering it as the greatest problem with which our nation has to deal.

What can we do? Preserve the remaining forest. Make it the obligation of every owner of a woodlot that he shall protect it. Let him use the accumulating interest and leave the principal untouched.

Agitate the question of national and state reserves. Let the Government guarantee the best care and protection for them. Further than this, let the Government reserve tracts of land suitable for new forests.

Instruct the legislators to see that more stringent laws concerning the growing and cutting of timber be passed and more strictly enforced.

But more important than all this should be the founding of good forestry schools. More bright and capable young men should be made interested enough in forestry to make it their profession. To draw their attention, the schools should be made popular and attractive.

If once our young men became enthusiasts, their enthusiasm will arouse the nation. Forests will be produced, preserved, and protected. Once more we will live in closer communion with nature.



EDITOR CONSERVATION:

I have been away from our home in Cartersville, Ga., since June, but have only had my interest in our forests strengthened by the awful fires which

obscured the sunlight from Maine to Philadelphia.

During my stay in Philadelphia, my native place, I found the enclosed composition, written by a young nephew. I am sending it for you to read, because it seemed to me to contain quite a good synopsis of the reasons why our school-children should be persuaded to become friends of the forests.

CAROLINE D. G. GRANGER.
New York City.

OUR FORESTS—A NATIONAL NECESSITY

In America, as in other countries before it, the first settlers found it necessary to hew down certain portions of the forest in order to make clearings in which to build their houses and plant their corn. Moreover it was necessary to push farther from their dwellings such forests as sheltered wild beasts and savages. Subsequently, as the population grew, the trees were cut down for purely commercial purposes, namely, for the selling of wood for building lumber, pulp, turpentine, and other uses. The continuance of this unrestricted cutting down of trees for centuries without any replanting of young trees, has resulted throughout the larger part of the eastern United States in the partial destruction of the forests, while in some places they have been completely destroyed.

Some states, notably New York, saw the peril of this practice in time and guarded against it by careful restrictions and by the state buying up tracts of forest in which the streams took their rise. Other countries learned the lesson too late. France has had to spend forty millions of dollars in endeavoring to restore lost soil and forest to her mountains after a long course of destruction, such as is now going on in America. The countries which have taken steps to preserve their wood supply, are found to be those which at the present day are most prosperous, and have the best prospects for the future.

The need of wood for some purposes has been lessened; coal, for instance, has been largely substituted for wood as fuel, and many other manufactured things have taken its place for building purposes; but in spite of this, there is more wood used to-day than ever before.

Forest land acts as a vast reservoir, for the earth is naturally soft and easily absorbs the rain, which, on account of the cover of dead leaves and the shade afforded by the trees, is not evaporated by the sun, but is stored up in innumerable springs and in many small lakes or ponds.

From many such reservoirs, large and small, are fed the streams which flow down to the lower lying farm lands and make our larger rivers navigable. By this natural method there is a constant supply of water through-

out the year; whereas when the land is denuded of forests the rainfall and melting snow flow at once into the streams, transforming them into raging torrents, although during the larger part of the year the stream may not contain water enough to make the land fertile. Thus it happens that where there are no natural reservoirs of water in the forests, artificial reservoirs have to be built, and an expensive system of irrigation carried out. Moreover, both the natural and the artificial reservoirs guard against floods, which wash off the loose earth from the mountainsides and carry it to the mouths of rivers, where it is deposited, and from which it must be dug at an outlay of an enormous amount of money.

When the forests fail, the rivers will dry up, for without them there will be nothing to keep the water from running right off. In some rivers already the water for most of the time is not deep enough, but in the spring the streams overflow their banks and cause terrible damage. The floods on our own Mississippi show us what the ruthless destruction of our timber about its headwaters is accomplishing.

When the forests are gone the country becomes uninhabitable. For this reason Tyre and Sidon, Babylon and Antioch came to ruin. One third of China has become unfit for habitation through destruction of the forests, for when they are destroyed the soil soon becomes so poor that it will not support a large population. The country is astounded at a great disaster like that at San Francisco. The people respond willingly, and millions of dollars are immediately given for its aid. Yet we are told that a city like San Francisco might be destroyed every three or four months without causing greater loss of national wealth than is now going on all the time.

The pinch is being felt already, for with the decrease in the supply of hardwood, industries, such as carriage building and furniture making, will be wiped out. The decline in the wood-working industries of Ohio between 1900 and 1905 was more than fifty-seven per cent. In Indiana the timber-using industry fell from the third to the eighth place. In 1905 the furniture establishments in the United States reported the annual use of 580,000,000 feet of lumber, and without hardwood lumber they are helpless. Yet the present supply, which is for the most part in the highlands of the East, will be exhausted in fifteen years. Building materials also have become more expensive, and hence the rents go higher.

Farming also suffers. Thousands of acres once cleared land have been abandoned, and in the South the farms are moving farther and farther up the mountainsides, with only a brief space between the beginning and the end of their usefulness.

Commercially, as a public asset, from the tourists' viewpoint alone, the White Moun-

tains are worth \$8,000,000 a year. Such famous places as Crawford Notch are rapidly being made hideous by the cutting away of the forests.

It is a pleasure to see that the Senate has recently passed a bill appropriating \$5,000,000 for beginning the purchase of lands in the Southern Appalachian and White Mountains.

Our trees must be considered as a crop which needs to be replanted if we would have it continually, and not as something which we may forever cut down and never exhaust. We must face the fact that without forests we can have neither fertile soil nor navigable rivers, and hence without forests we shall become an impoverished nation.

HENRY GREGORY ALLYN.

May 17, 1908.

Eucalyptus Growing

EDITOR CONSERVATION:

I spent most of last winter in southern California, and devoted a large part of the time to a study of the eucalyptus. I found, as claimed by growers, 100 or more species and distinct varieties, nearly all of which are grown successfully where they can get a supply of soil moisture sufficient to produce farm crops, and where the temperature does not fall more than three degrees to six degrees below freezing. They

are grown extensively for fuel, wind breaks, street shade and ornamental trees, and are now being largely planted for railroad ties, telegraph poles, lumber, and many other uses. But experience, as it appears, has not yet fully established the value of the different species for the various purposes, and there is a considerable diversity of opinion as to their relative merits. There are many species of very rapid growth, making annually from three to six times as much wood as the best of our eastern forest and ornamental trees, and while it is doubtful if the enormous profits claimed by some promoters will ever be realized, I believe that as a business, whenever soil and climate are suitable, the growing of eucalyptus will be reasonably profitable. It may be profitably grown on all suitable lands that would otherwise remain unoccupied, and every landowner and homemaker should plant more or less for shade and ornament, wind breaks, fencing, fuel, and various other uses for which trees and their products are always in demand.

S. T. KILSEY.

Las Cruces, N. Mex.



EDITORIAL

The Forest Fires

ALMOST without interruption the reports of forest fires continue to occupy the columns of the daily newspapers. When the final reports for the year 1908 are received and the figures tabulated, it will be found that never in the nation's history have forest fires been so numerous, or their consequences so disastrous as in the year now drawing to a close. No sooner have the fires died out in one region than they have sprung up in another. The fires in the far West and Northwest are extinguished and immediately we read reports of forest conflagrations farther east. The ravaging flames in Minnesota, Wisconsin and Michigan burn themselves out and Maine takes up the story. Back again to the Adirondacks and the White Mountains; then the telegraph tells us of the wasting of Pennsylvania's scanty forests, and before the smoke has passed away, the scene shifts again to Michigan. Maryland and New Jersey also suffer, and the National Capital itself is shrouded in a pall of smoke from burning forests within fifty miles of the Washington Monument.



Thirty Years' Fire Damage

WITHIN the last thirty years, and not including the fatalities for 1908, 1,956 people have perished in forest fires or fires caused by burning forests. Up to the time of writing, the death list for 1908 totals 296, as reported by the newspapers, or about seventy-two human lives per year lost in the flames of burning forests and the conflagrations arising from them.

In 1891 the Division of Forestry collected authentic records of 12,000,000 acres burned over in a single year. The value of the timber destroyed that year was estimated at \$50,000,000. The official census of 1880 estimated the area

burned per year as 10,000,000 acres. While now the acreage of forest burned over every year is undoubtedly smaller, the loss is not decreased, but is even greater, because the value of stumpage has increased since 1880 at least five times, and it is, therefore, only necessary to burn 2,000,000 acres annually to cause the same amount of loss.



Estimate Not Excessive

CITING a few examples of individual fires, it will be seen that the Census Bureau and Forest Service estimates of fire loss are not at all exaggerated. For instance, in 1894, the Hinckley fire in Minnesota burned over an area of 250 square miles, killed 418 people, and destroyed \$750,000 worth of property, this being entirely apart from the vast amount of timber and lumber that was burned. In 1902 a fire on the dividing line between Washington and Oregon destroyed property amounting in value to \$12,000,000.

During the whole of the month of September, this year, forest fires raged in northeastern Minnesota. The towns of Hibbing and Chisholm, which were in the paths of these fires, were practically wiped out, and the total loss, as conservatively figured, amounted to nearly \$10,000,000. The town of Chisholm alone suffered a loss to property, stocks of merchandise, and other items of direct loss, amounting to about \$1,500,000.

The fires that are raging in northern Michigan at this writing have already caused losses estimated at anywhere from \$1,500,000 to \$3,000,000, according to the newspaper reports. One of the appalling features of this great Michigan fire was the derailment and destruction of a train loaded with fugitives from the fire districts. The train, speeding over a track hemmed in on

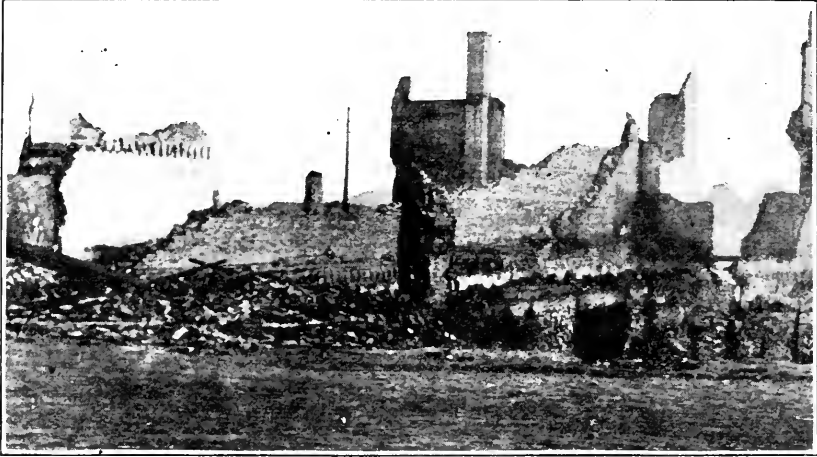

AMONG THE RUINS, CHISHOLM, MINN.

either side by blazing forests, was thrown from the rails, and with no means of escape possible, the fugitives, penned in the cars, were slowly roasted to death. Press dispatches gave the number burned in this wreck and fire as forty-five to fifty men, women and children. It is certain that very few escaped from the doomed train.

Other Features of Loss

THE above are the salient, glaring points in the story of this year's forest fires. There are other points, however, that cannot be ignored—other

items of loss that figured in the grand total of the Nation's bill for forest conflagrations. The loss to new forest growth alone, conservatively estimated, amounts annually to \$90,000,000. If it were not for these forest fires, we might expect an additional growth of twenty cubic feet per acre per year. This, for a forest area of 500,000,000 acres, would amount annually to 10,000,000 cubic feet. Ten billion cubic feet is equal to 45 000,000,000 feet board measure, or more than the present annual consumption of saw timber in the United States; and figured at \$2 per thousand this amounts to \$90,000,000.



ANOTHER VIEW IN CHISHOLM, AFTER THE FIRE

Other items of loss which cannot be estimated in any manner are those of loss of soil fertility where the humus and top soil is burned and calcined to a depth of from a few inches to two or three feet, and where all soil nutriment is absolutely destroyed; damage to river courses and to farming land adjacent to burned-over forests, such loss arising from floods and droughts which are caused by the destruction of forest cover and which annually cost the Nation many millions of dollars; and the constant depreciation in forest wealth and land values which have destroyed and are destroying the prosperity of many sections, and which form a ma-

terial hindrance to business enterprises and industrial development.

Fire Losses of 1907

THE final statistics of fire loss for the year 1907 for national forests having a total area of about 150,000,000 acres show that last year was an unusually favorable one so far as concerned forest fires. Heavy rains in all parts of the country kept down the fires and made conditions such as to be very unfavorable for the starting of any material conflagration. Following is a statement compiled by Mr. E. A. Ziegler, of the Forest Service, covering the fires of 1907.

STATEMENT OF FIRE LOSSES FOR 1907
Showing Lost of Fire-fighting on National Forests

1. Total area burned over.....	212,550 ¹ acres or .14 per cent. of 150 million acres reporting	
2. Timbered area burned over.....	29,365 ² acres	
3. Amount of timber destroyed.....	31,026,000 board feet	
	(or less than .007 per cent. of the 450 billion B.M. estimated stand on this area)	
4. Value of timber destroyed.....		\$31,590
5. Cost of fire fighting (exclusive of forest officers' salaries):		
Labor		\$4,259
Supplies		718
Total		4,977
6. Total number of fires reported:		
Class A		845
Class B		280
Class C		181
Unclassified		49
Total		1,355
7. Cause of fires:		Number
Campers		346
Railroad locomotives.....		273
Lightning		176
Donkey engines		65
Clearing land.....		34
Incendiary		19
Hunters.....		9
Herders.....		6
Miscellaneous.....		60
Unknown or not reported.....		367
Total.....		1,355

¹ Large area burned over due to including three large grass fires on—		
Dismal River (Nebr.) National Forest.....	Area burned, acres...	51,200
Garden City (Kans.) National Forest.....	do.....	38,400
Wichita (Okla.) National Forest.....	do.....	13,840
Total		103,440

²Includes area of 11,500 acres in Chiricahua National Forest, Arizona, reported as timberland, but only 100 board feet per acre were destroyed.

Note.—Comparatively few reports contained the month of occurrence, hence distribution statement is omitted.



AT THE CHISHOLM FIRE

After It Was Too Late to Accomplish Anything, a Few of the Citizens Made an Effort to Fight the Fire with a Water-cart and a Two-inch Hose

It will be noted that fire reports were received on 150,000,000 acres in 1907 against 97,000,000 in 1906. The increase is accounted for by the addition of 53,000,000 acres to the total area of national forests in the year 1906. The 1907 figures are further misleading in that they show the burning over of 212,850 acres by "forest fires," whereas, in this acreage are included three fires on grass lands on the Dismal River Forest in Nebraska, the Garden City Forest in Kansas, and the Wichita Forest in Oklahoma. After eliminating these fires, which were confined altogether to grass-covered areas of an aggregate of 103,440 acres, it will be seen that the actual acreage of average forest land burned over was only 109,410 acres. It will be seen thus that the forest land burned over in 1907 was over 400,000 acres less in area than in 1906, although, meanwhile the national forest area had been increased by 53,000,000 acres.

By its system of fire patrol, the Forest Service has reduced the burned-over area on national forests from sixty-six one-hundredths of one per cent. in 1904, to sixteen one-hundredths of one per cent. in 1905, then to twelve one-hundredths of one per cent. in 1906, and to

seven one-hundredths of one per cent. in 1907. Upon the basis of the Forest Service's experience on national forests on which the total administration cost per acre, including fire patrol, amounts to only 1 cent, the forest area of the entire United States could be patrolled and protected from fire at a total cost of less than \$3,000,000. This would save an annual loss on timber alone of close to \$20,000,000 per year, to say nothing of the prevention of loss and damage of all other kinds caused directly by forest fires.



Fire Protection a Business Proposition

NO TOWN, city or municipality in the United States is without more or less adequate fire protection. The apparatus for urban fire protection may be limited; it may be more or less obsolete—frequently it is—but the protection exists, and in case of emergency it is at hand for subduing or helping to subdue fires that threaten our towns and cities. The entire business district of a city the size of Indianapolis could be destroyed by fire without causing half the loss that is annually caused by for-



ON THE OUTSKIRTS OF CHISHLOM, AFTER THE FIRE

est fires; yet the states go on year after year without fire protection for their timber lands, and without taking any steps toward providing such protection. The State Forestry Board of Minnesota now has just \$11,500 per year to

spend for protection against forest fires. If the fires at Hibbing and Chisholm alone caused a loss of only \$5,000,000, that amount at five per cent. would yield \$250,000 per year; and \$250,000 a year would be a fund sufficiently large



SPARED BY THE FLAMES

Two Churches and the \$125,000 High School Building Were Untouched in the Chisholm Fire

to provide thoroughly adequate fire patrol and fire protection for half a dozen states the size of Minnesota. If our American legislators in reality possessed the business instincts that they are so fond of boasting about, it would not be five years until every state having any amount of timber lands would provide for the safe-guarding against fire of such timber lands. This is a simple business proposition—a proposition to invest, say, forty or fifty thousand dollars a year, to guard against losses that may run far into the millions. How long will it be until American business sense will recognize the business necessity of taking hold of questions like this in a businesslike manner, and take steps to provide the same measure of protection for our increasingly valuable timber lands that they have already provided for towns and cities?



The Hydro-electric-power Interests

A PHASE of the development of the West that has occupied rather a prominent place in the attention of the public during recent years, is that of the exploitation and development of water-powers for the generation of electric power; and friction between the Government, as represented by the Forest Service, and the electric power concerns has been more or less frequent. There are now pending several cases of alleged fraudulent entries covering valuable water-powers, and one of the largest of the electric power concerns is charged with being directly responsible for a large number of these fraudulent claims. It is charged that this company, which is said to be an auxiliary of the largest electric power and manufacturing concern in the country, has secured possession of water-powers by the expedient of having stenographers in the employ of the company make dummy entries; and the statement is also made that in at least two or three instances the consent of such dummy entrymen has not even been secured, and they have not known that their names were

being used until they were notified of the fact by Government officials.

Now, the day for bald pilfering of this sort has passed, and the big corporations ought to have realized that fact. No man and no corporation, no matter how wealthy, great or powerful, can, in this day of grace, filch from the Nation any of its natural resources without being made to pay the penalty. Whether it be timber, or grass lands, or water-powers, detection is sure to come, and, following detection, punishment swift and stern. The plea still goes up that to take from such a "developing agent" the resources so pillaged means to retard the "development" of the particular region affected. Well, if that region can only be developed through the agency of theft or grand larceny, then it were better that the region remain undeveloped till the crack of doom.

Conservation of natural resources means the saving from needless waste and destruction of the natural riches which we have, and the exploitation, through proper use and proper development, of all of our resources of land, water, timber, ores, minerals, water-powers, etc. It does not, however, mean their exploitation by improper use or improper development, or improper means, and theft of any of these resources is certainly improper. Likewise, it is expensive and unsafe, nowadays, no matter what it may have been a dozen years ago. A business, no matter what it may be, and no matter who may be the men in control of it, that cannot exist without resorting to theft—to bald-faced pillaging, piracy and robbery—should not be permitted to exist at all. And along this line we reproduce in full an editorial article that appeared in the issue of October 3 of the *Journal of Electricity, Power and Gas*. It is as fair and logical a presentment of the case as we recall having seen in a long while.

For some time the *Journal* has been giving careful thought to the hydro-electric companies, and to the problems that grow out of their

controversy with the Government. These thoughts have found expression in our editorial columns. The questions involved may jeopardize or affect millions of dollars of invested capital. The investment of further millions in western enterprise may be postponed or abandoned entirely, depending upon the wisdom of the policies outlined. Locked up in the proper solution of the hydro-electric controversy are more matters of vital interest to the West than are involved in any one other problem that confronts us—not excepting irrigation, for it includes irrigation.

Ignore for the moment the invested capital, and the contemplated investments for the future in this line of endeavor. Consideration of this view alone is selfish and personal. It appeals to the intelligence and it appeals to the pocketbook. But these things do not touch the interest of the public man or the private citizen nor does it affect the attitude of the general press or the public officer.

To predicate a request for national legislation upon the desire of some man, or some set of men, to invest large capital in a power or lighting plant is not enough. Our stand must be made on firmer ground; our foundation must be laid broader and deeper than mere personal interest.

The question involved is PUBLIC in its nature. The entire West is affected harmfully or beneficially by its solution. And we must appeal to the people—to the farmer, to the miner, to the vinedresser, to the manufacturer—to the tens of thousands of citizens whom we all know are to be served and are to be benefited by the installing of the vast power plants already under way or in immediate contemplation as soon as this vexed question be settled.

Is not the West interested in having the arid lands made fruitful? Would not the work of the

power companies be of untold value to the prosperity of not only sections immediately served by them, but of the whole state itself? Would it not be of immense state value to have lifted to the surface the great streams of water that course their way deep below soil that is parched and dry, but rich, and needing only water to render it a priceless asset to the state?

Is not the owner of that land, who knows that beneath the surface lies the deliverance of his soil, interested and benefited, nay, saved, by the facilities the power companies propose to furnish him in the way of power to raise that water to the surface?

Run over in your minds, you gentlemen of the hydro-electric interests, the long list of industries and the large populations you expect to serve. Catalogue them—no one can do so better than you—and then say whether your undertakings are to be a benefit or a curse to these citizens and to the state. That is the test! Are your great enterprises to benefit any one other than yourselves? If not, then perhaps they are better dismantled, better closed down, better never begun.

You are going to sell the thing you have for sale cheaper or on more advantageous terms than the customer can at present secure an equal services at other hands. You are going to do this, or the oil man, or the coal man, or the other power-providing man is going to keep the business at the old rates.

It is a business proposition. You ARE proposing to do better by your customers than it is possible for them to do to-day. You propose to erect these plants to secure business, to serve the public, to cheapen cost of production, to make it an advantage for a power or light consuming public to purchase your wares. Then you are to be a benefit to them, not a curse.

The *Journal* believes that the material prosperity of the West is to be affected very largely by the success or failure of your enterprises. We know that the fate of millions hangs upon a slender thread. The *Journal*, which is a part of your electrical world, shares all the hopes and fears and all of the suspense that you feel. We therefore feel emboldened to speak our mind.

Court publicity. Deal frankly with the people and take the world into your confidence. Be open, and if this is to be a campaign of education, as it must be to a great extent, let the people and the communities to whom you speak, feel and know that your every promise will be kept to the letter and that you are to benefit and to help them and the state as well as yourselves.

This admonition may not be necessary. The *Journal* does not believe it is; but we do believe it necessary to let the public fully understand that such is your spirit, that such are your intentions, and that the battle we have ahead of us is one in which they, the people, are as vitally interested as you are.

Lest we may be misunderstood, the *Journal* states that it stands pledged to the cause of the National Forest. The wilful, the awful and scarcely conceivable waste that the country has unnecessarily suffered in its natural resources is appalling. The plunderer of forests has mowed down all before him with a wicked wantonness. He has given no thought to to-morrow. To-day has been his fetish.

If the cause of the hydro-electric companies involved even to the smallest extent a fight against the underlying theory of the National Forest movement, or the conservation of our natural resources, we would hesitate before espousing it. The work inaugurated by Gifford Pinchot, and the services rendered by him, are entitled to the highest encomiums at our hands and at the

hands of the people, who should be grateful, even though they are not. In this day of abundance and waste we are not likely to appreciate the work of the man to the fullest extent. Future generations surely will.

Doubtless this man is jealous of his cause. It may be difficult to treat with him, difficult to induce him to adjust and dovetail his great work with the demands of a modern, every-day affair. But we must have patience. The cause of the hydro-electric interests rests on a sound foundation. If it does not, then the cause should not succeed. There may be cases where too much is expected, or where too much has been demanded. We know of no such cases. So far as our information goes, the problem to be solved is a simple business proposition. The state, and the people of the state, will be beneficially or harmfully affected by its proper or improper settlement.

True, rich men and wealthy corporations are very largely interested in the immediate question at hand. But the ultimate beneficiaries of their enterprise will be the people. It is not an easy matter to surround the petitions of large corporations with anything like sentimentalism, and sentiment comes pretty near moving the world.

The hydro-electric people appear before the Government, saying:

1. We offer you a means of conserving the coal resources of the country, which are being rapidly exhausted.

2. We offer you a means of conserving the oil deposits of the country.

3. We offer you a means of bringing to the surface the wasted waters that flow under our arid lands, and so save for other uses the water already flowing in our streams.

4. We offer you a means of wresting from the desert, land long regarded as worthless.

5. We offer you a means of cheapening the products of the farm, of lightening the labors of the farmer and the farmer's wife.

6. We offer you a means of conserving and distributing power and light, driving machinery and factories, drawing passengers and freight and cheapening the products of the land.

7. We offer you roads and highways, and easy means of reaching the great forest reserves where we will operate our plants.

8. We offer you these things without consuming one drop of water, without lessening the resources of the country, but promise you that our work will assist, help and contribute toward the very purpose to which we all stand pledged; namely, the conserving of the natural resources of the Nation.

The matter of adjusting whatever differences that here arise between the Government and the hydro-electric companies are not questions of law; they are business questions, questions of policy, questions that require good, wholesome common sense.

If any one representing the hydro-electric interests, have at any time joined the despoiling lumberman's selfish crusade against forest reservation as a Government policy, they have made a woeful blunder. The hydro-electric enterprises in effect and in spirit are in complete harmony with the movement. They ask nothing that diminishes in the slightest a single natural resource; they offer a means of conserving the very valuable and rapidly disappearing resources of the country to which the policy of the Government stands pledged.

At no point do their interests chafe against the working plan of conservation. There is no friction, and there should be none, any-

where between the Government and the electric people. There will be differences of opinion; a dozen questions may arise that need adjustment; but the individual who, in the cause of the hydro-electric interests, goes into this matter with a club in one hand and a complaint at law in the other is going to lead the hydro-electric interests into a controversy where they do not belong—not for the present, at any rate.

Victories won in the teeth of public opinion are costly affairs at best. The victor reaps a harvest of trouble in the years to come. We have justice and right on our side, and in the end it must prevail. First let us try common sense.



Interest of Public School Pupils in Forest Conservation

IN ANOTHER part of this issue we print two articles which are rather unusual. The articles appear under the head of "Communications," and were sent to us by members of The American Forestry Association for publication in CONSERVATION. We refer to the two essays, one by Miss Ellen M. Hastings, of the Elk River (Minnesota) High School, and the other by Henry Gregory Allyn, a pupil of the eighth form of one of the Philadelphia schools.

These articles, or essays, rather, indicate in an unmistakable manner the interest that is growing up among American school children in the subject of forestry and its relation to the broader general subject of conservation of the nation's natural resources. The value of the contributions lies not in any new statements, or the expression of any novel opinions, but rather in the fact that both of these papers show that the writers have certainly assimilated the basic facts of the great problem of taking care of the resources we have and of replacing those resources that we have wasted.

The fact has long been recognized that a fertile field of effort lies ready to our hands in the public schools of the

United States. In these schools the nation is raising up the youth that will, in a few years, be the men and women of the country. If these future men and women come to maturity with well-grounded ideas, such as are expressed in the two essays printed in this issue, there is every reason to hope that the cause of conservation will be materially advanced at their hands. It is an omen of promise to note the clear and ready statement of fact contained in these essays; not the parrot-like repetition of statements memorized, but the reduction to a form that is understandable by the juvenile intellect of the matured opinion of high authorities on these weighty subjects. One of these papers comes from the East, the other from the Northwest. We have likewise received essays of the same sort from the Middle West, the South and the West. In every case the essays are the work of boys or girls in the grammar or high schools; and the essays are in each case worthy of publication and would be published were it not for the limitations of space in this magazine. We commend these articles to the careful consideration of our older readers, and, in fact, of every member of The American Forestry Association. Immaturity of expression and lack of style there may be indeed; but these are minor points. The fact remains, amply illustrated by the two essays that appear in this issue, that the boys and girls of our public schools are taking a lively interest in matters pertaining to forestry, and it will be well, indeed, to further this interest by all the encouragement that can possibly be given.



The Conservation Program in Politics

ONE of the most encouraging features of the political campaign of 1908 has been the unanimity with which the political parties have taken a decided stand in favor of the conservation of natural resources. No matter which Presidential candidate is successful at the polls, the cause of conservation will not suffer. Both the Chicago platform and the Denver dec-

laration of principles declare strongly for a conservation program; Judge Taft and Mr. Bryan are both ardent friends of the conservation movement, and in more than one section of the country Congressional campaigns have been waged principally on the issue of conservation of natural resources.

No matter who the successful candidate shall be, and no matter what may be the political complexion of the next Congress, there will be no backward steps in the movement to take care of the Nation's resources. In the several states, particularly those most affected by any of the different phases of conservation, the movement, it seems certain, will receive a decided impetus during the coming legislative sessions. The leaders, both national and state, of both big parties have recognized the necessity for husbanding the forests, the ores and minerals; for developing a system of waterways; for extending irrigation works, and in general for doing the best we possibly can with the resources that nature has given us.

In this connection, the following quotation from the Democratic state platform of Montana is peculiarly apropos. We quote the fourth, fifth, sixth, and eighth paragraphs of the platform, which paragraphs express in unmistakable language the sentiment of a majority of the people of a great north-western state:

It is of paramount importance to protect, develop, and conserve the unparalleled natural resources of Montana under laws most carefully considered and wisely enacted for that purpose, and which will permit a present use sufficient to satisfy reasonable industrial needs and preserve the same as far as may be for future use and development.

Land being the most enduring resource, the permanent prosperity of a people can be best assured by its proper development and conservation; therefore, we recognize in the liberal grant to the state by the Federal Government for educational purposes a solemn trust, to be most carefully and wisely administered and conserved for the purposes for which granted and a great source of wealth, which growth in population will tend largely to increase. This trust should be so administered as to produce at all times the highest possible revenue consistent with a far-sighted conserving policy, and title to such lands as are agri-

cultural should pass to actual settlers in such quantity only as may be necessary to make homes for the settlers.

In order to promote regularity in the flow of streams and the furnishing of a larger volume of water for irrigation and all other useful purposes, the proper and scientific administration of the forests and timber areas, the property of the state, is a policy available forthwith to be initiated and at all times strictly pursued. The enactment of legislation to prevent, as far as may be, forest fires, the stripping of watersheds, and the cutting of unripe timber on lands not profitable for agricultural and horticultural purposes is hereby pledged. Experiments in reforestation should be made, with a view to ascer-

taining the practicability of affording protection to bare or denuded watersheds.

For the development and prosperity of the present and future industrial enterprises of Montana, the use of water for power purposes is necessary, and every encouragement consistent with a proper safeguarding of the public interests should be given to such use; these safeguards to be furnished by a law permitting the use of water for power generating purposes thereafter initiated, only after a franchise thereof is granted, and under such regulations, restrictions and conditions as, while insuring justice to the investors interested in power development, will relinquish no inherent right of the whole people to whom this and other resources belong.

ANTI-FOREST-FIRE CONGRESS

Twenty-eighth Annual Meeting of the American Forestry Association
Willard Hotel, Washington, D. C., January 13, 14, 1908

A SESSION on Forest Fires, at which the losses of the year will be summarized and means of fire prevention will be discussed.

A session on State Forest Work.

A session devoted to the relations of Forests to Waterways and Soils.

A session devoted to the Appalachian and White Mountain Forest Reserves and the Conservation of Natural Resources.

Each session will be addressed by leading experts from all parts of the country.

A further announcement will appear in the December number.

NEWS AND NOTES

Important Meetings in Washington

AMONG the important meetings to be held in Washington during the month of December are the following: The Southern Commercial Congress on December 7th; The meeting of the Governors and their advisors on December 8th; The meeting of the National Rivers and Harbors Congress on December 9th, 10th, and 11th, and on the same dates the meeting of the Woman's National Rivers and Harbors Congress.

The growth of the Woman's Rivers and Harbors Congress has been little less than phenomenal. Organized on June 29th last, the Congress already has branches in twelve states. Following are the state vice-presidents of this organization: Alabama, Mrs. O. C. Wiley, 141, College St., Troy; Florida, Mrs. T. M. Shackelford, Tallahassee; Hawaii, Mrs. A. F. Knudsen, Kakaha, Kaai, T. H.; Indiana, Mrs. N. L. Agnew, 307 Michigan St., Valparaiso; Iowa, Mrs. J. L. Kennedy, Sioux City; Louisiana, Mrs. W. A. Wilkinson, Coushatta; Massachusetts, Mrs. Emons Crocker, 48 Mechanic St., Fitchburg; Maryland, Mrs. M. M. North; Missouri Mrs. E. C. Ellis, 2456 Tracy Ave., Kansas City; North Carolina, Mrs. Lindsay Patterson, Winston-Salem; Ohio, Mrs. J. F. Ellison, 2327 Ashland Ave., Cincinnati; Tennessee, Mrs. Benton McMillin, 125 7th Ave., North, Nashville.

The officers of the Woman's National Rivers and Harbors Congress are: President, Mrs. Hoyle Tompkins, 980 Jordan St., Shreveport, La.; Corresponding Secretary, Mrs. Frances Shuttleworth, 621 Cotton St., Shreveport, La.; Vice-president, Mrs. J. Claiborne Foster, Shreveport, La.; Recording Secretary, Mrs. A. B. Avery, Shreve-

port, La.; Treasurer, Mrs. L. C. Allen, Shreveport, La.; Auditor, Mrs. J. D. Shreveport, La.



Work of The Connecticut Forestry Association

ON SEPTEMBER 21st The Connecticut Forestry Association held a field meeting in the town of Union. About forty members attended, and, considering the inaccessibility of the meeting place this attendance was considered highly satisfactory. An interesting address was delivered by Mr. Geo. Myers, after which the State Nursery was inspected. In this nursery 350,000 white pines are now being raised. Later in the day the members present tramped over the state forest and examined the plantations of white and Scotch pines which have been made during the past three years. Much interest was expressed, and many announced their intention of planting up some of their own waste lands during the coming year. As a result of the example set by the state, over 250,000 trees have already been planted by private owners in the town of Union.



"A Primer of Conservation"

THE Forest Service has just issued, as circular No. 157, a little booklet that should be in the hands of every member of The American Forestry Association and every friend of the conservation movement in the United States. The title of this pamphlet is, "A Primer of Conservation." It is written by Treadwell Cleveland, Jr., and presents in concise form the case for the conservation of our natural resources. There is not a superfluous paragraph in the pamphlet; from the introduction, the only possible fault of

which might be that it is too well written, to the last page it is clear, concise, and full of interest. The pamphlet contains excerpts from practically all the addresses made at the White House Conference in May, with a history of the origin of the Conservation Commission and the make-up and objects of the Commission. Those desiring a copy of this pamphlet can secure it by addressing the Forest Service, Washington, D. C.

Irrigation Notes from Washington

SIXTEEN thousand acres of land in Benton County, Washington, southwest of Spokane will come under the canal which the Richland Land Company is building out of Richland. The tract is on the divide between the Columbia and the Yakima rivers, overlooking the first named, and is the last gravity system on the latter stream. The main canal, upon which several hundred men and teams were put to work in the middle of October, is to be fifteen miles in length, and will be completed next February.

The organization back of the project is the result of the merging of the Lower Yakima Irrigation Company and the Benton Water Company, the latter having a canal which supplies 4,000 acres in the vicinity of Richland. Those interested in the new company are: Howard Amon, formerly president of the Benton Water Company; Lee A. Amsbury and Samuel T. Laird, formerly of Garfield, Wash.; Rufus Fullerton, formerly of Palouse, Wash., and Messrs. Allen, Downs and Struve, of Seattle. Headquarters has been established at Richland.

Practically the entire Yakima River is diverted at the intake of the canal, part of the water going into the Northern Pacific Irrigation Company's canal and the remainder into the canal now under construction. The Lower Yakima Irrigation Company has the oldest rights on the river, having consolidated with the Yakima Irrigation and Improvement Company's rights, also the old Rich rights.

Engineers measured the stream during the irrigation season last summer, and at all times there was at least 1,000 gallons of water going through the gates, unused, every second. This insures an abundance of water for the project. The North Coast Railway Company has construction crews between Richland and Kennewick, and the Kennewick Northern is hastening men and material into the field, which will give Richland two railroads.

Leon Lake Irrigation Company has been organized in Spokane, with a capital of \$100,000, to irrigate 2,000 acres of land between Deer and Leon lakes, in Stevens County, Washington, north of Spokane. The incorporators are M. R. Mann, B. H. Becker, and E. Morgan. Water will be taken from Deer Lake and led through a canal one and a quarter miles to the edge of the land. The canal will be six feet wide at the bottom, and four feet deep. It will cost \$25,000 to construct it and complete the laterals, which will tap every acre of land.

Deer Lake contains 1,600 square acres, and has a watershed of 700 square miles, hence the supply of water is sufficient for far more than the 2,500 acres to be reclaimed. Most of the land is level and is wooded. Work on the irrigation system and on clearing the land is now under way, and will be completed in time for crops next spring. The land will be devoted to apple-trees and berries. No provision has been made by the company for a domestic supply, but water is reached at a depth of from fifty to 100 feet all over the new tract.

M. H. Allen, treasurer of Sumpter, Oreg., south of Spokane, has petitioned that city for a right of way for a water ditch through the town. His object is the reclamation of a vast tract of land contiguous to Sumpter and beyond. Much of this land was formerly held by the Sumpter Townsite Company, which platted many acres, with the idea that at no far future date the city would absorb it for town lots. This dream has been dispelled and the town-

site company has given Mr. Allen an option on all its holdings. The ditch will not only supply water for this land, but many acres of other farming ground will be brought to a state of cultivation. The scheme is looked upon as one of the most important that has taken root in Baker County for some time. Under cultivation the land will guarantee an income of \$45 an acre yearly from its hay product alone. It is now a waste.

Spokane capitalists are planning to put in a big irrigation plant on the Columbia River, above the Cascade locks, southwest of Spokane, where a vast tract of land has been secured, and more land is under option. Cassius Wright, a rancher on the Big Klickitat River, reports that the syndicate is buying farming lands up the river sixteen miles from Lyle, Wash., with a view of making a canal into Lyle, where the fall will be 400 feet. Electric power may be generated for manufacturing purposes. The suitable fruit lands along the river will be subdivided into tracts and sold to truck and fruit growers, with water privileges.



A Pioneer in National Irrigation and Forestry

TIME is the real test of wisdom. However wise a man may seem to-day, events of future years may prove him to have been a simpleton; and ideas that to-day appear Utopian may, after many to-morrows, command the respect and admiration of the multitude.

Occasionally a man has arisen whose ideas and work have gained their greatest appreciation long after his death. Such a man was John Wesley Powell, formerly Director of the United States Geological Survey. The far-reaching foresight of this man is becoming more manifest with the passage of years. Every feature of his plans for the organization and conduct of the Geological Survey shows that he had vividly in mind all the importance of the larger movements that only to-day are being

agitated—movements for the conservation of the National resources.

Major Powell foresaw the time when accurate information would be needed concerning the mineral products of the public domain. He realized that at some time in the future forestry would be a great issue. He saw the potential value of the reclaimed arid West and foretold the era of National reclamation. To be ready for this he measured the streams from which the water must be derived for irrigation and hastened the topographic mapping of the areas involved.

Many other projects of National importance were foreseen and prepared by Powell, the last that has been forcibly brought to notice being the project for national drainage. During the recent public agitation of this matter, when broad and exact data were desired, the needed facts were found ready in the records and publications of the bureau that he had created. Probably few of the persons making those early investigations realized half the meaning of the results for the future, but Powell fully understood their importance.

At the time Powell resigned the Directorship of the Geological Survey one of his more intimate younger associates asked him what work that he had done would, in his own judgment, be most likely to keep his name in the memory of men. He replied at once, "My trip down the Grand Canyon." The reply was modest, for the trip down the Grand Canyon was only a season of daring exploration and wild venture. Powell's more enduring memory is involved with the work of building up a great National Bureau, with the larger problems he foresaw, and with the larger solutions for which he made preparation. When the truly great Americans are more wisely judged in a day of better judgment it may be that this wise counsellor for the determination and conservation of the Nation's resources will stand high among the prophets and patriots of the National pantheon.

"PAYMENT CONDITIONAL UPON SUCCESS"

SMOKY FIREPLACES REMEDIED

Twenty years' experience in dealing with the above trouble. Thoroughly trained workmen employed. In most cases work can be done without defacing decorated walls and with little inconvenience to the household

**Examinations and estimates without charge within 500 miles of New York
Contracts entered into with the understanding that charges are for results**

The following are a few of the many thousands who have availed themselves of my services:

Grover Cleveland, Princeton, N. J.
W. A. Slater, Washington, D. C.
Mrs. John Hay, Washington, D. C.
Princeton University, Princeton, N. J.
Senator Aldrich, Providence, R. I.
Clement B. Newbold, Jenkintown, Pa.
University Club, New York
Union League Club, New York

Hon. Whitelaw Reid
Hon. Joseph H. Choate
J. Pierpont Morgan
John D. Rockefeller, Jr.
Col. John J. Astor
George J. Gould
Henry Clews
Joseph Pulitzer

Architects

U. S. Government for:—
White House, Washington, D. C.
U. S. Naval Academy, Annapolis, Md.
McKim, Mead & White
Carrere & Hastings
Hunt & Hunt
Ernest Flagg
Howell & Stokes

JOHN WHITLEY

Engineer and Contractor

215 Fulton Street, Brooklyn, New York



Before Treatment of Cavities

Don't Let the Old Trees Die

Young trees may not equal the old ones in size and beauty during your life. Insecticides, fertilizers, bolting, pruning, tree surgery, and cavity-filling are only part of the practical means of restoring sick and dying trees to health and beauty. We examine estates, suggest improvements in planting new stock, and direct the work of saving diseased trees and shrubs. Trained assistants equipped with proper tools are furnished when desired. A booklet entitled "The Care of Trees" is sent on request.



After Treatment of Cavities

H. L. FROST & CO., The Pioneer Tree Specialists
Landscape Foresters and Entomologists
Arlington, Mass. White Plains, N. Y. Stamford, Conn.

Congressional Information Bureau

CLAUDE N. BENNETT, Manager

Attends to business before Congress, the Courts, Patent Office, Interstate Commerce Commission, and all other Departments of the Government at Washington.

Supplies any desired information from the Capital, furnishes advices concerning matters pending in Congress, the Courts or the Departments, and transacts business at Washington for clients anywhere in the world.

Conducts library research along any designated lines.

Has a Legal Department that prepares briefs for lawyers or other clients.

Usefulness demonstrated by ten years' successful experience.

Congressional Information Bureau

BOND BUILDING

WASHINGTON, D. C.

HOW TO RUN AN AUTO

Are You Interested in Automobiles?

If you are, an early purchase of "HOMANS' SELF PROPELLED VEHICLES" will prove a good investment.

This work is now the accepted standard on the practical care and management of motor cars—explaining the principles of construction and operation in a clear and helpful way, and fully illustrated with many diagrams and drawings.

The presentation of subjects has been determined by consideration of the needs of the man behind the wheel. It is clear and concise in its treatment, and comprehensible to the most inexperienced automobilist, at the same time it is so thorough that the expert will learn much from its pages. Contains 608 pages, over 400 diagrams and illustrations, printed on fine paper, size 3-3/4x8-1/2 inches, with generously good binding. Highly endorsed.

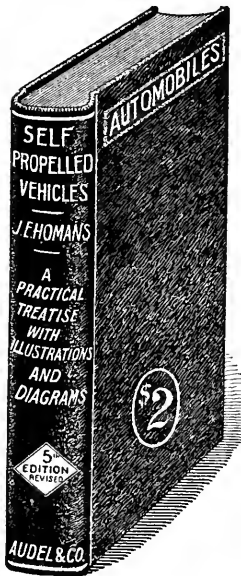

This good book will be sent to any address in the world, postpaid, upon receipt of two dollars, or if desired, will be sent on approval to be paid for after examination.

No money in advance required, sign and return
Theo. Audel & Co., 63 Fifth Avenue, New York
Kindly mail me copy "Homans' Auto," and if
found satisfactory I will immediately remit
\$2 or return book to you.

Name
Address
Date
For



MEXICAN PECAN-OKAS CANDY

Registered U. S. Patent Office

A new candy—original with us—wholesome, satisfying. Made of freshly shelled Pecan Nuts and carefully blended sugars. Rich in nutriment—sustaining—healthful. Pecan Nuts contain practically all of the important nutritive elements. Our blend of sugar adds the necessary properties to make a perfect food. We will send you a box (nearly 2 pounds) any place in the world, all charges prepaid, for a dollar bill mailed at our risk.

BROWNLEY'S, Dept. K, 1203-5 G St. Washington, D. C., U. S. A.

**F. R. MEIER
CONSULTING FORESTER**

1 Broadway, New York

TIMBER ESTIMATES, WORKING PLANS, FOREST APPRAISEMENT, TREE PLANTING, TREE SURGERY

Advice on profitable handling of woodlots, forest tracts, beautifying country estates. Work supervised. Seventeen years experience in the United States.

ORCHIDS

ORCHIDS

We are the largest Orchid Growers in the United States.

Our Illustrated and Descriptive Catalogue of Orchids is now ready and may be had on application.

Orchid Growers and Importers

LAGER @ HURRELL
SUMMIT, N. J.

BURNS AIR NOT MONEY.

One 'BEST' Light
Gives more Light than
Six Electric Lights, or Ten Kerosene Lamps or One Hundred Candles.

Burns 90% Air 10% Gas

A beautiful, pure white, steady, safe light. No Wick! No Grease! No Smoke! No Odor! Hang or set it anywhere. Over 100 Styles.

AGENTS WANTED.
THE BEST LIGHT CO.,
351 E. 5th St., Canton, Ohio.

The World's Greatest Poultry Paper

THE FEATHER

Only 50 cents a year

THE FEATHER'S LIBRARY

- No. 1. **DISEASES OF POULTRY.** By D. E. Salmon, D.V.M. Fully illustrated. Paper, 50 cents; cloth, \$1.
- No. 2. **THE FEATHER'S UP-TO-DATE POULTRY HOUSE.** Paper, 25 cents.
- No. 3. **THE AMERICAN FANCIER'S POULTRY BOOK.** Profusely illustrated. By Geo. E. Howard. Paper, 50 cents; cloth, \$1.
- No. 4. **PLYMOUTH ROCKS.** Colored illustrations. By T. F. McGrew. Paper, 50 cents; cloth, \$1.
- No. 5. **WYANDOTTES.** Colored illustrations. By T. F. McGrew. Paper, 50 cents; cloth, \$1.
- No. 6. **POCKET MONEY POULTRY.** By Myra V. Norrs. Paper, 50 cents; cloth, \$1.
- No. 7. **THE EGG QUESTION SOLVED.** By T. F. McGrew. Paper, 25 cents; cloth, 50 cents.
- No. 8. **HOW TO GROW CHICKS.** By T. F. McGrew. Paper, 25 cents; cloth, 50 cents.
- No. 9. **THE HOMING PIGEON.** Illustrated. Paper, 25 cents; cloth, 50 cents.
- No. 10. **THE FEATHER'S PRACTICAL PIGEON BOOK.** By J. C. Long. Paper, 50 cents; cloth, \$1.
- No. 11. **MONEY IN SQUABS.** Profusely illustrated. By J. C. Long and G. H. Brinton. Paper, 50 cents; cloth, \$1.
- No. 12. **THE FEATHER'S PRACTICAL SQUAB BOOK.** By W. E. Rice. Paper, 50 cents; cloth, \$1.
- No. 13. **PERFECTED POULTRY OF AMERICA.** By T. F. McGrew and Geo. E. Howard. Illustrated by Louis P. Graham. Cloth, \$2.50.

SPECIAL OFFER

Our latest book, **THE PERFECTED POULTRY OF AMERICA, and THE FEATHER** for one year for the price of the book alone, \$2.50.

THE HOWARD PUBLISHING CO.

714 Twelfth Street Northwest Washington, D. C.



We carry a large assortment of seeds of **EVERGREEN** and **DECIDUOUS TREES** and **SHRUBS**, both native and imported, and shall be glad to quote on any that are still unsold.

J. M. THORBURN & CO.

33 BARCLAY STREET

Through to 38 Park Place

Established 1802

NEW YORK

ADDITIONAL REAL ESTATE ADVERTISEMENTS

Continued from First Advertising Section

VIRGINIA

A FINE LOUDOUN COUNTY FARM FOR SALE

This farm contains 169½ acres, 2 miles from Leesburg, 1½ miles from Clarks Gap, on the Southern Ry.; there is about 30 acres of corn on the farm, 20 acres in good woodland, balance in grass; this farm produces well, either for grazing purposes or cultivating; well watered with running streams of water, a splendid spring and dairy house convenient to the dwelling, an 8-room dwelling, with nice shade, etc.

There was about 50 tons of hay made on this place this year. There is an extra fine barn, room for 6 or 8 head of horses and 20 cows, corn house and other out-buildings.

This farm has been equipped as a dairy farm and has been run as such until recently, shipping milk to Washington, where there is one of the best markets for milk there is to be found. Any one can run 25 to 30 cows on this farm; by doing so, would have a regular monthly income the year round.

The owner is an old dairy farmer, and offers his services gratis for a week or so to any one wishing to learn the dairy business.

Apply to

HAYWARD & BROWNING, Falls Church, Va.

One hundred sixty-five acres, 9-room house, six 6-room houses, four cattle barns, calf barn, machinery, and every convenience for dairy. Improvements cost \$180,000. Price, \$35,000

ANDERSON REAL ESTATE @ LAW CO.
Richmond, Va.

Summer homes, hunting preserves, and farms, in Old Virginia. Write,

W. E. LAWSON
Hampton, Va.

CONSULT CONSERVATION'S Information Bureau if in search of advice as to the purchase of timber lands or farm lands advertised in this magazine. Our services are *free* to our readers.

A Running Water Supply Plant

that takes care of itself—furnishes its own power—requires no attention or repairs—that is what you get in a

RIFE HYDRAULIC RAM

Raises water 30 feet for every foot of fall from any nearby stream, spring or pond. Any capacity for all Home and Farm uses, Irrigation, Town Plants, Railroad Tanks, etc. Low in cost, high in efficiency. Satisfaction Guaranteed.



Plans, Estimates and Book **Free.**
RIFE ENGINE CO.
2172 Trinity Building,
New York

Tall Timber
and
Grazing Farms

I HAVE for sale a 2,300 acre tract of white oak timber (every acre of which is well timbered) four miles from C. & O. Railroad. This is the prettiest, tallest, straightest, biggest and healthiest white oak that can be found in the United States.



It lies comparatively level, all slopes very gently in one direction, thus making it one of the cheapest logging propositions in the country. This tract will cut 12 M feet to the acre and will run 85 per cent. white oak, the balance being poplar and hickory of the finest quality.

For further particulars, address

T. M. GATHRIGHT

*Coal, Iron Ore and
Timber Land*

COVINGTON, VIRGINIA

NEW YORK

11,000 ACRES

TITLES PERFECT

J. F. WEATHERS & COMPANY

Timberland in Alabama on new railroad. Will cut 8,000 feet merchantable lumber. Will sacrifice for quick sale at \$6.00 per acre. Underlaid with 3 seams best coal and fine iron ore.

TIMBERLAND SPECIALISTS
1326 Broadway, New York

FOR SALE

Game and Trout Preserve

Sullivan County, New York; 2,300 feet above the sea level, 425 acres, over 300 acres in forest; a lake covering 70 acres, fed by numerous springs located on the premises. Lake stocked with trout; there are also partridge, deer, and other game.

Large four-story house and a two-story cottage, both furnished; fine views; for sale, including furniture, stock, implements, etc. For terms and particulars, address

W. F. DAVENPORT

171 Broadway, New York, N. Y.

FOR SALE — FARMS, COUNTRY ESTATES, BUILDING SITES; ALL SECTIONS; WRITE YOUR WANTS
W. F. DAVENPORT
171 BROADWAY, NEW YORK, N. Y.

WASHINGTON, D. C.

REAL ESTATE

BOUGHT, EXCHANGED AND SOLD

No matter where located, will buy or sell your business or Real Estate for CASH. Real Estate loans at lowest rates.

CLARENCE E. TUCKER
Metropolitan Bank Bldg. Washington, D. C.

MARYLAND

A SPLENDID OPPORTUNITY

150-acre farm in Maryland, within driving distance of Washington, D. C. Has first-class soil, well suited for all agricultural purposes; a substantial brick mansion, colonial style, of fourteen large rooms, marble mantels, and a cellar under the whole house. All necessary farm buildings, and a large orchard. Price, only \$4,000; must be sold at once.

H. BADENHOOP

111 N. Charles St., Baltimore, Md.
(Call or write for my list of Maryland farms)

PENNSYLVANIA

Beautiful Summer Home

On Trolley Line

110 acres rich soil in high state of cultivation; 9 room house, 2 barns and necessary outbuildings, some good timber, nice orchard, fine stream of water through farm. This farm has never been rented. Owing to the death is offered for sale. It fronts on Meadville Conneaut Lake and Linesville trolley line. About 1 1/2 miles from Exposition Park, Conneaut Lake, and 1/4 mile from station on Bessemer R. R.; 1 mile to high school, church, and store. Price, including crops, pair horses, a number of cattle, all tools and equipments, \$6,500. Best bargain offered in Crawford County. For further information, apply to

VET. L. BROWN CO., Timber, Coal and Farm Lands
Rooms 207-8 331 Fourth Ave., Pittsburg, Pa.

WEST VIRGINIA

A. G. WYNKOOP

Fine farms, fine orchards, ore,
coal and timber lands for sale

CHARLES TOWN, JEFFERSON CO., W. VA

WONDERFUL BARGAIN

595 acres on beautiful Chesapeake, in southern Maryland; two miles water front, affording splendid opportunity for oystering; 200 acres fine timber; large, old-fashioned brick dwelling; six room tenant house; two new tobacco barns, largest in county; several other outbuildings; near wharf, schools and churches and easily accessible from Baltimore and Washington; will take \$9,000, which is less than cost of buildings; other high-class farms and grand old colonial homes, finest in South. Catalogue. Splendid timber propositions.

SOULE REALTY COMPANY

FARMS near the National Capital, suitable for all classes, and purposes, reasonable in price, advantage of best market in the country. Healthy and delightful climate.

Write us for particulars.

NATIONAL FARM AGENCY
1407 N. Y. Ave. N. W. Washington, D. C.

Hardy Shrubbery, Trees, and Specimen Evergreens

In Small and Large Sizes Our Prices Are the Lowest for Quality Offered. Estimates Given on All Landscape Work. Write for Prices.

W. F. McCLOUD CO., Nurserymen

Tarrytown, N. Y.

PENNSYLVANIA

Philadelphia Farm Agency

WE represent 800 owners of farms near Philadelphia; where farms are cheaper and markets are better than near any large city in this country. I can sell a good 50-acre farm for \$2,500 to \$4,000. Write and tell us your requirements; we have the properties.

E. H. TRENCHARD, Farm Specialist
1230 Arch Street, Philadelphia, Pa.

OHIO

Farms and Timberlands

No. 4.—200 acres near Akron, Ohio. 25 acres of virgin hardwood timber. Soil gravelly loam. Large country house, hardwood finished; four other buildings, all in excellent condition, and two barns. Price \$55.00 per acre.

No. 16.—50 acres of good timber, white and red oak (first growth). Two miles from station. *Terms reasonable. Send for full list.*

F. A. Leeser, Akron, Ohio

OKLAHOMA

**Farm Lands, Coal Lands
Oil Lands**

and City Property. BRICK BLOCK in growing young town, pays 15 per cent. on its price, \$12,000

Splendid Country Seat

70 acres, adjoins town of 1,000 inhabitants, improvements cost \$10,000. All new \$15,000. Write for wants.

W. T. MILLER REALTY CO.

Box 256

PORUM, OKLA.

SEWAGE DISPOSAL

For Country Estates, Summer Homes, etc., etc.

HAVING NO SEWERS

The whole work done in your own dooryard. No chemicals required. No working parts. No odor nor offense. Little attention, and no cost to operate.

**THE
ASHLEY SYSTEM**

Employs the Natural forces of decay, and Nature's way in anything cannot be improved upon.

We estimate plants for residences.

FREE OF COST—Send for our handsome free booklet of particulars

**ASHLEY SEWAGE DIS-
POSAL SYSTEM**

6519 Normal Blvd. CHICAGO

**6⁰/₀
Timber Bonds**

Secured by first mortgage on over 4,000 acres of timber land with 241,000,000 feet of merchantable timber, situated within easy reach of a large city. Bonds mature in ten semi-annual installments of \$15,000 each, beginning March 10, 1909. Company's assets over five times the amount of the bond issue. Ample Sinking Fund, *payable monthly at our office*, to meet the issue three times over. Bonds personally guaranteed by principal stockholders.

Ask for Circular No. 646S.

**Peabody,
Houghteling & Co.**

181 La Salle Street
(Established 1865)

CAMERAS

AT THE SUMMIT

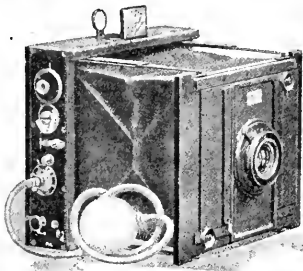

Recently Miss Annie Peck, the mountain climber, reached the top of Mt. Huascaran in Peru, an altitude of 26,000 feet. This accomplishment won for her the world's record in mountain climbing.

Of special interest is the fact that she carried with her a

GOERZ ANSCHUTZ CAMERA

This is a specific instance among many which come to us of the recognition of the merits of this camera for the most exacting kind of outdoor work. THE GOERZ ANSCHUTZ is a small, light weight, strongly built, folding camera, specially designed for travelers, naturalists, newspaper men, sportsmen — for all outdoor use where great speed, accuracy and compactness are essential: equally well adapted for general photographic work, lantern slide and enlargement making.

Let us tell you about the unique features found in this camera.

Address Dept. 3 for free descriptive catalogue, which also lists our photographic lenses, XL shutter, field glasses, gunsight, tele-photo attachments, etc.

We prefer to supply you through your dealer, but when he either cannot or will not, communicate with us.

**C. P. Goerz American
Optical Company**

52 Union Square E., New York
Heyworth Bldg.
Chicago

*Conservation's advertisers are dependable
—we see to that.*

Second Edition, Revised, with Additions

Snow—The Principal Species of Wood. Their Characteristic Properties

By CHARLES H. SNOW
*Dean of the School of Applied
Science, New York University*

Large 8vo, xi+203 pages, figures in
the text, 37 full-page half-tones.
Cloth, \$3.50

Circular giving complete table of contents
and sample pages mailed on request, or
the book may be seen at the leading book
stores or dealers in architectural supplies

*Order through your bookseller, or copies will be for-
warded postpaid by the publishers on receipt of the
retail price.*

JOHN WILEY & SONS
43 and 45 East 19th St., New York City

This Solar can be used in hazy weather,
when other Solars are useless. Used by
the U. S. General Land Office.

Specifications



Needle $3\frac{1}{2}$ inches
long. Graduations $4\frac{1}{4}$
inches long, reading
minutes. Power of
telescope 20 (with
splendid definition, good
light, and large field).
Variation plate. Level
to telescope, clamp
and opposing screws.
Vertical arc. Fixed
stadia hairs. Extension
Tripod. Solar At-
tachment on side of
standards.

Price Complete, \$300

Telegraph and Code Word, Mountsolar

Illustrated Catalogue Upon Application

YOUNG & SONS Philadelphia

IMPORTANT BOOKS ON FORESTRY

PRINCIPLES AND PRACTICE OF FORESTRY

FOREST MENSURATION. By HENRY SOLON GRAVES, M.A. A complete text book of this important subject and the first written for American Foresters. It deals with the determination of the volume of log, tree, or stand, and with the study of increments and yields. *Price, \$4.00*

ECONOMICS OF FORESTRY, THE. By B. E. FERNOW. This volume treats of forests and forestry from the standpoint of political economy, and is designed to furnish a trustworthy basis for formulating public policy. *Price, \$1.50*

FIRST BOOK OF FORESTRY, A. By FILIBERT ROTH. An outline of the general principles of forestry, written in simple, non-technical language, designed particularly for the beginner. *Price, \$1.10*

PRACTICAL FORESTRY, FOR BEGINNERS IN FORESTRY, AGRICULTURAL STUDENTS, AND WOODLAND OWNERS. By JOHN GIFFORD. A good general description of the principles of forestry with enough technical information to prepare the beginner. *Price, \$1.40*

HISTORY OF THE LUMBER INDUSTRY OF AMERICA. By J. E. DEFEBAUGH. The first authoritative work of its kind yet issued, and one which will commend itself alike to the timber owner, lumberman, lumber manufacturer, or merchant, or student of economics. In four volumes bound in half leather. *\$5.00 per volume*

FOREST PLANTING. By H. NICHOLAS JARCHOW. An illustrated treatise on methods and means of restoring denuded woodland. *Price, \$1.50*

FORESTRY. (Schwappach.) An English translation of "Forstwissenschaft." *Price, 70c*

HEDGES, WINDBREAKS, SHELTERS, AND LIVE FENCES. By E. P. POWELL. A treatise on the planting, growth and management of hedges with information concerning windbreaks and shelters. *Price, 70c*

NORTH AMERICAN FORESTS AND FORESTRY. By ERNEST BRUNCKEN. This volume, expository in its character, is written in a style intended for the general reader, to whom it should convey a good idea of our forests forestry. *Price, \$2.00*

PRACTICAL FORESTRY. By ANDREW S. FULLER. A treatise on the propagation, planting and cultivation, with descriptions and the botanical and popular names of all the indigenous trees of the United States, and notes on a large number of the most valuable exotic species. *Price, \$1.50*

PRINCIPLES OF AMERICAN FORESTRY. By SAMUEL B. GREEN. Prepared especially for students in elementary forestry and for the general reader who wishes to secure a general idea of forestry in North America. *Price, \$1.50*

SEASIDE PLANTING OF TREES AND SHRUBS. By ALFRED GAUT. Illustrated from photographs by FRANK SUTCLIFFE. This is a new volume in the English Country Life Library. Advice regarding selection and management to get satisfactory effects under adverse influence of closeness to seashore. *Price, \$1.75*

FOREST MANAGEMENT. By C. A. SCHENCK. Describes methods here and abroad to bring the most profit from all investments made in woodlands. *Price, \$1.25*

FOREST MENSURATION. By C. A. SCHENCK. Treats conditions in U. S. from mathematical and practical standpoint. *Price, \$1.25*

FOREST UTILIZATION. By C. A. SCHENCK. First treatise on this in U. S. Covers logging, lumbering, sawmilling, cooperage, paper-making, and description of all industries obtaining raw material from American forests. *Price, \$1.25*

BILTMORE LECTURES ON SYLVICULTURE. By C. A. SCHENCK. Written from author's long experience as forester of the Biltmore estate, where sylviculture has been practiced on a larger scale for a longer time than anywhere else in U. S., and where results become more apparent from year to year. *Price, \$2.50*

FOREST POLICY. By C. A. SCHENCK. (Second part.) Describes the various States of the Union under following heads: Area; physiography; distribution of forests; forest ownership; use of the forest; forestry movement; forest laws; forest reservation; irrigation. *Price, \$1.25*

PROFESSION OF FORESTRY, THE. By GIFFORD PINCHOT. A pamphlet containing an address on that subject by Mr. Gifford Pinchot; also an address by Mr. Overton W. Price, on "Study in Europe for American Forest Students," and a list of reference publications for students. *Price, 25c*

FOREIGN IMPORTATIONS

ENGLISH ESTATE FORESTRY. By A. C. FORBES. An authoritative volume on English forest methods from the pen of a well known forester, that should prove of interest to Americans. *Price, \$3.50*

FORSTWISSENSCHAFT. (Schwappach.) *Price, 60c*

MANUAL OF FORESTRY. (Schlich.) Five volumes, complete, or separately, as follows (*price, complete, \$18.80*):

Vol. I. "FORESTRY POLICY IN THE BRITISH EMPIRE." *Price, \$2.40*

Vol. II. "SYLVICULTURE." *Price, \$3.20*

Vol. III. "FOREST MANAGEMENT." *Price, \$3.60*

Vol. IV. "FOREST PROTECTION." *Price, \$4.80*

Vol. V. "FOREST UTILIZATION." *Price, \$4.80*

This is perhaps the most authoritative work that has been issued on the technical side of forestry, translated from the German.

WOOD. By G. S. BOULGER. An important new book for arboriculturists and forestry students. A manual of the natural history and industrial applications of the timbers of commerce. Cloth. 82 Illustrations. *Price, \$4.20*

FAMILIAR TREES. By Prof. G. S. BOULGER. Written by an eminent botanical authority, yet couched in language easily understood. The coloured plates are the work of celebrated artists, and are truthful and trustworthy in every respect. A special feature is the series of photo-micrographic illustrations of sections of woods. Three volumes. *Price, per volume, \$1.50*

DENDROLOGY, BOTANY, AND IDENTIFICATION OF SPECIES

MANUAL OF THE TREES OF NORTH AMERICA (exclusive of Mexico). By CHARLES SPRAGUE SARGENT. A volume that presents in convenient form and with excellent illustrations, authoritative information concerning the trees of North America. It is written in a manner that enables the reader to readily find to what family or species any particular tree belongs. *Price, \$6.00*

AMERICAN WOODS. By ROMEYN B. HOUGH. A new departure in the publication of an authoritative work illustrated with actual wood sections of the various species described. Three are given of each, viz.: radial, transverse, and tangential. Issued in ten parts, per part *Price, \$5.00*

HANDBOOK OF THE TREES OF THE NORTHERN U. S. AND CANADA, EAST OF THE ROCKY MOUNTAINS. By ROMEYN B. HOUGH. Pictorial description, one to two pages to each species; photo-engravings of trunk, leaves, flowers or fruit, section of wood, and map of distribution, with botanical description, and brief other information. *Price, in buckram, \$8.00; in half morocco, \$10.00*

FLORA OF THE SOUTHERN STATES. CHAPMAN. This is an excellent key to the flora of the South, complete and accurate in its scope. *Price, \$4.00*

GETTING ACQUAINTED WITH THE TREES. By J. HORACE McFARLAND. A handsome volume, copiously illustrated, and with facts accurately presented in an entertaining way. *Price, \$1.75*

HOW PLANTS GROW. By ASA GRAY. An understanding of the way in which a tree grows is of prime importance to the forester, and the matter here presented is accurate and authoritative. *Price, \$1.00*

PRINCIPAL SPECIES OF WOOD; THEIR CHARACTERISTIC PROPERTIES. By CHARLES HENRY SNOW. No attempt is made to give exhaustive descriptions of species, but the author presents a mass of information designed for the use and instruction of woodworkers, etc., in a popular style. A host of concise information is brought under each head, and the work is a valuable one. *Price, \$3.50*

*Important Books on Forestry and Irrigation for sale by CONSERVATION
1417 G Street N. W., Washington, D. C.*

MANUAL OF BOTANY. By ASA GRAY. A key to the flora of the northeastern states, and the most authoritative publication of its nature.

Price, \$1.62; field edition, \$2.00

TREES OF NEW ENGLAND. By L. L. DAME and HENRY BROOKS. This book is a small volume which can be easily put in the pocket and carried in the woods, and at the same time is the best guide to the identification of our New England trees of any of the smaller books yet published.

Price, \$1.50

TREES AND SHRUBS. By C. S. SARGENT. The most thorough and authoritative publication yet issued, and a standard work. The matter is issued in parts, of which there are three already published.

Price, per part, \$5.00

TREES, SHRUBS, AND VINES OF THE NORTHEASTERN UNITED STATES. By H. E. PARKHURST. In this book the author describes the trees, shrubs, and vines of the northeastern United States in a popular way, the book being designed especially for persons who have never studied botany. To these it will appeal as a valuable guide to a familiarity with the salient characteristics of trees, shrubs, and vines.

Price, \$1.50

TREES. A handbook of forest botany for the woodlands and the laboratory. By H. MARSHALL WARD. Vol. I. Buds and twigs. Vol. II. Leaves. Vol. III. Flowers and inflorescences. Three volumes to be added, on Fruits and seeds, Seedlings, Habit and conformation of the tree as a whole.

Price, per volume, \$1.50

PARTICULAR SPECIES AND LOCALITIES

MOUNTAINS OF CALIFORNIA, THE. By JOHN MUIR. No other person is so well fitted to write of the mountains of California as John Muir, and the volume presented here describes not only the mountains themselves, but the trees that clothe them and the wild life which they harbor.

Price, \$1.85

BOOKS ON IRRIGATION AND DRAINAGE

IRRIGATION IN THE UNITED STATES. By F. H. NEWELL. The most authoritative and complete work on the subject which has yet been published, by the head of the Government's irrigation work.

Price, \$2.00

IRRIGATION FARMING. By L. M. WILCOX. A newly revised edition of one of the standard works on irrigation. The principal chapters treat very fully of irrigation, its application, etc., and the volume is profusely illustrated.

Cloth, \$2.00

IRRIGATION FOR FARM, GARDEN AND ORCHARD. By HENRY STEWART. This work is offered to those American farmers and other cultivators of the soil who, from painful experience, can readily appreciate the losses which result from the scarcity of water at critical periods.

Price, \$1.00

IRRIGATION AND DRAINAGE. By F. H. KING. While most of the existing books on these subjects have been written from engineering or legal standpoints, this one presents in a broad, yet specific way the fundamental principles which underlie the methods of culture by irrigation and drainage.

Price, \$1.50

IRRIGATION INSTITUTIONS. By ELWOOD MEAD. A discussion of the economic and legal questions created by the growth of irrigated agriculture in the West, by the Chief of Irrigation and Drainage Investigations of the Department of Agriculture.

Price, \$1.25

LAND DRAINAGE. By MANLY MILES. A handbook for farmers on the principles and practise of draining, giving the results of his extended experience in laying tile drains.

Price, \$1.00

LAND OF LITTLE RAIN, THE. By MRS. MARY AUSTIN. A nature book of the highest type. The volume is made up of a series of sketches of the human, animal, and plant life found in the region of the Mohave desert, Death Valley, and the Sierras, much of which the average person is likely to consider almost devoid of living things.

Price, \$2.00

OUR NATIONAL PARKS. By JOHN MUIR. If you want to learn about the glaciers, mountain peaks, canyons, and great waterfalls of the West; of the habits of animals from the squirrel to the moose; plant life from the big trees to the wild flowers—in fact be brought face to face with nature's works, this is the book.

Price, \$1.85

TREES AND SHRUBS OF MASSACHUSETTS. EMERSON. Two volumes. Plain cloth edition has 148 plates. The colored edition has 36 of these in colors.

Price, plain, \$12.00

Price, colored, \$18.00

THE EARTH AS MODIFIED BY HUMAN ACTION. By G. P. MARSH. A Revision of Man and Nature. Describes changes in the face of the earth caused by man, including desolation of various countries, once thickly inhabited, by removal of forests. Shows importance of maintaining natural balance of forces.

Price, \$3.50

THE LONGLEAF PINE IN VIRGIN FOREST. A Silical Study. By G. FREDERICK SCHWARZ. This is a study of the life history of this important forest tree. Intended primarily for foresters and forest students; also for owners and managers of pine timber lands. Deals with the preference or dislike of the species for particular conditions of soil, climate, and environment. Illustrations and six tables.

Price, \$1.25

THE SPROUT FORESTS OF THE HOUSATONIC VALLEY TO CONNECTICUT. By G. F. SCHWARZ. Illustrated study of forests repeatedly cut over.

Price, 35c

IMPORTATIONS

BEAUTIFUL RARE TREES AND PLANTS. By the EARL OF ANNESLEY. A description of some of the rarer English trees, shrubs, and vines, illustrated copiously.

Price, \$12.00

FORESTS OF UPPER INDIA AND THEIR INHABITANTS. By THOMAS W. WEBBER. This volume is an account of the author's life in India during the period shortly after 1857. It contains a vivid description of the country, its people, customs, etc., with some description of its forests and timber wealth.

Price, \$5.00

IRRIGATION ENGINEERING AND CONSTRUCTIVE WORK

DESIGN AND CONSTRUCTION OF DAMS. By EDWARD WEGMANN. This volume includes an authoritative discussion of the constructive work involved and the principal forms of construction. Masonry, rock-fill, and timber dams are discussed extensively.

Price, \$6.00

IMPROVEMENT OF RIVERS. By B. F. THOMAS and D. A. WATT. This volume is a treatise on the methods employed for improving streams for open navigation and for navigation by means of locks and dams.

Price, \$6.50

IRRIGATION ENGINEERING. By HERBERT M. WILSON. This is the fourth edition of Mr. Wilson's popular work, and the revision and enlargement which it has undergone, places it at the forefront of text books on the subject for American students.

Price, \$4.00

ENGINEERING FOR LAND DRAINAGE. By C. G. ELIOTT. A manual for laying out and constructing drains for the improvement of agricultural lands.

Price, \$1.50

RESERVOIRS FOR IRRIGATION, WATERPOWER, AND DOMESTIC WATER-SUPPLY. By JAMES DIX SCHUYLER. An account of various types of dams and the methods and plans of their construction, together with a discussion of the available water-supply for irrigation in various sections of arid America, distribution, application, and use of water; the rainfall, runoff, and evaporation from reservoirs, and effect of silt, etc.

Price, \$5.00

WATER SUPPLY ENGINEERING. By A. PRESCOTT FOLWELL. A treatise on the designing, construction and maintenance of water-supply systems, both city and irrigation.

Price, \$4.00

These books sent prepaid upon receipt of price indicated, by CONSERVATION

WATER POWER. By JOSEPH P. FRIZELL. An outline of the development and application of the energy of flowing water. *Price, \$5.00*

CONCRETE, PLAIN AND REINFORCED. By FREDERICK W. TAYLOR and SANFORD E. THOMPSON. Designed for practicing engineers and contractors; text and reference book for students. Discusses materials, processes, and applications of concrete in construction and specifications. *Price, \$5.00*

HYDRAULICS. By MANSFIELD MERRIMAN. Purpose of book is to keep abreast of modern progress, and present subject with conciseness and clearness. Gives general principles and discusses flow of water through various kinds of openings and channels. Historical notes and references. *Price, \$5.00*

FOUNDATIONS. By W. M. PATTON. A practical treatise explaining fully the principles involved. Numerous descriptions of important modern structures are given in sufficient detail. Includes articles on use of concrete in foundations. *Price, \$5.00*

MASONRY CONSTRUCTION. By IRA O. BAKER. Contains results of a great number of experiments, and a large amount of practical data on cost of masonry, pile driving, foundations, culverts, etc., and 97 tables to facilitate estimating. *Price, \$5.00*

REINFORCED CONCRETE. By ALBERT W. BUEL and CHARLES S. HILL. A treatise for designing and constructing engineers, governed by American practice and conditions. Theoretical discussions omitted, and replaced by practical working formulas, examples of representative structures, and records of practice. *Price, \$5.00*

BOOKS ON RELATED SUBJECTS

UTILIZATION OF WOOD WASTE BY DISTILLATION. By WALTER B. HARPER. An important treatise on a subject regarding which the interest is great and the information scarce. Is intended to aid in the establishment and conduct of wood distilling enterprises on a business basis. *Price, \$3.00*

HANDBOOK OF TIMBER PRESERVATION. By SAMUEL M. ROWE. Intended as a complete practical guide for the operator of a preservation plant, with hints on construction thereof. *Price, \$4.00*

IN FOREST LAND. By DOUGLAS MALLOCH. The humor, sentiment, and philosophy of the lumber business interpreted by the "Lumberman Poet." A kind of touch with the great outdoors that few books contain. Illustrated in tint, bound in silk cloth and gold stamped. Ideal for gift or library. *Price, \$1.25*

THE GARDEN

ROSES AND HOW TO GROW THEM. By many Experts. In text, practical; in subject and quality of illustrations, beautiful. *Price, \$1.20*

FERNS AND HOW TO GROW THEM. By G. A. WOOLSON. The growing of hardy ferns, both in the garden and indoors. *Price, \$1.20*

LAWNS AND HOW TO MAKE THEM. By LEONARD BARON. For the first time the subject of lawn seed mixtures is set forth and explained. 32 photographs. *Price, \$1.20*

HOW TO MAKE SCHOOL GARDENS. By H. D. HEMENWAY. This suggestive little book is a practical manual of school gardening for both teacher and pupil, and supplies the first adequate work of the sort in this country. There are to-day a hundred thousand school gardens in Europe, and the progress of the recent movement in America has been most rapid. This volume is based on actual experience (the author is an authority and director of the Hartford School of Horticulture). Illustrations, 10. *Price, \$1.10*

HOW TO MAKE A FRUIT GARDEN. By S. W. FLETCHER. An eminently practical work on the subject of fruits for the home. With 182 photographic illustrations by the author. *Price, \$2.25*

HOW TO MAKE A FLOWER GARDEN. A charming and a practical book by experts on every branch of the subject. More than 200 beautiful photographs. *Price, \$1.75*

HOW TO MAKE A VEGETABLE GARDEN. By EDITH L. FULLERTON. The only adequate book on the home vegetable garden. 250 photographs by H. B. Fullerton. *Price, \$2.20*

ART AND CRAFT OF GARDEN MAKING. By THOMAS H. MAWSON. Third edition of this standard; out of print for a year, and now reissued in revised form. Over 100 plans and details of gardens. Methods employed by successful designers carefully analyzed. Characteristic sites in typical districts described and pictured. *Price, \$15.00*

THE HOME AND FARM

THE COUNTRY HOUSE. By CHARLES EDW. HOOPER. A Practical manual of house building, absolutely invaluable to every one with a country place. It covers every branch of the subject in detail and treats of the garden and its furnishings in connection with the dwelling. 380 photographs and plans. *Price, \$5.50*

THREE ACRES AND LIBERTY. By BOLTON HALL. Description of what can be accomplished on a small place in the way of gardening, home-making, and addition to financial resources. Were it not for the unimpeachable authorities quoted, its statements as to the possibilities of the "Little Lands" for a living would seem fanciful. *Price, \$1.85*

THE MAKING OF A COUNTRY HOME. By J. P. MOWBRAY ("J. P. M."). This delightful story showed its universal appeal when published serially, and the volume amply carries out the intention of the author. Besides its practical interest for the thousands of city dwellers who have dreamed of having a country home, the story is one of such reality, humor, and interest as to ensure it the widest circulation in book form. Elaborately decorated. *\$1.65*

THE FIRST BOOK OF FARMING. By CHARLES L. GOODRICH. No one interested in farming, old or young, can fail to appreciate this book, for it really gives the fundamental knowledge of how to conduct a farm with the least expense and the largest return. There are 63 full pages of helpful illustrations. The price is extremely low for a work of such value. 63 pages of photographs. *Price, \$1.10*

NATURE BOOKS

AMERICAN FOOD AND GAME FISHES. By DAVID STARR JORDAN and B. W. EVERMANN. Fills a long-felt need in popular scientific works, being a full account of the life-histories and methods of capture of North American food and game fishes. The only book in existence which will enable the amateur readily to identify species new to him. With 10 lithographed color plates, 100 photographs of live fish in the water, and 200 text cuts. *Price, \$4.40*

NATURE BIOGRAPHIES. By CLARENCE M. WEED. This volume is a sort of personal acquaintance with the lives of the more common butterflies, moths, grasshoppers, flies, and so on, the sort of fascinating details of these insect existences which make the reader want to go out and study these every-day marvels for himself. 150 photographic illustrations. *Price, \$1.50*

THE BROOK BOOK. By MARY ROGERS MILLER. A book is one of the most living and companionable features of the landscape, and few people, even the most ardent nature lovers, realize what an endlessly interesting study its changes and its throbbing life afford. It is a fascinating subject which the author (well known as a teacher, lecturer, and writer connected with the Nature Study Bureau at Cornell) handles with much ability. 16 photographs. *Price, \$1.50*

OUTDOORS. A Book of the Woods, Fields, and Marshlands. By ERNEST MCGAFFEY. Papers on out of doors, showing a love of nature and keenness of observation and power and beauty of description rarely surpassed. *Price, \$1.25*

NATURE AND THE CAMERA. By A. RADCLIFFE DUGMORE. Mr. Dugmore is an expert in the new movement of photographing live birds, animals, fish, flowers, etc. His works brought him so many requests for information, that he has set down here a full and detailed account of his methods. From the choice of a camera to questions of lighting, and to the problem of "snapping" shy birds and animals in their native haunts, every step is explained so simply as to be easily comprehended, even by the beginner. 53 photographic illustrations. *Price, \$1.50*

To Members of the American Forestry Association

We need your help. The Association of which you are members needs your help. The cause of conservation of natural resources needs your help.

Nominations for Membership

Now is the time to nominate. Use the blank below, adding to it when necessary, and send in your lists. Little remains of 1908; help to make a fine showing, in new members, for the year.

Do It Now—Lest You Forget!

Nominations for Membership

The activities of the National Office of the American Forestry Association are limited chiefly by its resources. These are derived almost wholly from its members in the form of dues. Every member is urged to aid in increasing the membership. Kindly fill out the enclosed blank form, lengthening the list, where possible, by attaching and filling blank sheet. The list should then be sent to

THOMAS E. WILL
Secretary American Forestry Association
1417 G Street Northwest, Washington, D. C.

I hereby nominate the following persons for membership in The American Forestry Association:

Name

Address

.....

.....

Signed.....

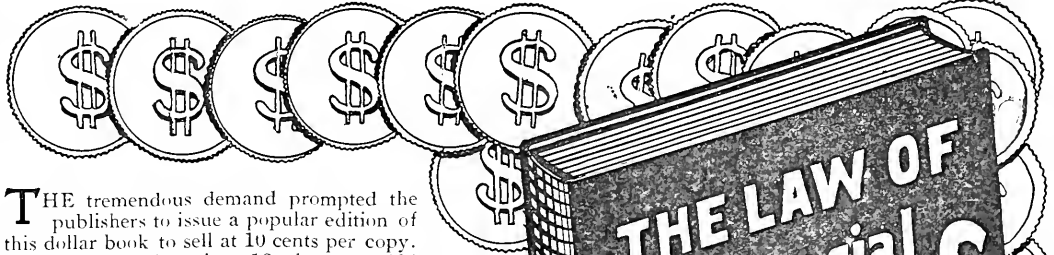

THE tremendous demand prompted the publishers to issue a popular edition of this dollar book to sell at 10 cents per copy. Convenient pocket size, 16 chapters, 104 pages, paper bound. It is practically a text book and should be the seed to a fortune to the man or woman with brains and earnestness of purpose, desirous of accumulating money. More individuals owe their financial success to the laws contained in this book, than to any other known source.

MONEY IS The BEST PARTNER

a man can have and the best friend a woman can have. It will work for you through health and sickness and stand by you through thick and thin. If you are unable to accumulate money, if your spare money or savings are idle, if you cannot make your money earn more than savings bank interest, if you desire to be able to distinguish between good and bad investments and secure the best profits, if you have any cherished plans or objects for which you need money, or if you want to better your financial condition generally, you should get this book immediately and learn the laws governing success in the accumulation of money. The book is plainly written, easily understood and among other subjects deals with:

- How to place your mind in condition for proper judgment on matters pertaining to investments.
- How to avoid fear and worry, and acquire the faith necessary for success in money-making.
- How to guide your ambition and utilize your latent abilities.
- How to create and realize the desire for better financial circumstances.
- How to concentrate upon your aim and persist until you achieve it.
- How to help you analyze and develop the dormant or lacking attribute essential to success.
- How to exercise your will power in claiming your own share of the world's wealth.
- How to make money safely and judiciously, etc.

70,000 copies already sold; new orders for this book will be filled in rotation at

TEN CENTS

per copy until the edition is exhausted. Regular edition bound in limp leather silk lined, \$1.00 per copy. You cannot afford to be without this book, as it places within your own hands the means of starting you on the road to a broader career and financial independence.

Mailed postpaid on receipt of 10 cents for paper bound copy or \$1.00 for leather bound copy, stamps or money.

NOTE—If you prefer, the book will be sent on 3 days' approval. You can remit the 10 cents or return the book at your own discretion. The Publishers know the sterling value of the book and have faith in the judgment and honesty of the average American, sufficiently ambitious and intelligent to be interested in a book of this character.

JUST FILL OUT AND MAIL THIS COUPON

THE FIDUCIARY COMPANY, 435 Tacoma Bldg., Chicago, Ill.

Enclosed herewith find 10 cents for paper bound copy } of your book "The Law of Financial Success."
(or) \$1.00 for leather bound copy } Mail the same to

Name

Address

**{ SEND YOUR
ORDER NOW }**

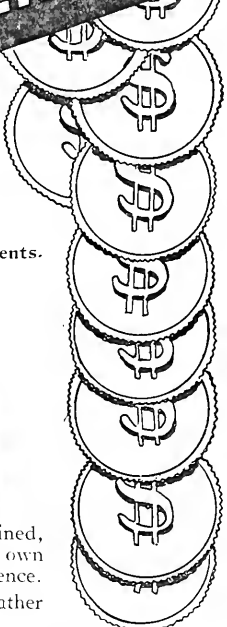
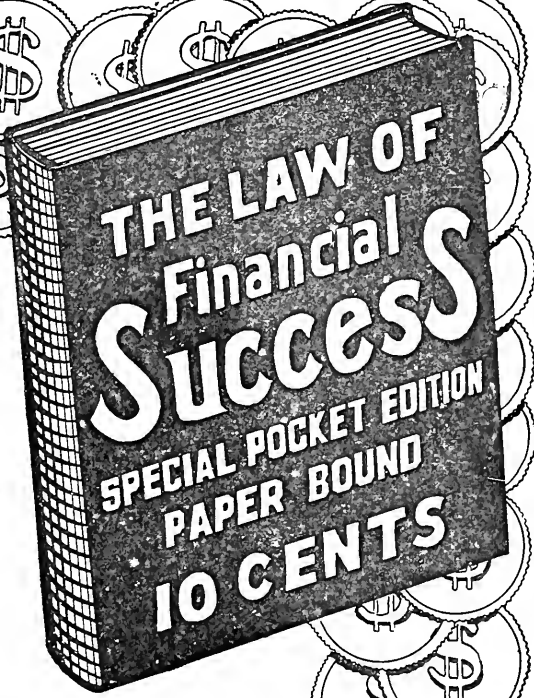

JAMES D. LACEY

WOOD BEAL

VICTOR THRANE

ARE YOU

Interested in Southern or Pacific Coast Timber?

We furnish detailed reports as to the QUALITY of the timber, giving average TOP and BUTT diameters, average lengths and number of trees on each 40-acre subdivision.

We submit reports covering details as to logging conditions, cost and most feasible methods of logging each 40-acre or sectional subdivision of each tract.

We also furnish a TOPOGRAPHICAL map of all tracts located in mountainous districts, showing every elevation of 100 feet throughout the tract with OUR OWN engineer's report showing locations of most feasible routes and grades for logging roads.

We can furnish sufficient data regarding ANY tract of timber which we have examined to convince you whether the tract is what you want or not. Personal inspection of any tract we may offer you will be found just as represented.

We are in a position to offer some exceedingly attractive TIMBER properties in the SOUTH, in BRITISH COLUMBIA, and on the PACIFIC COAST. Also a few going mill operation with ample timber supplies in South Carolina and Mississippi.

We furnish detailed reports of amount of STUMPAGE on each 2 1-2, 5 or 10 acre subdivision of each forty.

We employ expert PACIFIC COAST CRUISERS to check all estimates made on Western Timber.

We offer HIGH CLASS Timber Properties only, which have been placed in our hands for sale.

We guarantee our estimates are reliable.

JAMES D. LACEY & CO.

(ESTABLISHED SINCE 1880)

608 Hennen Building

New Orleans

828 Chamber of Commerce

Portland, Ore.

507 Lumber Exchange

Seattle

1215 Old Colony

Chicago

CONSERVATION



**WOODS AND WATERS
SOILS AND ORES**



A FLOODED MISSISSIPPI FOREST

SAVE YOUR TREES

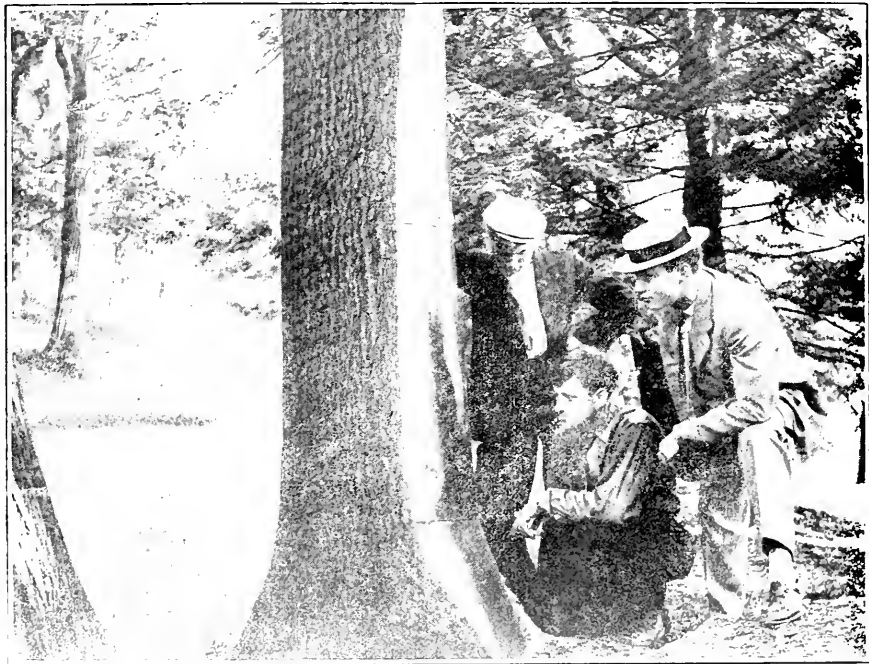

NATURE'S OPPORTUNITY

Health is the normal condition of the tree, just as it is of the human body. Disease and decay are the result of a perversion of the natural order. A cavity in a tree is indisputable evidence of neglect or abuse—it is a danger signal which, if unheeded, proclaims the inevitable death of the tree.

Examine the tree shown in the picture above. Before it was placed in the hands of the tree surgeon, it appeared perfectly healthy and sound on every side except one. But there a condition was revealed which startled its owner. Decay—insidious decay—was eating away the interior, robbing the tree of its physical strength. Not only was the process of decay faster than the process of healing, but there was no surface over which the bark could heal.

The tree was placed in our hands for treatment. The decayed wood was completely removed. The cavity was prepared and filled in accordance with our perfected methods. The contour of the tree is preserved, as clearly indicated in the photograph above. Over this new surface the bark will completely heal. The life forces are now unhampered, and another century has been added to the life of a noble tree. *This is Nature's opportunity.*

The owner of this tree, Mr. Gustav H. Schwab, expresses himself as follows:

Oelrichs & Co., New York.
Telegraphic Address, "Oelrichs"

New York, July 3, 1908.

Mr. Martin L. Davey,
The Davey School of Practical Forestry,
Tarrytown, Westchester County, N. Y.

Dear Sir: I am very much pleased with the work on my trees at Scarborough. It has been most intelligently and effectively done. I confess that before you undertook the work on my place I had no conception of the attention and care that trees require.

I desire also to express to you my appreciation of the very efficient workmanship and the courtesy and excellent behavior of your representatives who carried out the work.

I am, with kind regards,

Yours very truly,
GUSTAV H. SCHWAB.

DAVEY'S

SCHOOL OF PRACTICAL FORESTRY

Eastern Office, Tarrytown, N. Y.

Your house can be replaced, but your trees can not

"THE TREE DOCTOR"



by
John Davey
The Father of Tree Surgery

"The Tree Doctor" is recognized as the standard authority on the practical care of shade trees, orchards, lawns, shrubs, flowers, and vineyards.

Tree structure, tree surgery in all its phases, proper and improper root conditions, the growing of fruits, the care of trees in public places, remedies of insect pests and tree diseases, the cultivation of flowers, various types of landscaping, the relation between trees, birds,—these and kindred subjects are treated exhaustively, and the various points brought out in the text are clearly illustrated by an abundance of photographs, specially selected for this work from thousands taken by the author during his many years of experience in the care and study of trees.

This book is not written by a mere theorist, but by the most successful tree specialist of his time—a man who has spent nearly half a century in the most intimate contact with the subjects of which he treats. It is indispensable to the man who loves his home and its surroundings. It is interesting, instructive, elevating.

NEW YORK TIMES SUPPLEMENT

Saturday, March 20, 1908.

"'The Tree Doctor' is a book written by an enthusiastic tree lover, and one who, moreover, has made it his business to study trees, their injuries, diseases, and methods of preservation. * * * The large number of photographs, 213, with which the book is embellished, comprise an object-lesson in themselves of the value and benefits of tree culture."

Price, \$2.00, Postpaid

Send for our booklet, "A Great Revelation." It's interesting, and will cost you nothing.

DAVEY'S School of Practical Forestry
Eastern Office, TARRYTOWN, N. Y.

SCHOOLS OF FORESTRY

Colorado School of Forestry

Colorado Springs, Colo.

Three years' course in Technical and
Applied Forestry

Winter Term at Colorado College,
Colorado Springs. Summer Term
at Manitou Park, on the borders of
the Pike's Peak National Forest.

Tuition Sixty Dollars a Year

For further particulars apply to
WM. C. STURGIS, Dean
Colorado Springs, Colo.

Biltmore Forest School

Biltmore N. C.

Theoretical and practical in-
struction in all branches of applied
forestry.

The course comprises eight-
teen months; twelve consecutive
months of lectures and field work,
and six months of practical ex-
perience.

Object lessons within the moun-
tain estate of George W. Vander-
bilt, comprising 120,000 acres,
where forestry has been practiced
since 1895.

For further information apply to
C. A. SCHENCK, Director

YALE FOREST SCHOOL

NEW HAVEN, CONNECTICUT

The course of study in the YALE FOREST
SCHOOL covers a period of two years. Graduates
of collegiate institutions of high standing are admitted
as candidates for the degree of Master of Forestry.

The Summer School of Forestry is conducted at
MILFORD, PIKE COUNTY, PENNA.

FOR FURTHER INFORMATION ADDRESS

HENRY S. GRAVES, Director

New Haven

Connecticut

The
**PENNSYLVANIA
 STATE COLLEGE**

A thorough and practical undergraduate course in technical forestry, preparing men for all lines of professional and applied forestry.

Special attention is paid to practical field work in surveying, mapping, and forest measurements. One of the largest of the State Forest Reserves is within a short walk of the college.

For information regarding entrance requirements, expenses, etc., address

Department of Forestry

State College, Penna.

POWDER POINT SCHOOL, Duxbury, Mass.

Preparatory Course in
FORESTRY

Leading to Biltmore and College Course in the subject. It requires hard, earnest application, and develops appreciation of nature and powers of leadership.
 (M. I. T.) F. B. KNAPP, S. B.

FORESTRY SCHOOLS

can find no better medium through which to make their announcements than

Conservation

It reaches a class of Readers that is reached by no other Publication.

It is *the* Magazine of authority in its special field.

For Advertising Rates, etc., address

Advertising Manager

CONSERVATION

1417 G St. N. W.

Room C

Washington, D. C.

To Readers of Conservation

WE ARE completely overhauling, correcting and revising the mailing list of this magazine. In the course of this work we have found several errors—a very natural condition when the rapid growth of our circulation is taken into consideration. In order to have the list absolutely accurate, we ask every reader, subscriber and member of the American Forestry Association to advise us if his or her magazine is properly addressed. Changes of address may have been overlooked; "stop" orders may have escaped us. If there is anything wrong, please let us know immediately. The prompt attention of all readers is urged. Address:

CONSERVATION

Circulation Department

Washington, D. C.

THE

American Forestry Association

Officers for 1908

President

HON. JAMES WILSON, Secretary of Agriculture

Vice-presidents-at-large

DR. EDWARD EVERETT HALE	GEO. T. OLIVER
N. J. BACHELDER	DR. B. E. FERNOW
GEO. FOSTER PEABODY	GEO. C. PARDEE
RUTHERFORD P. HAYES	ALBERT SHAW
W. W. FINLEY	J. T. ROTHROCK

CHARLES R. VAN HISE

Advisory Board Selected by Affiliated Organizations

H. H. WHELESS	GEORGE E. STONE	W. K. KNOX
JAMES INNES	ALLEN CHAMBERLAIN	A. L. HAYES
C. H. KEYS	D. E. KLINE	FREDERICK S. UNDERHILL
ROBERT C. LIPPINCOTT	E. F. SAWYER	ROBERT L. LIPPINCOTT
GEORGE F. CRAIG	F. E. WEYERHAEUSER	S. B. ANDERSON
C. A. SMITH	KENT SHEPPARD	ROBERT A. JOHNSON

Members of Board Designated as Vice-Presidents of Association

N. W. McLEOD	LEWIS DILL	J. T. WYLIE
WILLIAM IRVINE	EDWIN A. START	D. E. KLINE
GEORGE H. HAMPTON	SAMUEL B. VROOMAN	B. W. PORTER

Acting Secretary, OTTO LUEBKERT, Washington, D. C.

Assistant Secretary, FRANK GLOVER HEATON, Washington, D. C.

Treasurer, OTTO LUEBKERT, Washington, D. C.

Directors

JAMES WILSON	WILLIAM L. HALL	W. J. MCGEE
GEO. P. WHITTLESEY	GEORGE K. SMITH	PHILIP W. AYRES
JAMES H. CUTLER	WILLIAM S. HARVEY	ROBERT GARRETT
HENRY S. GRAVES	H. A. PRESSEY	LIGON JOHNSON
F. H. NEWELL	ASBURY F. LEVER	FILIBERT ROTH

Application for Membership

To OTTO LUEBKERT

Acting Secretary American Forestry Association

1417 G Street N. W., Washington, D. C.

Dear Sir: I hereby signify my desire to become a member of the American Forestry Association. Two Dollars (\$2.00) for annual dues are enclosed herewith.

Very truly yours,

Name _____

P. O. Address _____

The American Forestry Association

President—**HON. JAMES WILSON**

Secretary of Agriculture

The American Forestry Association was organized in 1882, and incorporated in January, 1897. It now has over 7,000 members, residents of every State in the Union, Canada, and foreign countries. From its origin it has been the tireless friend of the forests.

The object of the Association is to promote the preservation, by wise use, and the extension of the forests of the United States; its means are agitation and education; it seeks to encourage the application of forestry by private owners to forest holdings, large or small; and it favors, especially, the establishment and multiplication of National and State forests, to be administered in the highest interests of all.

The Association seeks as members all who sympathize with its object and methods, and who believe that our natural resources constitute a common heritage, to be used without abusing and administered for the common good. Seeking to conserve our supplies of wood and water, the Association appeals especially to wood-producers and users, including owners of wood lands, lumbermen, foresters, railroad men, and engineers; and to those dependent upon equable stream flow, as manufacturers, irrigators, employers of water power, and those engaged in internal commerce.

The Association meets annually in Washington. It publishes, monthly, *CONSERVATION*, the magazine of authority in its special field. The list of contributors to this publication includes practically all persons prominent in forest work in the United States, making it alone worth the cost of Annual Membership in the Association.

The dues, covering a subscription to *CONSERVATION*, are as follows: Annual—For Annual Members, \$2; for Sustaining Members, \$25; Total, with exemption from all other payments—for Life Members, \$100; for Patrons, \$1,000, and of the above amount, \$1 is set aside each year to pay the subscription of each member to *CONSERVATION*.

OTTO LUEBKERT, Acting Secretary,
The American Forestry Association.

THE CARE OF TREES

The San Jose Scale Infests nearly every orchard. Unchecked it means death to the trees. The Winter is the best time for caring for **APPLE TREES** Consult us now

HAVE US INSPECT YOUR TREES

AN EXPERT INSPECTION SERVES AS AN INSURANCE ON THEIR WELFARE, and is often the means of saving valuable specimens found to be in urgent need of attention. The cost is a trifle in comparison with the worth of the trees.

PRESERVE YOUR OLD TREES

DEAD WOOD CAVITIES, DISEASES, AND OTHER DEFECTS MUST BE ELIMINATED if the trees are to live and flourish. Old Trees will respond quickly to scientific treatment. There is seldom real need of cutting down old landmarks.

And remember that our methods of pruning, spraying, and fertilizing can revive your dying orchard and bring it back to the healthy condition, which means the bearing of excellent crops.

Our free booklet, "The Care of Trees," fully illustrates the character of our work and goes into details regarding our qualifications for giving service which is absolutely unparalleled. Testimonials from all parts of our wide territory: "Maine to Virginia—West to Iowa."

MUNSON-WHITAKER COMPANY

1101 FLATIRON BUILDING, NEW YORK
842 TREMONT BUILDING, BOSTON

We offer an extremely valuable course on SHADE TREES, by G. H. Allen, B. S. This will be sent postpaid for \$1. Tell exactly how to plant, grow and preserve your Shade Trees.

TREE SURGERY
An important tree on the estate of Mr. J. A. Jeffrey, Columbus, Ohio. The cement filling gives this tree the strength of its youth



NEW ENGLAND COUNTRY HOMES

Stock and dairy farms, Summer Houses at sea-shore, White Mountains and Berkshire Hills, from 25 to 1,500 acres of land, ranging in price from \$10,000 up to \$150,000. Will be pleased to give full description and terms.

George C. Davis

70 STATE STREET, BOSTON

High-grade Country Estates

TIMBER LANDS

FOR

INVESTMENT

I sold to a bank president an Adirondacks tract at fifty per cent. more than its owner had paid for it less than a year previous, and the banker was satisfied.



I always have timber properties of inviting character and at inviting prices, and solicit correspondence from investors or those who would buy for operation.

RALPH HERBERT WAGGONER

309 BROADWAY, NEW YORK

CONSERVATION

OFFICIAL MAGAZINE
OF THE
AMERICAN FORESTRY ASSOCIATION

LIBRARY
NEW YORK
BOTANICAL
GARDEN

FRANK GLOVER HEATON, *Editor*

CONTENTS FOR DECEMBER, 1908

THE TWENTY-EIGHTH ANNUAL MEETING.....	640
CONSERVATION WEEK.....	641
THE APPALACHIAN NATIONAL FOREST ASSOCIATION.....	643
THE ATLANTIC DEEPER WATERWAYS ASSOCIATION.....	645
THE MISSISSIPPI-TO-ATLANTIC WATERWAYS ASSOCIATION.....	647
ANNOUNCEMENT OF SECRETARY WILL'S RESIGNATION.....	648
WATER-POWER—By M. O. Leighton.....	649
THE RELATION OF THE U. S. GEOLOGICAL SURVEY TO THE PUBLIC By George Otis Smith.....	652
REPORT OF THE WATER SUPPLY COMMISSION OF PENNSYLVANIA.....	659
BEARING OF THE PROPOSED APPALACHIAN FOREST ON NAVIGATION By W J McGee.....	661
PRESERVE THE SOIL— <i>Poem</i> —By John A. Joyce.....	663
BOOKS ON FORESTRY.....	664
A BEGINNER IN FORESTRY— <i>Paper Three</i> —By Anne Warner.....	665
TREES IN THE PHILIPPINE ISLANDS.....	667
INCREASE IN 1907 LUMBER CUT.....	668
FOREST SCHOOL NOTES— <i>Illustrated</i> —	
Yale Forest School.....	672
Pennsylvania Forest School.....	674
Colorado School of Forestry.....	675
MOTHER— <i>Poem</i> —By Eleanor Van Al'en.....	678
ORIGIN OF THE RESERVOIR SYSTEM IN THE UNITED STATES— <i>Illustrated</i> — By Thad C. Pound.....	679
THE FOREST HOLOCAUST—A Symposium.....	687
NEWS AND NOTES—	
Forest Service Personnel in Six New Field Districts.....	691
Association Changes Name.....	694
American Mining Congress.....	694
Illinois Votes for Waterway.....	695
Forest Receipts in Western Depositories.....	695
Arboretum for Cornell University.....	696
Resolutions by Carriage Builders' Association.....	696
State Revenues from National Forest Increased.....	696

CONSERVATION is the official organ of the American Forestry Association. Price, \$2.00 per year, including Annual Membership in the Association. Entered as second-class matter August 1, 1908, at the Post Office at Washington, D. C., under the Act of March 3, 1879

Published Monthly at
1417 G STREET N. W. WASHINGTON, D. C.

THE TWENTY-EIGHTH ANNUAL MEETING

A NNOUNCEMENT was made in the November issue of CONSERVATION of the Anti-Forest Fire Congress to be held in Washington, D. C., January 13-14, 1909. This will be the twenty-eighth annual meeting of the American Forestry Association, and forms an important link in the series of meetings and conferences to be held in Washington during the coming winter. Announcement of a number of these meetings which are to be held in December appear elsewhere in this issue.

Following these important meetings, the Anti-Forest Fire Congress of the American Forestry Association will be notable in many respects. In the first place, it follows a season of disastrous loss from fires in all parts of the country. The congress will be participated in by representatives from all the states which are concerned with forest fires—the losses sustained through them, and their prevention. One of the most important sessions of the congress will be that devoted to the prevention and control of forest fires.

The session which will be devoted to forest reservations will be equally interesting. As the subject of conservation of natural resources has been presented and discussed all over the country, the public mind has turned strongly to the necessity for constant improvement of the National Forests of the West, and to the need for extending the National Forest System to the eastern mountains. Nine out of ten persons, in discussing the conservation movement, say that one of the first steps to be taken is the protection of the Appalachian Mountain Range, north and south.

The session on Forests and Waterways will also be of primary importance. Never before has there been so keen an interest among thinking people of all classes in the relation which exists between mountain and forests and waterways. Indeed, one of the foremost discussions of the year, in engineering papers, has been on this question.

The congress will also devote a session, or at least a part of a session, to the subject of Forest Education and Policy. The public is anxiously awaiting each advance of information on the means by which the resources of our country may be made to serve their highest use to the Nation. All of these subjects, and others which will doubtless be included, will make this meeting one of the most important to be held in Washington during this winter. Many popular organizations have already signified their intention to be represented, and many prominent men will be present and speak.

On account of the very important meetings coming early in December, it is thought best not to issue a program in advance of these meetings.

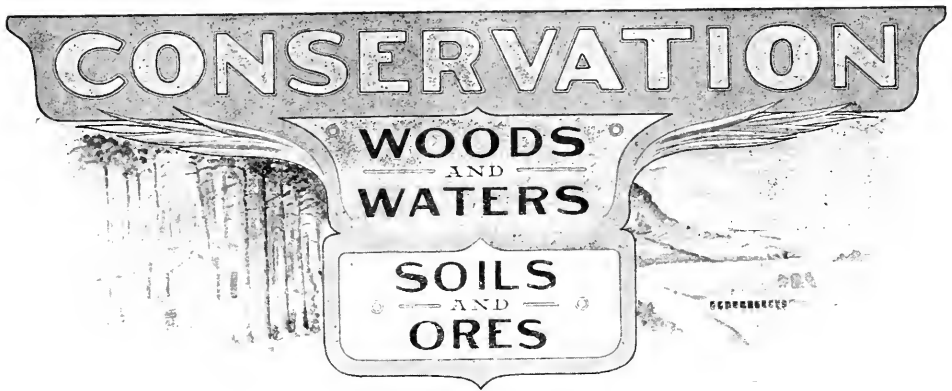

"CONSERVATION WEEK"

The Second Meeting of the Governors in Washington, to Receive the Report of the National Conservation Commission

DURING the period from December 1 to December 12, in Washington, occurs the second meeting of the Governors, pursuant to the action taken at the memorable White House Conference held last May. The first full meeting of the National Conservation Commission occurs on December 1, and at this meeting the reports of the four branches of the Commission—Water, Forests, Lands, and Minerals—will be received. During the time which has elapsed since the White House Conference, these four branches have been making an inventory—taking stock, as it were—of the natural resources of the country—their extent value, present condition, promise for future use and development, etc.—and the meetings which begin on December 1 will receive these reports. The reports will be put into shape by the Commission, sitting as a body, and the results of the six months' work will be ready to submit, in proper form, to the Governors, their advisors, and the representatives of the State Conservation Commissions and the commis-

sions selected by the various national associations, at the meetings which begin on December 7.

With less than six months in which to make the inventory, the four branches into which the Commission is divided, aided by the cooperation of the Government departments, have brought together what is probably the most useful collection of facts about the material things on which national industry and progress are based that has ever been assembled at one time.

Reports presenting these facts and pointing out their significance have been prepared. These reports, summarized and indexed, will be submitted to the Commission at its coming meeting.

All through the summer general interest in the work and object of the Conservation Commission has been growing. The public is now well posted on a subject of which only a few specialists had knowledge at the time of the Conference of Governors and experts at the White House, in May.

The Governors carried the spirit of the conference home with them to their own people, and have kept things moving ever since by appointing state commissions to study local problems, by writing and speaking upon the subject of conservation, and by keeping in close and helpful touch with the National Commission. They are ready to take part in the approaching joint meeting.

The bare announcement that it had been set for December 8 resulted in a number of acceptances before the formal invitation of the Commission had even got into the mails.

When the conservation movement was started, specific information about the actual state of our resources was partly wanting, partly inaccessible. Certain facts were broadly known. It was at least unquestionable that our resources had been wastefully used, and that some of them, notably the mines, were sure in time to be completely exhausted, while others—for example, the forests—could still be kept perpetually useful by right management. The first work was to get the facts, to show exactly what the situation was and how it could be improved by measures that would work. Without an inventory of the resources which should show the present condition of resources and the way to develop them to the best advantage, conservation was in danger of staying up in the air.

Plans for the second assembly of the Governors, together with the Governors' advisors and the other representatives making up the whole body, are practically completed. The sessions start with a mass meeting at the Belasco Theater at which President-elect Taft presides. The National Rivers and Harbors Congress and the Southern Commercial Congress, holding their sessions in Washington at the same time, take prominent parts in the program. The meetings during the week of December 1 are to be held in the Senate Reading Room of the Library of Congress, while the place of holding those of the Joint Conservation Conference had not, at the time this was written, been decided upon. These lat-

ter sessions will be at 10 a. m. and 2.30 p. m. daily, and it is believed the conference will continue at least three days.

The sessions of the National Conservation Commission, it is announced, will not be open to the general public. The work to be done at these meetings is that of receiving reports from the four divisions of the Commission, and, while it is realized that the discussion of these reports will be exceedingly full of interest, it is also realized that little could be accomplished in the way of putting these reports into shape for consideration at the later meeting, were the public made free of the sessions.

While, of course, not even the semblance of a forecast of the Commission's final report, or any outline of the inventory taken during the past summer, is or can be available until the conclusion of the meetings, it is safe to state that never in the history of the country has so valuable a contribution been made to science and to the general information of the country as is contained in the documents that will be submitted to the Joint Conservation Conference. The January number of CONSERVATION will contain the reports in full of the meetings of the Commission, and the later meetings of the Conference, and this number will, therefore, be of especial interest and value to all members of The American Forestry Association, as well as the members of other conservation organizations and friends of conservation in general.



THE APPALACHIAN NATIONAL FOREST ASSOCIATION

By J. H. Finney, Secretary

TWO matters of great importance to our work are making these "strenuous days" for us and are engaging our utmost activity.

The first of these is the work we are doing and planning in connection with the Southern Commercial Congress, which meets here in Washington, December 7 and 8, during what might be termed "Conservation Week," for following their meeting the Great National Rivers and Harbors Congress assembles for a three-day session on December 9, 10, and 11, while the Governors and their advisers meet again in conference, this time, with the National Conservation Commission on December 8 for a two or three day session.

The Southern Commercial Congress promises to mark a new mile-post in Southern affairs and thought. It is to be a gathering of the brains of the South in a program of presentation and interpretation of the South's resources in men and opportunity and material things—topics handled by men best qualified to discuss them intelligently and forcefully on the broadest lines,—not only that the South has these things, but what they should mean to the South, to the Nation, to the world at large.

It is a big conception, rightly planned, as to time and place, and our part in it will not be insignificant, for we are asked to present the Appalachian Forest Question at that time. What we are going to do is to present it right, and, working in cooperation with the Forest Service, we will decorate the small ballroom of the New Willard with a complete exhibit of maps, diagrams, pictures, transparencies, printed matter, etc. and in every way possible enlist the active aid of these men in

the fight we are making for National action. We feel that if we can once get the South to see the commercial importance of the Appalachians to it, that we shall arouse in these commercial bodies an aggressive and powerful agency of good.

The other matter is also "worth while," for the Agricultural Committee gives to us on December 9 another hearing on the Appalachian question, this time on Senate Bill 4825, being the bill which passed the Senate last session and which was referred to the House Committee on Agriculture. This hearing is most timely, for we ought to be able to present, through the conservation forces here at that time, the importance of the matter, and the overwhelming sentiment in the matter that the Nation is demanding this piece of legislation and intends to have it! We feel that in no higher or more useful way could these several bodies serve the country, and more effectively further the conservation idea than by getting squarely behind this legislation and making their wishes known in unmistakable terms.

So, in this we are working to get out these influences and effectively using them at the hearing.

Our Association has just sent out suggested resolutions to practically every Board of Trade or Chamber of Commerce in the South, requesting their adoption and early return to us. We have prepared and have mailed a brief review of the Appalachian-White Mountain project, which is quoted below, giving the scope, its present status, and pointing the way to success, to all the leading papers in the South, asking for their editorial comment and cooperation.

We will get it, too, for the South realizes more than ever that it must have the Appalachians and will range itself squarely behind the work we have been doing for its establishment.

The brief review of the project follows:

A BRIEF STATEMENT CONCERNING THE PROPOSED APPALACHIAN-WHITE MOUNTAIN FOREST RESERVE

This project contemplates the purchase by the National Government of forest areas in the Southern Appalachian and White Mountain regions, and their creation into a National Forest under the care and direction of the "Forest Service," on identical lines of management and use as are employed in the existing National Forests in the West, where to-day the Nation has some 168,000,000 acres, to be kept in forest covering perpetually under such wise restrictions as to use as insure their utmost value to the people now and in the future.

While the project has been suggested for a period of twenty years and aggressive agitation has been made for eight or ten years, since the need of Government action has been apparent, it has been along somewhat indefinite lines until the last session of Congress.

At this session, following the exhaustive survey and report of the Secretary of Agriculture there were introduced in the House two bills and in the Senate two bills on identical lines in both branches, all providing for the purchase of 5,000,000 acres in the Southern Appalachians extending from Alabama to Pennsylvania, and 660,000 acres in the White Mountains in New England, and proposed an appropriation of \$5,000,000 therefor.

Without going into much detail, no action was taken by the House, the bills dying in the Committee on Agriculture, not being reported out.

In the Senate one of the bills passed, near the close of the session, and being sent to the House, met the same fate as the House bills: viz., "Not reported out of Committee." The result was no action, though the real earnestness, the real urgency of it, the vital concern of the whole Nation in it, were never better or more convincingly shown. See House Document, "Hearing on the Appalachian Bill."

The Senate Bill (No. 4825) being still before the House Committee on Agriculture for their action, must be taken up and disposed of at the coming session of Congress, and if the committee can be induced to report it so that the House can consider and debate it, it stands an excellent chance for enactment into law, for a careful poll of the present House seems to show that the project, which has the cordial endorsement of the whole Nation, will win by a large majority

if a vote can be had on it—and that the old device of keeping it buried in committee may not at this session avail to prevent action.

We are not so much concerned with the success of any special measure. We want and must have in some definite form an adequate start toward a National Forest in both sections, so that we plan to support heartily any measure or measures which will best bring this about, as a start toward a definite, systematic and clearly defined forest policy on the part of the Government, the carrying out of which would mean the extension of the National Forests to all sections where they may be "constitutionally" established and "insure national sanity" as regards their proper conservation to the utmost extent possible.

A large impetus has been given to the cause of forest perpetuation along these broad lines by the conservation movement, which had its inspiration in the Governors' Conference in May last. The National Conservation Commission appointed by the President as the result of that conference has been engaged for months in a study of the National resources and of all the questions involved in their wise utilization. Its early report must be an authoritative utterance. If this report fixes the forest question as of first importance because of their rapid destruction and their early complete exhaustion, it will arouse a demand for their preservation that Congress must heed—and this demand must name the Appalachian-White Mountain region, first. Whether the Conservation Commission does this or not, conditions are such as demand that there be no let up in the earnest and hard work of the unselfish men and women of the Nation who are urging National action in this important matter, and legislation bearing on it should continue to receive loyal and earnest support.

The Agricultural Committee of the House proposes to grant a public hearing on the Senate bill on December 9, in Washington. There will be in session in Washington on December 7 and 8, the Southern Commercial Congress, representing the commercial voice of the entire South. There will be in session there on the 8th the Governors and their advisors, in conference with the President and the National Conservation Commission. There will be in session there on the 9th, 10th, and 11th, the great National Rivers and Harbor Congress—and every man in attendance upon them, who is alive to the conservation idea, should be in attendance on this hearing and make his influence felt before the committee.

Furthermore, every civic league, every chamber of commerce or similar body, every woman's club in every Southern city, should, prior to December 9, pass ringing resolutions demanding this legislation and see that the Appalachian National Forest Association in Washington gets them in time to use them at the hearing on December 9.

Do you plan to help?

ATLANTIC DEEPER WATERWAYS ASSOCIATION

THE first annual convention of the Atlantic Deeper Waterways Association was held in Baltimore, November 17 to 19, 1908 a large attendance and intense interest marking the gathering. Representatives were present from all the Atlantic Coast states, as well as from a number of the inland states. The old officers were reelected and strong resolutions were adopted. The resolutions follow in full:

The Atlantic Deeper Waterways Association, at Baltimore, assembled in its first annual convention, November 17 to 19, 1908, after full consideration and discussion of the relation of waterways to domestic commerce, and particularly of the requirements of the commerce of the 30,000,000 Americans living upon the Atlantic seaboard, approves and adopts the following resolutions:

Resolved, That the business interests of the seaboard population directly, and of the entire nation indirectly, require the removal, at the earliest possible moment, of the natural obstructions to a free interior deep water route from Massachusetts Bay to Key West along the lines indicated by existing canals and by surveys already made under the auspices of the Government of the United States.

Resolved, That in the judgment of the members of this association, and of several of the foremost railway experts in the country, the construction of this water highway can alone give gravely necessary and permanent relief to the business of transportation already hampered by insufficient facilities and threatened with more serious obstruction in the early future.

Resolved, That the evidence is conclusive that an interior deep water channel along the coast will be likely to repay even very large cost within a

brief period by reducing the charges for the movement of commodities.

Resolved, That the canals should be dugged in any case by the Federal Government; first, because the Government alone has authority over navigable water; second, because all the canals should be free, but chiefly because the enterprise, planned in the interest of peace, will have incalculable value for the whole nation in case of war.

Resolved, That in the opinion of this association Congress should deal with this problem as a permanent remunerative national investment, and not as a matter of making annual expenditures, and in view of the need for the earliest relief from the impending congestion of railroad transportation, the money required for deeper waterways should be met by an issue of bonds.

Resolved, That this association warmly commends and asks the continuation and deepening of the waterway from Norfolk to Beaufort Inlet, N. C., now in process of construction under an appropriation and project heretofore adopted by Congress; it asks that Congress shall make the Delaware and Chesapeake Canal the property of the Federal Government and begin its reconstruction in accordance with the recommendation of the Agnus Commission; that surveys shall be made for a canal from Beaufort south and from the Delaware River to New York harbor; that the Hudson River shall be deepened so as to meet in its upper reaches the needs of the traffic upon the improved Erie Canal; and that all necessary promotion shall be given to the projects for opening a channel between Long Island Sound and Massachusetts Bay.

Resolved, That this association pledges itself finally and irrevocably to the Atlantic Deeper Waterways scheme

in its entirety and in detail, preferring no one link in the chain to any other, but ardently desiring that each link shall be dealt with promptly and in accordance with its requirements in its relation to the total undertaking.

Resolved, That notwithstanding this association was organized particularly to promote the construction of a continuous waterway from Maine to Florida, we are in sympathy with all meritorious movements for the improvement of our waterways. A waterway from the Lakes to the Gulf is demanded by the great states composing the Mississippi Valley; and, whenever the engineers shall have recommended a route satisfactory to that section, within reasonable limits of cost, this association stands ready to unite with other sections in promoting legislation favorable to the great waterway. The movements for a waterway connecting the Mississippi with the Atlantic Ocean and the Atlantic with the Gulf, together with other waterway improvements which are shown to be practicable, also have our sympathy and cooperation. This association is committed to a broad, liberal policy consistent with the demands of commerce and within the ability of the Government to construct.

Resolved, That this association ex-

tends cordial greetings to the National Rivers and Harbors Congress which will soon convene in the city of Washington. That body has prosecuted a forceful propaganda of education among the people of the country for larger and more regular appropriations for the deepening and improvement of our harbors and waterways. We pledge our sympathy and active support in the continued prosecution of the work of that Congress.

Resolved, That the association approves the work of the United States Forest Service and commends the progressive and efficient administration of this service under the present Chief Forester; and commends the work of the "Inland Waterways Commission" and the other official and individual movements for the conservation of our natural resources. If the normal flow of our navigable streams is to be preserved, if the disastrous results of floods are to be averted, the forests and their floor covering at the headwaters must be preserved under the regulation of intelligent foresters. The interdependence of navigable waters upon their related natural resources is fully recognized and we pledge our efforts for the maintenance of all movements for their conservation.

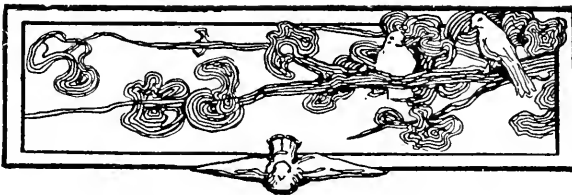

MISSISSIPPI-TO-ATLANTIC DEEP WATERWAYS ASSOCIATION

A NOTABLE convention of the month was that of the organization hitherto known as the "Gulf Coast Inland Waterway Association." It was held at Columbus, Ga., November 10-11, and was largely attended by delegates from Louisiana, Mississippi, Alabama, Georgia, and Florida, with members and guests from Illinois, Indiana, Ohio, South Carolina, and the District of Columbia. Notable addresses were made, that by Hon. Duncan U. Fletcher, U. S. Senator-elect from Florida, attracting particular attention as an exposition of the present condition and needs of navigation in the Southern States.

The name of the organization was changed to "The Mississippi and Atlantic Deep Waterways Association," and a committee was appointed to revise the constitution. Senator Fletcher was elected president for the ensuing year, with Mr. Leland J. Henderson, secretary, and Mr. G. A. Waterman, treasurer, with a strong body of vice-presidents and an effective executive committee. The resolutions adopted (apart from those of a more personal character) are as follows:

Feeling that the full industrial development of the southeastern states must depend on improved transportation facilities, we favor the adoption and prompt execution of a comprehensive plan of waterway improvement. We especially favor and call for, as a just right, the construction of a deep inland waterway along the eastern gulf coast to connect the Mississippi River with the Atlantic Ocean, together with the improvement of the gulf slope rivers in such manner as to open new territory to water transportation. We favor the execution of the work under

federal appropriations adequate for prompt and certain completion of the entire project; and, in case the state of the public treasury forbids sufficient appropriations at an early date, we favor the issuance of bonds in such an amount as to insure the completion of the work in a businesslike way.

In voicing our needs, we appeal to the Federal Government as of right; and as citizens and as representatives of the citizens of six sovereign states we claim consideration and action by Congress in accordance with the repeated recommendations of the federal administration and the united declaration of the governors of all the states of the Nation.

Resolved, that this convention cordially and unreservedly approves the work of the National Rivers and Harbors Congress, and endorses the policy advocated by it, and that this association take out a membership in the National Rivers and Harbors Congress and send delegates, not exceeding fifty, to the coming convention of said congress in Washington, December 9, 10, and 11, 1908, and urge upon all municipalities and commercial organizations in the states represented in this convention to do likewise.

That this association authorize the president to appoint three members as directors of the National Rivers and Harbors Congress, and ask that these appointees be elected such directors by said congress—one from the Chattahoochee River Basin, one from the east gulf coast, and one from the Atlantic Coast of Florida.

Resolved, that the Mississippi to the Atlantic Inland Waterways Association endorses a comprehensive businesslike system of caring for and improving

rivers and harbors and of extending such natural advantages by means of connecting canals whenever needed or justified by prospective requirements of trade between such natural waters. We specifically approve and endorse the Inland Waterways Commission.

That this convention heartily endorses the national policy of conserving all natural resources, and especially the sources of control of the water supply of inland streams, and to that end advise that the several states of the Union legislate with a view to vesting in the National Government sufficient authority above heads of navigation to adequately protect the rights of posterity as well as the advantages of the present generation.

That this association calls upon the governors of the states who have not named delegates to the approaching meeting of the National Conservation Commission to do so at once, selecting suitable persons who will attend the meeting and represent the states from

which appointed; and that the president of this association be requested and urged to attend said meeting of said National Conservation Commission, and the Hon Napoleon B. Broward, governor of Florida, be requested to appoint the president of this association as one of the delegates from the State of Florida.

That we unreservedly endorse the project and purposes of the Southern Commercial Congress, to meet in the City of Washington, December 7 and 8. the purpose of said congress being to bring the South itself into a clearer understanding of its rich possessions and to bring to the North and the rest of the world a fuller and therefore juster appreciation of the resources and opportunities of the South. Said liberations, we urge every resident of Southern States to visit Washington for this and the other great events of the week beginning Monday, December 7.

RESIGNATION OF DR. THOMAS E. WILL

At a meeting of the Executive Committee on October 19 Dr. Thomas E. Will tendered his resignation as Secretary of the American Forestry Association. It was accepted to take effect on October 26.

Although without connection with the Association since October 26, Doctor Will retains a deep interest in Forestry, and articles from his pen may be anticipated from time to time.

WATER-POWER

Our Unappreciated Resource and Our Future Refuge

By M. O. LEIGHTON, Chief Hydrographer, United States Geological Survey

IN THE closing days of August there were featured in the daily press accounts of floods in some southern Appalachian rivers. The descriptions contained nothing new. The story of some earlier flood would have been quite as satisfactory if a few names and figures were changed to correspond with local conditions. The really important facts were, as usual, omitted. To illustrate this, a single instance will be discussed.

Augusta, Ga., is situated on the Savannah River, at the head of navigation and at the foot of a series of falls and rapids that surmount forty-four feet in seven miles. A water-power privilege is thereby afforded, which, if fully developed, would furnish a minimum of about 15,500 horse-powers. Bear in mind that this is the development which, under present conditions, limits the value of the privilege. With an accommodating market, more power might be sold during seasons of high water, but 15,500 horse-powers are all that could be guaranteed throughout the year. In other words, until a greater flow can be secured during low-water seasons the Augusta privilege must be classed as 15,500 horse-power.

Newspaper reports fixed the damage of the August flood at Augusta at about \$500,000. For present purposes it matters not whether the proper figure be one-half or twice the newspaper estimate. The items of damage included loss to real property, raw materials, and finished merchandise, machinery and other equipment necessary to manufacturing and commerce. Possibly the estimate included losses due to interruption of traffic, delay in production cessation of wages, and other circumstances consequential in nature.

It is unlikely that the estimate included depreciation of property values, arising from the menace and uncertainty of future recurrent floods, though this is often a larger item of flood damage than all those above cited. Finally, it is certain that the estimate did not include the most serious loss of all: *The loss of the flood water.* It swept by Augusta unrestrained, carrying with it far more astonishing possibilities of ultimate benefit than can be measured by the devastation resulting from its unrestraint. For the purpose of measuring this most serious loss, let us scale is off in terms of water-power.

During the August flood there passed by and through the city of Augusta approximately 62,000,000,000 cubic feet of water in five days. If the water so lost had been conserved in forests and reservoirs on the upper drainage area of the Savannah and released uniformly throughout, say, the six low-water months of the year, the flow past Augusta would have been increased during these months by about 4,000 cubic feet per second. We know from observation of flow in the Savannah, that the remaining six months of the year will furnish at least as much as this, in addition to the usual low-water flow. Now, this amount of water, falling over the forty-four feet at Augusta, will produce 14,500 horse-powers. All this assumes a condition under which the entire flood could have been stored. But we know that all could not have been stored. With proper conditions of forestation, and with available reservoir sites utilized, about sixty-five per cent. of this flood could have been withheld. Therefore, we must reduce the power above given by the same proportion. The final re-

sult is, therefore 9,500 horse-powers, which, added to the previously stated minimum power, would raise the rating of the Augusta privilege from 15,500 to 25,000 horse-powers.

Seventy dollars per horse-power is not a large installation cost in this country. Some developments in the region have cost far more than this. Therefore, the value of the Augusta privilege alone, on the basis of the August flood, would have been increased \$665,000 by the adoption of proper means for saving the flood water. This is the figure which represents the principal item of loss in the Augusta flood, and of which neither the press nor the world made record.

The Augusta case has been discussed because its application is so thoroughly general. Like consideration apply to all water-powers. We have in the first place, an amount of economically available water-power, enormous in the total for the country, with rivers in their present condition of unrestraint. Secondly, we have a reserve which may be made available by means which will save the flood waters now wasted. No consideration of water-power is complete unless it comprehends the double possession. The extent of our suffering from floods must, therefore, be an index of our wastefulness of water-power. This may be accepted as fundamental.

We, as a Nation, present the curious appearance of being highly progressive on the one hand, and ruinously extravagant on the other. We get what we want, but the price that we pay is exorbitant. At the present time we are using not less than 26,000,000 steam horse-powers for manufacturing, light, traction, etc. It is true that there was a time when steam was the cheapest and most adaptable motive power. That day is past, or is rapidly passing, for everything except marine locomotion, and the twilight of that is not far distant. Steam-power is comparatively expensive, yet steam installation is constantly increasing. We persist in using expensive motive power, while millions of horse-powers are going to waste

in our rivers. The steam-power plants of the country must use approximately 260,000,000 tons of coal per year, an amount considerably more than one-half our total consumption of coal for 1907. Therefore, not only are we paying more than is necessary for our motive power, but we are in the process of making great and greater demands on our coal resources, to hasten their ultimate exhaustion.

It will be well now to consider how much cheaper is water-power than steam-power. Of course, there is a wide variation depending on many factors, most important of which is the price of coal. There are places in which coal is so cheap that the cost of steam-power exceeds little, if any, the cost of water-power. In other places, the difference in favor of water-power may exceed \$60 per horse-power. The State Water Supply Commission of New York, working under the guidance of one of our most competent engineers, calculated that in that state a steam horse-power per year is \$12 more costly than a water horse-power. This may be considered a small margin, resulting partly, no doubt, from the proximity of New York State to the Pennsylvania coal fields. Therefore, we shall be exceedingly conservative if we use this factor for the entire country.

As previously stated, there are in use 26,000,000 steam horse-powers. Undoubtedly there is some of this so situated that it could not at present, be replaced by hydro-electric power. If ten per cent. be allowed for this we shall be making a very liberal concession. This leaves 23,400,000 steam horse-powers which, at an excess cost of \$12 per horse-power, gives a total of about \$281,000,000, which the people of the United States pay annually for the privilege of squandering their coal resources. In view of this conservative estimate, is it not remarkable that we do not use more water-power?

Whether or not the people awaken to the bountiful water resources of the country, it is inevitable that the progressive exhaustion of our coal depos-

ics, and the consequent increase in the price of fuel, will drive us to water-power. It is, therefore, proper to ask whether or not the water resources of the country are sufficient to meet future demands. It is recognized that the demand for power must have future increase, even greater than that of the past. Therefore, let no one underestimate the task of providing a substitute for steam. Notwithstanding this, the prospect to one who has looked broadly into the country's water-power resources, is altogether pleasing. No one can tell at present just how extensive are those resources; although, in a few months, approximate figures will be at hand. Yet if we estimate from information now available, there is a wealth of conservation in the statement that 50,000,000 horse-powers may be produced from our rivers. Nor would there be any surprise on the part of the author if the final surveys show that with maximum conservation, three times the above amount may be realized. In any event the demands of a goodly number of generations will be amply served.

Our duty to ourselves and to posterity in the stewardship of our natural resources is not ended with the accomplishment of great achievements. Because we may, by wise procedure, ensure unto the fifth or sixth generation an abundant supply of this or that necessity, the obligations imposed by our stewardship are in no wise satisfied. Yet if, by conserving all water-power that can be made available on demand, we can look ahead to a suffi-

ciency for that fifth or sixth generation, we shall have accomplished a duty manfully and well. Having done all that we can, our responsibility, at any rate, will have been discharged. It will not suffice merely to know that the United States affords 50,000,000 or 150,000,000 water horse-powers. Like riches, horse-powers have wings. Present possession provides no guaranty of future availability. Our duty lies in securing those horse-powers using what we need and placing the remainder in safe deposit. Thus would a private corporation do. Why, then, should not a public corporation do likewise? The same economic principle controls both.

Present practices, all too familiar, will finally so dissipate our water-power resources that they will not be sufficient even for present demands. Therefore, the precept is utterly convincing that the first duty of the people is to study these resources and provide corrective measures for those practices. Thus shall we not only achieve power in more than one sense, but we shall consequentially provide for all other lines of water utilization and conserve our most valuable mineral deposits. There is but one great problem involved; to break it into parts, to pursue one object to the disregard of another merely betrays a narrow and obsolete view-point. Water-power is but one factor, although the most important, in a vital and world-wide problem, the solution of which has fallen to us. So far our shirking has been ingenious. The process has been easy, but even now we are paying the price.



THE RELATION OF THE UNITED STATES GEOLOGICAL SURVEY TO THE PUBLIC*

By GEORGE OTIS SMITH, Director U. S. Geological Survey

TO SERVE the people is the purpose of every Government department and bureau. As a part of the public service the Geological Survey has functions prescribed by law. In the organic act establishing this bureau twenty-nine years ago it is specified that the Director of the Geological Survey shall be charged with the classification of the public lands and the examination of the geologic structure, mineral resources and products of the national domain. Thus did Congress express its recognition of the practical relationship existing between geology and the mineral industry as well as its appreciation of the fact that these mineral resources constitute the Nation's material wealth.

The Survey thus became a pioneer agency in the development of the country. Its name expresses the scope and character of its work as national scientific, and practical. "Survey" stands for work in the field, and this branch of the public service is an organization for practical investigation in which the methods of pure science are made to serve utilitarian ends so as to insure the attainment of the economic results desired by the public. To be successful a Government scientific bureau must be practical.

The extent of the operations of the Survey depends upon the size of the annual appropriations in its behalf. Congress has gradually increased these from \$100,000 to more than one and a half million, so that the Geological Survey has from year to year become better equipped to occupy the large field of public service to which it was given a title in 1879.

Its activities are all directed toward

the public benefit, but are so varied as to deserve a simple classification for purposes of description. The exploration work of the Survey includes the discovery and mapping of the previously unknown; the investigations by the Survey have as their purpose the determination of the value of all the new data collected by the fieldmen; and the publication side of the work involves the making known to the world the results of these explorations and investigations.

As I speak of the explorations of the Survey, I must mention first the twenty-five to thirty thousand square miles of territory that is mapped each year by the Survey topographers. Exploration is the correct term, for our topographic surveys bring out new discoveries even in portions of the United States long settled. For example, the highest points in such old states as Ohio and Pennsylvania have been determined only recently in the course of the field surveys of these areas by our topographers.

The detailed maps that are being thus made of the country already number 1,800 sheets, which together cover one-third of the area of the United States. These maps constitute the "mother map" of the country in that they are based upon actual surveys, so that the other maps with which the public is familiar, whether published in geography, atlas, or as a folded state or county map, are to a large extent based upon the United States Geological Survey maps.

These topographic maps are utilized not only by the map-makers who sell their publications, but by the Govern-

*Address delivered before the Maine State Board of Trade, September 22, 1908.

ment cartographers, for example, in making the Post Route maps of the Post-office Department, or as bases for the military maps prepared by the War Department. While we know the extent to which the maps are put to a federal use, we can only estimate how largely they are utilized by the engineer in private practice in the great industrial enterprises of the day.

These maps now possess a degree of accuracy which fits them to serve the general purposes of preliminary surveys, so that the engineer can use them for the location of railroads, canals, highways, trolley lines, or in connection with planning water supply, sewerage, drainage, or irrigation systems. The fact that the sales of these Survey maps average over a thousand sheets every day in the year is evidence of a popular demand, but the measure of the contribution of these surveys to the public includes more than the extent of map distribution. Over all parts of the country there have been lines of levels run amounting to more than 200,000 miles, over 8,000 miles being run last year. Permanent bench marks are established, 2 100 last year, as a result of this accurate leveling, and these monuments serve the public, whether it be the western ranchers planning their irrigation system or the eastern engineers selecting a pipeline route.

Geologic mapping by the Survey geologists is another branch of exploration work, in which not only is the surface distribution of the rocks and soils observed and mapped, but also the subjacent formations are studied, to the end that the published maps may furnish the prospector, the mine-operator, or the driller for oil, gas, or water with reliable information as to what may be encountered at hundreds and thousands of feet beneath the surface. Detailed geologic maps covering thousands of square miles are issued each year, and the issue of such a map of a mining district is eagerly awaited by the mining engineers and mine-owners.

Nowhere has the Survey made a better record than in Alaska. Ex-

ploration work in this northern outpost of our country has resulted in maps that have well served the purposes of the prospectors and miners who have added so much to the Nation's wealth. The literature on Alaska of value to mining men is almost wholly of Survey authorship; yet the explorations represented by these reports and maps have involved an expenditure of less than half a million dollars or only one-half of one per cent. of the gold output of Alaska for the same period, not to mention the increasing production of coal and copper. Few taxes are so light as this.

The investigation work of the Survey is closely connected with the explorations by the field-men. The data collected must be studied, whether these are geologic, geographic hydrographic, or technologic: that is, whether they concern, for instance, ore deposits, mountain passes, waterfalls, or smoke abatement. Many are the lines of investigation, and each in its final analysis is found to be utilitarian.

One of the most important investigations under the Geological Survey is that of the water resources of the country. The daily flow of streams has been gaged at over 1,500 points throughout the United States for a period of years, and from these records the public can gain the most authoritative information available regarding the average flow of these rivers. During the past year 630 gaging stations were maintained.

Still another line of activity in scientific investigation by the Geological Survey is its technologic work. The testing of the fuels and structural materials, of which the Government itself is so large a consumer, has inaugurated investigations which have already yielded results of the greatest value to the public. Time permits mention only of the general scope of this work, but this is sufficient to indicate its importance. These investigations include the gas-producer tests which have shown the practicability of utilizing for power generation low-grade fuels, such as slack coal, bone, and lignite; the

manufacture of briquetts, so commonly used in foreign countries, and the testing of these briquetts on locomotives and naval vessels; comparative tests of the producer-gas engine with the steam engine and of the internal-combustion engine using gasoline and kerosene as well as alcohol; coking and washing tests which demonstrate the coking possibilities of many of the Rocky Mountain coals heretofore regarded as non-coking; smoke abatement investigations, which have indicated the conditions in steam boiler practice necessary for securing more perfect combustion; inquiries into the available supplies of concrete materials and the study of these constituent materials; the investigation of concrete as a structural material for different purposes and under different conditions with tests of concrete beams of different ages; comparative tests of different materials to determine their fine resisting qualities and strength at different temperatures; all these investigations have been carried forward and results of the most practical kind secured. Over 1,000 inspection analyses have been made of coal purchased by the Government on specifications, resulting in the delivery of coal up to the fixed standard of purity. This method, just inaugurated in the Government service, of getting the coal it pays for and of paying for just what it gets, is worthy of imitation by the general public. In a similar way all these technologic investigations, while made by the Survey primarily for the benefit of the Government, are in reality of even greater value to the public at large. Another line of investigation has as its purpose the prevention of mine disasters, with the consequent appalling loss of human life. Experimental work in the testing of explosives has just begun at Pittsburg under the supervision of the Survey.

The explorations and investigations of the Survey realize their full purpose only as the results attained are published. The relation of the Survey to the public demands that these results must be presented in the form best

adapted to secure publicity and that the publications must be distributed with care and expedition. Thus the Survey becomes a bureau of publication as well as of investigation, and here lies the real test of its success in the service of the people.

Publicity of results is secured by the preparation, publication, and distribution of the reports of the various investigations, geologic, geographic, hydrographic, and technologic, by the engraving and printing of the maps representing the surveys, and by the distribution of news bulletins issued weekly for use by the newspapers of the country. This news service deserves a further word inasmuch as it represents the Survey's point of direct contact with the most efficient agency of publicity, the newspaper. Advance notices of Survey publications, summaries of reports of special interest, preliminary statements of the statistics of mineral production, and news items regarding work in progress in the different branches of the Survey constitute the subject-matter of these press bulletins. Their purpose is to acquaint the public with the activities of the Bureau and to advertise the reports as issued, that the public may secure promptly the results of the work that is supported by public money. In this press-bulletin service there is no intention of advertising any one connected with the Survey, nor of creating public sentiment, nor of influencing public opinion, except as public opinion may be molded by the facts presented in the reports published by the Survey. In short not only must the scientific economic investigations of the Survey be made to yield authoritative results, but these results must be given to the public. Whatever form of publication secures the greatest publicity without affecting the integrity of the statement of these results, that form best serves the public.

In the publication branch of the Survey, there were issued in the fiscal year just closed: 127 books, comprising over 10,000 pages, nine geologic folios, eighty-seven new topographic maps,

127 reprints of maps, and fifteen special maps—a separate publication for every day of the year, with a grand total of copies issued of over 900,000. The total distribution of these publications was nearly 850,000 copies.

After this review of the different phases of the work of the United States Geological Survey, it may be appropriate to speak of the policy governing this branch of the public service. I have said that the Survey had its origin in an appreciation of the importance to the Nation of its mineral resources. In 1879, the treasure house of the country had barely been opened; the value of last year's mineral output was approximately six times that of the product of 1880.

This phenomenal growth of the mineral industry during the life of the Survey has emphasized the industrial dependence of the country upon its mineral wealth, and the present year has seen a nation awakening to a realization of its future needs. Thus it is that the Survey's duty to the people has caused its role to change in these thirty years from that of the promoter of the development of the mineral industry to that of the conservator of these sources of wealth. The Nation, under the lead of President Roosevelt, has begun to take thought of the morrow, and it has turned to its scientific bureaus for authoritative information.

The problem before the American people to-day is the extension of the life of its natural resources. It is fortunate that the explorations and investigations of the Geological Survey not only have contributed to the development of these resources, but also have furnished quantitative data that are available at this time of popular awakening to the needs of national conservation. The practical value of the Survey's scientific work has thus won popular recognition and appreciation, so that the Bureau can realize more fully its purpose of promoting the economic development of the country along proper lines.

Conservation as applied to mineral

resources means the meeting of present-day needs with an eye open to the requirements of the morrow. To this end, an inventory of the country's present supply of the essential materials is the first step, and for a period of years the Survey has been engaged in stock taking. The Survey geologist has measured the coal and iron reserves; the Survey hydrographer has gaged the streams of the country, determining their flow and calculating the available power; the Survey topographer has explored and mapped the little-known areas, furnishing us with reliable data from which may be determined the feasibility of reclamation by irrigation or by drainage, and the Survey statistician has determined and recorded the increasing rate of production and consumption of mineral products. With this information already at hand, the greatest incentive to economy is provided. The phenomenal industrial growth of the past few years cannot continue without endangering the future unless wasteful methods are stopped.

The campaign of conservation must be one of education. In this educational service, the Geological Survey, like the other scientific bureaus, long since enlisted. Its policy has been to better economic conditions by the investigation of the Nation's natural resources. Through such investigations by the Geological Survey the Forest Service and the Reclamation Service both originated, the older bureau by its preliminary work marking out the great fields open for the larger activities of the younger organizations. In the subjects other than forestry and irrigation, the Survey has continued its work and to-day is presenting to the public facts that constitute most forcible arguments for national conservation.

The subject of our mineral fuels is one of intense interest to the American who desires his country's future to be no less brilliant than its present. On the eve of the Governors' Conference at the White House, the Survey issued a map of the coal fields of the United States. This showed both graphically and sta-

tistically the extent of the Nation's coal reserves; but great as are these stores of fuel, at the present rate of increase in consumption, these statistics indicate that the supply of easily mined coal will be exhausted before the middle of the next century. Cheap coal has given this country its industrial supremacy, and it is well to take this account of stock.

The very abundance of our mineral fuels and ores of the important metals has discouraged economy, so that the problem immediately before us is that of waste prevention. Nowhere are the present conditions more critical than in the case of coal. At every stage in the mining and utilization of coal there is waste to an extent almost beyond belief, and much of the technologic investigation on the part of the Survey is directed toward lessening the waste in the production of coal and increasing the efficiency in its consumption.

Water is unquestionably our greatest mineral resource. All great industries—agriculture, manufactures, transportation, and mining—depend upon it, and it is fortunate indeed that our President has called the Nation's attention to the value of its water resources. The possibilities of our rivers and streams well deserve the investigation I mentioned earlier as being carried on by the Survey. Flood prevention would save to the Nation over \$100,000,000 annually, and it is believed that flood control could be secured by an expenditure equivalent to the present losses from the floods of a few years. Inland water navigation is demanded to solve the present-day problems of interstate commerce. Reclamation by irrigation and drainage means the winning to the use of man of vast tracts of fertile land and thus increasing the national wealth. Even more opportune to-day is the discussion of the utilization of our water power. While America is the greatest consumer of coal, more than one-half of the present consumption in the United States has for its object the generation of power. In the presence of enormous undeveloped water powers, this drain upon the coal resources

seems in a large part unwarranted. Utilize this water power and there will result not only the financial saving of to-day, but also the conservation of the coal. Nor should we think that posterity alone is concerned in this conservation of our resources. Every step toward the exhaustion of our easily mined coal, for instance, will be marked by a rise in price.

It is, then, only by systematic study of the natural resources of the country that progress can be made toward national conservation. The practical value of the Survey's scientific work has been recognized in this connection and the usefulness of its results appreciated by the general public. With reliable information before us regarding our stores of natural wealth our present wasteful practices, and our possibilities of improvement in methods of utilization, there should indeed be sufficient incentive to join in the movement for national betterment.

As a citizen of Maine, addressing a representative body of Maine men, I should speak of the share our state has in this national conservation. In all that relates to natural resources, political boundaries play little part. Most of the important rivers of the country are interstate streams. The distribution of the forests and deposits of valuable minerals antedated by centuries and ages the definition of state boundaries. Thus the paper manufactured from timber from the Maine forest by power derived from one of our rivers may go to a southern city, or again, the steel used by one of our Maine mills may be the product of a Pennsylvania furnace using Minnesota ore, West Virginia coke, and New Jersey limestone. It is this interdependence, this community of interest, that makes anything that affects any part of the country a matter of real concern to the citizens of Maine. Yet there are certain phases of this broad subject that touch us more intimately than others.

The farm, forests, and water powers of Maine comprise her chief natural wealth and constitute the real basis for her industrial life. Of these I will men-

tion only two, the forests and the water resources, which indeed cannot easily be discussed separately.

The rivers of Maine now contribute to the industries of the state a total of 341,976 horse-power. It is estimated that, fully developed, Maine's water powers might yield with proper storage somewhat more than 1,000,000 horse-power. This conservative estimate gives our state the equivalent as regards power generation, of the coal production of several of the fairly important coal states.

The development of these water powers is the line for Maine's future industrial progress. The preservation of this source of cheap power is a trust which we of to-day must acknowledge, and waste of this natural resource is criminal, inasmuch as with proper care water power can be utilized to the fullest extent and at the same time be successfully conserved for use by posterity. The discussion of the conservation of our water resources leads directly to the consideration of our forests.

Full appreciation of Maine's dependence upon her forests and exact knowledge of the extent and present condition of this resource are essential if we are to seek to inspire the people to adopt a policy of economy. There must be an educated and aroused public opinion if waste is to be discouraged. First of all, we must not be led by sentiment, but rather be urged onward by practical knowledge. Waste may or may not find some excuse for existence. There is a theoretical waste which it is not practicable to avoid under present conditions, but there is also waste against which both theory and practice warn us. There are the tops and limbs that cannot be taken from the forest, because their utilization would cost more than it could yield; but there are many forms of waste which may be avoided with profit to all concerned. Chief among these is the annual loss by forest fires. Two well-qualified speakers are to address you on this subject, and will discuss the prevention of this form of waste.

After several years of field work in the states of Michigan and Washington, where I have traversed hundreds, if not thousands, of square miles of territory devastated by forest fires, I feel qualified to add my warning as to the consequences that follow close upon such devastation. The forest is not only of value for the timber it contains, but it is the great conservator of soil and water. We might do without wood, but we cannot do without the forest. The soil that formed under the protection of the forest cover is soon washed away after the forest fire, if indeed the best of the soil was not reduced to ashes along with the forest itself. The streams that had their sources in the forested hills become seasonal torrents after the fire and the burnt-over land is indeed a thirsty land. No caliper surveys, however carefully made, of the burnt-over tract can furnish an estimate of the actual loss to either the owners or the people at large. The land at best has been made non-productive for a long term of years, and if the acreage is large the industrial equilibrium of the state is seriously disturbed. But no truer statement of these disastrous results can be made than that set forth by our Maine supreme court, in that opinion which deservedly called forth the admiration of President Roosevelt.

In this opinion, our jurists have taken an advanced position in the protection of the public's interest in the forest, yet they have not misjudged the state's need of protective legislation. For weeks now we have seen the danger signal each evening as the sun sinks in the west, and the issue of the hour is plainly the conservation of our forest lands. You business men of Maine should stand shoulder to shoulder with your supreme court justices and ask for the prompt enactment of laws which will preserve for our children the forests and water powers of Maine.

The forestry problem in Maine presents to me a two-fold aspect. First of all, the system of taxation of forest lands must be one to encourage the gathering not of one crop alone, but

of many harvests of trees from these lands which are fitted only for timber culture. I have very vivid memories of the cut-over lands of Michigan, and that is a state where a faulty policy of heavy taxation led the landowners to strip their lands of the valuable pine and then abandon the barren hills and plains to the state. The most practical precaution against over-cutting on private lands would seem to be the automatic restriction which is being advocated here in Maine: namely, the method of taxing what is cut rather than what is left. The other part of the problem, however, presents a more urgent need than any scheme of protection of these timber lands from the greed of private owners and that is the necessity of safeguarding these lands from utter devastation by fire. Here lies the opportunity of the executive officials of the state for I deem it their duty to be as progressive and farsighted as the state judges. This is no time to fall back behind precedent, nor to stand pat upon past procedure. There are exigencies that create and justify new methods of protecting the public interest. Our supreme bench is quoted by trade and commercial journals as far as the Pacific coast—do we wish it said that our judiciary constitute our only guardians of the public interest? Is there or is there not a law requiring efficient spark arrestors on locomotives? If such a law is on the statute books, why is it not enforced by those appointed to execute the laws of the state? Or are they awaiting resubmission of this statute also?

It will be written down to the credit of the Roosevelt administration that the federal officials have been aroused to a new appreciation of their obligations, not to this or that great interest, but to the public at large. The bureau officer at the center of government no longer complacently takes the Vanderbiltian view of public service; he gets busy in the performance of his whole duty as a servant of the people. This reform has been accomplished by placing before the whole departmental service the true aim and purpose of

government: namely, that of securing for every citizen all his rights and privileges. There is nothing new in this idea, but its manifestation has not yet become common enough, and the Roosevelt idea of stirring up public officials might well go beyond federal circles.

As a fellow servant of the people then, I would urge the state officials to meet the present emergency with the sole purpose of protecting the public interest at stake. Both executive and legislative branches must approach this forest problem not from the standpoint of the railroad companies, nor that of timberland proprietors, nor that of the pulp or lumber-mill owners, though we may agree that all these classes deserve much consideration, nor from that of any other special interests, but from the viewpoint of the whole people, whom alone you represent. Burn off the forests of the state, dry up its rivers, lay waste its land, and it will be not the timberland owners or the great manufacturing corporations, but the people at large who will suffer most and, as I understand it, that is the principle set forth in the supreme court opinion that we do well to quote, to consider, and to act upon.

I am not satisfied that the idea now current as to the status of the wild lands of the state as regards trespass is correct. The right of the public to hunt over the lands in private ownership is a question I will leave to the students of the law, but I would challenge the right of the public to build fires upon these lands. I cannot believe that the common law grants to a landowner the right to make any use of his own land that will endanger the property of his neighbor, and the general public should hardly expect any privileges that do not belong to the owner himself. Those who have in charge the execution of our state laws in protection of these wild lands may well at a time of exigency like the present prohibit the building of fires by those who wish to traverse the timber lands. Should such a prohibition interfere with their hunting, their loss con-

sequent upon such interference is outweighed by the danger to the property of others and to the public good that surely results from their camp-fires. When the interests of the Maine public are at stake, our law officers must surely be able to find some legal protection against non-resident tenderfeet.

The opportunity before our state officials is an exceptional one. By increasing the efficiency of the present admirable forest fire warden system, by

expending larger sums before the fires start and relying less upon the average rainfall, by promptly meeting each new problem with the proper initiative and independence by considering the interest of the whole people, and that alone, they can insure the future prosperity of the state and be public benefactors in fact. Some of us may advocate the conservation of the state's wealth, to these officials comes the privilege of actually protecting these resources.

REPORT OF THE WATER SUPPLY COMMISSION OF PENNSYLVANIA

ONE of the most enlightening and useful papers of the year on stream flow and water supply is the Report of the Water Supply Commission of Pennsylvania for 1907. The Commission was established in 1905 to procure facts concerning the water supply of the state and to provide for its utilization, conservation, purification, and equitable distribution.

In 1907, the jurisdiction of the Commission over the water companies of the state was increased by requiring all applications for charters for water and water-power companies to name the waters which it is proposed to use, by requiring all agreements for the consolidation or purchase of water or power companies to designate and limit their source of supply the same as original applicants for charters and by requiring all companies subject to the provisions of the law to procure the approval of the Commission before they can take or use any new or additional source or supply.

To intelligently carry out the provisions of this comprehensive law the Commission found it necessary to study the water supply of the state from several aspects. Particularly it had to give

attention to the influences which are working to reduce the available water supply and to render stream flow more irregular.

Fortunately for the Commission it was provided with funds sufficient for the employment of an able corps of engineers under the charge of Mr. Farley Gannett. Mr. Gannett and his assistants have not been satisfied merely to compile information. They have done this, to be sure, have compiled much in fact, but they have also gone after original data on the topographic and hydrographic conditions of the state.

The Commission has given a large amount of attention to the obstruction of streams through various kinds of development work. Its investigations have brought to light the existence of serious conditions in several important streams. For instance, "the carrying capacity of the Kiskiminetas River has been greatly reduced by the flattening of the slope by deposits carried down from above, and by encroachments along its bank, while changing conditions in its watershed make necessary a greater facility for discharge. This stream was one of the chief contribu-

tors of the great flood at Pittsburg in March, 1907."

No one will question but that it is for the best interest of the state that hereafter any obstruction to a navigable stream must first be approved by the Commission.

Upon no part of its field of inquiry does the Commission lay greater emphasis than the relation of forested watersheds to stream flow. An entire chapter is given to this subject and considerable original data is presented for several Pennsylvania streams. How thoroughly the Commission is convinced of the fundamental importance of forests to stream flow is shown by the following statement which occurs in the introductory part of the report:

"One of the causes which lessens the available water supply is deforestation, and the results of the work of this Commission show that stream flow is more irregular than formerly, and the value of the streams to the Commonwealth greatly decreased for this reason. The investigations of the Commission on this subject demonstrate that, in order to preserve the present value of our streams, active steps must be continued to protect and preserve the existing forest lands of the state, as well as to reforest those districts which have been denuded of the timber land.

"The effects of floods upon the streams of this state have been given careful consideration by this Commission, and wherever possible flood conditions have been carefully studied. The control of floods is closely allied with and interdependent upon the development of water power, and the results of the investigations of this Commission on these subjects are set forth in detail in the following pages. Flood influences may be ameliorated by reforestation of the denuded forest areas of the state, by the construction of extensive storage reservoirs for excess waters, and by the straightening, widening, and deepening of the channels of streams.

The interest recently taken in inland navigation, to effect which would necessitate the erection of numerous dams, and the revival of the use of water as power, may aid in protecting the streams of this state against flood. Through whatever means such results are accomplished the effect will be both a decrease in the damage to property and also an increase in the available water supply. The larger streams of this state may not yet have reached the condition where conservation of the water in reservoirs for supply purposes is necessary, but provision must be made by means of reforestation and reclamation of streams which are now undesirable for use, to keep the supply at its present capacity."

The Commission does not stop with the mere statement that deforestation is bad. It says in effect that the condition is so bad that it must be remedied and that it must be done through the protection or renewal of the forest. It heartily endorses the work of the State Forestry Reservation Commission in establishing state forest reservations on the headwaters of streams to the extent of over 750,000 acres, and in introducing scientific methods of lumbering and forest culture. It favors the legislation now pending in the Federal Congress, providing for National Forests in the Appalachian Mountains, extending over the headwaters of the Monongahela River.

Working in accord with the Forest Reservation Commission as it is doing, the possibilities of usefulness of the Water Supply Commission to the great Commonwealth of Pennsylvania can scarcely be overestimated. Its results should attract the notice of other states where the need of a similar body of authority on water supply is equally great.



BEARING OF THE PROPOSED APPALACHIAN FOREST RESERVE ON NAVIGATION

By W J McGEE, LL.D., Expert, Bureau of Soils, Department of Agriculture
(Secretary U. S. Inland Waterways Commission)

THE states whose rivers will be directly influenced by the Appalachian Forest Reserve when established are Alabama, Georgia, Kentucky, Mississippi, North Carolina, South Carolina, Tennessee, Virginia, and West Virginia, with northern Florida. Their area is 400,000 square miles. The rivers comprise the principal tributaries of the Ohio, including the Cumberland and Tennessee; the Mobile system, including especially the Alabama and Tom Bigbee, with their leading affluents; the Appalachian system, of which the chief members is the Shappahooche; the Ocmulgee, Altamaha, and Ogechee systems; the Savannah and Coosawhatchie, Edistow, Santee, and Pee Dee systems; the Cape Fear, with some of its affluents, the Noose, Tar, and Roanoke, with connected waters; the James and Rappahannock; together with the great bordering rivers, especially the Mississippi and Ohio, which extend the influence into all the adjacent states.

The mean annual precipitation within the states directly influenced by the Appalachian forests is about fifty inches; the total quantity per year is about 45,000,000,000,000 cubic feet. This boon from the skies is the chief value of the region; it controls production; it determines the value of farm lands; it fixes sites of towns and factories; it forms ways for water traffic and governs other lines of commerce. Without it the region would be a bare and uninhabitable desert; with it the far-reaching hills and dales have made

homes for 20,000,000 sturdy and independent people, and are capable of sustaining many times that number.

Of the 45,000,000,000,000 cubic feet of water annually distilled from the clouds, perhaps a half is returned to the air through evaporation; this tempers the atmosphere and acts as a blanket retaining the warmth of the day throughout the night; a part of it forms dew which sustains vegetation, while a larger part drifts away to maintain that atmospheric condition and circulation on which the habitability of the region depends no less than the direct precipitation. About a quarter of the aggregate rainfall is absorbed by the earth or consumed in chemic changes, chiefly connected with growing plants. The remaining quarter gathers into streams, of which the larger are navigable; and all parts of each river system from its sources in the forest-clad Appalachian ranges to its mouth are interdependent of the 10,000,000,000,000 or 12,000,000,000,000 cubic feet of water annually flowing from this greater Appalachian region into the sea. More than half flows through navigable channels—it forms the sole and entire basis of interstate and intrastate waterway commerce throughout what may be called the waterway states; and it virtually controls the interstate commerce on the bordering rivers—the Ohio and the Mississippi. Many primitive peoples worshiped rivers and imputed to them supernatural attributes; even within our own times some regard them as mysterious in their movements

and wholly beyond human control; but with advancing conquest of the earth's surface, the mystery of rivers has been cleared away, and their origin and growth no less than their uses are coming within everyday knowledge. Today the commercial and industrial values of our running waters can be appraised and controlled about as definitely as those of our lands.

In a state of nature the slopes of the land, the texture of the soil, and the vegetable cover are brought into adjustment during ages in such manner that most streams flow fairly clear, and in fairly uniform volume throughout the year—there is a general equilibrium or balance extending all the way from the hillsides on which the storm-waters gather to the coast where the flow returns to the sea. When the rain falls on a forest the beating drops are broken into spray which soaks gently into the mulch or trickles down the trunk and roots into the earth; the moisture seldom collects in gully-making rills, but forms a ground-water which soaks deeply, to finally reappear as clear springs or seepage in the banks and beds of the spring branches. Over prairies the sward in time grows so tough as to resist the beating of the storm, while the grass helps to retain the moisture and reduce run-off, with attendant gulying; yet in a state of nature the slopes of prairie-lands are always gentler and flatter than those of woodlands, in which the surface is better protected from the elements. In both types of surface (and in all intermediate types) the final or optimum condition toward which all the agencies tend is one in which nearly all of the precipitation soaks into the earth to form a ground-water, leaving little run-off on the surface; in which condition springs abound, floods seldom reach great heights, and the streams are seldom dry or even low in summer or between storms. In this condition there is little soil erosion, and comparatively little scouring of beds, building of bars, or shifting of channels in the lower reaches of the rivers. Judging from the best geological data

available, the annual soil-wash from the 400,000 square miles of what may now be called the Appalachian states was less than 75,000,000 tons, perhaps less than 50,000,000 tons annually; while the range from high to low water in the mill streams, and even in such rivers as the Tennessee, Cumberland, Alabama, and Savannah, was not such as to interfere seriously with control for power in the upper reaches or with navigation in the lower reaches.

The effect of settlement throughout this region has been, as elsewhere, to distribute the natural equilibrium or balance, whereby both the soil and its cover and the running waters are controlled. It is everyday knowledge that springs have failed in thousands; that spring branches have run dry; that it has become necessary to deepen wells; that brooks once clear and fairly uniform throughout the year now run muddy when they run at all, and range from destructive torrents after storms to trifling rivulets during droughts; and that the utility of the upper reaches for power and the lower reaches for navigation has been greatly reduced. The reason is now a commonplace of daily knowledge: The leading factor is deforestation of the uplands, whereby the surface is exposed to the elements, and the storm waters gather in torrents, cutting gullies, flooding bottoms, carrying debris over the lowlands, and choking the channels even of the larger rivers. Next in gravity is thoughtless farming, so conducted as to expose a thin layer of friable soil to storms, whereby the fields are gullied and impoverished, and the richest and most soluble portions of the soil are swept away—to accumulate in the lower reaches and either bar navigation or compel expensive dredging to maintain it. The change from the natural condition cannot be measured without extensive observations and surveys; yet any one familiar with the region and observant of the changes of the past quarter century must estimate that the annual soil-waste is at least doubled and that the range from freshet stage to low water is increased from fifty to

over 150 per cent. in different localities, or an average of probably 100 per cent. throughout the entire area. Undoubtedly even the bordering rivers—the Ohio and the Mississippi—have suffered an increase in range materially affecting both navigation and general industrial development. Nor can any one familiar with the region and acquainted with those natural processes whereby soils are formed, vegetal covers produced, and uniformity of streams maintained fail to see that the damage is increasing in a geometric ratio, the loss during each decade averaging twice that of the decade before; nor can he fail to foresee that unless the present tendencies are checked much of the Appalachian upland will be reduced to barren rock, the soil of the

lower hills swept away, and in precisely the same measure the headwater streams reduced to storm torrents, and the lower river channels converted into sand washes, like those of the arid region, or capricious volumes and mud-laden waters, utterly useless for navigation and impossible for terminals. Recent river work proves beyond all question that the value of a river for navigation depends no less on its sources than on the character of its channel; that the river system is a unit from headwaters to mouth; and that in such rivers as those heading in the Appalachian region it will be impossible to maintain navigation in the lower reaches without protection of the mountain slopes and the myriad springs whence the waters flow.

PRESERVE THE SOIL

Dedicated to Dr. W J McGee

By JOHN A. JOYCE

THE rolling hills and mountains
 Without their forest dress
 Will soon bring to the nation
 Great hunger and distress,
 And if we do not listen
 To the scientific strain
 The soil of grand Columbia
 Will be washed away by rain.

Brave Nature in her glory
 Works for animated things
 And tells the old, old story
 Of feeding serfs and kings,
 But man obtuse and greedy
 Will not listen in his pain
 To the poor and weak and needy
 Who must live by sun and rain.

We must save the soil and water
 Or a desert there shall be,
 For wife and son and daughter
 In this Land of Liberty;
 And the Congress of the nation
 Must now listen to the brain
 Of our scientific sages
 Who would husband soil and rain!

BOOKS ON FORESTRY

THE movement to study and preserve our forest trees instigated within the past few years has stirred up more than usual interest, not only among those whose business interests are concerned, but among the American people at large. Forestry to-day is the most important consideration in the general plan of conserving our national resources. To care for the vast timber tracts and to reforest the thousands of acres bared by former mismanagement is the proposed work that will bring greater results than any other national effort ever made in our country. And an issue of this sort gives rise to the usual literary danger—a multiplicity of books offering little practical return for the price paid for them.

When a book on trees is advertised it usually finds a ready market. And as such publications entail illustrating necessarily expensive, the cost per volume is much above that of the average book. And many of these books are very disappointing. One recently published, with a very seductive title, generalizes to such a liberal extent that *Ginkgo* and Southern Yellow Pine are introduced as representative conifers. In a way, this is true; but put in this manner, the truth is misleading. The *Ginkgo* is a geological curiosity and has a romantic story; but the long-leaf pine of the South means millions of dollars annually. This little book mentions eight species of pine (two of these being exotic) and there are thirty-nine

species of commercial value in the United States. And I did not see a single species of the many Western oaks described in its pages. Clearly a book of this kind means little to the real forest student. What he requires is a book covering these topics:

1. A list of our forest trees.
2. Botanical descriptions.
3. The definite locality of trees listed.
4. A statement of their value.

And with the last consideration comes the outlook that concerns us as a nation: Investigating sylvical conditions. Are our forests sufficiently studied, cared for, and preserved? Can waste tracts be reforested? The very nature of underbrush and shrubs, and even weeds and grasses, often help and suggest, or seriously hinder reforestation. The writer on subjects pertaining to forestry must be a broadly educated teacher. He must know that elementary training in any field should be sharply accurate, and very much to the point if successful instruction is sought. And it must be persistently borne in mind that long before the tree becomes *timber* it is a *plant*. The *tree* is *cause*; the nicety of the lumberman's calculation, the rise and fall of prices, the Nation's tremendous utilization of forest produce, is *result*.

It might therefore be suggested to all who would promote the study of forestry (and the study should be promoted even in our primary schools), to write, to recommend, and to buy books on the subject with care.



A BEGINNER IN FORESTRY

By ANNE WARNER

Paper Three

I MEANT to write an article on the beginnings of German forestry, but I must defer that until I can get some books, as the only book which goes far back, in my present library, is one which tells how Bavaria, under the Agilolfinger, was divided—not by woods—but into cleared districts or plain land. It's very interesting to read, but doesn't bear much relation to our subject—unless, indeed, one goes out of his way to wonder if, perhaps, America won't be divided into plains and cleared spaces herself before long. I suspect that the forest is such a menace to new society, and such a problem to settlers, that its destruction is simply a rule of economics, which each nation has to solve summarily in the beginning. They all solve it pretty much the same way, too. And then comes the same result.

In lieu of a nice story about the When and Where, I am forced to offer this time a riddle which racked our brains and which may be simpler to others, but is still complex to me.

Yesterday we were all in the woods, and there we came suddenly upon one of the most wonderful sights which I have ever seen. It burst upon us quite unexpectedly, and stopped us short. There we stood—"we" being the women, two men, a small girl, a donkey and a poodle—and this is what we saw:

An enclosure about 100 by 200 feet. Around it posts five feet high, with a wire running on top. Below the wire a wide-meshed net, pegged to the ground occasionally (not so often as "semi-occasionally," but rather quadri-occasionally, I should say). In a few places the net was carefully tied to the

wire above. There was something so naive and childlike about the whole treatment of the net—something which led us to hold the poodle from diving under it—something which savored of the wickedness of picking the pockets of a sleeping friend. No one would have willingly desecrated the purpose of the net, and all that troubled us was that it was so hard to guess its purpose from its behavior, that we hesitated for fear of doing so.

And, after all, the net was only the frame of the rest of the riddle. Within the guarding net were long rows of stout twigs, each with a bit of twine tied to its top. The bits of twine were about eight inches long, and each had an old rag tied to the other end. The little rags all waved in the breeze. Two of the twigs were crowned with odd bunches of dead leaves tied up in old cloth; two others were crowned with tin cans; in the center of the whole an old umbrella was carefully pegged down.

Nothing so weird and mysterious was ever seen before. Some one who had never been in India, said it made him think of an Indian graveyard, and some one who had never known a ghoulish said it looked ghoulish to her. We all stood and wondered for a long, long time, and the only opinion hazarded was that it was to catch rabbits. In view of the laxness of the net, this might sound absurd, only that we have learned by experience that the Lichtenberg ideal of a trap is very novel indeed. The mouse traps here are two-storied, with a window upstairs. After the mouse is caught, he leans in the window—literally on his elbows, for I've seen one caught—and as soon as the

trap is set down, he jumps gaily out and runs home. Such being a mouse-trap, the tastefully looped net looked as much like a rabbit-trap as anything. Susy suggested that the bits of rag might have been dipped in something of which the rabbits liked the odor.

So we stood for a long time, contemplating the curious whole, and then we tore ourselves away and went home to ask questions.

The forester, whom we asked, said that it was all a wood nursery—the rags wave birds away, and the net keeps out the rabbits. His statement was final, so now we simply wonder. It is impossible to disbelieve or doubt, but one may still wonder. I should like a dictionary that would elucidate the umbrella—even a glossary as to why peg or why not peg, would help a little.

But whatever they put down or tie up in this careful land, still one must give the most unqualified praise to the results. The trees are aflame now, and even the continual rain of gold cannot disturb the calm and beautiful order of the German forest. Every wide and imposing avenue is carpeted with yellow and brown, and on either side, stretching endlessly, lies the same fair, soft covering. I don't know when the work is done—we never see or meet a man. The gutters are latticed neatly to keep the leaves from choking the covered ways, the piles of firewood grow steadily greater, the troughs are kept spaded clean, the roads are mended with a skill that puts our countryways of dust and pebbles to eternal shame—and yet one sees no one. They must do it all early, early in the day. Or else it is gnomes. I am so glad that

I believe in fairies, dryads, and the whole blessed troupe of woodfolk. It makes me better and happier, more full of reverence for the green Heaven, which is so much nearer than the blue one, and more trusting and hopeful that if we prove worthy the kind little creatures will come our way soon, build us big, wide, hard roads, and open all their treasure-sacks for those two precious factors in society—the poor and the generation to come. Germany is so thoughtful for both of these; the village is getting in its firewood daily now, and over there, beyond the open pasture, are trees that will grow until 1950, while the net over which we looked, laughing, hedged in the trees that will ward away the sun from the weary-footed of 2100.

And to think that all this beauty and order is fixed and changeless. That it is not a problem, but an answer. I began with a riddle because, like all seekers for knowledge, I find riddles easier than their reading—but I end with an answer for one of the world's greatest questions—a question which Germany has answered. And answered in such a splendor of perfection, for out of the royal generosity of its good, practical purpose, the German Government's forestry not only pays profit as an investment, but feed health, strength, and happiness into all its people. And not only in its people, but into the stranger within its gates. When I think that in Napoleon's day these trees were being guarded for me to walk beneath this year!—

(There is a moral which belongs right here, but no one likes morals, so I'll leave it out.)



TREES IN THE PHILIPPINE ISLANDS

ONE cannot realize the richness of the tree flora of the Philippine Islands until he is told that there have already been found over 2,000 kinds in the Philippine Islands. This means more to the average person when it is known that here there are probably three times as many varieties as have been found in the United States. When all is known concerning the tree flora of the Philippines, it is probable that this number will reach 3,000. Of course, it must be stated that all of these are not used commercially. It is estimated that 150 of them are on the market at the present time. Many of the 2,000 are too small to ever be of any great importance commercially.

About one-half the area of the Philippine Islands, or 60,000 square miles, is in public forest. Of this 60,000 square miles, more than one-half is in mountainous regions, and will not yield, at the present time, much wealth to the Philippines. Indirectly they are of very great importance, for upon them will depend the conservation of moisture, so necessary to extensive irrigation schemes. Less than half of the 60,000 square miles can be classified as forest which will yield commercial varieties of timber. A rough estimate will place the yield of this forest close to 40,000,000,000 board feet. If this could be placed on the market to-day, at the price of our cheapest timber, it would bring a total of two and a half

billion pesos. Of this two and a half billion pesos of wealth, the Bureau of Forestry is the guardian. It is the object of this Bureau to have the wealth utilized as rapidly as it can be without danger to the forests. It is believed that about four times the present amount used can be exploited without endangering our forest. This would bring the annual amount of timber put on the market, from 100,000,000 board feet, the present amount, to 400,000,000 board feet. This would leave 300,000,000 board feet to be exported from the Philippine Islands, and thus bring to the islands considerable wealth.

Included in the 1,800 or more comparatively unknown woods now reposing on herbarium sheets in Manila, and bearing scientific names but no information of commercial importance, are many which will, in time, and after investigation, prove valuable.

The rating of the relative values of this assortment of trees; the distinguishing between those commercially valuable, and the others; the testing of those which have been selected as commercially desirable, to ascertain their strength and fitness; the supplying of merchants and engineers with specimens and information and the directing of all concerned how to obtain the maximum good with the minimum waste from our wooded lands—these are a few of the problems which daily confront the Bureau of Forestry of the Philippine Islands.



INCREASE IN 1907 LUMBER CUT

FIGURES of the lumber cut in 1907, compiled by the Bureau of the Census and the Forest Service, showed the largest total ever reported in the United States, exceeding

complete than ever before. The figures disclose some interesting facts.

In 1907, 28,850 mills made returns, and their production was over forty billion feet of lumber. This is believed to

Table I.—Production of lumber by states, lumber cut 1907-1906

States	1907	1906	Per cent. increase from 1906
	<i>M. feet</i>	<i>M. feet</i>	
Washington.....	3,777,606	4,305,053	- 12.3
Louisiana.....	972,119	2,796,395	6.3
Texas.....	229,590	1,741,473	28.0
Mississippi.....	694,485	1,840,250	13.8
Wisconsin.....	003,279	2,331,305	- 14.1
Arkansas.....	988,504	1,939,368	8.1
Michigan.....	827,685	2,094,779	- 12.7
Pennsylvania.....	734,729	1,620,881	- 7.0
Minnesota.....	660,716	1,794,144	- 7.4
Oregon.....	635,563	1,604,894	1.9
North Carolina.....	622,387	1,222,974	32.7
Virginia.....	412,477	1,063,241	32.8
West Virginia.....	395,979	976,173	43.0
California.....	345,943	1,348,559	.2
Alabama.....	224,967	1,009,782	21.3
Maine.....	103,808	1,088,747	1.4
Kentucky.....	912,908	661,299	38.0
Tennessee.....	894,968	634,587	41.0
Georgia.....	853,697	831,675	2.6
New York.....	848,894	810,949	4.7
Florida.....	839,058	888,137	5.5
New Hampshire.....	754,023	539,259	39.8
South Carolina.....	649,058	566,928	14.5
Missouri.....	548,774	507,084	8.2
Ohio.....	529,087	438,775	20.6
Idaho.....	513,788	418,944	22.6
Indiana.....	504,790	447,808	12.7
Vermont.....	373,660	329,422	13.4
Massachusetts.....	364,231	354,483	2.7
Montana.....	343,814	328,727	4.6
Maryland.....	213,786	219,098	.4
Iowa.....	144,271	163,747	- 11.9
Illinois.....	141,317	141,374	.0
Oklahoma.....	140,015	49,737	181.5
Connecticut.....	140,011	124,880	12.1
Colorado.....	134,239	110,212	21.8
New Mexico.....	113,204	103,079	9.8
Arizona.....	72,134	56,960	26.6
Delaware.....	50,892	44,487	14.4
New Jersey.....	39,942	36,253	10.2
South Dakota.....	34,841	22,634	53.9
Rhode Island.....	32,855	21,528	52.6
Wyoming.....	17,479	13,213	32.3
Utah.....	14,690	7,768	89.1
All others.....	5,891	1,170	3,365.3
Total.....	40,256,154	37,550,736	7.2
Mills reporting.....	28,850	22,388	28.8

- Indicates decrease

by over seven per cent. the cut reported for 1906, until then the record year. This does not necessarily show a larger actual cut than in 1906, for the returns obtained last year were more

include ninety-five per cent. of the actual cut. In 1906, 22,398 mills reported about thirty-seven and one-half billion feet. Since, according to these figures, nearly twenty-nine per cent. more mills

Table II.—Lumber Cut, by States, 1907

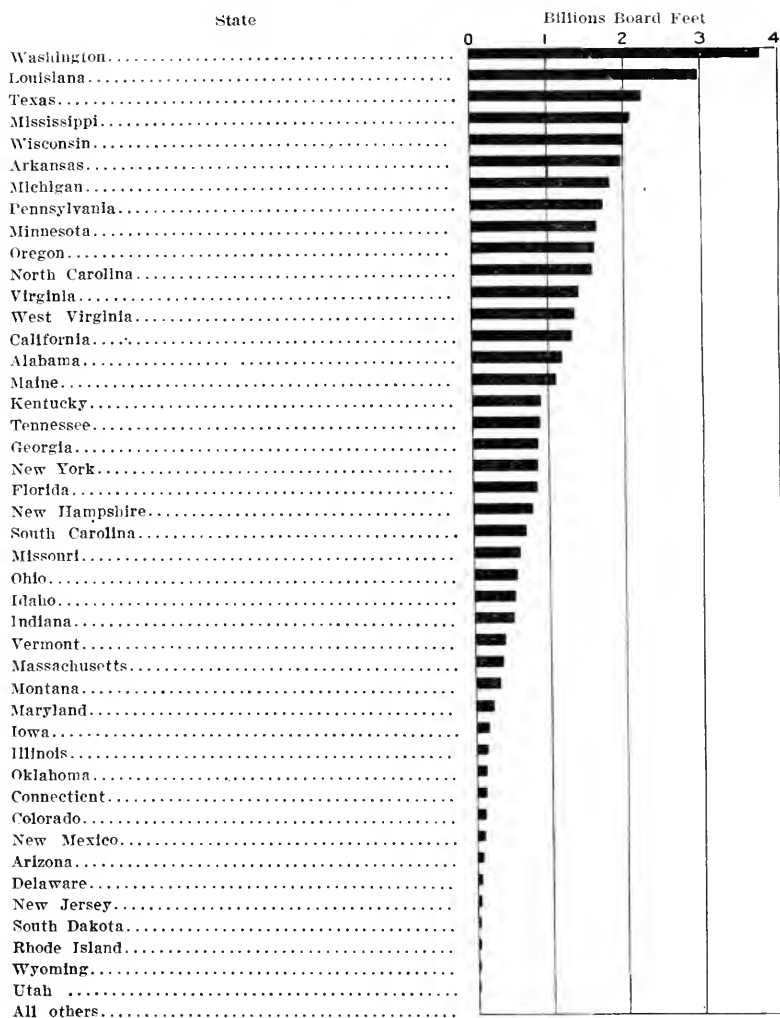

reported last year than the year before, while the increase in production was only a little over seven per cent., it might be thought that the amount actually manufactured must have been greater in the earlier year. This, however, would be a too hasty inference, for it is almost wholly among mills of small individual output that the gain in the number of establishments reporting has been made.

A classification of the returns by states and regions throws additional light on the situation. Individual changes, as, for example, the remark-

able rise of Texas from eighth to third place among the lumber-producing states, are doubtless accounted for primarily by the greater accuracy of the 1907 figures; but in the majority of cases the advances and declines can be traced to specific influences.

Before the year closed the general business depression was severely felt in the lumber industry. It was not, however, the most important cause of a falling off in the production of the year where a falling off occurred. For decline in production took place only in certain regions. The South is the

region of greatest activity in lumber production, and yellow pine the most important wood, forming thirty-three per cent. of the entire cut of the country. The cut of yellow pine reported shows an increase of thirteen per cent. over that of 1906. In the early part of the year many of the southern mills cut so heavily that, in spite of the curtailed

this group of states as the most important source of lumber supply. Since southern pine is abundant in all the Atlantic coast states from the Carolinas to Texas, the region as a whole will doubtless maintain its leading position for some years, in spite of the fact that at the present rate the bulk of the timber will be gone in another decade; but

Table III.—*Production of lumber, by kinds, 1907-1906*

Species	1907	1906	Per cent. increase from 1905
	<i>M. feet</i>	<i>M. feet</i>	
Yellow Pine.....	13, 215, 185	11, 661, 077	13.3
Douglas Fir.....	4, 748, 872	4, 969, 843	- 4.4
White Pine.....	4, 193, 787	4, 583, 727	- 8.5
Oak.....	3, 718, 760	3, 820, 333	- 31.8
Hemlock.....	3, 373, 016	3, 537, 329	- 4.6
Spruce.....	1, 726, 797	1, 644, 987	.5
Western Pine.....	1, 526, 116	1, 386, 777	10.0
Maple.....	939, 073	882, 878	6.3
Poplar.....	865, 536	677, 670	27.7
Cypress.....	757, 639	839, 276	- 9.7
Red Gum.....	689, 200	453, 678	51.9
Chestnut.....	653, 239	407, 379	60.4
Redwood.....	569, 450	659, 678	-13.7
Beech.....	430, 005	275, 661	55.9
Birch.....	387, 614	370, 432	4.6
Basswood.....	381, 088	376, 838	1.1
Cottonwood.....	290, 574	269, 458	8.0
Elm.....	260, 579	224, 795	15.9
Ash.....	252, 040	214, 460	17.5
Cedar.....	251, 002	357, 845	-29.9
Larch.....	211, 076	166, 078	27.1
Hickory.....	203, 211	148, 212	37.1
White Fir.....	146, 508	104, 329	40.5
Sugar Pine.....	115, 005	133, 640	-13.9
Tamarack.....	113, 433	123, 395	- 8.1
Tupelo.....	68, 842	47, 882	43.9
Sycamore.....	46, 044
Walnut.....	41, 490	48, 174	-13.9
All other.....	80, 973	164, 845	-50.8
Total.....	40, 256, 154	37, 550, 736	7.2
Mills reporting.....	28, 850	22, 398	28.8

--Decrease

output which followed the business disturbance later, the total was greater than ever before. But in both the Lake States and the Northwest a smaller cut was reported than for 1906, though the number of mills reporting increased.

In the Lake States the falling off evidenced the waning supply of white pine. Michigan, which for many years led all the states in lumber production, and then gave way to Wisconsin, sank in 1907 from fourth to seventh place, while Wisconsin went from third to fifth. Minnesota as late as 1905 held fourth place. Last year it went from seventh to ninth. It was not until the latter nineties that the South displaced

in totals of production by individual states the leadership has since 1905 been held by Washington.

The figures of production show that during 1907 Washington fell off very decidedly from its huge cut of 1906, while its sister state Oregon, is credited with a slight increase in its total. In the early part of the year Washington suffered from a car shortage, and at the end the combined effects of business disturbance and higher freight rates had brought the industry almost to paralysis. Oregon kept up its cut because of its larger proportion of coastwise and foreign trade. These two states together produced more lumber

Table IV.—*Lumber Cut, by Species, 1907*

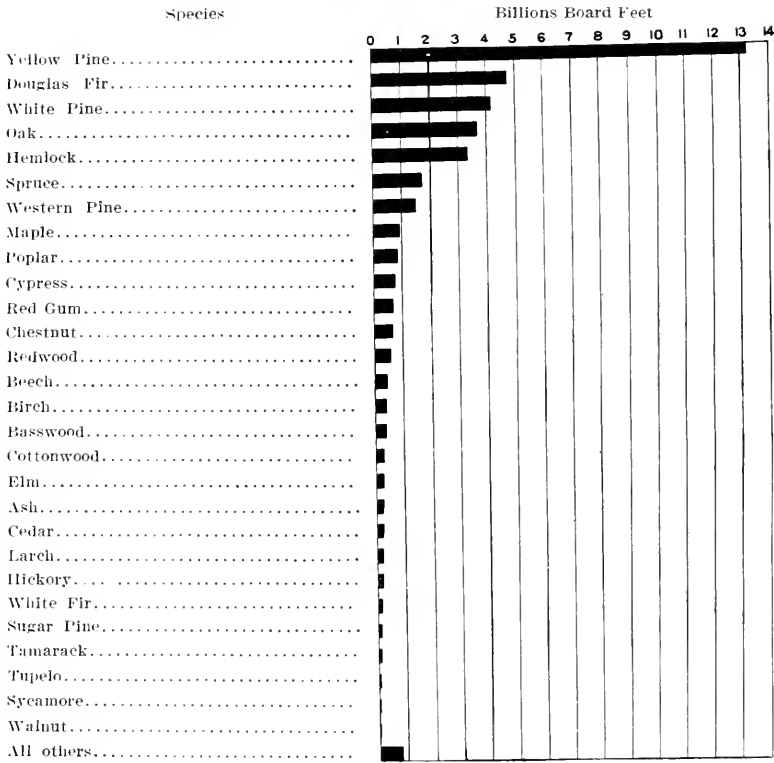

than any other two states in the Union. It is a striking fact that though lumber prices have been steadily going up during the last half-century, the per capita consumption of lumber has also been going up. In 1850, according to the best figures obtainable, the average

consumption to each person in the country was 250 feet; in 1900, 460 feet; and in 1907, 480 feet. This illustrates what has been found true the world over—that with industrial progress the demand for wood becomes greater and greater.



FOREST SCHOOL NOTES

YALE FOREST SCHOOL

ONE of the important features of the Yale Forest School is its summer work in Pennsylvania. The school has a fully equipped plant for field instruction at Milford, Pa., located on the estate of the late Mr. James W. Pinchot who was very much interested in this work and contributed generously to its establishment and support. Attendance at a summer session at Milford is required of a regular junior class of the Forest School. This term is given at the beginning of the course. The work during this term comprises Field Surveying, Forest Mensuration, Forest Botany, and Silvics. The instruction is largely in the field.

The Forest School has conducted at Milford also a short course in forestry designed for woods superintendents, prospective forest students, and others who wish to obtain a short general course in the subject.

During the past summer there were in attendance at Milford forty-six men taking the regular junior work and sixteen men in the short course.

The fall term has opened with a substantial increase over the preceding year in the number of students. There are registered seventy-one students in the regular department and seventeen men from other departments of the University taking special work at the Forest School.



Yale Summer Camp, Milford, Pa.



Yale Summer School of Forestry

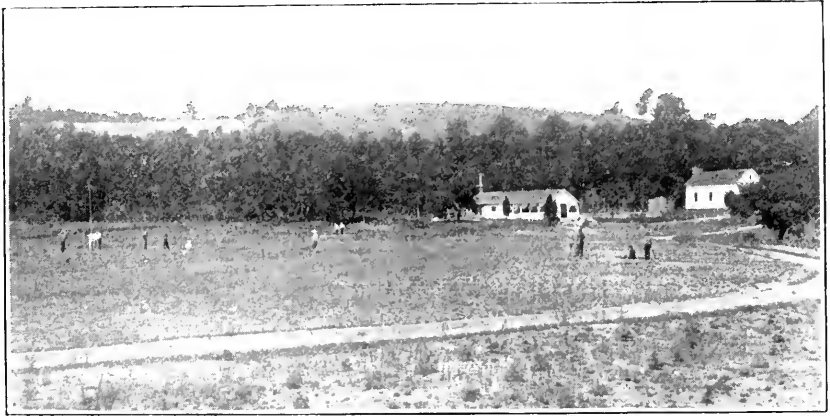

Class Surveying at the Summer School



Students Taking Tree Analyses

The new catalogue of the school shows a number of new courses which very substantially enrich the curriculum. The Forest School now affords an opportunity for advanced post-graduate work along special lines. Hitherto the course has been prescribed and there has been little opportunity for specialization. There is now, however, beginning to be a demand at Yale for post-graduate work by grad-

uates of forest schools who wish to specialize in certain branches. A number of advanced courses are now offered and there will be a distinct development of instruction along this line as rapidly as the circumstances warrant it. The new courses are chiefly in subjects related to Silviculture, Forest Management, Forest Products, Engineering, and Lumbering.

PENNSYLVANIA STATE COLLEGE, DEPARTMENT OF FORESTRY

THE Department of Forestry of the Pennsylvania State College has added an assistant in the person of Mr. John A. Ferguson. Mr. Ferguson, who takes up his work on September 1, as an assistant in the Department of Forestry, comes originally from Canandaigua, N. Y. He received his preparatory training at the Canandaigua Academy, and was graduated from Hamilton College with the class of 1896, receiving a degree of A.B. In 1903 the same institution conferred upon him the degree of A.M.

Upon graduation from college, Mr. Ferguson began teaching in the Brooklyn Polytechnic Institute at Brooklyn, N. Y., and continued this work at Fond du Lac, Wis. For several years he was instructor in Science at Rutgers College Preparatory School, New Brunswick, N. J. In July, 1906, Mr. Ferguson entered the Yale Forest School and was graduated in 1908 with the degree of M.F. While in Yale, Mr. Ferguson assisted Professor Tracy, of the Sheffield Scientific School, in Surveying, and later assisted Professor Chapman, of the Yale Forest School, in field work carried on by the senior class of the Forest School

in Alabama. During the summer of 1907, Mr. Ferguson was a log scaler with the Pigeon River Lumber Company, of North Carolina. Upon completion of the course in Yale Forest School, he entered the United States Forest Service, and spent the summer season of 1908 upon the Boise National Forest with headquarters at Boise, Idaho.

Mr. Ferguson comes to the college with unusual training, and his connection with the Department of Forestry will mean a great deal in the development of that work in this college.

Prof. Hugh P. Baker, of the Pennsylvania State College, Department of Forestry, writes:

"Since the opening of our school year, we find that we have between fifty-six and sixty men classified in our four-year course in forestry. These men are divided as follows: Senior year, four men; Junior year, eight men; Sophomore year, fourteen men; Freshman year, thirty men.

Our forestry society, which was organized last year, has held two meetings, with an attendance of forty to fifty at each meeting."

COLORADO SCHOOL OF FORESTRY

ALTHOUGH forestry in this country is comparatively a new science, the progress that has been made is wonderful. The foresters were in the beginning chiefly young men who had been trained according to the principles in vogue in Europe, and the conditions are so different in this country that these principles had to be considerably modified to meet our own needs. Practically all the first work was necessarily of an experimental nature. Of course, mistakes were made, yet under the conditions it is gratifying that there were not more.

In a country of nearly 4,000,000 square miles, with climatic conditions varying from those of the tropics to those of the arctics with regions of abundant rainfall and others of practically no rainfall, with bare rocky mountains, broad fertile valleys, and extensive plains, and with forests richer in species than those of any other coun-

try of similar latitudes, it is indeed a problem to work out the varying needs of the forests and the relation of these forests to the country. Hampered by public opinion, restricted by insufficient appropriations, and, above all, with a decided lack of trained men to carry on the work, the progress that has been made in forestry in this country is certainly beyond all expectations. But under the guidance of competent leaders, who were untiring workers and men of remarkably keen foresight, the fundamental principles which should guide the work have been derived with exceptional rapidity.

The people have been taught the necessity of preserving the forest, and public opinion no longer stands in the way of progress. We have learned this lesson well. We have also learned much about the care of the forest yet this lesson is far from done. In the matters of adequate appropriations and



Students Making Growth Studies

a sufficient force of trained men to carry on the work we are still far behind. For a proper administration of the forests larger appropriations and more trained men are needed in both the National Government and the state governments. More men are needed to carry on research work, work in education, work to bring the forests into a state of sustained productiveness, work to reforest the denuded forest lands, and work to guard the forests against fire and trespass.

the field that is open to the great majority of trained men.

For obvious reasons instruction in all fields has developed more and more toward the laboratory method, and especially is this true in technical education. No technical school to-day would think of graduating men who have not had a thorough opportunity to work with the actual materials that form the constructive elements of their profession. Perhaps there is no other branch of education in which the neces-



Forest Growth Near Manitou

A number of schools for preparing men for these tasks have been established. Many of them restrict their field to special studies intended only to meet specific local needs. A few have complete courses for training professional foresters, and these are doing an exceptionally high grade of work. The majority of graduates take up their work with a showing of ability seldom met in the man just out of a technical school. It is unfortunate that up to the present time so little really adequate instruction has been given in the West,

the majority of graduates take up their work with a showing of ability seldom met in the man just out of a technical school. It is unfortunate that up to the present time so little really adequate instruction has been given in the West, the majority of graduates take up their work with a showing of ability seldom met in the man just out of a technical school. It is unfortunate that up to the present time so little really adequate instruction has been given in the West,

the majority of graduates take up their work with a showing of ability seldom met in the man just out of a technical school. It is unfortunate that up to the present time so little really adequate instruction has been given in the West,

and under the new scheme of administration which distributes about one-half of the force formerly located in Washington to branch offices in the West, over seventy-five per cent. of the Forest Service employees are located here. Furthermore, as the great need for men is in the field, the majority of new men are sent to the West.

With the West as the great field of operation, is it not unfortunate that so relatively few of the men who will find their lifework here do not have the

National Forest, and within a half-hour's ride by rail from Colorado Springs the Forest Service maintains one of the largest forest nurseries of the region. Through the courtesy of the Forest Service the students of the school of forestry are allowed to study the work that is being carried on in the National Forests, thus increasing the opportunities for a thorough field preparation and placing the student into direct contact with the work for which he is preparing himself.



Lumbering at Manitou Park

opportunity to use the forests of the West as a laboratory. The conditions of the country and of the profession make the demand for a good school of forestry in the West almost imperative.

In 1905, Gen. William J. Palmer laid the foundation for such a school at Colorado College by presenting the college with a tract of 13,000 acres of yellow pine forest near Colorado Springs in the heart of the Rocky Mountain Reserve Region. The tract is known as Manitou Park. It is surrounded on three sides by the Pike

Manitou Park is under the direct supervision of the School. Logging and milling operations are now being carried on with a small portable mill, such as is common throughout the mountain districts. All cutting is done according to strictly scientific principles, with the result that there is an abundant young growth to cover the cut-over areas. During the past year an experiment station has been established in cooperation with the Forest Service for the purpose of studying the effect of different methods of treating mountain

forests. This should aid materially in the solution of problems that are now in doubt.

Although the regular course at the Colorado School of Forestry at first covered only three years, it has now been extended over four years and two summers, and graduates will be awarded the degree of Forest Engineer. In order to bring the school up to a very high standard, as well as to limit the number of students, the requirements will be made very strict and no student will receive a degree who is not a thorough master of his work.

The directors also believe that forestry as a profession has become so

broad that no one man can become expert in all its various fields and that the time has come when some provision must be made for specialization. Plans are now under way whereby the students at the Colorado School of Forestry will be given an opportunity to specialize in connection with their work.

In many ways the opportunities for a good school of forestry at Colorado College are unexcelled and the directors of the school are making every effort to increase the endowment and to develop the school to its fullest capacity to meet the needs for which it was established—a school that can train men in the field where they will work.



MOTHER

By ELEANOR VAN ALLEN

O MOTHER Earth!—to whom we all return
 And on whose breast we calmly lie asleep.
 As in our earlier days, we slept in other arms;
 Hold lightly thou, lightly and warm and close,
 Rocking us gently, sweeping 'mid the splures;
 Tho' we lie near or far from those we love,
 Guard thou our ashes, tenderly and long;
 Far from our anguish and our keenest joys,
 Deeply enmeshed by roots of things to be
 Ah! let us sleep—mourn, covered o'er with winter snows,
 Cradled amid the Universe, till Spring shall come with flowers.

ORIGIN OF THE RESERVOIR SYSTEM IN THE UNITED STATES

By THAD. C. POUND

WHAT is known as the reservoir system was projected primarily for the improvements of river navigation, other anticipated benefits being regarded as incidental. Subsequent observation and experience have proven other results of equal value. The employment of this system presents three distinct benefits, either of them justifying the expenditure required to construct, operate, and maintain the works required.

First.—By the erection of dams upon the headwaters of navigable rivers, for the creation of vast reservoirs in which to impound and control the superabundance of waters produced by rains and melting snows in the springtime, disastrous floods occurring annually may be restrained. The destruction of property from such cause is beyond estimate, while the loss of human life has in many instances been appalling.

Second.—Those vast bodies of water so stored and controlled may be discharged as required during the low-water season, so as to maintain an equable volume for navigation.

Third.—By thus controlling and regulating the flow of water, improved water-powers upon the rivers and tributaries constituting an interest of great and increasing value, will be rendered safer and operated with greater regularity and efficiency. Engineering demonstration and actual use have already established the practicability and value of the reservoir system and placed it beyond the experimental stage.

The initial legislative movement toward the inauguration of the reservoir system was made at the special session of the Forty-fifth Congress, in the year 1877, by Representative Thad. C.

Pound, of Wisconsin, in the presentation and adoption of the following joint resolution:

“Be it resolved by the Senate and House of Representatives of the United States of America, in Congress assembled, that the Secretary of War be, and hereby is, requested to make such preliminary examination of the headwaters of the St. Croix, Chippewa, and Wisconsin rivers, in the States of Minnesota and Wisconsin, as is consistent with his service to determine the extent and practicability of reservoirs upon the same, and report to this Congress the result of such examination, together with a compilation of all information and reports in his office bearing upon the subject of reservoirs, by February 15th proximo, or as early thereafter as practicable, and that he also report the estimated amount and character of the lands which would be submerged by such reservoirs.”

Mr. Pound was prompted to take this action by reports theretofore submitted to Congress by the War Department, relative to examinations and surveys of the sources of the Mississippi in Minnesota, and the practicability of constructing reservoirs thereupon for the improvement of navigation of the Mississippi River, the “Father of Waters.”

The work required by this resolution was promptly undertaken, and by authority of Congress, continued to completion upon the rivers named and other sources of the Mississippi. So encouraging and satisfactory were the results as submitted by the War Department to Congress, that an appropriation of \$75,000 was made June 14, 1880, for the construction of an experi-

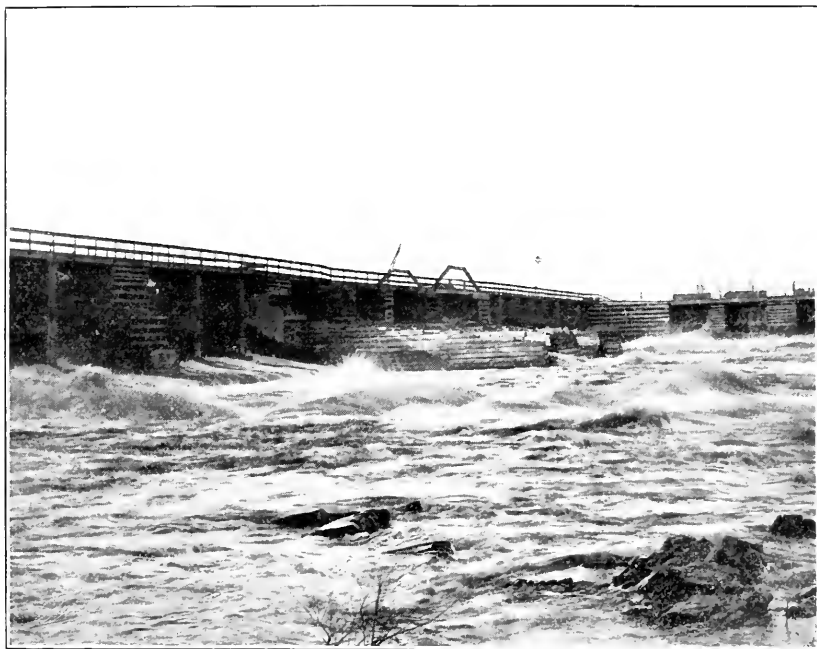

Little Falls Dam, on the Chippewa River, Wisconsin

mental dam and reservoir, and a further appropriation of \$150,000 March 3, 1881, and again \$300,000 August 2, 1882, to prosecute the work on the dams and reservoirs in the State of Minnesota, and to begin work on the Chippewa River and tributaries in the State of Wisconsin, upon which sites for thirteen dams had been selected and the Government lands required withdrawn from sale. Subsequent appropriations have been made for continuing work on the sources of the Mississippi in Minnesota, resulting in the completion of five dams and reservoirs, about completing the system in that state. As a consequence, good navigation is established from Brainerd to Grand Rapids, a distance of eighty-two miles, this being above Minneapolis, while the benefit to navigation below St. Paul is of great value. Floods are restrained and water-powers benefited, although some dissatisfaction has been expressed by owners of water-powers relative to the management and operation of the works.

It is to be regretted that this great work has not been prosecuted as con-

templated on the Wisconsin tributaries, which contribute to the Mississippi River a volume of water greater than that flowing in the main river at St. Paul. Provision had been made for beginning the work upon the Chippewa River in 1882, but was defeated for the reason that lumbermen and loggers declined to comply with the requirements of the Government to safeguard against claims for damage growing out of charters granted by the state for dams and other privileges. In consequence the river has since been at the sole service of lumbermen for log driving and storage, and its navigation for steamboats from its mouth to Eau Claire and Chippewa Falls, a distance of sixty miles, suspended—a use it had served from the earliest settlement of the Chippewa Valley.

Conditions are now radically changed. Log driving below Chippewa Falls has ceased, and the dams and reservoirs for flooding and driving logs are about to be abandoned. Conditions are now most favorable for the Government to begin the work abandoned in 1882, restore and improve navigation for steam-



Dam Site on Chippewa River, Wisconsin, at Brunett's Falls

boats and other craft, and yield to the Mississippi River the benefit of the regulated waterflow of this river. The lands withdrawn from sale hitherto, have been sold with reserved rights of flowage. The estimated cost of the works contemplated for and upon the Chippewa and branches, submitted by the Government engineer is \$325,000.

The Chippewa River unites with the Mississippi at the foot of Lake Pepin, after a course of 267 miles, one of its sources extending to within twenty miles of Lake Superior, the total fall of the river being 900 feet. The drainage of the river commands an area of 9,573 square miles, occupied by countless springs, and more than 100 lakes, large and small, many of which may be utilized for reservoirs.

This vast area of 6,000,000 acres, much of which was once forests, embraces in most parts as fine agricultural lands as can be found anywhere, adapted to cereals, vegetables, fruits, and grasses. For dairying and stock

raising they are not excelled. With the present population of 200,000, settlement is rapidly going forward.

The value of the water-powers upon the Chippewa River and tributaries cannot be measured. To undertake the enumeration and description of these varied water-powers would weary the reader or listener. It is worthy of note, however, that the east branch, the Flambeau, supplies a larger and more uniform flow of water than the main Chippewa, its drainage area being 2,120 square miles, and average discharge about 4,000 cubic feet per second. Of the numerous water-powers upon this branch the most available undeveloped power is located near Big Falls, four miles north of the Soo Railway, a fifty-foot fall being obtainable. It may be truthfully stated that the territory embraced in the drainage of the Chippewa River may be made to sustain a population of 10,000,000 inhabitants. Similar conditions exist upon the St. Croix and Wisconsin rivers.

With the sources of the Missouri River wisely utilized by reservoirs, a six-foot channel in the Mississippi may be assured as far as Dubuque, where it would contribute to and be supplemented by the systems employed for improvement of navigation extending

the entire length of the Mississippi to New Orleans.

Added to this great achievement would be prevention of disastrous floods and development of the water-powers, the value of which cannot be overstated.

View of Dam Site on Flambeau, Tributary of Chippewa River, Wisconsin, at Big Falls





SCENE IN KERN RIVER VALLEY

The Edison Electric Company Is Erecting a Power Plant in This Valley which Is Expected to Develop
a Minimum of 50,000 Kilowatts



FLOOD DAMAGE IN THE SOUTH

Railroad Track Washed Away for over Half a Mile; Waters Piled Logs of Driftwood in the Cut Twelve Feet above the Grade on the Nolichucky River, Tennessee



SPECIMEN OF LONG-LEAF (YELLOW) PINE

Showing the Lower Part of the Trunk Damaged by a Forest Fire. The Upper Part, However, Is Making Vigorous Growth. Picture Taken near Ocilla, Georgia

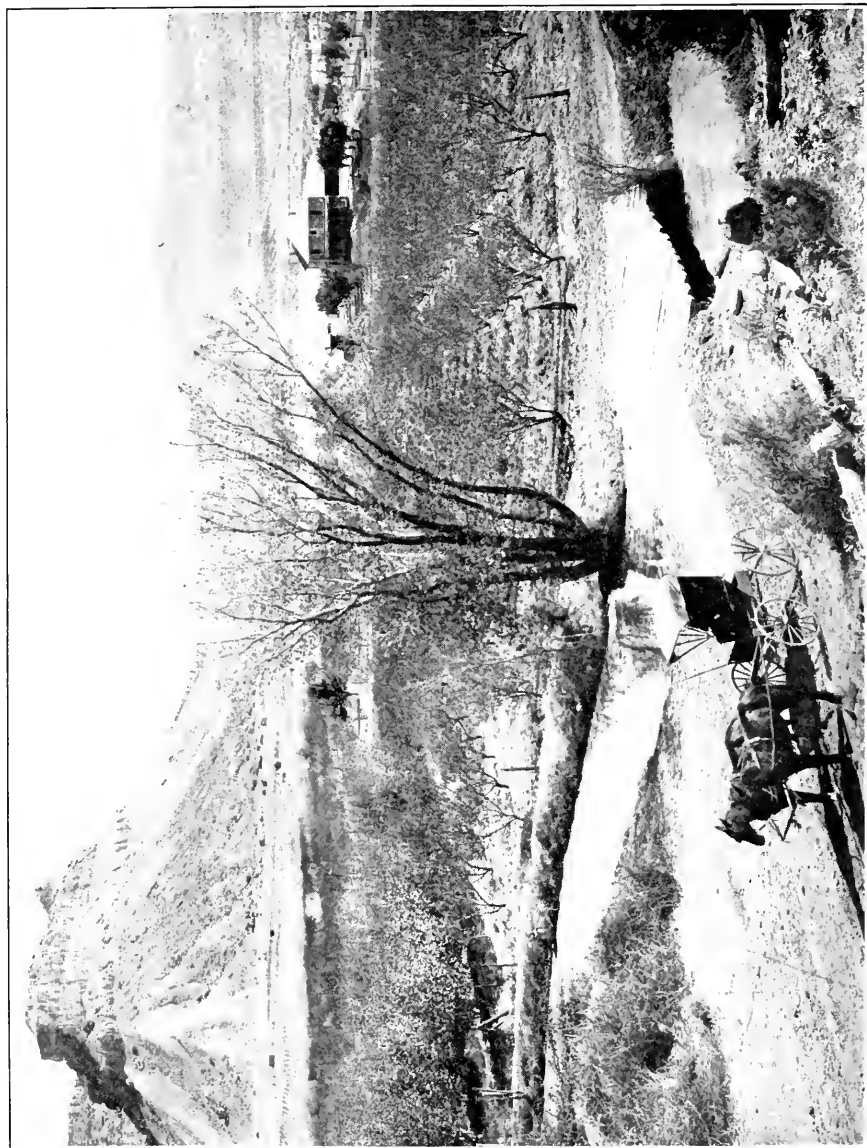

IRRIGATION IN THE WEST

Fruit Farm near Grand Junction, Colorado, on the Line of the Denver and Rio Grande Railroad. Irrigated Peach Orchard, with a High Protecting Butte and Mesa at the Back

THE FOREST HOLOCAUST

How the Press of the Country Comments on the Recent Forest Fires— A Symposium on the Destruction of Our Standing Timber

RECENT issues of CONSERVATION have had much to say in regard to the wholesale destruction of forests and the appalling losses brought by fires throughout the entire country. Following is a symposium, gleaned from the columns of the daily press, on this subject. There is little to be added to the expressions herein contained; but, for the information of those of our readers who may have thought that CONSERVATION has been unduly exercised over the matter of losses by forest fires, we have taken the trouble to get together these extracts. They are enlightening, if for no other reason than that they show clearly the ever-widening sentiment in favor of safeguarding the forests; but, besides this, they show unmistakably that this magazine is not alone in recognizing the danger that threatens our timber supply.

FERTILITY OF SOIL BURNED OUT

In an article in the *Pioneer Press*, of St. Paul, Thomas Shaw recently called attention to the vast loss to agriculture caused by the series of forest fires that swept northern Minnesota and urged the need of better protection of the forests, as advocated by the American Civic Association. Mr. Shaw wrote:

"The real loss is far greater than any estimate shows, based upon the amount of timber consumed and the value of the property of the settler and the houses and improvements of villages and towns. The greatest loss, probably, is one that is never taken into account—the loss of young tress and the loss in humus.

"After one of these terrible conflagrations has swept over a timber slashing not a living thing of vegetation is left. Nature has to begin again the work for furnishing protection for the naked earth; years must elapse before the traces of the dreary desolation are hidden. The farmer who returns to rebuild his home upon the ashes is without material for building or fencing, and soon he is without material for living, except what he buys.

"But the loss of humus is a far greater loss. The vegetable matter so abundant on the surface of the soil in a new country is devoured by the flames. The top soil with all that it contains is turned into ashes. For two or three years good crops may follow because of the abundance of ashes lying over the soil, but the stimulating effect of these is soon lost. The area thus burned over will not recover what it lost by such a conflagration in a score of years, or in a period much longer."

NEED NATIONAL FIRE DEPARTMENT

There is a general demand for the establishment of a national fire department which, in a systematic and efficient way, shall keep guard over the forests. With losses aggregating tens of millions of dollars in the amount of lumber destroyed, with scores of persons burned to death, with hundreds made homeless and with all the serious damage to the soil, this is a grave question, but there ought be no hesitancy in getting to work.

"What this country needs is a national fire department," urges the *San Francisco Globe*. "Recent reports of

forest fires throughout the United States, and particularly in the West, where timber is most valuable, have been alarming, almost appalling.

"The actual destruction wrought can hardly be computed in figures, and the mental anxiety and physical suffering endured by thousands of persons in towns and villages touched by fire is incalculable by any human measurement. California has been one of the worst sufferers. Her famous trees narrowly escaped destruction and thousands of square miles of valuable timber land were burned. In Washington, Oregon, Nevada, Montana, Dakota, Minnesota—all through the Northwest—vast forest fires have raged.

"These things ought not to be. Yet, what is being done to prevent them? Nothing."

"What this government needs, and what the exigencies of the situation demand, is a fire department for the entire nation; a body of men trained and equipped to the last degree to fight the fires which are consuming the country's timber; a department provided with special trains and which can be transported from place to place upon the shortest notice, regardless of time and careless of expense. It would be costly, but look at the untold millions it would save yearly. A forest may be burned to the ground in a day, but it takes a hundred years to grow."

CANADA URGED TO PROTECT FORESTS

In urging Sir Wilfrid Laurier, the Canadian Premier, to advocate a policy for the preservation of the Dominion timber lands, the *Toronto World* declared in a recent editorial:

"For years the *World* has advocated the promulgation of a new and comprehensive forest policy upon advanced scientific lines, securing adequate protection of the growing timber from fires, the harvesting only of mature timber and the protection of the younger growth and the reforestation of the sections already denuded and unfitted for agricultural use.

"Experts all agree that the world is

within measurable distance of a timber famine and the conditions in the United States particularly are causing grave anxiety to all public men who have given the question attentive consideration. Nor is it alone the result of the denudation of the old forest lands in creating a shortage in the supply which has to be faced.

"Denudation of mountain ranges and wooded areas has a very important bearing upon the character of the streams and rivers, and upon the climatic and soil conditions. When the ground is forest-covered the water-courses are not liable in the same degree to sudden changes in volume. Rivers rise and fall gradually and disastrous floods are much less likely to occur. Forests hold the water and help to feed the springs whose existence is so necessary in many parts of the country, and looking to a new and extraordinary value now associated with water powers, their maintenance at sufficient volume throughout the year, and from year to year, must become a question of increasing importance and urgency.

"The time has arrived for the dominion and the provinces of Canada possessing valuable forest lands to protect the present and future interests of the people in these assets and their responsible governments can find no better way of laying posterity under obligation."

PINCHOT'S WARNING

Calling attention to the warning sounded by Gifford Pinchot, chief of the United States Forest Service, the *Chicago Post* said recently:

"Forest fires in Wisconsin, Minnesota, and Michigan are destroying millions of dollars' worth of standing timber and are menacing a score of villages with destruction. The states individually, by adopting the government's system of protective patrols now in service in the Federal forest reserves, can prevent the repetition of the disasters of the present year.

"Gifford Pinchot, the government's chief forester, said, less than six months

ago, that at the present rate of consumption of timber the end of the American forests as sources of supply of good material would come in twenty years. The warning was based on a study of conditions in every part of the United States. The fires that have been in progress since the present period of drought began have been the most damaging in a quarter of a century.

"If adequate protective measures are not taken the limit of twenty years' life set for the woodlands will be cut in half. If prompt action is taken, even in view of the great losses of the year, the forests may be preserved for all time."

WHAT FOREST FIRES SIGNIFY

"If the people of Minnesota and neighboring states had taken in earnest all that has been said of late about conserving our natural resources, they would have done something to prevent these calamitous forest fires or to make them less destructive. Probably if an attempt had been made to obtain an appropriation from the Minnesota legislature for a sufficient number of men to patrol the forests during the more dangerous part of the year, it would have met with failure—have been called a useless and extravagant expenditure.

"But a comparatively small outlay would have cut down to insignificant figures a fire-loss which is in the millions. Wisconsin had one great forest fire more than thirty years ago; if it were to have another, the fault would rest with a state government which failed to adopt preventive measures."—*The Chicago Tribune*.

PREVENTION OF FOREST FIRES

"The prevention of forest fires is really the most strenuous problem that confronts the department of the government concerned about increasing the forests of the United States. It will take a great deal of replanting every year to overcome the ravages which

are worked by these fires. In a night a forest fire may burn up more wood than would supply half a state with lumber.

"One who has not traversed the vast pine forests can't realize what are the dangers that constantly menace such forests, especially in the belts where summer droughts are long protracted and severe. There is always a lot of deadwood and dried grasses in which the sparks from locomotives and the fagots from the careless campers find lodgment and start great conflagrations. The railroad companies seemingly take every precaution. They plough furrows and they burn over strips on which sparks are apt to fall, but all these precautions often go for naught. One way in which the dangers from railroad locomotives might be overcome is by the use of oil for fuel instead of coal. Oil as fuel means that no sparks are scattered over the country. Many railroads now use a very soft coal and sparks and cinders are thrown out in vast quantities. There ought to be some way of preventing such dangers."—*The Republican*, Cedar Rapids, Iowa.

FORESTRY AS AN INSURANCE

"Forest fires in the Mesaba range, Minnesota, which wiped out the town of Chisholm and destroyed more than \$5,000,000 worth of property, were fed largely by the tangle of deadwood and brush which had accumulated in years of forest neglect. The intensity of the average forest fire is due to similar conditions. Improved forestry prevents such timber heaps. It costs money for labor to clear the woods of brush and to remove fallen trees and deadwood, but such work does something more than save all the living powers of the soil for the growing trees. It prevents the accumulation of fuel with which to feed sweeping flames. Is it not worth while? The value of forestry as an insurance against fire loss is capable of mathematical demonstration."—*The Boston Herald*.

PUNISHMENT FOR CARELESS PERSONS

"One of the things that the state should not neglect in the next session of the legislature is the passage of laws for the safeguarding of the forests so that they can be protected from fires, and so that men who ruthlessly and intentionally set fire to such forests can be sufficiently punished.

"It appears to be an accepted fact that these fires are the result of carelessness, or spite, or ignited by men who hope to make money by fighting them. All of these causes are sufficient to invite attention and severe punishment. It is a subject that the state must handle with a strong hand."—*The Republican*, Scranton, Pa.

LOSS NOT ONLY UPON FOREST COMMUNITIES

"It takes one hundred to four hundred years to grow such trees as have made up the great forests of Michigan, which have disappeared in large measure; but they can be destroyed in a day. It is estimated that the great fires which have swept over the remaining forests of portions of the State in the last twenty days have destroyed \$40,000,000 worth of timber. As we have reached the point where the cost of lumber must be measured by the cost of replacing the forests with new growth, it will be appreciated that this loss does not fall upon Michigan alone."—*Rockford (Ill.) Gazette*.

LOSSES ARE IRREPARABLE

"This is bad news from Maine which tells of great fires in the forests. The meaning will be better understood when it is remembered that the great Maine woods constitute the only reserve of timber of any real consequence in this part of the country. Every inroad upon it is irreparable, so far as the present generation is concerned. The case is bad enough when the ax and saw are wielded recklessly, but at least we have the use of the timber. Fire simply de-

roys; the great tracts burned over are a total loss."—*The Providence Bulletin*.

CANNOT AFFORD FOREST FIRES

"Aside from the enormous amount of property destroyed by forest fires, we cannot afford to have such inroads upon the timberlands. We need all the woodland we have, and more. Some means will have to be devised to stop this fearful and needless waste."—*The Schenectady (N. Y.) Gazette*.

LESSON FOR STATESMEN

"The need for forestry patrol is being greatly emphasized by the fires that are devastating the timber lands. Those eminent statesmen who voted against the President's measures probably now realize how little wisdom and how much selfishness there was in their course."—*The Omaha Bee*.

HOW MICHIGAN VIEWS ITS LOSSES

"Millions of dollars' worth of timber has been destroyed in the forest fires and the damage in 1908 represents a great deal more in dollars and cents than did the memorable conflagrations in 1871, because lumber is much dearer now than then. In 1871 practically the only merchantable timber was pine; the era of the hardwoods had not arrived. Now the forest fires inflict heavy pecuniary damage when they sweep off acres of maple and oak as well as pine."—*Saginaw (Mich.) News*.

REPLANTING WILL COST A FORTUNE

"Estimates of the losses caused by forest fires in the territory of the northern boundary have been placed at \$40,000,000 by Prof. Filibert Roth, of the Forestry Department of the University of Michigan, who has returned from a visit to the burned regions. He said that more than a million acres of good timber lands have been devastated. It will cost \$5 an acre to replant this land."—*Detroit Free Press*.

NEWS AND NOTES

Forest Service Personnel in Six New Field Districts

THE names of the 377 foresters, clerks, and stenographers who are to make up the personnel of the United States Forest Service Headquarters of the six districts into which the National Forests have been divided, have just been announced. The district foresters' offices, located in Denver, Colo.; Ogden, Utah; Missoula, Mont.; Albuquerque, N. Mex.; San Francisco, Cal., and Portland, Oreg., will open on December 1.

The new field organization of the Forest Service will greatly facilitate the use of the National Forests by the people. It will mean that the National Forest business which formerly was transacted in Washington will be handled by officers on or near the ground. The establishment of the district headquarters is the culmination of a plan toward which the Forest Service has been working steadily since it took charge of the National Forests.

Each National Forest District will be in charge of a District Forester. The work at district headquarters will be distributed among four offices—Operation, Grazing, Silviculture, and Products—each equipped with men of special training for the work of their office.

The Office of Operation will be charged with responsibility for the protection of National Forests, for the building of roads, trails, and other permanent improvements upon them, for the organization of the force on National Forests, and with the supervision of all business relating to the special use of National Forest resources. The Office of Silviculture will have supervision of the free use and sale of timber from National Forests, forest planting upon them, and will conduct forest

studies on National Forests as well as in cooperation with private owners in the District. The Office of Grazing will supervise grazing business in the District, except for the actual fixing of allowances, periods, and rates, and will make studies looking to the improvement of the forage crop on National Forests. The Office of Products will make both independently and in cooperation with private owners, studies leading to a more profitable use of timber on and off National Forests within the District and to their preservative treatment.

From the District Foresters down, the personnel of the District offices is made up of men picked for their proved capacity, for their thorough training, and for their experience in the West. Most of them are men who not only have worked in the West after they entered in the Service, but who lived in the West before they took up the Government forest work. Many of them are men who formerly were employed on the National Forests and have been promoted to larger responsibilities as a result of their high efficiency. The personnel of the District offices, which has just been announced, is as follows:

District One Including: Montana, Northeastern Washington, Northern Idaho, Northern Wyoming, and Northwestern South Dakota. *Headquarters:* Missoula, Mont. *W. B. Greeley, District Forester;* F. A. Silcox, Assistant District Forester.

R. H. Rutledge, Chief, Office of Operation; R. Y. Stuart, Assistant Chief; J. P. Martin, Chief Engineer; E. W. Kramer and T. L. Day, Engineers; E. B. Quiggle, Chief, Section of Occupancy; P. J. O'Brien, Claims Clerk; J. E. Keach, Settlement Clerk; C. O. Wilhite, Uses Clerk; H. I. Loving, Fiscal Agent; O. M. Wold, J. A.

Urbanowicz, Miss Grace M. Curtin, and P. S. Gray, Accounts Clerks; R. L. Campbell, Chief, Section of Maintenance; Miss Belle G. Warren, Miss Lydia Jacobi, Miss J. L. Farnsworth, Clerks; Gordon Guptill, H. F. Tripp and Mrs. L. H. Bryan, Draftsmen.

C. H. Adams, Chief, Office of Grazing; W. S. Perrine, Assistant Chief; Miss B. Todd, Clerk.

W. R. Wheaton, Chief, Office of Products; F. I. Rockwell, Assistant Chief; Miss Eva Slocum, Computing Clerk.

A. W. Cooper, Chief, Office of Silviculture; D. T. Mason, Assistant Chief; E. I. Terry, Chief, Section of Silvics; W. T. Stone, Assistant; E. O. Clifford, Chief, Section of Planting; W. M. Aiken, Law Officer; S. J. Humeston, Assistant Law Officer; J. F. Preston, J. D. Warner, J. A. Fitzwater, G. B. MacDonald, K. W. Woodward, W. B. Piper, L. S. Murphy, J. St. J. Benedict, E. D. Fletcher, and P. R. Hicks, Forest Assistants; F. X. Salzman, A. J. Norton, and W. T. Cott, Lumbermen; C. W. Gleason, R. P. McLaughlin, J. W. Streit, and J. D. Jones, Land Examiners; C. B. Swim, Assistant Land Examiner; H. M. Booth, C. A. McElroy, and C. J. Sullivan, Expert Miners.

The following have been assigned to the stenographic work in this district: Misses F. L. Sinclair, E. M. Linell, Florence Kelly, Bessie C. Shimman, B. M. Gray, H. E. Kearney, Eva Ammen, Mathilde Ammen, Mrs. L. K. Locke, Floy K. Riley, Otto Greenwald, and C. E. Gage.

District Two Including: Colorado, Southern Wyoming, South Dakota, Northwestern Minnesota, Nebraska, Western Kansas, and Southeastern Utah. *Headquarters:* Denver, Colo.; *Smith Riley, District Forester:* P. G. Redington, Assistant District Forester.

Fred W. Morrell, Chief, Office of Operation; C. J. Stahl, Assistant Chief; R. E. Mesnard, Chief Engineer; Nile Hughel, Engineer; Fred Lees, Chief, Section of Occupancy; C. F. Folloh, Claims Clerk; Mrs. Anna L. Riordan, Settlement Clerk; G. W. Holland, Uses

Clerk; W. R. Fuchs, Fiscal Agent; F. C. Thompson, W. A. McKenzie, Miss Alva von der Linde, and W. C. Stump, Accounts Clerks; J. W. Dilly, Chief, Section of Maintenance; Miss Gertrude L. Kimmel, File Clerk; Mrs. Rosa C. Pennebaker, Assistant File Clerk; Miss Nettie M. Kimmel, Mail Clerk; C. B. Gosorn, C. B. Noyes, I. I. Tayloe, and Mrs. Stella W. Munce, Draftsmen.

J. W. Nelson, Chief, Office of Grazing; E. N. Kavanaugh, Assistant Chief; Miss Anna P. Koschwitz, Clerk.

C. L. Hill, Chief, Office of Products; G. R. Ogier, Assistant Chief; W. L. Stockton, Computing Clerk.

A. K. Chittenden, Chief, Office of Silviculture; S. L. Moore, Assistant Chief; C. G. Bates, Chief, Section of Silvics; W. D. Edmonston, Assistant; L. C. Miller, Chief, Section of Planting; G. S. Arnold, Law Officer; J. M. Cates, Assistant Law Officer; J. Bentley, Jr., R. W. Allen, G. P. Bard, R. G. Pierce, H. B. Holroyd, A. L. Heim, T. Lyons, and J. A. Silsbee, Forest Assistants; W. R. Davey, and H. S. Bushnell, Land Examiners; G. H. Gustafson, H. Gregory, Wm. Darley, and F. W. Blatt, Assistant Land Examiners; George P. Gregg, W. R. McKinnon, and J. S. Baird, Lumbermen; T. A. Curry and F. Sherwin, Jr., Expert Miners.

The following have been assigned to the stenographic work in this district: Misses Ethel M. White, Hilda Rosenquist, Stella Hooper, P. Womack, Lura M. Holcomb, Cary L. Hendricks, Sue Hayward, May Wise, Ermina E. Weaver, Anna Mellan, Eva L. Gay, Lillian E. Wessler, Mabel Berry, Hattie Felder, Lena A. Daniels, and Marguerite T. Waters.

District Three Including: Arizona, Arkansas, New Mexico, and Oklahoma. *Headquarters:* Albuquerque, N. Mex. *A. C. Ringland, District Forester:* E. H. Clapp, Assistant District Forester.

A. C. Waha, Chief, Office of Operation; R. G. Willson, Assistant Chief; E. H. Jones, Chief Engineer; H. H. Harris, Chief, Section of Occupancy; Oliver C. Phillips, Claims Clerk; Miss K. M. Riley and G. Griffin, Settlement

Clerks; W. D. Wheeler, Uses Clerk; J. J. Duffy, Fiscal Agent; William Rose, A. Morris, Miss M. L. Hobgood, and Mrs. E. V. Steely, Accounts Clerks; W. B. Bunton, Chief, Section of Maintenance; Miss Mary Latimer, File Clerk; Miss Cornelia Glase, Assistant File Clerk; Mrs. Ruth Harris, Mail Clerk; E. R. Thompson, Chas. H. Freyer, and Miss Helen B. Smith, Draftsmen.

J. K. Campbell, Chief, Office of Grazing; John Kerr, Assistant Chief; Miss Zuleika Felder, Clerk.

O. T. Swan, Chief, Office of Products; Miss M. A. Bell, Computing Clerk.

T. S. Woolsey, Chief, Office of Silviculture; A. B. Rechnagel, Assistant Chief; W. R. Mattoon, Chief, Section of Silvics; G. A. Pearson, Assistant; A. S. Peck, Chief, Section of Planting; H. B. Jamison, Law Officer; I. F. Eldridge, J. H. Allison, R. L. Rogers, S. G. Smith, and D. N. Rodgers, Forest Assistants; D. W. Adams, and A. L. Wynne, Lumbermen; J. V. Hubbard and Lee A. Harris, Land Examiners; E. H. Corlett, Jr., H. Greene, G. H. Kellogg, and Morton K. McGillan, Assistant Land Examiners; S. L. Gillen and H. N. Johnson, Expert Miners.

The following have been assigned to the stenographic work in this district: Claudius J. Neis, Luther Steward, James T. Markey, and Mrs. B. S. Asquith, Misses Florence Derbyshire, Mary Miller, M. E. Baker, Lillie A. Cheshire, M. A. Shekells.

District Four Including: Utah, Southern Idaho, Western Wyoming, Eastern Nevada, and Northwestern Arizona. *Headquarters:* Ogden, Utah. *Clyde Leavitt, District Forester;* Franklin W. Reed, Assistant District Forester.

R. P. Imes, Chief, Office of Operation; E. H. Clarke, Assistant Chief; A. T. Mitchelson, Chief Engineer; A. L. Herring, Engineer; Timothy C. Hoyt, Chief, Section of Occupancy; Miss N. Huff, Claims Clerk; Miss M. M. Childs, Settlement Clerk; C. S. Brothers, Uses Clerk; Q. R. Craft Fiscal Agent; M. J. O'Toole, J. W. Cook,

H. A. Seip, and Mrs. S. G. Totten, Accounts Clerks; R. E. Connor, Chief, Section of Maintenance; Miss Lillian McDevitt, File Clerk; Mrs. C. J. Kemon, Assistant File Clerk; Miss H. R. Patterson, Mail Clerk; A. G. Sorensen, Miss H. J. Holberg, and Miss A. R. Holberg, Draftsmen.

Homer E. Fenn, Chief of Office of Grazing; A. C. McCain, Assistant Chief; Mrs. J. B. Burnham, and Mrs. M. L. Ring, Clerks.

A. L. Brower, Chief Officer of Products; W. H. Murdock, Computing Clerk.

L. L. White, Chief, Office of Silviculture; O. M. Butler, Assistant Chief; E. R. Hodson, Chief, Section of Silvics; F. T. McLean, Assistant; J. M. Fotherolf, Chief, Section of Planting; W. C. Henderson, Law Officer; C. E. Dunstan, D. C. A. Galarneau, C. P. Wilbur, and L. Crowell, Forest Assistants; D. W. Seery, and D. M. Lang, Lumbermen; W. W. Blakeslee, and G. C. Thompson, Land Examiners; R. Dieffenbach and William Winter, Assistant Land Examiners; B. L. Wheeler, Expert Miner.

The following have been assigned to the stenographic work in this district: V. C. Metcalf, and Misses Anna M. Dow, Judith Fant, H. V. Rittue, Pattie Sanderlin, Ruth Helff, Grace Griswold, Mary E. Moore, Rozelle Lazenby, and Veronica Tegethoff.

District Five Including: California and Southwestern Nevada. *Headquarters:* San Francisco, Cal. *F. E. Olmsted, District Forester;* Coert Dubois, Assistant Forester.

R. L. Fromme, Chief, Office of Operation; Roy Headley, Assistant Chief; F. C. Wales, Chief Engineer; W. C. Nespital and E. E. Leslie, Engineers; B. Franklin Chief, Section of Occupancy; W. F. Gardner, Claims Clerk; Miss E. L. MacFate, Settlement Clerk; B. P. Berger, Uses Clerk; J. S. Swan, Fiscal Agent; Miss Celestine Igoe, Miss E. M. Rea, H. J. Weil, and C. Wiley, Accounts Clerks; A. L. Dahl, Chief, Section of Maintenance; Mrs. V. M. Bain, File Clerk; Miss Mary McDonald, Assistant File Clerk; Miss

Martha Sexton, Mail Clerk; R. E. L. Borgfeldt, J. G. Shumate, Miss E. L. De Valin, and Miss Daisy E. Walker, Draftsmen.

J. H. Hatton, Chief, Office of Grazing; M. B. Elliott, Assistant Chief; Miss Lula E. Haukness, Clerk.

L. E. Hunt, Chief Office of Products; C. S. Smith, Assistant Chief; Miss Carrie T. Montrose, Computing Clerk.

G. M. Homans, Chief, Office of Silviculture; T. D. Woodbury, Assistant Chief; T. R. Cooper, Chief, Section of Silvics; J. H. Foster, Assistant; G. W. Peavy, Chief, Section of Planting; E. A. Lane, Law Officer; T. M. Talbot, Assistant Law Officer; P. T. Harris, Swift Berry, Louis Margolin, Carl A. Kupfer, V. Wulff, G. R. Gesert, and W. D. Dudding, Forest Assistants; S. M. Cross, John L. Lafon, Jr., and J. C. Elliott, Lumbermen; G. L. Duncan and E. C. Hard, Expert Miners.

The following have been assigned to the stenographic work in this district: H. G. Allen, Mrs. Ruth Lyle, and Misses Mary O'Toole, Marjorie Webster, Cora Slicer, Claudine McClinton, F. Keen, M. E. Sherman, Marie Smith, Violet Kidwell, L. M. Jarvis, Annie K. Gardner, Minnie B. Aarons, Bertha M. Brown, and Ella M. Hildreth.

District Six Including: Washington, Oregon, a small portion of Northern California and Alaska. *Headquarters:* Portland, Oreg. E. T. Allen, *District Forester;* G. E. Cecil, Assistant District Forester.

C. H. Flory, Chief, Office of Operation; C. J. Buck, Assistant Chief; W. E. Herring, Chief Engineer W. H. Benton and E. H. Darling, Engineers; W. F. Staley, Chief, Section of Occupancy; D. F. McGowan, Claims Clerk; T. M. Moorman, Settlement Clerk; Frank A. Law, Jr., Uses Clerk; A. H. Cousins, Fiscal Agent; Miss Florence D. Strause, C. C. Brunner, Miss Lucy I. Brader, and Miss Augusta W. Russell, Accounts Clerks; Shirley Buck, Chief, Section of Maintenance; Miss E. J. Bernhardt, File Clerk; Mrs. A. P. Mulford, Assistant File Clerk; Mrs. L. G. Riddell, Mail Clerk; O. E. Haring R.

H. Robertson, G. Hilton and Miss L. W. Cottrell, Draftsmen; Howard K. O'Brien, Chief, Office of Grazing; T. P. McKenzie, Assistant Chief; Mrs. M. L. Joynet, Clerk.

J. B. Knapp, Chief, Office of Products; H. B. Oakleaf, Assistant Chief; Miss Erma F. Bell, Computing Clerk.

F. E. Ames, Chief, Office of Silviculture; C. S. Judd, Assistant Chief; T. T. Munger, Chief, Section of Silvics; J. F. Kummel, Chief, Section of Planting; C. H. Pierce, Law Officer; G. E. Frowbridge, Assistant Law Officer; N. F. McDuff, Dorr Skeels, Max Rothkugel, P. S. Buhl, O. P. M. Goss, and E. B. Starr, Forest Assistants; Wm. T. Andrews and J. P. Hughes, Lumbermen; C. L. Farrar and A. L. Thayer, Land Examiners; W. McBride and T. O. Erickson, Assistant Land Examiners; J. G. Giddings and H. S. Riggins, Expert Miners.

The following have been assigned to the stenographic work in this district: Misses Pearl Shrader, Anna Madsen, Dora Reese, Agnes McNair, Elizabeth Garth, Beulah Westlake, Louise Helmick, K. L. Reed, Clara Gonter, Agnes V. Scannell, Ida Estes, Mrs. M. F. Rule, Florence Wilson, and Mrs. J. R. Anderson.

Association Changes Name

AT THE convention of the Gulf Coast Inland Waterway Association held last month in Columbus, Ga., the name of the association was changed to The Mississippi Atlantic Inland Waterway Association. Duncan W. Fletcher, of Jacksonville, Fla., was elected president.

American Mining Congress

ON DECEMBER 2, 3, 4, and 5 the American Mining Congress will hold its annual meeting, at which will be gathered together the foremost men in all branches of the mining industry not only in the United States, but

throughout the world. The meeting this year will be held in Pittsburg, and among the subjects to be discussed is that of forest preservation, which, the invitation states, is held to be intimately related with mining. The invitations summed up the purport of the Congress thus:

"The main purpose of the Convention is to bring out the opinions and suggestions of all men interested in mining upon such matters as need consideration, in order to arrive at a remedy for any improper condition."

The American Mining Congress has already taken some long steps forward in the matter of forest protection, and it is believed that the deliberations of the Congress at this year's sessions will have an important bearing upon the subject of forest conservation; at least, in so far as it relates to the permanent timber supply for mine uses.

Illinois Votes for Waterway

AT THE National Election on November 3 the people of Illinois voted on the proposition to bond the state for \$20,000,000 for the purpose of constructing a deep-water channel from Lockport, Ill., to Utica, Ill., on the Illinois River. This channel, when completed, is to be a part of the ship canal from the Great Lakes to the Gulf, running through the Chicago River, the Drainage Canal, and the Illinois River to the Mississippi. The proposition to bond the state for \$20,000,000 was carried by a decisive majority, and, so far as the people of the state are concerned, the final word has been said and the canal is authorized.

Forest Receipts in Western Depositories

BEGINNING December 1, receipts from the six field districts into which the National Forests have been divided will be deposited in Western

banks, and the Government has selected the six depositories which are to handle the funds taken in at headquarters of the several new districts. The object of this move, it is announced, is to keep the National Forest receipts in the region in which they originate; the funds will be deposited to the credit of the Treasurer of the United States, but will be available for circulation in the sections from which they are derived. All moneys received from timber sales, permits for stock grazing and for special uses of the various natural resources in the National Forests will be handled in this manner. The depositories chosen, by districts, are: First District, including Northeastern Washington, Northern Idaho, Northern Wyoming, and Northwestern South Dakota, the Western National Bank, Missoula, Mont.

Second District, including Colorado, Southern Wyoming, South Dakota, Northwestern Minnesota, Nebraska, Western Kansas, Southeastern Utah, the Denver National Bank, Denver, Colo.

Third District, including Arizona, Arkansas, New Mexico, and Oklahoma, the First National Bank, Albuquerque, N. Mex.

Fourth District, including Utah, Southern Idaho, Western Wyoming, Eastern Nevada, and Northwestern Arizona, the First National Bank, Ogden, Utah.

Fifth District, including California and Southwestern Nevada, the First National Bank, San Francisco, Cal.

Sixth District, including Washington, Oregon, and small part of Northern California and Alaska, the First National Bank, Portland, Oreg.

The estimated receipts from National Forests for the present fiscal year will approximate \$2,000,000, making the estimated receipts from the six field districts from \$275,000 to \$350,000, and this money, instead of being sent direct to Washington, as in the past, will remain in the country in which it originates, ready for the demands of local circulation.

Arboretum for Cornell University

THROUGH the generosity of an alumnus, Mr. Henry Hicks, of Westbury, L. I., a member of the class of '92, Cornell University, Ithaca, N. Y., is to have an extensive and comprehensive arboretum. The site has already been chosen, and the arboretum will be located in what is known as Cascadilla Ravine, near the university grounds. About twenty acres will be devoted to trees, which will be furnished by Mr. Hicks, and the collection, it is announced, will embrace specimens of practically the entire forest growth of the temperate zone. Mr. Hicks will include in the collection a large number of trees native to Japan and Manchuria, and the arboretum will, therefore, be somewhat in the nature of a testing ground for forest specimens that are comparatively little known in this country. It is announced that planting will be started early next spring.



Resolutions by Carriage Builders' Association

THE following resolution was adopted by The Carriage Builders' National Association of the United States at its Thirty-sixth Annual Meeting at Chicago, October 13-15, 1908.

"The progressive failure of our timber supply, intensified by recent forest conflagrations, the intimate connection between forests on the one hand, and flood prevention, soil conservation, inland waterway and water-power development, with irrigation of arid and drainage and swamp lands on the other, make the question of forest conservation an issue of gravest national import. Success in administration of our national forests contracts in striking manner with failure in the administration of most of our private forests. Experience, home and foreign, proves that intelligent expenditure on forestry is a remunerative investment. The Governors' Conference, the unanimity of the press and the rising tide of approving public sentiment bear increasing tes-

timony to the popular demand for forest conservation. The Appalachian-White Mountain Bill, again passed by the United States Senate at its last session, represents the next step in practical forestry. The Carriage Builders' National Association of the United States, in its Thirty-sixth Annual Meeting assembled, therefore earnestly urges the House of Representatives of the United States certainly and speedily to enact this measure into law at the coming session of Congress."



State Revenue from National Forest Increased

IN ADDITION to the benefits secured by fire protection and by regulations which control the use of timberland and range so as to insure permanent supplies for local wants, the states having National Forests now receive, under the new Agricultural Appropriation Bill, twenty-five per cent. of the gross proceeds derived from the sale of National Forest resources. This amount, according to law, goes to offset any losses to the states through withdrawal of forest areas from taxation, and is devoted to public roads and schools.

Several years ago complaints were made that the withdrawal of timberlands for forest purposes reduced the taxable areas of the states in which withdrawals were made. The Forest Service, quick to see the justice of these complaints, recommended at first that ten per cent. and later that twenty-five per cent. of the gross proceeds from the National Forests should be paid to the states. As a result, the states are assured of school and road funds, doubtless more certainly than they otherwise could have been, since the permanence of the Forest resources is now secured by conservative management. Had the Forests never been established, their resources would undoubtedly have been exhausted by hasty and improvident methods of exploitation, leaving the land wasted and unproductive.

"PAYMENT CONDITIONAL UPON SUCCESS"

SMOKY FIREPLACES REMEDIED

Twenty years' experience in dealing with the above trouble. Thoroughly trained workmen employed. In most cases work can be done without defacing decorated walls and with little inconvenience to the household

Examinations and estimates without charge within 500 miles of New York
Contracts entered into with the understanding that charges are for results

The following are a few of the many thousands who have availed themselves of my services:

Grover Cleveland, Princeton, N. J.
 W. A. Slater, Washington, D. C.
 Mrs. John Hay, Washington, D. C.
 Princeton University, Princeton, N. J.
 Senator Aldrich, Providence, R. I.
 Clement B. Newbold, Jenkintown, Pa.
 University Club, New York
 Union League Club, New York

Hon. Whitelaw Reid
 Hon. Joseph H. Choate
 J. Pierpont Morgan
 John D. Rockefeller, Jr.
 Col. John J. Astor
 George J. Gould
 Henry Clews
 Joseph Pulitzer

U. S. Government for:—
 White House, Washington, D. C.
 U. S. Naval Academy, Annapolis, Md
 McKim, Mead & White
 Carrere & Hastings
 Hunt & Hunt
 Ernest Flagg
 Howell & Stokes

Architects

JOHN WHITLEY

Engineer and Contractor

215 Fulton Street, Brooklyn, New York

Don't Let the Old Trees Die



Before Treatment of Cavities

Young trees may not equal the old ones in size and beauty during your life. Insecticides, fertilizers, bolting, pruning, tree surgery, and cavity-filling are only part of the practical means of restoring sick and dying trees to health and beauty. We examine estates, suggest improvements in planting new stock, and direct the work of saving diseased trees and shrubs. Trained assistants equipped with proper tools are furnished when desired. A booklet entitled "The Care of Trees" is sent on request.



After Treatment of Cavities

H. L. FRUST & CO., The Pioneer Tree Specialists
 Landscape Foresters and Entomologists
 Arlington, Mass. White Plains, N. Y. Stamford, Conn.

SEWAGE DISPOSAL

For Country Estates, Summer Homes, etc., etc.

HAVING NO SEWERS

The whole work done in your own dooryard. No chemicals required. No working parts. No odor nor offense. Little attention, and no cost to operate.

THE ASHLEY SYSTEM

Employs the Natural forces of decay, and Nature's way in anything cannot be improved upon.

We estimate plants for residences.

FREE OF COST—Send for our handsome free booklet of particulars

ASHLEY SEWAGE DISPOSAL SYSTEM

6519 Normal Blvd.

CHICAGO

HOW TO RUN AN AUTO

Are You Interested in Automobiles?

If you are, an early purchase of "HOMANS' SELF PROPELLED VEHICLES" will prove a good investment.

This work is now the accepted standard on the practical care and management of motor cars—explaining the principles of construction and operation in a clear and helpful way, and fully illustrated with many diagrams and drawings.

The presentation of subjects has been determined by consideration of the needs of the man behind the wheel. It is clear and concise in its treatment, and comprehensible to the most inexperienced automobilist, at the same time it is so thorough that the expert will learn much from its pages. Contains 608 pages, over 400 diagrams and illustrations, printed on fine paper, size 5 3/4x8 1/2 inches, with generously good binding. Highly endorsed.



This good book will be sent to any address in the world, postpaid, upon receipt of two dollars, or if desired, will be sent on approval to be paid for after examination.

No money in advance required, sign and return
 Theo. Aude & Co., 63 Fifth Avenue, New York
 Kindly mail me copy "Homans' Auto", and if
 found satisfactory I will immediately remit
 \$2 or return book to you.
 Name.....
 Address.....
 Date.....
 For.....

OPTICAL GOODS



For Short Days and Weak Light

WHETHER out of doors, indoors, at home or in the studio, you must have a lens that works fast. At the best your photographic working day is short at this time of the year. *How short*, is a matter which is intimately connected with the speed of the lens which you are using. Many lenses are fast in theory only; it is impossible to make use of their speed because at full opening they will not cover enough of the plate, for which they are intended, to be of use. It is easy to make a lens fast at the expense of other qualities, such as covering power, definition, depth of focus. But the

Goerz "Celor" Lens

is not made that way. At full opening it covers a larger field with sharper definition, and negatives made with it have a greater depth of focus than with any other lens of equal speed.

The **Celor** is invaluable for groups, portraits and all outdoor use requiring extreme speed.

The **Celor** because of its perfect chromatic corrections, is admirably adapted to the new color photography.

A Suggestion for Christmas

For your photographic friend, we would suggest one of our high-grade lenses fitted with our *accurately* working XL Shutter; a most practical and pleasing gift. Or for general gift giving one of our field glasses.

Write for free catalogue which lists our high-grade Photographic Lenses, XL Shutter, Field Glasses, Anschütz Camera, Gunsight, Telephoto Attachments, etc.

We prefer to supply you through your dealer, but where we have none we do so direct.

C. P. Goerz American Optical Co.

Dept. 3

52 UNION SQUARE, E., NEW YORK CITY

Thorburn's Seeds

We carry a large assortment of seeds of EVERGREEN and DECIDUOUS TREES and SHRUBS, both native and imported, and shall be glad to quote on any that are still unsold.

J. M. THORBURN & CO.

33 BARCLAY STREET

Through to 38 Park Place

Established 1802

NEW YORK

The World's Greatest Poultry Paper

THE FEATHER

Only 50 cents a year

THE FEATHER'S LIBRARY

- No. 1. DISEASES OF POULTRY. By D. E. Salmon. D.V.M. Fully illustrated. Paper, 50 cents; cloth, \$1.
- No. 2. THE FEATHER'S UP-TO-DATE POULTRY HOUSE. Paper, 25 cents.
- No. 3. THE AMERICAN FANCIER'S POULTRY BOOK. Profusely illustrated. By Geo. E. Howard. Paper, 50 cents; cloth, \$1.
- No. 4. PLYMOUTH ROCKS. Colored illustrations. By T. F. McGrew. Paper, 50 cents; cloth, \$1.
- No. 5. WYANDOTTES. Colored illustrations. By T. F. McGrew. Paper, 50 cents; cloth, \$1.
- No. 6. POCKET MONEY POULTRY. By Myra V. Norys. Paper, 50 cents; cloth, \$1.
- No. 7. THE EGG QUESTION SOLVED. By T. F. McGrew. Paper, 25 cents; cloth, 50 cents.
- No. 8. HOW TO GROW CHICKS. By T. F. McGrew. Paper, 25 cents; cloth, 50 cents.
- No. 9. THE HOMING PIGEON. Illustrated. Paper, 25 cents; cloth, 50 cents.
- No. 10. THE FEATHER'S PRACTICAL PIGEON BOOK. By J. C. Long. Paper, 50 cents; cloth, \$1.
- No. 11. MONEY IN SQUABS. Profusely illustrated. By J. C. Long and G. H. Brinton. Paper, 50 cents; cloth, \$1.
- No. 12. THE FEATHER'S PRACTICAL SQUAB BOOK. By W. B. Rice. Paper, 50 cents; cloth, \$1.
- No. 13. PERFECTED POULTRY OF AMERICA. By T. F. McGrew and Geo. E. Howard. Illustrated by Louis P. Graham. Cloth, \$2.50.

SPECIAL OFFER

Our latest book, THE PERFECTED POULTRY OF AMERICA, and THE FEATHER for one year for the price of the book alone, \$2.50.

THE HOWARD PUBLISHING CO.

714 Twelfth Street Northwest

Washington, D. C.

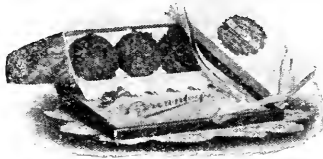

MEXICAN PECAN-OKAS CANDY

Registered U. S. Patent Office

A new candy—original with us—wholesome, satisfying. Made of freshly shelled Pecan Nuts and carefully blended sugars. Rich in nutriment—sustaining—healthful. Pecan Nuts contain practically all of the important nutritive elements. Our blend of sugar adds the necessary properties to make a perfect food. We will send you a box (nearly 2 pounds) any place in the world, all charges prepaid, for a dollar bill mailed at our risk.

BROWNLEY'S, Dept. K, 1203-5 G St. Washington, D. C., U. S. A.

**F. R. MEIER
CONSULTING FORESTER**

1 Broadway, New York

TIMBER ESTIMATES, WORKING PLANS, FOREST APPRAISEMENT, TREE PLANTING, TREE SURGERY

Advice on profitable handling of woodlots, forest tracts, beautifying country estates. Work supervised. Seventeen years experience in the United States.

ORCHIDS ORCHIDS

We are the largest Orchid Growers in the United States.

Our Illustrated and Descriptive Catalogue of Orchids is now ready and may be had on application.

Orchid Growers and Importers

LAGER @ HURRELL
SUMMIT, N. J.

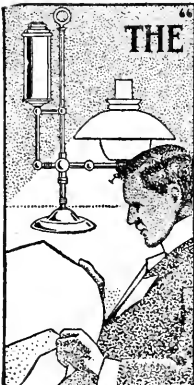

THE "BEST" LIGHT
COSTS 2c A WEEK
Gives more light than
6 Electric Lights or 10 Kerosene Lamps
A brilliant, pure white steady light. Conforms to insurance underwriters' rules.
No Smoke—No Grease—No Odor
Safe as a candle. Send for catalogue. Agents wanted.
Liberal Commission Exclusive Territory
THE BEST LIGHT CO.
Owners of Original Patents.
264 E. 5th St., Canton, Ohio.

Second Edition, Revised, with Additions

Snow—The Principal Species of Wood. Their Characteristic Properties

BY CHARLES H. SNOW
Dean of the School of Applied Science, New York University

Large 8vo, xi+203 pages, figures in the text, 37 full-page half-tones. Cloth, \$3.50

Circular giving complete table of contents and sample pages mailed on request, or the book may be seen at the leading book stores or dealers in architectural supplies

Order through your bookseller, or copies will be forwarded postpaid by the publishers on receipt of the retail price.

JOHN WILEY & SONS
43 and 45 East 19th St., New York City

This Solar can be used in hazy weather, when other Solars are useless. Used by the U. S. General Land Office.

Specifications

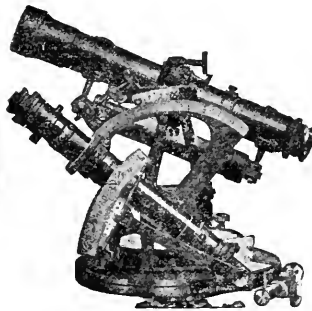

Needle 3½ inches long. Graduations 4¼ inches long, reading minutes. Power of telescope 20 (with splendid definition, good light, and large field). Variation plate. Level to telescope, clamp and opposing screws. Vertical arc. Fixed Stadlairs. Extension Tripod. Solar Attachment on side of standards.

Price Complete, \$300

Telegraph and Code Word, Mountsolar

Illustrated Catalogue Upon Application

YOUNG & SONS Philadelphia

Real Estate, Farms, etc.

The following advertisements of Real Estate, Farm Lands, Timber Lands, etc., are the announcements of reliable firms and agencies. The Advertising Manager of CONSERVATION has investigated the announcements in all cases, and feels safe in recommending the advertisers to the readers of the magazine. The services of this department are free to all members of The American Forestry Association and subscribers to this magazine; advice in regard to the purchase of Real Estate advertised in our pages is gladly given, and our readers are urged to make the fullest use of our services in all matters pertaining to the purchase of advertised Real Estate, of whatever character, no matter where it is located.

VIRGINIA

Rockbridge County, Virginia

offers advantages to the home-seeker equaled by few and excelled by none.

LEXINGTON

the County Seat, is a town of homes; 4,000 people, two large institutions of learning, good high school and graded school. **THREE BANKS** with over a million dollars of deposits, beautiful scenery, healthful climate.

SAM'L B. WALKER, JR.

FARM, MINERAL, TIMBER, COAL LANDS
LEXINGTON, VA.

A VIRGINIA BARGAIN

No. 45.—245 acres strong lime-stone and blue-grass land, situated in a fine section of Augusta County, Va. About 2 1-2 miles from N. & W. R. R., about 5 miles from station on C. & O. R. R., about 2 1-2 miles from a station on B. & O. R. R., and about 9 miles from Staunton. Fronts on main road. Well fenced and well watered, and has about 15 acres of good timber. Land is gently rolling and well adapted to both grazing and cultivation.

IMPROVEMENTS: Large old 12-room residence with spacious rooms and halls, large bank barn 50 by 75 feet, stable under barn for 45 head of stock, large hog-pen, granary, hay-shed, carriage-shed, corn-crib, blacksmith-shop, smoke-house, large hen-house, and other outbuildings. About 5 acres of orchard in good bearing, trees about 15 years old. A good tenant house with 5 rooms. All in all, this is a very desirable place.

Price, \$20,000 00, one-third cash, balance on good terms.

R. W. MENESEE & CO.

Timber Lands and Farms
STAUNTON, VA.

Virginia Country Homes

Grain, fruit, dairy, and blue-grass farms for sale in the best portion of the state. Also timber lands.

Climate, social conditions, and nearness to markets, make this a splendid country in which to locate.

Write for free illustrated register. We solicit correspondence.

H. W. HILLEARY & CO.

Charlottesville, Virginia

VIRGINIA

Farms, City Property
Timber and Mineral

LANDS

A Specialty

*Large Tracts for
Colonization*

International Farm Agency

(INCORPORATED)

900 Main Street

Lynchburg, Va.

Farms and Homes in Virginia

ree from frost 183 days. Plowing season 315 days, growing season 225 days. Why not move to Virginia where you can buy good level land with buildings, timber, fruit, water, etc., at \$8 per acre and up? Best climate, health, markets, transportation facilities, churches, schools, active business life. Our Illustrated Real Estate Herald, with map, tells all about it. Write to-day for free copy.

PLYLE & COMPANY (Inc.), PETERSBURG, VIRGINIA

VIRGINIA INVESTMENTS

J. NELSON GARNETT, Real Estate and Loan Agent, CULPEPER, VA.

High-class Loans and Mortgages our Specialty

Choicest homes and investments of every description in Northern or Piedmont Virginia, the garden spot of the world, and the booming Southland, within sixty miles of Washington. Write for property list and other information.

TIMBERLANDS IN THE SOUTH

We offer timber tracts in Virginia, North and South Carolina, and other sections of the South.

FIRST-CLASS SOUTHERN PINE AND HARDWOODS

The tracts are covered with virgin growths of Southern Yellow Pine and Hardwoods, the timber alone being worth the price asked for the lands. Land is all good farming land after it is cleared. All are within a reasonable distance of Charleston. Particulars on request.

O. H. PERRY TIE & LUMBER CO.
Norfolk, Virginia

FOR SALE

300 acres, Loudoun County blue-grass farm, five minutes walk from railroad station at Leesburg; 2 fine houses, one of 14 rooms, all modern improvements, furnace heat, slate roof. Cost \$18,000 to build, the other house has 8 rooms, porches, and fine barns and out-buildings, all in first-class condition. Price, \$45,000. No. 2—328 acres. Genuine fine-stone blue-grass land. Which is the old home of Admiral Chilton, who was one of the founders of the U. S. Navy. It has a nice house of 13 rooms, and all kinds of out-buildings in first-class condition, all nicely fenced. The water supply is never falling. This farm has been pronounced by the U. S. Government as the best agricultural land in the state for blue-grass and grain. Price \$21,000. Terms, to suit purchaser.

Bulletin sent on application.

J. W. BAUCKMAN & SON
Real Estate Brokers Herndon, Va.

TWO TIMBER BARGAINS

No. 45.—14,000 acres, iron and timber land, in Bath and Rockwell Counties, Va. Second-growth timber, some merchantable; land lies well and is good grazing land for sheep or cattle. \$1.25 per acre.

No. 46.—41,576 acres in Bath, Highland and Augusta Counties, Va. *Best virgin tract of white oak now standing in Virginia.* All easy logging proposition, 10 to 12 miles from C. & O. Ry. Road would have a water grade on Mill Creek—all easy grades. 160,000,000 feet saw timber, 75 per cent. of which is white oak of finest quality, besides tan bark, ties and other timber. Owner would consider offer of \$8.00 per acre.

Prospective Investors, Look This Over!

J. W. Guinn, Goshen, Virginia

Timber Lands, Farms and Summer Resorts

A FINE LOUDOUN COUNTY FARM FOR SALE

This farm contains 169½ acres, 2 miles from Leesburg, 1½ miles from Clarks Gap, on the Southern Ry.; there is about 30 acres of corn on the farm, 20 acres in good woodland, balance in grass; this farm produces well, either for grazing purposes or cultivating; well watered with running streams of water, a splendid spring and dairy house convenient to the dwelling, an 8-room dwelling, with nice shade, etc.

There was about 50 tons of hay made on this place this year. There is an extra fine barn, room for 6 or 8 head of horses and 20 cows, corn house and other out-buildings. This farm has been equipped as a dairy farm and has been run as such until recently, shipping milk to Washington, where there is one of the best markets for milk there is to be found. Any one can run 25 to 30 cows on this farm; by doing so, would have a regular monthly income the year round.

The owner is an old dairy farmer, and offers his services gratis for a week or so to any one wishing to learn the dairy business.

Apply to HAYWARD & BROWNING, Fal's Church, Va.

Handsome Virginia Estates!

No. 172. 1,023 acres almost at the station, 46 miles only from Washington City; 500 acres in blue-grass, 200 acres in timothy and other grasses, 200 acres otherwise cultivated, and 100 acres is timber. Farm lies from ¼ mile to 2 miles from prominent station on the Southern Railway (double track), in good neighborhood. Place well fenced and watered. A fine stream runs through the farm.

A beautiful new mansion of 13 rooms, two bath rooms, 100 feet of porch, all modern improvements, situated in a 10-acre lawn, on an eminence overlooking the whole farm. Splendid shade trees in the yard. There is another new six room house, three tenant houses, five stock barns, etc.; 500 fruit trees in bearing. This will make an ideal fancy stock or dairy farm.

No. 221. 2,200 acres, 3 miles from station, about 30 miles from Washington, about 1,050 acres in cultivation, and the balance in good timber, oak and pine. There are two dwellings and two sets of farm buildings. A splendid stream runs through this place, and is otherwise well watered. Several hundred acres bottom land. Price, \$50,000.

No. 28. 160 acres two short miles from Manassas, 146 in cultivation, and balance in timber. 12-room house, with large halls, porches on three sides. Modern improvements. Large barn and necessary outbuildings. Well watered, etc. Good orchard. For quick sale, price, \$10,000.

No. 231. 405 acres, ¼-mile from depot. 375 acres in cultivation, balance in timber. Well watered, well fenced. Plenty of fruit. Good buildings. Splendid land. 35 miles from Washington. Price, \$20,000.

No. 248. Beautiful Florida home. Nice 12-room house, furnished; orange grove and dairy business, together with cows, other stock and farming implements. Price for everything, only \$3,000. A great bargain.

All the above will make ideal stock or dairy farms. I have other farms for sale, that are smaller and cheaper, but also convenient to railroad. Dairymen are getting now \$2.75 per 100 pounds for their milk, in Washington.

For any further information write,

JOHN A. NICOL

MANASSAS, VIRGINIA

Tall Timber *and* Grazing Farms

I HAVE for sale a 2,300 acre tract of white oak timber (every acre of which is well timbered) four miles from C. & O. Railroad. This is the prettiest, tallest, straightest, biggest and healthiest white oak that can be found in the United States.



It lies comparatively level, all slopes very gently in one direction, thus making it one of the cheapest logging propositions in the country. This tract will cut 12 M feet to the acre and will run 85 per cent. white oak, the balance being poplar and hickory of the finest quality.

For further particulars, address

T. M. GATHRIGHT

*Coal, Iron Ore and
Timber Land*

COVINGTON, VIRGINIA

One hundred sixty-five acres, 9-room house, six 6-room houses, four cattle barns, calf barn, machinery, and every convenience for dairy. Improvements cost \$180,000. Price, \$35,000

ANDERSON REAL ESTATE & LAW CO.
Richmond, Va.

Summer homes, hunting preserves, and farms, in Old Virginia. Write,

W. E. LAWSON
Hampton, Va.

PENNSYLVANIA

Philadelphia Farm Agency

WE represent 800 owners of farms near Philadelphia; where farms are cheaper and markets are better than near any large city in this country. I can sell a good 50-acre farm for \$2,500 to \$4,000. Write and tell us your requirements; we have the properties.

E. H. TRENCHARD, Farm Specialist
1230 Arch Street, Philadelphia, Pa.

Beautiful Summer Home On Trolley Line

110 acres rich soil in high state of cultivation; 9 room house, 2 barns and necessary outbuildings, some good timber, nice orchard, fine stream of water through farm. This farm has never been rented. Owing to the death is offered for sale. It fronts on Meadville Conneaut Lake and Linesville trolley line. About 1½ miles from Exposition Park, Conneaut Lake, and ¼ mile from station on Bessemer R. R.; 1 mile to high school, church, and store. Price, including crops, pair horses, a number of cattle, all tools and equipments, \$6,500. Best bargain offered in Crawford County. For further information, apply to

VET. L. BROWN CO., Timber, Coal and Farm Lands
Rooms 207-8 331 Fourth Ave., Pittsburg, Pa.

Beautiful Country Home

97 acres located southwest of North Alle on Walnut Street ¾ mile from the station. The improvements consist of a finestone mansion, and a large tenant house built of stone. Large store and frame barn, and all outbuildings, spring an spring house, with ram forcing water to the house and barn. Fine stream of water flows through the farm. Fine meadow pasture. All buildings and fences are in order. All crops, stock and implements go with the farm. Price of this splendid farm is only \$23,000. This is one of the finest farms in this section of the country, and cost the owner more than the price asked.

WM. J. WEATON
Farm and Timber Lands Mortgages Negotiated
Estates Managed
49 North Thirteenth Street
PHILADELPHIA

WEST VIRGINIA

FOR SALE

TIMBER AND COAL LANDS. In sizes to suit your pocket-book and handy to market.

STOCKS AND BONDS. Which will net the owner good interest on his money without risk of losing the principal.

FARMS AND COUNTRY ESTATES. In Ohio Valley, Virginia, Kentucky and elsewhere, large and small.

CITY PROPERTY. Modern dwellings, nice homes and good renters; and vacant lots which are growing in value

MILLS. Flouring and Saw Mills.

OUR SPECIALTY, to locate parties who have **MONEY TO LEND** or **INVEST**, and place it at a good rate of interest on good securities.

AGENTS WANTED. To represent us. Liberal commission paid.

Parties interested are requested to write us stating fully what they want, or to come and see us.

Tri-State Investment & Security Company

Rooms 402, 403, 404 Union Trust Building
Parkersburg, West Virginia

MARYLAND

A Great Bargain

447 acres of good land, bounded on three sides by country roads, well watered and wooded, and improved by two good dwelling-houses and all necessary farm buildings. School and church at one corner of farm. Two miles from electric car between Baltimore and Washington; stores and canning factories nearby. Must be sold at once. Price, \$16 per acre for the whole farm; would also sell part.

H. Badenhoop III N. Charles Street
Baltimore, Md.

(Call or write for my list of Maryland Farms)

MONEY TO LOAN

in sums to suit on real estate, city or country located in the United States or Canada, at six per cent. interest. Two per cent. commission charged for placing loans. Will also make loans on yachts and vessel property.

Address **A. H. Crawford, R. F. D. Route One**
Box 60, Elliott City, Maryland

OHIO

Farms and Timberlands

No. 4.—200 acres near Akron, Ohio. 25 acres of virgin hardwood timber. Soil gravelly loam. Large country house, hardwood finished; four other buildings, all in excellent condition, and two barns. Price \$55.00 per acre.

No. 16.—50 acres of good timber, white and red oak (first growth) Two miles from station. *Terms reasonable. Send for full list.*

F. A. Leeser, Akron, Ohio

OKLAHOMA

Farm Lands, Coal Lands Oil Lands

and City Property. **BRICK BLOCK** in growing young town, pays 15 per cent. on its price, \$12,000

Splendid Country Seat

70 acres, adjoins town of 1,000 inhabitants, improvements cost \$10,000. All new \$15,000. Write for wants.

W. T. MILLER REALTY CO.

Box 256

PORUM, OKLA.

NEW YORK

11,000 ACRES

TITLES PERFECT

J. F. WEATHERS & COMPANY

Timberland in Alabama on new railroad. Will cut 8,000 feet merchantable lumber. Will sacrifice for quick sale at \$6 00 per acre. Underlaid with 3 seams best coal and fine iron ore,

TIMBERLAND SPECIALISTS
1226 Broadway, New York

FOR SALE

Game and Trout Preserve

Sullivan County, New York; 2,300 feet above the sea level, 425 acres, over 300 acres in forest; a lake covering 70 acres, fed by numerous springs located on the premises. Lake stocked with trout; there are also partridge, deer, and other game.

Large four-story house and a two-story cottage, both furnished; fine views; for sale, including furniture, stock, implements, etc. For terms and particulars, address

W. F. DAVENPORT

171 Broadway, New York, N. Y.

FOR SALE—FARMS, COUNTRY ESTATES, BUILDING SITES; ALL SECTIONS; WRITE YOUR WANTS
W. F. DAVENPORT
171 BROADWAY, NEW YORK, N. Y.

30 Years Successful Selling COUNTRY PROPERTY ONLY.

Residences, Farms, Cottages, Hotels, Stores, Etc.
EVERYWHERE.—CATALOG FREE.
OWNERS wishing to sell call or write.
PHILLIPS & WELLS, 12 F Tribune Bldg., N. Y.

WASHINGTON, D. C.

A Valuable Blue Grass Farm at Sacrifice Price

227 acres, 54 timber, valued at \$2,000; 53 grass; fenced; 6 springs, fine stream; 8-room stone house, slate roof, large cellar; double cornhouse, barn, stable, stone dairy, stone meat house; fruit. Owner going abroad, offers this fine farm, best part of Loudoun County, Va., with magnificent view on every side; completely stocked, house furnished, for \$11,000. Immediate possession.

Finest Timber Proposition in Virginia

3,000 acres, mostly pine and oak; about 50 miles Washington, 10 miles railroad; 200 acres cleared; modern 10-room house; fine large orchard; tenant house; all necessary outbuildings. We can sell this grand plantation for \$8 acre, and guarantee income of \$1,500 from timber for five or more years. Investigate at once. Other bargains. Catalogue.

SOULE REALTY CO., (Dept. H)
WASHINGTON, D. C.

MONTANA

DO YOU WANT TO HELP

Conserve the Timber Supply?

You can do so at a financial profit by buying a timber claim and holding for the inevitable rise in value.

I have claims to sell at first hand from those who took them up under the Timber and Stone act. Average selling price only

TEN DOLLARS
PER ACRE

C. I. O'NEIL KALISPELL, MONT.

NEW JERSEY

WANTED

Two or three hundred acres of timber land. Pine or hard-wood. Suitable for forest camp, virgin timber. Accessible location. State locality and price. Address

E. N. BEE Box 157 NEWARK, N. J.

PUMPS WATER

Day and Night Automatically

Low in first cost, easy to install, no expense to operate, any capacity desired for Country Homes, Farms, Dairies, Gardens, Irrigation, Town Plants, Railroad Tanks, etc.

RIFE HYDRAULIC RAMS

Raise water 30 feet for every foot of fall. Satisfaction Guaranteed. Over 7,000 in use. If there is a stream, spring or pond within a mile—

Write for Free Plans and Book.
Get Our Free Trial Offer.

Rife Engine Co.
217 1/2 Trinity Bldg.
NEW YORK



Hardy Shrubbery, Trees, and Specimen Evergreens

In Small and Large Sizes. Our Prices Are the Lowest for Quality Offered. Estimates Given on All Landscape Work. Write for Prices.

W. F. McCORD CO., Nurserymen

Tarrytown, N. Y.

PRATT'S
"SCALECIDE"

TRADE MARK REG. U. S. PAT. OFF.

Will positively destroy SAN JOSE SCALE and all soft-bodied, sucking insects without injury to the tree. Simple, more effective and cheaper than Lime Sulphur. Not an experiment. Write for FREE sample and endorsement of leading fruit growers and entomologists who have used it for years. Prices: 50 gal. bbl., \$25.00; 30 gal. tin, \$15.00; 10 gal. can, \$6.00; 5 gal. can, \$3.25; 1 gal. can, \$1.00, f. o. b. New York. One gallon makes 16 to 20 gallons spray by simply adding water.

B. G. PRATT CO., MFG. CHEMISTS, 50 CHURCH ST., NEW YORK CITY

**Evergreens and Forest Trees
 for Reforestation**

I make a specialty of growing Evergreens and Forest tree seedlings and transplants for Forestry purposes and can offer in immense quantities at lowest prices all the most important varieties, such as White Pine, Scotch Pine, Jack Pine, Ponderosa Pine, Norway Spruce, White Spruce, Red Spruce, Balsam Fir, Douglas Fir, etc., also Catalpa Speciosa, Black I ocust, Red Oak, White Oak, Burr Oak, Black Oak, Chestnut Oak, Hickory, Walnut, Chestnut, Beech, European Larch and many others. I am the largest collector of tree seeds in America, having collectors in all the most important collecting districts in this country and Europe. No seeds leave our warehouse unless they test up to the same high degree of germination which we demand for our own plantings. Correspondence is solicited from parties who contemplate purchasing material for Forestry planting, for tumber, railroad ties, fence posts and all commercial purposes, and information relative to care, culture, growth, soil, and varieties suited for different localities, etc., cheerfully given upon request.

D. HILL—THE DUNDEE NURSERIES
 DUNDEE, ILL.

"Dundee Grown" Trees Have Been Famous
 for Over Half a Century



DENTACURA
TOOTH PASTE

differs from the ordinary dentifrice in minimizing the causes of decay. It is deliciously flavored and a delightful adjunct to the dental toilet. Endorsed by thousands of dentists. For sale at all toilet counters.

Sample and Literature Free

DENTACURA CO.

271 ALLING STREET

NEWARK, N. J.

**Congressional
 Information
 Bureau**

CLAUDE N. BENNETT, Manager

Attends to business before Congress, the Courts, Patent Office, Interstate Commerce Commission, and all other Departments of the Government at Washington.

Supplies any desired information from the Capital, furnishes advices concerning matters pending in Congress, the Courts or the Departments, and transacts business at Washington for clients anywhere in the world.

Conducts library research along any designated lines.

Has a Legal Department that prepares briefs for lawyers or other clients.

Usefulness demonstrated by ten years' successful experience.

**Congressional Information
 Bureau**

BOND BUILDING

WASHINGTON, D. C.

Consult **Conservation's
 Information Bureau**

if in search of advice as to the purchase of timber lands or farm lands advertised in this magazine. Our services are *free* to our readers.

This Great World History

SENT TO YOUR HOME FREE

Just send your name and address on the coupon below—that is all you need to do. It does not cost one penny and as soon as your name and address is received a set of the World famous Library of Universal History will be sent to you prepaid.

HERE is the greatest opportunity ever offered—an opportunity for our readers to secure at less than half price these fifteen beautiful volumes all printed from large new type, embellished with over 100 double page maps and plans, 700 full page illustrations, many of which are in colors, and over 5,000 pages of reading matter.

This offer is made possible by the failure of the publishers, The Union Book Co., of Chicago. Hundreds of sets of this work have been sold at \$60.00 each and they are worth every cent of it, but we now name you a rock-bottom bankrupt price of only 50c after examination and \$2.00 per month for 12 months. It is impossible to name a lower price for cash in full, as this is less than half the publisher's price and is made only to close out the few remaining sets quickly.

Before you decide to buy we invite you to examine this work in your own home for an entire week absolutely free of charge, and should you not want the books after examination we will have them returned at our expense. We earnestly request you to examine this Library; let your wife and children and friends see it. No better set of books could be placed in the hands of children than this; it reads like a thrilling novel, and is in fact a complete connected History of every country, nation and people from the beginning of time to the present year; the greatest World History ever written and endorsed by scholars everywhere.

Prof. George Fellows, of Indiana, says: "Most histories of the World are dreary compilations. This work, however, is clear, interesting and accurate."

Ex Vice-Pres. Stevenson says: "It is a complete record of the human race and should find a place in every Library."

E. Benjamin Andrews, Chancellor of the University of Nebr., says: "Its educational value in the home is sure to be very great."

Rev. Frank W. Gunsaulus, of Chicago, says: "These volumes will be of immense service in stimulating history study in our country. It is a work of real genius."

Prof. Dabney, of Virginia, says: "Southern readers will be gratified at the impartial spirit in which the war for Southern independence is treated."

The St. Louis Globe Democrat says: "This work invests the study of History with a new charm that will be felt by both young and old."

15 Massive Volumes

Each volume 7 inches wide and 10 inches high; weight, boxed, nearly

75 lbs.

NEVER BEFORE in the annals of the publishing business have we seen such a bargain. We do not hesitate to recommend this offer to every reader of this magazine; indeed we believe every family should own a standard World History, for by knowing how other countries than ours are governed, it gives us a better knowledge and higher appreciation of our own system of government and makes us better citizens.

We will be glad to give you an opportunity to see for yourself and make your own decision after you have seen the beautiful binding, the magnificent illustrations and have read parts of this great History of man on earth. Then you can decide. Should you not wish to keep the work you will notify us and we will have it returned at our expense.

The illustration of the books given here does not do them justice; you must see them to realize what they are. You assume no obligation to us or any one else by making this request, you simply ask for a free examination in your own home without paying any one anything, and remember you can send the books back at our expense, and remember, too, this bankrupt rock-bottom price of \$25.00 for this \$60.00 Library has been made possible only on account of the failure of the Union Book Company, thus necessitating a receivers' sale at a price which barely covers the cost of the paper and binding.

MAIL THE COUPON



Here is Our Offer: Once more we wish to make our offer particularly clear. Just write your name and address on the coupon, cut out and send it to us and we will have this Library sent to you for free examination in your own home. Use a postal or letter if you wish, but the coupon will do. Send us no money. Address American Underwriter Corp., Dept. 94, 240 Wabash Ave., Chicago. We employ no agents. We send the books of misleading sample pages—MAIL COUPON.

AMERICAN UNDERWRITERS CORP. DEPT. 94, 240 WABASH AV. CHICAGO

Without expense or obligation, I would like to examine your new Library of Universal History (having home free for a week. If satisfactory, will keep and pay your special price, otherwise books to be returned at your expense.)

Name.....
Address.....

IMPORTANT BOOKS ON FORESTRY

PRINCIPLES AND PRACTICE OF FORESTRY

FOREST MENSURATION. By HENRY SOLON GRAVES, M.A. A complete text book of this important subject and the first written for American Foresters. It deals with the determination of the volume of log, tree, or stand, and with the study of increments and yields. *Price, \$4.00*

ECONOMICS OF FORESTRY, THE. By B. E. FERNOW. This volume treats of forests and forestry from the standpoint of political economy, and is designed to furnish a trustworthy basis for formulating public policy. *Price, \$1.50*

FIRST BOOK OF FORESTRY, A. By FILLIBERT ROUH. An outline of the general principles of forestry, written in simple, non-technical language, designed particularly for the beginner. *Price, \$1.10*

PRACTICAL FORESTRY, FOR BEGINNERS IN FORESTRY, AGRICULTURAL STUDENTS, AND WOODLAND OWNERS. By JOHN GIFFORD. A good general description of the principles of forestry with enough technical information to prepare the beginner. *Price, \$1.40*

HISTORY OF THE LUMBER INDUSTRY OF AMERICA. By J. E. DEFEBAUGH. The first authoritative work of its kind yet issued, and one which will commend itself alike to the timber owner, lumberman, lumber manufacturer, or merchant, or student of economics. In four volumes bound in half leather. *\$5.00 per volume*

FOREST PLANTING. By H. NICHOLAS JARCHOW. An illustrated treatise on methods and means of restoring denuded woodland. *Price, \$1.50*

FORESTRY. (Schwappach.) An English translation of "Forstwissenschaft." *Price, 70c*

HEDGES, WINDBREAKS, SHELTERS, AND LIVE FENCES. By E. P. POWELL. A treatise on the planting, growth and management of hedges with information concerning windbreaks and shelters. *Price, 70c*

NORTH AMERICAN FORESTS AND FORESTRY. By ERNEST BRUNCKEN. This volume, expository in its character, is written in a style intended for the general reader, to whom it should convey a good idea of our forests forestry. *Price, \$2.00*

PRACTICAL FORESTRY. By ANDREW S. FULLER. A treatise on the propagation, planting and cultivation, with descriptions and the botanical and popular names of all the indigenous trees of the United States, and notes on a large number of the most valuable exotic species. *Price, \$1.50*

PRINCIPLES OF AMERICAN FORESTRY. By SAMUEL B. GREEN. Prepared especially for students in elementary forestry and for the general reader who wishes to secure a general idea of forestry in North America. *Price, \$1.50*

SEASIDE PLANTING OF TREES AND SHRUBS. By ALFRED GAUT. Illustrated from photographs by FRANK SUTCLIFFE. This is a new volume in the English Country Life Library. Advice regarding selection and management to get satisfactory effects under adverse influence of closeness to seashore. *Price, \$1.75*

FOREST MANAGEMENT. By C. A. SCHENCK. Describes methods here and abroad to bring the most profit from all investments made in woodlands. *Price, \$1.25*

FOREST MENSURATION. By C. A. SCHENCK. Treats conditions in U. S. from mathematical and practical standpoint. *Price, \$1.25*

FOREST UTILIZATION. By C. A. SCHENCK. First treatise on this in U. S. Covers logging, lumbering, sawmilling, cooperage, paper-making, and description of all industries obtaining raw material from American forests. *Price, \$1.25*

BILTMORE LECTURES ON SYLVICULTURE. By C. A. SCHENCK. Written from author's long experience as forester of the Biltmore estate, where sylviculture has been practiced on a larger scale for a longer time than anywhere else in U. S., and where results become more apparent from year to year. *Price, \$2.50*

FOREST POLICY. By C. A. SCHENCK. (Second part.) Describes the various States of the Union under following heads: Area; physiography; distribution of forests; forest ownership; use of the forest; forestry movement; forest laws; forest reservation; irrigation. *Price, \$1.25*

PROFESSION OF FORESTRY, THE. By GIFFORD PINCHOT. A pamphlet containing an address on that subject by Mr. Gifford Pinchot; also an address by Mr. Overton W. Price, on "Study in Europe for American Forest Students," and a list of reference publications for students. *Price, 25c*

FOREIGN IMPORTATIONS

ENGLISH ESTATE FORESTRY. By A. C. FORRES. An authoritative volume on English forest methods from the pen of a well known forester, that should prove of interest to Americans. *Price, \$3.50*

FORSTWISSENSCHAFT. (Schwappach.) *Price, 60c*

MANUAL OF FORESTRY. (Schillich.) Five volumes, complete, or separately, as follows (*price, complete, \$18.00*):

Vol. I. "FORESTRY POLICY IN THE BRITISH EMPIRE." *Price, \$2.40*

Vol. II. "SYLVICULTURE." *Price, \$3.20*

Vol. III. "FOREST MANAGEMENT." *Price, \$3.60*

Vol. IV. "FOREST PROTECTION." *Price, \$4.80*

Vol. V. "FOREST UTILIZATION." *Price, \$4.80*

This is perhaps the most authoritative work that has been issued on the technical side of forestry, translated from the German.

WOOD. By G. S. BOULGER. An important new book for arboriculturists and forestry students. A manual of the natural history and industrial applications of the timbers of commerce. Cloth. \$2 Illustrations. *Price, \$4.20*

FAMILIAR TREES. By Prof. G. S. BOULGER. Written by an eminent botanical authority, yet couched in language easily understood. The coloured plates are the work of celebrated artists, and are truthful and trustworthy in every respect. A special feature is the series of photo-micrographic illustrations of sections of woods. Three volumes. *Price, per volume, \$1.50*

DENDROLOGY, BOTANY, AND IDENTIFICATION OF SPECIES

MANUAL OF THE TREES OF NORTH AMERICA (exclusive of Mexico). By CHARLES SPRAGUE SARGENT. A volume that presents in convenient form and with excellent illustrations, authoritative information concerning the trees of North America. It is written in a manner that enables the reader to readily find to what family or species any particular tree belongs. *Price, \$6.00*

AMERICAN WOODS. By ROMEYN B. HOUGH. A new departure in the publication of an authoritative work illustrated with actual wood sections of the various species described. There are given of each, viz.: radial, transverse, and tangential. Issued in ten parts, per part *Price, \$5.00*

HANDBOOK OF THE TREES OF THE NORTHERN U. S. AND CANADA, EAST OF THE ROCKY MOUNTAINS. By ROMEYN B. HOUGH. Pictorial description 3000 30 Two pages to each species; photo-engravings of trunk, leaves, flowers or fruit, section of wood, and map of distribution, with botanical description, and brief other information. *Price, in buckram, \$8.00; in half morocco, \$10.00*

FLORA OF THE SOUTHERN STATES. CHAPMAN. This is an excellent key to the flora of the South, complete and accurate in its scope. *Price, \$4.00*

GETTING ACQUAINTED WITH THE TREES. By J. HORACE McFARLAND. A handsome volume, copiously illustrated, and with facts accurately presented in an entertaining way. *Price, \$1.75*

HOW PLANTS GROW. By ASA GRAY. An understanding of the way in which a tree grows is of prime importance to the forester, and the matter here presented is accurate and authoritative. *Price, \$1.00*

PRINCIPAL SPECIES OF WOOD; THEIR CHARACTERISTIC PROPERTIES. By CHARLES HENRY SNOW. No attempt is made to give exhaustive descriptions of species, but the author presents a mass of information designed for the use and instruction of woodworkers, etc., in a popular style. A host of concise information is brought under each head, and the work is a valuable one. *Price, \$3.50*

*Important Books on Forestry and Irrigation for sale by CONSERVATION
1417 G Street N. W., Washington, D. C.*

MANUAL OF BOTANY. By ASA GRAY. A key to the flora of the northeastern states, and the most authoritative publication of its nature. *Price, \$1.62; field edition, \$2.00*

TREES OF NEW ENGLAND. By L. L. DAME and HENRY BROOKS. This book is a small volume which can be easily put in the pocket and carried in the woods, and at the same time is the best guide to the identification of our New England trees of any of the smaller books yet published. *Price, \$1.50*

TREES AND SHRUBS. By C. S. SARGENT. The most thorough and authoritative publication yet issued, and a standard work. The matter is issued in parts, of which there are three already published. *Price, per part, \$5.00*

TREES, SHRUBS, AND VINES OF THE NORTHEASTERN UNITED STATES. By H. E. PARKHURST. In this book the author describes the trees, shrubs, and vines of the northeastern United States in a popular way, the book being designed especially for persons who have never studied botany. To these it will appeal as a valuable guide to a familiarity with the salient characteristics of trees, shrubs, and vines. *Price, \$1.50*

TREES. A handbook of forest botany for the woodlands and the laboratory. By H. MARSHALL WARD. Vol. I, Buds and twigs. Vol. II, Leaves. Vol. III, Flowers and Inflorescences. Three volumes to be added, on Fruits and seeds, Seedlings, Habit and conformation of the tree as a whole. *Price, per volume, \$1.50*

PARTICULAR SPECIES AND LOCALITIES

MOUNTAINS OF CALIFORNIA, THE. By JOHN MUIR. No other person is so well fitted to write of the mountains of California as John Muir, and the volume presented here describes not only the mountains themselves, but the trees that clothe them and the wild life which they harbor. *Price, \$1.85*

BOOKS ON IRRIGATION AND DRAINAGE

IRRIGATION IN THE UNITED STATES. By F. H. NEWELL. The most authoritative and complete work on the subject which has yet been published, by the head of the Government's irrigation work. *Price, \$2.00*

IRRIGATION FARMING. By L. M. WILCOX. A newly revised edition of one of the standard works on irrigation. The principal chapters treat very fully of irrigation, its application, etc., and the volume is profusely illustrated. *Cloth, \$2.00*

IRRIGATION FOR FARM, GARDEN AND ORCHARD. By HENRY STEWART. This work is offered to those American farmers and other cultivators of the soil who, from painful experience, can readily appreciate the losses which result from the scarcity of water at critical periods. *Price, \$1.00*

IRRIGATION AND DRAINAGE. By F. H. KING. While most of the existing books on these subjects have been written from engineering or legal standpoints, this one presents in a broad, yet specific way the fundamental principles which underlie the methods of culture by irrigation and drainage. *Price, \$1.50*

IRRIGATION INSTITUTIONS. By ELWOOD MEAD. A discussion of the economic and legal questions created by the growth of irrigated agriculture in the West, by the Chief of Irrigation and Drainage Investigations of the Department of Agriculture. *Price, \$1.25*

LAND DRAINAGE. By MANLY MILES. A handbook for farmers on the principles and practice of draining, giving the results of his extended experience in laying the drains. *Price, \$1.00*

LAND OF LITTLE RAIN, THE. By MRS. MARY AUSTIN. A nature book of the highest type. The volume is made up of a series of sketches of the human, animal, and plant life found in the region of the Mohave desert, Death Valley, and the Sierras, much of which the average person is likely to consider almost devoid of living things. *Price, \$2.00*

OUR NATIONAL PARKS. By JOHN MUIR. If you want to learn about the glaciers, mountain peaks, canyons, and great waterfalls of the West; of the habits of animals from the squirrel to the moose; plant life from the big trees to the wild flowers—in fact be brought face to face with nature's works, this is the book. *Price, \$1.85*

TREES AND SHRUBS OF MASSACHUSETTS. EMERSON. Two volumes. Plain cloth edition has 148 plates. The colored edition has 36 of these in colors. *Price, plain, \$12.00 Price, colored, \$18.00*

THE EARTH AS MODIFIED BY HUMAN ACTION. By G. P. MARSH. A Revision of Man and Nature. Describes changes in the face of the earth caused by man, including desolation of various countries, once thickly inhabited, by removal of forests. Shows importance of maintaining natural balance of forces. *Price, \$3.50*

THE LONGLEAF PINE IN VIRGIN FOREST. A Silvical Study. By G. FREDERICK SCHWARZ. This is a study of the life history of this important forest tree. Intended primarily for foresters and forest students; also for owners and managers of pine timber lands. Deals with the preference or dislike of the species for particular conditions of soil, climate, and environment. Illustrations and six tables. *Price, \$1.25*

THE SPROUT FORESTS OF THE HOUSATONIC VALLEY TO CONNECTICUT. By G. F. SCHWARZ. Illustrated study of forests repeatedly cut over. *Price, 35c*

IMPORTATIONS

BEAUTIFUL RARE TREES AND PLANTS. By the EARL OF ANNESLEY. A description of some of the rarer English trees, shrubs, and vines, illustrated copiously. *Price, \$12.00*

FORESTS OF UPPER INDIA AND THEIR INHABITANTS. By THOMAS W. WEBBER. This volume is an account of the author's life in India during the period shortly after 1857. It contains a vivid description of the country, its people, customs, etc., with some description of its forests and timber wealth. *Price, \$5.00*

IRRIGATION ENGINEERING AND CONSTRUCTIVE WORK

DESIGN AND CONSTRUCTION OF DAMS. By EDWARD WEGMANN. This volume includes an authoritative discussion of the constructive work involved and the principal forms of construction. Masonry, rock-fill, and timber dams are discussed extensively. *Price, \$6.00*

IMPROVEMENT OF RIVERS. By B. F. THOMAS and D. A. WATTS. This volume is a treatise on the methods employed for improving streams for open navigation and for navigation by means of locks and dams. *Price, \$6.50*

IRRIGATION ENGINEERING. By HERBERT M. WILSON. This is the fourth edition of Mr. Wilson's popular work, and the revision and enlargement which it has undergone, places it at the forefront of text books on the subject for American students. *Price, \$4.00*

ENGINEERING FOR LAND DRAINAGE. By C. G. ELLIOTT. A manual for laying out and constructing drains for the improvement of agricultural lands. *Price, \$1.50*

RESERVOIRS FOR IRRIGATION, WATERPOWER, AND DOMESTIC WATER-SUPPLY. By JAMES DIX SCHUYLER. An account of various types of dams and the methods and plans of their construction, together with a discussion of the available water-supply for irrigation in various sections of arid America, distribution, application, and use of water; the rainfall, runoff, and evaporation from reservoirs, and effect of silt, etc. *Price, \$5.00*

WATER SUPPLY ENGINEERING. By A. PRESCOTT FOLWELL. A treatise on the designing, construction and maintenance of water-supply systems, both city and irrigation. *Price, \$4.00*

These books sent prepaid upon receipt of price indicated, by CONSERVATION

1417 G Street N. W., Washington, D. C.

WATER POWER. By JOSEPH P. FRIZELL. An outline of the development and application of the energy of flowing water. Price, \$5.00

CONCRETE, PLAIN AND REINFORCED. By FREDERICK W. TAYLOR and SANFORD E. THOMPSON. Designed for practicing engineers and contractors; text and reference book for students. Discusses materials, processes, and applications of concrete in construction and specifications. Price, \$5.00

HYDRAULICS. By MANSFIELD MERRIMAN. Purpose of book is to keep ahead of modern progress, and present subject with conciseness and clearness. Gives general principles and discusses flow of water through various kinds of openings and channels. Historical notes and references. Price, \$5.00

FOUNDATIONS. By W. M. PATTON. A practical treatise explaining fully the principles involved. Numerous descriptions of important modern structures are given in sufficient detail. Includes articles on use of concrete in foundations. Price, \$5.00

MASONRY CONSTRUCTION. By IRA O. BAKER. Contains results of a great number of experiments, and a large amount of practical data on cost of masonry, pile driving, foundations, culverts, etc., and 97 tables to facilitate estimating. Price, \$5.00

REINFORCED CONCRETE. By ALBERT W. BUEL and CHARLES S. HILL. A treatise for designing and constructing engineers, governed by American practice and conditions. Theoretical discussions omitted, and replaced by practical working formulas, examples of representative structures, and records of practice. Price, \$5.00

BOOKS ON RELATED SUBJECTS

UTILIZATION OF WOOD WASTE BY DISTILLATION. By WALTER B. HARPER. An important treatise on a subject regarding which the interest is great and the information scarce. Is intended to aid in the establishment and conduct of wood distilling enterprises on a business basis. Price, \$3.00

HANDBOOK OF TIMBER PRESERVATION. By SAMUEL M. ROWE. Intended as a complete practical guide for the operator of a preservation plant, with hints on construction thereof. Price, \$4.00

IN FOREST LAND. By DOUGLAS MALLOCH. The humor, sentiment, and philosophy of the lumber business interpreted by the "Lumberman Poet." A kind of touch with the great outdoors that few books contain. Illustrated in tint, bound in silk cloth and gold stamped. Ideal for gift or library. Price, \$1.25

THE GARDEN

ROSES AND HOW TO GROW THEM. By many Experts. In text, practical; in subject and quality of illustrations, beautiful. Price, \$1.20

FERNS AND HOW TO GROW THEM. By G. A. WOOLSON. The growing of hardy ferns, both in the garden and indoors. Price, \$1.20

LAWNS AND HOW TO MAKE THEM. By LEONARD BARON. For the first time the subject of lawn seed mixtures is set forth and explained. 32 photographs. Price, \$1.20

HOW TO MAKE SCHOOL GARDENS. By H. D. HEMENWAY. This suggestive little book is a practical manual of school gardening for both teacher and pupil, and supplies the first adequate work of the sort in this country. There are to-day a hundred thousand school gardens in Europe, and the progress of the recent movement in America has been most rapid. This volume is based on actual experience (the author is an authority and director of the Hartford School of Horticulture). Illustrations, 10. Price, \$1.10

HOW TO MAKE A FRUIT GARDEN. By S. W. FLETCHER. An eminently practical work on the subject of fruits for the home. With 182 photographic illustrations by the author. Price, \$2.25

HOW TO MAKE A FLOWER GARDEN. A charming and a practical book by experts on every branch of the subject. More than 200 beautiful photographs. Price, \$1.75

HOW TO MAKE A VEGETABLE GARDEN. By EDITH L. FULLERTON. The only adequate book on the home vegetable garden. 250 photographs by H. B. Fullerton. Price, \$2.20

ART AND CRAFT OF GARDEN MAKING. By THOMAS H. MAWSON. Third edition of this standard; out of print for a year, and now reissued in revised form. Over 100 plans and details of gardens. Methods employed by successful designers carefully analyzed. Characteristic sites in typical districts described and pictured. Price, \$15.00

THE HOME AND FARM

THE COUNTRY HOUSE. By CHARLES EDW. HOOPER. A Practical manual of house building, absolutely invaluable to every one with a country place. It covers every branch of the subject in detail and treats of the garden and its furnishings in connection with the dwelling. 380 photographs and plans. Price, \$3.30

THREE ACRES AND LIBERTY. By BOLTON HALL. Description of what can be accomplished on a small place in the way of gardening, home-making, and addition to financial resources. Were it not for the unimpeachable authorities quoted, its statements as to the possibilities of the "Little Lands" for a living would seem fanciful. Price, \$1.85

THE MAKING OF A COUNTRY HOME. By J. P. Mowbray ("J. P. M."). This delightful story showed its universal appeal when published serially, and the volume amply carries out the intention of the author. Besides its practical interest for the thousands of city dwellers who have dreamed of having a country home, the story is one of such reality, humor, and interest as to ensure it the widest circulation in book form. Elaborately decorated. \$1.65

THE FIRST BOOK OF FARMING. By CHARLES I. GOODRICH. No one interested in farming, old or young, can fail to appreciate this book, for it really gives the fundamental knowledge of how to conduct a farm with the least expense and the largest return. There are 63 full pages of helpful illustrations. The price is extremely low for a work of such value. 63 pages of photographs. Price, \$1.10

NATURE BOOKS

AMERICAN FOOD AND GAME FISHES. By DAVID STARR JORDAN and B. W. EVERMANN. Fills a long-felt need in popular scientific works, being a full account of the life-histories and methods of capture of North American food and game fishes. The only book in existence which will enable the amateur readily to identify species new to him. With 10 lithographed color plates, 100 photographs of live fish in the water, and 200 text cuts. Price, \$4.40

NATURE BIOGRAPHIES. By CLARENCE M. WEED. This volume is a sort of personal acquaintance with the lives of the more common butterflies, moths, grasshoppers, flies, and so on, the sort of fascinating details of these insect existences which make the reader want to go out and study these every-day marvels for himself. 150 photographic illustrations. Price, \$1.50

THE BROOK BOOK. By MARY ROGERS MILLER. A brook is one of the most living and companionable features of the landscape, and few people, even the most ardent nature lovers, realize what an endlessly interesting study its changes and its throbbing life afford. It is a fascinating subject which the author (well known as a teacher, lecturer, and writer connected with the Nature Study Bureau at Cornell) handles with much ability. 16 photographs. Price, \$1.50

OUTDOORS. A Book of the Woods, Fields, and Marshlands. By ERNEST MCGAFFEY. Papers on out of doors, showing a love of nature and keenness of observation and power and beauty of description rarely surpassed. Price, \$1.25

NATURE AND THE CAMERA. By A. RADCLIFFE DUGMORE. Mr. Dugmore is an expert in the new movement of photographing live birds, animals, fish, flowers, etc. His works brought him so many requests for information, that he has set down here a full and detailed account of his methods. From the choice of a camera to questions of lighting, and to the problem of "snapping" shy birds and animals in their native haunts, every step is explained so simply as to be easily comprehended, even by the beginner. 53 photographic illustrations. Price, \$1.50

To Members of the American Forestry Association

We need your help. The Association of which you are members needs your help. The cause of conservation of natural resources needs your help.

Nominations for Membership

Now is the time to nominate. Use the blank below, adding to it when necessary, and send in your lists. Little remains of 1908; help to make a fine showing, in new members, for the year.

Do It Now—Lest You Forget!

Nominations for Membership

The activities of the National Office of the American Forestry Association are limited chiefly by its resources. These are derived almost wholly from its members in the form of dues. Every member is urged to aid in increasing the membership. Kindly fill out the enclosed blank form, lengthening the list, where possible, by attaching and filling blank sheet. The list should then be sent to

OTTO LUEBKERT
Acting Secretary American Forestry Association
1417 G Street Northwest, Washington, D. C.

I hereby nominate the following persons for membership in The American Forestry Association:

Name

Address

Signed.....

I CAN PRESERVE YOUR OLD TREES

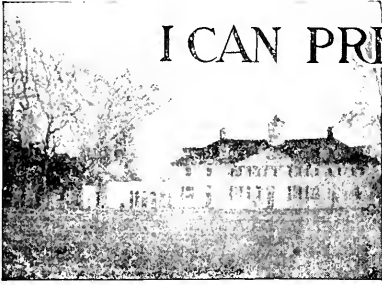

Mount Vernon

One of my expert crews is now working on the historic trees of Mount Vernon

Proper feeding of an old tree to give fresh vigor is an important part of my method of treatment. After decay has been arrested and all dead or useless limbs removed, I give special attention to starting new growth.

The art of tree surgery is comparatively new, but it is based on scientific principles of plant growth and a knowledge of the causes of disease and decay.

I undertake the management of orchards, as well as all kinds of ornamental plantations, grading, surveying; making flower gardens and herbaceous borders; and give professional advice on estate management. My crews consist of 75 expert workmen

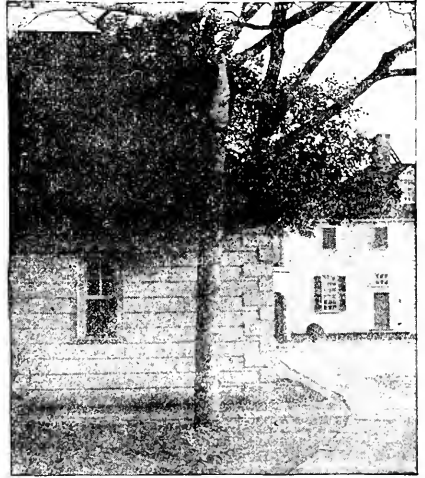

This Holly was planted by George Washington

At the request of the Mt. Vernon Association, injuries from wind storms and decay were repaired; the top was crowned and weakened branches bolted to a reinforcing rod. The tree now has a new lease of life



The famous LIBERTY TREE, Annapolis, Md., treated by us, 54 tons of concrete being used to fill the great cavity

Write to me about any subject concerning care of trees, and I will give you my opinion, based on years of experience

Practical Forestry

Landscape Gardening

Plans and Consultations

John T. Withers

1 Montgomery Street

JERSEY CITY, N. J.

JAMES D. LACEY

WOOD BEAL

VICTOR THRANE

ARE YOU

Interested in Southern or Pacific Coast Timber?

We furnish detailed reports as to the QUALITY of the timber, giving average TOP and BUTT diameters, average lengths and number of trees on each 40-acre subdivision.

We submit reports covering details as to logging conditions, cost and most feasible methods of logging each 40-acre or sectional subdivision of each tract.

We also furnish a TOPOGRAPHICAL map of all tracts located in mountainous districts, showing every elevation of 100 feet throughout the tract with OUR OWN engineer's report showing locations of most feasible routes and grades for logging roads.

We can furnish sufficient data regarding ANY tract of timber which we have examined to convince you whether the tract is what you want or not. Personal inspection of any tract we may offer you will be found just as represented.

We are in a position to offer some exceedingly attractive TIMBER properties in the SOUTH, in BRITISH COLUMBIA, and on the PACIFIC COAST. Also a few going mill operation with ample timber supplies in South Carolina and Mississippi.

We furnish detailed reports of amount of STUMPAGE on each 2 1-2, 5 or 10 acre subdivision of each forty.

We employ expert PACIFIC COAST CRUISERS to check all estimates made on Western Timber.

We offer HIGH CLASS Timber Properties only, which have been placed in our hands for sale.

We guarantee our estimates are reliable.

JAMES D. LACEY & CO.

(ESTABLISHED SINCE 1880)

608 Hennen Building

New Orleans

828 Chamber of Commerce

Portland, Ore.

507 Lumber Exchange

Seattle

1215 Old Colony

Chicago ✓



New York Botanical Garden Library



3 5185 00258 1997

