

UC-NRLF

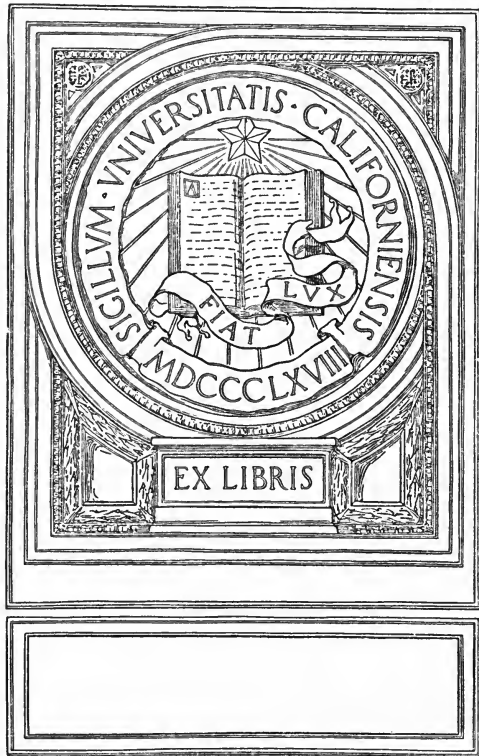

SB 26 294

GIFT OF  
Mr. Heinz Eulau







COTTAGE BUILDING IN  
COB, PISÉ, CHALK & CLAY







COB HOUSE BUILT BY MR. ERNEST GIMSON, NEAR BUDLEIGH SALTERTON, DEVON.

*Frontispiece*



# COTTAGE BUILDING

IN

# COB, PISÉ, CHALK & CLAY

*A RENAISSANCE*

BY

CLOUGH WILLIAMS-ELLIS

*WITH AN INTRODUCTION*

BY

J. ST. LOE STRACHEY



LONDON

PUBLISHED AT THE OFFICES OF "COUNTRY LIFE," 20,  
TAVISTOCK STREET, COVENT GARDEN, W.C.2, AND BY  
GEORGE NEWNES, LTD., 8-11, SOUTHAMPTON STREET,  
STRAND, W.C.2. NEW YORK: CHARLES SCRIBNER'S SONS

MCMXIX

TH 1421  
W5

Gift of Mr. Heinz Eulau

TO THE  
AMERICAN

---

## Preface

---

### P R E F A C E

MR. STRACHEY'S introduction and the author's prologue make a preface superfluous, save as a vehicle for the conveying of acknowledgments and thanks. Mr. Strachey himself is certainly the godfather of Pisé-building so far as modern England is concerned, and his enterprise and enthusiasm are alone responsible for the present interest in the subject. It is to him that I owe the greater part of my data. The experiments and building works carried out by him with the help of Mr. Gilbert Swayne of Guildford were highly instructive and attracted considerable notice through the publicity given to them in *The Spectator*.

Cob, again, is undoubtedly the godchild of Mr. Fulford, of Fulford, to whose knowledge of the old building lore of Devon I am much indebted.

It is, however, Mr. Alban Scott who made this book possible at all, by most generously putting at my disposal a mass of laboriously collected and carefully arranged information that I have not scrupled to draw upon copiously.

That so eminent an authority on the ultra-modern systems of construction should have given our ancient methods of building such careful and sympathetic consideration is in itself a testimony to their inherent excellence and to their possibilities.

CLOUGH WILLIAMS-ELLIS.

14, QUEEN ANNE'S GATE,  
LONDON, S.W. 1.

M117375

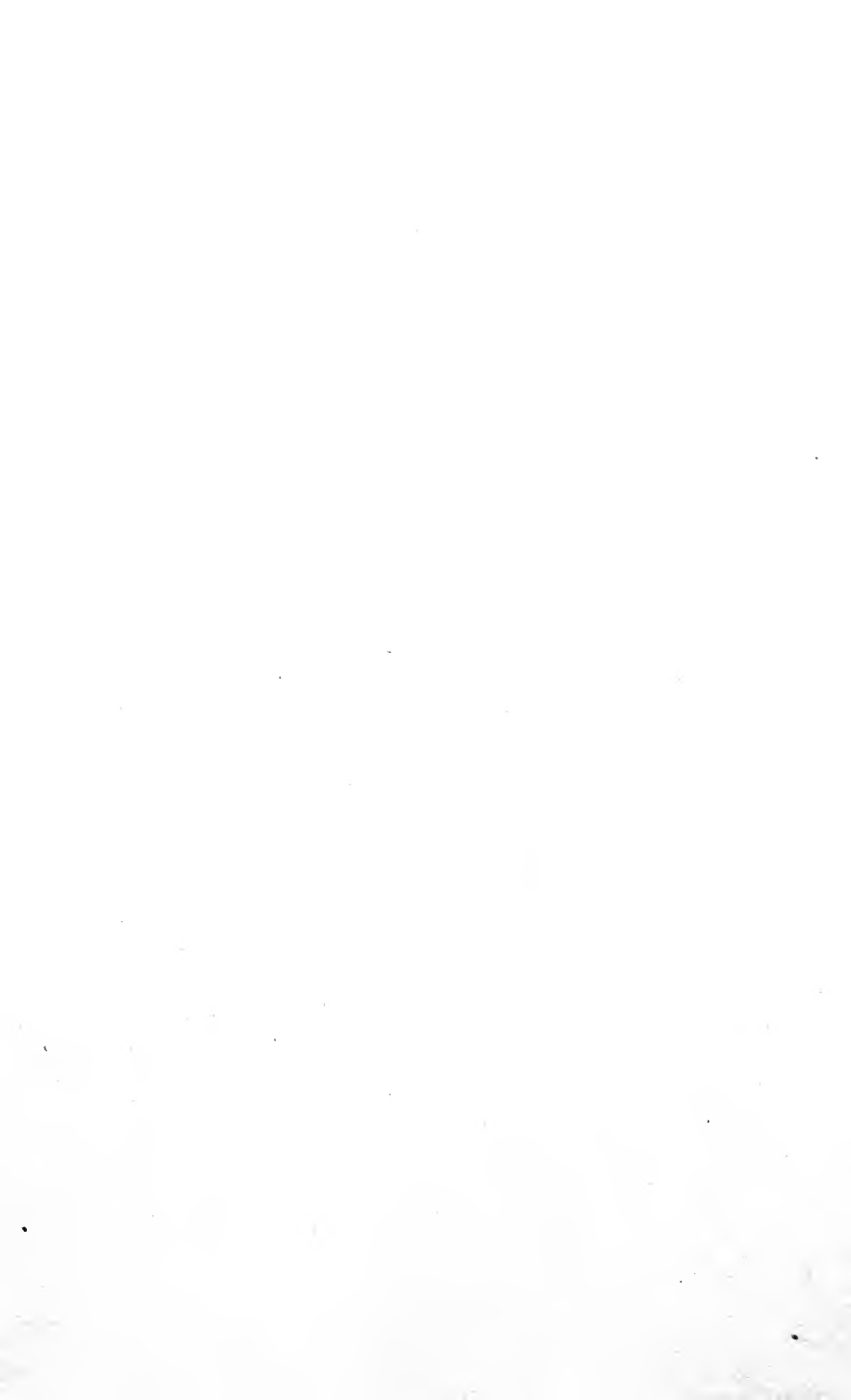

---

# Contents

---

## CONTENTS

	PAGE
INTRODUCTION . . . . .	II
GENERAL SURVEY . . . . .	26
I	
COB . . . . .	33
II	
PISÉ . . . . .	57
III	
CHALK . . . . .	93
IV	
UNBURNED CLAY AND EARTH BRICKS . . . . .	107
APPENDIX . . . . .	II 3
INDEX . . . . .	I 23

---

# Illustrations

---

## ILLUSTRATIONS

COB HOUSE BUILT BY MR. ERNEST GIMSON, NEAR BUDLEIGH SALTERTON, DEVON . . . . .	<i>Frontispiece</i>
	FACING PAGE
PISÉ WAGGON-HOUSE AT NEWLANDS CORNER . . . . .	18
THE NEWLANDS WAGGON-HOUSE (INTERIOR) . . . . .	18
THE BEGINNING OF A PISÉ FRUIT-HOUSE . . . . .	19
THE FRUIT-HOUSE COMPLETED WITH ROOF OF PEAT BLOCKS ON ROUGH BOARDING . . . . .	19
MODEL OF A PISÉ DE TERRE HOUSE TO BE BUILT IN THREE SUCCESSIVE STAGES . . . . .	22
WAYSIDE STATION OF PISÉ AT SIMONDIUM, SOUTH AFRICA, DESIGNED BY MR. HERBERT BAKER . . . . .	23
FRONT AND BACK ELEVATIONS OF COTTAGE DESIGNED BY SIR EDWIN LUTYENS AND MR. ALBAN SCOTT . . . . .	28
PLAN OF COTTAGE DESIGNED BY SIR EDWIN LUTYENS AND MR. ALBAN SCOTT . . . . .	29
ANOTHER VIEW OF THE COB HOUSE BUILT BY MR. ERNEST GIMSON, NEAR BUDLEIGH SALTERTON, DEVON . . . . .	34
A FINE SPECIMEN OF A DEVONSHIRE COB HOUSE . . . . .	35
A DEVONSHIRE COB FARMHOUSE, PROBABLY BETWEEN 200 AND 300 YEARS OLD . . . . .	36
A COB-BUILT VILLAGE . . . . .	37
A DEVONSHIRE FARM, LOCAL MATERIAL (COB) . . . . .	42

---

*Illustrations*

---

9

	FACING PAGE
DEVON COUNTRY HOUSE, BUILT OF DEVON COB . . . .	43
COB HOUSE TEMP. ELIZABETH, LEWISHILL . . . .	44
ANOTHER DEVONSHIRE (COB) FARMHOUSE, WEEKE BARTON .	45
CEILINGS OF MODELLED PLASTER FROM OLD COB HOUSES IN DEVON . . . . .	46
A COB GARDEN-WALL WITH THATCHED COPING . . . .	47
FISÉ PLANT AND IMPLEMENTS . . . . .	58
DIAGRAM OF MARK V PISÉ SHUTTERING . . . . .	88
MARK V SHUTTERING . . . . .	89
THREE CHALK COTTAGES AT HURSLEY PARK . . . .	100
MARSH COURT, HAMPSHIRE . . . . .	102
BRICK-AND-CHALK VAULTING AT THE DEANERY GARDEN, SONNING . . . . .	103
ONCE CORN HALL, NOW COUNCIL SCHOOL . . . . .	108
A ROW OF CLAY-LUMP COTTAGES . . . . .	108
ENGINEERING WORKSHOPS . . . . .	109

## CONSIDERATIONS

“ IF ALL AVAILABLE BRICKWORKS WERE TO PRODUCE AT THEIR HIGHEST LIMIT OF OUTPUT AND WITH ALL THE LABOUR THEY WANTED AT THEIR DISPOSAL THEY COULD ONLY TURN OUT 4,000,000,000 BRICKS IN A YEAR AS AGAINST A PRE-WAR AVERAGE OF 2,800,000,000.”—(*See Report by Committee appointed by Ministry of Reconstruction to consider the post-war position of building.*)

---

The first year's programme of working-class housing *alone* calls for at least 6,000,000,000 bricks. That is to say, unless wall materials other than brick are freely used, we shall fall alarmingly short of what the population of Great Britain needs in bare accommodation, and all building and engineering projects whatsoever other than housing must be postponed indefinitely.

---

“ THE COUNTRY DISTRICTS OF ENGLAND AND WALES ARE UNSURPASSED FOR VARIETY AND BEAUTY OF CHARACTER, AND IT WOULD BE NOTHING LESS THAN A NATIONAL MISFORTUNE IF THE INCREASED DEVELOPMENT OF SMALL HOLDINGS WERE TO RESULT IN THE ERECTION OF BUILDINGS UNSUITED TO THEIR ENVIRONMENT AND UGLY IN APPEARANCE.”—(*Extract from the report submitted by the Departmental Committee appointed to enquire as to Buildings for Small Holdings, 1913.*)





## INTRODUCTION

### I

THE country is faced by a dilemma probably greater and more poignant than any with which it has hitherto had to deal. It needs, and needs at once, a million new houses, and it has not only utterly inadequate stores of material with which to build them, but has not even the plant by which that material can be rapidly created. There is not merely a shortage, but an actual famine everywhere as regards the things out of which houses are made. Bricks are wanted by the ten thousand million, but there are practically no bricks in sight. All that the brickyards of the United Kingdom can do, working all day and every day, is to turn out something like four thousand million a year. But to those who want houses at once, what is the use of a promise of bricks in five years' time? To tell them to turn to the stone quarries is a mere derision. Let alone the cost of work and of transport, it is only in a few favoured places that the rocks will give us what we want. Needless to say we are short, too, of lime and cement, and probably shall be shorter. *No coal, no quicklime*, and *No coal, no cement*, and as things look now, it is going to be a case, if not of no coal, at any rate of much less coal. Even worse is the shortage in timber—the material hitherto deemed essential for the making of roofs, doors, windows and floors. Raw timber is hardly obtainable, and seasoned timber does not exist. The same story has to be told about tiles, slates, corrugated iron, and every other form of "legitimate" roofing substance. There are none to be had.

In this dread predicament what are we to do as a nation? What we must not do is at any rate quite clear. We must not lie down in the high road of civilisation and cry out that we are ruined or betrayed, or that the world is too hard for us, and that we must give up the task of living in houses. Whether we like it or not we have got to do something about the housing question, and we have got to do it at once, and there is an end. Translated into terms of action, this means that as we have not got enough of the old forms of material we must turn to others and learn how to house ourselves with materials such as we have not used before. Once again necessity must be the mother of invention, or rather, of invention and revival, for in anything so old and universal as the housing problem it is too late to be ambitious. Here we always find that there has been an ancient Assyrian or Egyptian or a primitive man in front of us.

It is the object of the present book to attack part of the problem of how to build without bricks, and indeed without mortar, and equally important, as far as possible without the vast cost of transporting the heavy material of the house from one quarter of England to another. That is my apology for introducing to the public a work dealing with what I can hear old-fashioned master-builders describing as the "bastard" forms of construction. One of these is *Pisé de terre*, the old system of building with walls formed of rammed or compressed earth: a system which was once known throughout Europe and of which the primitive tribesmen of Arizona and New Mexico knew the secret. Down to our own day it has been practised with wonderful success in the Valley of the Rhône. Then come our own cob, once the cottage material *par excellence* of Devonshire and the West of England, our system of building with plain clay blocks, a plan indigenous in the Eastern counties, and again the use of chalk and chalk *pisé*.

PISÉ DE TERRE

For me Pisé de terre, ever since I heard of it, has offered special attractions. It, and it alone provides, or if one must be cautious, appears to provide the way to turn an old dream of mine and of many other people into a reality. My connection with the problem of housing, and especially of rural housing, *i.e.* cottage housing, now nearly a quarter of a century old, has been on the side of cheap material. Rightly or wrongly (I know that many great experts in building matters think quite wrongly), I have had the simplicity to believe that if you are to get cheap housing you must get it by the use of cheap material. It has always seemed to me that there is no other way. What more natural than first to ask why building material was so dear, and then what was the cause of its dearness? I found it in the fact that bricks are very expensive things to make, that stones are very expensive things to quarry, that cements are very expensive things to manufacture, and worst of all, that all these things are very heavy and very expensive to drag about the country, and to "dump" on the site in some lonely situation where cottages or a small-holder's house and outbuildings are, to use the conventional phrase, "urgently demanded." Therefore, to the unfeigned amusement, nay, contempt of all my architectural friends, I spent a great deal of my leisure in the years before the war in racking my brains in the search for cheap material. My deep desire was to find something in the earth out of which walls could be made. My ideal was a man or group of men with spades and pickaxes coming upon the land and creating the walls of a house out of what they found there. I wanted my house, my cottage in "Cloud-Cuckoo Land," to rise like the lark from the furrows. But I was at once dissuaded from my purpose by cautious and scientific persons. The chemists, if they did not scoff like the architects, were visibly perturbed.

“Your dream is impossible,” they said. “Nature abhors it as much as she used to be supposed to abhor a vacuum. If your soil is clay, and you can afford the time and cost of erecting kilns, and bringing coal to the spot to make the bricks, you can no doubt turn the earth on the spot into a house, but even then you had far better buy them of those that sell. Your dream of having some chemical which will mix with the earth and turn it into a kind of stone, is the merest delusion. It is the nature of the earth to kill anything in the way of cement that is mixed with it. For example even a little earth will kill concrete or mortar. Unless you wash your sand most carefully, and free it from all earth stain, you will ruin your concrete blocks.” I appeared to be literally “up against” a brick wall. It was that or nothing. And then, and when things seemed at their very worst, a kind correspondent of *The Spectator* showed me a way of escape. I felt like a man lost in underground passages who suddenly sees a tiny square of light and knows that it means the way out. Somebody wrote, from South Africa I think, asking why I didn’t find the thing I wanted in *Pisé de terre*, much used in Australia, and occasionally in Cape Colony. Then came a rush of enlightenment. People who had seen and even lived in such houses wrote to *The Spectator*, and the world indeed for the moment seemed alive with *Pisé de terre*. I was even lent the “Farmer’s Handbook” of New South Wales, in which the State Government provides settlers with an elaborate description of how to build in *Pisé*, and how to make the necessary shuttering for doing so. It was then, too, that I began to hear of the seventeenth and eighteenth-century buildings of *Pisé* in the Rhone Valley. In fact, everybody but I seemed to know all there was to be known about *Pisé de terre*. For the moment indeed, the situation seemed like that described in *Punch’s* famous picture of the young lady and the German professor. “*What is Volapuk?*” asks the young

lady. "*Ze universal language,*" says the professor. "*Where is it spoken?*" "*No vairs.*" *Pisé de terre* appeared to be the universal system of building, but as far as I could make out, it was practised "*no vairs,*" or at any rate not in Europe.

## II

I had got as far as the position described above, when down swept the war upon Europe, and everything had to be postponed in favour of the immediate need of filling the ranks of the nation's army and teaching the men how to fight our enemies. As the war went on, however, the demand for rapid, cheap, and temporary building became very great, and I felt I should be justified in trying some experiments with *Pisé de terre*, even in spite of the difficulty of obtaining labour.

I think I can best illustrate the nature of *Pisé* and what it can do, and I believe will do, if I shortly recount in chronological order these humble pioneer efforts.

In the summer of 1915 I found that it was necessary in the interests of the hospital established in my house to find a place in which to store apples, for the men in blue consumed them in incredible quantities. I thought I would try *Pisé*. Accordingly, I had some shuttering made on the Australian model—not splendid scientific shuttering such as is described in the body of this work, but still shuttering quite sufficient for the purpose. With great rapidity a little fruit-house was put up, roofed with boards, and covered with blocks of compressed peat in order to make a roof which would be both vermin-proof and also keep out the heat and the frost. In my ignorance and my hurry, I now find that I violated every sound rule of *Pisé* construction. I built the walls during a week of rain, when the earth was wet, which was a great mistake; and I did not clear out the stones, which was another error that prevented the walls from being homogeneous. Worst

of all, as soon as the walls were built (and very pretty walls they were, looking something like soft brown marble), I painted them over with tar, which of course would not enter the wet wall, but only made a skin, which in a few months peeled off exactly like the bark off a plane tree. Yet in spite of this ignorant mishandling of my material, the little fruit-house is still standing and sheltered till January the few apples Nature allowed us to gather last autumn. It looks disreputable, but there has been no structural collapse, nor will there be.

No sooner was the fruit-house finished than I was met by the demand of my wife, the commandant of the hospital, to add to my house a patients' dining-room, which would be bright, dry, airy, warm, and comfortable, and be large enough for forty men to have their meals in, and to use as a sitting-room during the rest of the day. The local builder said that it was impossible to make a wooden addition, for there was no wood to be procured, or to build in bricks, since my house stands 600 ft. above the sea on an isolated chalk down. Croesus would have found it difficult at that time to build on my site, and for the ordinary economic man—"L'homme à quarantes écus"—it was quite impossible. But the room had got to be built, for the men were there, and built at once, since the out-of-door life of July and August could not continue. There was nothing to do but to fall back upon Pisé. I decided to be ambitious and to experiment, not merely in Pisé de terre, but in what I then thought—and perhaps rightly—was a new form of Pisé, *i.e.* Pisé de craie or compressed chalk. My shuttering therefore was put up. A hole not very far off was dug in the earth, the chalk which was almost at the surface was quarried out, and we began to build the wall, candid and contemptuous friends telling us of course that the chalk wall would never stand the frosts in so exposed a position, and that the wall, if made, would certainly explode! Everyone worked at that wall; the nursing

staff, the coachman, an occasional visitor, a schoolboy, a couple of boy scouts, members of the National Reserve who were guarding a "vulnerable point" close by, and even some of the patients. Patients as a rule will endure any toil with the utmost good temper if it is for the purposes of sport. If the task is useful it does not interest them. Still, a wall which might explode offered a certain attraction. We worked with more zeal than discretion, but happily I had it in my mind that homogeneity was the essential, and therefore the hard nuggets of chalk as they were thrown into the shuttering to be compressed by the rammers were first chopped up with spades, much as one minces meat. The wall had no foundations. In Pisé you can make your foundations, so to speak, as you go, through the simple process of ramming. Anyway, and to cut a long story short, the wall was made, was able to receive the roof, for which happily the local builder found some material, and not only did the wall stand, but showed a very creditable exterior. Its weight was of course enormous, for there were some twenty tons of chalk put into it. In spite of the irregularity of the labour it did not take more than ten or twelve days to build. To prevent the wet and frost getting into it, I painted the main front with a patent liquid material for rendering walls damp-proof. The Chalk Pisé wall not only served its purpose, but served it very well. The room proved extraordinarily warm and comfortable, largely owing no doubt to the fact of a solid, very dry, 18-in. wall on the north-east side.

### III

My next venture was in response to an urgent appeal from a farm tenant to build him a waggon house. The result is seen in the accompanying illustration. This building, about 40 ft. by 30 ft., was made purely of earth, but some experiments were tried in the way of introducing hurdles into the

shuttering in order to afford a surface to which plaster could easily cling. Suffice it to say that the plain earth, without plaster or any covering, more than justified itself. One part of the wall is very much exposed to the weather, but it has stood the rains and the frosts of three very bad winters without turning a hair. Lovers of the picturesque may like to know that it presents a pleasant face of light ochre, upon which a pale green efflorescence of lichen has appeared of late. Anyway, the frost has not touched it.

## IV

Next I made some experiments in chalk farmyard walls. Unfortunately, however, one of these, which was not made homogeneous by chalk mincing, *i.e.* in which the nuggets of chalk were not properly broken up, got the wet into it, and true to the candid friend's prophecy did literally explode in the big frost of 1917-18. Another very pretty chalk wall is, however, standing to this day. But though Chalk Pisé will, I think, do well if properly made and properly protected, it is somewhat of a doubtful material for anything except a building with a good overlay of roof. Another structure put up by me was a largish gardener's potting shed. This was built purely of earth, and in dry weather. When the walls were perfectly dry, the local road authorities kindly came with their tar spray and sprayed it with hot tar, with most excellent results. The hot tar really entered instead of merely making a skin, with the result that the external walls thus treated resembled a section of tarred road stood up on end.

I may add that I lent my Pisé shuttering to a Guildford Volunteer Battalion, who in a ten-hour day, or rather, two days of five hours each, built an excellent hut about 20 ft. square and 10 ft. high, and thus showed that a platoon might house themselves with Pisé in a day, provided they had roofing material ready. This building had subsequently



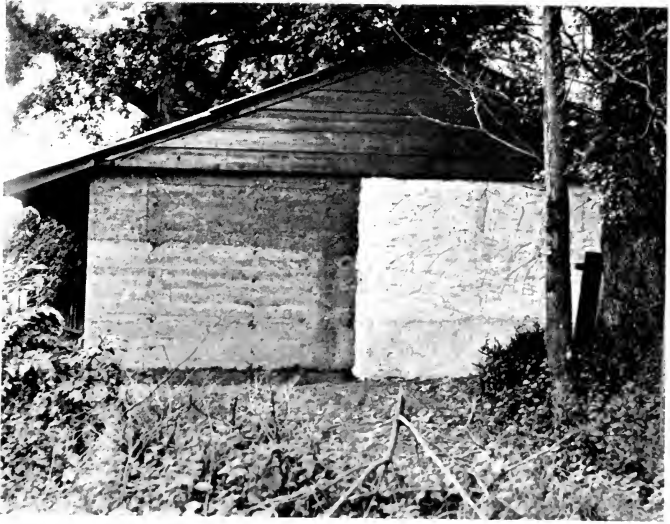

Pisé WAGGON-HOUSE AT NEWLANDS CORNER.  
An experiment in rendering.



THE NEWLANDS WAGGON-HOUSE,  
Interior.

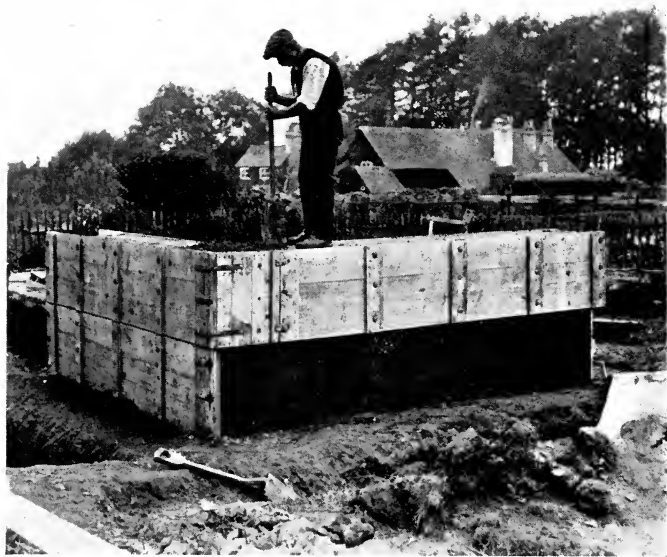

THE BEGINNING OF A PISE FRUIT-HOUSE



THE FRUIT-HOUSE COMPLETED WITH ROOF OF PEAT BLOCKS ON  
ROUGH BOARDING.

to be destroyed, because the ground on which it stood was wanted for another purpose. When it was knocked down the house-breakers were astonished at the strength and tenacity of the walls. Yet the earth out of which they were made was particularly bad—as one of the volunteers expressed it, not earth, but merely leaf-mould and horse-manure. The site had, as a matter of fact, been a suburban garden for at least two hundred years.

## V

Before I leave the record of these terrestrial adventures I may note that in the early stages I received a great deal of help and encouragement from General Sir Robert Scott-Moncrieff. He was indeed so much struck by them that he drew up a series of instructions for walls of Pisé work which were issued to all engineer companies at the front in case they might have opportunities for experimenting. These instructions were based upon the Australian book and embodied the very simple form of shuttering there recommended. The diagram that accompanied them is reproduced in the Appendix to the present volume.

## VI

### PISÉ IN MOULDS

There is one thing more to be said about Pisé. I believe that a useful development of the system may be found in the plan of ramming earth into moulds and making earth blocks, something like concrete blocks. Moulds of this kind are easy to make and are specially suitable when the soil is somewhat clayey in its nature. They have the advantage of being much cheaper than shuttering, and of being capable of being handled by one man without assistance. With a strong wooden mould and a good rammer a small-holder may easily build his own pigsty, his

own chicken house, and all the small outbuildings he requires, if not indeed add an extra room to his house. I am at present experimenting with these blocks and only yesterday had the pleasure of seeing a sergeant (R.A.M.C.), discharged through ill-health and now trying to turn himself into a small-holder, building a pigsty with the help of one of my moulds.

## VII

*Apropos* of the elusive universality and yet non-existence of Pisé work, the following personal anecdote or footnote to compressed earth may amuse my readers. Happening to be sleeping in a bedroom at Brooks's Club in 1916, I noticed a charming Regency bookcase full of old books. Among them was a copy of a *Cyclopædia* of 1819. I thought it would be amusing to see whether there was any mention of Pisé de terre. What was my astonishment to find that what I thought was my own special and peculiar hobby and discovery was treated therein at very great length and with very great ability, but treated not in the least as anything new or wonderful, but instead as "this well-known and greatly appreciated system of building, etc., etc." To complete the irony of the situation the fact was mentioned that a Mr. Holland had lately sent to the Board of Agriculture a memorandum as to how to put up houses and farm-buildings in this form of construction. My hair rose on my head, for I had just committed a similar official indiscretion myself, and had been bombarding appropriate authorities with what I thought must be a complete novelty. Truly one can never be first or do anything new. It is always "in the Files," as Mr. Kipling says. Even in our most original moments we only keep on feebly imitating somebody else. The claim to originality is nothing but a muddy mixture

of pride and ignorance. What did, however, somewhat amaze me was the calm statement of the *Cyclopædia* that this system of building was now well known in the counties of—and then came the names of practically all the counties of Southern England. And yet I had been keenly on the look-out for such buildings for several years. The cynic will say that they had all fallen down. That only shows the weakness of the cynic's point of view. The truth is they are often concealed under various disguises of plaster, paint, and weather tiles. Few people know what their own walls are really made of till they try to cut a new opening for a door or a window in them.

## VIII

### COB AND CHALK

Of Cob I know little by actual experiment. It is fully dealt with in the body of this work, and readers will find that it is a kind of mud or clay concrete reinforced with straw. It is therefore totally and absolutely different from Pisé. One is wet, the other dry.

All that need be said about chalk is said by the author of the present book.

## IX

### A POSTSCRIPT

In the body of this work mention is made of a very successful experiment in Pisé de terre made by the officials of a Rhodesian mining company; the outcome, I am proud to think, of my pre-war advocacy of Pisé in *The Spectator*. No sooner had my introduction been finished than there came by way of postscript an exceedingly interesting series of photographs, sent to me by Mr. Pickstone, a gentleman very well known in South Africa for his fruit gardens, his

peaches, and his apricots. On the strength of what he had read in *The Spectator*, Mr. Pickstone lately undertook to build a station building and station-master's house for the railway station at Simondium in the Drakenstein Valley, a place which during the summer is noted for its great heat. In the January number of the *South African Railways and Harbours Magazine*, Mr. Pickstone gives a detailed account of his bold and successful experiment and illustrates it by a reproduction of some of his photographs. Here is his own account of what he did.

“ It must have been about eighteen months ago that the railway administration decided to promote Simondium Siding to the dignity of a station. As a siding, it had always been a busy place in the fruit season, during which time a permanent checker had for some years been kept quite busy, his accommodation being a couple of small tin shanties, and he had been accustomed to board out where he could. Now we were to have a ‘pukka’ station-master and, presumably, suitable premises. The department quickly got to work and the station-master's house arrived. It was what one might call a second-hand, or even a third- or fourth-hand one, consisting of the inevitable sheets of galvanised iron and the ever-essential Oregon and Swedish timber. Our new station-master also shortly afterwards arrived, and turned out to be a married man with a wife and four children. The station-master was not a grouser, but during the hot summer—and it is terribly hot in the Drakenstein Valley during that time of the year—he complained to me that it was almost impossible to hold on, owing to the conditions under which he and his family had to live. It was just about this time that I saw in *The Spectator* a series of articles strongly advocating ‘Pisé de terre’ construction for buildings of all kinds; especially was it recommended as a war-time expedient for rapid and economical construction for barracks and



MODEL OF A PISÉ DE TERRE HOUSE TO BE BUILT IN THREE SUCCESSIVE STAGES.

The right wing is planned to be built first as a complete small cottage, eventually becoming service and servants' quarters.



WAYSIDE STATION OF PISÉ AT SIMONIUM, SOUTH AFRICA, DESIGNED BY MR. HERBERT BAKER.



hospitals, and, indeed, it was strongly recommended by Mr. St. Loe Strachey, the editor, for all sorts of general building and military purposes. It is a curious fact, which many readers could verify, that frequently one lives one's life under certain conditions, and in reality remains absolutely blind to their presence and potentialities. Here was I, living in a country where some of the most beautiful old homesteads are on the principle of the 'Pisé de terre' construction, and a large proportion of the older farm buildings in this district also built of similar material, with the additional pleasing accompaniment of beautiful beams, ceilings and floors made of colonial pine—one may advisedly add, the *despised* colonial pine. Some of these buildings have stood the wear and use of close on a century, and are still an object of joy to those privileged to have an eye to see. Here lived I, as I say, blind to its potentialities for to-day, although it had been clearly appreciated and carried out with the most charming and solid results by our great-grandfathers in the old slave-labour days."

The supervising architect, Mr. Kendall, who was responsible for carrying out the work to the admirable design of Mr. Herbert Baker, gives the following description of the way the work was actually executed, which contains several very useful hints :

"The construction of walls determined upon was that known as 'Pisé de terre,' consisting of earth walls some 18 in. to 24 in. thick, which owe their solidity to a simple process of ramming between wooden casings previously placed in position on both sides. These walls are built in stages of some 3 ft. in height, the wood casing being raised at intervals as required. The frames for doors and windows are placed in position at the right time, and anchored into the walls by means of long hoop iron ties. These walls, when completed, give a surface almost as

---

hard as burnt brick, but the external angles present a slight point of weakness, as from their exposure they would be naturally inclined to chip away in cases of rough usage. In order to overcome this it was arranged that irregular brick quoins should be embedded in the angles all the way up as the work proceeded. The walls, when completed, were then plastered and whitewashed, and present as good an appearance as more expensively plastered brickwork. As additional security the weather sides were given, prior to whitewashing, a coat of hot gas tar direct on the plaster, which in all exterior work was lime plus 10 per cent. cement. The roofs are of thatch with a fairly good overhang at the eaves in order to form a protection for the walls."

On one point, however, we may reassure Mr. Kendall. I do not think he need be afraid of his walls being destroyed by the weather even if he has no overhang. Part of a Pisé wall in my cart-shed, built in a very exposed situation, has no overhang. Further, the wall is not covered by cement or any other protective covering. The compressed earth was left quite bare, and yet the three worst winters of alternating wet and frost known for many years have made no impression upon the wall. It seems to be both rain-proof and frost-proof.

I may add that Mr. Pickstone informs me in a letter dated February 19th that the Pisé walls have proved an enormous success from the point of view of protection from the heat. Whereas in an iron building lined with wood the temperature in the hot weather went up to 104 degrees Fahrenheit, in the station-master's Pisé de terre dining-room the thermometer registered only 86 degrees. Those who have ever lived where such temperatures prevail will note the immense advantage gained by the Pisé walls. Such temperatures try strong men and women, and for children they are positively death-dealing. With so successful an

experiment as that at Simondium before my eyes, I am beginning to feel that I may live to correct my view that this universal system of building is practised “no vairs.”

X

PLINY ON PISÉ DE TERRE

Now for something which I have kept as the *bonne bouche* of my earthy story. At the end of my researches and experiments I found that Pliny has got it all in his *Natural History* in six lines! There is no need for more words.

“*Have we not in Africa and in Spain walls of earth, known as ‘formocean’ walls? From the fact that they are moulded, rather than built, by enclosing earth within a frame of boards, constructed on either side. These walls will last for centuries, are proof against rain, wind, and fire, and are superior in solidity to any cement. Even at this day Spain still holds watch-towers that were erected by Hannibal.*”—Pliny’s “*Natural History*,” Bk. XXXV, chapter xlviii.

J. ST. LOE STRACHEY.

NEWLANDS CORNER, SURREY.

## GENERAL SURVEY

ALWAYS necessity has been the mother of invention. The war has proved her prolific indeed, and her teeming offspring are seen in the multiplicity of war contrivances and the bewildering array of substitutes for the once common things of our daily life. Where necessity has been most dire, there invention has unfailingly come to the rescue with the most amazing "Ersatz" products to replace the vanished originals.

At any rate it pleases us to attribute the truly astonishing feats of the Germans in this direction to their greater need rather than to any superior ingenuity or enterprise on their part.

That their success was often no more than moderate will be readily admitted by anyone who, for instance, has made trial of their "Ersatz" cigars or ration coffee.

Still, need did at least awaken prodigious effort, ingenuity, and enterprise—all co-ordinated and concentrated on the business of making good a hundred paralysing deficiencies.

In this present matter of National Housing the shortage of all the generally recognised building materials as well as of actual houses is extreme and grave. Effort, ingenuity, and enterprise in overcoming these insufficiencies are as urgently and vitally necessary to England in Peace as ever they were to Germany in war. Little will be said here of the direct and intimate connection between good houses and good citizens.

It is assumed that those who go to the pains of reading

this book have at least glanced at the Housing Reports, and drawn certain disquieting conclusions from the criminal and vital statistics with which the case for reform is reinforced.

In a recent speech the Registrar-General said: "War does not only fill the graves, it also empties the cradles." This is no less true of bad and inadequate housing.

Only the most reckless and thick-skinned of the poorer population will adventure on marriage and the bringing up of a family whilst the odds against decent and reasonable housing persist as at present.

True, "Housing" is very properly being given considerable prominence in the press, and scarcely a day passes but there appears an article or letter dealing with this question.

Usually we are left but little wiser than we were, whilst if we chance to know something about the subject, the general tone of vague cheerfulness that pervades them all, fills us with misgiving.

Nothing is easier or pleasanter or more popular than to make airy promises or predictions about the "Homes for Happy Human Beings" that, somehow, are to be prepared for our returned soldiers, and for all those others who are housed miserably or not at all. It is very easy to predict and promise, but without adequate materials performance is not merely difficult, it is impossible.

There is a world-shortage of almost every manufactured or cultivated product; there is also a labour famine, a money famine, and a transport famine.

In this country, closely connected with these deficiencies and looming ominously over them all, is, as we have said, our house-famine.

To relieve the last in face of the others, and without further aggravating them, is one of the most grave and pressing of the many problems that confront us.

Briefly the problem is this: To provide a maximum of

---

new housing with a minimum expenditure of labour, money, transport, and manufactured materials.

Broadly speaking, so far as rural housing is concerned, the solution must be sought through the use of natural materials already existing on the site, materials that can be worked straight into the fabric of the building, without any elaborate or costly conversion, and that by local labour.

"Pisé de Terre," "Chalk Compost," and "Cob" are three alternative forms of construction, one of which will usually fulfil the above conditions in any given situation.

Despite the somewhat outlandish and high-sounding name of the first, it is nothing more than a very old and very simple method of building, recently revived through stress of circumstances. The rude technique has happily been kept alive and preserved for us in out-of-the-way corners of the Continent and in our Colonies. Wherever there is a sufficiency of sunshine to effect the necessary drying, there have earth buildings arisen and prospered.

"Cob" building needs less introduction, as it is still well understood and a living craft in several parts of Great Britain, notably in Devonshire and South Wales, where its merits and advantages have been recognised apparently from the earliest times.

All those indeed who are familiar with this method of construction are fully alive to its virtues, and the same is true of Pisé-building, both in chalk and earth, and also of clay-lump.

This book, however, is addressed to those who have in the past built only with stone, brick, concrete, timber and plaster, etc., and who are only now considering a reversion to the more primitive construction here described, through the shortage or absolute lack of their former materials.

It is not so much a question as to whether a Cob or Pisé house is preferable to one of brick or stone or concrete—though there are many who profess a lively preference for the former—but as to whether you will boldly revert to

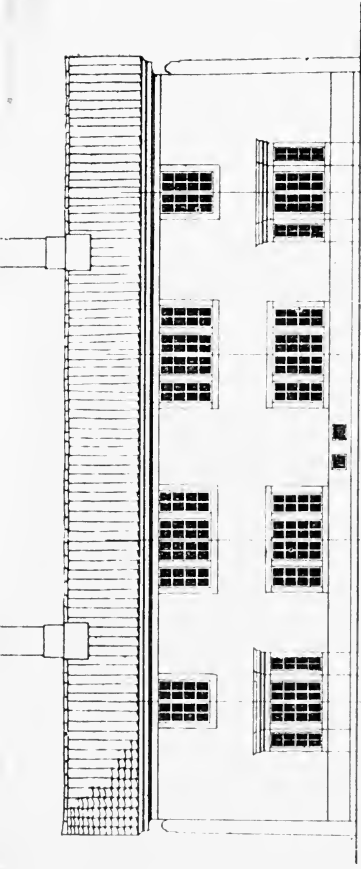
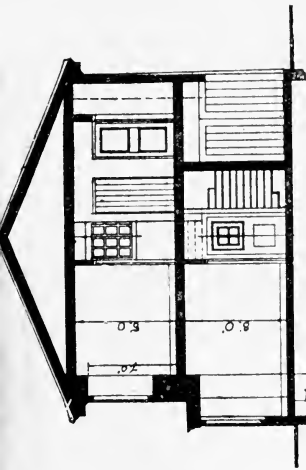

*Front Elevation*

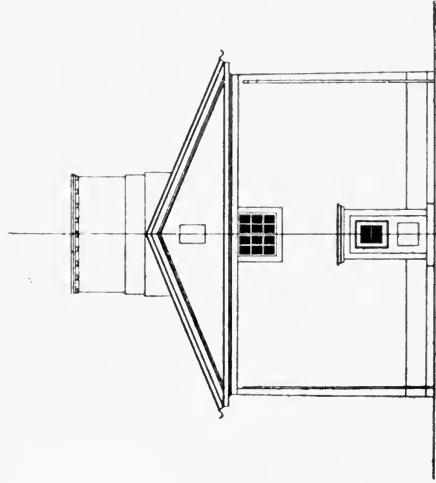

*Entrance Elevation*

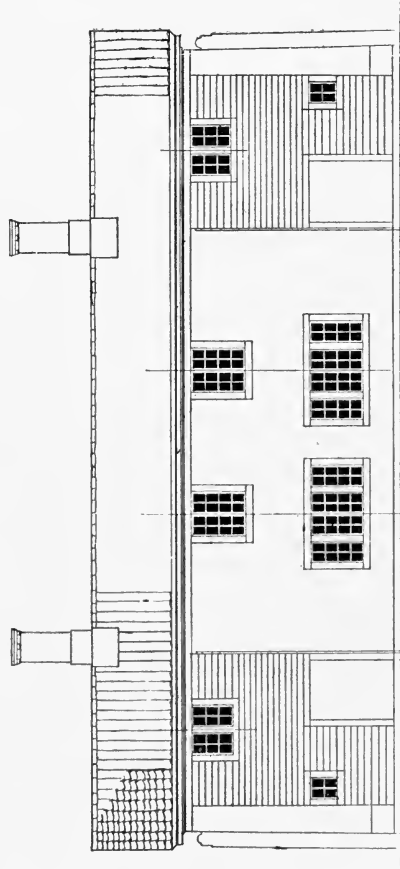

*Back Elevation*

FRONT AND BACK ELEVATIONS OF COTTAGE DESIGNED BY SIR EDWIN LUYTENS AND MR. ALBAN SCOTT.  
 This Cottage can be built in Cob, Pisé, Concrete, Stone, or Brick.

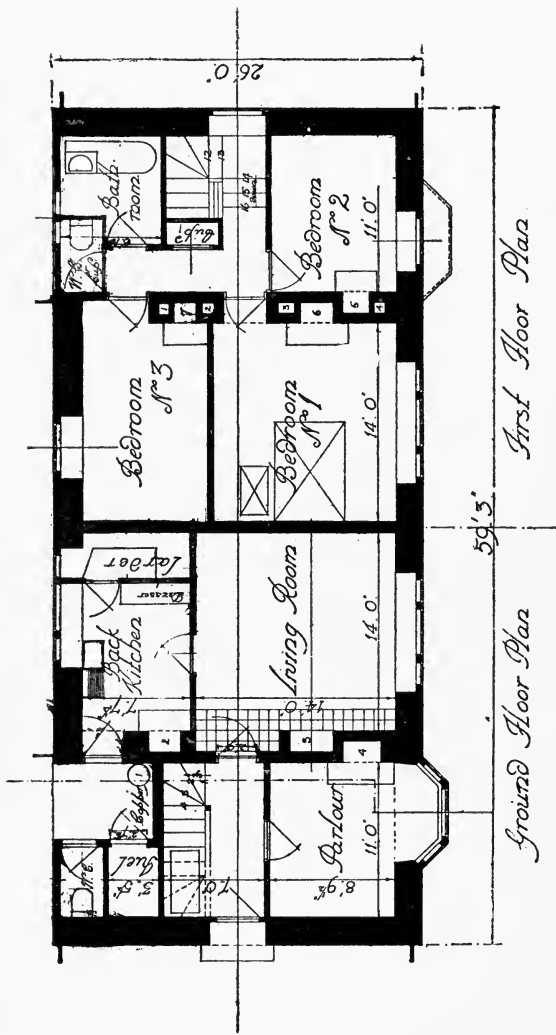

Scale of  50 Feet.

PLAN OF COTTAGE DESIGNED BY SIR EDWIN LUTYENS AND MR. ALBAN SCOTT.



these old and well-tried methods of building, or, in the absence of the ordinary materials, feebly sit down and build nothing at all.

For that will, inevitably, be the alternative for a great many private persons. National and Public-Utility Housing Schemes and public and industrial works of all sorts will naturally and properly claim priority in the matter of all building materials—and the private individual, so far as he can secure such materials at all, will only do so at a price that is the logical outcome of an unprecedented demand and an ominously inadequate supply.

Timber, tiles, slates, plaster, and ironmongery he must still purchase and transport as best he may—but the shell of his house, its outer walls at least, could and should be raised from the soil of the site itself by the employment of the simplest gear and a small amount of unskilled local labour.

So acute indeed is the transport problem, and so small is the hope of any substantial improvement in the near future, that any expedient tending to ease matters in this respect is worthy of the most serious attention.

The restrictions imposed by high freights will of themselves tend to check the often senseless and unnecessary importation of materials foreign to a district, which in the past was the despair of architects of the “traditional” school.

It was a wasteful practice that had gone far to obliterate all but the most robust traits in the old and very diverse local building conventions of rural England.

Formerly, he who wilfully carried bricks into Merioneth or the Cotswolds, or slates into Kent or ragstone-rubble into Middlesex, was guilty of no more than foolishness and an æsthetic solecism.

Under present conditions such action should render him liable to prosecution and conviction on some such count as “Wasting the shrunken resources of his country

in a time of great scarcity, . . . in that he did wantonly transport material for building the walls of a house by rail and road from A to B when suitable and sufficient material of another sort and at no higher cost existed, and was readily accessible hard by the site at B."

That indeed is our one chance of salvation, the existence and use of "the materials of another sort hard by the site."

These natural materials and their appropriate use in building will be considered in the following pages.

The Lutyens-Scott cottage, of which illustrations are given, is designed with a special view to the use of such local materials as cob, chalk, and Pisé, though it could also be constructed without appreciable modification in stone or brick.

It is thus a model of unusually universal application, providing, too, accommodation such as is certain to be demanded by the new and more educated generation that it is the aim of the country to produce.

I  
*COB*



# I

## COB

### § I. GENERAL

IF ever the counties of England recover their bygone loyalty to their own materials and their old traditions, then Cob-building will return to Devon and the West. Cheap bricks, cheap transport, and the ignoble rage for fashions from the town went far to oust provincial cob from the affections of those whom, with their forbears, it had housed so well for several centuries.

Whether the new loyalty be from within, or be imposed from without by force of circumstances, matters little. What does matter is the fact of its revival.

For with it will come again the building of cottages that are knit intimately to their sites and surroundings as of old, cottages consanguineous with the ground they stand on, be it brick-earth, rock, or common soil.

The soil of Devonshire and of many parts of Wessex and of Wales serves excellently well for building in Cob or "Clom."<sup>1</sup>

The soil itself suggested the construction, and the men of Wessex were quick to take the hint and to act on it.

The yeomen and small-holders of earlier days were commonly builders too, and often built their own homes in their own way, yet by the guiding light of local tradition.

Thus the old Devonian countryman in need of a house would set-to and build it himself—of stone if that were handy and easily worked, of cob if it were not.

<sup>1</sup> Probably, indeed, there is no county in the kingdom that has not considerable areas where the soil would, if tried, prove well adapted for Cob-building.

No doubt the doors and windows would be made and fitted by the village wheelwright ; but the cottager himself would thatch or slate the roof as naturally and successfully as he built.

The skill and care with which these versatile amateurs built their houses was not always of the highest, and careless construction, like other sins, is visited on the children—the worse the sooner.

Thus it is that there are to-day plenty of old cob cottages that are both damp and insecure, but to condemn cob building in general because certain old builders were careless, ignorant, or incompetent, is to condemn all materials from wattle and daub to ferro-concrete in the same breath.

Cob, being a humble, amenable, and thoroughly accommodating substance, has reaped the inevitable reward of good nature in being “ put upon ” and in being asked to stand what is quite beyond its powers of endurance, and yet Devon cob houses of Elizabethan date are not uncommon.

It is very reasonable in its demands, but two things it does require—dry foundations and a good protecting roof.

To quote an old Devonshire saw on cob—“ Giv’un a gude hat and pair of butes an’ ’er’l last for ever.”

In many instances the Devonshire leaseholder, usually only a “ life-lease ” holder, built badly and on indifferent foundations. He neglected to repair his thatch, with the consequence that ruin followed sooner or later. He did not always use rough-cast, so that it often happened that by the time the lease expired the unfortunate landowner found that the cottage fell in—in the literal as well as in the legal sense. The lower portions of the walls were honey-combed with rat-holes, the walls bulged out or fissures resulted from subsidence, and the dwelling presented that appearance of squalor and meanness that has led so many to decry the mud buildings of Devon as relics of bygone barbarism. But if adequate care is bestowed on the construction, there



ANOTHER VIEW OF THE COB HOUSE BUILT BY MR. ERNEST GIMSON, NEAR BUDDLEIGH SALTERTON, DEVON.

[See *Frontispiece*

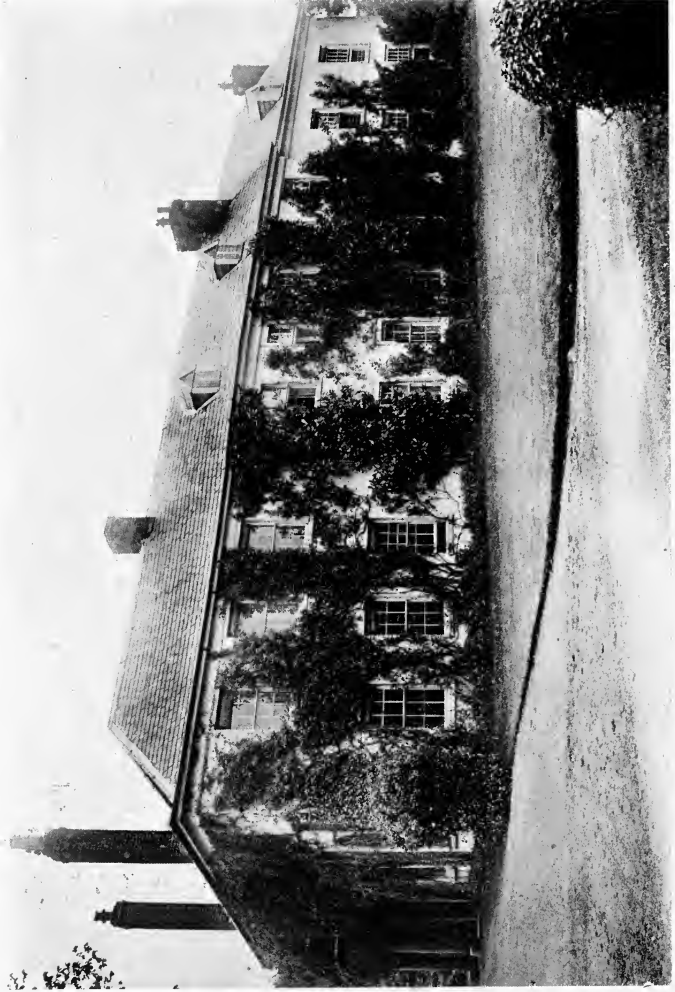

A FINE SPECIMEN OF A DEVONSHIRE COB HOUSE.



is no reason why cob cottages should not prove at one and the same time comfortable to the inmates and pleasant to the eye, and endure for many generations.

As to their comeliness and longevity, a day's walk in Devon, or, failing that, a glance at the printed pictures will tell all that need be told. That the beauty of cob buildings is not due merely to the irregularities and weathering produced by the passage of time is sufficiently proved by the photographs of Mr. Gimson's charming cob cottage, taken soon after he had finished it.

The work was done a year or two before the war ; this is Mr. Gimson's own description of the manner of its building :

“ The cob was made of the stiff sand found on the site ; this was mixed with water and a great quantity of long wheat straw trodden into it. The walls were built 3 ft. thick, pared down to 2 ft. 6 in., and were placed on a plinth standing 18 in. above the ground floor, and built of cobble stones found among the sand. The walls were given a coat of plaster and a coat of rough-cast, which was gently trowelled over to smooth the surface slightly. I believe eight men were engaged on the cobwork, some preparing the material, and others treading in on to the top of the walls. It took them about three months to reach the wall plate ; the cost was 6s. a cubic yard, exclusive of the plastering. No centring was used. The joists rested on plates, and above them the walls were reduced to 2 ft. 2 in. in thickness to leave the ends of the joists free. The beams also rested on wide plates and the ends were built round with stone, leaving space for ventilation. Tile or slate lintels were used over all openings. The cost of the whole house was 6½*d.* a cubic foot. Building with cob is soon learnt—of the eight men, only one of them had had any previous experience, and, I believe, he had not built with it for thirty years. This is the only house I have built of cob.”

What is most interesting in this narrative is the workmen's lack of experience, which seems to have been no hindrance. Anyone who proposes to revive the use of cob may take courage from Mr. Gimson's evidence. The time spent in building the walls was reasonable and the cost low. It may be guessed that the post-war rise in cost will be no greater in proportion, if as great, when compared with brickwork. The natural charm of the wall surface is enhanced by the crown of thatched roof, modelled with a skill which few can bring so certainly to their task as Mr. Gimson.

## § II. METHOD OF BUILDING

*Composition.*—Cob is a mixture of shale and clay, straw and water. Shale is a common and widely distributed stratified formation of a slaty nature, and there are few types of clay soil that would not serve for cob making.

The precise relative proportion of the first two ingredients varies, depending on their individual peculiarities.

Local custom as to the composition and preparation of the mixture will generally be found to have adjusted itself to the peculiarities of the soil.

The following extract is from an analyst's report on a sample of typical old cob walling :

“ The material when placed in water fell to pieces. On analysis, it was found to consist of :

	Per cent.
Stones (residue on 7 by 7 mesh sieve) .	24'40
Sand, coarse (residue on 50 by 50 mesh sieve)	19'70
Fine sand (through 50 by 50 mesh sieve) .	32'50
Clay . . . . .	20'60
Straw . . . . .	1'25
Water, etc. . . . .	1'55
	100'00



A DEVONSHIRE COB FARMHOUSE, PROBABLY BETWEEN 200 AND 300 YEARS OLD.



A COB-BUILT VILLAGE.

“The material is a conglomerate of slaty gravel with a very sandy clay, to which mixture a small proportion of straw has been added.

“The clay acts as an agglutinant, and the straw as a reinforcement.

“Efficient protection from frost and rain would be necessary before such material could be considered weather-proof.”

(N.B.—Lime is occasionally added to the clay-shale, but this is not usual.)

*Mixing.*—The old method of mixing by hand is as follows : A “bed” of clay-shale is formed close to the wall where it is to be used, sufficient to do one perch. A perch is superficial measurement described as  $16\frac{1}{2}$  ft. long, 1 ft. high, and the amount of material will vary according to the thickness of wall required. Four men usually work together. The big stones are picked out. The material is arranged in a circular heap about 5 or 6 ft. in diameter.

Starting at the edge the men turn over the material with cob picks, standing and treading on the material all the time. One man sprinkles on water, and another sprinkles on barley straw from a wisp held under his left arm. The heap is then turned over again in the other direction, treading continuing all the time. “Twice turning” is usually considered sufficient. Straw bands may be wrapped puttee-wise around the legs of the men to keep them clean, and these are removed at the end of the day.

More rarely the mixing is done in a rough trough, whilst a power-driven “pan-mill” has also been tried with success ; though one would think that the use of such a machine might tend to diminish the binding strength of the straw submitted to its grinding.

*Building.*—In building a man stands on the low base-wall, and lays the material handed up to him on the cob

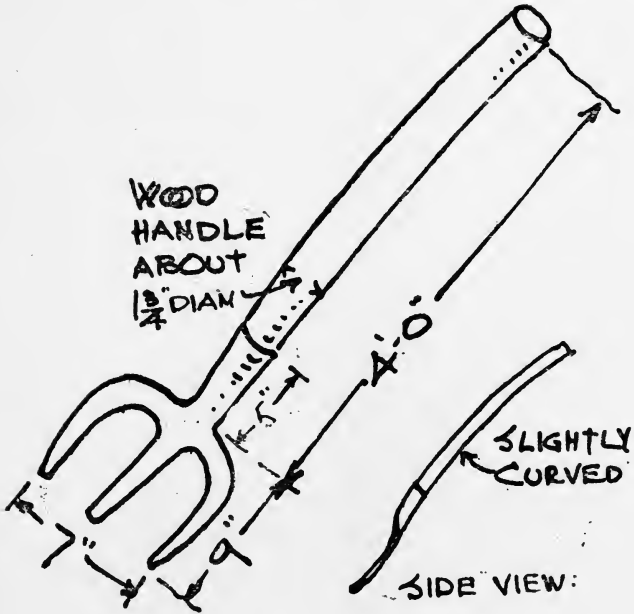

COB PICK  
 (Measured from example at  
 Great Fulford).

picks, treading it into position. Thorough treading is important, and the heels should be well used. The material is allowed to project each side an inch or so beyond the stone base to allow for paring down afterwards. The courses are usually about 2 ft. high. The cob should be



COB COURSE, OR SCAR, SHOWING DIAGONAL LAYERS.

laid and trodden in diagonal layers, as shown in the diagram: this is to secure proper bonding. It takes from two to three weeks for a course to dry, according to the weather, and five or six men would be required to build the walls of an ordinary cottage. This would not keep them continuously employed, however, and they would require to have several buildings in hand at the same time, so as to be able to turn from one to the other while the courses were drying.

At the completion of a course the corners are plumbed up from the stone base below, a line is stretched through and the wall is then pared down "plumb" with the "paring

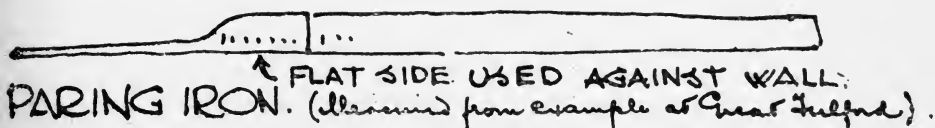
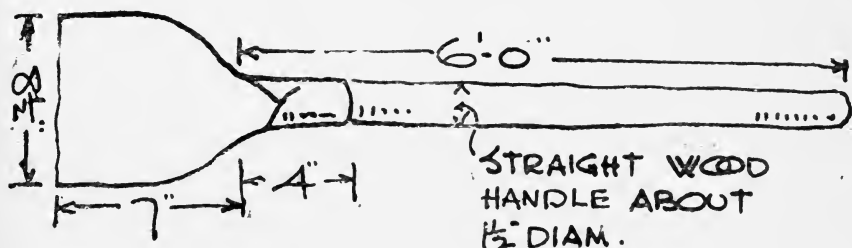

iron" by the man standing on the wall. Sometimes, however, the paring down is left until the wall is finished and dry. Four men will do about four perches per day of a wall 2 ft. thick, preparing and laying material.

The material is rarely laid between timber shuttering as in *Pisé* work, as the retaining boards tend seriously to retard the drying out.

*Drying.*—If a course takes from two to three weeks to

dry, it naturally takes a long time for a whole cottage to completely dry out. The walls can be built from about March to September. The internal fitting, plastering, etc., can be done in the winter, but the external rendering must not be done for at least a year, perhaps two years, to allow the walls to become perfectly dry.

As unprotected cob is sensitive to frost, especially if not thoroughly dried out, it should be given a good external rendering as soon as it is really dry, and should in the meantime be protected from frost by some temporary covering, straw-matting or what not. Also all cob-work must be protected from the rain both whilst building and when built.

No artificial methods of drying are at present usual, beyond good fires inside during the winter, though, as under such conditions a cob cottage is not usually considered fit to live in for several months after completion, some artificial means of drying might be worth considering.

*Foundations and Base.*—The depth of the excavations required for the foundations naturally depends upon the character of the site and soil, as also does the spread of the footings, if any.

The base-course wall of brick, stone, or concrete should be carried up some 2 ft. or so above ground level. In old days this walling was not infrequently built "dry"—but good lias lime or cement should be used in all new work.

The damp-course too was an unknown refinement to the by-gone builders, and the introduction of this one improvement alone makes the new cob cottage a very different dwelling from the old.

The usual forms of damp-course serve well for cob walls, though slates laid butt and broken joint in cement are probably the best.

*Thickness of Walls.*—The thickness of walls may be any-



thing you please from 18 in. upwards. There are old examples a full 3 ft. across, but for an ordinary two-storied cottage a thickness of about 2 ft. is general. Eighteen inches is certainly the minimum thickness, and would not ordinarily be adopted for any but one-storied buildings.

The first-floor walls are made the same thickness as those below, for if they were reduced in width, as is usual in a stone building, the extra weight thus thrown on to one side of the ground floor walls would tend to make them bulge, unless quite dry and thoroughly set.

There are old cob walls in existence fully 30 ft. in height, and there is no apparent limit in this direction provided they are thick enough.

The upper layers compress the lower ones, and automatically render them more dense and stone-like and fit to bear the load imposed above.

*Hipped roofs.*—As a general rule, however, it is found expedient to hip back the roof rather than carry it up in a tall gable, partly because cob-building at a great height above the ground in short and diminishing layers is a somewhat tedious process, partly because a hipped roof with good eaves is very welcome for the protection that its projection affords the walling.

*Masonry and Carpentry.*—The bonding of cob to stone and brick is sometimes liable to leave an open joint that will require filling when the cob dries and shrinks. Many of the chimneys in old cob houses are of brick or stone, and brick and stone jambs are sometimes to be seen in cob walls, but they are probably by way of repairs to damaged corners. It is considered better to have cob all round, so ensuring the uniform settlement of the building.

The timber built into old cob does not seem to decay. The walls are usually so dry, especially when plastered, that the wood is well preserved. The straw in the interior of old cob walls is often as bright as when put in. The straw in cob performs a similar function to hair in plaster.

Heather has sometimes been used instead of straw with good results.

The old practice was for beams, wall plates, joists, etc., to be just bedded on the cob, and for the cob to be filled in

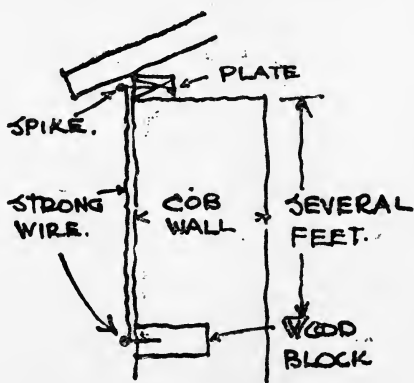

WALL COPINGS.

between the joists. In new work, particularly when the use of imperfectly seasoned timber is unavoidable, it would be wise to take the usual precautions as to the proper ventilation of all "built in" woodwork—especially the ends of joists and so forth. Roofs must of course be tied and exercise no thrust on walls. The roof plates are sometimes tied down by galvanised iron wire.

Door and window-frames are also fixed to wood blocks built into the jambs and to the wood lintels above. The frames are sometimes near the outer face of wall, some-

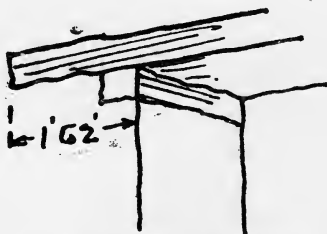

LINTEL-BEARING CROSS-PIECE.



A DEVONSHIRE FARM, LOCAL MATERIAL (COB).



DEVON COUNTRY HOUSE, BUILT OF DEVON COB.

times near the inner face. Where the door frames are on the interior face of a 2 ft. thick wall, a convenient porch results.

Other joinery is fixed to wood pins driven into the cob where required.

Corners are usually of cob, though stone quoins are occasionally met with.

Lintels are usually of wood well tailed into the wall and resting on a wood pad placed crosswise.

*Protection.*—Old buildings that have been neglected are often found to be somewhat eroded towards the bottom of their walls through the action of rain and frost.

Protection is less here than higher up under the projecting eaves, and the Achilles' heel of the cob wall is undoubtedly its base.

This vulnerable part, exposed as it is to driven rain, back-splash, and the casual kicks, should be given special protection.

Where the base is of cob and not of masonry, the traditional method is to provide a good deep skirting of pitch or tar, or a mixture of both, applied hot to the face of the rendering that should completely cover the exterior of all cob work.

This rendering is usually composed of lime and hair mortar, though Portland cement has come into use to some extent recently.

Cement, however, is apt to be rather too "short" and brittle, and it does not always hold to the cob walling very securely.

A rendering consisting of an equal mixture of cement and lime with three parts of sand adheres well to cob, however, and is probably the best coating that can be given to it.

This coating can be colour-washed or lime-whited in the usual way. The granular surface of rough rendering or of "slap-dash" on the slightly wavy surface of cob

walling perhaps gives to whitewash its very highest opportunity and charm.

Certain it is that the old cob cottages of Devon with the pearly gleam of their white walls, their heaving bulk of thatch and their trim black skirtings, are as gracious and as pleasant to the eye as any in all the length and breadth of England.

Within, lime-and-hair mortar plastered straight on to the cob makes an excellent lining.

*Chimneys.*—Nowadays, chimneys are commonly built up in brick or stone, but numerous good examples survive of flues and stacks constructed in cob. The insides of these areargeted with lime and cow-dung in the usual way, brickwork being only introduced immediately around the fireplaces.

*Rats.*—Where the surface rendering of cob-walls has been omitted or has been allowed to fall away, an enterprising rat will sometimes do considerable damage by his tunnelling.

A little powdered glass mixed with the lower strata of a wall will discourage any such burrowing, but the best preservative for any cob building is a thoroughly good skin of rendering, especially if this be reinforced by fine-mesh wire-netting secured to the wall.

*Strength.*—The strength of cob walls is surprisingly great so long as they are vertical, and are not subjected to undue lateral thrust or tension.

Beams as large as 12 in. by 12 in. may be seen supported by old cob walls, and there is nothing likely to be asked of the material in the way of strength to which it cannot easily respond.

*Design.*—Cob, like every other material, should have a certain say in the design of any building in which its use is intended.

The chief desiderata are a plain straightforward plan and broadly treated elevations where voids and solids are



COB HOUSE TEMP. ELIZABETH, LEWISHILL.

Walls from 3 ft. to 4 ft. thick. A wing was added in 1618. This farm has been occupied by the family of the present holder between 300 and 400 years.



ANOTHER DEVONSHIRE (COB) FARMHOUSE, WEEKE BARTON.



carefully disposed with an eye to getting as large unbroken blocks of cob as possible.

The cracks that are sometimes found in old cob buildings are almost entirely attributable to unsuitable design in such respects, or to bad foundations.

Cob walls built up in the ordinary way are not very suitable for internal partitions on account of their considerable width and the consequent waste of space, though in old work cob was sometimes used as a filling for stud and lath partitions which were finally plastered over in the usual way.

The sun-dried clay-lumps so much used for walling in Suffolk would seem to be admirable for forming the partitions in a house of cob.

Cob work is usually repaired with rubble, stone, or brick.

New openings are easily cut through cob walls, and this fact has occasionally led to the collapse of an old building through the zeal for light and air of some new occupier exceeding his caution, and causing him to cut away the substance of his walls in cheerful disregard of the laws of gravity.

### § III. CONCLUSION

#### AUTHORITIES—ANCIENT AND MODERN

Not by any means was cob exclusively the poor man's material, and several old homes of this sort still survive that are of some consideration.

Amongst them is Hayes Barton, the birthplace of Sir Walter Raleigh. Writing of Raleigh and his home, Mr. Charles Bernard says :

*Sir Walter Raleigh's House.*—"He had great affection for his boyhood's home—the old manor-house at Hayes

Barton where he was born, and did his best to secure it from its then owner. 'I will,' he wrote, 'most willingly give you whatsoever in your conscience you shall deme it worth . . . for ye naturall disposition I have to that place, being borne in that house, I had rather see myself there than anywhere else.' But alas! it was not to be, and the snug and friendly Tudor homestead passed into other hands. The house at Hayes Barton was probably not newly built when Raleigh's parents lived there, and it says much for the character of cob that the house is as good to-day as ever it was; though for all that it has, to use Mr. Eden Phillpotts' words, 'been patched and tinkered through the centuries,' it 'still endures, complete and sturdy, in harmony of old design, with unspoiled dignity from a far past.' Lady Rosalind Northcote gives the following description of the house in her *Devon*. She writes: 'In front of the garden, a swirling stream crosses a strip of green; and in the garden, at the right time, one may see the bees busy among golden-powdered clusters of candytuft, and dark red gillyflowers, and a few flame rose-coloured tulips, proud and erect. The house is very picturesque; it has cob walls and a thatched roof, and is built in the shape of the letter E; a wing projects at either end, and in the middle the porch juts out slightly. The two wings are gabled; there is a small gable over the porch and two dormer ones over the windows at each side of it, the windows having lattice lights and narrow mullions. Dark carved beams above them show up well against the cream-coloured walls. The heavy door is closely studded with nails, and over it fall the delicate sprays and lilac "butterfly" blossoms of wistaria.'

*Reed Thatch*.—In recent years slates or tiles have replaced thatch for the roofing of cob buildings and walls, owing to the cost of reed (the local name for the straw from

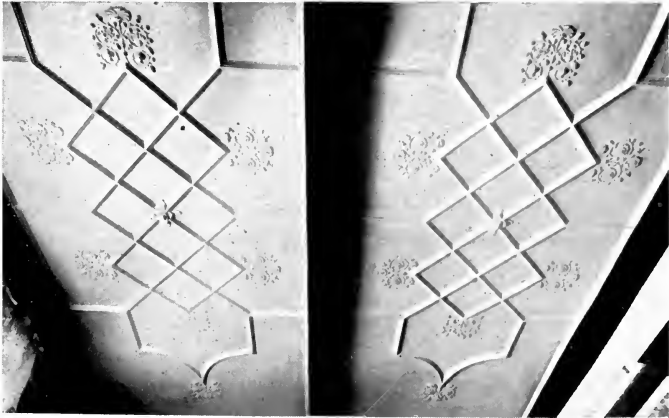
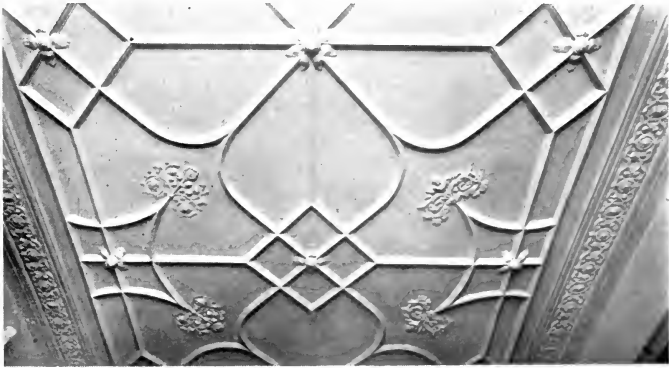
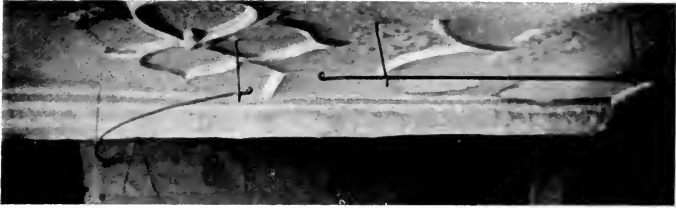

CEILINGS OF MODELLED PLASTER FROM OLD COB HOUSES IN DEVON.

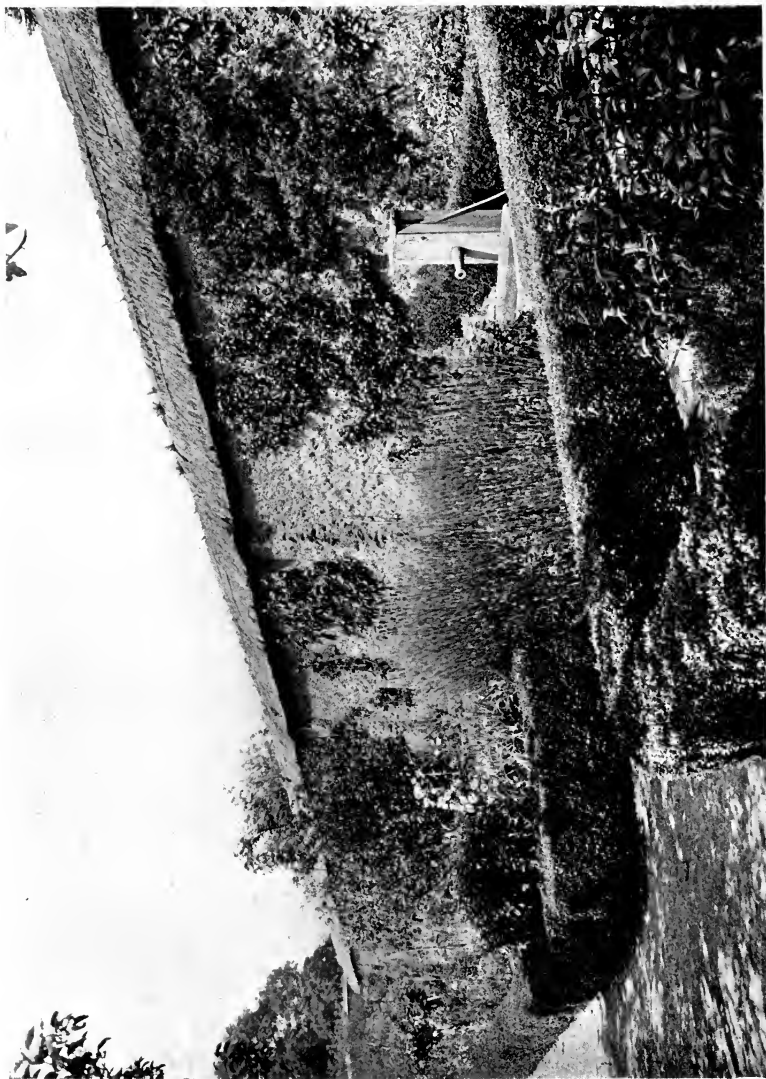

A COB GARDEN-WALL WITH THATCHED COPING.

which the grain has been hand-threshed by flail to prevent the straw being broken), and the difficulty of getting good thatchers. The opinion is held by many that the lasting quality of thatch has deteriorated since the practice of liming the cornland has unfortunately been given up.

*Primitive Methods.*—Formerly the ground floors of cob cottages were all cobbled, but these have, generally speaking, been replaced by lime, ash, or cement floors. The cob builders of past generations apparently made no use of the square, plumb-line, or level. No laths were used for the walls, which were plastered within; outside, rough-cast or “slap-dash” was laid on.

*Mr. Baring-Gould's Testimony.*—Mr. S. Baring-Gould, in his *Book of the West*, writing on the subject says: “No house can be considered more warm and cosy than that built of cob, especially when thatched. It is warm in winter and cool in summer, and I have known labourers bitterly bewail their fate in being transferred from an old fifteenth or sixteenth century cob cottage into a newly-built stone edifice of the most approved style, as they said it was like going out of warm life into a cold grave.”

#### DEVON COB

The following paragraph, taken from C. B. Allen's *Cottage-Building*, is of interest :

“The cob walls of Devonshire have been known to last above a century without requiring the slightest repair, and the Rev. W. Elicombe, who has himself built several houses of two stories with cob walls, says that he was born in a cob-wall parsonage built in the reign of Elizabeth, or somewhat earlier, and that it had to be taken down to be rebuilt only in the year 1831.”

*Fruit Walls.*—Again quoting Mr. Baring-Gould: “Cob walls for garden fruit are incomparable. They retain the warmth of 'he sun and give it out through the night,

and when protected on top by slates, tiles, or thatch, will last for centuries." It will be seen that the disadvantages of cob buildings are solely due to faults of construction, and not to any inherent defect in properly made cob as a material, and that the construction of cottages, farm buildings, and garden walls is well within the compass of an averagely intelligent workman.

It is not intended to argue that the cob cottage could be advantageously built in every county, but only that where it has been used and liked for centuries, a wise building policy would encourage its continuance. The materials are at hand, and the population ready to welcome this form of dwelling-place.

● *An Old Authority.*—An old writer treating of cottage-building thus delivers himself :

" A Bill for inclosing the waste lands of the kingdom having been introduced into the House of Commons, under the auspices of the Board of Agriculture, and as so beneficial a Bill cannot fail, sooner or later, to pass into a law, and as in consequence thereof, many small houses must necessarily be built, suited to small estates issuing out of allotments of such wastes, we have been induced to submit to the consideration of the Board three plans of such small houses to be built of different species of materials.

"The first is with mud walls, composed of soft mire and straw, well trodden together, and which, by degrees, is laid on, stratum-super-stratum, to the height required ; a species of building not uncommon for cottages, and even for better houses, barns, etc., in the western and some other parts of the kingdom. It is the cheapest habitation that we can construct and is also very dry and comfortable."

And again :

" Walls of mud, or of compressed earth, are still more

economical than those of timber, and if they were raised on brick or stone foundations, the height of a foot or 18 in. above the ground, or above the highest point at which dung or moist straw was ever likely to be placed against them, their durability would be equal to that of marble, if properly constructed and kept perfectly dry. The cob walls of Devonshire, which are formed of clay and straw trodden together by oxen, have been known to last above a century without requiring the slightest repair; and we think that there are many farmers, especially in America and Australia, who if they knew how easily walls of this description could be built, would often avail themselves of them for various agricultural purposes.

“The solidity of cob walls depends much upon their not being hurried in the process of making them, for if hurried, the walls will surely be crippled, that is, they will swag or swerve from the perpendicular. It is usual to pare down the sides of each successive rise before another is added to it. The instrument used for this purpose is like a baker’s peel (a kind of wooden shovel for taking the bread out of the oven), but the cob-parer is made of iron. The lintels of the doors and windows and of the cupboards and other recesses are put in as the work advances (allowance being made for their settling), bedding them on cross pieces, and the walls being carried up solid. The respective openings are cut out after the work is well settled. In Devonshire the builders of cob-wall houses like to begin their work when the birds begin to build their nests, in order that there may be time to cover in the shell of the building before winter. The outer walls are plastered the following spring. Should the work be overtaken by winter before the roof is on, it is usual to put a temporary covering of thatch upon the walls, to protect them from the frost.”

*Mr. Fulford’s Evidence.*—Mr. Fulford, of Great Fulford, near Exeter, whose own village and estate can show as

---

many good examples of old cob work as any place in Devon, writes as follows :

*Cost.*—" It is not possible to give a close estimate of what would now be the comparative cost of a building in cob, stone, or brick, as this must depend upon the exact locality of the site. It may, however, be of assistance if I quote particulars of the relative cost of cob and stone building in Devon in the year 1808 when cob was in common use. The stonework referred to was rough rubble, and not with square or dressed blocks. It must be borne in mind that up to that date practically all material, stone, lime, etc., was carried on horses' backs. Wheeled carts, which began to creep in about the beginning of 1800, were not in general use until twenty or thirty years later. As a boy I knew a farmer who remembered the first wheeled cart coming to Dunsford. In 1838 the Rector of Bridford (the 'Christowell' of Blackmore's novel) recorded the fact that in 1818 there was only one cart in the parish and it was scarcely used twice a year. In 1808 the price of building varied according to the district. In the northern part of the county the common price of stonework, including the value of three quarts of cider or beer daily, was from 22*d.* to 24*d.* the perch (16½ ft.), 22 in. in width and 1 ft. in height. Including all expenses of quarrying and carriage of materials, stonework worked out at from 5*s.* to 6*s.* per perch running measure, and cob estimated in like manner at about 3*s.* 6*d.* Masons when not employed by the piece received 2*s.* per day, and allowance of beer or cider. In the Dunstone district (the clay shales from which make the best cob) masonwork was 18*d.* per rope of 20 ft. in length, 18 in. thick, and 1 ft. high, stone and all materials found and placed on the spot ; cob work of the same measure was 14*d.* In the South Hams district masonwork cost 2*s.* 6*d.*, and cob 2*s.* per perch of 18 ft. in length, 2 ft. thick, and 1 ft. high."



*Use of Shuttering.*—“ In those parts of the red land where Dunstone shillot or clay shale is not available, the red clay was mixed with small stones or gravel, and frequently the cob was laid and trodden down between side boards as used in building concrete walls. Three cartloads of clay built a perch and a half of wall 20 in. wide and 1 ft. deep. Eight bundles of barley straw, equal to one pack-horse load, were mixed and tempered with nine cartloads of clay.”

*Roofing.*—“ Thatching in 1808 cost 8s. per square of 10 ft.; 100 sheaves of wheat-straw reed, weighing 25 lb. each, were sufficient for one square. Thatching, however, is not, as many suppose, indispensable as a roofing for cob buildings; slate found in many parts of Devon was frequently used, and of late years Welsh and Delabole slates, tiles, and unfortunately, from the picturesque point of view, corrugated iron, have to a large extent supplanted thatch.”

*A Protective Wash.*—“ Vancouver, in his report on the Survey of Devon for the Board of Agriculture in 1808, gave the following recipe, which he described as a preserving and highly ornamental wash for rough-cast that was then getting into common use: ‘ Four parts of pounded lime, three of sand, two of pounded wood ashes, and one of scoria of iron, mixed well together and made sufficiently fluid to be applied with a brush. When dry it gives the appearance of new Portland stone, and affords an excellent protection against the penetrating force of the south-westerly storms.’

*Rendering.*—“ For the rough-weather sides of cob buildings I have found cement and sand, finished with a rough surface, satisfactory, and far more durable than ordinary lime and gravel rough cast. For interior cob walls, laths are not necessary. The old plastering was frequently laid on too thick. Of late years I have used with excellent results granite silicon plaster for ceilings and walls. This requires no hair, and is easily applied.

*The Cob Tradition.*—"Cob-making was, like many other local trades, carried on in some families from generation to generation and developed by them into an art, but apart from these specialists, practically every village mason and his labourers built as much with cob as they did with stone. There are men still left in various parts of the county who have made cob, and it would, in my opinion, be of advantage if demonstrations could be given by them to discharged sailors and soldiers who are anxious to take up work on the land."

*Training of ex-Soldiers.*—"In cob-building, as in many other arts and crafts, a little showing is of far greater help to the novice than any amount of text-book instruction. The knowledge and experience that these men would gain from being shown, and better still, assisting an expert in making cob, would be of material advantage in the development of the county scheme promoted by the Central Land Association for the establishment of ex-Service men on the land. They could try their 'prentice hands on walls, tool-sheds, cart linhays, etc., for their own use, and some no doubt would develop into expert builders capable of constructing walls for dwelling-houses from approved plans."

*1819 Conditions Returned.*—"The depletion of our home-grown timber supply and the prohibitive cost of practically all building material has in effect brought about the conditions that led our forefathers to utilise suitable material that lay nearest to hand, and unless some endeavour is made to follow their methods and profit by their example, it will be impossible to provide sufficient buildings for the necessary equipment of the allotments and small holdings, let alone housing accommodation for the workers on the land."

There is probably no one who knows more about cob than does Mr. Fulford—certainly no one who has done

more to promote the revival of cob-building both by precept and example.

Cob is the traditional material of his native place, he has, as it were, been brought up on cob—he is familiar with both the ancient history and the modern practice of cob-building, and in short, he “knows.”

When a revivalist has knowledge as well as enthusiasm, the grounds of his faith are usually worth serious attention.



**II**  
***PISÉ DE TERRE***



## II

### PISÉ DE TERRE

#### § I. GENERAL

*What it is.*—"Pisé de terre" is merely the French for rammed earth, and rammed earth is an exceedingly good material for the building of walls.

The odd thing is that its very obvious merits should have secured it such small attention.

It is no new-fangled war-time invention brought forth by our present necessity, but a very ancient system well proved by centuries of trial.

*History.*—Pliny gives an excellent account of Pisé-building in his *Natural History*, and Monsieur Gorffon, who published a treatise on this method of construction in 1772, states that it was first introduced into France by the Romans.

The following extracts from an old book based on a French original will serve well as an introduction to the study of Pisé-building :

*Capabilities.*—"An account of a method of building strong and durable houses, with no other materials than earth ; which has been practised for ages in the province of Lyons, though little known in the rest of France, or in any other part of Europe. It appeared to be attended with so many advantages, that many gentlemen in this country who employ their leisure in the study of rural economy were induced to make a trial of its efficiency ; and the result of their experiments has been of such a nature as

to make them desire, by all possible means, to extend the knowledge and practice of so beneficial an art.

“The possibility of raising the walls of houses two or even three stories high, with earth only, which will sustain floors loaded with the heaviest weights, and of building the largest manufactories in this manner, may astonish every one who has not been an eye-witness of such things.”

*Of Pisé and its Origin.*—“Pisé is a very simple manual operation; it is merely by compressing earth in moulds or cases, that we may arrive at building houses of any size or height.”

*Locale.*—“This art, though at present confined to the single province of the Lyonese in France, was known and practised at a very early period of antiquity. The Abbé Rozier, in his *Journal de Physique*, says that he has discovered some traces of it (Pisé) in Catalonia; so that Spain, like France, has a single province in which this ancient manner of building has been preserved. The art, however, well deserves to be introduced into more general use. The cheapness of the materials which it requires, and the great saving of time and labour which it admits of, must recommend it in all places and on all occasions, but the French author says that it will be found particularly useful in hilly countries, where carriage is difficult, and sometimes impracticable; and for farm buildings, which, as they must be made of considerable extent, are usually very expensive, without yielding any return.”

## § II. METHOD OF BUILDING

There is an exhaustive article on Pisé in Vol. XXVII of *The Cyclopædia or Universal Dictionary of Arts, Sciences, and Literature*, published in 1819. The writer, Abraham Rees, D.D., F.R.S., F.L.S., draws chiefly on French authorities and his directions are most detailed and precise.



# P I S É .

*Implements for Pisé or Rammed Earth Buildings.*

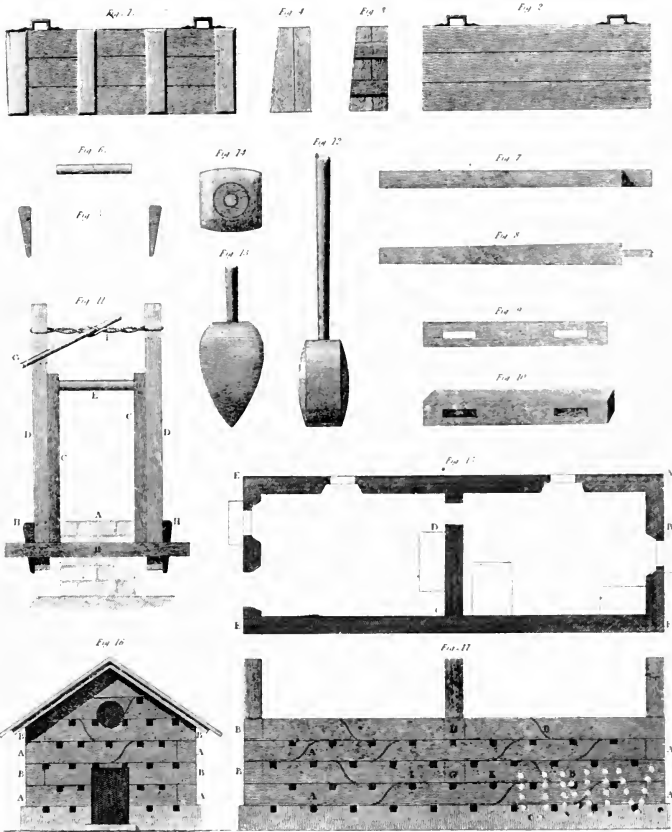

*J. F. Scher.*

*Publ. in 1850. At London by the London Museum. First Printed by Bowen, Paternoster Row.*

**PISÉ PLANT AND IMPLEMENTS.**  
 (Reproduced from an old Encyclopædia.)



*Definition.*—He introduces his subject thus :

“Pisé-building, in Rural Economy, the name of a method of building with loamy or other earthy matters, which has long been practised with great success, and in a very cheap manner, in some departments of France, and which is now had recourse to with similar advantage in some parts of this country. It has been described, delineated, and recommended by Mr. H. Holland in the first volume of *Communications to the Board of Agriculture*, and is to be managed somewhat in the manner directed below.”

At great length and with immense detail, the plant, the preliminaries, and the process are each severally described.

The pith of the matter is sufficiently given by the following extracts :

*Shuttering.*—“For the construction of the mould, take several planks, each 10 ft. long, of light wood, in order that the mould may be easy to handle ; deal is the best as being least liable to warp. To prevent which the boards should be straight, sound, well seasoned, and with as few knots as possible. Let them be ploughed and tongued, and planed on both sides. Of these planks, fastened together with four strong ledges on each side, the mould must be made, 2 ft. 9 in. in height ; and two handles should be fixed to each side.

“All the boards and ledges here mentioned must be, after they are planed, something more than 1 in. thick.”

*Rammer.*—“The instrument with which the earth is rammed into the mould is a tool of the greatest consequence, on which the firmness and durability, in short the perfection, of the work depends. It is called a *pisoir*, or *rammer* ; and though it may appear very easy to make it, more difficulty will be found in the execution than is at first apprehended. A better idea of its construction may be formed by examining the Plate, in which it is delineated,

than any words can convey. It should be made of hard wood, either ash, oak, beech, walnut, etc., or what is preferable, the roots of either of them."

*Method of Working.*—"Pisé contains all the best principles of masonry, together with some rules peculiar to itself, which are now to be explained.

"To begin with the foundation ; this may be made of any kind of masonry that is durable, and should be raised to the height of 2 ft. above the ground ; which is necessary to secure the walls from the moisture of the earth, and the splashing of the rain, which will drop from the eaves of the roof.<sup>1</sup> When these foundation walls are made level, and 18 in. thick, mark upon them the distance at which the joists are to be set, for receiving the moulds ; those distances should be 3 ft. each from centre to centre. Each side of the mould being 10 ft. long, will divide into three lengths of 3 ft. each, and leave 6 in. at each end, which serve to lengthen the mould at the angles of the house and are useful for many other purposes. After having set the joists in their places, the masonry must be raised between them 6 in. higher, that is, to a level with the joists ; there will, therefore, altogether be a base of  $2\frac{1}{2}$  ft., which in most cases will be found more than sufficient to prevent the rain, frost, snow, or damp from injuring the walls. Raise the mould immediately on this new masonry, placing it over one of the angles of the wall.

"A workman should be placed in each of the three divisions of the mould, the best workman being placed at the angle. He is to direct the work of the other two, and by occasionally applying a plumb-rule, to take care that the mould does not swerve from its upright position. The labourers who dig and prepare the earth must give it in small quantities to the workmen in the mould, who, after having

<sup>1</sup> The introduction of a damp-course and the provision of gutters at the eaves greatly reduce the function of the masonry base in modern work.

spread it with their feet, begin to compress it with the rammer. They must only receive at a time so much as will cover the bottom of the mould to the thickness of 3 or 4 in. The first strokes of the rammer should be given close to the sides of the mould, but they must be afterwards applied to every other part of the surface; the men should then cross their strokes, so that the earth may be compressed in every direction. Those who stand next to one another in the mould should regulate their strokes so as to beat at the same time under the cord, because that part cannot be got at without difficulty, and must be struck obliquely; with this precaution, the whole will be equally compressed. The man at the angle of the wall should beat carefully against the head of the mould.

“Care must be taken that no fresh earth is received into the mould till the first layer is well beaten, which may be ascertained by striking it with a rammer; the stroke should leave hardly any print on the place. They must proceed in this manner to ram in layer after layer, till the whole mould is full. When this is done, the machine may be taken to pieces, and the earth which is contained will remain firm and upright, about 9 ft. in length and  $2\frac{1}{2}$  ft. in height. The mould may then be replaced for another length, including 1 in. of that which has first been completed.

“The first course being thus completed, we proceed to the second; and here it must be observed that in each successive course we must proceed in a direction contrary to that of the preceding. It may easily be conceived, that with this precaution the joints of the several lengths will be inclined in opposite directions, which will contribute very much to the firmness of the work. There is no reason to fear overcharging the first course with the second, though but just laid; for three courses may be laid without danger in one day.

“This description of the first two courses is equally applic-

able to all the others, and will enable any person to build a house, with no other materials than earth, of whatever height and extent he pleases.

“With respect to the gables, they may be made without any difficulty, by merely making their inclination in the mould and working the earth accordingly.”

### § III. THE THEORY AND SCIENCE OF PISÉ

*The Value of Ramming.*—“Beating, or compression, is used in many different sorts of work ; the ancients employed it in making their rough walls ; the Italians employ it for the terraces which adorn their houses ; the Moors for all their walls ; the Spaniards, the French, and others for some of the floors of their apartments. The intent of the ancient architects, when they recommended the beating of cement and other compositions used in building, was to prevent them from shrinking and cracking ; and it is employed for the same purpose in walls which are made of earth. The beater, by repeated strokes, forces out from the earth the superfluous water which is contained and closely unites all the particles together, by which means the natural attraction of these particles is made powerful to operate, as it is by other natural causes in the formation of stones. Hence arises the increasing strength and astonishing durability which houses of this kind are found to possess.”

*An Experiment.*—“Upon beating a small portion of earth, and weighing it immediately afterwards, it was found to weigh  $39\frac{1}{2}$  lb. Fifteen days after, it had lost  $4\frac{1}{2}$  lb. In the space of another fifteen days it lost but 1 lb. ; and in fifteen days after that its weight diminished only  $\frac{1}{2}$  lb. In the space of about forty-five days the moisture was completely evaporated, and its weight was diminished about one-eighth ; consequently only one-eighth of the whole mass was occupied by moisture, and this small proportion cannot at all affect the solidity and consistency

of the earth so treated. This experiment is also sufficient to show the difference between this kind of building and that vulgar kind called in England 'mud-walling.' "

*Rate of Work.*—" In one single day three courses of about 3 ft. each may be laid one over the other ; so that a wall of earth of about 8 or 9 ft., or one story high, may be safely raised in one day. Experience has proved that as soon as the builders have raised their walls to a proper height for flooring, the heaviest beams and rafters may without danger be placed on the walls thus newly made ; and that the thickest timber of a roof may be laid on the gables of pisé the very instant they are completed."

#### ON EARTH PROPER FOR BUILDING

*Suitable Soils.*—" 1st. All earths in general are fit for that use, when they have not the lightness of poor lands nor the stiffness of clay.

"2ndly. All earths fit for vegetation.

"3rdly. Brick-earths ; but these, if they are used alone, are apt to crack, owing to the quantity of moisture which they contain. This, however, does not hinder persons who understand the business from using them to a good purpose.

"4thly. Strong earths, with a mixture of small gravel, which for that reason cannot serve for making either bricks, tiles, or pottery. These gravelly earths are very useful, and the best pisé is made of them."

*Soil Tests.*—"The following appearances indicate that the earth in which they are found is fit for building : when a pickaxe, spade, or plough brings up large lumps of earth at a time ; when arable lands lies in clods or lumps ; when field-mice have made themselves subterraneous passages in the earth ; all these are favourable signs. When the roads of a village, having been worn away by the water continually running through them, are lower than the other lands, and the sides of those roads support themselves

almost upright, it is a sure mark that pisé may be executed in that village. One may also discover the fitness of the soil by trying to break with one's fingers the little clods of earth in the roads, and finding a difficulty in doing it; or by observing the ruts of the road, in which the cart-wheels make a sort of pisé by their pressure; whenever there are deep ruts on a road, one may be sure of finding abundance of proper earth.

“Proper earth is found at the bottom of the slopes of low lands that are cultivated, because every year the rain brings down the fat or good earth. It is frequently found on the banks of the river, but above all, it is found at the foot of hills, and on all cultivated lands which have much slope. In digging trenches and cellars for building, it generally happens that what comes out of them is fit for the purpose.”

#### ON THE MIXTURE OF EARTHS

*Soil Blending.*—“As it may sometimes happen that earth of a proper quality is not to be found on the spot where it is intended to build, it becomes of importance to attend to the method of mixing earths; for though the earth which is near at hand may not of itself be proper, it is very probable that it may be rendered so by the mixture of a small quantity of another earth fetched from a distance. The principle on which a mixture must be made is very simple; strong earths must be tempered with light; those in which clay predominates, with others that are composed more of chalk and sand; and those of a rich, glutinous substance, with others of a poor and barren nature. The degree in which these qualities of the earths prevail must determine the proportions of the mixture; which it is impossible here to point out for every particular case, but which may be learnt by a little practice. Some easy methods will be described, by which any one may make a trial of the qualities of his earth.



“It will not be amiss to mix with the earth some small pebbles, gravel, rubbish of mortar, or in short any small mineral substances; but none of the animal or vegetable kind must be admitted.<sup>1</sup> Such hard substances bind the earth firmly between them, and being pressed and pressing in all directions, contribute very much to the solidity of the whole; so that well-worked earth, in which there is a mixture of gravel, becomes so hard at the end of two years that a chisel must be used to break it, as if it was freestone.”

#### EXPERIMENTS TO ASCERTAIN THE QUALITIES OF ANY EARTH

*Trial by Experiment.*—“Take a small wooden tub or pail, without a bottom, dig a hole in the ground of a court or garden, and at the bottom of that hole fix a piece of stone, flat and level; place your tub upon the stone, fill around it the earth that has been dug out to make the hole, and ram it well, that the tub may be enclosed, to prevent its bursting. Then ram into the tub the earth you mean to try; putting in, at each time, about the thickness of three or four fingers' breadths: when this is well rammed, add as much more, and ram it in the same manner, and so the third and fourth, etc., till the earth is raised above the brim. This superfluous earth must be scraped off extremely smooth, and rendered as even as the under-part will be, which lies on the stone. Loosen with a spade the earth around the tub, and you will then be able to take it out, and with it the compressed earth that it contains; then turn the tub upside down, and if it is wider at the top than at the bottom, as such vessels usually are, the pisé will

<sup>1</sup> “The pisé does not admit any vegetable or animal substances. In mud walls they put straw, chopped hay, hair, flocks, wool, etc., to make the mud adhere to the wood, or laths; whereas the workmen who build in pisé are careful to pick out the least straw or the smallest bit of root which remains in the earth: in short, the pisé is a mineral substance imitating stone, consequently anything that can slake or rot must be excluded.”

easily come out, but if it should happen to stick, let it dry in the air about twenty-four hours, and you will then find that the earth is loose enough to fall out of itself. You must be careful to cover this lump of pisé with a little board; for though a shower of rain, falling in an oblique direction, will not injure it, yet it may be a little damaged if the rain falls perpendicularly, and especially if it remains upon it. Leave the lump exposed to the air, only covered with a board or flat stone, and if it continues without cracking or crumbling, and increases daily in density and compactness as its natural moisture decreases, you may be sure that the earth is fit for building. But you must remember that it is necessary that the earth employed should be taken from a little below the surface of the ground, in order that it may be neither too dry nor too wet; it must be observed also that if the earth is not well pressed around the outside of the tub before it is filled, though the hoops were of iron, they would burst, so great is the pressure of the beaten earth against the mould, of whatever size it may be."

*The Earth-ball Test—An Experiment which may be made at any time.*—"Every person in walking on his ground may make little balls of earth and press them as tight as he can between his hands. If he brings them home and puts marks on them, he will by that means know the quality of every piece of land, and also be a judge of the mixture it will be necessary to make."

#### ON THE PREPARATION OF THE EARTH FOR BUILDING

*Soil Preparation.*—"All the operations of this art are very simple and easy; there is nothing to be done but to dig up the earth with a pickaxe, break the clods with a shovel, so as to divide it well, and then lay it in a heap, which is very necessary, because as the labourers throw it on that heap, the lumps of earth and large stones roll to the bottom, where another man may break them or draw them away with a

rake. I must observe that there should be an interval of about an inch and a quarter between the teeth of the rake, that the stones and pebbles of the size of a walnut, or something more, may escape, and that it may draw off only the largest. If the earth that has been dug has not the proper quality, which is seldom the case, and it is necessary to fetch some better from a distance, then the mixture must be made in this manner: one man must throw one shovelful of the best sort, while the others throw five or six of the inferior sort on the heap, and so more or less according to the proportions which have been previously ascertained."

*Rain.*—"No more earth should be prepared than the men can work in one day, or a little more, that they may not be in want; but if rain is expected, you must have at hand either planks, mats, or old cloths to lay over the heap of earth, so that the rain may not wet it; and then as soon as the rain is over, the men may resume their work, which, without this precaution, must be delayed; for it must be remembered that the earth cannot be used when it is either too dry or too wet, and therefore if the rain should wet it after it has been prepared, the men will be obliged to wait till it has recovered its proper consistency—a delay which would be equally disadvantageous to them and their employer. When the earth has been soaked by rain, instead of suffering compression, it becomes mud in the mould; even though it be but a little too moist, it cannot be worked; it swells under the blows of the rammer, and a stroke in one place makes it rise in another. When this is the case, it is better to stop the work, for the men find so much difficulty that it is not worth while to proceed. But there is not the same necessity of discontinuing the work when the earth is too dry, for it is easy to give it the necessary degree of moisture; in such a case it should be sprinkled with a watering-pot, and afterwards well mixed up together; it will then be fit for use."

*Organic Matter.*—“It has already been observed that no vegetable substances should be left in the earth ; therefore in digging, as well as in laying the earth in a heap, great care must be taken to pick out every bit of root, great and small, all sprigs and herbs, all bits of hay and straw, chips or shavings of woods, and in general everything that can rot or suffer a change in the earth.”

ON THE BOND TIMBER TO BE USED IN BUILDINGS OF PISÉ

*Corners.*—“To make good walls, it is not sufficient that the earth be well beaten, we must also learn to unite them well together. Here the binders cost very little ; they consist only of thin pieces of wood, a few cramps and nails, and these are sufficient to give the greatest stability to buildings of pisé.”

Having gone on to explain that the angles of the building are formed by the successive courses alternately crossing one another on the corner like the alternating “long and short” quoins in a stone building, our authority proceeds to describe how rough boards are laid between the courses of pisé so as to cross at the corner and so, entirely encased in tightly compressed earth, they form effective ties.

“This board must be rough, as the sawyers have left it, 5 or 6 ft. long, something less than 1 in. thick, and in breadth about 8, 9 or 10 in., so that there may remain on each side 4 or 5 in. of earth, if the wall is 18 in. thick ; by this means the board will be entirely concealed in the body of the wall. When thus placed neither the air nor damp can reach it, and of course there is no danger of its rotting. This has been often proved by experience, as in taking down old houses of pisé such boards have always been found perfectly sound, and many that had not even lost the colour of new wood. It is easy to conceive how much this board, from the pressure of the work raised above it, will help to bind together the two lengths of wall and to strengthen the angle.”

*Bonders.*—"It is useful (particularly when the earth is not of a very good quality) to put ends of planks into the pisé after it has been rammed about half the height of the mould. These ends of planks should only be 10 or 11 in. long, to leave as before a few inches of earth on each side of the wall, if it is 18 in. thick; they should be laid crosswise (as the plank before mentioned is laid lengthwise) over the whole course, at the distance of about 2 ft. from one another, and will serve to equalise the pressure of the upper parts of the works on the lower course of the pisé.

"The boards above mentioned need only be placed at the angles of the exterior wall, and in those parts where the courses of the partition walls join to those of the exterior wall, the same directions that have here been given for the second course must be observed at each succeeding course, up to the roof. By these means the reader will perceive that an innumerable quantity of holders or bondings will be formed, which sometimes draw to the right, sometimes to the left of the angles, and which powerfully unite the front walls with those of the partitions; the several parts deriving mutual support from one another, and the whole being rendered compact and solid."

*Strength.*—"Hence these houses, made of earth alone, are able to resist the violence of the highest winds, storms and tempests. The height that is intended to be given to each story being known, boards of 3 or 4 ft. in length should be placed beforehand in the pisé, in those places where the beams are to be fixed, and as soon as the mould no longer occupies that place, the beams may be laid on, though the pisé be fresh made; little slips of wood, or boards, may be introduced under them, in order to fix them level. The beams thus fixed for each story, the pisé may be continued as high as the place on which you intend to erect the roof,"

ON THE TIME AND LABOUR NECESSARY IN BUILDING A  
CERTAIN QUANTITY OF PISÉ

*Speed of Building.*—“Besides the advantages of strength and cheapness, this method of building possesses that of speed in the execution. That the reader may know the time that is required for building a house, or an enclosure, he need only be told that a mason used to the work can, with the help of his labourer, when the earth lies near, build in one day 6 ft. square of the pisé.”

*Rendering.*—“To prepare the walls for plastering, indent them with the point of the hammer, or hatchet, without being afraid of spoiling the surface left by the mould; all those little dents must be made as close as possible to each other, and cut in from top to bottom, so that every hole may have a little rest in the inferior part, which will serve to retain and support the plaster.

“If you happen to lay the plaster over them before the dampness is entirely gone, you must expect that the sweat of the walls will cast off the plaster.”

The wall surface having been duly hammer-chipped, the work must be scoured with a stiff brush to remove all loose earth and dust, and to finally prepare it for rough-casting. Rough-cast consists of a small quantity of mortar, diluted with water in a tub, to which a trowel of pure lime is added, so as to make it about the thickness of cream.

One workman and his labourers are sufficient; the workman on the scaffold sprinkles with a brush the wall he has indented, swept, and prepared; after that he dips another brush, made of bits of reed, box, etc., into the tub which contains the rough-cast, and throws with this brush the rough-cast against the wall.

“Rough-cast, which is attended with so little trouble and expense, is notwithstanding the best cover that can be made for pisé walls, and for all other constructions; it contributes to preserve the buildings. It is the peculiar

advantage of these buildings that all the materials they require are cheap, and all the workmanship simple and easy."

*Local Testimony.*—At the end of the article just summarised, an instructive letter from a former rector of St. John's, La Rochelle, is quoted :

"SIR,—

"My having been an inhabitant for some time of the town of Montbrison, capital of the Forets, enables me to give you some information concerning the mode of building houses with earth, etc.

*A Pisé Church.*—"The church was the most remarkable in this style of building ; it is about 80 ft. long, 40 ft. broad, and 50 ft. high ; the walls built in pisé, 18 in. thick, and crépé, or rough-cast on the outside, with lime and sand. Soon after my arrival, the church, by some accident, was destroyed by fire, and remained unroofed for about a twelvemonth, exposed to rains and frost. As it was suspected that the walls had sustained much damage, either by fire or the inclemency of the season, and might fall down, it was determined to throw them down partially, and leave only the lower parts standing ; but even this was not done without much difficulty, such was the firmness and hardness these walls had acquired, the church having stood above eighty years ; and all the repairs required were only to give it on the outside, every twelve or fifteen years, a new coating of rough-cast.

"A house for a single family is generally finished in about a fortnight. The following is the method I have seen them practise."

*Building Procedure.*—"The earth is pounded as much as possible, in order to crumble any stones therein ; clay is added thereto in a small quantity, about one-eighth part. It is all beaten and mixed up together by repeated blows with a mallet about 10 in. broad, and 10 or 15 in. long, and 2 in. thick. The earth being thus prepared, and

slightly wetted, the foundation of the house is dug for; this is laid with stone, and when it is about 1 ft. high above the surface of the ground, planks are arranged on each side, which are filled with earth intended for the wall; this is called *Pisé* in the dialect of the country. It is strongly beaten; and this method is continued successively all round the building. The walls have more or less thickness according to the fancy of the owner; I have seen them 6 in. and 18 in. thick. If several stories are intended in such erections, they do not fail to place beams to support the floors before they build higher. Of such buildings I never saw any consisting of more than three floors at most; generally they have but two. When the building is thus finished, it is left for some months to dry; then such as wish to make the building more solid and durable, give it a rough-cast coating on the outside with lime and sand. This is what I have observed during a residence of three years in the town of Montbrison. I should be happy if this detail should afford the slightest information to the generous nation which has received us with so much goodness.

“ I am, etc.,

“ JAUOUR.”

*The Virtues of Pisé.*—“ Such is the method of building which has been practised in the Lyonnese for many centuries. Houses so built are strong, healthy, and very cheap, they will last a great length of time, for the French author says he had pulled down some of them which, from the title-deeds in the possession of the proprietors, appeared to be 165 years old, though they had been ill kept in repair. The rich traders of Lyons have no other way of building their country-houses. An outside covering of painting in fresco, which is attended with very little expense, conceals from the eye of the spectator the nature of the building, and is a handsome ornament to the house.



That method of painting has more freshness and brilliancy than any other, because water does not impair the colours. No size, oil, or expense is required, manual labour is almost all it costs, either to the rich or poor. Any person may make his house look as splendid as he pleases, for a few pence laid out in red or yellow ochre, or in other mineral colours.

Strangers who have sailed upon the Rhône probably never suspected that those beautiful houses, which they saw rising on the hills around them, were built of nothing but earth, nay, many persons have dwelt for a considerable time in such houses without ever being aware of their singular construction. Farmers in that country generally have them simply white-washed, but others, who have a greater taste for ornament, add pilasters, window-cases, panels, and decorations of various kinds.

There is every reason for introducing this method of building into all parts of the kingdom; whether we consider the honour of the nation as concerned in the neatness of its villages, the great saving of wood which it will occasion, and the consequent security from fire, or the health of the inhabitants, to which it will greatly contribute, as such houses are never liable to the extremes of heat or cold. It is attended with many other circumstances that are advantageous to the State as well as to individuals. It saves both time and labour in building, and the houses may be inhabited almost immediately after they are finished; for which latter purpose the holes made for the joists should not be closed up directly, as the air, if suffered to circulate through them, will dry the walls more speedily."

#### § IV. INDIAN AND COLONIAL PRACTICE

*A Manual on Earthwork*, edited by Colonel Maclagan, R.E., gives much interesting information as to Pisé-building and a number of valuable hints :

*Shutter-ties*.—"Cross pieces, as the work proceeds,

become so firmly embedded in the wall, that there is great difficulty in extracting them, to remedy which iron bars have been substituted. Even these thin iron bars become so tightly jammed when surrounded by the compact pisé earth, that much labour and risk of injury to the work is incurred in extricating them, and the expedient of setting them in a bed of sand has been successfully resorted to. They are then drawn out with care, the sand also is removed, and the holes which they leave are subsequently filled with the same earth of which the wall is made, and rammed hard.

“The heads of the opposite uprights are held together by ropes, but in practice in this country<sup>1</sup> it has been found that, under the immense pressure exerted upon the plank sides by the earth firmly rammed in the interior, the ropes are so liable to stretch, and to break, that it is advisable to use iron rods or bars in this position also. When ropes are used, the distance between the side planks is measured by gauge rods, and the ropes tightened when requisite to preserve the proper breadth of wall. The use of iron connecting rods renders this unnecessary.”

*Soil.*—“Soil of a medium quality, that is neither very stiff nor very sandy, is considered best adapted for pisé. It may be said that that which would make good bricks will answer well for this description of work.

“When the earth is very dry, a sprinkling of water will be necessary.”

*Foundations.*—“It is usual to begin the work upon a foundation of brick or masonry; but there seems to be no reason why the pisé might not be used from the commencement, even for foundations under ground; being carefully guarded from all chance of injury by running water.”

*The Building.*—“The casing being prepared and erected, and the upper surface of the old work, when above the first stage, being sprinkled with water, the earth, well mixed and slightly moistened, is thrown in, and spread in thin

<sup>1</sup> Indja,

layers of 4 or 5 in. These should, when rammed, be reduced to one-half their original thickness. The rammers should be of hard wood and very smooth. The successive layers are similarly treated, and thus the work proceeds until the top of the casing is reached. The ends of each portion should be finished with a slope, to which will be joined the portion next to be added longitudinally. These joinings should not, in the successive courses, be above those of the lower stage, but as in masonry and brickwork, should 'break joint.' The seams are all distinctly perceptible when the work is complete."

*Plastering.*—"The wall may have a coating of plaster, or the surface may be simply smoothed and dressed with a shovel, or similar implement. When it is to be plastered, it is necessary that the wall should first be thoroughly dry. If dry only externally whilst damp within, it has been found that the moisture is apt subsequently to attack the plaster and cause it to fall off in flakes. Without plaster, good Pisé work is found successfully to withstand exposure to the weather, and after the lapse of many years to be so compact and hard as to be picked down with difficulty."

*Protection.*—"Where the wall is not that of a roofed building, it should be provided with a coping, having a good projection to protect it from rain."

*Rods versus Bars.*—"The substitution of iron connecting bars for the wooden ones has been mentioned above. The evils of the wooden arrangement were found to be: the starting of the wedges, the fracture of the tenons, the tight jamming of the bars in the wall, and the injury to the walls and to the bars themselves from the force requisite to be applied for extracting them. The lower iron connecting bars are made  $3\frac{1}{2}$  in. by  $\frac{1}{2}$  in.; the upper, 1 in. by  $\frac{1}{3}$  or  $\frac{1}{4}$  in. each, having holes  $\frac{1}{2}$  in. by  $\frac{1}{4}$  in., with corresponding pins.

"The mode of setting the bars and arranging the work on each successive elevation of the casing is to cut on the

surface of the completed part of the wall a groove 1 in. wider than the bar, filling it in, after placing the bar, with sand, to the level of the wall's surface. The side boarding being set up, the vacant space left along the bevelled edge of the previous course is filled up with moist clay to retain the first layer of the new course. The end pieces are secured by iron bars or rods, with screws and nuts." <sup>1</sup>

*Ramming.*—"Gentle and quick ramming has been found most effectual."

*Report on the Pisé-work executed at the Etah Jail during 1867-8. By Mr. H. Sprenger, Assistant Engineer*

"The boxes in which the pisé-work at the Etah Jail is being executed consist of two wooden frames 10 ft. long and  $2\frac{1}{2}$  ft. broad, made of planks, which are nailed on to stout battens. They are held together by four pairs of posts 3 in. by 3 in., which are connected above and below with tie-bars of flat iron  $1\frac{1}{2}$  in. by  $\frac{1}{4}$  in. The tie-bars have at each end a certain number of  $\frac{1}{2}$  in. holes punched in them to receive pins for the purpose of preventing the posts from slipping off. By changing the pins, walls of any given dimension can be obtained, wedges of hard wood, with longitudinal slots, are introduced between the posts and the pins, to adjust the breadth of the boxes to a standard gauge. After the boxes are fixed and adjusted, they are secured in their position by ropes passing over them, and tied to stakes on each side. Any deflection from the vertical should be corrected at the commencement of the work, as it is impossible to alter the position of a box after it is half full. Any earth which is suitable for brick-making will do for pisé-work. On being dug out it is passed through

<sup>1</sup> "A convenient arrangement might be: to make the lower and upper connecting bars alike, to raise the side boarding a few inches above the upper bars, which, when embedded, might be allowed to remain and become the lower ones of the next course; the external apparatus being shifted by taking out the pins and slipping off the stanchions and planks to be re-applied to the upper bars already in position to receive them."

a screen with  $\frac{1}{2}$ -in. meshes, and thrown into the boxes in even layers of 6 in. in depth.

“Generally fresh earth contains sufficient moisture to ensure good consolidation ; but if it is found that it jumps up under the rammers, it should, on being thrown into the boxes, be sprinkled with a little water out of a tin can with a rose. The watering should be as uniform as possible, as if it is applied unequally it will liquefy the earth, which will commence oozing out under the rammers. Pisé-work executed with too much water is worse than if done with dry earth, as, on account of the elasticity of the wet earth, the effect of the ramming is deadened, and the earth remains unconsolidated. The men should be prohibited to keep time in ramming, as it causes vibration, which is injurious to the stability of the wall. On working over a lower course, it is as well to let the lower tie-bars about 4 in. into the same to give the boxes a firm hold on the old work, thereby the joints become imperceptible, and the upper edge of the lower course is prevented from chipping off.

“The implements used are three different kinds of rammers. The earth is first beaten down with a V-shaped rammer, and then surfaced with one with a flat bottom. The sides of the boxes are consolidated with a spade-shaped rammer. When commencing the pisé-work at Etah, considerable difficulty was experienced in extricating the lower tie-bars. These were, therefore, supplied with holes 3 in. apart throughout their whole length. A pin was inserted, against which a crow-bar with a long slot and well bent at the end was made to work. An equal pressure could thereby be exerted against the tie-bars ; they were thus extracted with great facility without injuring them or the face of the wall, which was not the case formerly.”

*Supplementary Note by Mr. E. Battie, Executive Engineer,  
5th Division, Grand Trunk Road*

“The work at Etah has generally been concluded in the

following manner: In the morning the boxes were taken down, and again put up and filled during the day; they were left during the night, so that the earth might detach itself from the sides. It is not advisable to allow a course to dry thoroughly, as the upper one will not bind well into it, but probably show a crack. If the earth is well rammed, and only the proper quantity of moisture admitted, a second course can be commenced immediately."

The Report of the Rhodesia Munitions and Resources Committee issued in 1918 contains an interesting paper by Mr. John Hynd on Pisé-building, from which the following is extracted:

*"Pisé de Terre Buildings*

"*The Spectator* took this matter up some two years ago and wrote as follows:

" 'Various schemes of land settlement are in the air. . . . All of them must, however, be concerned with cheap buildings. That is a *sine qua non*.' . . .

"The material used for the walls at Empanjeni is one-third sand, one-third ant-heap, and one-third soil, all pulverised and put through a sieve. Water is then added. The mixture must be neither too wet nor too dry, just sufficiently damp to bind; a good indication of the correct consistency being that when squeezed hard by the hand it shows a tendency to bind. Sufficient of the loose mixture is thrown into the form to fill it to a depth of about 3 in., and this is thoroughly rammed before the next layer is put in. Most thorough ramming is essential. When the frame is rammed full, it is taken apart and shifted along to make another section and so on until the first layer is complete. The first layer is, as a rule, sufficiently dry to permit the starting of the next about three hours after laying. Door and window frames are put in as the work proceeds, and must be well braced while ramming. In the top layer hoop iron or fencing wire is let in for fastening down the wall plates. Arsenite of soda or Atlas Compound

is used in the first layer or two to keep out white ants. The floor can be made of timber, cement concrete, or rammed earth, and the roof thatched or covered with corrugated iron as is most convenient.

“The following Pisé de terre buildings have been erected at Empandeni :

“A large schoolroom 75 ft. by 28 ft. by 12 ft. high, walls 14 in. thick ; seven boys' dormitories, each 30 ft. by 20 ft. by 12 ft. ; twelve single-room houses, each 16 ft. by 12 ft. ; six fowl houses, each 20 ft. by 10 ft. ; a large fowl house 250 ft. long, front walls 7 ft. and back walls 5 ft. high. This building is divided into fifteen compartments.

“From the foregoing description it is quite evident that cheap and efficient buildings of this nature can be erected at a very low cost.

“On a farm it is not necessary to employ any skilled labour, as the doors and windows can be purchased ready-made, and the frame work, clamps, etc., put together by the farmer himself. For a roof of thatch all the necessary material, except iron ridging, if this is used, can as a rule be procured on the farm.

“Should a cement concrete floor, which is cheaper than a wood one, be desired, there would be an extra expenditure for cement, the amount required being about two bags per twelve square yards. Such a floor should be laid before the walls of the building are commenced, and it is essential that the site is thoroughly well rammed and consolidated, particularly below where walls will come, before laying the concrete, to prevent cracks developing through settlement. The concrete raft should be carried at least 6 in. beyond the outside walls of the building, and if the work is properly done, a special ant-course will be unnecessary. The concrete can be left rough below the walls to give a bond, and it might be advisable to lay some pieces of hoop iron in it which would be left projecting to be bedded into the walls.

“Another good type of floor would probably be that suggested in *The Spectator*, viz. road material laid down and tarred in the same manner as roads are now made in many places.

“A number of rooms and houses have been erected on the Globe and Phœnix Mine on much the same principle as Pisé de terre buildings, but the system developed there is different as regards the mixture, which consists of two parts ant-heap or ordinary dagga which must not be too sandy, and three parts ashes or clinker sieved free from fine dust.

“A very full description of the method employed on this mine was forwarded by the courtesy of the Manager to the Committee, and it is interesting to note from this that the walls are made waterproof by first making them smooth with dagga plaster, then, when quite dry, giving one good coat of boiling hot tar. A coat of limewash is applied three days later. That this is effective is well evidenced by the fact that the buildings erected have successfully withstood our last abnormally heavy rainy season.

“The Globe and Phœnix system is the result of a number of experiments carried out on that mine. Their mixture, which is stated to be ant-proof, contains more moisture than Pisé de terre, and each course is reinforced with old wire rope, or other suitable scrap. The material is left in a heap for one or two days before being used.

“Circular huts have been built on the mine of the same material, the forms being made of two rings of corrugated iron in three or more sections joined up with cleats at the end laps and held in position with cross bolts and distance pieces. The inner ring is 9 in. less radius than the outer one.”

*Extracts from a paper on Pisé in the “Farmers’ Handbook,” issued by the Department of Agriculture, New South Wales, 1911*

“Pisé is a material readily obtainable by the settler,



of which cheap and durable buildings can be easily and substantially erected.

“For the construction of pastoral or agricultural buildings, especially in districts remote from railways, or from towns in which other building materials are cheap or easily procurable, pisé is particularly well adapted. In the country earth is plentiful and readily obtainable; in the city or town such is not the case, and this fact, combined with the very bulky nature of the material, prohibits its use in such centres of population.

“To the selector or settler, who, like many of our successful pioneers, is not burdened with a superfluity of hard cash, but who possesses an abundant capital of energy, combined with a certain amount of handiness, pisé has an additional advantage (which it shares with slabs, wattle and dab, etc.) over most other building materials, in that it affords him an opportunity of erecting his homesteading largely as the result of his own labour.

“As a building material, pisé is infinitely superior and more durable than slabs, galvanised iron, or weatherboards. In fact it is questionable whether it is not more suitable for our climate, and therefore to be preferred to brickwork; for pisé buildings, properly protected and finished, are quite as durable and much cooler than buildings constructed with solid brick walls. This statement may be questioned by some whose knowledge of pisé is limited to buildings so badly planned that the very elementary principles of building construction have been neglected. This neglect, which is all too common, makes things bad enough, but when to it is added, as is sometimes the case, indifferent workmanship, combined with the use of unsuitable material, the result does not call for admiration, and it is not surprising that a bad impression is created. With no other knowledge of pisé it is only natural to condemn it because of such specimens, but under similar circumstances other better-known

building materials of proved excellence would also be condemned. Brickwork would just as readily be condemned if its building qualities had to be estimated by the appearance presented by a brick building which had been constructed of badly-burnt bricks laid by unskilful tradesmen on an imperfectly thought-out plan. Just as with other building materials, the possibilities of this material can only be judged by an examination of properly planned and constructed examples of the pisé-builder's art. Such are found here and there throughout the country, pleasing to look at, affording comfort and satisfaction to their owners. A properly constructed pisé building can be finished to suit the taste of the most fastidious. Even without plaster the walls can be 'floated' down and a 'skin' obtained on them which, when limewashed, resembles stonework. When plastered inside and out they possess the advantages of a stone house, and are erected at a fraction of the cost.

"Some idea may be formed of the durability of pisé by the fact that there is a stable built of pisé which has been in constant use for over sixty years, and which at the present time is in good order. The good condition of this stable is the more surprising because the external walls are unprotected from the weather, and it is generally recognised that pisé-work, especially if unplastered, should be protected from the direct action of rain. Pisé buildings are said to have a life of a century and a half.

"The stability of pisé buildings is beyond question, as is proved by the following instance:—At Lambrigg, a second-story brick building, with 14-in. walls, and containing ten rooms, is built upon a lower story of pisé. The brick-layer who had the contract for erecting the brick portion of the house refused, as it was built upon pisé, to guarantee his work. Some time after the completion of the house he visited it, and after a thorough examination of the building, declared that it was the most substantial brick

house in the district, as it had not a crack in it, a feature which was somewhat unusual in that locality. Another case bearing on the same subject is that of a residence at Temora. When this building was being constructed the workmen omitted to leave holes for the bolts which were to secure the verandah plates to the walls, as it was thought these could readily be bored out afterwards with an auger. On attempting to bore out these holes on the completion of the building, and when the pisé-work had become drier, the operation of boring proved so difficult as to be practically impossible, and had to be abandoned.

“The merits of pisé-work have been recognised in France, India, Mexico, and California for years past, and seeing its equal suitability for our climate, it is surprising that these merits have not led to its being more extensively used. The principal reason for this seems to be because our builders are averse to undertaking this class of work, and in consequence the bulk of it is placed in the hands of untrained men, who, whilst quite fitted to carry out the pisé-work, are not competent to undertake the other constructive work of a building. However, they do not hesitate to do this, as well as to undertake the more important work (though unrecognised as being so) of planning out the building. The result is in most cases an improperly planned and defectively constructed building, which appeals to no one, but has a tendency to bring pisé into disrepute.

“The reason for a builder's unwillingness to undertake pisé-work is not far to seek. For the successful carrying out of his work a builder relies upon skilled tradesmen; our tradesmen are trained in cities and towns, and as pisé is not a suitable material for such places, tradesmen do not become familiar with it. A good builder with a reputation to lose shrinks from placing that reputation at the mercy of a pisé-builder, who is not recognised as a tradesman, and in whom, in consequence of this, a builder is likely to have little or no confidence.

“The actual erection of pisé-work presents so little difficulty that it can be done by any one who has sufficient strength to shovel earth and wield a rammer, provided he will exercise care to see that the moulds or boxes into which the earth is shovelled are kept plumb and in straight lines. The average settler, even with no previous knowledge of pisé-work or building construction, need have no hesitation in undertaking the pisé-work of his own buildings if he works to a well-thought-out plan drawn up by somebody competent to do so.

“The necessity of having a plan prepared by some one who understands the principles and requirements of simple building construction, before undertaking the erection of any building, cannot be too strongly emphasised. This great need, which is often overlooked by the settler, cannot be economically dispensed with. The securing of a properly prepared plan is of the greatest value towards obtaining a building of the maximum strength and durability, combined with the best appearance and greatest convenience, for the least cost. Even when a settler undertakes the pisé-work of his own building, it will only be in rare instances that he will not have the advantage of trained supervision during its erection. The services of a tradesman will invariably be found necessary to make doors and window frames, construct the roof, etc. This workman can be engaged when the building is started, and whilst preparing the timbers of the roof, in readiness for the time when they will be required on the completion of the pisé-work, can supervise the fixing of the door and window frames, and see they are set correctly, and in their proper places.

“Pisé walls are constructed in sections, the extent of which is regulated by the supply of casings available.

“Into the moulds formed by the boxes the earth is shovelled in layers of 4 or 5 in., and then rammed until thoroughly solid before another layer is put in. On the completion of the section, *i.e.* when the mould is full and

well rammed, the keys or pins are knocked out of the 'bolts,' and the 'boxes' taken apart and erected on another portion of the building. The top of that portion of the pisé-work on which it is proposed to erect another section should be well moistened and covered with wet bags some hours before the mould is formed. The bottom of the mould should overlap the top of the pisé-work by about 6 in. After the 'boxes' are put together, the top layer of pisé should be loosened with a pick so as to form a bond with the section about to be built, and if this section adjoins one already built, the ends of the latter should be bevelled off so as not to form a straight joint.

"Material which is too sandy will fret away, and one containing clay will crack when dry. Soils containing these defects should be avoided. There is, however, such a wide range of soils which are suitable that a holding of any size on which suitable soils cannot be found will be the exception. It is possible to remedy the defects found in one soil by mixing it with another soil, but very rarely will such a course be necessary.

"The plant required will depend upon the number of men to be employed. Three is the least number that can be economically employed—two attending to the boxes and ramming, and one carting earth from its location to the building and assisting generally. The plant required for this number of men is given below. If more are engaged, additional plant of the same character will be found advantageous.

"The necessary plant will consist of—2 wooden rammers, 1 iron shod rammer, 2 straight boxes, 2 angle boxes, 3 casings for blocking up the ends of boxes, bolts and keys for same, 12 gauge rods, washers—a liberal supply of  $\frac{3}{4}$ -in. washers, 2 shovels, 1 spade, a horse and dray or other means for transporting the material to the building (if required)."

The following detailed instructions are taken from the same authority :

## SPECIFICATION CLAUSES FOR A PISÉ HOUSE (NEW ZEALAND)

*Excavator.*—Remove the turf to make footings, but not deeper at any place than 3 in. Step where required.

*Pisé-Builder*

*Walls.*—Erect the walls as shown on plan, external walls 18 in., internal walls 15 in., carried up plumb and true, with all cross walls properly bonded by continuing the pisé-boxes around all angles; when necessary, the material for the walls is to be properly tempered with sufficient water. All sticks and vegetable matter are to be removed.

*Suitable material:* to be a pipeclay loam, with a trace of small gravel evenly distributed through it.<sup>1</sup> The boxes to be filled in thin layers of 4 in. at a time, and well rammed until solid; the workmen are not to use their rammers in unison.

The whole of the internal angles, also door and window jambs, to be neatly splayed.

*Floating.*—Moisten well the outside and inside walls before the floors are laid, and float same to even smooth surface with wooden hand-float, using weak plaster, where required.

*Bolts.*—To hold down wall-plates, provide and build in  $\frac{1}{2}$  in. bolts, not less than 15 in. long, and spaced not more than 6 ft. apart.

*Damp-course.*—Below all walls lay a three-ply Ruberoid damp-course the full width of walls, to lap at ends at least 4 in.

*Ventilators.*—Insert below floors, where directed, four 9 in. by 6 in. galvanised iron air gratings, in wooden frames  $1\frac{1}{2}$  in. thick by full width of walls; also insert at about 18 in. below ceiling similar air gratings and frames.

*Plugs.*—Insert plugs 3 ft. apart for skirting, chair and picture rail, at the heights directed.

<sup>1</sup> This was specified because it was the best material near the site,

*Frames.*—Set all frames plumb and true, and secured in wall before removing head. Lintels and heads must be well and solidly bedded in mortar, at proper heights. The whole of the work to be done in a proper workmanlike manner.

*Fillet.*—Finish against intersection of floor and wall with neat  $1\frac{1}{2}$  in. quarter-round fillet, scribed to wall and floor and nailed to floors.

The pisé-builder will require to build into wall at all window and door openings 3 in. by 3 in. shaped plugs, spaced not more than 3 ft. apart to secure architraves.

*Lintels.*—For all door and window openings provide 6 in. by 4 in. well-seasoned pine lintels, to extend 12 in. into pisé-work on each side of opening.

*Skirting.*—Provide and fix in all rooms, to plugs about 3 ft. apart, 6-in. skirting, neatly scribed to floors, mitred at angles as required.

*Picture-rail.*—Provide 3 in. by 1 in. picture-rail to all rooms.

*Plugs.*—Prepare and tar for pisé-builder 3 in. by 1 in. well-seasoned softwood plugs, 15 in. long, as per detail, for skirtings, picture- and chair-rail, to be inserted 3 ft. apart.

#### STUDDING, WIRE-NETTING, AND PISÉ

“This is a modification of Pisé, which provides a settler in a district where poles and saplings are available with a quick method of providing himself with a comfortable temporary residence without the expenditure of much cash. To construct buildings of this character, a framework of saplings or poles, at intervals of 3 ft. 6 in. to 3 ft. apart, is first erected; this framework is covered on both sides with  $1\frac{1}{4}$  in. mesh wire-netting. The two sections of netting are held together, strengthened, and prevented from stretching and bulging between the posts by means of wire hooks or loops, which are as long as the posts are wide.

The spaces thus enclosed by the netting and the poles are then filled with earth, which is well rammed, thus making a solid wall 4 in. to 6 in. thick. This wall can be plastered, the plaster forming a key with the wire-netting, which holds securely. Buildings of this character can be made to look rather attractive, and, if neatly constructed, are very much superior, both in appearance and comfort, to slabs or wattle and daub."

#### PISÉ SHUTTERING

##### I

That the plant now commonly in use for pisé-building is but a slight improvement on the anciently accepted model, may be seen by a comparison of modern examples with old engravings and descriptions. Pisé-building lay off the great main stream of constructional activity, and the enterprise and ingenuity lavished on the perfecting of other building materials and methods passed Pisé by, leaving it undisturbed in its quiet backwater, a primitive system still with its primitive tackle.

Yet there were a number of very obvious and unnecessary shortcomings in the accepted shuttering that seemed to clamour for attention, defects, too, that were in no way inherent, but merely traditional infelicities reproduced in succeeding models that remained remarkably true to their primitive ancestral architype—the Pisé plant described by Pliny.

Here seemed to be a very promising field for an ingenious inventor, a field that is still "To Let."

In the absence of any such inventive genius, the author has had certain ideas of his own embodied in the "Mark V" type of shuttering—a type that further experience and experiment will doubtless modify.

The principle of the building-process remains unaffected. The improvements, such as they are, are merely improvements of mechanism.



# DIAGRAM OF MARK-V PISE SHUTTERING.

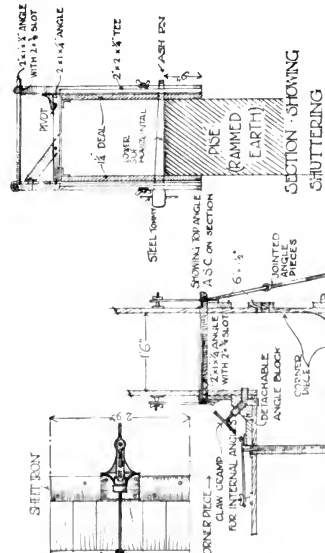
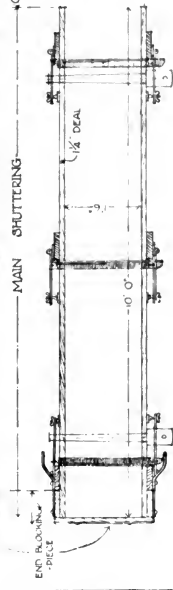
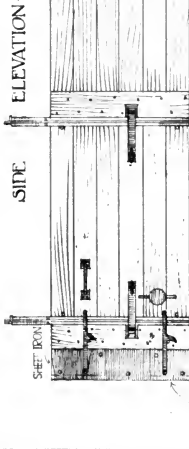
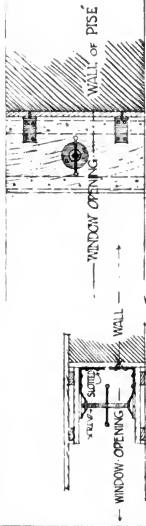

*Chas. J. ...*



MARK V SHUTTERING.

Showing top cross-braces thrown back and free leg disengaged.

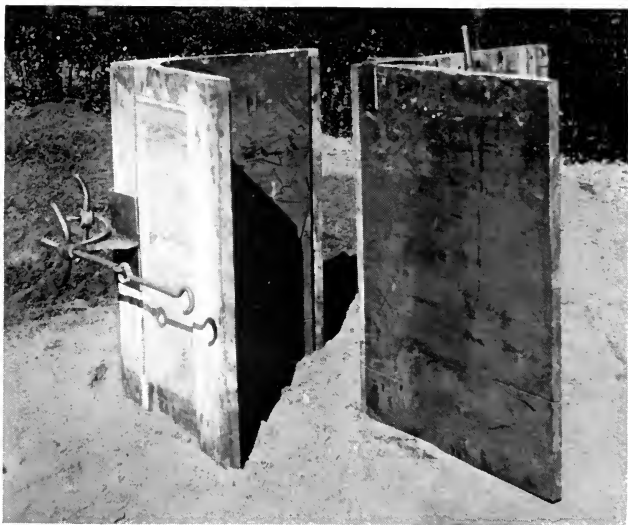

MARK V SHUTTERING.

Showing screw-up securing tackle of exterior corner-piece and its rounded interior. Also screw-cramp at interior angle of shuttering,

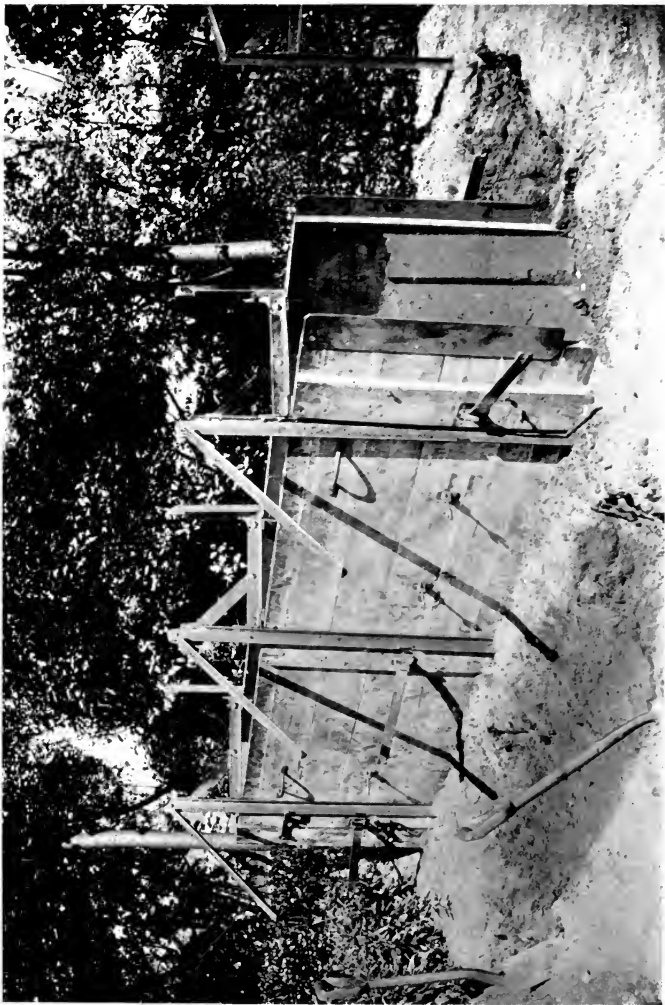

MARK V SHUTTERING.

Shuttering about to be removed from a first section of Pisé walling. Top cross-braces have been thrown back and clamps to legs released. It is now only necessary to detach the stays and lift away the shutters. Where, as here, there is no masonry plinth, the bearing-pins are only required for the succeeding courses of Pisé, and need not be inserted for the first.



MARK V SHUTTERING.

The angle-iron stay with cross-brace raised, and the blocking-box showing its internal clamping-gear.

Scientific research could doubtless, if it would, do much towards perfecting Pisé-building.

We know very little about the behaviour of different earths under compression, or of their several reactions to chemical treatment. Meanwhile, a few trifling mechanical modifications are all that distinguish our modern plant from that devised by the ancients. That said, a short description of the "Mark V" model may be of some interest, pending the future developments that may now be hoped for.

## II

The chief desiderata in designing a satisfactory Pisé plant appear to be these :

All constituent parts should be reasonably light and easy to handle. The shutters should be rigid and not liable to warp, without being expensively constructed. The shutters, when clamped in position, should be firmly and positively supported, without deviation from the vertical.

The fairway between the shutters must be as little obstructed by the cross-braces as may be, leaving good room for the men on the wall to tread and ram.

The through-pins by which the shuttering rests upon the base wall or on a completed course of Pisé, must be easily withdrawn without injury to the wall.

The shuttering must be easily disengaged and removed from the wall, one side at a time.

The special corner-piece must have some means of rigid attachment to the ordinary shutters on the two meeting walls.

There must be some means of blocking off the shuttering at any desired point, for the forming of door or window openings at any level.

The whole apparatus must be as simple and as fool-proof as possible, and built to stand rough usage and exposure to the weather.

## III

The author has attempted to construct a plant embodying these essentials, and the working drawing and photographs shown will give the reader a tolerable idea of his "Mark V" model.

The thing has, at the moment of writing, only been experimentally tested in one of the London parks. These trials were, however, sufficiently satisfactory to encourage a belief that the new plant will prove a very considerable improvement on the old. It has now been despatched to a site in Surrey, there to undergo the searching and very practical test of being used for the building of a small-holder's house and homestead.

III  
*CHALK*





### III

## CHALK

### § I. GENERAL

CHALK, as a source of lime, has always been of high importance to builders, and, until improved transport brought alien materials into its old preserves, chalk was in general use for walling in the form of roughly squared blocks.

Chalk again forms the basis of a compost that, used in the form of a stiff paste, has been largely employed for building from the earliest times down to the present.

“Pisé de Craie,” or chalk consolidated by ramming within a casing, is a form of building that has been long held in high repute in France and elsewhere, but which has only recently been given a serious trial in England.

Chalk in all these forms, if fairly dealt with and reasonably protected from the weather, is a most amenable and satisfactory material to build with.

The last-named method particularly seems to promise results that should satisfy the most exacting critics of the unconventional, as it assuredly does those who inhabit the cottages so constructed.

The several systems of chalk construction are fully dealt with in the pages that follow.

*Chalk Compost : Historical.*—At the Ancient British village on West Down, Chilbolton, some five miles south of Andover, delving archæologists have brought to light undeniable fragments of chalk “Daub,” with the wattle marks still clearly showing upon them.

This discovery is chiefly of academic interest, though

it is a pretty refutation to those who regard any building material save brick and stone as "new-fangled," and it should also serve to hearten the doubters and the timid amongst us who seek historic sanction for any departure from current building practice.

*Composition and Uses.*—In the Andover district Chalk Compost or "Chalk Mud," as it is called locally, is prepared and used as follows :

The chalk is dug out in the autumn, and the frost allowed to play on it during the winter. In the spring building starts, and the weathered chalk is spread all around the outside of the walls. Straw is sprinkled on it and it is then well-trodden, usually by the workers, but sometimes by horses. Sometimes chopped straw is added, sometimes unchopped straw is sprinkled on. The quality of the walls depends very largely on the preparation—that is, in getting the mud to the right consistency—and the old hands know by experience when it is ready.

The compost is lifted on the wall by a fork and another man stands on the wall and treads it in. It is then chopped down straight with a spade. Some of the naked walls at Andover show traces of the courses, which are usually something under 2 ft. in height.

Where a course has to be left unfinished it should be ended with a diagonal ramp so as to splice in with the work that follows.

Some of the old builders seem to have been somewhat catholic in their conceptions as to what constituted "chalk," and vague patches of earth, loose flints and other stray substances not infrequently mar their work and sometimes seriously reduce its strength.

As a general rule, the finer the chalk the stronger and more durable is the walling.

What is aimed at is a conglomerate of small chalk knobs cemented together by a matrix of plastic chalk and straw, the whole forming as dense a mass as possible.

Grinding in a mortar-mill would probably reduce all the chalk to an amorphous powder, which would not be desirable, and in any case such mechanical mixing is quite unnecessary.

Building by ramming the moist compost between timber shutterings does not appear to have been practised in the past, though there is nothing against the method except its tendency to delay the drying out.

The drying of each course takes several days, depending on the weather. A course is usually laid right round the building. It must be covered up at night in case of rain, and when it is hard another course is laid on, and so on till completion. The aim is to build during the summer and autumn, and when the moisture has dried out, to render the exterior.

Where brickwork is used with chalk compost it is generally bonded in in the ordinary way, but block-bonding the depth of a chalk course is a better way of doing it.

The exterior corners of chalk buildings are the vulnerable points, and these should therefore be well rounded off.

*Timber.*—In the old work nothing seems to have been done to prevent woodwork built in to the compost from decaying, though in many cases it has survived surprisingly. In any new work, however, proper ventilated air-spaces should be contrived or the timber ends treated with some preservative.

The door and window frames are fixed to fairly large pieces of wood built in across the thickness of wall, and other woodwork is fixed to wood blocks built in in a similar way.

Picture-rails should be provided in all rooms, as chalk walls are apt to flake and chip if nails are driven into them.

Lintels are usually of wood, and when plastering is carried down over these some form of key must of course be provided to hold it.

*Frost.*—New work must not be exposed to frost or there will be danger of collapse, and winter work is barred out for this reason.

*Repairs.*—Chalk compost walls are not easily repaired in that material, and bricks are generally used, well bonded in.

*Chimneys.*—Chimneys, too, are usually of brick, though there would seem no reason against the flues being carried up in chalk, especially if clay pipe linings were used.

The chimney-stacks above the roof might well be built in flint, the corners being rounded off in deference to the peculiarities of the material.

*External Rendering.*—It is of the first importance that a good weather-tight skin be maintained, and many old buildings have suffered through neglect of this precaution.

The rendering was often of the poorest quality, more mud than lime, and the constant repairs that the indifferent materials necessitated has resulted in many of the old cottages becoming patchworks of variegated plaster blotches, when not whitewashed over, which give an impression of dilapidation by no means warranted by the facts.

*Rendering.*—Given a good skin, however, of cement or cement and lime, a chalk conglomerate wall will last indefinitely. So vital is the skin that it is as well to put it on in two good coats—rounding off all the corners and finishing it either with slap-dash or rough from the wooden float.

Also, to ensure its proper adhesion throughout, wire-netting may be used as reinforcement—being secured to the face of the chalk wall by means of cross netting or wires laid on the wall as the building rises.

If the netting be of a fine mesh it also serves as an absolute barrier to vermin, though pounded glass incorporated in the base of the wall is equally effective.

*Strength.*—Provided the wall has dried out thoroughly, any of the ordinary loads occurring in a two-storied house can be borne with ease.

Chalk conglomerate walling, however, has no great lateral strength, and it should not be asked to stand up to thrusts.

The roof, therefore, must be well tied, and should sit on the building merely as a lid.

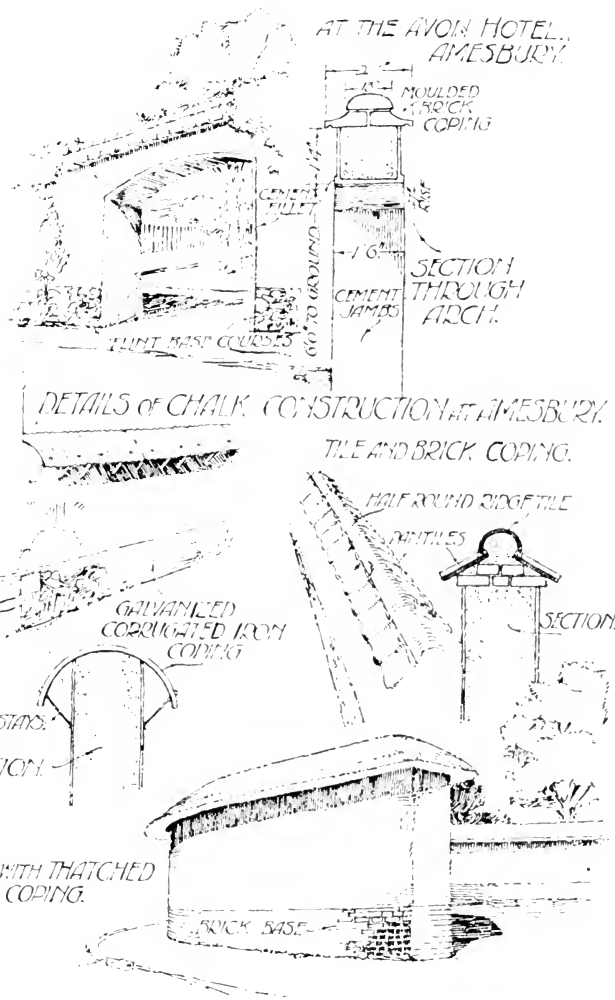

DETAILS OF CHALK CONSTRUCTION AT AMESBURY.

(From a sketch by W. R. Jaggard, F.R.I.B.A., the copyright of the Department of Scientific and Industrial Research.)

CHALK CONSTRUCTION AT AMESBURY.  
WILTSHIRE.

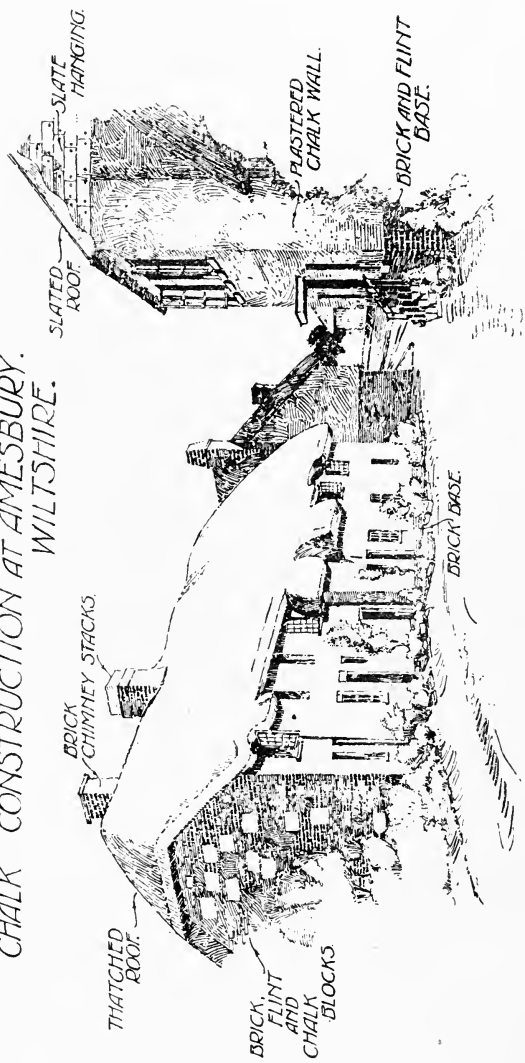

COTTAGES AT COLDHARBOUR. AMESBURY.

CHALK CONSTRUCTION AT AMESBURY, WILTS.

(From a sketch by W. R. Jaggard, F.R.I.B.A., the copyright of the Department of Scientific and Industrial Research.)

*Roof.*—Though thatch is the traditional roofing material of chalk cottages, any other will serve that is permanent and good of its kind.

The only special demand that chalk walls make is that the eaves shall be generously overhung for their better protection from the weather.

Where, in later years, the boldly projecting thatch has been thoughtlessly replaced by a slate roof with meagre eaves, or with none at all, the walls have suffered accordingly.

*Garden Walls.*—A chalk garden wall must be afforded just as much protection as the wall of a house and on both sides.

The hat with which it is provided is of the highest importance to the health and longevity of the walling.

Examples of garden wall copings are given in the sketches shown below.

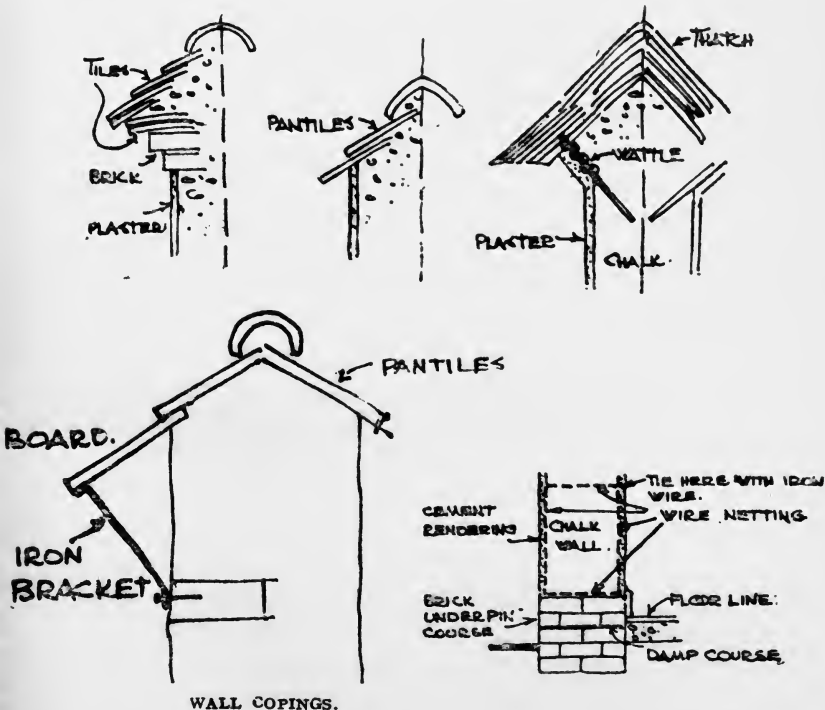

WALL COPINGS.

*House Walls.*—Chalk conglomerate walls rarely exceed 18 in. in thickness, and are usually the same upstairs as down.

A plinth of the same thickness as the chalk wall it supports is usually carried up 6 in. to 18 in. above the ground level in rubble-work, flint, or brick, being known as the "Underpin Course." Any of the stock damp-courses are suitable, but they must be well and truly laid, as damp feet are nearly as deleterious to a chalk wall as a leaky or inadequate hat.

No special tools are required for this method of building, an ordinary farm fork for lifting and a spade for the final chopping down of the wall faces being all that are necessary.

A house built during the summer is usually fit for occupation the same autumn.

*Old Examples.*—Those who may wish to see buildings in chalk conglomerate, both old and new, would do well to visit some such typical chalk district as that lying about Andover in Wiltshire.

It should, however, be constantly borne in mind that most of the old cottages were somewhat unscientifically erected by their original jack-of-all-trades occupiers, that damp-courses and Portland cement were unknown, and that the advantages of proper ventilation and the causes of dry-rot were discoveries yet to be made.

Secondly, a large number of these cottages have been sadly neglected either recently or in the past, and they bear the disfiguring marks of their ill-treatment upon them now.

But a chalk cottage that is well found in the beginning, and that is reasonably well cared for subsequently, has nothing to fear from comparison with cottages built in the most approved manner of the more fashionable materials.

Mr. James Thorold gives the following particulars of a block of three chalk cottages recently built for Sir George Cooper on his estate at Hursley, near Winchester :



“The chalk walling was done by Messrs. A. Annett and Son, of Winterslow, near Salisbury, where this method of building has been kept alive from olden days. It consists of working up the soft upper strata of the chalk by putting a bed of it 4 ft. 6 in. thick on the ground, watering and treading it to a sticky consistency with the feet, working in shortish straw at the same time. When thoroughly mixed by the builder’s mate, he lifts up a forkful to the builder working on the wall immediately above him, the latter catches the chalk, dumps it down on the top of the wall, building an 18 in. course all round. As soon as the weather has dried this sufficiently he goes round with a sharp spade squaring up both sides of the wall. As this work is greatly dependent on the weather it is well if the men have other work to fall back on, and that building operations should be commenced in the spring or early summer. The wall is built 18 in. thick to the first floor joists and 14 in. above. Chalk in itself being very absorbent of moisture, the usual plan is to render the outside of the wall with a lime mortar, which, however, requires renewal every few years. To obviate this we fixed with long staples 1¼ in. mesh wire-netting over the outside surface of the wall to give a reinforcement for a rendering of hair mortar and cement gauged in proportion of 1 to 2 respectively, and left rough from the trowel. This rendering was done at a cost of 3s. 3½d. per square yard, which is a substantial addition to the cost of the walling, but so far there is no sign of a crack or hollow place behind it, and the cottages have kept very dry. The walls were finished off with a limewash containing Russian tallow and copperas.<sup>1</sup>

“As regards the cost of this block of three cottages, the result is obscured by the fact that tall chimney-stacks with ornamental bricks and appropriate foundations were built and reinforced leaded lights were used in the windows

<sup>1</sup> See recipes for Whitewash in Appendix (I).

to keep the building in character with the other cottages on the estate, but at the time we estimated that the chalk walling saved a sum of £54 as against the amount we should have had to have spent in carrying out the building with bricks made on the estate, and this had to include lodging money and profit, the builders being independent men. The ornamental chimney-stacks were put in for the sake of appearance, flues built up in the chalk being entirely satisfactory and fireproof. The foundations are either flint or brick with a slate damp-course.

“I consider that for a chalk country this method of building has many advantages.

“ (1) It saves cartage.

“ (2) It can be carried out by a skilled labourer who can be otherwise employed during unsuitable weather.

“ (3) No fuel is required as in burning bricks.

“ (4) If a suitable rendering is employed to keep it weatherproof, and a good damp-course on the foundations, the cottages are nice and dry and keep an equable temperature, chalk being a good non-conductor.

“Sir George wonders if any method could be devised by chemical means to harden the chalk and make it weatherproof; if this could be done it might save the expense of the cement rendering.”

#### CHALK CONGLOMERATE

From *Country Life*, February 23rd, 1901 :

“Soft chalk is practically mud, yet Dr. Poore, one leading authority on rural hygiene, had his model hygienic cottage built with it at Andover, just outside the boundaries, in order to escape the tyranny of the bye-laws. In several other places this material has been used time out of mind.

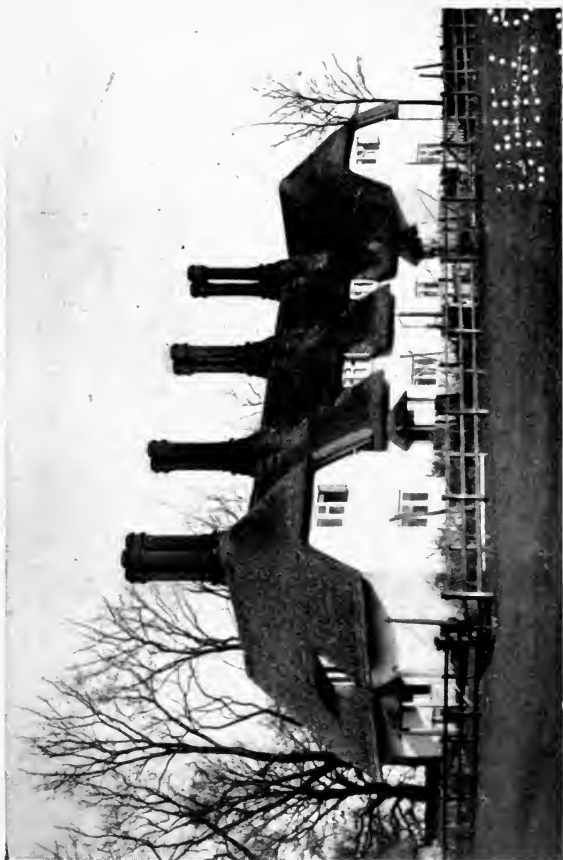

THREE CHALK COTTAGES AT HURSLEY PARK.



“The white cottages on the Wiltshire Downs are as good as any in England.”

THE WINTERSLOW COTTAGES

From *Country Life*, April 6th, 1901 :

“The white chalk cottages of the scattered straggling village are found in every sort of position. They must not be confounded with the cottages of rock chalk at Medmenham. You might almost call them mud cottages.

“The house is generally both planned and constructed by the owner.

“. . . the soil is only a few inches deep, soft chalk lies close to the surface and can be dug out with a spade. This is a very suitable material in the district and costs nothing but the labour of digging. . . .

“On the downs there is a constant lack of water ; that which falls in the shape of rain is therefore very precious, and in some cases is indeed the only kind available. But a large tank or artificial well is needed to contain it, and the pit from which the chalk is dug out can be made to serve the purpose. . . . One was made watertight by means of a lining of concrete, and held enough water to keep the family going through all the dry season.

“In another house . . . the chalk-pit had been utilised to form a large and convenient cellar. . . .

“Most of them (the cottages) . . . are on two floors, with parlour, kitchen, back kitchen and so forth on one, and the bedrooms on the other. In the preparation of the chalk, the method followed is that of treading it into a kind of rubble, and adding a proportion of straw and a small quantity of lime.

“There is a local builder who will run up the shell of a house for a matter of £100, more or less, according to its size. . . . Most of the cottages are literally hand-made. A skilful architect who visited the Winterslow cottages

felt sure that boards must be used to keep the walls straight, but he was wrong. The chalk is shovelled up and the walls are kept straight without line or plummet. No expensive scaffolding or machinery is employed. Yet the walls come out beautifully in the end, the colour being an exquisite soft white. They are about 18 in. thick, and the slowness of their construction has one good effect, it gives them time to dry. No point is of more importance than this. It is advisable not to put on any rough-cast, plaster, or paper for at least twelve months, as doing so will prevent the moisture from exuding. One or two of the little cottages were slightly damp, but the majority were as dry as tinder. The thickness of the walls helps to render the cottage more comfortable, to make it cool in summer and dry in winter.

“One word should be added in regard to soft chalk as a building material. Where it can be obtained in the garden at a few inches depth, and especially where the cottager is his own architect and builder, it can be most heartily recommended, but there are obvious objections to its transportation to districts where it is foreign.

“The village itself is a very homely and irregular one without a single dwelling of any pretence. The country lying adjacent to Salisbury Plain consists of broken, sparsely peopled downland, and very ornate or finished cottages would be out of keeping, but they would not look so well copied in a very rich, heavily timbered country.”

#### RATS AND CHALK

*Note.*—Conglomerate chalk is, like cob, vulnerable to the attacks of a really determined rat.

The outer defences provided by the exterior rendering can be backed up by the mixing in of broken glass or sharp flints with the substance of the wall, where such attacks are likely,



MARSH COURT, HAMPSHIRE.  
A fine example of hewn-chalk building, by Sir Edwin Lutyens.

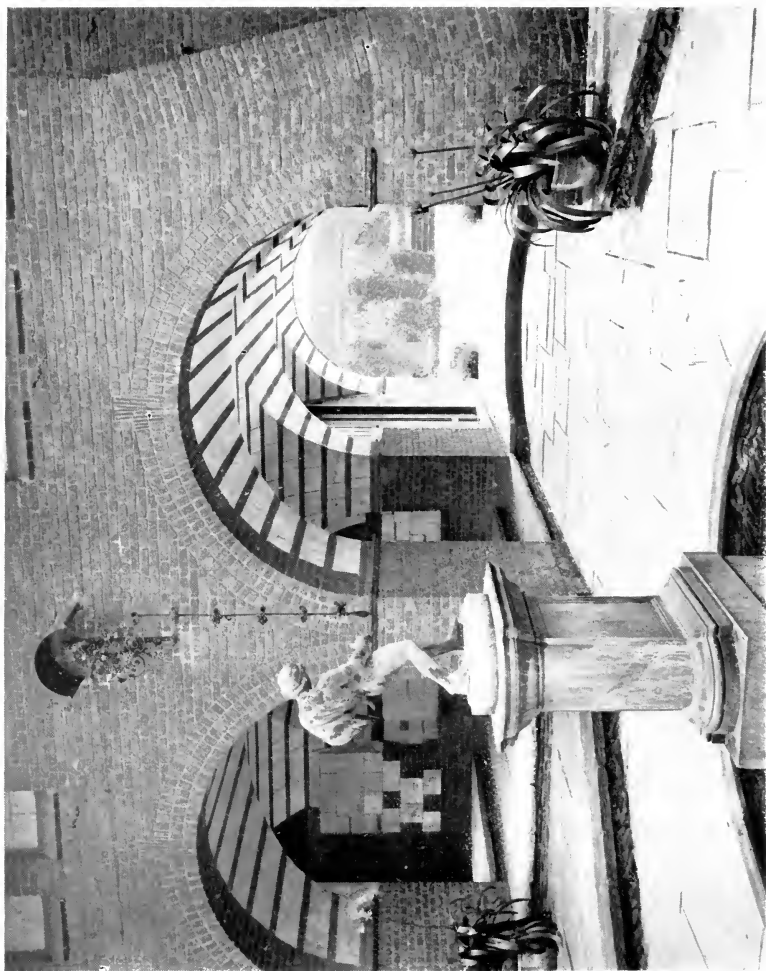

BRICK-AND-CHALK VAULTING AT THE DEANERY GARDEN, SONNING



## BLOCK CHALK

“Chalk” is a term somewhat loosely used to denote the soft white limestone—the “*Creta Scriptoria*”—that is cousin to Marl on one side and to Ragstone on the other.

In its purest form chalk consists of over 95 per cent. of carbonate of lime in the form of fine granular particles held together by a calcareous cement, its organic origin being clearly traced in the remains of the minute sea creatures with which it abounds.

Hewn blocks of chalk have been used for walling and vaulting from immemorial times, and, where not exposed to direct erosion by the weather, remain to this day as clean-cut as when they were first quarried and a very great deal harder.

The filling in of the great vaults at Salisbury Cathedral and in the Bishop’s Palace are of chalk, whilst innumerable lesser buildings of more or less antiquity still remain to us as monuments to the excellence and durability of this stone.

Chalk, too, was often used in combination with flint or brick to build the engaging chequer-work walls that embellish so many downland villages.

At Medmenham there are cottages both old and new of hewn rock chalk, and both the Berks and Bucks banks of the Thames have many buildings to show of this beautiful material.

Amongst present-day architects Sir Edwin Lutyens was the first to give hewn chalk an opportunity of showing its quality in serious architecture, Marsh Court in Hampshire being an instance of more than local celebrity.

In the great walls at the Bishop of Winchester’s palace, Farnham Castle in Surrey, the old builders appear to have used bricks, lime-stone and chalk proper, according as the several materials were delivered, quite indifferently, and with results altogether delightful.

Not all chalk is suitable for building ; that near the surface being often far gone in decay and much too friable for such a purpose.

Even when apparently sound blocks have been gotten they are not infrequently found to be crossed in all directions by planes of weakness along which they are apt to fall to pieces in the handling.

From this cause the " waste " is sometimes considerable.

The well-known building " stones " from the quarries of Beer, Sutton, and Tottenhoe in Devonshire are really chalk, but in a form not readily distinguishable from ordinary free-stone.

The longer that chalk blocks are kept to dry before building-in the better, and the sun and wind of at least a year should be allowed free play upon them to dry out their natural sap and render them " frost-proof."

During the drying-out process the chalk should, if possible, be protected from the rain.

For years after being built into the walls of a house, chalk will continue to dry and harden.

But it is essentially a somewhat porous material, and will quickly revenge itself on those neglecting its just demands for a sound roof and a proper damp-course.

In exposed situations new chalk walling is liable to allow the penetration of moisture under the pressure of the wind unless a cavity is provided or unless the surface is treated with a silicate or other " vitrifying " fluid.

Chalk, however, has one shining virtue in common with its great antithesis—it improves mightily with keeping.

Chalk walls sometimes have youthful vices in the way of porosity that entirely disappear with advancing years through the closing up of the surface pores, which eventually makes a cavity and inner lining superfluous,

IV

*UNBURNED CLAY AND EARTH BRICKS*



## IV

### UNBURNED CLAY AND EARTH BRICKS

#### SUN-DRIED BRICKS

THE use of sun-dried bricks in this country, is, for no very apparent reason, almost entirely restricted to East Anglia. There it has been used for generations with entirely satisfactory results.

Mr. Skipper of Norwich writes of the material as follows :

“ Who, travelling from Norfolk to London, whether by the Ipswich or Cambridge line, has not noticed the numerous colour-washed or black (tarred) cottage, farmhouse and agricultural buildings scattered practically all along the countryside? Some of these are of studwork and plaster, some of wattle and daub, but many are built of clay made up into lumps, sun-dried, and built into the walls with a soft clay-mixture as mortar. No lime *need* be used, though sometimes it is mixed with the clay mortar. The preparation, digging, exposure and mixing with short straw are similar to the Devonshire ‘Cob’ work, but in these parts the worked clay is thrown into moulds, and lumps are formed of, say, 18 in. by 12 in. by 6 in., or 18 in. by 9 in. by 6 in. for large sizes, and for inside walling or backing to brick-faced walls, 18 in. by 6 in. by 6 in. The walls, naturally, are rough in texture and the joints are generally stopped up and besmeared with a thin coating or almost a wash of clay. This coating sometimes has lime mixed with it, but it is not necessary. This is all that is needed to complete the walling, and there is a building—a malting,

that any one can see at Tivetshall Station on the Ipswich line, about 200 ft. long, 45 ft. or 50 ft. wide and three floors high, built of lumps 18 in. by 12 in. by 6 in.—that has stood the weather and weight of its roof for forty years built in this way; 12 in. is the thickness of its walls. A further stage in finish is to give the walls two or three coats of coal tar, but it is not essential, though desirable where stock are kept, as cattle are rather fond of licking the clay, and they do not use their horns much when walls are tarred. The highest finish in this work is to cast sand on the last coating of tar before it is quite dry, and then to colour or whitewash on this. This accounts for the variety of colourings seen in these buildings, some even of a kind of pink or red; while some yellow or buff, beside the white and the black or tarred buildings, and all huddled together or standing apart, whether covered with thatch or red pan or flat tiles, look remarkably in harmony with their surroundings. These lump walls are, of course, built on a base of brickwork, about 18 in. or 2 ft. high, to keep them free from damp. This kind of walling can be built for *at least* 15 per cent. or 20 per cent. cheaper than ordinary 9 in. brickwork. Thin as these walls are compared with those of 'Cob' houses, they are noted for being warm in winter and cool in summer. When suitable clay is procurable a local builder almost invariably uses clay lumps when building a house for himself, though to gratify a whim perhaps, he will case the outside walls—especially the front next the street or road—with brickwork. But clay lumps he carefully reserves for inside walls and weight-carrying linings to the outside walls, bonding the two together very much in the same way as two  $4\frac{1}{2}$  in. 'cavity walls' are bonded. I am not suggesting that this walling is as interesting artistically as 'Cob,' but I do suggest it is a practical, sensible and *dry* walling, and if properly done it will 'last for ever,' as a local builder repeatedly said to me when speaking of it. One can easily see why



ONCE CORN HALL, NOW COUNCIL SCHOOL.

Built about a hundred years ago. Still in sound condition and quite dry.



A ROW OF CLAY-LUMP COTTAGES.

The front has been plastered and panelled out. In the upper part of the stable building, seen in the foreground, the clay-lumps are shown exposed.

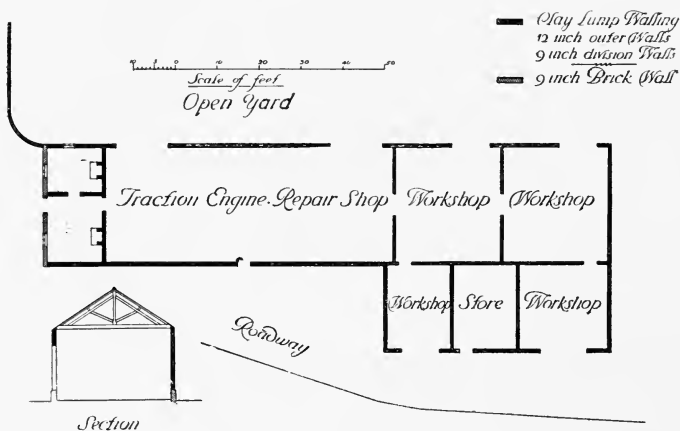

#### ENGINEERING WORKSHOPS.

Built twenty years ago. The walls are thoroughly sound, despite constant vibration, and are perfectly dry, except the brick face, which was added for effect.



the cost is light—the sun and the winds do the drying in the spring months, and no coals are required, and also the clay is often found on the building site, hence no cartage. Actual building work naturally goes quickly, as the lumps are large. There is another important point to notice. One may see a building complete with its roof on and occupied by its tenant while still awaiting an outside casing of brickwork to be built round it, either with a view to greater protection or for the mere vanity of the owner, for while thus left unprotected the lump walls take no harm from even winter exposure. Now to be quite practical in these extremely practical days, I venture to suggest that the use of clay lumps at least for inside walls and linings of outside walls would be an immense boon to the numerous cottage-building schemes now being projected. We must not forget that comparatively few bricks will be available this year, while the cottages are wanted at once. Can these few bricks be better used than by forming foundations and chimneys for the clay-lump walls of these cottages? I think not. The cottages could, of course, be occupied in the late summer or autumn of this year, and next year when bricks will be more plentiful perhaps the brick casings could be added, if brickwork *must* complete them. I make this strictly utilitarian suggestion solely to meet a very urgent and deep national need. Personally, I prefer the sight of a cottage built and finished in the old-established method of the locality. Unskilled labour only is required, working under intelligent supervision, hence immediate employment for a great number of men would be provided.”

The use of sun-dried bricks for the interior partitions of cob and pisé cottages is worth consideration, as the nature of these materials demands a thickness of wall which is too wasteful of space to be acceptable in mere partitioning.

Of the strength of clay-lump walls, there is no question. It was recently necessary to cut a new doorway in the old clay-lump wall of a large traction-engine garage, and the blocks removed were thrown into a heap upon the ground.

The clay happened to be needed for other purposes, for which it had first to be broken up.

Ordinary hammers proved entirely ineffective, and it was not until heavy sledges were used that the lumps could be smashed.

The tractor-house in question is a large building some 25 ft. by 100 ft., carrying a heavy roof and constantly subjected to vibration by the coming and going of the tractors.

The walls are only 12 in. thick, without piers or reinforcements of any kind, and yet the whole building, which is 26 ft. high at the gables, is as perfect to-day as when first erected some twenty years ago.

In the same town as this tractor-house, East Harling in Norfolk, is a council school built of clay lump (converted from the old Corn Hall), apparently not a pin the worse for a century of hard wear.

Near by there are a number of private houses built of the same material, some of them reputed to be upwards of 200 years old and certain of them having considerable architectural merit.

*(Extract from "The Farmers' Handbook," issued by the Department of Agriculture, New South Wales, 1911)*

"ADOBE," OR SUN-DRIED BRICKS

"As their name implies, these buildings are constructed of sun-dried, but unburnt bricks. For buildings of this character, material like clay, which is unsuitable for pisé-work, can be used. The bricks are made in a wooden mould, and are 16 in. long, 8 in. wide, and 6 in. thick. A man can mould about 100 per day. They are laid in a

similar manner to other bricks, the mortar used being wet loam, or even the material of which the bricks are made. The cost of making and laying is estimated at about 15s. per 100. Buildings constructed of these bricks are substantial and cool, and very similar in character to pisé buildings.

“A school-house built of these bricks eighteen years ago by Mr. Nixon, of Reefton, is still in an excellent state of preservation ; in fact, little, if any, the worse for wear, despite the fact that walls are unprotected by verandahs or overhanging eaves. During its existence it has had, first one coat of oil-paint, and later a coat of coloured limewash.”

“Clay lump,” then, is one of the many good old building methods that needs no proving, but only revival and perhaps improvement.



## APPENDIX

### I

#### WHITEWASH

Whitewashing has been frequently referred to in the foregoing pages as the most suitable treatment for the exterior of chalk and earth buildings.

There is, however, a certain prejudice against lime-whiting amongst both owners and occupiers, owing to the frequent renewal that its adoption usually implies.

With a view to removing this drawback from a treatment otherwise so effective, the following recipes are suggested as improvements on the usual practice.

Ordinary whitewash is made by slacking about 10 lbs. of quicklime with two gallons of water.

The following recipes are taken from "*White Paints and Painting*" (Scott), and are reliable :

(1) "*Factory*" Whitewash (*interiors*), for Walls, Ceilings, Posts, etc. :

(a) 62 lbs. (1 bushel) quicklime, slake with 15 gallons water.

Keep barrel covered till steam ceases to arise. Stir occasionally to prevent scorching.

(b) 2½ lbs. rye-flour, beat up in ½ gallon of cold water, then add 2 gallons boiling water.

(c) 2½ lbs. of common rock-salt, dissolve in 2½ gallons of hot water.

Mix (b) and (c), then pour into (a), and stir until all is well mixed. This is the whitewash used in the large implement factories, and recommended by the insurance companies. The above formula gives a product of perfect brush consistency.

(2) "*Weatherproof*" Whitewash (exteriors), for Buildings, Fences, etc. :

(a) 62 lbs. (1 bushel) quicklime, slake with 12 gallons of hot water.

(b) 2 lbs. common table salt, 1 lb. sulphate of zinc, dissolved in a gallon of boiling water.

(c) 2 gallons skimmed milk.

Pour (b) into (a), then add the milk (c), and mix thoroughly.

(3) "*Light House*" Whitewash :

(a) 62 lbs. (1 bushel) quicklime, slake with 12 gallons of hot water.

(b) 12 gallons rock-salt, dissolve in 6 gallons of boiling water.

(c) 6 lbs. of Portland cement.

Pour (b) into (a), and then add (c).

*Note.*—Alum added to a lime whitewash prevents it rubbing off. An ounce to the gallon is sufficient.

Flour paste answers the same purpose, but needs zinc sulphate as a preservative.

The following are from "*1,000 More Paint Questions Answered*" :

(4) *Durable Whitewash for Outside Use.*—A whitewash that will not rub off or wash off in rainy weather can be made by mixing one half-pint of flour to a batter with cold water, then stirring into this boiling water until it becomes a thick paste.

While still hot it is poured into a pailful of ready-made lime whitewash and well stirred in.

(5) Another simple method is to add to 2 gallons of ready-made lime whitewash one half-pint each of molasses and table salt. Must be stirred frequently while being used.

*Whitewash for Exterior Surfaces.*—A formula for a durable whitewash for out-buildings of rough lumber. The following is reprinted from "*Popular Mechanics*" :

(6) Place 1 bushel good fresh lime in a barrel with 20 lbs. beef tallow ; slake with hot water and cover with sackcloth to keep in steam. When the lime is slaked, the tallow will have disappeared, having formed a chemical compound with the lime. Dry colours may be added to produce any tint desired.

It is better to add colour before slaking the lime, but if this is not feasible mix the colour with alcohol and add it to the strained whitewash. Thin to easy flowing consistency with clear water.

*Cold Water Paint that will stand the Weather.*—A formula for making a white outside coating that will resist the action of the weather and remain hard even under the influence of moisture and rain. Experiments with different brands of cold water paints have proved failures.

A really effective cold water paint, in order to resist the elements and remain white, should contain a white pigment of good body and some oil in addition to the water, and with this purpose in view the following is suggested:

(7) To make 100 lbs. of such paint, mix 10 lbs. white, pure in oil, with 10 lbs. bolted whiting, 8 lbs. raw linseed oil, 6 lbs. soft soap (made with potash), and 26 lbs. soft water.

One quart of pale copal varnish will improve the preparation. The formula given is of the right consistency to apply on dressed lumber with the brush. For application on rough lumber or with the spraying machine it requires more thinning with water and varnish.

The following is taken from Pearce's "*Painting and Decorating*":

(8) A London recipe for distemper has the following proportions: 4 "balls" whiting, 2 lbs. Young's patent size, and sufficient water to cover the whiting.

(9) A Scotch distemper is described as: 12 lbs. whiting, size as given previously, 2 ozs. alum, 2 ozs. soft soap. It is very fast, for passages, schools, etc. Tinting colours for limewash should be restricted to ochres, umbers, lime blue, lime greens, charcoal or lamp black, and earthy reds (as Venetian).

(10) External limewash for farm buildings, etc., may be made as follows: Lime,  $\frac{1}{2}$  bushel, slaked with 1 gallon of milk and remainder of water, 1 lb. salt and  $\frac{1}{2}$  lb. sulphate of zinc to make it withstand the weather.

Experiments with and practical tests of these and other kinds of whitewash are being carried out, and the author hopes that he may find opportunity at some later date of announcing the results obtained.

## II

## THE IMPORTANCE OF USING LOCAL MATERIALS

(Extract from "Country Life," November 9th, 1918)

300,000 COTTAGES WOULD ENTAIL THE TRANSPORT OF  
60,000,000 TONS OF MATERIAL

In carrying out any considerable scheme of house building two difficulties will have to be met. The first arises from the scarcity of building material; the other from the cost and difficulty of transport. These, to some extent, can be obviated by the use of local material, which is to be commended on other grounds as well. Local material fits into the character of the neighbourhood in which it is found and maintains its traditions.

Very few people realise the bulk of materials, and in order to help them the following statement has been prepared to show the materials needed for each cottage and the total for 300,000 cottages :

Materials.	Per One Cottage.			Weight. Per 300,000. (Tons.)
	Tons.	Cwts.	Qrs.	
Ballast, sand, gravel . . . . .	78	17	0	23,655,000
Lime . . . . .	5	18	0	1,770,000
Cement . . . . .	12	8	0	3,720,000
Bricks . . . . .	85	0	0	25,500,000
Slates for D.P.C. . . . .	0	10	2	157,500
Chimney-pots . . . . .	0	0	3	11,250
Tiles . . . . .	7	2	2	2,137,500
Carcassing timber . . . . .	7	0	0	2,100,000
Complete joinery timber . . . . .	1	12	0	480,000
Cast-iron rain-water goods and sundries . . . . .	0	9	0	135,000
Stoves, copper, ash-bin, etc. . . . .	0	5	2	82,500
Nails, screws, etc. . . . .	0	1	2	22,500
Hair for plaster . . . . .	0	1	0	15,000
Lead flashings, etc. . . . .	0	2	1	33,750
Sink, waste pipes, draining boards, etc. . . . .	0	2	1	33,750
Sanitary goods . . . . .	0	1	0	15,000
Whitening, distemper and paint . . . . .	0	3	1	48,750
<b>Total . . . . .</b>	<b>199</b>	<b>14</b>	<b>2</b>	<b>59,917,500</b>

It will be seen that to carry out the scheme for 300,000 cottages a total of close on 60,000,000 tons of material will have to be shifted. In addition to that, it must be remembered that the



cost of material is very small in comparison with that of building. This will be apparent from an analysis of the items employed for actual cost and the percentage which that cost bears to the total cost.

Cottages erected 1912 (semi-detached): total interior area of cottage, 772 ft. super. (parlour, kitchen, scullery and three bedrooms, coal and W.C.):

No.	Item.	Per House.	
		Actual Cost.	Per cent. of Total Cost.
1.	Sundries . . . . .	8	2.66
2.	Foundations . . . . .	16	5.28
3.	External and party walls (a) . . . . .	77	25.41
	Windows and doors (b) . . . . .	23	7.59
4.	Internal partitions . . . . .	36	11.88
5.	Ground floor . . . . .	18	5.94
6.	Upper floor . . . . .	22	7.26
7.	Roof and rain-water goods . . . . .	34	1.22
8.	Chimney and fireplaces . . . . .	30	9.90
9.	Sanitary fittings, water supply and drainage . . . . .	19	6.27
10.	Staircases . . . . .	11	3.63
11.	Fittings . . . . .	6	1.98
	<b>Total . . . . .</b>	<b>£300</b>	

These facts help to clarify the problem. The weight of the building materials required for an ordinary cottage with living-room, parlour, scullery, three bedrooms, etc., the house containing cubic contents of about 11,500 ft., would come approximately to 200 tons per cottage; and even assuming that there is only an average transport of fifty miles, this would give 10,000 ton-miles per rural cottage, which is taking it at a very low average. In each cottage the weight of the brickwork represents about 42 per cent. of the total weight. It is, therefore, apparent that every effort should be made to lessen the transit of materials required for the external walling. If, on the other hand, local materials are employed, this carriage would be saved and a great economy effected. Even if this utilitarian consideration were not so important as it is, the desirability of making all possible use of local materials is very great from other points of view. It would stimulate local interest in building and, in addition to retaining the traditions

of the district, give greater hope of retaining and maintaining the proper architectural aspect of our villages.

It is scarcely necessary to summarise the advantages that may fairly be expected to flow from this endeavour to make a real start at finding a solution for the housing difficulty. First and foremost must be placed the saving in transport. A casual reader may easily imagine that the difficulties of carriage will vanish with the end of the war, but that is not so in reality. Any one who has travelled in France must have noticed engines bearing such names as Liverpool Street, King's Cross, Euston, Birmingham, and so on. The meaning of that is that a great deal of our rolling stock was sent over to France, and at the best will not be available here for a long time to come. Even the ordinary work of upkeep and repair has necessarily been neglected owing to the scarcity of men and other causes incidental to war-time. Transport difficulties are bound to last for a very considerable period after the peace settlement, and it would not be at all advisable to delay the construction of houses so long. The returned soldiers will make us vividly conscious of the shortage. Nothing could be imagined more likely to make them look for chances of going abroad than to learn that there is not sufficient housing accommodation for them in the village in which they lived before the war, and to which they hoped to return on its conclusion.

### III

#### EXTRACT FROM A LETTER TO THE EDITOR OF *COUNTRY LIFE*, JULY 27TH, 1918

“ Shortly before the war I had occasion to demolish some very old cottages at Clovelly for the reconstruction of the New Inn. I was so much struck with the stability of these (although by no means first-class samples of cob work) that I collected some facts and notes on the subject from different parts of the county of Devon. Where bye-laws have been adopted, cob is no longer being used. It is difficult, therefore, to give an accurate comparison of costs, but after careful investigation I did arrive at the following results for North Devon and Scotland. The prices were in 1913, and in both cases for a five-roomed cottage

(assuming four to be built at the same time, including internal water supply, but omitting any special work necessary to procure supply, and omitting fencing).

	Cost per foot cube cob at 2 ft. 6 in. thick.	Cost per foot cube 11 in. hollow brick.
North Devon . . . . .	6½d.	5½d.
Scotland . . . . .	6d.	6d.

These prices assumed suitable material on or near site, and allowed something for the difficulty of getting at least one experienced cob-worker to instruct the unskilled men. Since 1913 the cost of brick has risen so much that cob would now be much cheaper, probably as much as 1d. or 1¼d. foot cube in both cases, and this is likely to be the case for many years. Suitable material exists in many parts of the country. If reed straw cannot be had, other reinforcements can be used. I have seen various materials in use, of which heather was perhaps the best and most easily procured. I can endorse from experience the comfort of these old buildings, and the affection of Devon people for them. The thick walls give all that a house should—protection from heat in summer and cold in winter. For the contrast, visit the new Garden City at Rosyth. Many of the houses are attractive, but their thin brick walls, tile and slate hanging are not suitable to the north and east coasts. Ask the opinion of the occupants of these new houses. Many of them are Devon born and bred, and imported from the dockyards of the three towns. They nearly all complain of the cold, and their views form an interesting comment on modern construction."



*INDEX*



## INDEX

### INTRODUCTION :

- Chalk walls, 18
- Cheap materials, the search for, 13
- Pisé de craie, 16, 17, 93
- Pisé, experiments with, 15; in moulds, 19, 20; in South Africa, 22, 23
- Pliny on Pisé de terre, 25
- Rammed chalk, 16, 17, 93

### GENERAL SURVEY :

- Building materials, shortage of, 26
- " Ersatz " products introduced during the War, 26
- House famine, the, 27
- Local materials, use of, to avoid transport, 29
- Lutyens, Sir Edwin, and Mr. Alban Scott, cottage by, 30
- Rural housing, suitability of cob and pisé for, 28

### I—COB :

- Allen, Mr. C. B., his reference to Devon cob, quoted, 47
- Baring-Gould, Rev. S., on cob, quoted, 47
- Beauty of cob, 35
- Bernard, Mr. Charles, his account of Sir Walter Raleigh's cob house, 45, 46
- Book of the West, The*, by Rev. S. Baring-Gould, reference to cob in, quoted, 47
- Building, 37, 38, 39
- Carpentry and joinery, 41, 42
- Chimneys, 44
- Cob tradition, 52
- Composition, 36
- Cost, 35, 50

### COB—continued :

- Cottage-Building*, reference to cob in, quoted, 47
- Country Life*, letter to, relating to cob work, quoted, 118, 119
- Design, 44, 45
- Devon cob, 47
- Drying, 39
- Elizabethan cob houses still existing, 34
- Former conditions returned, 52
- Foundations and base, 40; result of bad, 34
- Fruit walls, of cob, 47, 48
- Fulford, Mr., of Great Fulford, on cob, 50-52
- Gimson, Mr., his description of building cob, quoted, 35
- Hayes Barton, Sir Walter Raleigh's house at, 45, 46
- Hipped roofs, 41
- Joinery, 41, 42, 43
- Masonry and carpentry, 41, 42
- Method of building, 36-45
- Mixing, 37
- Northcote, Lady Rosalind, her description of Sir Walter Raleigh's house, 46
- Primitive methods, 46
- Protection, 43
- Protective wash, 51
- Raleigh, Sir Walter, his cob house at Hayes Barton, 45, 46
- Rats, 44
- Reed thatch, 46
- Rendering, 51
- Roofing, 51
- Shuttering, 51
- Strength, 44
- Thickness of walls, 40
- Traditional building material in Devon and Wessex, 33
- Training of ex-soldiers, 52

## II—PISÉ :

- Bolts, 86
- Bonders, 69
- Building procedure, 71, 72, 74, 75
- Capabilities, 57, 58
- Corners, 68
- Cyclopædia, or Universal Dictionary of Arts, Sciences, and Literature*, on pisé, quoted, 59-71
- Damp-course, 86
- Definition of Pisé de terre, 57, 59
- Durability, 82
- Earthwork, A Manual on*, quoted, 73-76
- Empandeni, pisé work executed at, 78, 79, 80
- Excavation, 86
- Etah Jail, pisé work executed at, 76, 77, 78
- Fillet, 87
- Floating, 86
- Foundations, 74
- Frames, 87
- France, introduction of pisé into, 57
- Gorffon, Monsieur, reference to his treatise on pisé, 57
- History, 57
- Indian and Colonial practice, 73-88
- Introduced into France by the Romans, 57
- Journal de Physique*, by the Abbé Rozier, quoted, 58
- Lintels, 87
- Locale, 58
- Method of building, 58-62
- Method of working, 60, 61, 62
- New South Wales, pisé work in, 81-88
- Origin, 58
- Picture-rail, 87
- Plant required, 85, 89, 90
- Plastering, 75
- Pliny, references to his account of pisé, 25, 57
- Plugs, 86, 87
- Protection, 75
- Rain, 67
- Rammer, the, 59, 60
- Ramming, 62, 76
- Rate of work, 63
- Rendering, 70
- Rods *versus* bars, 75, 76

## PISÉ—continued :

- Rozier, the Abbé, his *Journal de Physique*, quoted, 58
- Shuttering, 59, 88, 89
- Shutter ties, 73
- Skirting, 87
- Soil blending, 64; preparation of, 66, 67; suitable, 63, 74, 86; tests, 63; to ascertain quality of, 65
- Speed of building, 70
- Stability, 82
- Strength, 69
- Studding, 87, 88
- Theory and science of pisé, the, 62-73
- Ventilators, 86
- Virtues of pisé, 72
- Wire netting, use of, 87, 88

## III—CHALK :

- Block chalk, 103, 104
- Chalk compost, historical, 93; composition and uses, 94, 95
- Chalk conglomerate, 100
- Chimneys, 96
- External rendering, 96
- Frost, 95
- Garden walls, 97
- House walls, 98
- Old and modern examples, 98-101
- Rats and chalk, 102
- Rendering, 96
- Repairs, 96
- Roof, 97
- Strength, 96
- Timber, 95
- Winterslow cottages, the, 101, 102

## IV—UNBURNED CLAY AND EARTH BRICKS :

- "Adobe," use of, in New South Wales, 110, 111
- Age of clay-lump buildings, 110
- East Anglia, use of sun-dried bricks in, 107
- Method of making, 107
- New South Wales, use of sun-dried bricks in, 110, 111
- Skipper, Mr., on sun-dried bricks, quoted, 107-109
- Strength of clay-lump walls, 110



## UNBURNED CLAY AND EARTH

BRICKS—*continued* :Thickness of clay-lump walls,  
108, 110

## APPENDIX :

Cold-water paint, recipe for, 115

Cost, an analysis of building,  
117APPENDIX—*continued* :*Country Life*, letter to, relating to  
cob work, quoted, 118, 119

Distempers, recipes for, 115

Local materials, importance of  
using, 116, 117Weight of building materials,  
table of, 116

Whitewash, recipes for, 113, 114

PRINTED BY  
HAZELL, WATSON AND VINEY, LD.  
LONDON AND AYLESBURY,

# Recent Additions to the "COUNTRY LIFE LIBRARY."

---

## The "Country Life" Book of Cottages.

By LAWRENCE WEAVER. Nearly 300 pages and over 300 illustrations. **9/6** net ; by post, **10/-**.

## Small Country Houses : Their Repair and Enlargement.

By LAWRENCE WEAVER. Forty examples chosen from five centuries. 300 illustrations. Large quarto, **18/9** net ; by post, **19/6**.

"Anyone who wishes to adapt an old house for modern use will find much to learn from Mr. Weaver's pages."—*Scotsman*.

## Small Country Houses of To-day.

(*Second Series*.) By LAWRENCE WEAVER. Over 300 illustrations and plans. Large quarto, **25/-** net ; by post, **26/-**.

## The First and Chief Groundes of Architecture.

By JOHN SHUTE, 1563, with a historical and critical introduction by LAWRENCE WEAVER. Facsimile edition of the first book on architecture published in England. Folio, half-bound in sheepskin, **18/9** net ; by post, **19/6**.

## Houses and Gardens by E. L. Lutyens.

Described and criticised by LAWRENCE WEAVER. 400 folio pages, and 600 magnificent illustrations. 2nd Edition, quarter buckram, **31/3** net ; half morocco, **43/9** net ; postage **10d.** extra.

"It is only when we see such a publication as this, that we realise what quality characterises some of the building of to-day. Abundantly and splendidly illustrated, this book shows the work of a great master."—*Manchester Guardian*.

## Grinling Gibbons and the Woodwork of His Age (1648-1720).

By H. AVRAY TIPPING, M.A., F.S.A. Large folio, quarter buckram, **31/3** net ; half morocco, **43/9** net ; postage **10d.** extra. Nearly 250 illustrations.

"The book is rich in lessons for architects and amateurs of fine woodwork."—*The Scotsman*.

## English Homes.

Edited by H. AVRAY TIPPING, M.A., F.S.A. The internal character, furniture and decorations, of some of the most notable Houses of England. Vols. I. and III., containing 500 matchless illustrations, large folio, handsomely bound, each **52/6** net.

"A veritable revelation of the wealth of internal adornments, architectural and other, contained in the great country mansions of England. To turn over the pages is to obtain keen pleasure, as well as enlightenment, concerning a treasury of domestic art and archæology, which to a large extent is kept closed from the common eye."—*Scotsman*.

## Gardens Old and New.

Edited by H. AVRAY TIPPING, M.A., F.S.A. Vols. I. and III., beautifully illustrated, each **52/6** net. These volumes illustrate the relationship between house and garden in a way never before attempted.

"The principle conveyed in the letterpress is that held by all great gardeners and architects—that house and garden are, or should be, intimately associated, and that the character of the possessors should be reflected in both. The accounts of lovely garden after lovely garden are most agreeable reading."—*Daily Chronicle*.

## Twenty-Five Great Houses of France.

By SIR THEODORE ANDREA COOK, M.A., F.S.A., with an Introductory Chapter, outlining the Development of French Domestic Architecture, by W. H. WARD, M.A., F.S.A., F.R.I.B.A., and illustrations by FREDERICK H. EVANS. Large folio, containing over 400 superb illustrations, plans and diagrams. Half-bound in buckram, **52/6** net; in half morocco, **60/6** net; postage **1/-** extra.

"The Publishers of COUNTRY LIFE have touched few subjects that they have not adorned, but here they have surpassed themselves. It is seldom that we have seen so rich and communicative photographs of great architecture."—*Daily News*.

"A book which will prove a source of endless delight to lovers of architecture."—*Glasgow Herald*.

## Garden Ornament.

By GERTRUDE JEKYLL, with over 500 wonderful illustrations. Large folio, gilt edges, **63/-** net; postage **1/-** extra.

"Miss Jekyll's collection in this noble folio is a storehouse of examples, styles and method in the decoration of gardens, a compendium of the history and taste in English Horticulture and a revelation of the treasures of beauty which our country holds."—*Times*.

## Windsor Castle.

An Architectural History. Collected and written by command of Their Majesties QUEEN VICTORIA, KING EDWARD VII. and King GEORGE V. By SIR WILLIAM H. ST. JOHN HOPE, Litt.D., D.C.L. Imperial quarto, in Two Volumes, and a Portfolio. Bound in half sheepskin, **£7 17s. 6d.** net; whole sheepskin, **£10 10s.** net; full morocco, **£13 2s. 6d.** Carriage extra.

---

Illustrated prospectuses of these invaluable books and a complete catalogue will be sent post free on application to the Manager, COUNTRY LIFE, LTD., 20, Tavistock Street, Covent Garden, W.C.2.



UNIVERSITY OF CALIFORNIA LIBRARY  
BERKELEY

Return to desk from which borrowed.  
This book is DUE on the last date stamped below.

<p>31 Oct '49 HJ</p> <p>21 Nov '49 MB</p> <p>12 Oct '54 BH</p> <p>NOV 12 1954 <i>ds</i></p> <p><i>R. Lowe</i></p> <p>DEC 12 1954</p> <p><i>de</i></p> <p>DEC 12 1954 LU</p> <p>14 Nov '55 VT</p> <p>REC'D LD</p> <p>NOV 11 1959</p>	<p>REC'D LD</p> <p>JUN 10 '65</p> <p>JUN 10 '65 - 9 PM N</p> <p>DEAD</p> <p>APR 1 1982</p> <p>RET'D MAR 19 1982</p> <p>APR 25 1988</p> <p>MAY 23 1988</p>	<p>RECEIVED</p> <p>MAY 10 '88</p> <p>AUTO DISC. MAY 16 '88</p>
---	---	--

U.C. BERKELEY LIBRARIES



C005560367

M117375

7/4/21

WS

THE UNIVERSITY OF CALIFORNIA LIBRARY

