

SF

467

R49R

1902

---

---

ROBINSON METHOD



BREEDING SQUABS

RICE

---

---

From the Personal  
Reference Library of  
PAUL IVES



ALBERT R. MANN  
LIBRARY

NEW YORK STATE COLLEGES  
OF  
AGRICULTURE AND HOME ECONOMICS

AT  
CORNELL UNIVERSITY



THE GIFT OF  
PAUL POMEROY IVES 2D  
IN MEMORY OF  
PAUL POMEROY IVES



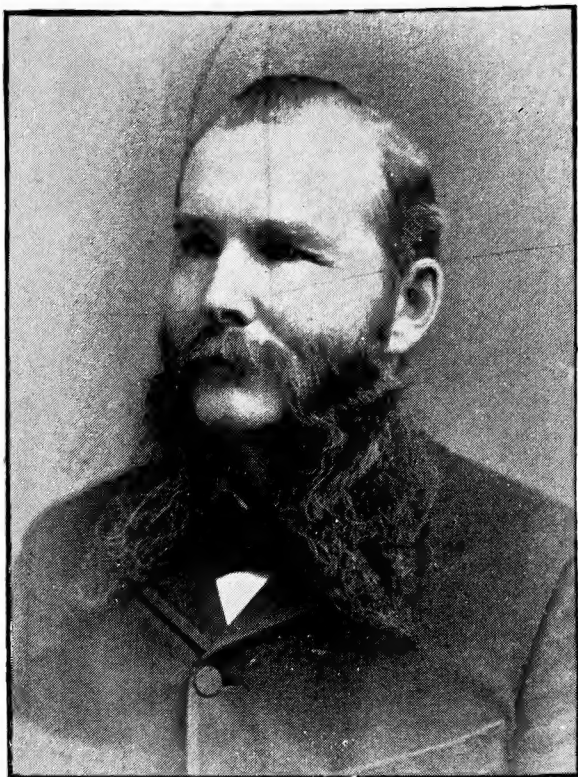

**J. G. ROBINSON, M. D.**

THE  
ROBINSON METHOD  
— OF —  
BREEDING SQUABS

*A FULL ACCOUNT OF THE NEW METHODS AND SECRETS OF THE MOST  
SUCCESSFUL HANDLER OF PIGEONS IN AMERICA.*



*DIRECTIONS FOR HOUSING, NESTING, MATING, FEEDING, KILLING.  
COOLING, MARKETING, SHIPPING, BUYING, ETC.*

*BY ELMER RICE.*

*ILLUSTRATED WITH PLATES FROM NEW PHOTOGRAPHS SPECIALLY  
TAKEN FOR THIS WORK.*

*SECOND EDITION, REVISED.  
WITH SUPPLEMENT.*

BOSTON, MASS.:  
PLYMOUTH ROCK SQUAB CO.  
1902.

*FW*

SF  
467  
R49R  
1902

E 6619

---

*COPYRIGHT, 1901, BY ELMER RICE.*

*COPYRIGHT, 1902, BY ELMER RICE.*

**ALL RIGHTS RESERVED.**

---

## PREFACE.

This Manual is written to give in brief and plain terms the rules by which Dr. J. G. Robinson, of Pembroke, Mass., has won his famous success in breeding squabs for market. I think everyone interested in profitable breeding stock will appreciate an account of the ways and means by which this gentleman and his wife have made such marked progress in the handling of pigeons. Although somewhat skeptical at first, I was shortly forced to believe that in this isolated hamlet of Plymouth county (where certainly there are no distractions to annoy the patient student), they had quietly worked out problems which had been perplexing squab breeders for years, and were producing with mathematical certainty and regularity a table product so excellent as to make their squabs noted all over Boston where good diners gathered. By talking with the Boston marketmen who handled his product, I had a confirmation of the astonishing profit-showing of his books and I prevailed upon the Doctor to let the public know of this comparatively new industry, and its wonderful possibilities when intelligently pursued, and he has co-operated with me in this publication of the facts. To make the work careful and thorough, I investi-

gated his plant for four months, in my leisure time, watching every detail, taking notes, and going over in conversation with the Doctor and his wife the experiments which had led up to his deductions and settled plans. I made a rough draft from my data, cut out superfluous words and boiled everything down, and the following pages are the result. I take no credit for ideas of my own, but merely have made observations of another's work, checked them for accuracy, and written down the result. My intention has been to make a simple guide which faithfully followed by even a child with some gumption will result in a duplication of Dr. Robinson's success anywhere. He has revised the proofs and aided in the preparation of the illustrations. We hope this little handbook will stimulate those into whose hands it goes to make a profitable living for themselves and aid in the development of this remarkable home industry. We welcome new facts and new experiences from any source and will take pleasure in incorporating them in future issues of this Manual.

ELMER RICE.

Boston, December, 1901.



## CONTENTS.

	PAGE.
NO DRUDGERY.....	9
SQUAB HOUSE AND FITTINGS.....	13
FLYING-PEN AND FITTINGS.....	23
HOW TO REMODEL A POULTRY HOUSE....	31
HOW TO USE A GARRET OR BARN LOFT.....	32
HOW TO FEED.....	33
BREEDING HABITS.....	40
HOW TO MATE.....	44
FEW AILMENTS.....	49
HOW TO KILL AND COOL THE SQUABS.....	51
HOW TO SHIP.....	54
BOOKKEEPING.....	61
TRAINED FLYERS.....	62
CHEAP BREEDERS ARE EXPENSIVE.....	66

## ILLUSTRATIONS.

TITLE.	PAGE.
PORTRAIT OF DR. ROBINSON.....	FRONTISPIECE.
HOW PIGEONS MULTIPLY.....	12
SQUAB HOUSE AND FLYING-PEN.....	14
PLANS OF ROBINSON UNIT.....	16
SQUAB HOUSE AND FLYING-PEN IN A BACKYARD.....	18
INTERIOR OF SQUAB HOUSE.....	20
NEST-BOXES WITH NAPPIES.....	22
BACK VIEW OF NEST-BOXES.....	24
FLYING-PEN VIEWED FROM THE SOUTH SIDE.....	26
THE PATH-PAN.....	27
FILLING THE SELF-FEEDER WITH GRAIN.....	28
OLD POULTRY HOUSE FIXED FOR PIGEONS.....	30
HOW TO KEEP PIGEONS IN A GARRET.....	32
ANOTHER VIEW OF THE SELF-FEEDER.....	34
A PRETTY SQUAB BREEDING STRUCTURE.....	36
INSIDE OF SQUAB HOUSE.....	38
PIGEONS IN THE SUN.....	40
A PAIR OF EGGS.....	42
SQUABS JUST HATCHED.....	42
SQUABS ONE WEEK OLD.....	42
SQUABS TWO WEEKS OLD.....	42
SQUABS THREE WEEKS OLD.....	43
SQUABS FOUR WEEKS OLD.....	43
PIGEONS ON THE ROOF OF SQUAB HOUSE.....	46
HOW TO HANDLE A PIGEON.....	48
HOW NOT TO KILL A SQUAB.....	52
THREE DRESSED SQUABS ON A PLATTER.....	53
HOW TO COOL THE KILLED SQUABS.....	56
HAVING HIS PICTURE TAKEN.....	60
VIEW OF RANCH AND FLYING-PENS.....	64

## NO DRUDGERY.

In raising live stock of any kind, arrange matters so the animals will look after themselves as much as possible. We all know that automatic machinery has cheapened many articles formerly dear, and the perfect breeding outfit is automatic, needing only a supply of feed and water. Aim to cut down the factor of personal drudgery, so as to leave your time clear, to observe and plan, and execute intelligently. Beginners who load themselves down with a daily round of exacting duties soon lose heart, their patience gives out and they become disgusted. We have known breeders of rabbits to fail simply because they raised them in hutches. Each hutch had a door and two dishes, one for feed, the other for water. Every day, the door of the hutch had to be opened, the hutch cleaned, the dishes refilled (and often cleaned), and the door closed. It took 15 or 20 motions to do this for each hutch. Multiply this by 20 to 30 (the number of the hutches), and the burden grew unbearable. It was not surprising that in three or four months the breeder's patience was worn out. The factor of personal drudgery had become greater than the rabbits. The thoughtful breeder would have turned his rabbits into two or three enclosures on the

ground and let them shift for themselves. Then one set of motions in feeding would have answered for all, and there would have been no dirt to clean up. Infinite patience as well as skill is required to make a success of animals given individual attention. The aim of every breeder should be to make one minute of his time serve the greatest possible number of animals. When you think and reason for yourself, you understand how much more practical it is to give sixty animals one minute of your time than one animal one minute. Time is money and if you are too particular, and too fussy, and thoughtless about these details, it is a clear case of the chances being sixty to one against you.

At the start, the problem of breeding squabs for market is in your favor, because one hundred pairs of breeding pigeons may be handled as easily and as rapidly as one pair. Try to keep this numerical advantage in your favor all the time. Discard every plan that cuts down the efficiency of your own labor, and adopt every device that will give you control in the same time over a greater number of pigeons.

It takes brains and skilled labor to run a poultry plant successfully. Every poultryman knows that he cannot entrust the regulation of temperatures of incubators and brooders to an ignorant hired man, but even a boy or girl, or under-the-average farm hand, knows enough to fill up the bathtubs and feeding-troughs for squab-breeders, leaving the time of the owner free for correspondence and the more skillful work of killing and shipping the squabs.

We found no written or printed advice about squab-breed-

ing that was of real use. On the contrary, it was a hindrance. The booklets, for instance, gave a warning against rats and dampness, but no clear, practical remedy. They advised a form of nest-box which experience proved impractical on account of the time necessary to keep it clean. They advised a nest which turned out to be wrong. They recommended feeding at stated intervals, which resulted in squabs squeaking continually for nourishment. They said nothing about cooling the killed squabs. Unless the cooling is done properly, the squabs cannot be marketed. And so in almost every particular the advice proved to be either misleading, or deficient. It was discouraging, but an incentive to thought and experiment. Unless the beginner with squabs wishes to pass through the evolution of devices and methods which we passed through, he will avoid every suggestion which has not been demonstrated to be practical.

The primary object is to breed squabs for market as cheaply, as easily and as fast as possible, without the expenditure of a dollar for fanciful or impractical appurtenances. The amount of one's capital will settle the question of the number of pairs with which to start, whether ten, fifty, one hundred or five hundred pairs. When you have fixed upon the amount of money you wish to expend for breeders, lay out your plans for the plant.

The pigeons need shelter for themselves and their young—for this purpose a weatherproof wooden structure is demanded. This shelter, which we will call the squab house, needs to be supplemented by a flying-pen in which the birds

Beginning with 12 pairs of Hovers, at the end of the

1st Month you will have 24 squabs

2d " " " " 48 "

3d " " " " 72 "

4th " " " " 96 "

5th " " " " 120 "

(Now the 1st Month squabs are old enough to lay)

6th " " " " 120 + 24 + 24 = 168 squabs  
\* O.B. 1st Mo.

7th " 168 + 24 + 24 + 24 = 240 "  
O.B. 1st Mo 2d Mo

8th " 240 + 24 + 24 + 24 = 336 "  
O.B. 1st Mo 2d Mo 3d Mo

9th " 336 + 24 + 24 + 24 + 24 + 24 = 456 "  
O.B. 1st Mo 2d Mo 3d Mo 4th Mo

10th " 456 + 24 + 24 + 24 + 24 + 24 = 600 "  
O.B. 1st Mo 2d Mo 3d Mo 4th Mo 5th Mo

11th " 600 + 24 + 24 + 24 + 24 + 24 + 24 = 768 "  
O.B. 1st Mo 2d Mo 3d Mo 4th Mo 5th Mo 6th Mo

12th " 768 + 24 + 24 + 24 + 24 + 24 + 24 + 24 = 960 "  
O.B. 1st Mo 2d Mo 3d Mo 4th Mo 5th Mo 6th Mo 7th Mo

\* O.B. - Old birds.

960 squabs - 480 pairs

480 pairs at \$1.50 to \$3 alive  
per pair = \$1080

(Or if sold to market men at  
50¢ a pair killed)

480 pairs at 50¢ = \$240

Subtract cost of feed and cost of  
the original 12 pairs, for profits

#### HOW PIGEONS MULTIPLY.

If one's means are limited, it is not necessary to buy a large flock. You may start with a dozen pairs, and by rearing your squabs to maturity, at the end of a year you will have a large number of pairs. The sale of a comparatively few squabs during the year will pay for the feed for all and make the flock self-supporting.

will get the air and exercise which their nature demands.

## SQUAB HOUSE AND FITTINGS.

The essential points in the construction of the squab house are these, that it should face the south, or east, or whence the least wind and most sun comes, that it be raised off the ground by short posts or stone pillars so rats cannot breed under it, that it have a double floor to keep out dampness, and that it be provided with windows for ventilation. Its shape may be varied to suit the fancy of the owner, but the simplest will be found to be the best. The simple pattern may be extended at any time, growing as the business grows.

First, then, if you are starting to make a new building, select a location on fairly high, dry ground. It is not necessary to go to the side or top of a hill, in fact there would be too much wind in such a location. Pick out a place that is not a meadow but whose soil is loose, giving indication of good drainage. Set the foundation posts so that if you are called upon to extend the building at any time, it will run east and west on fairly level land for a distance of two hundred feet or more.

Use cedar or locust for the posts, or you may build up stone at the four corners. Elevate the foundation timbers from one to two feet above the ground. Shingle all around the building, also the roof, but do not shingle the end which faces the direction in which you later may extend the squab house. Then you will not have to rip off the shingles when

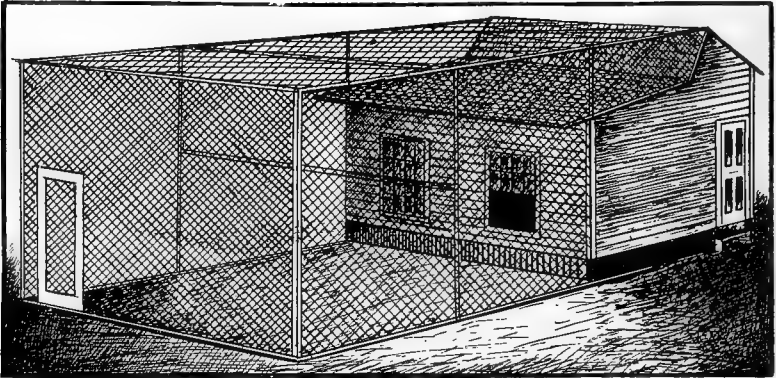

**SQUAB HOUSE AND FLYING-PEN.**

Perspective view of the Robinson Unit, with passageway, and wind-break formation of roof. Notice the pole for pigeons' roost in the center of the flying-pen.



you come to make the extension. The floor should be of two thicknesses of boards, with tarred paper between, to keep out dampness.

One window in the north side is enough. There should be two in the south side. Through these two the birds fly from house to pen. They may slide up or down, or be hung on hinges, the idea being to provide means for closing them winter nights after the pigeons have taken refuge from the pen in the house. The arrangement easiest operated is to set them in grooves, and attach a rope for closing them from the back of the house.

Sunlight is as good for pigeons as for all live stock. The windows of the squab house should be large and set as high as possible, especially on the south side, where the sun shines in all day. The glass should be kept clean so that the direct rays will fall in the interior of the squab house, dispelling moisture and aiding the process of disinfection which the oxygen in the air performs continually.

The window or windows in the north side of the squab house should be kept closed most of the year, so as to run no chances on draughts, which are a prolific cause of trouble. In the hot days of summer there is no harm in opening the north windows. The breeder should use common sense in managing the windows so as to keep the air fresh without draughts.

The nest-boxes are built of boxing and set in a vertical row at the back of the house, forming a wall between which and the north side of the house is a three-foot passageway.

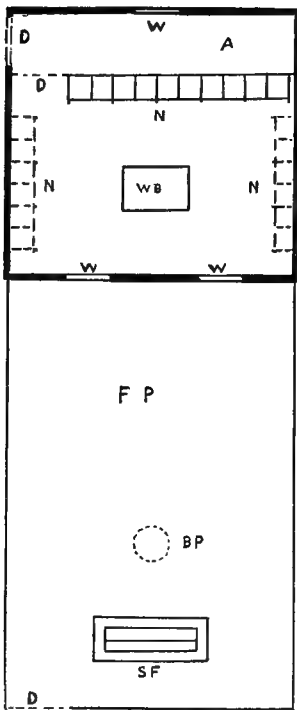

**PLAN OF UNIT.**

A, passageway; WWW, windows; DDD, doors; NNN, nests; WB, wind-break; FP, flying pen; BP, bath-pan; SF, self-feeder; PP, posts. The squab house is 12ft.x18ft.

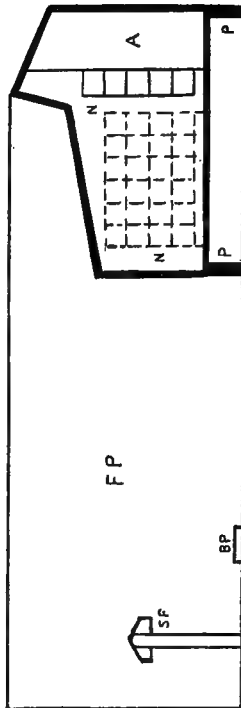

**SIDE VIEW OF ROBINSON SQUAB HOUSE AND PEN.**

Length of house and pen, 32 feet. The nest boxes which are shown by dotted lines may be added as the flock grows. For a flock of 26 pairs, the nest boxes shown by full lines are sufficient.

You can buy this boxing at a saw mill all cut, ten by eleven inches, the dimensions of the nest, and if you get it in this shape you can put the boxes together with as much ease as a child builds a doll's house. You will have no doubts as to the squareness and plumbness of the structure when you have it up. Take long lengths of boxing eleven inches wide for the shelving which should form the top and bottom of the nest-boxes, then set the 10 in. x 11 in. pieces the proper distance apart. The finished nest will be eleven inches from front to back, ten inches from top to bottom, and about ten inches from one partition to the other (or whatever distance the proper distribution of your nests in pairs permits).

We have found five-eighths inch boxing to be the best suited. Build the nest-boxes up from floor to roof perfectly plain, just as the pigeon holes of a desk run. When you have got them up take two-inch strips of the boxing and separate each pair of nests by tacking the stripping onto the edges where they project out into the house. The object of this stripping is to make it harder for a pair of birds in one nest-box to disturb the pair in the adjoining box. Between the nest-boxes of the same pair there should be no stripping.

The backs of the nest-boxes should be on hinges so that from the passageway you may examine every nest. Give each pair of nests a number and it is possible to keep an extremely accurate record of each pair of breeding birds. This record may be kept in a book, numbering the pages to correspond to the number on a pair of nests. A better

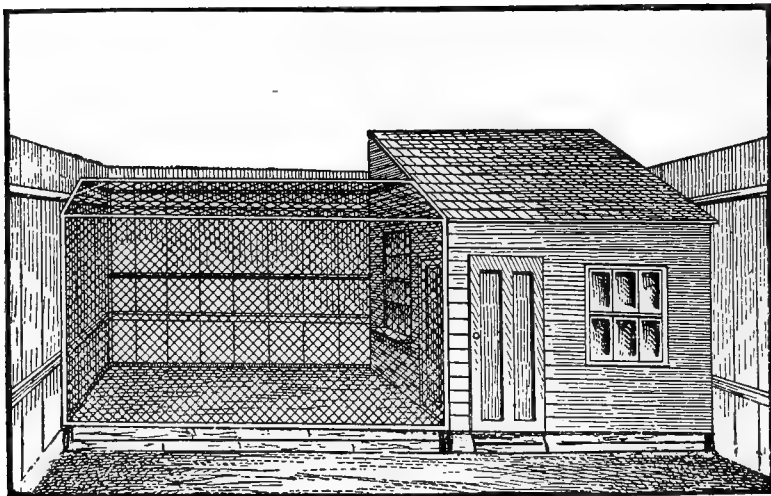

**SQUAB HOUSE AND FLYING-PEN IN A BACK YARD.**

This arrangement is simple and inexpensive. The door does not open to a passageway (as in the Robinson unit), but directly to the interior, which is lined with nests. The flying-pen has a raised board floor to prevent the gathering of pools of rain water.

way is to use a card index, giving one card to each pair of nests. A card three by five inches in size should be used, for the record is liable to extend over a term of years. If a pigeon dies, or a pair is otherwise broken up for any reason, the card may be removed at once. If you are using a book, you will have a lot of abandoned records in a year or two. The card index, weeded out as the birds change, remains alive always, and is a perfect indication of the business you are doing, in every detail of expenditure and profit, as well as condition of birds, and the relation of feed to selling price of squabs may be figured out to a nicety.

Roosts for the breeding pigeons should be tacked to the south and end walls of the squab house. These roosts should be made of inch lumber 5 in. x 6 in. square. Set two pieces v shape and tack the roost (apex up) to the side of the house. One roost for each pair of birds will suffice. When one pigeon is not on the roost the other is on the roof or on the nest. The construction of the roost makes it impossible for one bird to soil another bird on the roost immediately underneath. Do not provide one pole for a roost (as in a poultry house). The roosting habits of pigeons are not like those of hens. You must have separate perches. If you have only one perch, one bully cock pigeon is likely to swagger down the line sweeping off all the others and disputing ownership with them.

There should be a wire door leading from the passageway to the interior of the squab house. You will go in and out of this door to clean the nests, pick up squabs from nests

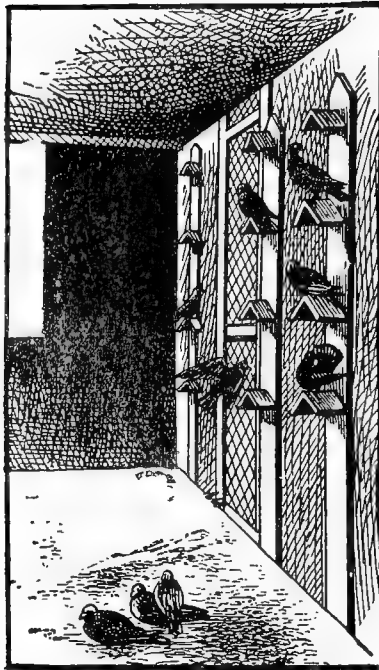

**INTERIOR OF SQUAB HOUSE.**

This illustrates how the perches are made and fastened to the walls. Nail up as many as there is room and whitewash them.

built on the floor, etc.

In the middle of the house, on the floor, place an egg-crate or other light structure, tacking it lightly to the floor. This serves two purposes. On it place hay, grass, straw, etc., to be used by the birds in building their nests. It also serves as a wind-break. It modifies the force of the air blown by the wings of the pigeons as they fly from their nests out through the windows into the pen. Were it not there, the floor would be swept clean by the force of the wind from the wings.

There should be a layer of sawdust one to two inches thick on the floor of the house. This prevents the nappies from being broken if by birds' quarreling they are pushed out of the nests. On a board floor they would break when they drop, but the sawdust lets them down easy. The sawdust also makes an easy resting place for those birds that prefer to build their nests on the floor. There always will be two or three of these pairs of pigeons in every house.

The nest-boxes should be perfectly plain, made of simple boxing in the manner described. Do not build up a piece of boxing at the front part of the nest to prevent the nappy from being pushed out. Early in our experience we built a few nests in this way but soon changed them over to the simpler form, on account of the difficulty of keeping them clean. The droppings bank up at the front of such a nest-box and it is almost impossible to clean them thoroughly.

Two sizes of nappies should be used. The small one is the size known as No. 6, seven inches in diameter across the

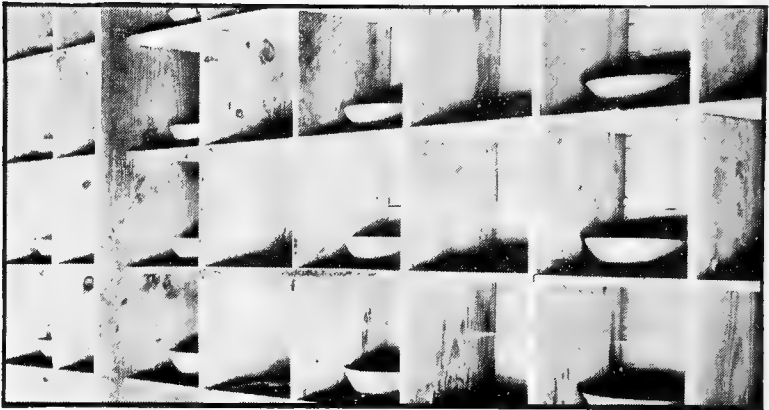

#### **NEST BOXES WITH NAPPIES.**

The nest boxes are built of five eighths pine boxing sawed 10in. x 11in. in size. They are perfectly plain without cleats or projections, so that no dirt will collect. The pigeons build the nests in the nappies, using pieces of hay and grass.



top and two inches deep. The large nappy is known as No. 7, and is nine inches in diameter and two and a half inches deep. The large one is given to the pigeons first to receive the eggs. When the squabs are two weeks old, the large nappy is removed and the nest with its occupants transferred to the small one. The reason for the change is this: The nest which the breeding pigeons build in to receive the eggs should be large so that the cock and hen will have plenty of room to cover the youngsters and protect them from the cold. In winter time especially they are very careful not to leave their tender young uncovered long enough to be chilled. The squabs deposit their dung in a circle inside the nest. At the end of two weeks when you change nappies, you get rid of the dirty nest and at the same time provide a nappy in which there is plenty of room for the squabs, and also you have a self-cleaning nest, for the youngsters deposit their dung over the edge of the nappy into the nest-box, and not into the nappy, as they would do if you allowed the large nappy to remain. In the large nappy, also, some squabs, if left to develop, will become deformed, owing to the fact that their feet will push the nesting material off the slippery bottom, on which their legs will sprawl disjointed.

## **FLYING-PEN AND FITTINGS.**

The flying pen is simply a wire yard. It is as wide as the squab house, and as high, and extends toward the south about twenty feet. Set posts at the southern extremity and stretch the wire to them, sides and top. The top of the



**BACK VIEW OF NEST BOXES.**

The camera was located in the passageway (see plan of Robinson unit.) The hinged back of the pair of nests No. 21 has been let down, to show how the nests and squabs are reached from the passageway. An inquisitive three-week-old squab is seen perched on the edge of the opening.

posts should be on a level with the top of the squab house, so that a neat appearance will result. Wire of two-inch mesh will suffice. The object is to keep strange and smaller birds out as well as keep the pigeons in. There should be a door in the south end of the flying-pen. In some localities, on account of the prevalence of the thieving English sparrow, it will be necessary to use wire of one-inch mesh in order to protect the grain in the self-feeder from spoliation.

In stretching the wire for the flying-pen, you will have to lay several strips of the netting parallel in order to get the full width of the yard. In piecing these widths together, do not tie them with short pieces of wire, but use one long piece of No. 18 or 20 iron wire and weave it in and out of the netting, first in one width, then in the other. In this manner you can unite two widths of netting in one-tenth the time needed to apply short pieces of tie-wire.

The feeding trough should rest on a single post at the back of the flying-pen, but not close up to the wire, so that the birds can perch all around it. A simple form of self-feeder protected at the top from rain, is the best. It is built entirely of pine wood. It is best to invert a tin pan on the top of the post on which the feeder rests so that if mice climb up the post (if rough) they cannot reach the grain in the feeder.

The bath-pan is placed on the ground at the back of the flying-pen. The best pattern is of galvanized iron, twenty inches in diameter and five inches deep. It should be filled with fresh water once or twice a day. The pigeons go to

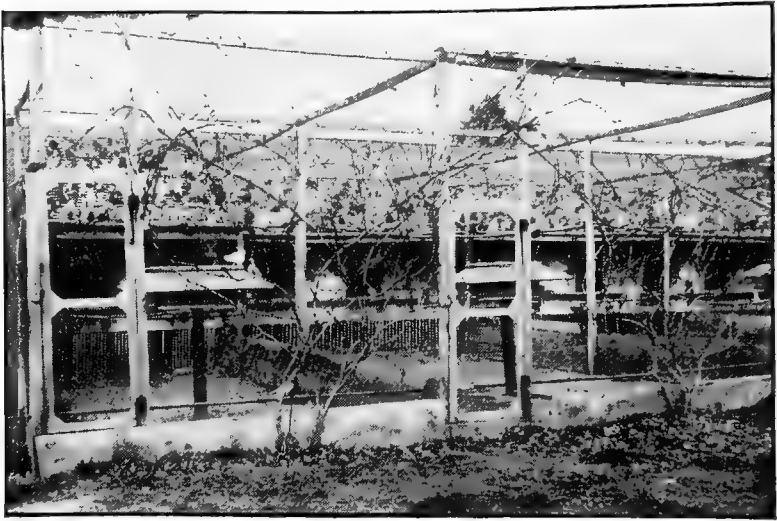

**FLYING-PEN VIEWED FROM THE SOUTH SIDE.**

This photograph of a part of one of our breeding outfits at Pembroke shows the construction of the flying pen, the location of the self-feeder, etc. The pipe supplies water for the bath-pans and saves steps to carry water in pails.

it early every morning and bathe in it, keeping their feathers free from vermin by this habit. They drink from the pan before bathing. When thin ice forms in winter, they break it and splash their wings about as in summer. If you place the bath-pan close to the netting at the back of the flying-pen, you may fill it with water from a pail outside the pen by pouring the water through the netting. After a flock of birds have bathed in the pan, a thick, greasy scum may be observed on the surface of the water.

---

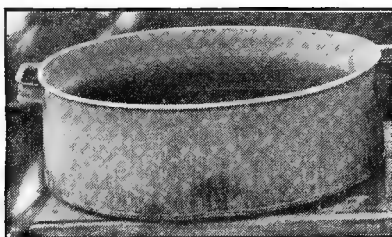

#### **THE BATH-PAN.**

This is made of galvanized iron, is twenty inches in diameter and five inches deep. It should be filled with water once or twice a day. The pigeons drink from it and bathe in it. They are clean and dainty and if necessary they will break the thin ice in the winter in order to get into their daily bath.

---

The space from the rear of the squab house to the ground should be trellised with narrow stripping so that the pigeons cannot fly under the squab house from the pen. Trellis work instead of solid boards is used in order that there may be a free circulation of light and air under the house, thus preventing rats from obtaining a lodging and also making ventilation good.

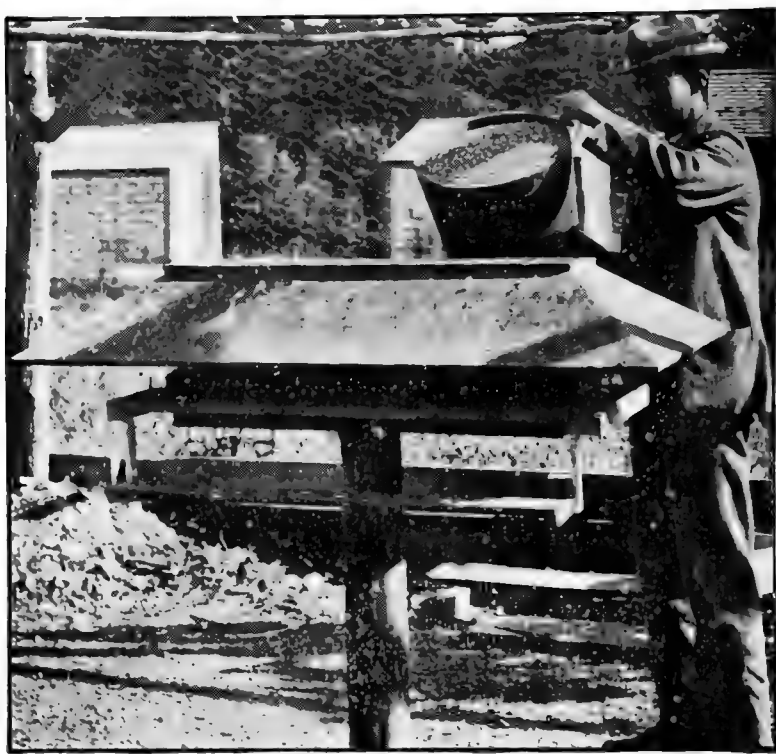

#### **FILL'NG THE SELF-FEEDER WITH GRAIN.**

This shows the construction of the feeder, which is built wholly of pine. As the pigeons eat, the grain drops down on the inside. One filling of the feeder will last two or three days, sometimes a week (depending on the size of the flock.) In a corner of the above picture, on the round of the flying pen, may be seen the straw, grass, etc., used by the pigeons in bulding their nests.

In the squab house, at the bottom of the nest-boxes, reaching from them to the floor, is trellis work through which in winter the birds will stretch their necks to feed from a trough which should be placed at the bottom of the passageway.

In the winter, or in a long stretch of rainy weather, a lamp or small oil-stove may be set in the passageway to help drive off the moisture. The object should not be to raise the temperature of the squab house, but merely to evaporate the moisture in the air. We have hot water pipes running the entire length of the passageways of our squab houses but they are not kept hot enough to heat the air to any extent. We have set faucets at regular intervals and can draw water without going to the front of the house. For the same reason we have set pipes below the frost line in the ground at the end of the flying-pens so that we can get a water supply easily for the bath-pans. We have faucets at the top of the ground, also valves sunk below the surface so that we can shut off the water in winter and prevent freezing in the pipes where they are exposed to the air.

We have experimented with all kinds of nappies and pans in the nest-boxes and believe that most of the success attained is due to the use of the nappies described. Do not use the earthenware nests or wooden boxes which you may find advertised.

## HOW TO REMODEL A POULTRY HOUSE.

Probably most breeders will start in the pigeon industry by remodeling an old poultry house. The foregoing instruc-

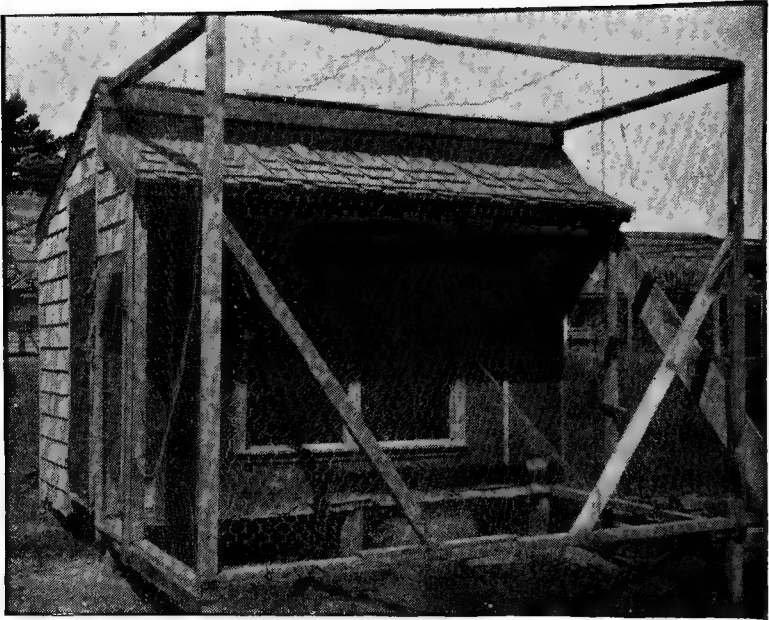

#### **OLD POULTRY HOUSE FIXED FOR PIGEONS.**

This is the place where we housed our first squab-breeders. It was a cheap and ungainly affair, but it answered for a while. Any old poultry house may be remodeled for pigeons at a trifling expense.



tions have given the particulars of as substantial and convenient a plant as it is necessary to build. An old poultry house may be remodeled in a day with little expense save the labor involved and the remodeled building will answer the purpose well.

First elevate the poultry house. Set it on four or more posts a foot or a foot and a half from the ground so as to get a protection from rats and dampness. Arrange the flying-pen on the south side as previously described. A passageway for the quick manipulation of the nest-boxes is not needed. Simply build the boxing in the form of nests against the north and end walls of the building and you have a practical arrangement. Set the roosts and wind-break as described and arrange the windows so that they may be closed at night in the winter.

To remove the squabs and clean the nests, in such a house, you enter the door of the house and approach the nests from the front. It is not so convenient as the passageway method because you will drive some of the birds out of the house, but the interruption is not serious and when you have left the house they will fly back to their nests.

## **HOW TO USE A GARRET OR BARN LOFT.**

We have known city people without a square foot of ground to make a success in squab raising by housing the pigeons in a garret. In such cases the flying-pen is built out from the window or skylight as shown in the illustration, so as to give the birds an opportunity to get light and air.

The garret is lined with the nests. The danger to watch out for in such a location is mice. Tin or fine mesh wire should be used plentifully in the corners and on the floors of the garret, or rats will get in and kill the squabs. With careful tinning, trouble will be avoided.

It is also possible to utilize the upper part of a barn. The

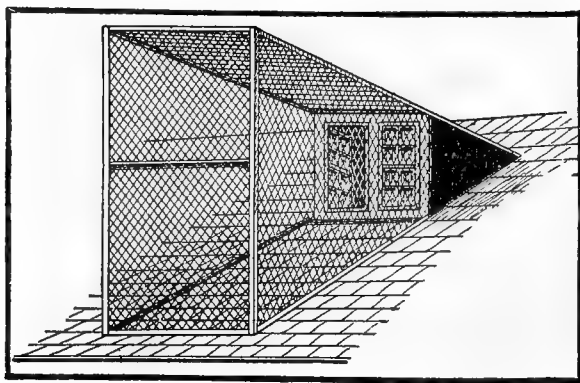

#### HOW TO KEEP PIGEONS IN A GARRET.

Build a flying pen out from the windows (or skylight) and line the garret with nests. City people who may have no land can breed squabs successfully and with little effort, in this way. It is not necessary to heat the garret—the pigeons thrive no matter how cold is the weather. A barn which has a loft may be arranged in practically the same manner.

flying-pen should project out from the roof just as in the case of the garret already described. The loft may be reached either by stairs or a ladder. It should be completely boarded in and the floor protected all around by fine mesh wire, or tin, so that rats cannot get at the interior.

Many beginners wish to raise squabs until they get a flock

which will make removal to a farm profitable. They can work intelligently and securely (if they are cramped for room), with either the back-yard, the garret or the barn arrangement, give the business a thorough test and then move to a farm if their ambition leads them to make the profit which thousands of pairs of breeders earn.

## HOW TO FEED.

The feed consists of red wheat, cracked corn, kaffir corn, Canada peas, hempseed, oyster shells and salt, all cheap and easily obtained. No other food is given. No sloppy food is given and there is no mechanical preparation of the food. The diet does not vary from one end of the year to the other, with this exception, that in winter you allow two parts of corn to one of wheat—in summer one part of corn to two of wheat. A summary of the food follows:

1. Red Wheat. This may be procured anywhere at a cost of from \$1.30 to \$1.50 per 100 pounds. (Do not feed white wheat, it will cause diarrhoea.)

2. Cracked Corn. This costs from 95 cents to \$1.10 per 100 pounds. (Do not feed the whole corn. It is hard to digest and is especially unsuited to young stock, making hard labor for their crops.)

3. Kaffir Corn, or Egyptian Wheat. This is procurable anywhere. It is grown principally in the South and West, the largest supply coming from Kansas. It costs from \$1.15 to \$1.50 for 100 pounds. It will grow in localities where there is little or no rain. Pigeons come to the hand fast for

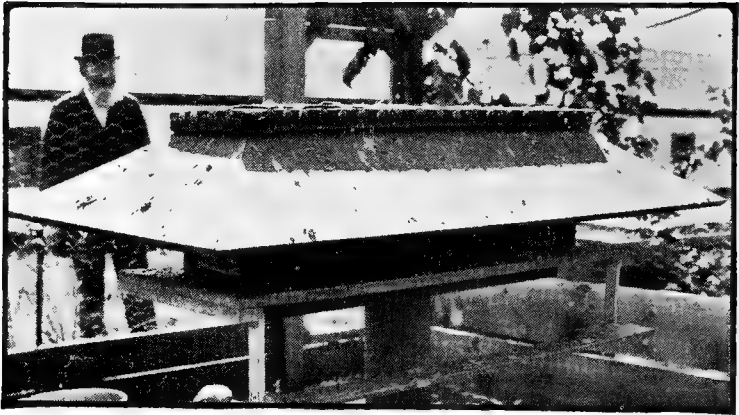

**ANOTHER VIEW OF THE SELF-FEEDER.**

The top (which is on hinges) should be covered with tarred paper so that the grain will keep dry in storm weather.

it, thus demonstrating that it is a well-liked food. This corn makes white flour and is an ideal food for pigeons. The color of the food supply affects to a degree the color of the squab meat, and as white squab meat commands the highest price, plenty of kaffir corn should be fed.

4 and 5. Canada Peas and Hempseed. These are fed, not regularly, on account of their expense, but as dainties, in periods of moulting, extra strain, etc. Canada peas cost about \$1.25 a bushel (about sixty pounds); hempseed costs from \$3.50 to \$4 per 100 pounds.

6. Oyster Shells. These cost from 45 to 65 cents per 100 pounds, ground. They should be kept before the pigeons all the time in a special trough.

7. Salt. Coarse ground salt should be purchased and kept before the pigeons all the time in a special trough. They will eat it as they feel the need of it. On the south end of some of our squab houses, on the pen side, we have pieces of rock salt hung up, enclosed in wire netting. The birds peck at these pieces occasionally. They are not necessary, however, provided coarse salt is kept before them.

8. Grit. The yard of the flying-pen should be gravelled, not grassed. We buy the same kind of grit as is used for poultry, only slightly finer.

9. Nesting Material. On the wind-break in the centre of the squab house, also in a corner of the yard, keep a small pile of hay, straw and green field grass for the use of the pigeons in building their nests. They will fly to the pile and take what they need. We have seen tobacco stems recom-

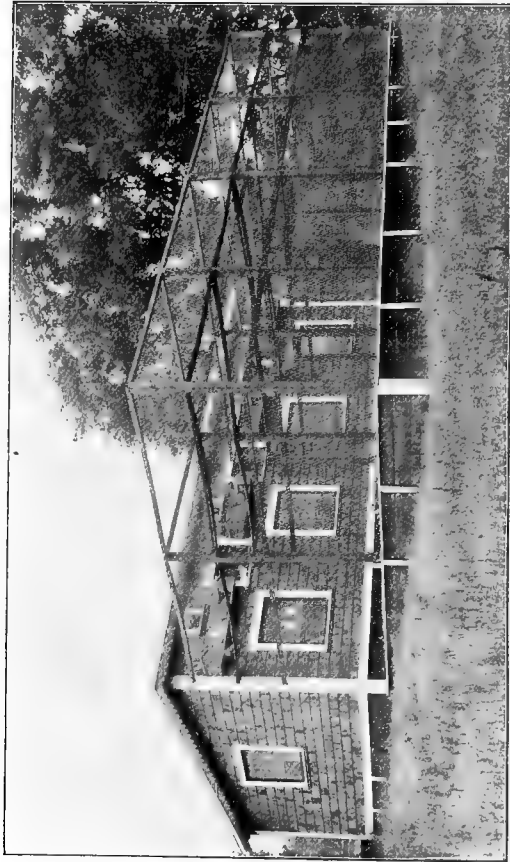

### **A PRETTY SQUAB-BREEDING STRUCTURE.**

The buildings may be made a distinct ornament to a country place. This squab house and flying pens were built by Mr. Edward S. Payson on his Lexington (Mass.) estate. The shingles are stained and the trimmings are white, the whole making a neat appearance. The flying-pens have a board floor.

mended for this purpose, as a preventive of lice, but we have found them too coarse for nesting material and now never use them. There will be no trouble from lice if ordinary cleanliness is observed.

Hempseed and peas are useful dainties in getting acquainted with your birds. They will flock to your hand and eat them greedily.

Our practice is to go light on the corn, in feeding. Corn is carbonaceous and fat-producing and the pigeons become weakened under such a diet. It heats the blood and lays the system open to an attack of canker.

The self-feeder and the feeding-troughs in the squab house should be kept supplied with a mixture of the grains before noted. We have seen recommendations to feed the birds once or twice a day only what they would clean up at one feeding but have found such advice to be wholly wrong when breeding on a large scale. When the food supply is of the "clean-up" kind, and consequently not generous, the young squabs will be heard squeaking loudly for food. Where a continuous supply is at hand, one seldom hears the hungry cry of a squab, and all grow quickly and strongly to market size. It is poor economy to furnish a meagre and uncertain supply of food. Do not fear that the pigeons will waste the grain provided by a bountiful self-feeding trough. They will eat what they need for themselves and the squabs and never will gorge nor lose their trim, racy shape. We have discovered no diseases caused by overfeeding.

Salt fish and preparations of mortar and grit are imprac-

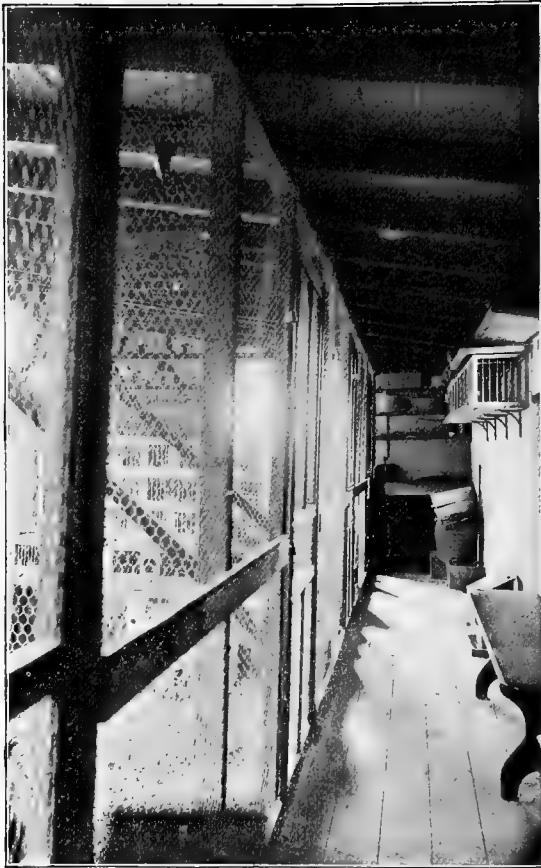

**INSIDE OF SQUAB HOUSE.**  
(See Page 36 for Outside View.)



tical and not at all necessary in the diet of pigeons.

The proper mixture, as we have noted before, is two parts of corn to one of wheat, in winter, and two parts of wheat to one of corn in summer. Fill the self-feeder and the eating-trough in the squab house with the mixture. The other food materials, the dainties, should be fed by hand, throwing handfuls on the floor of the squab house or flying-pen whenever you think the pigeons need stimulating. Vary the diet. Alternate with the dainties. If you feed a plain mixture too long, the pigeons will eat with poor appetites and the size of the squabs will deteriorate. Force your feed and you will force the size of the squabs. The principle is the same in feeding all live stock. Force coal under a boiler and you will force the steam pressure. Increase the fuel in the crops of the pigeons and you will increase the size of the squabs.

The bath-pan should be filled twice a day if the breeder is solicitous as to the cleanliness of his birds. All the birds bathe, but some not every day. They never take cold in this way. The cause of a cold is always a damp, draughty house. Their feet are not sensitive and in winter they have no hesitation in breaking thin ice and stepping into the pan. They drink from the bath-pan, not continually inserting the bill and raising the head, but obtaining their fill usually at one insertion of the bill. They do not rustle in the dirt and cleanse themselves in this way, as a hen does.

In cold weather, fill the pigeons' bath and drinking dishes with warm water. They appreciate it, as do all live stock.

## BREEDING HABITS.

The hen pigeon builds the nest, which is not an elaborate affair, simply a good-sized handful of nesting material laid straight in the nappy. They do not build a circular nest in the careful manner of some birds. If they wish to hatch on the floor of the squab house, their nest is there usually of a rudimentary pattern.

When the nest is built, the cock begins to “drive” the hen around the house and pen. In a flock of pigeons on the roof

---



**PIGEONS IN THE SUN.**

This roof has no wind-break, but it is of the ordinary construction, which is cheaper than the wind-break style. Although the pairs are mixed together, each pair of mates remains constant for years, one male attending the same female all the time.

---

of the squab house, you always will see one or two cocks “driving” their mates, pecking at them and nagging them with the purpose of forcing them onto the nest to lay the eggs. The cock seems to take more interest in the coming family than the hen.

The hen lays one egg in the nest, then skips a day and

lays the second egg on the third day. Seventeen days after being laid the eggs hatch. The egg first laid hatches a day before the second, sometimes, but usually the parents do not sit close on first egg, but stand over it, and do not incubate it. Sometimes one squab may get more than its share of food, and the younger one will weaken and die. This seldom happens but if you see one squab considerably larger than the other, the thing to do is to exchange with a squab from another nest that is nearer the size of the remaining squab. The old birds will not notice the change but will continue feeding the foster squab.

From the day of its hatching to market time the squab is fed by its parents. The first food is a liquid secreted in the crop of both cock and hen, and called pigeons' milk. The parent pigeons open their bills and the squabs thrust their bills within to get sustenance. This supply of pigeons' milk lasts from five to six days. It gradually grows thicker and in a week is found to be mixed with corn and wheat in small particles. When about ten days old, the squabs are eating the hard grain from the crops of the mature cock and hen, which fill up at the trough, then take a drink of water and fly to the nest to minister to the little ones. You see how important it is to have food available at all times.

In 14, 15 or 16 days after the first pair of squabs have been hatched, the cock begins "driving" the hen again. This shows the necessity of a second nest for the pair. In this second nest the hen lays two more eggs, and the care of the first pair of squabs, now between two and three weeks old,



**PAIR OF EGGS.**



**JUST HATCHED.**

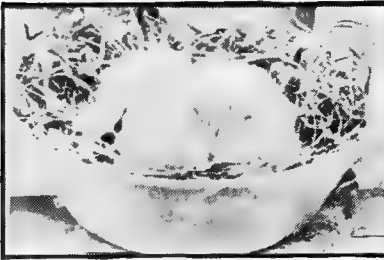

**ONE WEEK OLD.**

So rapidly do squabs grow that you will quickly notice their increase in size from day to day.



**TWO WEEKS OLD.**

devolves upon the cock. When this pair is four weeks old, it is taken out of the nest and killed and both the mature birds are concerned then only with the new hatch. This sequence of eggs and hatches goes on all the time.

If there are not two nests, the two new eggs will be laid in the nest where are the growing squabs and the parents in their eagerness to sit on the new eggs will push the squabs



**THREE WEEKS OLD.**

In this picture the squabs are seen in the smaller nappy, to which they were transferred when two weeks old and which remains their home until they are killed for market.



**FOUR WEEKS OLD.**

out of the nest and they will die for lack of sustenance.

The hen lays the eggs about four o'clock in the afternoon. The cock and hen take turns at covering the eggs, the hen sitting during the night until about ten o'clock in the morning, when the cock relieves her, remaining on until the latter part of the afternoon.

When the nappies are changed at the end of two weeks, the nest-box should be scraped clean with a trowel. When the squabs are taken out for market at the end of four weeks, the nappy should be washed and scalded and the nest-box whitewashed. If the nappies are changed and the whitewash used regularly, no trouble from parasites will result. In the summer it is well to add a little carbolic acid to the white-wash as an extra precaution.

## HOW TO MATE.

One way of mating pigeons is to turn males and females in equal number into the same pen. They will seek their own mates and settle down to steady reproduction. Another method is to place the male and female which you wish to pair in a mating coop or hutch. In the course of a few days they will mate and then you may turn them loose in the big pen with the others. The latter method is necessary when improving your flock by the addition of new blood, or when keeping a positive record of the ancestry of each pair. By studying your matings, you may improve the efficiency of your flock. If you are raising squabs for breeders, you should use the mating coop constantly so as not to inbreed, which the young pigeons might do if left to chance.

In case a pigeon loses its mate by death or accident, the sex of the dead one must be ascertained and a live pigeon of the same sex introduced to the pen to mate with the odd one. Or the live one should be removed from the pen and placed in the mating coop with a pigeon of the opposite sex.

The mating coop should have a partition of lattice work or wire. Place the cock in one side, the hen in the other, and leave them thus for two or three days to flirt and tease each other, then remove the central lattice work or wire and they usually will mate. If they show no disposition to mate but on the contrary fight, replace the partition and try them for two or three days longer. If they refuse to mate after two or three thorough trials, do not experiment any more with them, but select other mates. Be sure your birds are mated before putting them together in the squab house, otherwise a stray cock will visit the nests in search of a mate, breaking up hatchings and causing fights.

The determination of the sex of pigeons is difficult. The bones at the vent of a female are wider apart than of a male. If you hold the beak of a pigeon in one hand and the feet in the other, stretching them out, the male bird usually will hug his tail close to its body—the female will throw her tail. The best way to determine the sex is to watch the birds. The male is more lively than the female, and does more cooing, and in flirting with her usually turns around several times, while the female seldom turns more than half way around. The male may be seen pecking at the female and driving her to nest. When one pigeon is seen chasing another inside and outside the squab house, the driven one is the female and the driver her mate.

The Runt pigeons are the largest and have the biggest squabs, but they are poor breeders, and it takes the squabs from one to two weeks longer to reach market size. The

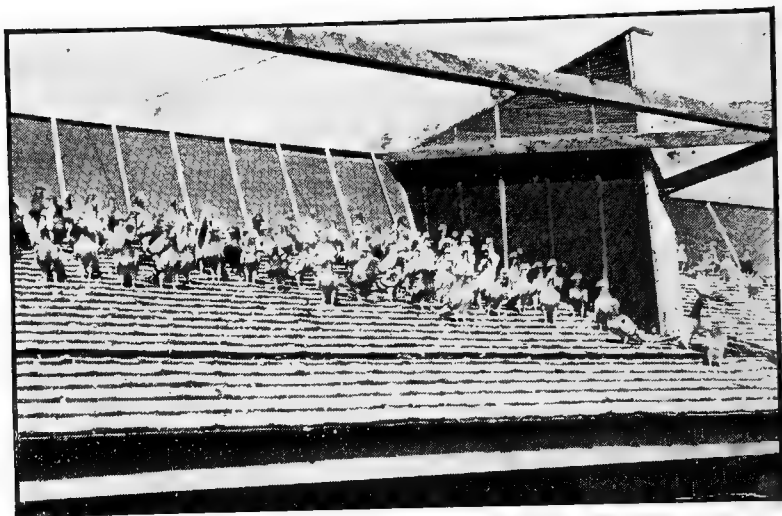

**PIGEONS ON THE ROOF OF THE SQUAB HOUSE.**

Protected from northerly wind and storms by the jog in the roof, they walk about here for hours, their mates being on the nests inside. At night all go inside the squab house. Winter or summer, some of the pigeons always may be seen on the roof.



straight Homer is the best for the practical squab raiser. Runts are expensive, costing from \$6 to \$10 a pair, because they are hard to raise. Some squab breeders have a few pairs of Runts in order to cross occasionally with Homers, but we do not advise it. You will obtain better results by judiciously out-breeding from selected Homers, forcing along the path of advancement the strains that are producing the most and the biggest squabs.

Neither the squab-breeder nor the flying-Homer breeder is much concerned about the color of feathers. There are blue checkers, red checkers, black checkers, silver, blue, brown, red, in fact about all the colors of the rainbow. Color has no relation to the ability of a pair to breed a large pair of squabs. We wish specially to emphasize the fact that the color of the feathers has no influence on the color of the skin of the squab. A white-feathered bird does not mean a whiter-skinned squab. The feed affects the color of the meat a little. A corn-fed pigeon will be yellower than one fed on a mixture. Squabs with dark skins (almost black in some cases) are the product of blood matings. The trouble with a dark-colored squab is in the blood and the only remedy is to get rid of them either by killing the parents or by re-mating. Usually the trouble comes from one parent bird, which you can find by turning up the feathers and examining the skin. Having found the bird which is at fault, kill it. This point has come up continually in our correspondence. The erroneous belief that white-feathered birds produce the whitest-skinned squabs seems to be widespread and we are

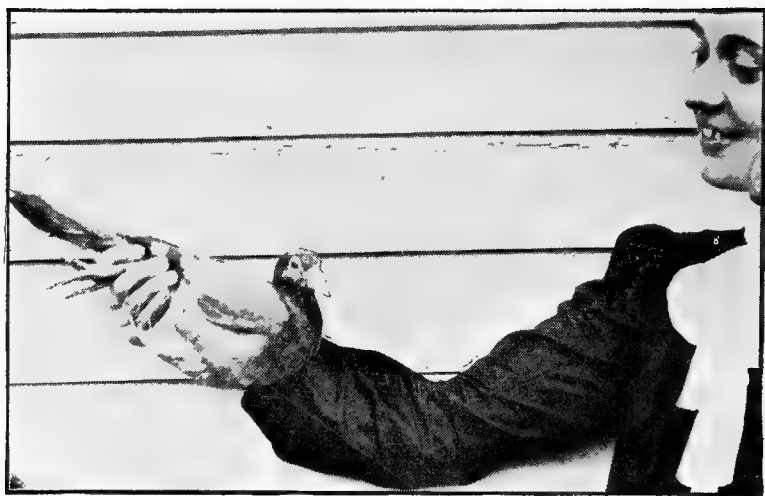

#### **HOW TO HANDLE A PIGEON.**

The fingers of one hand grasp both the feet and the wings, and the bird can neither struggle nor flutter; it immediately becomes calm, realizing that it is mastered.

asked sometimes for a flock of breeders "all white." Our experience with all white Homers is that they have less stamina than the colored ones. (This is also the experience of poultrymen with all white fowls; they are not hardy.) The marketmen will take two or three pairs of dark-skinned squabs in a bunch without comment, but an excess of dark ones will provoke a cut in price. Breeders who are shipping only the undressed squabs should pluck feathers now and then to see just what color of squabs they are getting. The dark-colored squabs are just as good eating as the light-colored ones, but buyers for the hotels and clubs, and those who visit the stalls generally, pick out the plump white-skinned squabs in preference to the plump dark-skinned ones. As a rule, squabs from Homer pigeons are white-skinned—the dark-colored squab is an exception.

### FEW AILMENTS.

Pigeons have few diseases. If housed properly, ailments are seldom encountered. Prevention is much easier and far more satisfactory than cure. When we discover an ailing pigeon, we at once isolate it and if it does not improve, kill it. According to Nature's plans for the survival of the fittest, it is best to get weak and sick pigeons out of the way, then you are sure that your flock is growing hardier and stronger all the time. If there is a diseased pigeon, this is a sign of constitutional weakness, and you do not wish such qualities perpetuated. It does not pay to cure the pigeon. You ought to kill it.

Canker is the most common ailment. It is something like diphtheria, a collection or false membrane forming in the throat. Inject a solution of alum into the throat and this membrane usually comes away.

“Going light” is a disease manifested by a wasting away. If you see a pigeon drooping in a corner, with no ambition to fly, catch it and you will find usually a prominent breast bone and its feathers soiled by diarrhoea. It takes too much time and trouble to cure a pigeon thus affected. We take it as a sign that a pigeon thus affected has not stamina enough to transmit desirable qualities, and kill the bird.

We have learned that canker and kindred diseases are caused by an excess of corn. A corn diet is carbonaceous and fat-producing and the pigeons grow weak when they get too much of it, and fall a prey to disease.

Pigeons kept in a house or loft artificially heated will raise few squabs and will become tender. The coldest weather will have no effect on a flock. The old birds protect the squabs intelligently in freezing weather and do not leave the nests for long periods.

On cold and stormy days when the sun is hid, shut down the windows of the squab house and do not let the pigeons into the flying-pen until the sun comes out again.

When pigeons are from four to eight weeks old, they are in their most precarious period. This is the time of the first moult, and moults are a trying condition for all breeding stock, being a tax on the vitality. When a pigeon has safely passed this first period, the breeder does not worry much

about its future existence.

In the case of young birds, the first mating does not amount to much, the eggs being undersized and the squabs lacking in vitality.

## HOW TO KILL AND COOL THE SQUABS.

To kill a squab, do not use a knife, as the writers advise. Hold the squab in the left hand. Take the head in the right with the thumb at the base of the bill, give it a slight pull, then a push back. This dislocates the neck and in the break of the spinal column a small cavity forms, and this fills with the blood, draining the body. Pull hard and you wrench the head from the body and spoil the looks of the squab. The knack is easily acquired. The first time a woman tries it, she may feel a bit squeamish, but not after she has mastered the operation with the second or third squab. It is painless to the squab and requires but little strength on the part of the operator—merely a little skill which is quickly acquired.

Squabs to be killed should be gathered in the morning, because then their crops are empty.

The cooling of the killed squab is very important. It cost us a good deal to learn the right way. They should not be laid on a board or table, for the tender flesh will turn green at the spot where it touches anything. They should not be hung where rats, cats or dogs can get at them. We have lengths of two by four inch studding and these lengths are hung from the wall by pieces of wire. If the studding is propped up with boards at each end, cats and mice will crawl

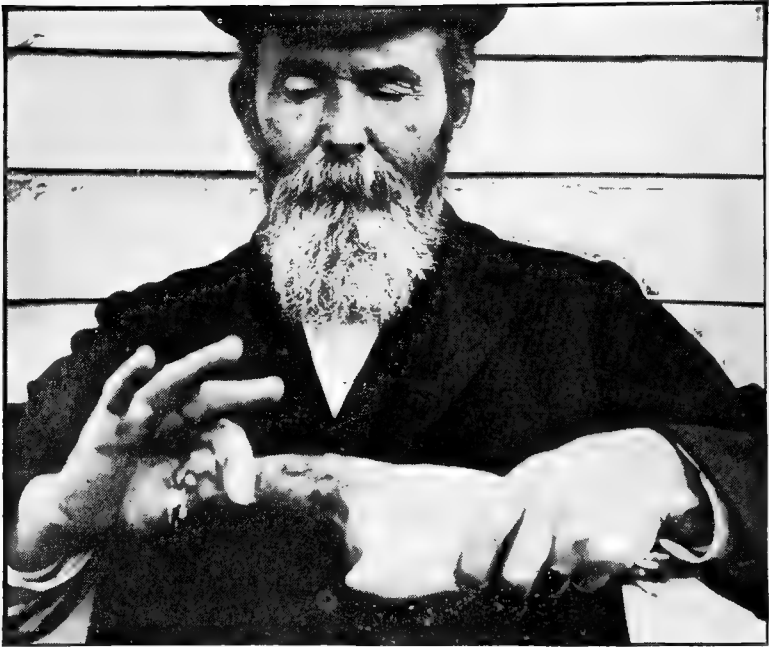

#### **HOW NOT TO KILL A SQUAB.**

The position of the right hand is correct, but the left hand should grasp the neck of the squab close to the fingers of the right. Pull firmly, then push back, and the spine will be broken, the squab expiring instantly. With the hands as shown in the picture, the effect of a pull will be to separate the head from the body. Having illustrated the mistaken way to kill a squab, we have impressed on the operator what to avoid. The correct method is quickly acquired if you studiously avoid the wrong position of the left hand.

up, then along the studding and devour the squabs, but neither cats nor mice can travel along the wires from which our studding hangs. Every four inches along the studding two nine-penny wire finish nails (a finish nail because no head is wanted) are driven in for half an inch or so. The feet of the squab are put between the two nails and the toes prevent the bird from dropping to the floor. We number the nails

---



**THREE DRESSED SQUABS ON A PLATTER.**

Squabs bred from our Homers grow at four weeks to weigh from ten ounces to a pound. The average squab in the Boston market weighs from seven to ten ounces. No one who has not eaten a squab can imagine how delicious the meat is. The bones are small and there is more meat on a squab than on the average duck.

---

in sequence and in hanging up the squabs to cool we know when we have finished hanging just how many squabs we will send to market the next day.

The squabs should be allowed to remain over night. In the morning the animal heat will be entirely gone, and the birds should be sent at once to market.

The ideal squab is not only large and plump but also has

a clean crop (no food in it to sour), has been neatly killed (no blood showing) and has clean feet.

Ship in small quantities, particularly in the summer. Do not pack up an enormous box, or the bottom layers will suffer.

Inability to cool the killed squabs properly has discouraged more squab breeders than all other causes combined. Follow the foregoing rules carefully and you will wonder how anybody could have had any difficulty.

If you are delivering plucked squabs to your market, pick the feathers out when the bird is warm, immediately after killing. Work fast but gently, or you will tear the delicate flesh. When picked clean, throw the squab into cold water and leave it there over night to plump out and harden the flesh. In the summer use ice-water.

During the last few days of its growth, the squab puts on more feathers than flesh. If you discover squabs whose feathers are not prettily out but which are fat and plump enough for market, you may save a week (if you are delivering dressed squabs) by killing and plucking them.

A skillful plucker will strip the feathers from squabs at the rate of ten to twenty squabs an hour. A fast workman should pluck 200 a day.

## HOW TO SHIP.

Pigeons may be shipped anywhere safely. Of all live stock, they are the easiest transported. Breeders of flying Homers in America frequently ship as far as Australia, the



birds arriving in perfect condition. We have shipped squab breeders to the far west, the south, and distant points in Canada, and have never lost one by death or accident. How is this done? There is a little knack to it. The usual fault of inexperienced shippers is that the box or crate is too high, and too large, giving an opportunity for one bird to pass another by flying over its head. If there is too much room between the top and bottom of the crates feathers will be ruffled and pulled out, and the birds by crowding, will suffocate one or two. A large, heavy crate also adds enormously to the express charges. It is not pleasant to buy pigeons and receive them in a cumbersome box weighing from 25 to 75 pounds, on which the express charges are more than double what they would be were the birds crated properly. The best wood to use in crating is that of which egg crates are made. It is thin (about one-eighth of an inch), very light and tough and splits evenly. The ends and back of the crate should be made of half-inch or five-eighths pine boxing. If you procure this sawed six inches wide, in varying lengths, you may make up crates to suit your order. The floor or bottom of the crate should be solid, also the sides and back. For the front and top, split the thin stuff about two inches wide and tack to the boxing with three-penny nails. The pigeons should be packed closely (but not too close), giving each room to turn and move about. In the six-inch space they have just about enough room to stand, and the contact of their heads with the top slats will remind them that they must not attempt to fly, and they do not. If

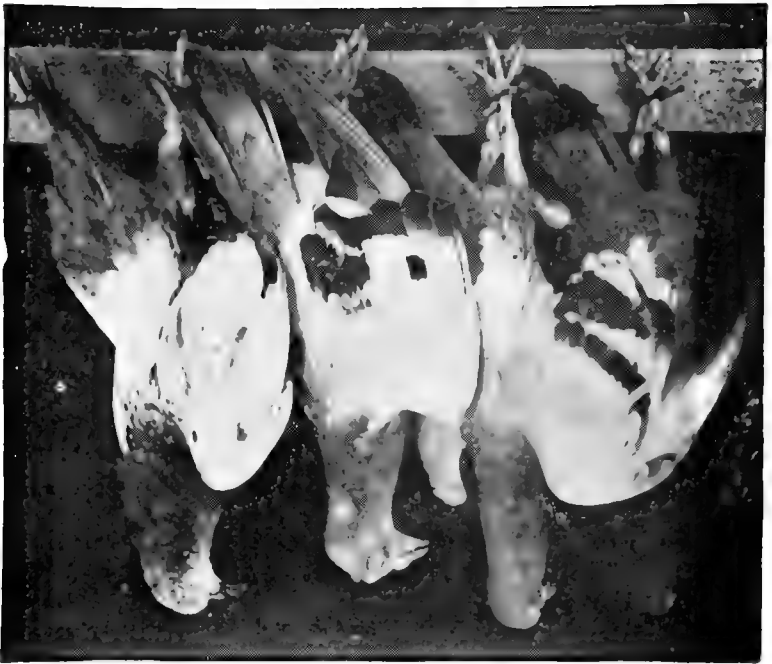

#### **HOW TO COOL THE KILLED SQUABS.**

The large size of squabs at four weeks of age may be judged from the fact that the wooden studding in the above photograph is two inches thick. The nails are ninepenny wire finish, and the distance between the pairs of nails is four inches. The studding is hung at the ends by wire fastened to the ceiling so that rats and cats cannot get at the squabs when they are cooling over night.

they are going to a point only a day or a day and a night distant, they need no feed nor water. If the destination is more remote, two tin cups, one for grain, the other for water, should be tacked to the inside of the crate. A sponge should be placed in the water dish and wired in loosely so the birds cannot peck it out. This prevents the water from being spilled in transit. A given quantity of water lasts longer and keeps cleaner. For a very long journey, a bag of grain should be nailed to the crate. It is the duty of the express messengers to feed and water the birds en route, and they are so instructed by their companies. It is well to tack a tag to the crate giving general directions to the express messengers, in a case of long distance shipment.

Do you know that live stock is transported long distances by the express companies at the rate charged for ordinary merchandise? For carrying live stock short distances, the animal rate (which is double the merchandise rate) is charged. This is a peculiar rule, and it works so that the buyer at a remote point gets his shipment cheaper than the buyer nearer us. For instance, we can ship a crate of pigeons to Chicago from Boston cheaper than we can to Buffalo. All the express companies doing business in the United States and Canada have the same rule, which is, that between points where the single or merchandise rate is \$2 or more per 100 pounds, live animals, boxed, crated or caged, are charged for transportation at the single or merchandise rate. Between points where the single or merchandise rate is less than \$2 per 100 pounds, live animals are charged the animal

rate (which is double the merchandise rate). In order to obtain the lowest rate of transportation, the value of each pigeon must be stated by the shipper at \$5 or less. At one time we bought a lot of fine Homers at \$10 a pair and when they arrived we were asked to pay a big transportation charge. We discovered on investigation that the shipper, when asked the valuation by his agent, proudly replied (wishing to convince us perhaps that he was selling the birds to us at half price): "Ten dollars apiece." The agent made no argument with the shipper (they seldom do) and accordingly billed the charges to us at a rate just double what he would have billed had the shipper declared the valuation \$5 apiece, and we had to pay accordingly for the exhibition of pride made by the shipper. When the agent asks you the valuation of the pigeons, get it within the \$5 limit, or your man at the other end will have an extra charge and a sharp letter to send back to you.

We have seen breeders who have been shipping live stock for years and they never heard of the above rule of the express companies, and also we have seen scores of express agents who did not know of their own rule, but always charged the animal rate on animal shipments. But the rule is found in every graduated charge book of every express company, and the experienced express men and experienced shippers know all about it. If the agent in your town is ignorant of the rule, ask him for his graduated charge book and you will find it under the classification "Animals." Every customer of ours entitled to the single or merchandise

rate on his shipment gets a card from us in our letter to him with the rule printed on it. Many express agents at local points seldom handle a live animal shipment and do not know how to charge for it.

A live animal contract release, to be signed both by shipper and express agent, is needed in all cases where the value of the shipment is over \$5. If pigeons which we ship are killed in a smash-up, we can recover from the company. We have no hesitation, therefore, in guaranteeing the safe delivery of our pigeons to customers. Our responsibility does not end when we have given them to the expressman. Our guarantee follows them as long as they are in the hands of the express company. We will put them into your hands safe and sound.

Once in a while you will read of live stock and breeding associations getting together and complaining about the "exorbitant rates" charged by the express companies. The trouble is not with the rates of the express companies, but lies wholly in the ignorance of the breeders who meet to complain. They simply do not know how to ship and how to talk to the express agents.

We never read the above advice as to shipping live stock in any book or paper. It is the product of our own experience and the information cost us at least \$100 in excess charges before we learned how to get the low rate. It is worth dollars to our customers, and that is why we have given it here in detail.

Killed squabs go to market at the rate charged for ordi-



**HAVING HIS PICTURE TAKEN.**

This pigeon, one of the best of our squab-breeders, is a pet and will fly to the hand. He remained still for over a minute while the photographer focussed the camera.

nary merchandise, no matter what the distance. Breeders having special customers who wish the squabs plucked should pack them loose in a clean pine box (with ice in the summer) and nail the box up tight. Such shipments go through in splendid condition and if the breeder has a choice article, with his trade mark stamped on the box, he gets the fancy price. Squabs which reach the Boston market from jobbers in Philadelphia and New York are plucked and packed with ice in barrels. Breeders around Boston who reach the Boston market with undressed squabs send them in wicker hampers or baskets on the morning of the day after they are killed.

### BOOKKEEPING.

If you wish to have a very accurate record of your breeders, or if you are breeding pedigreed stock, you should mark the squabs when they are four or five days old. The only practical method is to place around one leg of the squab a seamless metal band, usually made of aluminum and having stamped on it your initials and a designating number, to correspond to the number of the card in your card index. When the squab is young, the toes may be squeezed easily through the band. As the squab grows, the growth of the claws makes the removal of the band impossible. The squab should be inspected occasionally for a day or two after you have put on the band, to make sure that it has not worked off (which sometimes happens). Having marked your breeders, you know each by its number, and you may make dif-

ferent matings and keep a record which cannot get mixed.

On the left of your record page or card write the date of laying, then figure 17 days ahead and write the day of hatching. When you get the hatches, and as the squabs grow to market size, write whatever memoranda concerning their size, color, etc., you wish. As the same pair of birds occupy the same pair of nests year after year, your record will be an accurate one.

If you allow five cents a month for the board of one pair of breeding pigeons, you can figure the amount of grain needed to a nicety. In a large flock, fifty cents a year will cover the cost. A pair of pigeons not breeding will cost only thirty-six cents a year.

## TRAINED FLYERS.

A very profitable business may be built up in flying Homers. If you have the time and the inclination, do not fail to have a pen of flyers and pens of fancy varieties of pigeons. Champion flyers and fancy birds sell from \$10 to \$100 and more, everything depending on the skill of the breeder.

Young birds raised in your own squab house may be allowed to fly wide in the neighborhood, if you choose. They will not leave you. If you buy young birds of us, with the intention of raising flying Homers, you may dispense with the flying-pen. (But all market squab-breeders use flying-pens and confine their birds, so as to control their feeding, etc.) If you buy old birds of us, and have no flying-pen, they will leave you and fly back to us to the squab house where they were raised. If you live far from us, it may take



the pigeons some time to work back, but barring accident, they will turn up at our place some time, for that is the working of the instinct of Homer pigeons.

The young Homers when five months old are strong enough to be trained to fly. Take them in a basket (having omitted to feed them) a mile or two away, and liberate them one by one. They will circle in the air, then choose the correct course. You should have left grain for them as a reward for their safe arrival home, and an inducement for their next experience in flying. Two or three days later take or send them away five miles and repeat. Next try ten miles, and so work on by easy stages up to 75 or 100 miles. If you have a friend in another city, you may send your birds in a basket to him with instructions to liberate certain ones at certain hours, or you may send the basket by train to any express agent, along with a letter telling him to liberate the birds at a certain hour and send the basket back to you.

If you wish to have the bird carry a message, write it on a piece of cigarette paper (or any strong tissue), wrap the paper around the leg of the bird and tie with thread; or, you may tie the tissue around one of the tail feathers. A thin aluminum tube containing the message may be fastened to a leg, or to a tail feather.

A trap window should be constructed to time the arrival home of birds. This is an aperture about six inches square closed by wires hanging from a piece of wood at the top of the aperture and swinging inward, but held close to the aperture by its own weight. The pigeon cannot fly out but on its return home (if you have sprinkled grain on the



**THE SQUAB BREEDING RANCH**





**AT PEMBROKE, MASSACHUSETTS.**



**LONG SQUAB HOUSES.**

inside of the house, next the wires) the bird will push the wire door and go in. It takes only a day or two for the pigeon to become accustomed to the trap. If you connect the trap with a simple make and break electric circuit, the pigeon on its arrival home from its flight will ring a bell in any part of your house or barn.

When you have a record of the flyers, you will have a guide for mating. The majority of fanciers recommend a medium-sized Homer. A large hen should be mated to a small cock, or a large cock to a small hen. Instead of mating birds of equal age, try an old cock with a young hen, and vice versa. For vitality and stamina, it is best to mate birds of different colors.

A pair of breeding pigeons will occupy the same pair of nests year after year, and they never will change mates, but you may break up an undesirable mating if you choose and re-mate the birds according to your determination, using the mating coop as described.

## **CHEAP BREEDERS ARE EXPENSIVE.**

There is a great difference between common and Homer pigeons, although they look alike to a beginner without advice. Indeed, there are many common pigeons which are larger and fatter than Homers, but the squabs they raise are as skinny as sparrows. It is an effect not of flesh but of feathers, which in a common pigeon are fluffy. The feathers of a Homer are laid tight as a board, the skin fits as close as a glove, and the flesh is hard and firm. The flesh of a common pigeon is flabby and soft, and the skin loose. The

Homer has a long bill, its head in front of the eye is large. The bill of a common pigeon is short, its bill is more hooked and is sharper pointed, its head is shorter and more rounding on top. This is the kind of pigeon seen in the streets. They are bred only for use by undertakers at funerals, or by trapshooters. They will live anywhere but a Homer has only one home. They cannot find their way back to their usual roosts if they wander away, but a Homer always flies straight home. The common pigeons will alight on any buildings. A Homer will alight only on its own squab house, and if prevented from so doing will remain circling in the air overhead for hours. Common pigeons will move from one neighborhood to another and will foul different springs and wells, becoming a nuisance in a country community. A Homer drinks at its own home. A common pigeon has little intelligence. A Homer has the largest brain and the most intelligence of any variety of pigeons. Common pigeons are worth about fifty cents a pair and are sold to the unsuspecting as Homers. "See how large they are," the dealer will say. But as we have said before, the size is one of feathers and not of flesh, and the squabs are worth only ten to twenty cents a pair, and cannot be sold in an intelligent market. It is useless to think of starting with common pigeons and improving them as you go along by mating them with Homers. At every mating you take from the Homer side the desirable qualities and add only undesirable qualities. It is like trying to make champagne out of dishwater. You can do something practical only when you have

eliminated the common pigeons entirely and are mating thoroughbred Homers. Do not be deceived by a hasty inspection of pigeons—a common pigeon is unlike a Homer as a crow is unlike a grouse. It is hard to make some beginners comprehend this difference. All pigeons (especially if they are of similar-colored feathers) look alike to them and they buy the cheapest they can get, with the inevitable result that they quit the business in disgust or are forced to dispose of their foolish purchase to trap-shooters and begin again with an outfit of Homers. It stands to reason that a pair of birds capable of earning a fifty-cent pair of squabs once a month is easily worth from \$2 to \$4, and that a pair of birds capable of earning only a ten-cent pair of squabs once in two or three months is worth only fifty cents.

We had one or two unsatisfactory experiences with persons who had breeding Homers for sale “cheap,” “large flock very low,” etc. These pigeons proved an expensive investment. They were either birds that had been worked for ten or twelve years, beyond their period of usefulness, or were too young, or were unmated, or there was an excess of cocks, and much time and effort were lost before we discovered the fact. One lot of Homers which we bought “at a bargain” produced very few No. 1 squabs, but mostly culls, and it was plain that the dealer of whom we purchased had got rid of something which was unprofitable for him. The reputation of the breeder goes a long way in a pigeon sale. The beginner will find himself safe when he pays a fair price to a reliable breeder. Genuine cases of good Homer pigeons

being sold at "sacrifice prices" are rare. There is always something the matter with cheap pigeons. As in every line of trade, and in farming and all stock-breeding, articles that earn more are worth more.

## SUPPLEMENT

### DEFINITION.

Look in the Standard dictionary for the word SQUAB and it is found to be derived from the Swedish squabb, meaning FAT, or fat flesh. Used as an adjective it means fat, bulky. As a noun, it not only means the young of pigeons, but also a well-stuffed cushion. The idea that a squab is fat is thoroughly conveyed by the use of the word.

### MANURE WORTH MONEY.

Clean the droppings out of your squab house and flying pen once a month or so. This manure is in demand by tanneries and you should get at least \$80 a ton for it, or about fifty cents a bushel. The sale of the manure should pay from one-quarter to one-third of the grain bill.

The tanneries want the manure for its alkali, in which it is very rich.

There is a point in this connection which you will find helpful. When washing the nappies in hot water, to cleanse them, you will not be obliged to use soap, for the alkali in the manure will unite with the water to form a strong cleanser.

Pigeon manure is in demand all the time by buyers who advertise for it. Here is an advertisement cut from the Boston Sunday Globe of Feb. 23, 1902:

Wanted to Buy—Pigeon manure by J. J. McKittrick, 14 Kingston st., Charlestown, Mass.

### FLYING ROOM NEEDED.

Customers occasionally write us and describe a poultry house or other building which they have, and ask us to tell them how many pairs of pigeons it will accommodate.

No matter what the building, it will accommodate as many pairs of pigeons as you can find room for pairs of nest-boxes. Put in all the nest-boxes for which you have room, then you will know how many pairs of pigeons you can accommodate. As to the size of the flying pen, make it as small or as large as you have room. As we tell in writing about how to utilize a garret or barn

loft, you do not need any more than a place where the birds can hop or fly into the direct sunlight. Of course it is better to give a good-sized flying pen when you have room.

Nail up the roosts in the squab house wherever you have room, placing them about 15 inches apart. You understand only part of the birds roost at a given time. While some are roosting, others are on the roof or on the nests. The patent roosts which you will find advertised are not so good as the old-fashioned inverted V-shaped kind because the latter prevent a bird from soiling the bird underneath, while the patent ones do not.

A letter is just at hand in which the writer says: "You do not say how many birds can be kept in one pen or flock." We repeat, you can keep as many birds in one flock or one pen as you wish, or as you have room for pairs of nest-boxes. We recommend the Robinson Unit with its 25 or 50 pairs of birds because in flocks of that size you have something arranged orderly and precisely, which you can keep track of in a positive, definite manner, but they do equally as well in one flock, regardless of number, provided they are all Homers.

### SORTING SQUABS.

Squabs are killed when they are four weeks old because they are full size then. They have more meat on their bones at four weeks than at eight weeks, because at five weeks old they begin to feed themselves, and lacking the forced feeding given by the parent birds, they become thinner. Their muscles are also hardening by use. At four weeks all the feathers are prettily out. If at four weeks you are undecided whether or not to kill, be guided one or two days either way by the fullness of the feathering. Sometimes a squab can be killed when a day or two over three weeks old. The more you shorten the time, the less the product costs you.

In sorting, do not forget to keep the plump-est squabs in one lot and those not so plump

in another lot. Do not tie up a plump with a thin squab so that the buyer will have a chance to say: "This is a mixed lot, I cannot pay you the No. 1 price." By keeping all the birds of one kind together you prevent the buyer from making comparisons. Shippers of farm produce of all kinds know how this is. They ship to one dealer their firsts and to another dealer their seconds and very frequently the latter dealer pays the No. 1 price because the goods are equal to the goods of others for which he pays the No. 1 price.

#### REMODELED HOG-PENS.

We print one picture here to show how one of our customers started at very small expense. He took the hog-pen side of his barn and fixed it over as you see. The staging on which the birds sun themselves was made out



of boards cheaply. The nest-boxes and roosts inside take up only a small part of the structure. Anybody who has a barn or an outbuilding of any kind can fix up the sunny side of it as shown here and put into breeding stock the money which others use for a special building.

#### NEAR THE SEA.

A few beginners who live on the seacoast write and tell us that they are going to move inland to raise squabs. We have advised them not to do it. The Homer pigeon is derived from the old rock pigeon, which bred in the cliffs, and the seacoast was its natural home. They thrive in salt air. If the tide or a creek runs from the sea into your property, build your flying pen over the water and let the birds enjoy it.

If you live inland and happen to have a brook or river running through your property, build your flying pen over it and the birds by bathing and drinking in running water will save you the trouble of supplying bath pans.

#### ON BUYING.

Many beginners ask us to advise them on starting, whether to buy mated or young birds, etc., and how many. We recommend that beginners start with our best mated adult birds, as many pairs as you can afford. It is just as easy to care for a good-sized flock as a little one, and the earnings are larger. Remember, your time is the big factor. You will have to pay attention just as often to half a dozen pairs as you will to 25, 50 or 100 pairs. If you wish immediate returns, with weekly sales of squabs to pay for the grain, and a profit besides at the start which will keep rolling up, then buy our mated adult birds, and the extra quality if you believe that the best is the cheapest, as it undoubtedly is in the case of squabs, for there is at least a dollar's difference per dozen in the market price of the squabs they raise.

If you have, for instance, \$50 to invest, put \$40 into your birds and \$10 into your building, rather than \$10 or \$12 into your birds and the balance into the building. Almost any place will do for a shelter if it is waterproof. Your flock will earn a better building.

#### USE OF ICE.

Ice is not absolutely needed in the summer by the squab breeder. Every house has a cool room or a cool cellar in which the squabs can be hung from the studding as described in the Manual. In shipping to a distant market on hot days, ice will be needed.

The squab breeder will find it better to manage in this way: When summer time, with its comparatively low prices comes, let your flock multiply, keeping the squabs and growing them up for breeders. You will more than make up the delay when the cool days come.

#### MARKET CONDITIONS.

The New York market for squabs is undoubtedly one of the best in the country and our customers who live within shipping distance of that city have opportunity to make a mint of money. A squab-breeder in Mauricetown, N. J., writes us: "Your Manual received and I am pleased with it. We are now getting in New York for dressed squabs \$4.25 to \$4.50 per dozen. Did not get below \$2.50 last summer. We have express or freight to pay and five per cent. commission



for selling. Our houses are not as complete as yours. We do not have any floor in our houses except the earth. Have about 300 pair pigeons and last year shipped 2700 squabs. We feed three times a day in the flying pen and on the ground, and in wet weather this is quite a disadvantage. Your self-feeder strikes me as being very desirable. We keep fifty pair pigeons in each house."

At the same time the above correspondent was getting \$4.25 to \$4.50 a dozen for his squabs, we were getting for ours in Boston \$3 a dozen. There is an immense and very rich hotel trade in New York, not to speak of the fine butcher shops. Such hotels as the Waldorf-Astoria, Imperial, Fifth Avenue, Hoffman House, Astor House, etc., and restaurants like Sherry's and Delmonico's will pay as high as \$8 and \$10 a dozen for choice, plump squabs, and if the squab-breeder will personally interview the proprietors of these places, when he has stock ready, he will make sales at top-notch prices direct, avoiding the middleman. Anybody owning a farm on Long Island, in southern New York, northern New Jersey or Connecticut, can make a fortune by shipping squabs to New York.

Our advertising has brought us many letters from game supply houses, hotels and clubs in New York who wish to buy our killed squabs, and offering to pay from \$4 a dozen up. We do not care to supply them, having our hands full in raising live breeders and in supplying Boston game dealers under contract, but our customers are welcome to this trade. To every customer of ours who buys breeding stock and who wishes to supply the New York market, we will give letters of introduction to desirable squab buyers in that city. We intend to work up opportunities for our customers in every large city. The right to use our trade-mark and brand, "Plymouth Rock," is given by us to every customer who buys breeding stock of us, and can be used by no other breeder.

A correspondent in New York state sends us a clipping from the New York Tribune's market columns and asks us to interpret it. We quote from the price-list as follows:

"Pigeons, 20c.; squabs, prime, large, white, per doz., \$3.50 and \$3.75; ditto, mixed, \$2.75 and \$3; ditto, dark, \$1.75 and \$2."

The quotation, "Pigeons, 20 cents," means 20 cents a pair for common old killed pigeons. These tough old birds are occasionally found in the markets and are worth only 10 or 15 cents apiece. They are neither squabs nor the old Homer pigeons, but are common pigeons such as fly in the streets. A small boy might get a pair of these street pigeons

and kill them and give them to a butcher who would pay him 15 or 20 cents a pair. These cheap pigeons come into the eastern markets largely from the West in barrels and are sold to Boston commission men for five cents apiece, or 50 cents a dozen. They are retailed at from \$1 to \$1.20 a dozen. They have been killed with guns and have shot in their bodies. If you ask for pigeon pie at one of the cheap Boston restaurants, you will get a shot or two against your teeth with mouthfuls. After every trap-shooting contest some skulker goes over the field and gathers up all the killed and maimed birds he can find, and sells them for two and three cents apiece, or for anything he can get, and these find their way into the markets. The cruel practice of pigeon shooting by mis-called "sportsmen" on Long Island is quite common, and the presence of these birds in the New York butcher shops accounts for the above quotation in the Tribune. It is unnecessary to add that such birds do not compete with squabs. They can be made palatable only by stewing for hours in a pie, which takes out a little of their toughness.

As to squabs, the quotation, "Prime, large, white, per dozen \$3.50 and \$3.75," is for the kind of squabs that are raised from our Homers, namely, No. 1 grade.

By the quotation, "Mixed, \$2.75 and \$3.00," is meant that these amounts are paid for lots of birds composed of No. 1 and No. 2 grades, mixed. If you sort up your birds carefully you will be able to get the No. 1 prices for all. Some people do not know how to sort them, and they have to be satisfied with the price of a mixed lot.

By the quotation, "Dark, \$1.75 and \$2.00," is meant the dark-fleshed squabs, as you have learned by reading our Manual. Squabs whose flesh is dark do not sell for as much as the white-fleshed squabs.

Pigeons are of all colors, i. e., as you see their feathers, and the squabs likewise, but when you pluck the feathers off the flesh is either a pure white with a tinge of yellow or dark like a negro's skin.

Quotations for squabs as found in the market reports in the newspapers are always lower than they really are. The writers of the market columns in the daily papers see only the commission men and cater only to them; they smoke the commission men's cigars and believe what the commission men tell them. They do not see the producer at all. The object of the commission men is to get the squabs as cheap as they can. When you are breeding squabs make up your mind to get from 25 cents to \$1 or more per dozen

than you see quoted in the market reports. At the same time the report quoted above was printed in the New York Tribune the breeder in Mauricetown, N. J., previously quoted, was getting from \$4.25 to \$4.50 a dozen for his squabs. (This was the last week in January, 1902). You see, it does not pay to trust wholly to the market reports in the newspapers. The motive of the city men is to get their goods as cheap as they can. It is your motive to get as much as you can, and don't be fooled by second-hand information. Go direct to headquarters yourself in person and learn the truth. If the middleman tries to hold down the price to you, go to a consumer and make your bargain with him at top prices.

A breeder in New Jersey who has become interested in our methods writes that there are several squab breeders in his town, all of whom give their regular time to other businesses. He continues: "I am now (February, 1902), getting 32 cents each as they run, no sorting, for what few squabs I am now raising, and they are sold to a man who calls every Tuesday for them. When I have enough, I ship direct to New York by express. They sort them in New York."

This is doing extremely well for unsorted squabs. It is only another bit of evidence which proves the money-making condition of the New York market. (The above correspondent's breeders are not first-class, he admits, saying he has been breeding for seven years and his flock has run down, and his object in writing to us is to buy a new flock.)

The Kansas City market does not yet know what a fat squab is. The only things obtainable there are the squabs of common pigeons, which are quoted low, as they are all over the country. A correspondent in Atchison writes: "I wrote to the Kansas City dealer again, telling him I thought his prices were pretty low for Homer squabs. He replied that they had so few Homers offered that they did not quote them, and they would be worth from \$2 to \$2.50 per dozen. He quoted common pigeon squabs at \$1.25 to \$1.75 per dozen, as I wrote you before. That is better, and I want to try raising them as soon as I can get into a place where I can handle them."

Fact is, the squabs that bring from \$3 to \$5 a dozen east of the Mississippi will bring that (and more) as soon as the wealthy trade of Kansas City get a taste of them.

#### AS TO THE NESTS.

The nests seem to puzzle some beginners. Get these terms accurately in your mind:

First, the nest-box, which is made of wood; second, the nappy, which is made of yellow glazed earthenware in two sizes, the uses of which are fully explained; third, the nest, which is built by the bird in the nappy. Each pair of pigeons must have two nest-boxes. In one nest-box you put one nappy, in the other nest-box another nappy.

#### WATER SUPPLY.

During the winter (and at all seasons, if you wish), you can save steps for yourself by locating the bath-pan in the squab house. We recommend the suggestion of Mr. Barry, a squab breeder with whom we are acquainted. It is on the wet sink principle. The sink is made of wood or galvanized iron 2½ feet square with a two-inch hole in the centre and a two-inch pipe six inches long leading from the hole through the floor of the squab house, for drainage. The bath pan is set in the sink, which rests on the floor. The following will make the idea clearer:

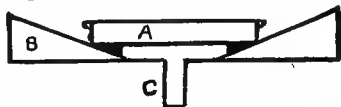

A is the bath pan, B the sink and C the drainage pipe. When the birds bathe in the pan, the water which they splash is caught by the sloping bottom of the sink and runs out through the pipe. The blocks under the bath pan are three or four in number and do not extend all around the sink, but merely steady it to prevent sliding and tipping. Pigeons drink after they have taken food and by this arrangement they have clean water for drinking as well as bathing. All the splashed water is taken out of the way and the floor of the squab house remains dry. The sink is not nailed to the floor and can be taken out easily for cleaning or white-washing.

If you can afford it, pipe your squab house for running water and set the above wet sink and bath pan under an open faucet, and let the water run slowly continuously, or you may turn it on when you choose from a valve in your house or office. This is an ideal labor-saving arrangement for a big plant with 25 to 50 bath pans. Don't let the overflow collect under the squab house. It must be drained off the premises.

#### INCREASE IN FLOCK.

The table on page 12, showing the possibilities of pigeon breeding, was compiled by Dr. W. R. Amesbury.

Many beginners wish to know if it will be

all right for them to buy a flock and keep it in one house for six months or a year, paying no attention to the mating of the young birds, but leaving that to themselves, so as to get without much trouble a large flock before the killing of the squabs for market begins. Certainly, you may do this, providing extra nest-boxes from time to time until your squab house has been filled with nests; then you will have to provide overflow quarters. We are asked if the flock will not become weakened by inbreeding, that is, a brother bird mating up to a sister, by chance. According to the law of chances, such matings would take place not very often. Pigeons in a wild state, on the face of a cliff, or in an abandoned building, would mate by natural selection. The stronger bird gets the object of its affection, the weaker one is killed off or gets a weaker mate, whose young are shorter-lived, so the inevitable result is more strength and larger size. Nature works slowly, if surely. A lot of pigeons in one pen mating as they please when old enough is the natural way, and if you follow this, you cannot go very far wrong. We advocate matings by the breeder because it hurries Nature along the path which makes most money for the breeder. We all know how Darwin studied natural and forced selection with pigeons. He took one pigeon with a certain peculiarity, say a full breast, and mated it to another pigeon with a full breast. The squabs from these birds, when grown, had breasts fuller than their parents. Then these in turn were mated to full-breasted pigeons from other parents, and the grandchildren had even larger breasts. Darwin's experiments covered a period of over twenty years and in this time he developed little faults and peculiarities to an amazing degree. Every intelligent, careful pigeon breeder is striving by his forced matings to push along the path of progress the peculiarity in pigeons which is his specialty. The breeder who selects most carefully and keeps at it the longest wins over the others. By selecting from our best and most prolific breeders the biggest and fattest squabs, keeping them for breeders and mating so as to get something larger and plumper, we are getting all the time bigger squabs. We expect eventually to raise squabs which when four weeks old will be as big as market-sized chickens. We are amused sometimes by the thought that we have made some progress in this direction, for a judge of poultry at the big Boston show in 1901 was fooled by our squabs and gave them first prize in the chicken broiler class! Every breeder of

squabs has it in his power to increase the efficiency of his flock by studying his matings. At the end of a year, his squabs should be larger than when he started, at the end of two years still larger, and so on. There is commercial satisfaction in breeding for size and plumpness because it pays at once, and at the same time the breeder has the satisfaction of increasing the stamina and variety of pigeons.

To be master of the matings, the breeder should band his squabs as described in the Manual. As soon as they are weaned (that is, as soon as the breeder sees them flying to the feed and eating it) they should be taken and put into a rearing squab-house. When about six months old, the breeder should begin mating them by selection, using the mating coop, then when they are mated turn the pair into a working pen with other adult birds. By looking at the number on the band of each bird, then on your record card, you know how to avoid mating up brother and sister.

When the young birds are just over four weeks old, or between four and six weeks, they are able to fly a little, and if they do not hop out of the nest (or are not pushed out by the parents) you may push them out yourself. They are now able to feed themselves and you should provide an auxiliary feeding trough in the squab house for them. In a week or so longer, they will be bright enough to go to the self-feeder in the flying-pen. If these young birds are left in the squab house, they will bother the old birds by begging for food, and this infantile nagging will hinder the regular breeders in their next hatch, so the very best thing to do is to put the young birds by themselves in a rearing house, where they cannot bother anybody.

Of course there is likely to be a little inbreeding when you leave the birds to choose for themselves, but not much. If the breeder has not the time to make forced matings, then he may not care to make them. Remember in mating that like begets like. The parent bird that feeds its young the most, and most often, will raise the biggest squab. Sometimes a parent bird will have fine nursing abilities and will stuff its offspring with food. These good-feeding qualities are transmitted from one generation to another and are as much under the control of the breeder as size and flesh-color. Your biggest squabs will be found to have an extra-attentive father or mother, or both. A pigeon with a dark skin if mated to a white skinned bird will produce a mulatto-like

squab. It is the large, fat, white-fleshed squab which you are after. Disregard the color of the feathers when mating. If when plucking your squabs you come across a "nigger," that is, a squab with a dark skin, find out what pair of breeders it came from, and whether the cock or the hen is at fault, and get rid of the faulty one.

It is important to start with adult birds that are not related, then you will not begin inbreeding. That is why we make a special effort with our adult birds to have them unrelated, and with our system of identification and record keeping we can do it with precision.

A breeder in Moorestown, N. J., writes us: "I have read your circular ('How to Make Money with Squabs') and find according to my experience (of seven years) that you do not make as many departures from the truth as most books I have received on the subject, and as I don't claim to 'know it all' I have a desire to read your Manual. I am now getting rid of a lot of my stock in order to make some alterations to my buildings and will need some new blood in my lofts."

There is always something to learn in pigeon breeding and like our correspondent, we do not claim to "know it all," either. It is an open field, and the best thought and industry take the lead. We do not intend to make any departures from the truth and most certainly have not, in the light of our own experience. We take our correspondent to mean that he has not discovered any inaccuracies worth speaking about. Everything is as plain and precise as we can make it, and carefully stated.

#### CLEANING TROWEL.

The nappies are cleaned in hot water. To clean the nest-boxes, the very best imple-



ment is a square-pointed trowel, as shown in the illustration. These trowels are seldom found in the country and not in every city hardware store, but one is worth having, even if you have to send away for it. The kind we use is of thick steel, bevelled front and sides, which cannot be bent, and strong handle. The edges may be ground sharp. The caked droppings can be dug off from the nest boxes with this handy tool quickly and easily. With one sweep of the side edge you can rough out a nappy and put off washing time

a fortnight.

#### HOW TO CATCH THE BIRDS.

If for mating purposes, or for any other reason, you wish to catch a pigeon, walk into the squab house or flying pen at any time of the day with a net on the end of a six-foot pole—like a butterfly catcher. You can catch the bird you want in half a minute. A Homer does not struggle fiercely to elude capture. It acts with some intelligence as if realizing that it may injure its wings.

When dusk comes you can handle pigeons as easily and almost as fast as you can apples. You need not wait until it is pitch dark. At 5.30 P. M. in the short winter days, and 7.30 P. M. in summer, we can go into the squab houses and crowd the birds into one end, then reach fast for the ones we want, their identity being clearly distinguished. They are as quiet as kittens in the semi-darkness, making little or no fluttering, and can be transferred to a basket or crate as fast as you can pick them up with the right hand, holding the basket with the left.

#### INBREEDING.

Some letters from customers make plain to us that a clear knowledge of what inbreeding means is not possessed by everybody. Several have written to this effect: "If I buy two or three dozen pairs from you to start, how can I increase the size of my flock without inbreeding." Now, inbreeding, or breeding in, is the opposite of breeding out (or line breeding). When (1) a brother is mated to sister, or (2) a father to a daughter, or (3) a mother to a son, or (4) a grandson to his grandmother, etc., that is inbreeding. We know it is forbidden by law for human beings to mate in that manner, because (a) God in the Scriptures has forbidden it, and (b) because the State does not wish to have to care for the puny, weak-minded offspring that would result from such unions. We all know that the marriages of cousins often result in demented, diseased children. Now suppose you buy two dozen pairs of pigeons of us, and number them Pairs 1 to 24. If you mate the offspring of Pair 2 (or any other pair) to the offspring of Pair 1 (or any other pair) that is outbreeding. What you do not do, and what you try to prevent, is the mating of the offspring of Pair No. 1 (or any other pair) to each other. So, you see, if you have a dozen or two pairs, you need never inbreed, for there is an infinite variety of matings possible. Breeders of animals sometimes inbreed purposely in order to get better color of fur or plumage, or finer bones, etc., but what is gained in these respects is lost in size and stamina. Fowls

hatched from studied inbreedings often are so weak that their progress across the barnyard is like the tottering, falling progress of a drunkard. There are no brothers and sisters in the flocks we sell. If you buy one dozen or twenty dozen pairs of breeders of us, the pairs will be unrelated, and you need never inbreed.

#### NAPPIES.

This illustration shows the two nappies, the small size and the large size, the uses of which we have fully explained. They are made of yellow glazed earthenware. On Page 29 we say: "Do not use the earthenware nests or wooden boxes which you may find advertised," meaning by "earthenware

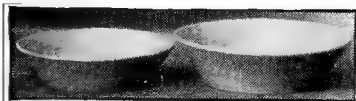

nests" the extremely deep heavy, brown, unglazed clay nests shaped something like the bottom part of an egg cup (only, of course, larger). These are not only expensive, but impractical, a relic of ancient, cumbersome and ineffective methods.

#### FOOD MATERIALS.

If any of the food materials which we tell about in the Manual puzzles you, ask your grain dealer for samples and prices. Some write to us saying they have never heard of Kaffir corn, another wishes to know where he can get red wheat. All the food supplies are obtainable anywhere in the United States, Canada or foreign countries. If your grain dealer has not on hand a certain kind, the reason is that he has few calls for it, but he can get it for you as easily as he gets oats or chicken food. Many grain dealers keep only horse feed and don't know anything about other animal foods. If the dealer nearest you has no Kaffir corn, ask him if he has a pigeon mixture. You will probably find his pigeon mixture contains Kaffir corn, and this mixture is what you should buy. Put it into your self-feeder just as it is. Mix up the quantity for the self-feeder of wheat and corn (bearing in mind what we have said about varying the amount of corn so as to keep down the heat in the blood). Vary the dainties, feeding by hand as much or as little as you choose. The birds will search out the dainties with a rush and eat them first. Throw them on the yard of the flying pen or the floor of the squab-house.

On Page 33, "How to Feed," the diet given is for local (New England) use. We did not

think the Manual would find its way over such a wide area of country as it has. We wish to emphasize the fact, that pigeons are like human beings. To be kept in perfect health, they must be given a variety of foods. We did not intend to give "Feed no whole corn," as a hard and fast rule. In the spring months, it is impossible to get cracked corn that is sweet and good. It heats, sours, and is unfit for feed. Another thing, in some localities it is not convenient to procure the cracked corn. Then we say feed the corn whole. But remember to keep your birds in health, you must feed a variety of other grains. Locality often determines the grain. For instance, we have the corn belt, the wheat belt, also local centres, where buckwheat is raised, which also is an excellent pigeon feed, second only to wheat. Other localities produce barley, another grain that is a good feed for pigeons, so considered by the English. Millet is another wholesome grain. Keep this one great fact before you at all times, to feed a variety of grains; by doing this you will avoid diseases of all kinds, and your birds will be in the pink of condition at all seasons of the year. In feeding whole corn, do not mix it with your finer grains. In feeding corn to our birds we scatter it on the floor or ground. The feed boxes are all the time supplied with the finer grains. After the birds eat all they wish of the whole corn, they adjourn to the feed boxes for their desert. Allow them to choose their own diet, and their health, happiness, and your prosperity will be with you. Some of our readers will say, "The Doctor says nothing about oats." As a muscle-making food, and to build frame, there is nothing like oats, but in using oats we prefer them hulled. In that way we feed them all the time, especially when we are raising young for breeders. But for market squabs, we eliminate it from the bill of fare, as oats are not a fat producer.

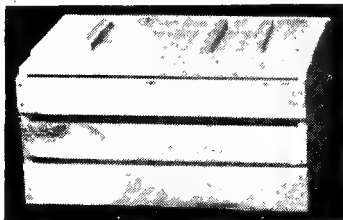

SHIPPING CRATES.

This photograph shows our smallest-sized

shipping crate, capable of accommodating from four to sixteen birds. The tag is shown in position on top of the crate, protected by three short pieces of wood. Twelve birds in this light and strong crate weigh about fifteen pounds. When shipping a large number of birds, we use two or three or more crates, each crate being as large as can be handled by one expressman. The express charges are the same, no matter whether one big crate or two or three small ones are used, provided the total weight is the same. Usually they are less when several small crates are used, because the lumber in them is lighter than in one big crate, and there is a decided advantage in ease of handling.

#### THE SELF-FEEDER.

Everybody has asked for more details about the self-feeder, and we give here three views with dimensions.

The first is a plan (looking down from the top.)

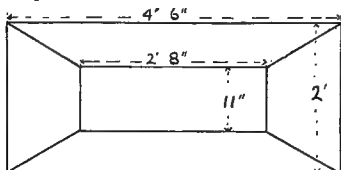

The second is the elevation, or side view.

The third is a cross section. The birds usually hop onto the drop shelf, then onto the base board (as shown). As fast as they eat, the grain in the hopper drops down. Look again at the elevation and you will see that the sides are cut away, leaving supports at the middle and ends.

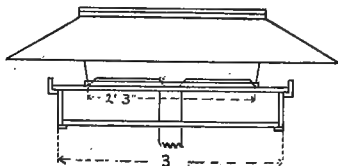

Note this fact particularly, that the wedge-shaped ends of the hopper are removable (sliding up) so that when you choose you may clean out the whole interior of the hopper easily with a broom.

The self-feeder is built almost wholly of one-inch pine, with the exception of the lighter stuff, which may be of half-inch. The

top, or cover, is covered with tarred paper and is on hinges. The post should be of a height to permit of your filling the hopper

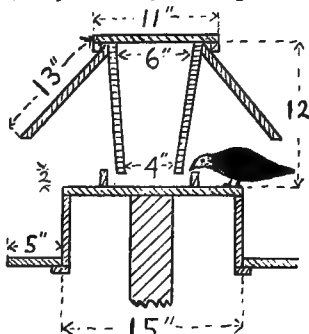

from a pail or scoop without straining your arms.

#### SEAMLESS BAND.

A few beginners are puzzled by the seamless band and its use, so we have had this sketch prepared to make the idea plain. The band with date of hatch stamped on it is shown in the lower right-hand corner and the arrow points to a band on the right leg of a pigeon, showing how it looks when in place. The band is made of aluminum and as the

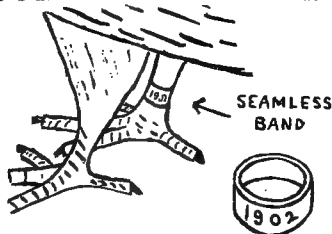

squab's leg grows it fills the ring, and the band cannot be taken off without sawing or filing, nor can another band be put on. On the band, in addition to the year of hatch, the breeder may stamp a designating number, or anything he chooses.

#### SQUAB HOUSE DETAILS.

On Page 16 we print a plan and side view of squab house and flying pen. In order to give a clearer idea of the timbers, we print a

more detailed side view here.

A B C is one timber, E C H another and E B a third. B D is made of wire, to prevent the birds from flying from the squab house to the top of the passageway. K shows the lattice work underneath the nest boxes through which the pigeons thrust their bills and heads to feed from the trough F. You fill the trough with grain by hand from the passageway. This is useful in stormy or bitter cold weather when it is desirable not to let the birds out into the flying pen, where the self-feeder is located. The line C D is shown full to represent the bracing posts, but you should remember to leave this top part of the squab house mostly open, for better ventilation.

In building our new squab houses, we have deviated a trifle from the dimensions given on

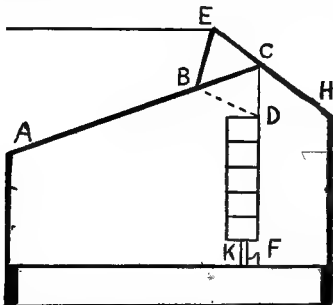

Page 16. The perpendicular distance from E to the floor of the squab house we are making eleven feet. From A to C, thirteen feet. From C to floor of squab house, nine feet. From H to floor of squab house six feet. From A to H (total depth of squab house) 16 feet. Width of unit squab house (large enough to house 50 to 75 pairs of birds), twelve feet. Length of flying pen from top of ridge pole of squab house to south extremity, thirty feet. Length of flying pen from end of squab house to south extremity, twenty feet. Height of flying pen from ground, nine to twelve feet.

#### TO SUM UP.

There are but four points essential to success in pigeon raising: First, variety and plenty of food. Second, fresh, clean water. Third, clean houses. Fourth, GOOD STOCK, as obtained from the PLYMOUTH ROCK SQUAB CO.

#### QUESTIONS ANSWERED.

Ques. How do you yourself pack squabs for market, in baskets or boxes? Ans. We pack in boxes with hinged cover because the distance from Pembroke to the Boston market is short. For a day's journey, use nailed cover boxes.

Ques. Do you pack in one layer, or more? Ans. We pack them in layer upon layer, close, in an orderly manner. Don't throw them in every way.

Ques. Is there any discoloration of the meat upon contact, after the squab is cooled? Ans. No; in hot weather the squabs should not be killed until the night before shipping, and when cooling from the studding should be hung in a draft. There will be no discoloration when shipping squabs cooled properly in this manner.

Ques. Is it safe to hang killed squabs from studding in the summer time to cool? Ans. Use a cellar, or the coolest room on the premises.

Ques. Of each pair of squabs hatched, is one invariably a male and the other a female? Ans. Not invariably, but as a rule.

Ques. When raised all in one pen, are not the brother and sister likely to pair, being best acquainted by association in the nest? Ans. No, it is not Nature's way. Each will look for a new acquaintance.

Ques. If pairs only of birds when old enough to take to the wing were put in an apartment until there were a large number of such pairs, would it insure freedom from unmated and unproductive birds and the useless cost of feeding such birds? If so this would be easier than mating them in coops or hutches. To the inexperienced it would be safer than to trust to one's ability to determine the sex of birds by examination. Ans. It is very hard to tell the sex of young birds by manipulation because the female, having produced no eggs, has not widened in position of posterior bones. As we state in the Manual, one way to tell the sex of pigeons is by observation of their behavior, and this is the way which must be used in the case of young birds. You cannot tell either male or female organs in the living birds. We have killed and dissected them and found them. The breeder must train his faculties of observation keenly and then he can tell the birds apart and seldom make an error. (But we have seen breeders who thought they were good judges fooled.) It takes a keen, sharp eye.

Ques. Would it not be well to have the nest-boxes larger, so the birds can have a place to alight? Ans. No; the bird shou'1

not have any space to loaf on, but should be on top of the nest as soon as it strikes into the nest-box. The nest should be its only place to sit.

Ques. Please give details as to shingling squab house. Ans. To get a warm house, one of our correspondents has suggested the use of rosin-sized building paper "under the shingles. We approve this suggestion. Use common and not wire shingle nails, which rust out quickly. As to the roosts, this correspondent makes the following suggestion: Use inch boards five and six inches wide, cut eight inches long. Nail the side of the six-inch piece onto the side of the five-inch piece like the letter V inverted and toenail the end to the wall where wanted.

Ques. In tacking on the two-inch strips to the front of each pair of nests, do you mean both the horizontal and perpendicular divisions? Ans. No, only the perpendicular.

Ques. Why not use a wire across the front to keep nappies from falling out? Ans. Not necessary; would hinder cleaning. A nappy is seldom pushed out.

Ques. How many squabs are packed in a basket or box when shipping to market? Ans. As many as will make a package easily handled by one expressman. A box 2 ft. x 2 ft. x 18 inches is big enough.

Ques. Will a male mate with two females at the same time? Ans. No. There may be exceptions, but we have not observed any.

Ques. On Page 23 you say: "When squabs are two weeks old . . . the nest with occupants are transferred," etc., and a few lines further you say: "You get rid of the dirty nest," etc. Do you intend to say that the old nest is entirely thrown away, or only the dung in nappy outside of nest? Ans. Throw the old nest away and in the new, clean nappy place a handful of nesting material (straw and grass). Then place the pair of live squabs on top of this new nest.

Ques. Instead of shingling the squab house, would it not do to make the sides and ends of good flooring, put on right, that would be air-tight? Ans. Yes; we prefer shingles because neater.

Ques. I believe I will build a wire netting fence eight feet high and leave the top of the flying pen open. Ans. You must keep the birds wired in completely, otherwise they will fly back to us. Birds which you hatch and raise you may allow to fly loose. Not knowing of any home but yours, they will not leave you.

Ques. In the case of a long squab house with different flocks, would not one large flying pen answer? Ans. Yes, but the birds

would not be under your control so well. You can keep watch of them better.

Ques. When you pluck, do you draw the entrails out of the bird? Ans. No.

Ques. Please describe killing the squab more fully. Ans. We can, but it will not make it clearer. Wait until your first lot of squabs is ready to be tweaked, then we warrant you will teach yourself by actual practice in five minutes. If you avoid the wrong way of holding your hands, as illustrated, there is only one other way of holding, and that is the right way, as told.

Ques. Are the flying (carrier) Homers the same breed of stock as your squab raisers? Ans. Yes; a carrier is a Homer that has been trained.

Ques. Do the nest-boxes face the door? Ans. No; they face the south wall of the squab house.

Ques. Is it necessary to completely cover the yard of the flying pen with grit? Ans. No; one correspondent writes on this point: "For grit we give oyster shells and sometimes pound up glass for them."

Ques. Is Kaffir corn considered corn; and if so, should it be mixed half and half with cracked corn; the two forming the mixture considered the one-part corn, to two of wheat; for summer feed, as given in Manual, page 33? Ans. No; we call Kaffir corn a "dainty." By "mixture," we mean wheat and cracked corn. That is the staple, the others are dainties.

Ques. Are the mating coops mere bird cages, or as large as a flying pen? Ans. They are small, but not so small as the ordinary canary cage. A good size is 4 ft. x 2 ft. x 2 ft., with removable wire partition in the middle, giving each bird a space 2 ft. x 2 ft. x 2 ft.

Ques. I would like to buy half a dozen pairs of Homers. Provided I kept them in the house and flying pen until May 1, do you think they would leave if left out in the open after that date? Ans. Yes; you must keep them wired in all the time, or back they will come to us.

Ques. On page 51, a sentence at the top of the page says, "In the case of young birds, the first mating does not amount to much, the eggs being undersized and the squabs lacking in vitality." Now is it best to let the birds hatch the first eggs, or would it not be best to destroy the first eggs, and let the birds mate again, or is it best to let them hatch and learn to feed their young? Ans. It is best to let them hatch and learn to feed their young.

Ques. Does each pair of birds have two



nest-boxes? Ans. Yes.

Ques. In changing the nappies from large to small, is the smaller nappy placed in the empty nest-box, or is it placed in the same nest-box? Ans. In the same nest-box.

Ques. (1) Judging from the illustration on Page 24 of your Manual, I should say that the backs of the nest-boxes are made of five-inch strips, and that the strip covering the

upper portion of the pair of boxes is hinged to the strip covering the lower half. Is this correct? (2) It seems to me that in this case the nest-boxes could not be conveniently cleaned from the rear. Ans. (1) Yes. (2) The nest-boxes are not cleaned from the rear (or passageway) but from the front (interior of squab house).





