



~~A~~
~~M 89~~
~~2~~

QR
41
M95
1903

CORNELL UNIVERSITY.

THE

Roswell P. Flower Library

THE GIFT OF

ROSWELL P. FLOWER

FOR THE USE OF

THE N. Y. STATE VETERINARY COLLEGE

1897

8394-I



Cornell University Library
QR 41.M95 1903

Manual of bacteriology,



3 1924 000 225 965

vet

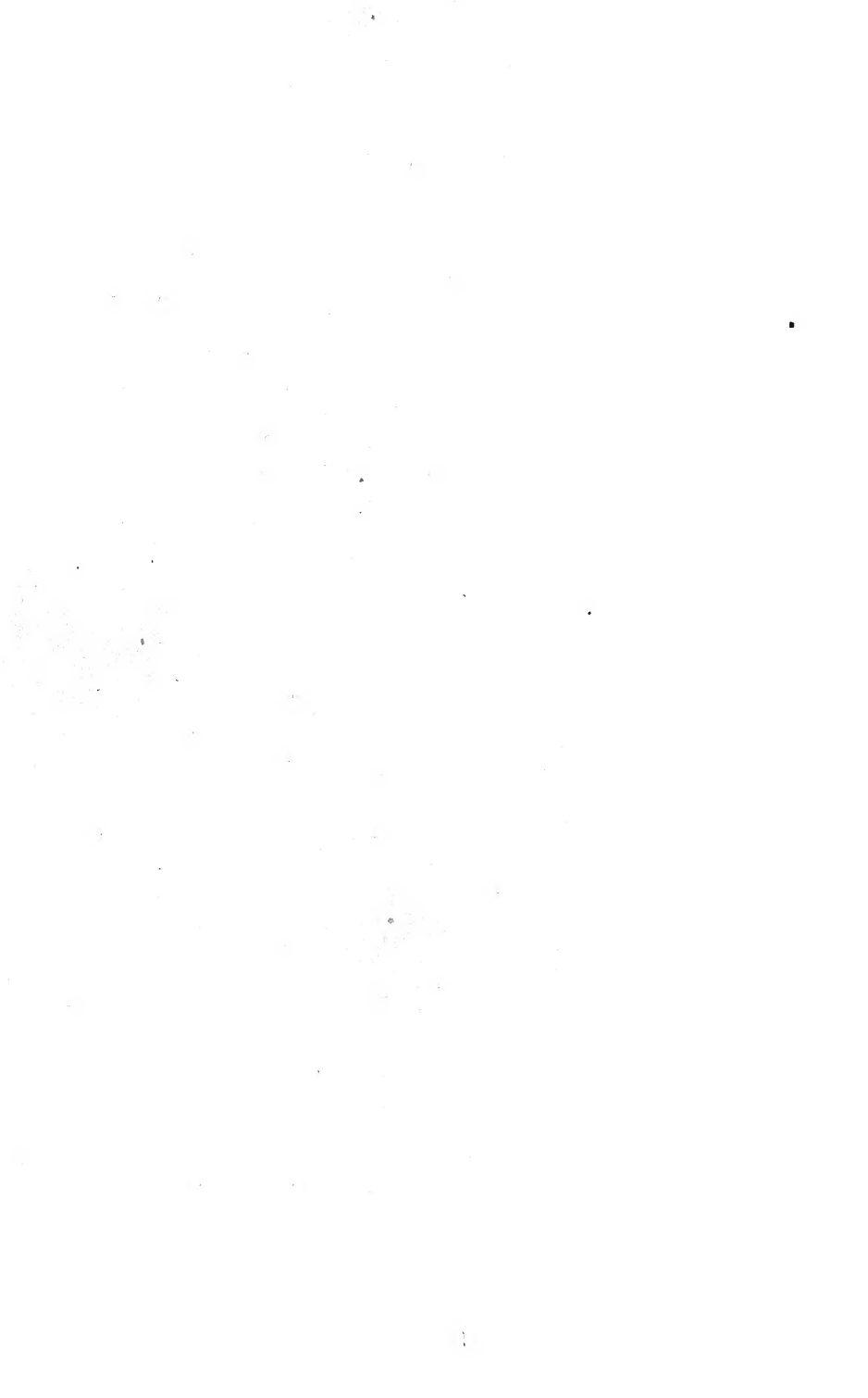



Cornell University Library

The original of this book is in
the Cornell University Library.

There are no known copyright restrictions in
the United States on the use of the text.

MANUAL OF BACTERIOLOGY

•The  Co. •

MANUAL

OF

BACTERIOLOGY

BY

ROBERT MUIR; M.A., M.D., F.R.C.P.Ed.

PROFESSOR OF PATHOLOGY, UNIVERSITY OF GLASGOW,

AND

JAMES RITCHIE, M.A., M.D., B.Sc.

READER IN PATHOLOGY, UNIVERSITY OF OXFORD.

AMERICAN EDITION (WITH ADDITIONS),

REVISED AND EDITED FROM THE THIRD ENGLISH EDITION

BY

NORMAN MAC LEOD HARRIS, M.B. (TOR.)

ASSOCIATE IN BACTERIOLOGY, THE JOHNS HOPKINS UNIVERSITY, BALTIMORE.

WITH ONE HUNDRED & SEVENTY ILLUSTRATIONS.



New York:

THE MACMILLAN COMPANY.

LONDON: MACMILLAN & CO., LTD.

1903

^T
All rights reserved.

2812/03

GR
41
M 95
1903

~~I A. 89 (2)~~
No. 2008

COPYRIGHT, 1903,
BY THE MACMILLAN COMPANY.

Set up and electrotyped February, 1903.

Norwood Press
J. S. Cushing & Co. — Berwick & Smith
Norwood, Mass., U.S.A.

PREFACE TO THE AMERICAN EDITION.

IN presenting this the American edition of the well-known and appreciated work of Doctors Muir and Ritchie, the endeavour has been made to add to the value of the book by giving adequate expression to the best in American laboratory methods and research, and, at the same time, to augment the general scope of the work without eliminating the personal impress of the authors. Therefore occasional alterations and additions of greater or lesser magnitude have been made throughout the book in general, but more especially in Chapters II, III, IV, XV, and XVII; whilst the chapter on Fungi, deleted from the last English edition, has been retained and enlarged. The section of the Manual dealing with the bibliography has also been extended to cover as far as possible the advances in work made in this country and abroad.

Some photographic reproductions and a few engravings of apparatus have been added to those of the English edition, for which hearty thanks is due Doctors A. C. Abbott, T. C. Gilchrist, and Charles Potter, and Messrs. Charles Lentz & Sons, and W. B. Saunders & Co. for their kindness in furnishing the same.

The Editor takes this opportunity of expressing his indebtedness to Professor William H. Welch for many helpful suggestions in the preparation of the edition.

N. MAC L. H.

THE JOHNS HOPKINS UNIVERSITY,
BALTIMORE, MARYLAND,
November, 1902.

PREFACE TO THE THIRD EDITION.

IN this edition the whole subject has been carefully revised, and, as formerly, we have aimed at making the bearings of bacterial action on general pathological processes an outstanding feature.

The advances in bacteriology during the last three years have been neither few nor of small importance, and to incorporate these and at the same time maintain the work as a convenient hand-book for the student, has been no easy task. In endeavouring to accomplish it, we have condensed various portions and omitted others which appear now to be of subsidiary importance. Thus, although much new matter has been introduced, the former length of the volume has been but slightly increased. Additions have been made to most of the chapters and several new subjects are treated of, amongst which may be mentioned the bacteriology of the air, soil, and water, to which a new chapter has been devoted. The chapter on Immunity has been modified and extended so as to include the recent important researches on the subject. A number of new illustrations will be found to have been added, and we trust that these will tend towards the elucidation of the text.

One result of later research in bacteriology has been to bring into prominence the fact that, in nearly every instance, each so-called pathogenic organism is a member of a group of bacteria possessing closely allied characters. Hard and fast lines as to distinguishing features can now be less definitely drawn, and accordingly an intelligent conception on the part of the student is more than ever necessary. We have therefore in many instances merely stated the known facts, when we have considered that these do not justify an advance being made to a definite conclusion.

JANUARY, 1903.

PREFACE TO SECOND EDITION.

IN preparing this edition we have made no change in the original plan of the book. The text, however, has been carefully revised, and the results of the more recent researches have been incorporated. Some parts have been condensed, but, in consequence of the introduction of new subject-matter and of additional illustrations, the size of the book as a whole has been considerably increased. We trust that these alterations will be found to be in the direction of improvement.

MAY, 1899.

PREFACE TO THE FIRST EDITION.

THE science of Bacteriology has, within recent years, become so extensive, that in treating the subject in a book of this size we are necessarily restricted to some special departments, unless the description is to be of a superficial character. Accordingly, as this work is intended primarily for students and practitioners of medicine, only those bacteria which are associated with disease in the human subject have been considered. We have made it a chief endeavour to render the work of practical utility for beginners, and, in the account of the more important methods, have given elementary details which our experience in the practical teaching of the subject has shown to be necessary.

In the systematic description of the various bacteria, an attempt has been made to bring into prominence the evidence of their having an etiological relationship to the corresponding diseases, to point out the general laws governing their action as producers of disease, and to consider the effects in particular instances of various modifying circumstances. Much research on certain subjects is so recent that conclusions on many points must necessarily be of a tentative character. We have, therefore, in our statement of results aimed at drawing a distinction between what is proved and what is only probable.

In an Appendix we have treated of four diseases; in two of these the causal organism is not a bacterium, whilst in the other two its nature is not yet determined. These diseases have been included on account of their own importance and that of the pathological processes which they illustrate.

Our best thanks are due to Professor Greenfield for his kind advice in connection with certain parts of the work. We have also great pleasure in acknowledging our indebtedness to Dr. Patrick Manson, who kindly lent us the negatives or preparations from which Figs. 143-148 have been executed.

As we are convinced that to any one engaged in practical study, photographs and photomicrographs supply the most useful and exact information, we have used these almost exclusively in illustration of the systematic description. These have been executed in the Pathological Laboratory of the University of Edinburgh by Mr. Richard Muir. The line drawings were prepared for us by Mr. Alfred Robinson, of the University Museum, Oxford.

To the volume is appended a short Bibliography, which, while having no pretension to completeness, will, we hope, be of use in putting those who desire further information on the track of the principal papers which have been published on each of the subjects considered.

JUNE, 1897.

CONTENTS.

CHAPTER I.

GENERAL MORPHOLOGY AND BIOLOGY.

	PAGE
Introductory — Terminology — Structure of the bacterial cell — Reproduction of bacteria — Spore formation — Motility — Minuter structure of bacterial protoplasm — Chemical composition of bacteria — Classification — Food supply — Relation of bacteria to moisture, gaseous environment, temperature, and light — Conditions affecting bacterial motility — Effects of bacteria in nature — Methods of bacterial action — Variability among bacteria	1

CHAPTER II.

METHODS OF CULTIVATION OF BACTERIA.

Introductory — Methods of sterilisation — The preparation of culture media — The use of the culture media — The methods of the separation of aerobic organisms — The principles of the culture of anaerobic organisms — Miscellaneous methods — General laboratory rules	27
--	----

CHAPTER III.

MICROSCOPIC METHODS—GENERAL BACTERIOLOGICAL DIAGNOSIS — INOCULATION OF ANIMALS.

The microscope — Examination of hanging-drop cultures — Film preparations — Examination of bacteria in tissues — The cutting of sections — Staining principles — Mordants and decolorisers — Formulæ of stains — Gram's method and its modifications — Stain for tubercle and leprosy bacilli — Staining of spores and flagella — Observation of agglutination and sedimentation — Routine bacteriological examination — Methods of inoculation — Autopsies on animals	87
--	----

CHAPTER IV.

BACTERIA IN AIR, SOIL, AND WATER. ANTISEPTICS.

AIR: Methods of examination — Results. SOIL: Methods of examination — Varieties of bacteria in soil. WATER: Methods of examination — Bacteria in water — Bacterial treatment of sewage. ANTISEPTICS: Methods of investigation — The action of antiseptics — Certain particular antiseptics	123
--	-----

CHAPTER V.

FUNGI: NON-PATHOGENIC AND PATHOGENIC.

	PAGE
Mucorinæ — Ascomycetæ — Perisporiaceæ — Yeasts and torulæ — Blastomycetic dermatitis — Morphology — Cultural characters	148

CHAPTER VI.

RELATIONS OF BACTERIA TO DISEASE — THE PRODUCTION OF TOXINS BY BACTERIA.

Introductory — Conditions modifying pathogenicity — Modes of bacterial action — Tissue changes produced by bacteria — Local lesions — General lesions — Disturbance of metabolism by bacterial action — The production of toxins by bacteria, and the nature of these — Allied vegetable and animal poisons — The theory of toxic action	157
--	-----

CHAPTER VII.

INFLAMMATORY AND SUPPURATIVE CONDITIONS.

The relations of inflammation and suppuration — The bacteria of inflammation and suppuration — Results of experimental inoculation — Lesions in the human subject — Mode of entrance and spread of pyogenic bacteria — Ulcerative endocarditis — Acute suppurative periostitis — Erysipelas — Meningitis — Conjunctivitis — Acute rheumatism — Methods of examination in inflammatory and suppurative conditions	180
--	-----

CHAPTER VIII.

INFLAMMATORY AND SUPPURATIVE CONDITIONS, *CONTINUED*:
THE ACUTE PNEUMONIAS.

Introductory — Historical — Bacteria in pneumonia — Fraenkel's Pneumococcus — Friedländer's pneumobacillus — Distribution of pneumobacteria — Experimental inoculation — Etiological relations to pneumonia — The toxins of the pneumococcus — Immunisation against pneumococcus — Methods of examination	205
---	-----

CHAPTER IX.

GONORRHŒA, SOFT SORE, SYPHILIS.

The gonococcus — Microscopical characters — Cultivation — Relations to disease — Its toxin — Distribution — Gonococcus in joint affections — Methods of diagnosis — Soft sore — Syphilis	223
--	-----

CHAPTER X.

TUBERCULOSIS.

Historical — Tuberculosis in animals — The tubercle bacillus — Staining reactions — Cultivation of tubercle bacillus — Powers of resistance — Action on the tissues — Histology of tuberculous nodules — Distribution of bacilli	
--	--

	PAGE
— Bacilli in tuberculous discharges — Experimental inoculation — Varieties of tuberculosis — Other acid-fast bacilli — Action of dead tubercle bacilli — Sources of human tuberculosis — Koch's tuberculin — Toxins of the tubercle bacillus — Koch's new tuberculin — Immunisation against tubercle — Methods of examination	236

CHAPTER XI.

LEPROSY.

Pathological changes — Bacillus of leprosy — Distribution in lesions — Relations to disease — Methods of diagnosis	267
--	-----

CHAPTER XII.

GLANDERS AND RHINOSCLEROMA.

The natural disease — The bacillus of glanders — Cultivation of glanders bacillus — Powers of resistance — Experimental inoculation — Action on the tissues — Mode of spread — Mallein and its preparation — Methods of examination — Rhinoscleroma	275
---	-----

CHAPTER XIII.

ACTINOMYCOSIS AND ALLIED DISEASES.

Characters of the actinomyces — Tissue lesions — Distribution of lesions — Cultivation of actinomyces — Varieties of actinomyces and allied forms — Experimental inoculation — Methods of examination and diagnosis — Madura disease	287
--	-----

CHAPTER XIV.

ANTHRAX.

Historical summary — Bacillus anthracis — Appearances of cultures — Biology — Sporulation — Natural anthrax in animals — Experimental anthrax — Anthrax in man — Pathology — Toxins of the bacillus anthracis — Mode of spread in nature — Immunisation against anthrax — Methods of examination	300
--	-----

CHAPTER XV.

TYPHOID FEVER — BACILLI ALLIED TO THE TYPHOID BACILLUS.

Historical summary — The bacillus typhosus — Morphological characters — Characters of cultures — Bacillus coli communis — Reactions of B. typhosus and B. coli — Bacillus enteritidis (Gaertner) — Paracolon bacillus — Psittacosis bacillus — Pathological changes in typhoid fever — Suppuration in typhoid fever — Pathogenic effects produced in animals — The toxic products of B. typhosus — Immunisation of animals — Relations of bacilli to the disease — Serum diagnosis — Vaccination against typhoid — Methods of examination — Bacillary dysentery — Bacillus enteritidis sporogenes	319
---	-----

CHAPTER XVI.

DIPHTHERIA.

PAGE

Historical — General facts — Bacillus diphtheriæ — Microscopical characters — Distribution — Cultivation — Inoculation experiments — The toxins of diphtheria — Variations in virulence of bacilli — Summary of pathogenic action — Methods of diagnosis	356
---	-----

CHAPTER XVII.

TETANUS.

Introductory — Historical — Bacillus tetani — Isolation of tetanus bacillus — Characters of cultures — Conditions of growth — Pathogenic effects — Experimental inoculation — Tetanus toxins — Antitetanic serum — Methods of examination — Malignant œdema — Characters of bacillus — Methods of diagnosis — Bacillus botulinus — Quarter-evil — Bacillus aerogenes capsulatus — Cultural characters	376
--	-----

CHAPTER XVIII.

CHOLERA.

Introductory — The cholera spirillum — Distribution of the spirilla — Cultivation — Powers of resistance — Experimental inoculation — Toxins of cholera spirillum — Inoculation of human subject — Immunity — Modes of dis- tinguishing the spirillum — General summary — Spirilla resembling the cholera organism — Methods of diagnosis — Metchnikoff's spirillum — Finkler and Prior's spirillum — Deneke's spirillum	407
---	-----

CHAPTER XIX.

INFLUENZA, PLAGUE, RELAPSING FEVER, MALTA FEVER,
YELLOW FEVER.

Influenza bacillus — Microscopical characters — Cultivation — Distribution — Experimental inoculation — Methods of examination — Bacillus of plague — Microscopical characters — Cultivation — Anatomical changes produced and distribution of bacilli — Experimental inoculation — Paths and mode of infection — Immunity — Relapsing fever — Characters of the spirillum — Relations to the disease — Malta fever — Micrococcus melitensis — Relations to the disease — Methods of diagnosis — Yellow fever — Bacteria in yellow fever — The mosquito theory of infection	430
--	-----

CHAPTER XX.

IMMUNITY.

Introductory — Acquired immunity — Artificial immunity — Varieties — Active immunity — Methods of production — Attenuation and exaltation of viru- lence — Passive immunity — Action of the serum — Antitoxic serum — Standardising of toxins and of anti-sera — Nature of antitoxic action —
--

	PAGE
Ehrlich's theory of the constitution of toxins — Antibacterial serum — Lysogenic actions — Hæmolytic sera — Agglutination — Pfeiffer's phenomenon — Therapeutic effects of anti-sera — Theories as to acquired immunity — Ehrlich's side-chain theory — The theory of phagocytosis — Natural immunity — Natural bactericidal powers, — Natural susceptibility to toxins	460

APPENDIX A.

SMALLPOX AND VACCINATION.

Jennerian vaccination — Relationship of smallpox and cowpox — Bacteria in smallpox — Protozoa as causative agents — The nature of vaccination	501
---	-----

APPENDIX B.

HYDROPHOBIA.

Introductory — Pathology — The hydrophobic virus — Prophylaxis — Antirabic serum — Methods	508
--	-----

APPENDIX C.

MALARIAL FEVER.

Characters of the malarial parasite — Varieties of the malarial parasite — The cycle of the malarial parasite in man — The cycle in the mosquito — Methods of examination	516
---	-----

APPENDIX D.

AMŒBIC DYSENTERY.

Amœbic dysentery — Characters of the amœba — Distribution of the amœba — Relations to disease — Methods of examination	529
--	-----

BIBLIOGRAPHY	534
------------------------	-----

INDEX	553
-----------------	-----

LIST OF ILLUSTRATIONS.

FIG.	PAGE
1. Forms of bacteria	13
2. Hot-air steriliser	29
3. Koch's steam-steriliser	30
4. Arnold steam-steriliser	30
5. Autoclave	31
6. Steriliser for blood serum	32
7. Meat press	34
8. Wire funnel for supporting paper filter	39
9. Hot-water funnel	40
10. Blood serum inspissator	44
11. Potato jar	46
12. Cylinder of potato cut obliquely	47
13. Ehrlich's tube containing piece of potato	47
14. Apparatus for filling tubes	50
15. Tubes of media	50
16. Platinum wires in glass handles	51
17. Method of inoculating solid tubes	52
18. Rack for platinum needles	53
19. Petri's capsule	53
20. Koch's levelling apparatus for use in preparing plates	55
21. Koch's levelling apparatus, showing transference of plate	56
22. Esmarch's tube for roll-culture	56
23. Apparatus for supplying hydrogen for anaerobic cultures	59
24. Esmarch's roll-tube adapted for culture containing anaerobes	60
25. Novy's anaerobic jar	61
26. Bulloch's apparatus for anaerobic plate-cultures	61
27. Flask for anaerobes in liquid media	63
28. Flask arranged for culture of anaerobes which develop gas	64
29. Wright's method for cultivation of anaerobes in solid media	65
30, 31. Wright's method for cultivation of anaerobes in fluid media	65
32. Tubes for anaerobic cultures on the surface of solid media	66
33. Harris' method of making collodion sacs	67
34. Slide for hanging-drop cultures	68
35. Graham Brown's chamber for anaerobic hanging-drops	69
36. Sternberg's bulb adapted for thermal death-point test	71
37. Apparatus for counting colonies	72
38. Geissler's vacuum-pump for filtering cultures	75
39. Chamberland's candle and flask arranged for filtration	76
40. Chamberland's bougie, with lamp funnel	76
41. Bougie inserted through rubber stopper	76

FIG.	PAGE
42. Muencke's modification of Chamberland's filter	77
43. Flask for filtering large quantities of fluid	77
44. Tubes for demonstrating gas-formation by bacteria	79
45. Hill's modification of Smith's fermentation tube	80
46. Geryk's air-pump for drying <i>in vacuo</i>	81
47. Reichert's gas regulator	83
48. Hearson's incubator for use at 37° C.	84
49. Cornet's forceps for holding cover-glasses	89
50. Stewart's cover-glass forceps	89
51. Needle for manipulating paraffin sections	94
52. Syphon wash-bottle	98
53. Tubes used in testing agglutinating and sedimenting properties of serum	111
54. Test-tube and pipette for obtaining fluids containing bacteria	113
55. Apparatus for holding mouse preparatory to subcutaneous inoculation	118
56. Hollow needle for intraperitoneal inoculations	119
57. Hesse's tube	124
58. Petri's sand filter	125
59. Sedgwick-Tucker aerobioscope	125
60. Apparatus for collecting water samples	133
61. Forms of fungi	150
62. Blastomyces dermatitidis, showing organism with doubly-contoured membrane. × 1000	153
63. Blastomyces dermatitidis, showing budding form of organism. × 1000	153
64. Blastomyces dermatitidis, sporulating form in abscess cavity	154
65. Staphylococcus pyogenes aureus, young culture on agar. × 1000	183
66. Two stab-cultures of staphylococcus pyogenes aureus in gelatin	183
67. Streptococcus pyogenes, young culture on agar. × 1000	185
68. Culture of the streptococcus pyogenes on an agar plate	185
69. Bacillus pyocyaneus, young culture on agar. × 1000	186
70. Micrococcus tetragenus. × 1000	187
71. Film preparation of exudation from case of meningitis, showing the diplococci within leucocytes	188
72. Streptococci in acute suppuration. × 1000	193
73. Minute focus of commencing suppuration in brain. × 50	195
74. Secondary infection of a glomerulus of kidney by the staphylococcus aureus. × 300	196
75. Section of a vegetation in ulcerative endocarditis	198
76. Film preparation of conjunctival secretion. × 1000	201
77. Film preparation of pneumonic sputum. × 1000	208
78. Friedländer's pneumobacillus, from exudate in a case of pneumonia. × 1000	209
79. Fraenkel's pneumococcus in serous exudation. × 1000	209
80. Stroke-culture of Fraenkel's pneumococcus on blood agar	210
81. Fraenkel's pneumococcus from a pure culture on blood agar of twenty-four hours' growth. × 1000	211
82. Stab-culture of Friedländer's pneumobacillus	212
83. Friedländer's pneumobacillus from a young culture on agar. × 1000	212
84. Capsulated pneumococci in blood taken from the heart of a rabbit. × 1000	215

FIG.	PAGE
85. Portion of film of gonorrhoeal pus. × 1000	224
86. Gonococci, from a pure culture on blood agar. × 1000	225
87. Tubercle bacilli, from a pure culture on glycerin agar. × 1000	239
88. Tubercle bacilli in phthisical sputum. × 1000	239
89. Cultures of tubercle bacilli on glycerin agar	242
90. Tubercle bacilli in section of human lung in acute phthisis. × 1000	247
91. Tubercle bacilli in giant-cells. × 1000	248
92. Tubercle bacilli in urine. × 1000	248
93. Moeller's Timothy-grass bacillus. × 1000	255
94. Cultures of acid-fast bacilli grown at room temperature	256
95. Smegma bacilli. × 1000	256
96. Section through leprous skin, showing the masses of cellular granulation tissue in the cutis. × 80	268
97. Superficial part of leprous skin; the cells of the granulation tissue appear as dark patches. × 500	270
98. High-power view of portion of leprous nodule. × 1100	271
99. Glanders bacilli amongst broken-down cells. × 1000	277
100. Glanders bacilli, from a pure culture. × 1000	278
101. Actinomycosis of human liver. × 500	289
102. Actinomyces in human kidney. × 500	290
103. Colonies of actinomyces. × 60	291
104. Cultures of the actinomyces on glycerin agar	294
105. Actinomyces, from a culture on glycerin agar. × 1000	294
106. Streptothrix maduræ. × 1000	298
107. Surface colony of the anthrax bacillus. × 30	302
108. Anthrax bacilli, arranged in chains. × 1000	302
109. Stab-culture of the anthrax bacillus	303
110. Anthrax bacilli containing spores. × 1000	305
111. Scraping from spleen of guinea-pig dead of anthrax. × 1000	307
112. Portion of kidney of a guinea-pig dead of anthrax. × 300	309
113. Specially large clump of typhoid bacilli in a spleen. × 500	320
114. Typhoid bacilli. × 1000	321
115. Typhoid bacilli from a young culture on agar. × 1000	322
116. Stab and stroke cultures of typhoid bacillus and bacillus coli	323
117. Colonies of typhoid bacillus. × 15	323
118. Bacillus coli communis. × 1000	325
118 A. Bacillus dysentericæ, from an agar culture 48 hours old. × 1000	350
119. Film preparation from diphtheria membrane. × 1000	358
120. Section through a diphtheritic membrane, showing diphtheria bacilli in clumps. × 1000	359
121. Cultures of the diphtheria bacillus on an agar plate	361
122. Diphtheria bacilli, from a twenty-four hours' culture on agar. × 1000	362
123. Diphtheria bacilli of larger size than in previous figure. × 1000	362
124. Involution forms of the diphtheria bacillus. × 1000	362
125. Pseudo-diphtheria bacillus (Hofmann's). Young agar culture. × 1000	371
126. Film preparation of discharge from wound in a case of tetanus. × 1000	377
127. Tetanus bacilli, showing flagella. × 1000	378
128. Spiral composed of numerous twisted flagella of the tetanus bacillus. × 1000	378

FIG.	PAGE.
129. Tetanus bacilli, some of which possess spores. × 1000	379
130. Bipolar spore formation in glucose agar culture of <i>B. tetani</i> . × 1000	379
131. Stab-culture of the tetanus bacillus (Kitasato)	381
132. Film preparation in a case of malignant œdema in human subject. × 1000	394
133. Bacillus of malignant œdema. × 1000	395
134. Stab-cultures in agar	396
135. Bacillus of quarter-evil, showing spores. × 1000	401
136. Bacillus aerogenes capsulatus	403
137. <i>B. aerogenes capsulatus</i> , showing coagulation of casein	405
138. Cholera spirilla. × 1000	409
139. Cholera spirilla stained to show the terminal flagella. × 1000	409
140. Cholera spirilla from an old agar culture. × 1000	409
141. Puncture culture of the cholera spirillum	411
142. Colonies of the cholera spirillum in a gelatin plate	412
143. Metchnikoff's spirillum. × 1000	427
144. Puncture cultures in peptone gelatin	428
145. Finkler and Prior's spirillum from an agar culture. × 1000	429
146. Influenza bacilli from a culture on blood agar. × 1000	430
147. Film preparation from a plague bubo, showing enormous numbers of bacilli. × 1000	436
148. Bacillus of plague from a young culture on agar. × 1000	436
149. Bacillus of plague in chains. × 1000	437
150. Culture of the bacillus of plague on 4 per cent salt agar. × 1000	437
151. Section of a human lymphatic gland in plague. × 50	439
152. Film preparation of spleen of rat after inoculation with the bacillus of plague. × 1000	441
153. Spirilla of relapsing fever in human blood. × about 1000	448
154. <i>Micrococcus melitensis</i> , from a two days' culture on agar at 37° C. × 1000	453
155. Bacillus icteroides, from a young culture on agar (Sanarelli). × 1000	456
156. Culture of <i>Bacillus icteroides</i> on agar. Natural size	457
157-162. Various phases of the benign tertian parasite	518
163-168. Exemplifying phases of the malignant parasite	519
169. Amœbæ of dysentery	530
170. Section of wall of liver abscess, showing an amœba of spherical form with vacuolated protoplasm. × 1000	532

MANUAL OF BACTERIOLOGY

MANUAL OF BACTERIOLOGY.

CHAPTER I.

GENERAL MORPHOLOGY AND BIOLOGY.

Introductory. — At the bottom of the scale of living things there exists a group of organisms to which the name of bacteria is usually applied. These are apparently of very simple structure and may be subdivided into two sub-groups, a lower and simpler and a higher and better developed.

The *lower forms* are the more numerous, and consist of minute unicellular masses of protoplasm devoid of chlorophyll, which multiply by simple fission. Some are motile, others non-motile. Their minuteness may be judged of by the fact that in one direction at least they usually do not measure more than 1μ ($\frac{1}{25000}$ inch). These forms can be classified according to their shapes into three main groups — (1) A group in which the shape is globular. The members of this are called *cocci*. (2) A group in which the shape is that of a straight rod — the proportion of the length to the breadth of the rod varying greatly among the different members. These are called *bacilli*. (3) A group in which the shape is that of a curved or spiral rod. These are called *spirilla*. The full description of the characters of these groups will be more conveniently taken later (p. 12). In some cases, especially among the bacilli, there may occur under certain circumstances changes in the protoplasm whereby a resting stage or spore is formed.

The *higher forms* show advance on the lower along two lines. (1) On the one hand they consist of filaments made up of simple elements such as occur in the lower forms. These filaments may be more or less septate, may be provided with a sheath, and may show branching either true or false. The

minute structure of the elements comprising these filaments is analogous to that of the lower forms. Their size, however, is often somewhat greater. The lower forms sometimes occur in filaments, but here every member of the filament is independent, while in the higher forms there seems to be a certain interdependence among the individual elements. For instance, growth may occur only at one end of a filament, the other forming an attachment to some fixed object. (2) The higher forms, moreover, present this further development that in certain cases some of the elements may be set apart for the reproduction of new individuals.

Terminology. — The term bacterium of course in strictness only refers to the rod-shaped varieties of the group, but as it has given the name bacteriology to the science which deals with the whole group, it is convenient to apply it to all the members of the latter, and to reserve the term bacillus for the rod-shaped varieties. Other general words, such as germ, microbe, micro-organism, are often used as synonymous with bacterium, though, strictly, they include the smallest organisms of the animal kingdom.

While no living organisms lower than the bacteria are known (though the occurrence of such is now suspected), the upper limits of the group are difficult to define, and it is further impossible in the present state of our knowledge to give other than a provisional classification of the forms which all recognise to be bacteria. The division into lower and higher forms, however, is fairly well marked, and we shall therefore refer to the former as the lower bacteria, and to the latter as the higher bacteria.

Morphological Relations. — The relations of the bacteria to the animal kingdom on the one hand and to the vegetable on the other constitute a somewhat difficult question. It is best to think of there being a group of small, unicellular organisms, which may represent the most primitive forms of life before differentiation into animal and vegetable types had occurred. This would include the flagellata and infusoria, the myxomycetes, the lower algæ, and the bacteria. To the lower algæ the bacteria possess many similarities. These algæ are unicellular masses of protoplasm, having generally the same shapes as the bacteria, and largely multiply by fission. Endogenous sporulation, however, does not occur, nor is motility associated with the possession of flagella. Also their protoplasm differs from that of the bacteria in containing chlorophyll and another blue-green pigment called phycocyan. From the morphological resemblances, however, between these algæ and the bacteria, and from the fact that fission plays a predominant part in the multiplication

of both, they have been grouped together in one class as the Schizophyta or splitting plants (German, Spaltpflanzen). And of the two divisions forming these Schizophyta the splitting algæ are denominated the schizophyceæ (German, Spaltalgen), while the bacteria or splitting fungi are called the schizomycetes (German, Spaltpilzen). The bacteria are, therefore, often spoken of as the schizomycetes. Certain bacteria which have been described as containing chlorophyll ought probably to be grouped among the schizophyceæ.

GENERAL MORPHOLOGY OF THE BACTERIA.

The Structure of the Bacterial Cell.—On account of the minuteness of bacteria the investigation of their structure is attended with great difficulty. When examined under the microscope, in their natural condition, *e.g.* in water, they appear merely as colourless refractile bodies of the different shapes named. Spore formation and motility, when these exist, can also be observed, but little else can be made out. For their proper investigation advantage is always taken of the fact of their affinities for various dyes, especially those which are usually chosen as good stains for the nuclei of animal cells. Certain points have thus been determined. The bacterial cell consists of a sharply contoured mass of protoplasm which reacts to, especially basic, aniline dyes like the nucleus of an animal cell—though from this fact we cannot deduce that the two are identical in composition. A healthy bacterium when thus stained presents the appearance of a finely granular or almost homogeneus structure. The protoplasm is surrounded by an envelope which can in some cases be demonstrated by overstaining a specimen with a strong aniline dye, when it will appear as a halo round the bacterium. This envelope may sometimes be seen to be of considerable thickness. Its innermost layer is probably of a denser consistence, and sharply contours the contained protoplasm, giving the latter the appearance of being surrounded by a membrane. It is only, however, in some of the higher forms that a true membrane occurs. Sometimes the outer margin of the envelope is sharply defined, in which case the bacterium appears to have a distinct capsule, and is known as a capsulated bacterium (*vide* Fig. 1, No. 4; and Fig. 77). The cohesion of bacteria into masses depends largely on the character of the envelope. If the latter is glutinous, then a large mass of the same species may occur, formed of individual bacteria embedded in what appears to be a mass of jelly.

When this occurs, it is known as a *zooglæa* mass. On the other hand, if the envelope has not this cohesive property the separation of individuals may easily take place, especially in a fluid medium in which they may float entirely free from one another. Many of the higher bacteria possess a sheath which has a much more definite structure than is found among the lower forms. It resists external influences, possesses elasticity, and serves to bind the elements of the organism together.

Reproduction among the Lower Bacteria. — When a bacterial cell is placed in favourable surroundings it multiplies; as has been said, this, in the great majority of cases, takes place by simple fission. In the process a constriction appears in the middle and a transverse unstained line develops across the protoplasm at that point. The process goes on till two individuals can be recognised, which may remain for a time attached to one another, or become separate, according to the character of the envelope, as already explained. In most bacteria growth and multiplication go on with great rapidity. A bacterium may reach maturity and divide in from twenty minutes to half an hour. If division takes place only every hour, from one individual after twenty-four hours 17,000,000 similar individuals will be produced. As shown by the results of artificial cultivation, others, such as the tubercle bacillus, multiply much more slowly. Sometimes division proceeds so rapidly that the young individuals do not reach the adult size before multiplication again occurs. This may give rise to anomalous appearances. When bacteria are placed in unfavourable conditions as regards food, etc., growth and multiplication take place with difficulty. In the great majority of cases this is evidenced by changes in the appearance of the protoplasm. Instead of its maintaining the regularity of shape seen in healthy bacteria, various aberrant appearances are presented. This occurs especially in the rod-shaped varieties, where flask-shaped or dumb-bell-shaped individuals may be seen. The regularity in structure and size is quite lost. The appearance of the protoplasm also is often altered. Instead of, as formerly, staining well, it does not stain readily, and may have a uniformly pale, homogeneous appearance, while in an old culture only a small proportion of the bacteria may stain at all. Sometimes, on the other hand, a degenerated bacterium contains intensely stained granules or

globules which may be of large size. Such aberrant and degenerate appearances are referred to as *involution forms*. That these forms really betoken degenerative changes is shown by the fact that, on their being again transferred to favourable conditions, only slight growth at first takes place. Many individuals have undoubtedly died, and the remainder which live and develop into typical forms may sometimes have lost some of their properties.

Reproduction among the Higher Bacteria.—Most of the higher bacteria consist of thread-like structures more or less septate, and often surrounded by a sheath. The organism is frequently attached at one end to some object or to another individual. It grows to a certain length, and then at the free end certain cells called gonidia are cast off, from which new individuals are formed. These gonidia may be formed by a division taking place in the terminal element of the filament, such as has occurred in the growth of the latter. In some cases, however, division takes place in three dimensions of space. The gonidia have a free existence for a certain time before becoming attached, and in this stage are sometimes motile. They are usually rod-like in shape, sometimes pyriform. They do not possess any special powers of resistance.

Spore Formation.—In certain species of the lower bacteria, under certain circumstances, changes take place in the protoplasm which result in the formation of bodies called spores, to which the vital activities of the original bacteria are transferred. Spore formation occurs chiefly among the bacilli and in some spirilla. Its commencement in a bacterium is indicated by the appearance in the protoplasm of a minute highly refractile granule (or by a number of minute highly refractile granules scattered about throughout the protoplasm which gradually coalesce) unstained by the ordinary methods. This increases in size, and assumes a round, oval, or short rod-shaped form, always shorter but often broader than the original bacterium. In the process of spore formation the rest of the bacterial protoplasm may remain unchanged in appearance and staining power for a considerable time (*e.g.* *B. tetani*), or, on the other hand, it may soon lose its power of staining and ultimately disappear, leaving the spore in the remains of the envelope (*e.g.* *B. anthracis*). This method of spore formation is called *endogenous*. Bacterial spores are always non-motile. The spore may appear in the centre of the bacterium, or it may be at one extremity, or a short distance from one extremity (Fig. 1, No. 11). In structure the spore consists of a mass of protoplasm surrounded by a dense

membrane. This can be demonstrated by methods which will be described, the underlying principle of which is the prolonged application of a powerful stain. The membrane is supposed to confer on the spore its characteristic feature, namely, great capacity of resistance to external influences such as heat or noxious chemicals. Koch, for instance, in one series of experiments, found that while the bacillus anthracis in the unspored form was killed by a two minutes' exposure to 1 per cent carbolic acid, spores of the same organism resisted an exposure of from one to fifteen days.

When a spore is placed in suitable surroundings for growth it again assumes the original bacillary or spiral form. The capsule dehisces either longitudinally, or terminally, or transversely. In the last case the dehiscence may be partial, and the new individual may remain for a time attached by its ends to the hinged spore-case, or the dehiscence may be complete and the bacillus grow with a cap at each end consisting of half the spore-case. Sometimes the spore-case does not dehisce, but is simply absorbed by the developing bacterium.

It is important to note that in the bacteria spore formation is rarely, if ever, to be considered as a method of multiplication. In at least the great majority of cases only one spore is formed from one bacterium, and only one bacterium in the first instance from one spore. Sporulation is to be looked upon as a *resting stage* of a bacterium, and is to be contrasted with the stage when active multiplication takes place. The latter is usually referred to as the *vegetative stage* of the bacterium. Regarding the signification of spore formation in bacteria there has been some difference of opinion. According to one view it may be regarded as representing the highest stage in the vital activity of a bacterium. There is thus an alternation between the vegetative and spore stage, the occurrence of the latter being necessary to the maintenance of the species in its greatest vitality. Such a rejuvenescence, as it were, through sporulation, is known in many algæ. In support of this view there are certain facts. In many cases, for instance, spore formation only occurs at temperatures specially favourable for growth and multiplication. There is often a temperature below which, while vegetative growth still takes place, sporulation will not occur, and in the case of *B. anthracis*, if the organism be kept

at a temperature above the limit at which it grows best, not only are no spores formed, but the species may lose the power of sporulation. Furthermore, in the case of bacteria preferring the presence of oxygen for their growth, an abundant supply of this gas may favour sporulation. Most bacteriologists are, however, of opinion that when a bacterium forms a spore, it only does so when its surroundings, especially its food supply, become unfavourable for vegetative growth; it then remains in this condition until it is placed in more suitable surroundings. Such an occurrence would be analogous to what takes place under similar conditions in many of the protozoa. Often sporulation can be prevented from taking place for an indefinite time if a bacterium is constantly supplied with fresh food (the other conditions of life being equal). The presence of substances excreted by the bacteria themselves plays, however, a more important part in making the surroundings unfavourable than the mere exhaustion of the food supply. A living spore will always develop into a vegetative form if placed in a fresh food supply. With regard to the rapid formation of spores when the conditions are favourable for vegetative growth, it must be borne in mind that in such circumstances the conditions may really very quickly become unfavourable for a continuance of growth, since not only will the food supply around the growing bacteria be rapidly exhausted, but the excretion of effete and inimical matters will be all the more rapid.

We must note that the usually applied tests of a body developed within a bacterium being a spore are (1) its staining reaction, namely, resistance to ordinary staining fluids, but capacity of being stained by the special methods devised for the purpose (*vide* p. 106); (2) the fact that the bacterium containing the spore has higher powers of resistance against inimical conditions than a vegetative form. It is important to bear these tests in mind, as, in some of the smaller bacteria especially, it is very difficult to say whether they spore or not. There may appear in such organisms small unstained spots the significance of which it is very difficult to determine.

The Question of Arthrosporous Bacteria. — It is stated by Hueppe that among certain organisms, *e.g.* some streptococci, certain individuals may, without endogenous sporulation, take on a resting stage. These become swollen, stain well with ordinary stains, and they are stated to have higher

power of resistance than the other forms; further, when vegetative life again occurs it is from them that multiplication is said to take place. From the fact that there is no new formation within the protoplasm, but that it is the whole of the latter which participates in the change, these individuals have been called *arthrospores*. The existence of such special individuals amongst the lower bacteria is extremely problematical. They have no distinct capsule, and they present no special staining reactions, nor any microscopic features by which they can be certainly recognised, while their alleged increased powers of resistance are very doubtful. All the phenomena noted can be explained by the undoubted fact that in an ordinary growth there is very great variation among the individual organisms in their powers of resistance to external conditions.

Motility. — As has been stated, many bacteria are motile. Motility can be studied by means of hanging-drop preparations (*vide* p. 68). The movements are of a darting, rolling, or vibratile character. The degree of motility depends on the temperature, on the age of the growth, and on the medium in which the bacteria are. Sometimes the movements are most active just after the cell has multiplied, sometimes it goes on all through the life of the bacterium, sometimes it ceases when sporulation is about to occur. Motility is associated with the possession of fine wavy thread-like appendages called flagella, which for their demonstration require the application of special staining methods (*vide* Fig. 1, No. 12; and Fig. 115). They have been shown to occur in many bacilli and spirilla, but only in a few species of cocci. They vary in length, but may be several times the length of the bacterium, and may be at one or both extremities or all round. When terminal they may occur singly or there may be several. The nature of these flagella has been much disputed. Some have held that, unlike what occurs in many algæ, they are not actual prolongations of the bacterial protoplasm, but merely appendages of the envelope, and have doubted whether they are really organs of locomotion. There is now, however, little doubt that they belong to the protoplasm. By appropriate means the central parts of the latter can be made to shrink away from the peripheral (*vide infra*, "plasmolysis"). In such a case movement goes on as before, and in stained preparations the flagella can be seen to be attached to the peripheral zone. It is to be noted that flagella have never been demonstrated in non-motile bacteria, while, on the other hand, they have been observed in nearly

all motile forms. There is little doubt, however, that all cases of motility among the bacteria are not dependent on the possession of flagella, for in some of the special spiral forms, and in most of the higher bacteria, motility is probably due to contractility of the protoplasm itself.

The Minuter Structure of the Bacterial Protoplasm. — Many attempts have been made to obtain deeper information as to the structure of the bacterial cell, and especially as to its behaviour in division. These have largely turned on the interpretation to be put on certain appearances which have been observed. These appearances are of two kinds. First, under certain circumstances irregular, deeply stained granules are observed in the protoplasm, often, when they occur in a bacillus, giving the latter the appearance of a short chain of cocci. They are often called metachromatic granules (*vide* Fig. 1, No. 16) from the fact that by appropriate procedure they can be stained with one dye, and the protoplasm in which they lie with another; sometimes, when a single stain is used, such as methylene-blue, they assume a slightly different tint from the protoplasm.

For the demonstration of the metachromatic granules two methods have been advanced. Ernst recommends that a few drops of Löffler's methylene-blue (*vide* p. 100) be placed on a cover-glass preparation and the latter passed backwards and forwards over a Bunsen flame for half a minute after steam begins to rise. The preparation is then washed in water and counter-stained for one or two minutes in watery Bismarck-brown. The granules are here stained blue, the protoplasm brown. Neisser stains a similar preparation in warm carbol-fuchsin, washes with 1 per cent sulphuric acid and counter-stains with Löffler's blue. Here the granules are magenta, the protoplasm blue. The general character of the granules thus is that they retain the first stain more intensely than the rest of the protoplasm does.

A second appearance which can sometimes be seen in specimens stained in ordinary ways is the occurrence of a concentration of the protoplasm at each end of a bacterium, indicated by these parts being deeply stained. These deeply stained parts are sometimes called polar granules (*vide* Fig. 1, No. 16, the bacillus most to the left), (German, Polkörnchen or Polkörner).

With regard to the significance that is to be attached to such appearances, much depends on whether they are constantly present under all circumstances, or only occasionally, when the organism is grown in special media or under special growth conditions. Some bacteria, however stained, show evidence of having the protoplasm somewhat granular. In other cases this granular condition is only seen when the organism has been grown under bad conditions, or where the food supply is becoming exhausted. Some have thought that the appearances might be due to a process allied to mitosis, and might signify approaching division, but of this there is no evidence.

In perfectly healthy and young bacteria, moreover, appearance of granule formation and of vacuolation may be accidentally produced by physical means in the occurrence of what is known as *plasmolysis*. To speak generally, when a mass of protoplasm surrounded by a fairly firm envelope of a colloidal nature

is placed in a solution containing salts in greater concentration than that in which it has previously been living, then by a process of osmosis the water held in the protoplasm passes out through the membrane, and, the protoplasm retracting from the latter, the appearance of vacuolation is presented. Now in making a dried film for the microscopic examination of bacteria, the conditions necessary for the occurrence of this process may be produced, and the appearances of vacuolation and of Polkörperchen may thus be brought about. Plasmolysis in bacteria has been extensively investigated,¹ and has been found to occur in some species more readily than in others. We may conclude that such appearances as vacuolation of the bacterial protoplasm and Polkörperchen are very often either signs of degeneration, like the metachromatic granules, or are artificially produced. They are most frequently observed in old or otherwise enfeebled cultures.

Bütschli, from a study of some large sulphur-containing forms, concludes that the greater part of the bacterial cell may correspond to a nucleus, and that this is surrounded by a thin layer of protoplasm, which in the smaller bacteria escapes notice, unless when, as in the bacilli, it can be made out at the ends of the cells. Fischer, it may be said, looks on the appearances seen in Bütschli's preparations as due to plasmolysis. By special staining methods, Nakanishi believes that he has been able to demonstrate, undoubtedly, nuclei in a number of bacterial species. His work, however, has not yet been confirmed.

The Chemical Composition of Bacteria. — In the bodies of bacteria many definite substances occur. Some bacteria have been described as containing chlorophyll, but these are properly to be classed with the schizophyceæ. Sulphur is found in some of the higher forms, and starch granules are also described as occurring. Many species of bacteria, when growing in masses, are brilliantly coloured, though few bacteria associated with the production of disease give rise to pigments. In some of the organisms classed as bacteria a pigment named bacterio-purpurin has been observed in the protoplasm, and similar intracellular pigments probably occur in some of the larger forms of the lower bacteria and may occur in the smaller; but it is usually impossible to determine whether the pigment occurs inside or outside the protoplasm. In many cases, for the free production of pigment abundant oxygen supply is necessary; but sometimes, as in the case of *Spirillum rubrum*, the pigment is best formed in the absence of oxygen. Sometimes the faculty of forming it may be lost by an organism for a time, if not permanently, by the conditions of its growth being altered.

¹ Consult Fischer, "Untersuchungen über Bakterien," Berlin, 1894; "Ueber den Bau der Cyanophyceen und Bakterien," Jena, 1897.

Thus, for example, if the *B. pyocyaneus* be exposed to the temperature of 42° C. for a certain time, it loses its power of producing its bluish pigment. Pigments formed by bacteria often diffuse out into, and colour, the medium for a considerable distance around.

Comparatively little is known of the nature of bacterial pigments. Zopf, however, has found that many of them belong to a group of colouring matters which occur widely in the vegetable and animal kingdoms, viz., the lipochromes. These lipochromes, which get their name from the colouring matter of animal fat, include the colouring matter in the petals of Ranunculaceæ, the yellow pigments of serum and of the yolks of eggs, and many bacterial pigments. The lipochromes are characterised by their solubility in chloroform, alcohol, ether, and petroleum, and by their giving indigo-blue crystals with strong sulphuric acid, and a green colour with iodine dissolved in potassium iodide. Though crystalline compounds of these have been obtained, their chemical constitution is entirely unknown, and even their percentage composition is disputed.

Some observations have been made on the chemical structure of bacterial protoplasm. Nencki isolated from the bodies of certain putrefactive bacteria proteid bodies which, according to Ruppel, appear to have been allied to peptone, and which certainly differed from nucleo-proteids in not containing phosphorus, but many of the proteids isolated by other chemists have been allied in their nature to the protoplasm of the nuclei of cells. Buchner in certain researches obtained bodies of this nature allied to the vegetable caseins, and he adduces evidence to show that it is to these that the characteristic staining properties are due. Various observers have isolated similar phosphorus-containing proteids from different bacteria. Besides proteids, however, substances of a different nature have been isolated. Thus cellulose, fatty material, chitin, wax-like bodies, and other substances have been observed. There are also found various mineral salts, especially those of sodium, potassium, and magnesium. The amount of different constituents varies according to the age of the culture and the medium used for growth, and certainly great variation takes place in the composition of different species.

The Classification of Bacteria. — There have been numerous schemes set forth for the classification of bacteria, the fundamental principle running through all of which has been the recognition of the two sub-groups and the type forms mentioned

in the opening paragraph above. In the attempts to still further subdivide the group, scarcely two systematists are agreed as to the characters on which sub-classes are to be based. Our present knowledge of the essential morphology and relations of bacteria is as yet too limited for a really natural classification to be attempted. To prepare for the elaboration of the latter, Marshall Ward suggests that in every species there should be studied the habitat, best food supply, condition as to gaseous environment, range of growth, temperature, morphology, and life history, special properties, and pathogenicity.

We must thus be content with a provisional and incomplete classification. We have said that the division into lower and higher bacteria is recognised by all, though, as in every other classification, there occur transitional forms. In subdividing the bacteria further, the forms they assume constitute at present the only practicable basis of classification. The lower bacteria thus naturally fall into the three groups mentioned, the cocci, bacilli, and spirilla, though the higher are more difficult to deal with. Subsidiary, though important, points in still further subdivision are the planes in which fission takes place, and the presence or absence of spores. The recognition of actual species is often a matter of great difficulty. The points to be observed in this will be discussed later (p. 112).

I. The Lower Bacteria.¹—These, as we have seen, are minute unicellular masses of protoplasm surrounded by an envelope, the total vital capacities of a species being represented in every cell. They present three distinct type forms, the coccus, the bacillus, and the spirillum; endogenous sporulation may occur. They may also be motile.

1. *The Cocci.*—In this group, the cells range in different species from $.5 \mu$ to 2μ in diameter, but most measure about 1μ . Before division they may increase in size in all directions. The species are usually classified according to the method of division. If the cells divide only in one axis, and through the consistency of their envelopes remain attached, then a chain of cocci will be formed. A species in which this occurs is known as a *streptococcus*. If division takes place irregularly the resultant mass

¹ For the illustration of this and the succeeding systematic paragraphs, *vide* Fig. 1.

may be compared to a bunch of grapes, and the species is often called a *staphylococcus*. Division may take place in two axes at right angles to one another, in which case cocci adherent to each other in packets of four (called *tetrads*) or sixteen may be found,

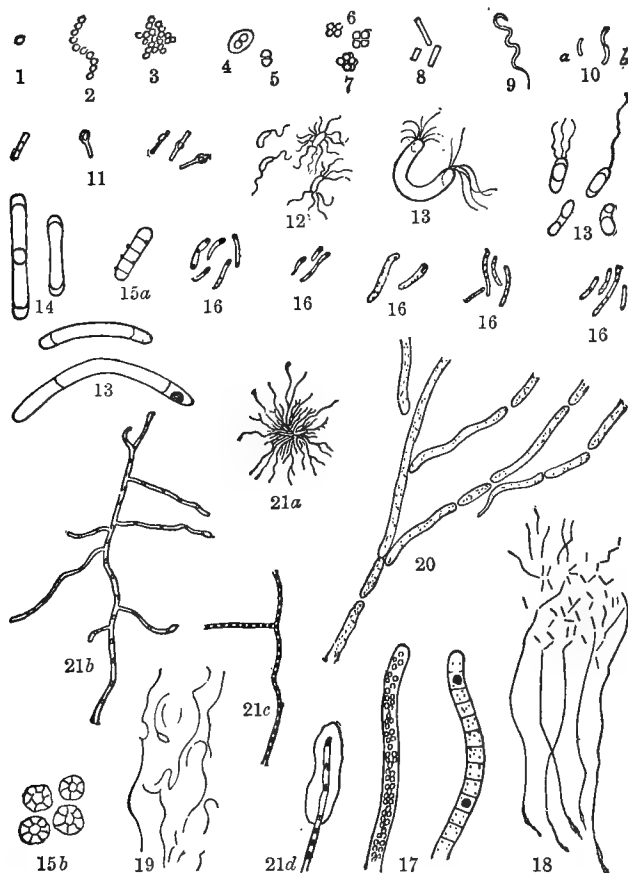

FIG. 1. — 1. Coccus. 2. Streptococcus. 3. Staphylococcus. 4. Capsulated diplococcus. 5. "Biscuit"-shaped coccus. 6. Tetrads. 7. Sarcina form. 8. Types of bacilli (1-8 are diagrammatic). 9. Non-septate spirillum $\times 1000$. 10. Ordinary spirillum — (a) comma-shaped element; (b) formation of spiral by comma-shaped elements $\times 1000$. 11. Types of spore formation. 12. Flagellated bacteria. 13. Changes in bacteria produced by plasmolysis (after Fischer). 14. Bacilli with terminal protoplasm (Bütschli). 15. (a) Bacillus composed of five protoplasmic meshes; (b) protoplasmic network in micrococcus (Bütschli). 16. Bacteria containing metachromatic granules (Ernst, Neisser) — some contain polar granules. 17. *Beggiatoa alba*. Both filaments contain sulphur granules — one is septate. 18. *Thiothrix tenuis* (Winogradski). 19. *Leptothrix innominata* (Miller). 20. *Cladothrix dichotoma* (Zopf). 21. *Streptothrix actinomyces* (Boström), (a) colony under low power; (b) filament showing true branching; (c) filament containing coccus-like bodies; (d) filament with club at end.

the former number being the more frequent. To all these forms the word *micrococcus* is often generally applied. The individuals in a growth of micrococci often show a tendency to remain united in twos. These are spoken of as *diplococci*, but this is not a distinctive character, since every coccus as a result of division becomes a diplococcus, though in some species the tendency to remain in pairs is well marked. The adhesion of cocci to one another depends on the character of the capsule. Often this has a well-marked outer limit (*micrococcus tetragenus*), sometimes it is of great extent, its diameter being many times that of the coccus (*streptococcus mesenterioides*). It is especially among the streptococci and staphylococci that the phenomenon of the formation of arthrospores is said to occur. In none of the cocci have endogenous spores been certainly observed. The number of species of the streptococci and staphylococci probably exceeds 150. Usually included in this group are coccus-like organisms which divide in three axes at right angles to one another. These are usually referred to as *sarcinæ*. If the cells are lying single they are round, but usually they are seen in cubes of eight, with the sides which are in contact slightly flattened. Large numbers of such cubes may be lying together. The *sarcinæ* are, as a rule, rather larger than the other members of the group. Most of the cocci are non-motile, but a few motile species possessing flagella have been described.

2. *Bacilli*. — These consist of long or short cylindrical cells, with rounded or sharply rectangular ends, usually not more than $1\ \mu$ broad, but varying very greatly in length. They may be motile or non-motile. Where flagella occur, these may be distributed all round the organism, or only at one or both of the poles (*pseudomonas*). Several species are provided with sharply marked capsules (*B. pneumoniae*). In many species endogenous sporulation occurs. The spores may be central or terminal, round, oval, or spindle-shaped.

Great confusion in nomenclature has arisen in this group in consequence of the different artificial meanings assigned to the essentially synonymous terms bacterium and bacillus. Migula, for instance, applies the former term to non-motile species, the latter to the motile. Hueppe, on the other hand, calls those in which endogenous sporulation does not occur, bacteria, and those where it does, bacilli. In the ordinary terminology of systematic bacteriology the word bacterium has been almost dropped, and is reserved, as we

have done, as a general term for the whole group. It is usual to call all the rod-shaped varieties bacilli. And until the botanists themselves agree to adopt a common standard of nomenclature, it is preferable, we think, to retain the use of the older system throughout this work.

3. *Spirilla*. — These consist of cylindrical cells more or less spiral or wavy. Of such there are two main types. In one there is a long non-septate, usually slender, wavy or spiral thread (*e.g.* spirillum of relapsing fever, Fig. 1, No. 9). In the other type the unit is a short curved rod (often referred to as of a "comma" shape). When two or more of the latter occur, as they often do, end to end with their curves alternating, then a wavy or spiral thread results. An example of this is the cholera microbe (Fig. 1, No. 10). This latter type is of much more frequent occurrence, and contains the more important species. Among the first group motility is often not associated, as far as is known, with the possession of flagella. The cells here apparently move by an undulating or screw-like contraction of the protoplasm. Most of the motile spirilla, however, possess flagella. Of the latter there may be one or two, or a bunch containing as many as twenty, at one or both poles. Division takes place as among the bacilli, and in some species endogenous sporulation has been observed.

Three terms are used in dividing this group, to which different authors have given different meanings. These terms are spirillum, spirochæta, vibrio. Migula makes "vibrio" synonymous with "microspira," which he applies to members of the group which possess only one or two polar flagella; "spirillum" he applies to similar species which have bunches of polar flagella, while "spirochæta" is reserved for the long unflagellated spiral cells. Hueppe applies the term "spirochæta" to forms without endospores, "vibrio" to those with endospores in which during sporulation the organism changes its form, and "spirillum" to the latter when no change of form takes place in sporulation. Flugge, another systematist, applies "spirochæta" and "spirillum" indiscriminately to any wavy or corkscrew form, and "vibrio" to forms where the undulations are not so well marked. It is thus necessary, in denominating such a bacterium by a specific name, to give the authority from whom the name is taken.

II. The Higher Bacteria. — These show advance on the lower in consisting of definite filaments branched or unbranched. In most cases the filaments at more or less regular intervals are cut by septa into short rod-shaped or curved elements. Such elements are more or less interdependent on one another, and special staining methods are often necessary to demonstrate the

septa which demarcate the individuals of a filament. There is further often a definite membrane or sheath common to all the elements in a filament. Not only, however, is there this close organic relationship between the elements of the higher bacteria, but there is also interdependence of function; for example, one end of a filament is frequently concerned merely in attaching the organism to some other object. The greatest advance, however, consists in the setting apart among most of the higher bacteria of the free terminations of the filaments for the production of new individuals, as has been described (p. 5). There are various classes under which the species of the higher bacteria are grouped; but our knowledge of them is still somewhat limited, as many of the members have not yet been artificially cultivated. The *beggiatoa* group consists of free-swimming forms, motile by undulating contractions of their protoplasm. For the demonstration of the rod-like elements of the filaments special staining is necessary. The filaments have no special sheath, and the protoplasm contains sulphur granules. The method of reproduction is doubtful. The *thiothrix* group resembles the last in structure, and the protoplasm also contains sulphur granules; but the filaments are attached at one end, and at the other form gonidia. The *leptothrix* group resembles closely the thiothrix group, but the protoplasm does not contain sulphur granules. In the *cladothrix* group there is the appearance of branching, which, however, is of a false kind. What happens is that a terminal cell divides, and on dividing again, it pushes the product of its first division to one side. There are thus two terminal cells lying side by side, and as each goes on dividing, the appearance of branching is given. Here, again, there is gonidium formation; and while the parent organism is in some of its elements motile, the gonidia move by means of flagella. The highest development is in the *streptothrix* group,¹ to which belongs the streptothrix actinomyces, or the actinomyces bovis, an important pathogenic agent. Here the organism consists of a felted mass of non-septate filaments, in which true dichotomous branching occurs. Under certain circumstances threads grow out and produce chains of coccus-like bodies from which new

¹ Lachner-Sandoval has pointed out the impropriety of the employment of the term "streptothrix," and instead, clearly justifies the use of the term "actinomyces" for all members of this group.

individuals can be reproduced. Such bodies are often referred to as spores, but they have not the same staining reactions nor resisting powers of so high a degree as ordinary bacterial spores. Sometimes too the protoplasm of the filaments breaks up into bacillus-like elements, which may also have the capacity of originating new individuals. In the streptothrix actinomycetes there may appear a club-shaped swelling of the membrane at the end of the filament, which has by some been looked on as an organ of fructification, but which is most probably a product of a degenerative change. The streptothrix group, though its morphology and relationships are much disputed, may be looked on as a link between the bacteria on the one hand and the lower fungi on the other. Like the latter, the streptothrix forms show the felted mass of non-septate branching filaments, which is usually called a mycelium. On the other hand, the breaking up of the protoplasm of the streptothrix into coccus- and bacillus-like forms, links it to the other bacteria.

GENERAL BIOLOGY OF THE BACTERIA.

There are five prime factors which must be considered in the growth of bacteria, namely, food supply, moisture, relation to gaseous environment, temperature, and light.

Food Supply.—The bacteria are chiefly found living on the complicated organic substances which form the bodies of dead plants and animals, or which are excreted by the latter while they are yet alive. Seeing that, as a general rule, many bacteria grow side by side, the food supply of any particular variety is, relatively to it, altered by the growth of the other varieties present. It is thus impossible to imitate the complexity of the natural food environment of any species. The artificial media used in bacteriological work may therefore be poor substitutes for the natural supply. In certain cases, however, the conditions under which we grow cultures may be better than the natural conditions. For while one or two species of bacteria growing side by side may favour the growth of the other, it may also in certain cases hinder it, and, therefore, when the latter is grown alone it may grow better. Most bacteria seem to produce excretions which are unfavourable to their own vitality, for, when a species is sown on a mass of artificial food medium, it does not in the great majority of cases go on growing till the

food supply is exhausted, but soon ceases to grow. Effete products diffuse out into the medium and prevent growth. Such diffusion may be seen when the organism produces pigment, *e.g.* *B. pyocyaneus* growing on gelatin. In supplying artificial food for bacterial growth, the general principle ought to be to imitate as nearly as possible the natural surroundings, though it is found that there exists a considerable adaptability among organisms. With the pathogenic varieties it is usually found expedient to use media derived from the fluids of the animal body, and in cases where bacteria growing on plants are being studied, infusions of the plants on which they grow are frequently used. Some bacteria can exist on inorganic food, but most require organic material to be supplied. Of the latter some require for their proper nourishment proteid to be present, while others can derive their nitrogen from such a non-proteid as asparagin. All bacteria require nitrogen to be present in some form, and many require to derive their carbon from carbohydrates. Mineral salts, especially sulphates, chlorides, and phosphates, and also salts of iron, are necessary. Occasionally special substances are needed to support life. Thus some species, in the protoplasm of which sulphur granules occur, require sulphuretted hydrogen to be present. In nature the latter is usually provided by the growth of other bacteria. When the food supply of a bacterium fails, it degenerates and dies. The proof of death lies in the fact that when it is transferred to fresh and good food supply it does not multiply. If the bacterium spores, it may then survive the want of food for a very long time. It may here be stated that the reaction of the food medium is a matter of great importance. Most bacteria prefer a slightly alkaline medium, and some, *e.g.* the cholera spirillum, will not grow in the presence of the smallest amount of free acid.

Moisture. — The presence of water is necessary for the continued growth of all bacteria. The amount of drying which bacteria in the vegetative stage will resist varies very much in different species. Thus the cholera spirillum is killed by two or three hours' drying, while the staphylococcus pyogenes aureus will survive ten days' drying, and the bacillus diphtheriæ still more. In the case of spores the periods are much longer. Anthrax spores will survive drying for several years, but here

again moisture enables them to resist longer than when they are quite dry. When organisms have been subjected to such hostile influences, even though they survive it by no means follows that they retain all their vital properties.

Relation to Gaseous Environment. — The relation of bacteria to the oxygen of the air is such an important factor in the life of bacteria that it enables a biological division to be made among them. Some bacteria will only live and grow when oxygen is present. To these the title of *obligatory aerobes* is given. Other bacteria will only grow when no oxygen is present. These are called *obligatory anaerobes*. To still other bacteria the presence or absence of oxygen is a matter of indifference. This group might theoretically be divided into those which are preferably aerobes, but could be anaerobes, and those which are preferably anaerobes, but could be aerobes. As a matter of fact, such differences are manifested to a slight degree, but all such organisms are usually grouped as *facultative anaerobes*, *i.e.* preferably aerobic but capable of existing without oxygen. Examples of obligatory aerobes are *B. proteus vulgaris*, *B. subtilis*; of obligatory anaerobes, *B. tetani*, *B. œdematis maligni*, while the great majority of pathogenic bacteria are facultative anaerobes. With regard to anaerobes, hydrogen and nitrogen are indifferent gases. Many anaerobes, however, do not flourish well in an atmosphere of carbon dioxide. Very few experiments have been made to investigate the action on bacteria of gas under pressure. A great pressure of carbon dioxide is said to make the *B. anthracis* lose its power of sporing, but it seems to have no effect on its vitality nor on that of the *B. typhosus*. With the bacillus pyocyaneus, it is said to destroy life.

Temperature. — For every species of bacterium there is a temperature at which it grows best. This is called the “optimum temperature.” There is also in each case a maximum temperature above which growth does not take place, and a minimum temperature below which growth does not take place. As a general rule the optimum temperature is about the temperature of the natural habitat of the organism. For organisms taking part in the ordinary processes of putrefaction the temperature of warm summer weather (20° to 24° C.) may be taken as the average optimum, while for organisms normally inhabiting animal tissues 35° to 39° C. is a fair average. The lowest limit of

ordinary growth is from 12° to 14° C., and the upper is from 42° to 44° C. In exceptional cases growth may take place as low as 5° C. and as high as 70° C. Some organisms which grow best at a temperature of from 60° to 70° C. have been isolated from dung, the intestinal tract, etc. These have been called *thermophilic* bacteria. It is to be noted that while growth does not take place below or above a certain limit it by no means follows that death takes place outside such limits. Organisms can resist cooling below their minimum or heating beyond their maximum without being killed. Their vital activity is merely paralysed. Especially is this true of the effect of cold on bacteria. The results of different observers vary; but if we take as an example the cholera vibrio, Koch found that while the minimum temperature of growth was 16° C., a culture might be cooled to -32° C. without being killed. With regard to the upper limit, few ordinary organisms in a spore-free condition will survive a temperature of 57° C., if long enough applied. Many organisms lose some of their properties when grown at unnatural temperatures. Thus many pathogenic organisms lose their virulence if grown above their optimum temperature, and some chromogenic forms, most of which prefer rather low temperatures, lose their capacity of producing pigment, *e.g.* spirillum rubrum.

Effect of Light. — Of recent years much attention has been paid to this factor in the life of bacteria. Direct sunlight is found to have a very inimical effect. One observer found that an exposure of dry anthrax spores for one and a half hours to sunlight killed them. When they were moist, a much longer exposure was necessary. Typhoid bacilli were killed in about one and a half hours, and similar results have been obtained with many other organisms. In such experiments the thickness of the medium surrounding the growth is an important point. Death takes place more readily if the medium is scanty or if the organisms are suspended in water. Any fallacy which might arise from the effect of the heat rays of the sun has been excluded, though light plus heat is more fatal than light alone. In direct sunlight it is chiefly the green, violet, and, it may be, the ultra-violet rays which are fatal. Diffuse daylight has also a bad effect upon bacteria, though it takes a much longer exposure to do serious harm. A powerful electric light is as fatal as sunlight, but the so-called X-rays are quite without any

germicidal effect. Here, as with other factors, the results vary very much with the species under observation, and a distinction must be drawn between a mere cessation of growth and the condition of actual death. Some bacteria, especially occurring on the dead bodies of fresh fish, are phosphorescent.

Conditions affecting the Movements of Bacteria. — In some cases differences are observed in the behaviour of motile bacteria, contemporaneous with changes in their life history. Thus, in the case of *bacillus subtilis*, movement ceases when sporulation is about to take place. On the other hand, in the *bacillus* of symptomatic anthrax, movement continues while sporulation is progressing. Under ordinary circumstances motile bacteria appear not to be constantly moving but occasionally to rest. In every case the movements become more active if the temperature be raised. Most interest, however, attaches to the fact that bacilli may be attracted to certain substances and repelled by others. Schenk, for instance, observed that motile bacteria were attracted to a warm point in a way which did not occur when the bacteria were dead and therefore only subject to physical conditions. Most important observations have been made on the attraction and repulsion exercised on bacteria by chemical agents, which have been denominated respectively *positive* and *negative chemiotaxis*. Pfeffer investigated this subject in many lowly organisms, including *bacterium termo* and *spirillum undula*. The method was to fill with the agent a fine capillary tube, closed at one end, to introduce it into a drop of fluid containing the bacteria under a cover-glass, and to watch the effect through the microscope. The general result was to indicate that motile bacteria may be either attracted or repelled by the fluid in the tube. The effect of a given fluid differs in different organisms, and a fluid chemiotactic for one organism may not act on another. Degree of concentration is important, but the nature of the fluid is more so. Of inorganic bodies salts of potassium are the most powerfully attracting bodies, and in comparing organic bodies the important factor is the molecular constitution. These observations have been confirmed by Ali-Cohen, who found that while the vibrio of cholera and the typhoid bacillus were scarcely attracted by chloride of potassium, they were powerfully influenced by potato juice. Further, the filtered products or the growth of

many bacteria have been found to have powerful chemiotactic properties. It is evident that all these observations have a most important bearing on the action of bacteria, though we do not yet know their true significance. Corresponding chemiotactic phenomena are shown also by certain animal cells, *e.g.* leucocytes, to which reference is made below.

The Parts played by Bacteria in Nature. — As has been said, the chief effect of bacterial action in nature is to break up into more simple combinations the complex molecules of the organic substances which form the bodies of plants and animals, or which are excreted by them. In some cases we know some of the stages of disintegration, but in most cases we know only general principles and sometimes only results. In the case of milk, for instance, we know that lactic acid is produced from the lactose by the action of the *bacillus acidilactici* and of other bacteria, and that from urea ammonium carbonate is produced by the *micrococcus ureæ*. That the very complicated process of putrefaction is due to bacteria is absolutely proved, for any organic substance can be preserved indefinitely from ordinary putrefaction by the adoption of some method of killing all bacteria present in it, as will be afterwards described. This statement, however, does not exclude the fact that molecular changes take place spontaneously in the passing of the organic body from life to death. Many processes not usually referred to as putrefactive are also bacterial in their origin. The souring of milk, already referred to, the becoming rancid of butter, the ripening of cream and of cheese, are all due to bacteria.

A certain comparatively small number of bacteria have been proved to be the causal agents in some disease processes occurring in man, animals, and plants. This means that the fluids and tissues of living bodies are, under certain circumstances, a suitable pabulum for the bacteria involved. The effects of the action of these bacteria are analogous to those taking place in the action of the same or other bacteria on dead animal or vegetable matter. The complex organic molecules are broken up into simpler products. We shall study these processes more in detail later. Meantime we may note that the disease-producing effects of bacteria form the basis of another biological division of the group. Some bacteria are harmless to animals and plants, and apparently under no

circumstances give rise to disease in either. These are known as saprophytes. They are normally engaged in breaking up dead animal and vegetable matter. Others normally live on or in the bodies of plants and animals and produce disease. These are known as parasitic bacteria. Sometimes an attempt is made to draw a hard and fast line between the *saprophytes* and the *parasites*, and obligatory saprophytes or parasites are spoken of. This is an erroneous distinction. Some bacteria which are normally saprophytes can produce pathogenic effects (*e.g.* bacillus œdematis maligni), and it is consistent with our knowledge that the best-known parasites may have been derived from saprophytes. On the other hand, the fact that most bacteria associated with disease processes, and proved to be the cause of the latter, can be grown in artificial media, shows that for a time at least such parasites can be saprophytic. As to how far such a saprophytic existence of disease-producing bacteria occurs in nature, we are in many instances still ignorant.

The Methods of Bacterial Action.—The processes which bodies undergo in being split up by bacteria depend, first, on the chemical nature of the bodies involved and, secondly, on the varieties of the bacteria which are acting. The destruction of albuminous bodies which is mostly involved in the wide and varied process of putrefaction can be undertaken by whole groups of different varieties of bacteria. The action of the latter on such substances is analogous to what takes place when albumins are subjected to ordinary gastric and intestinal digestion. In these circumstances, therefore, the production of albumoses, peptones, etc., similar to those of ordinary digestion, can be recognised in putrefying solutions, though the process of destruction always goes further, and still simpler substances, *e.g.* indol, and, it may be, crystalline bodies of an alkaloidal nature, are the ultimate results. The process is an exceedingly complicated one when it takes place in nature, and different bacteria are probably concerned in the different stages. Many other bacteria, *e.g.* some pathogenic forms, though not concerned in ordinary putrefactive processes, have a similar digestive capacity. When carbohydrates are being split up, then various alcohols, ethers, and acids are produced. During bacterial growth there is not infrequently the abundant production of such gases as

sulphuretted hydrogen, carbon dioxide, methane, etc. For an exact knowledge of the destructive capacities of any particular bacterium there must be an accurate chemical examination of its effects when it has been grown in artificial media the nature of which is known. The precise substances it is capable of forming can thus be found out. Many substances, however, are produced by bacteria, of the exact nature of which we are still ignorant, for example, the toxic bodies which play such an important part in the action of many pathogenic species.

Many of the actions of bacteria depend on the production by them of *ferments* of a very varied nature and complicated action. Thus the digestive action on albumins probably depends on the production of a peptic ferment analogous to that produced in the animal stomach. Ferments which invert sugar, which split sugars up into alcohols or acids, which coagulate casein, which split up urea into ammonium carbonate, also occur.

Such ferments may be diffused into the surrounding fluid, or be retained in the cells where they are formed. Sometimes the breaking down of the organic matter appears to take place within, or in the immediate proximity of, the bacteria, sometimes wherever the soluble ferments reach the organic substances. And in certain cases the ferments diffused out into the surrounding medium probably break down constituents of the latter to some extent, and prepare them for a further, probably intracellular, disintegration. Thus in certain putrefactions of fibrin, if the process be allowed to go on naturally, the fibrin dissolves and ultimately great gaseous evolution of carbon dioxide and ammonia takes place, but if the bacteria, shortly after the process has begun, are killed or paralysed by chloroform, then only a peptonisation of the fibrin occurs, without the further splitting up and gaseous production being observed. That a purely intracellular digestion may take place is illustrated by what has been shown to occur in the case of the micrococcus ureæ, which from urea forms ammonium carbonate by adding water to the urea molecule. Here, if after the action has commenced the bacteria are filtered off, no further production of ammonium carbonate takes place, which shows that no ferment has been dissolved out into the urine. If now the bodies of the bacteria be extracted with absolute alcohol or ether, which of course destroys their vitality, a substance is obtained of the

nature of a ferment, which, when added to sterile urine, rapidly causes the production of ammonium carbonate. This ferment has evidently been contained within the bacterial cells.

In considering the effects of bacteria in nature it must be recognised that some species are capable of building up complex substances out of simple chemical compounds. Examples of these are found in the bacteria which in the soil make nitrogen more available for plant nutrition by converting ammonia into nitrites and nitrates. Winogradski, by using media containing non-nitrogenous salts of magnesium, potassium, and ammonium, and free of organic matter, has demonstrated the existence of forms which convert, by oxidation, ammonia into nitrites and of other forms which convert these nitrites into nitrates. Both can derive their necessary carbon from alkaline carbonates. Other bacteria or organisms allied to the bacteria exist which can actually take up and combine into new compounds the free nitrogen of the air. These are found in the tubercles which develop on the rootlets of the leguminosæ. Without such organisms the tubercles do not develop, and without the development of the tubercles the plants are poor and stunted. Bacteria thus play an important part in the enrichment and fertilisation of the soil.

The Occurrence of Variability among Bacteria.—The question of the division of the group of bacteria into definite species has given rise to much discussion among vegetable and animal morphologists, and at one time very divergent views were held. Some even thought that the same species might at one time give rise to one disease, — at another time to another. There is, however, now practical unanimity that bacteria show as distinct species as the other lower plants and animals, though, of course, the difficulty of defining the concept of a species is as great in them as it is in the latter. Still, we can say that among the bacteria we have exhibited (to use the words of De Bary) “the same periodically repeated course of development within certain empirically determined limits of variation” which justifies, among higher forms of life, a species to be recognised. What at first raised doubts as to the occurrence of species among the bacteria was the observation in certain cases of what is known as *pleomorphism*. By this is meant that one species may assume at different times different forms, *e.g.* appear as a coccus, a bacillus, or a leptothrix. Undoubtedly many of the cases where this was alleged to have been observed occurred before the elaboration of the modern technique for the obtaining of pure cultures, but at the present day there are cases where evidence appears to exist of the occurrence of pleomorphism. This is especially the case with certain bacilli, and it may lead to such forms being classed among the higher bacteria. Pleomorphism is, however, a rare condition, and with regard to the bacteria as a whole we may say that each variety tends to conform to a definite type of structure and function which is peculiar to it and to it alone. On the other hand, slight variations from such type can occur in each. The size may vary a little with the medium in which the organism is growing, and under certain similar conditions the adhesion of bacteria to each other may also vary. Thus cocci, which are ordinarily seen in short chains, may grow in long chains. The capacity to form spores may be altered, and

such properties as the elaboration of certain ferments or of certain pigments may be impaired. Also the characters of the growths on various media may undergo variations. As has been remarked, variation as observed consists largely in a tendency in a bacterium to lose properties ordinarily possessed, and all attempts to transform one bacterium into an apparently closely allied variety (such as the *B. coli* into the *B. typhosus*) have failed. This of course does not preclude the possibility of one species having been originally derived from another or of both having descended from a common ancestor, but we can say that only variations of an unimportant order have been observed to take place, and here it must be remembered that in many cases we can have forty-eight or more generations under observation within twenty-four hours.

CHAPTER II.

METHODS OF CULTIVATION OF BACTERIA.

Introductory. — In order to study the characters of any species of bacterium it is necessary to have it growing apart from every other species. In the great majority of cases where bacteria occur in nature, this condition is not fulfilled. In the general processes of putrefaction many different species occur all mingled with each other. Only in the blood and tissues in some diseases do particular species occur singly and alone. We usually have, therefore, to remove a bacterium from its natural surroundings and grow it on an artificial food medium. When we have succeeded in separating it, and have got it to grow on a medium which suits it, we are said to have obtained a *pure culture*. The recognition of different species of bacteria depends, in fact, far more on the characters presented by pure cultures and their behaviour in different food media, than on microscopic examination. The latter in most cases only enables us to refer a given bacterium to its class. Again, in inquiring as to the possible possession of pathogenic properties by a bacterium, the obtaining of pure cultures is absolutely essential. If two or more different organisms be present together, we cannot say that any one of them is the cause of the disease in question.

To obtain pure cultures, then, is the first requisite of bacteriological research. Now, as bacteria are practically omnipresent, we must first of all have means of destroying all extraneous organisms which may be present in the food media to be subsequently used for growing the bacteria we wish to study, in the vessels in which the food media are contained, and on all instruments which are to come in contact with our cultures. The technique of this destructive process is called sterilisation. We must, therefore, study the *methods of sterilisation*. The growth of bacteria in other than their natural surroundings involves further the *preparation of sterile artificial food media*, and when we have such media prepared we have still to look at the tech-

nique of the *separation of micro-organisms from mixtures of these, and the maintaining of pure cultures when the latter have been obtained.* We shall here find that different methods are necessary according as we are dealing with *aerobes* or *anaerobes*. Each of these methods will be considered in turn.

THE METHODS OF STERILISATION.

To exclude extraneous organisms, all food materials, glass vessels containing them, wires used in transferring bacteria from one culture medium to another, instruments used in making autopsies, etc., must be sterilised. These objects being so different, various methods are necessary. The foods comprise meat infusions, jellies, potatoes, etc., and a method suitable for their sterilisation evidently may not be suitable for the sterilisation of, say, a glass flask. Bacteria may be killed by various methods. Many chemicals will kill them, but the difficulty of subsequently removing such chemicals, so that they may not interfere with the growth of the microbes we wish to cultivate, makes their use inapplicable. We therefore in practice take advantage of the principle that all bacteria are destroyed by heat. The temperature necessary varies with different bacteria, and the vehicle of heat is also of great importance. The two vehicles employed are hot air and hot water or steam. The former is usually referred to as "dry heat," the latter as "moist heat." As showing the different effects of the two vehicles, Koch found, for instance, that the spores of bacillus anthracis, which were killed by moist heat at 100° C., in one hour, required three hours' dry heat at 140° C. to effect death. Both forms of heat may be applied at different temperatures; in the case of moist heat above 100° C., a pressure higher than that of the atmosphere must of course be present.

A. *Sterilisation by Dry Heat.*

A. (1) **Red Heat or Dull Red Heat.** — Red heat is used for the sterilisation of the platinum needles, which, it will be found, are so constantly in use. A dull heat is used for cauteries, the points of forceps, and may be used for the incidental sterilisation of small glass objects (cover-slips, slides, occasionally when necessary even test-tubes), care of course being taken not to melt the glass. The heat is obtained by an ordinary Bunsen burner.

A. (2) Sterilisation by Dry Heat in a Hot-air Chamber.—

The chamber (Fig. 2) consists of an outer and inner case of sheet iron. In the bottom of the outer there is a large hole.

A Bunsen is lit beneath this, and thus plays on the bottom of the inner case, round all of the sides of which the hot air rises and escapes through holes in the top of the outer case. A thermometer passes down into the interior of the chamber, halfway up which its bulb should be situated. It is found, as a matter of experience, that an exposure in such a chamber for one hour to a temperature of 170° C., is sufficient to kill all the organisms which usually pollute articles in a bacteriological laboratory, though

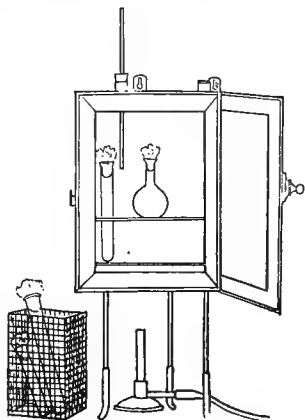

FIG. 2. — Hot-air steriliser.

circumstances might arise where this would be insufficient. This means of sterilisation is used for the glass flasks, test-tubes, plates, Petri's dishes, the use of which will be described. Such pieces of apparatus are thus obtained sterile and dry. It is advisable to put glass vessels into the chamber before heating it, and to allow them to stand in it after sterilisation till the temperature falls. Sudden heating or cooling is apt to cause glass to crack. The method is manifestly unsuitable for food media.

B. Sterilisation by Moist Heat.

B. (1) By Boiling.—The boiling of a liquid for five minutes is sufficient to kill ordinary germs if no spores be present, and this method is useful for sterilising distilled or tap water which may be required in various manipulations. It is best to sterilise knives and instruments used in autopsies by boiling in water to which a little sodium carbonate has been added to prevent rusting. Twenty minutes' boiling will here be sufficient. The boiling of any fluid at 100° C. for one and a half hours will ensure sterilisation under almost any circumstances.

B. (2) By Steam at 100° C.—This is by far the most useful means of sterilisation. It may be accomplished in an ordinary potato steamer placed on a kitchen pot. The apparatus ordi-

narily used is "Koch's steam steriliser" (Fig. 3). This consists of a tall metal cylinder on legs, provided with a lid, and covered externally by some bad conductor of heat, such as felt or asbestos. A perforated tin diaphragm is fitted in the interior at a little distance above the bottom, and there is a tap at the bottom by which water may be supplied or withdrawn. If water to the depth of 3 inches be placed in the interior and heat applied, it will quickly boil, and the steam streaming up will surround any flask or other object standing on the diaphragm. Here no evaporation takes place from any medium as it is surrounded during sterilisation by an atmosphere saturated with water vapour. It is convenient to have the cylinder tall enough to hold a litre flask with a funnel 7 inches in diameter standing in its neck. The funnel

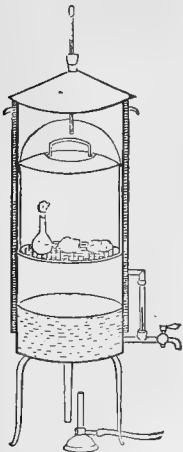

FIG. 3.—Koch's steam steriliser.

may be supported by passing its tube through a second perforated diaphragm placed in the upper part of the steam chamber. With such a "Koch" in the laboratory a hot-water filter is not needed. An even more serviceable steriliser is that known as the Arnold steam steriliser, which, by its peculiar construction, effects a greater saving in the time necessary to develop steam than does a similar sized Koch apparatus. As has been said, one and a half hours' steaming will sterilise any medium, but in the case of media containing gelatin such an exposure is not practicable, as, with long boiling, gelatin tends to lose its physical property of solidification. The method adopted in this case is to *steam for a quarter of an hour on each of three succeeding days.*

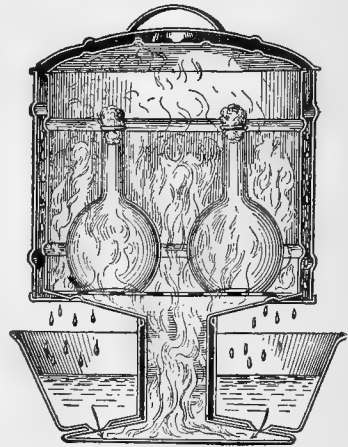

FIG. 4.—The Arnold steam-steriliser.

This is a modification of what is known as "Tyndall's intermittent sterilisation." The fundamental principle of this method is

that all bacteria in a non-spored form are killed by the temperature of boiling water, while if in a spored form they may not be thus killed. Thus by the sterilisation on the first day all the non-spored forms are destroyed — the spores remaining alive. During the twenty-four hours which intervene before the next heating, these spores, being in a favourable medium, are likely to assume the non-spored form. The next heating kills these. In case any may still not have changed their spored form, the process is repeated on a third day. Experience shows that usually the medium can now be kept indefinitely in a sterile condition. Steam at 100° C. is therefore under most conditions available for the sterilisation of all ordinary media. In using the Koch's steriliser, especially when a large bulk of medium is to be sterilised, it is best to put the media in while the apparatus is cold, in order to make certain that the whole of the food mass reaches the temperature of 100° C., and it is preferable to prolong the period of exposure to half an hour, always reckoning from the time boiling commences in the water in the steriliser.

If we wish to use such a substance as blood serum as a medium, the albumin would be coagulated by a temperature of 100° C. Therefore other means have to be adopted in this case.

B. (3) Sterilisation by Steam at High Pressure. — This is the most rapid and effective means of sterilisation. It is effected in an autoclave (Fig. 5). This is a gun-metal cylinder on legs, the top of which is fastened down with screws and nuts and is furnished with a safety valve, pressure-gauge, and a hole for thermometer. As in the Koch's steriliser, the contents are supported on a perforated diaphragm. The source of heat is a large Bunsen beneath. The temperature employed is usually 115° C. or 120° C. To boil at 115° C., water requires a pressure of about 23 lb. to the square inch (*i.e.* 8 lb. plus the 15 lb. of ordinary atmospheric pressure). To boil at 120° C., a pressure of about 30 lb. (*i.e.* 15 lb. plus the usual pressure) is necessary. In such an apparatus the desired temperature is maintained by

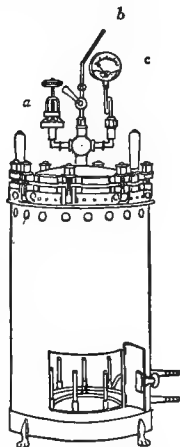

FIG. 5. — Autoclave.
a, safety valve.
b, blow-off pipe.
c, gauge.

adjusting the safety valve so as to blow off at the corresponding pressure. One exposure of media (when in small bulk) to the latter temperature for seven minutes is sufficient to kill all organisms or spores, but if the bulk is great, then it is advisable to prolong the exposure to fifteen minutes. Here, again, care must be taken when gelatin is to be sterilised. It must not be exposed to a temperature above 105° C., and must be sterilised by the intermittent method.¹ Certain precautions are necessary in using the autoclave. In all cases it is necessary to allow the apparatus to cool well below 100° C. before opening it or allowing steam to blow off, otherwise there will be a sudden development of steam when the pressure is removed, and fluid media will be blown out of the flasks. Sometimes the instrument is not fitted with a thermometer. In this case care must be taken to expel all the air initially present, otherwise a mixture of air and steam being present, the pressure read off the gauge cannot be accepted as an indication of the temperature.

Further, care must be taken to ensure the presence of a residuum of water when steam is fully up, otherwise the steam is superheated, and the pressure on the gauge again does not indicate the temperature correctly.

B. (4) Sterilisation at Low Temperatures. — Most organisms in a non-spored form are killed by a prolonged exposure to a temperature of 57° C. This fact has been taken advantage of for the sterilisation of blood serum, which will coagulate if exposed to a temperature above that point. Such a medium is sterilised on Tyndall's principle by exposing it for an hour at 57° C. for eight consecutive days, it being allowed to cool in the interval to the room temperature. The apparatus shown in Fig. 6

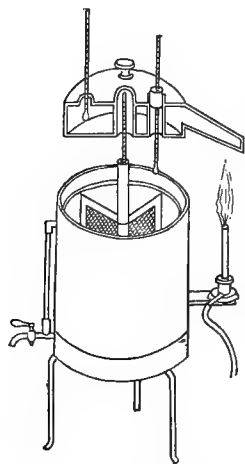

FIG. 6.—Steriliser for blood serum.

is a small hot-water jacket heated by a Bunsen placed beneath it, the temperature being controlled by a gas regulator. To

¹ This medium will retain its gelatinising power perfectly well when sterilised for five minutes in the autoclave, if, on removal therefrom, it be at once placed in the ice-chest to cool.

ensure that the temperature all around shall be the same, the lid also is hollow and filled with water, and there is a special gas burner at the side to heat it. This is the form originally used, but serum sterilisers are now constructed in which the test-tubes are placed in the sloped position, and in which inspissation (*vide* p. 43) can afterwards be performed at a higher temperature.

THE PREPARATION OF CULTURE MEDIA.¹

The general principle to be observed in the artificial culture of bacteria is that the medium used should approximate as closely as possible to that on which the bacterium grows naturally. In the case of pathogenic bacteria the medium therefore should resemble the juices of the body. The serum of the blood satisfies this condition and is often used, but its application is limited by the difficulties in its preparation and preservation. Other media have been found which can support the life of all the pathogenic bacteria isolated. These consist of proteids or carbohydrates in a fluid, semi-solid, or solid form, in a transparent or opaque condition. The advantage of having a variety of media lies in the fact that growth characters on particular media, non-growth on some and growth on others, etc., constitute specific differences which are valuable in the identification of bacteria. The most commonly used media have as their basis a watery extract of meat. Most bacteria in growing in such an extract cause only a grey turbidity. A great advance resulted when Koch, by adding to it gelatin, provided a transparent solid medium in which growth characteristics of particular bacteria become evident. Many organisms, however, grow best at a temperature at which this nutrient gelatin melts, and therefore another gelatinous substance of vegetable origin, called *agar*, which does not melt below 98° C., was substituted. Bouillon made from meat extract, gelatin, and agar media, and the modifications of these, constitute the chief materials in which bacteria are grown.

¹ The student is strongly advised to make himself familiar with the more elaborate technique laid down by the Bacteriological Committee of the American Public Health Association, which has been adopted in America as the standard of procedure in bacteriological investigation. The technique as outlined in the following pages will be found, however, to be more suitable to the necessities of the work of large classes, or where facilities for the prosecution of advanced work are lacking.

Preparation of Meat Infusion.

The flesh of the ox, calf, or horse is usually employed. Horse-flesh has the advantage of being cheaper and containing less fat than the others; though generally quite suitable, it has the disadvantage for certain purposes of containing a larger proportion of fermentable sugar. The flesh must be freed from fat, and finely minced. To a pound of mince add 1000 c.c. distilled water, and mix thoroughly in a shallow dish. Set aside in a cool place for twenty-four hours. Skim off any fat present, removing the last traces by stroking the surface of the fluid with pieces of filter paper. Place a clean linen cloth over the mouth of a larger filter funnel, and strain the fluid through

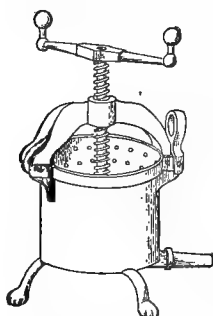

FIG. 7.—Meat press.

it into a flask. Pour the minced meat into the cloth, and gathering up the edges of the latter in the left hand, squeeze out the juice still held back in the contained meat. Finish this expression by putting the cloth and its contents into a meat press (Fig. 7), similar to that used by pharmacists in preparing extracts; thus squeeze out the last drops. The resulting sanguineous fluid contains the soluble albumins of the meat, the soluble salts, extracts, extractives, and colouring matter,

chiefly hæmoglobin. It is now boiled thoroughly for two hours, by which process the albumins coagulable by heat are coagulated. Strain now through a clean cloth, boil for another half-hour, and filter through white Swedish filter paper (best, C. Schleicher u. Schull, No. 595). Make up to 1000 c.c. with distilled water. The resulting fluid ought to be quite transparent, of a yellowish colour without any red tint. If there is any redness, the fluid must be reboiled and filtered till this colour disappears, otherwise in the later stages it will become opalescent. A large quantity of the infusion may be made at a time, and what is not immediately required is put into a large flask, the neck plugged with cotton wool, and the whole sterilised by methods B (2) or (3). This infusion contains very little albuminous matter, and consists chiefly of the soluble salts of the muscle, certain extractives, and altered colouring matters, along with any slight traces of soluble proteid not coagulated by heat. It is of acid

reaction. We have now to see how, by the addition of proteid and other matter, it may be transformed into proper culture media. Another and equally reliable method of making meat infusion, in which a great saving of time is accomplished, is by dissolving $2\frac{1}{2}$ grammes of Liebig's extract of meat in 1000 c.c. of boiling water.

1. **Bouillon Media.**—These consist of meat infusion with the addition of certain substances to render them suitable for the growth of bacteria.

1 (a). **Peptone Broth or Bouillon.**—This has the composition:—

Meat infusion	1000 c.c.
Sodium chloride	5 grms.
Peptone albumin	10 „

Boil till the ingredients are quite dissolved, and neutralise with a 4 per cent solution of sodium hydrate. This is done by adding cautiously a cubic centimetre or two of the sodium hydrate solution, stirring well the while, and testing the reaction by means of phenol-phthaleine paper, proceeding until the latter strikes a well-defined rose-pink colour, thus indicating the point of beginning alkalinity. Should, however, the color be deeper, approaching a madder, then the alkalinity can be decreased by adding enough of a 5 per cent hydrochloric acid solution until the desired colour tint is acquired. To prevent the subsequent precipitation of phosphates and other matters in the broth after autoclaving in tubes, it is recommended to autoclave the whole of the broth after adjusting the reaction, allowing it to become cold, and then filter it, when it may be tubed and again autoclaved with no fear of any subsequent clouding of the medium. This method of neutralisation is to be recommended for all ordinary work.

In this medium the place of the original albumins of the meat is taken by peptone, a soluble proteid not coagulated by heat. Here it may be remarked that the commercial peptone albumin is not pure peptone, but a mixture of albumoses (see footnote, p. 172) with a variable amount of pure peptone. The addition of the sodium chloride is necessitated by the fact that alkalisation precipitates some of the phosphates and carbonates present. Experience has shown that sodium chloride can quite well be substituted. The reason for the alkalisation is that it is found that most bacteria grow best on a medium slightly alkaline to litmus. Some, *e.g.* the cholera vibrio, will not grow at all on even a slightly acid medium.

Standardisation of Reaction of Media. — While the above procedure of dealing with the reaction of a medium is sufficient for ordinary work, it has been thought advisable to have a more exact method for making media to be used in growing organisms, the growth characteristics of which are to be described for systematic purposes. Such a method should also be used in studying the changes in reaction produced in a medium by the growth of bacteria. It, however, involves considerable difficulty, and should not be undertaken by the beginner. It entails the preparation of solutions of acid and alkali which may be used for determining the original reaction of the medium, and for accurately making it of a definite degree of alkalinity. Normal¹ and decinormal solutions of sodium hydrate and hydrochloric acid are used.

Preparation of Standard Solutions. — The first requisites here are normal solutions of acid and alkali. The latter is prepared as follows: 85 grammes of pure sodium bicarbonate are heated to dull redness for ten minutes in a platinum vessel and allowed to cool in an exsiccator; just over 54 grammes of sodium carbonate should now be present. Any excess is quickly removed, and the rest being dissolved in one litre of distilled water, a normal solution is obtained. A measured quantity is placed in a porcelain dish, and a few drops of a .5 per cent solution of phenol-phthaleine in 50 per cent alcohol is added to act as indicator. The alkali produces in the latter a brilliant rose pink, which, however, disappears on the least excess of acid being present. The mixture is boiled and a solution of hydrochloric acid of unknown strength is run into the dish from a burette till the colour goes, and does not return after very thorough stirring. The strength of the acid can then be calculated, and a normal solution can be obtained. From these two solutions any strength of acid or alkali (such as the decinormal solution of NaOH mentioned below) may be derived.

As Eyre has suggested, the reaction of a medium may be conveniently expressed by the sign + or - to indicate acid or alkaline respectively, and a number to indicate the number of cubic centimetres of normal acid or alkaline solution necessary

¹A "normal" solution of any salt is prepared by dissolving an "equivalent" weight in grammes of that salt in a litre of distilled water. If the metal of the salt be monovalent, *i.e.* if it be replaceable in a compound by one atom of hydrogen (*e.g.* sodium), an equivalent is the molecular weight in grammes. In the case of NaCl, it would be 58.5 grammes (atomic weight of Na=23, of Cl=35.5). If the metal be bivalent, *i.e.* requiring two atoms of H for its replacement in a compound (*e.g.* calcium), an equivalent is the molecular weight in grammes divided by two. Thus in the case of CaCl₂ an equivalent would be 55.5 grammes (atomic weight of Ca=40, of Cl₂=71).

to make a litre of the medium neutral to phenol-phthaleine. Thus, for example, "reaction = -15," will mean that the medium is alkaline, and requires 15 c.c. of normal HCl to make a litre neutral. It has been found that when a medium such as bouillon reacts neutral to litmus, its reaction to phenol-phthaleine, according to the above standard, is on the average +25. Now as litmus was originally introduced by Koch, and as nearly all bacterial research has been done with media tested by litmus, it is evidently difficult to say exactly what precise degree of alkalinity is the optimum for bacterial growth. It is probably safe to say, however, that when a medium has been rendered neutral to phenol-phthaleine by the addition of NaOH, the optimum degree is attained by the addition of from 10 to 15 c.c. of normal HCl per litre, *i.e.* the optimum reaction is +10 to +15. In other words, the optimum reaction for bacterial growth lies, as Fuller has pointed out, about midway between the neutral point indicated by phenol-phthaleine and the neutral point indicated by litmus.¹

The only objection to the use of phenol-phthaleine is that its action is somewhat vitiated if free CO₂ be present. This can be completely obviated as follows. Before testing any medium it is boiled in the porcelain dish into which titration takes place. The soda solutions are best stored in bottles such as that shown in Fig. 52, having on the air inlet a little bottle filled with soda lime with tubes fitted as in the large one. The CO₂ of the air which passes through is thus removed.

Method. — The practical application of these principles is as follows. Take the medium with all its constituents dissolved and filter it. Place 5 c.c. in a porcelain dish, add 45 c.c. of distilled water and 1 c.c. phenol-phthaleine, and boil. Run in decinormal soda till neutral point is reached. Repeat process thrice and take the mean to obtain amount of soda required. From this calculate acidity of medium per litre, and neutralise with normal soda solution. Check calculation by a fresh titration of 5 c.c. of the neutralised medium. Steam for half an hour, and take reaction again to see that it is constant. Now add normal HCl in the ratio of 1.5 c.c. per cent.

¹ For the majority of pathogenic bacteria, Fuller's optimum reaction is still too acid. It will be found that an acid reaction of .5-.3 is much more satisfactory.

The gelatin and agar media (*vide infra*) are treated in the same way.

1 (b). **Glucose Broth.**—To the other constituents of 1 (a) there is added 1 or 2 per cent of grape sugar. The steps in the preparation are the same. Glucose being a reducing agent, no free oxygen can exist in a medium containing it, and therefore glucose broth is used as a culture fluid for anaerobic organisms.

1 (c). **Glycerin Broth.**—The initial steps are the same as in 1 (a), but *after filtration* 6 to 8 per cent of glycerin (sp. grav. 1.25) is added. This medium is especially used for growing the tubercle bacillus when the soluble products of the growth of the latter are required.

2. **Agar Media** (French, “gélose”).—The disadvantage of gelatin is that at the blood temperature (38° C.), at which most pathogenic organisms grow best, it is liquid. To get a medium which will be solid at this temperature, agar is used as the stiffening agent instead of gelatin. Unlike the latter, which is a proteid, agar is a carbohydrate. It is derived from the stems of various seaweeds growing in the Chinese seas, popularly classed together as “Ceylon Moss.” The best for bacteriological purposes is that consisting of the thin dried stem of the seaweed itself.

2 (a). **Ordinary Agar.**—To preserve as far as possible the relative proportions of the ingredients throughout the process to the end, it will be found most advantageous to ascertain the weight of the finished product just previous to filtration, for then one can accurately make up deficiencies due to evaporation, or adjust excesses by further boiling down. To this end a large saucepan is taken and its weight ascertained, and, it being required to make 1000 grammes of agar, 1500 c.c. of water are poured into the pan and set over the flame of a triple Bunsen burner, or a laboratory furnace, and brought to the boil. At this juncture 15 grammes of the dry agar are shredded up and dropped in, along with 2.5 grammes of Liebig's meat extract. The boiling is continued until the agar is quite dissolved, usually occupying about thirty minutes, when the scum which rises to the surface should be skimmed off, the fire lowered until boiling ceases, and then 10 grammes of peptone and 5 grammes of common salt should be gradually dusted into the fluid with constant stirring to prevent the formation of large lumps of peptone, the pan replaced over the flame and contents boiled until all the peptone is com-

pletely dissolved. The reaction of the material is now adjusted according to the directions given under 1 (a). Previous to filtration the medium has to be clarified, and to accomplish this the pan is removed from the fire and its contents cooled down to 60° C., and to them are added the yolks and whites of two eggs beaten up gently in 100 c.c. of water. The pan is replaced upon the fire, and with a low burning flame the heat of the pan is to be gently and carefully raised to the boiling-point, so that the coagulation of the eggs may be produced gradually. After coagulation is completed, it is important to boil the agar gently for about ten or fifteen minutes to allow the surface coagulum to toughen sufficiently so that it will not readily disintegrate when the agar is poured into the funnel containing the filter paper. Before filtering, the pan and contents must be weighed, so that, deducting 50 grammes for each egg and the weight of the pan itself, the net result will be 1000 grammes. Filtration is now readily accomplished by using Swedish filter paper of moderate thickness folded and placed in a wire funnel, such as shown in Fig. 8, to prevent contact with the walls of the glass funnel into which it is placed, and moistened thoroughly. To the lower end of the glass funnel is affixed about 10 cm. of rubber tubing of proper calibre carrying a pinchcock and a glass delivery tube drawn out to a moderately fine bore. The apparatus is now set up on a stand and the hot agar poured carefully into the paper filter, the coagulum being held back by a small oval strainer mounted on a handle, or by a large spoon. The agar rapidly at first makes it way through the paper into the glass funnel, when it is at once delivered into sterile tubes in quantities of 12 c.c., or thereabouts; later on because of cooling and plugging of the pores of the paper by small particles of coagula, the agar comes through slower and slower, so that it is then necessary to empty it into the pan to be heated up and again poured into a fresh filter; this procedure being repeated as often as necessary. Filtration may also be accomplished by passing the hot agar through absorbent cotton packed not too tightly into the neck of a glass funnel and wetted, or we may have recourse to the use of a hot-water funnel (Fig. 9).

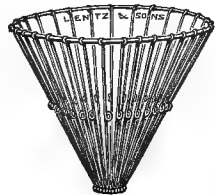

FIG. 8. — Wire funnel for supporting paper filter.

This consists of an outer tin funnel, the neck of which is fitted with a perforated cork, through which is placed the stem of an inner glass funnel. The interspace between the two funnels is filled with water, which is kept hot by a Bunsen under a side arm let into the outer funnel. Whichever instrument be used, before filtering shake up the melted medium, as it is apt while melting to have settled into layers of different density. The medium when tubed is to be sterilised in the autoclave seven minutes.

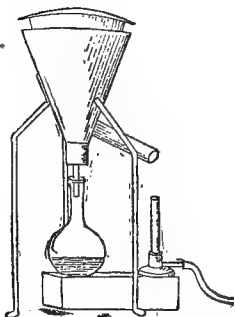

FIG. 9.—Hot-water funnel.

2 (b). **Glycerin Agar.**—To 2 (a) after filtration add 6 to 8 per cent of glycerin and sterilise as above. This is used especially for growing the tubercle bacillus.

2 (c). **Glucose Agar.**—Prepare as in 2 (a), but add 1 to 2 per cent of grape sugar along with agar. This medium is used for the culture of anaerobic organisms at temperatures above the melting-point of gelatin. It is also a superior culture medium for some aerobes, *e.g.* the *B. diphtheriæ*.

3. **Gelatin Media.**—These are simply the foregoing broths, with gelatin added as a solidifying body.

3 (a). **Peptone Gelatin.**—To 1100 c.c. of water brought to the boiling-point in a saucepan of known weight, 100 to 150 grammes of “gold label” gelatin (preferably that of Coignet et Cie., Paris) are added, the solution being rapidly made by grasping the bunch of leaves by one end in the hand, and stirring it around in the water. As soon as solution is accomplished the fluid is no longer permitted to boil, as prolonged boiling tends to destroy the gelatinising power of the medium. The further technique is quite the same as that described for making agar. The medium when tubed may be sterilised for five minutes in the autoclave at 120° C., without endangering its subsequent gelatinisation, if upon removal from the autoclave the tubes are placed in ice-water until solidified—a long experience justifies the use of the autoclave under such conditions. Too much boiling, or boiling at too high a temperature, as has been said, causes a gelatin medium to lose its property of solidification. This transparent solid gelatin medium is that chiefly

employed for the culture of aerobic bacteria at ordinary temperatures. The exact percentage of gelatin used in its preparation depends on the temperature at which growth is to take place. Its firmness is its most valuable characteristic, and to maintain this in summer weather, 15 parts per 100 are necessary. A limit is placed on higher percentages by the fact that, if the gelatin be too stiff, it will split on the perforation of its substance by the platinum needle used in inoculating it with a bacterial growth; 15 per cent gelatine melts at about 24° C.

3 (b). **Glucose Gelatin.** — The constituents are the same as 3 (a), with the addition of 1 to 2 per cent of grape sugar. The method of preparation is identical. This medium is used for growing anaerobic organisms at the ordinary temperatures.

3 (c). **Beerwort Gelatin** consists of hopped beerwort, to which has been added 10 or 15 per cent of gelatin. It is a useful medium for the cultivation of yeasts and moulds.

These bouillon, agar, and gelatin preparations constitute the most frequently used media. Growths on bouillon do not usually show any characteristic appearances which facilitate classification, but such a medium is of great use in investigating the soluble toxic products of bacteria. The most characteristic developments of organisms take place on the gelatin media. These have, however, the disadvantage of not being available when growth is to take place at any temperature above 24° C. For higher temperatures agar must be employed. Agar is, however, never so transparent. Though quite clear when fluid, on solidifying it always becomes slightly opaque. Further, growths upon it are never so characteristic as those on gelatin. It is, for instance, never liquefied, whereas some organisms, by their growth, liquefy gelatin and others do not — a fact of prime importance.

Litmus Media. — To any of the above media litmus (French, “tournesol”) may be added to show change in reaction during bacterial growth. The litmus is added, before sterilisation, as a strong watery solution¹ in sufficient quantity to give the medium a distinctly bluish tint. During the development of an acid reaction the colour changes to a pink and may subsequently be discharged.

Petruschky's Litmus-whey (as modified by Durham). — “Fresh milk is slightly warmed and clotted by means of essence of

¹ 6 grammes of Merck's neutral extract of litmus to 1000 c.c. of distilled water.

rennet. The whey is strained off and the clot is hung up to drain in a piece of muslin. The whey, which is somewhat turbid and yellow, is then cautiously neutralised with 4 per cent citric acid solution, neutral litmus being used as an indicator. When it gives a good neutral violet colour with the litmus, it is heated upon a water bath at 100° C. for half an hour or so; thereby nearly the whole of the proteid is coagulated. It is then filtered clear, and neutral litmus is added to a convenient colour for titrations or rougher observation." It may be sterilised in tubes or in bulk at 100° C., or by passing through a Berkefeld filter.

Use of neutral red.—This dye has recently been introduced as an aid in determining the presence or absence of members of the *B. coli* group, especially in the examination of water. The medium found most suitable is agar containing .5 per cent of glucose, to which 1 to 5 per cent of a concentrated solution of neutral red is added. The use of this medium and its probable value are described below.

Blood Agar and Serum Agar.—The former medium was introduced by Pfeiffer for growing the influenza bacillus, and it has been used for the organisms which are not easily grown on the ordinary media, *e.g.* the gonococcus and the pneumococcus. Human blood or the blood of animals may be used. "Sloped tubes" (*vide* p. 50) of agar are employed (glycerin agar is not so suitable). Purify a finger first with 1–1000 corrosive sublimate, dry, and then wash with absolute alcohol to remove the sublimate. Allow the alcohol to evaporate. Prick with a needle sterilised by heat, and, catching a drop of blood in the loop of a sterile platinum wire (*vide* p. 52), smear it on the surface of the agar. The excess of the blood runs down and leaves a film on the surface. Cover the tubes with india-rubber caps, and incubate them for one to two days at 37° C. before use, to make certain that they are sterile. Agar poured out in a thin layer in a Petri dish may be smeared with blood in the same way and used for cultures. In investigating the diseases of races other than the white, it appears advisable to use the blood of the race under investigation.

Serum agar is prepared in a similar way by smearing the surface of the agar with blood serum, or by adding a few drops of serum to the tube and then allowing it to flow over the surface.

Peptone Solution or Dunham's Medium.

A simple solution of peptone (Witte) constitutes a suitable culture medium for many bacteria. The peptone in the proportion of 1 to 2 per cent, along with .5 per cent NaCl, is dissolved in distilled water by heating. The fluid is then filtered, placed in tubes and sterilised. The reaction is usually distinctly alkaline, which condition is suitable for most purposes. For special purposes the reaction may be standardised. In such a solution the cholera vibrio grows with remarkable rapidity. It is also much used for testing the formation of indol by a particular bacterium; and by the addition of one of the sugars to it the fermentative powers of an organism may be tested. Litmus may be added to show any change in reaction.

Blood Serum.

Koch introduced this medium, and it is prepared as follows: Plug the mouth of a tall cylindrical glass vessel (say of 1000 c.c. capacity) with cotton wool, and sterilise by steaming it in a Koch's steriliser for one and a half hours. Take it to the place where a horse, ox, or sheep is to be killed. When the artery or vein of the animal is opened, allow the first blood which flows, and which may be contaminated from the hair, etc., to escape; fill the vessel with the blood subsequently shed. Carry carefully back to the laboratory without shaking, and place for twenty-four hours in a cool place, preferably an ice-chest. The clear serum will separate from the clotted blood. If a centrifuge is available, a large yield of serum may be obtained by centrifuging the freshly drawn blood. If coagulation has occurred, the clot must first be thoroughly broken up. With a sterile 10 c.c. pipette transfer this quantity of serum to each of a series of test-tubes which must previously have been sterilised by dry heat. The serum may, with all precautions, have been contaminated during the manipulations, and must be sterilised. As it will coagulate if heated above 68° C., advantage must be taken of the intermittent process of sterilisation at 57° C. [method B (4)]. It is therefore kept for one hour at this temperature on each of eight successive days. It is always well to incubate it for a day at 37° C. before use, to see that the result is successful. After sterilisation it is "inspissated,"

by which process a clear solid medium is obtained. "Inspissation" is probably an initial stage of coagulation, and is effected by keeping the serum at 65° C. till it stiffens. This temperature is just below the coagulation point of the serum. The more slowly the operation is performed the clearer will be the serum. The apparatus used is seen in Fig. 10. It consists of a rectangular, shallow, covered, hot-water jacket, with sloped bottom, and can be rapidly heated by an S-shaped Bunsen containing many lateral perforations, from each of which a flame issues. The serum tubes are thus placed in a sloped position, and the temperature being raised to 65° C., the contents solidify in a sloped position in the interior. It is well not only to have the jacket filled with water, but also to put some water in the

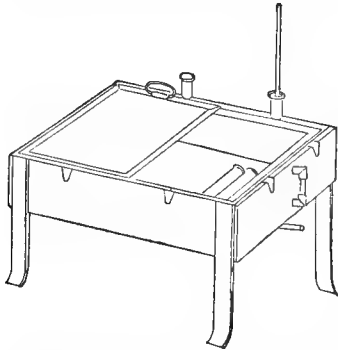

FIG. 10. — Blood serum inspissator.

trough in which the tubes lie, and also to have a thermometer in the water. This prevents cooling of the tubes when the lid is raised to see if the process is complete. As is evident, the preparation of this medium is tedious, but its use is necessary for the observation of particular characteristics in several pathogenic bacteria, notably the tubercle bacillus. Pleuritic and other effusions may be prepared in the same way, and used as media, but care must be taken in their use, as we have no right to say that pathological effusions have the same chemical composition as normal serum.

If blood be collected with strict aseptic precautions, then sterilisation of the serum is unnecessary. To this end the mouth of the cylinder used for collecting the blood, instead of being plugged with wool, has an india-rubber bung inserted in it through which two bent glass tubes pass. The outer end of one of these is of convenient length, and, before sterilisation, a large cap of cotton wool is tied over it; the other tube is plugged with a piece of cotton wool. In the slaughter-house the cap is removed and the tube is inserted into the blood-vessel as a canula. The cylinder is thus easily filled. Another method is to conduct the blood to the cylinder by means of a sterilised

canula and india-rubber tube, the former being inserted in the blood-vessel. The serum obtained under such circumstances must be incubated before use, to make sure that it is sterile.

Löffler's Blood Serum. — This is the best medium for the growth of the *B. diphtheriæ* and may be used for other organisms. It has the following composition. Three parts of calf's or lamb's blood serum are mixed with one part ordinary neutral peptone bouillon made from veal with 1 per cent of grape sugar added to it. Though this is the original formula it can be made from ox or sheep serum and beef bouillon without its qualities being markedly impaired. Sterilise by method B (4) as above (p. 32). Or we may adopt the more rapid method in bringing about coagulation at a high temperature, by placing the tubes as before in the inspissator and slowly raising the water in the jacket of the apparatus to the boiling-point and then turning out the gas. The serum will be found to be firmly coagulated and free from bubbles, if the precaution were taken to keep the tubes of serum free from contact with the metal bottom or sides of the inspissator by means of thin wooden slats properly adjusted. The medium must then be sterilised on three successive days in the Koch or Arnold steriliser.

Alkaline Blood Serum (Lorrain Smith's Method). — To each 100 c.c. of the serum obtained as before, add 1 to 1.5 c.c. of a 10 per cent solution of sodium hydrate and shake it gently. Put sufficient of the mixture into each of a series of test-tubes, and laying them on their sides, sterilise by method B (2). If the process of sterilisation be carried out too quickly, bubbles of gas are apt to form before the serum is solid, and these interfere with the usefulness of the medium. Dr. Smith informs us that this can be obviated if the serum be solidified high up in the Koch's steriliser, in which the water is allowed only to simmer. In this case sterilisation ought to go on for one and a half hours. A clear solid medium (consisting practically of alkali-albumin) is thus obtained, and he has found it of value for the growth of the organisms for which Koch's serum is used, and especially for the growth of the *B. diphtheriæ*. Its great advantage is that aseptic precautions in obtaining blood from the animal are not necessary, and it is easily sterilised.

Marmorek's Serum Media. — There has always been a difficulty in maintaining the virulence of cultures of the pyogenic

streptococci, but Marmorek has succeeded in doing so by growing them on the following media, which are arranged in the order of their utility : —

1. Human serum 2 parts, bouillon 1 part.
2. Pleuritic or ascitic serum 1 part, bouillon 2 parts.
3. Asses' or mules' serum 2 parts, bouillon 1 part.
4. Horse serum 2 parts, bouillon 1 part.

Human serum can be obtained from the blood shed in venesection, the same precautions being taken as in the case of that got in the slaughter-house. In the case of these media, sterilisation is effected by method B (4), and they are used fluid.

Hiss's Serum Media. — Their use is for a more efficient means of differentiating pneumococcus from streptococcus pyogenes, and they bear some resemblance to those of Marmorek.

- A. Ox serum 1 part.
Distilled water 2 parts.
Normal sodium hydrate 0.1 per cent.
- B. Ox serum 1 part.
Distilled water 2 parts.
Inulin 1.0 per cent.

They can be sterilised intermittently at 100° C. without coagulating. In either medium pneumococcus forms acid and coagulates the serum, but more rapidly in the latter, whilst streptococcus does neither.

Potatoes as Culture Material.

(a) **In Potato Jars.** — The jar consists of a round, shallow, glass vessel with a similar cover (*vide* Fig. 11). It is washed with 1-1000 corrosive sublimate, and a piece of circular filter paper, moistened with the same, is laid in its bottom. On this latter are placed four sterile watch-glasses. Two firm, healthy, small, round potatoes, as free from eyes as possible, and with the skin whole, are scrubbed well with a brush under the tap

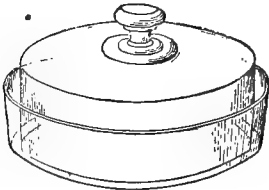

FIG. 11. — Potato jar.

and steeped for two or three hours in 1-1000 corrosive sublimate. They are steamed in the Koch's steriliser for thirty minutes or

longer, or in the autoclave for a quarter of an hour. When cold, each is grasped between the left thumb and forefinger (which have been sterilised with sublimate) and cut through the middle with a sterile knife. It is best to have the cover of the jar raised by an assistant, and to perform the cutting beneath it. Each half is put in one of the watch-glasses, the cut surfaces, which are then ready for inoculation with a bacterial growth, being uppermost. Smaller jars, each of which holds half of a potato, are also used in the same way and are very convenient.

(b) **By Slices in Tubes.**— This method, introduced by Ehrlich, is the best means of utilising potatoes as a medium. A large, long potato is well washed and scrubbed, and peeled with a clean knife. A cylinder is then bored from its interior with an apple corer or a large cork borer, and is cut obliquely, as in Fig. 12. Two wedges are thus obtained, and to preserve their



FIG. 12.— Cylinder of potato cut obliquely.

white appearance as much as possible these slices are placed in running water for 12 to 18 hours, then deposited broad end down in a test-tube of special form (see Fig. 13). In the wide part at the bottom of this tube is placed a piece of cotton wool, which catches any condensation water which may form.



FIG. 13.— Ehrlich's tube containing piece of potato.

The wedge rests on the constriction above this bulbous portion. The tubes, washed, dried, and with cotton wool in the bottom and in the mouth, are sterilised before the slices of potato are introduced. After the latter are inserted, the tubes are sterilised in the Koch steam steriliser for one hour, or in the autoclave for five minutes at 1 atmosphere pressure and 120° C. An ordinary test-tube may be used with a piece of sterile absorbent wool in its bottom, on which the potato may rest.

Glycerin potato, suitable for the growth of the tubercle bacillus, may be prepared by covering the slices in the tubes with 6 per cent solution of glycerin in water and steaming for half an hour. The fluid is then poured off and the sterilisation continued for another half-hour.

Potatoes ought not to be prepared long before being used, as the surface is apt to become dry and discoloured. It is well

to take the reaction of the potato with litmus before sterilisation, as this varies; normally in young potatoes it is weakly acid. The reaction of the potato may be more accurately estimated by steaming the potato slices for a quarter of an hour in a known quantity of distilled water and then estimating the reaction of the water by phenol-phthaleine. The required degree of acidity or alkalinity is obtained by adding the necessary quantity of HCl or NaOH solution (p. 37) and steaming for other fifteen minutes. The water is then poured off and sterilisation continued for another half-hour. Potatoes before being inoculated ought always to be incubated at 37° C. for a night, to make sure that their sterilisation has been successful. This is necessary only if sterilised in the Koch steamer.

Elsner's Medium. — This is one of the media introduced in the study of the comparative reactions of the typhoid bacillus and the bacillus coli. The preparation is as follows: 500 grammes potato are grated up in a litre of water, allowed to stand over night, then strained, and added to an equal quantity of ordinary 15 per cent peptone gelatin which has not been neutralised. Normal sodium hydrate solution is added till the reaction is feebly acid, the whole boiled together, filtered, and sterilised. Just before use potassium iodide is added so as to constitute one per cent of the amount used. Moore has used a similar agar preparation. Here 500 grammes potato are scraped up in one litre of water, allowed to stand for three hours, strained, and put aside over night. The clear fluid is poured off, made up to one litre, rendered slightly alkaline, 20 grammes agar are added, and the whole is treated as in making ordinary agar. The medium is distributed in test-tubes — 10 c.c. to each — and immediately before use, to each is added .5 c.c. of a solution of 10 grammes potassium iodide to 50 c.c. water.

Milk as a Culture Medium.

This is a convenient medium for observing the effects of bacterial growth in changing the reaction, in coagulating the soluble albumin, and in fermenting the lactose. It is prepared as follows: fresh milk is taken, preferably after having had the cream "separated" by centrifugalisation, as is practised in the best dairies, and is steamed for fifteen minutes in the Koch; it is then set aside in an ice-chest or cool place over night to facilitate further separation of cream. The milk is siphoned off from beneath the cream. The reaction of fresh milk is alkaline. If great accuracy is necessary, any required degree of reaction may be obtained by the titration method. It is then placed in tubes and sterilised by methods B (2) or B (3).

Added value is given to the usefulness of milk by the addition to each litre of 150 c.c. of a watery tincture of litmus (Merck's extract of litmus, 6 grammes; water, 1000 c.c.), whilst the retention of a small percentage of cream confers a distinct advantage.

Bread Paste.

This is useful for growing torulæ, moulds, etc. Some ordinary bread is cut into slices, and then dried in an oven till it is so dry that it can be pounded to a fine powder in a mortar, or rubbed down with the fingers and passed through a sieve. Some 100 c.c. flasks are washed, dried, and sterilised, and a layer of the powder, half an inch thick, placed on the bottom. Distilled water, sufficient to cover the whole of it, is then run in with a pipette held close to the surface of the bread, and, the cotton-wool plugs being replaced, the flasks are sterilised in the Koch's steriliser by method B (2). The reaction is slightly acid.

Beerwort.

Beerwort, and beerwort to which 10 per cent of gelatin has been added, are also used for the study of these higher organisms. One takes ordinary hopped beerwort and places it in, say, a litre flask, autoclaves it for five minutes, cools it thoroughly, and filters; by this means all resinous matters are precipitated and removed, and the wort remains permanently clear. It is tubed, and sterilised in the autoclave for seven minutes, or, as usual, in the Koch or Arnold apparatus.

THE USE OF THE CULTURE MEDIA.

The culture of bacteria is usually carried on in test-tubes conveniently $6 \times \frac{5}{8}$ in. If new, these ought to be carefully washed and dripped, and their mouths are plugged with pledgets of plain cotton wool. They are then sterilized for one hour at 170° C. The reason is that the glass, being usually packed in straw, is covered with the extremely resisting spores of the bacillus subtilis. Tubes which have been in use are merely well washed, dried thoroughly, and plugged. Cotton-wool plugs are universally used for protecting the sterile contents of flasks and tubes from contamination with the bacteria of the air. A medium thus protected will remain sterile for years. Whenever a protecting plug is removed for even a short time, the sterility

of the contents may be endangered. It is well to place the bouillon, gelatin, and agar media in the test-tubes directly after filtration. The media can then be sterilized in the test-tubes.

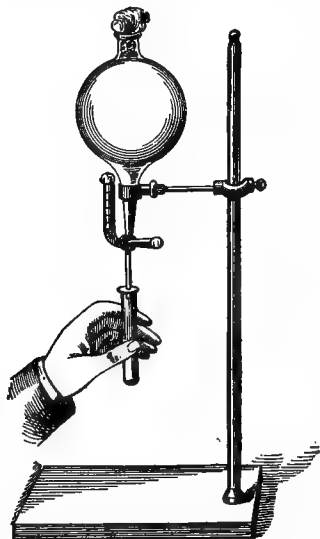

FIG. 14.—Apparatus for delivering measured quantities of media into tubes.

In filling tubes, care must be taken to run the liquid down the centre, so that none of it drops on the inside of the upper part of the tube with which the cotton-wool plug will be in contact, otherwise the latter will subsequently stick to the glass and its removal will be difficult. The tubes may, when filled, be placed in cages made of fine wire netting and sterilised. If all the contents of a flask of medium be not filled into tubes, the remainder must be re-sterilised before being stored. In the case of liquid media, test-tubes are filled about

one-third full. With solid media the amount varies. In the case of gelatin media, tubes filled one-third full and allowed to solidify while standing upright are those commonly used. With organisms needing an abundant supply of oxygen the best growth takes place on the surface of the medium, and for practical purposes the surface ought thus to be as large as possible. To this end "sloped" agar and gelatin tubes are used. To prepare these, tubes are filled only about one-sixth full, and after sterilisation are allowed to solidify, lying on their sides with their necks supported so that the contents extend 3 to 4 inches up, giving an oblique surface when held

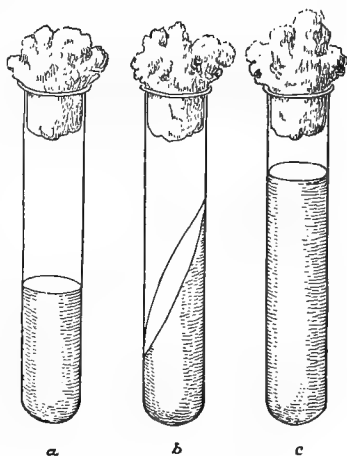

FIG. 15.—Tubes of media.
a Ordinary upright tube. *b*. Sloped tube.
c. "Deep" tube for cultures of anaerobes.

extend 3 to 4 inches up, giving an oblique surface when held

upright after solidification. Thus agar is commonly used in such tubes (less frequently gelatin is also "sloped"), and this is the position in which blood serum is inspissated. Tubes, especially those of the less commonly used media, should be placed in large jars provided with stoppers, otherwise the contents are apt to evaporate. A tube of medium which has been inoculated with a bacterium, and on which growth has taken place, is called a "culture." A "pure culture" is one in which only one organism is present. The methods of obtaining pure cultures will presently be described. When a fresh tube of medium is inoculated from an already existing culture, the resulting growth is said to be a "sub-culture" of

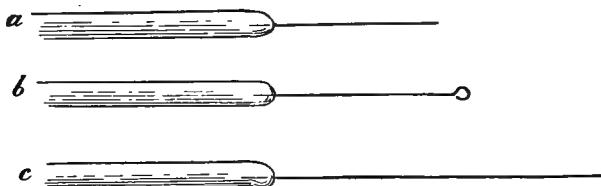

FIG. 16.—Platinum wires in glass handles.

a. Straight needle for ordinary puncture inoculations. *b.* "Platinum loop." *c.* Long needle for inoculating "deep" tubes.

the first. All manipulations involving the transference of small portions of growth either from one medium to another, as in the inoculation of tubes, or, as will be seen later, to cover-glasses for microscopic examination, are effected by pieces of platinum wire (Nos. 24 or 27 Birmingham wire gauge—the former being the thicker) fixed in glass rods 8 inches long.¹ Every worker should have three such wires. Two are $2\frac{1}{2}$ inches long, one of these being straight (Fig. 16, *a*), and the other having a loop turned upon it (Fig. 16, *b*). The latter is referred to as the platinum "loop" or platinum "eyelet," and is used for many purposes. "Taking a loopful" is a phrase constantly used. The third wire (Fig. 16, *c*) ought to be $4\frac{1}{2}$ inches long, and straight. It is used for making anaerobic cultures. Cultures on a solid medium are referred to (1) as "puncture" or "stab" cultures (German, *Stichkultur*), or (2) as "stroke" cultures (*Strichkultur*), according as they are made (1) on tubes solidified in the upright position, or (2) on sloped tubes.

¹ Aluminium rods are made which are very convenient. The end is split with a knife, the platinum wire is inserted and fixed by pinching the aluminium on it in a vice.

To inoculate, say, one ordinary upright gelatin tube from another, the two tubes are held in an inverted position between the forefinger and thumb of the left hand, with their mouths towards the person holding them; the plugs are twisted round once or twice, to make sure they are not adhering to the glass. The short, straight platinum wire is then heated to redness from point to insertion, and 2 to 3 inches of the glass rod are also passed two or three times through the Bunsen flame. It is held between the right fore and middle fingers, with the needle projecting backwards, *i.e.* away from the right palm. Remove plug from culture with right forefinger and thumb, and continue to hold it between the same fingers, by the part which projected beyond the mouth of the tube. Now touch the culture with the platinum needle, and, withdrawing it, replace plug. In the same way remove plug from tube to be inoculated, and plunge platinum wire down the centre of the gelatin to within half an inch of the bottom. It must on no account touch the glass above

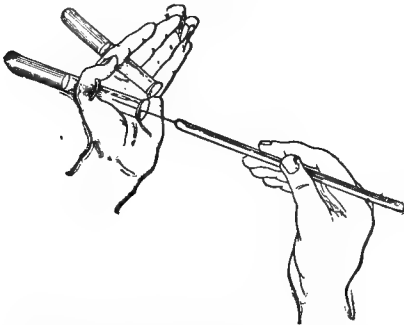

FIG. 17. — Another method of inoculating solid tubes.

the medium. The wire is then immediately sterilised. A variation in detail of this method is to hold the plug of the tube next the thumb between the fore and middle fingers, and the plug of the other between the middle and ring fingers, then to make the inoculation (Fig. 17). The sub-culture is labelled, and in a bacterio-

logical laboratory a label *should never be licked*. If a tube contain a liquid medium, it must be held in a sloping position between the same fingers, as above. When a stroke culture is made, the same manipulations are gone through. Here the platinum loop is used, and a little of the culture is smeared in a line along the surface of the medium from below upwards. In inoculating tubes, it is always well, on removing the plugs, to make sure that no strands of cotton fibre are adhering to the inside of the necks. As these might be touched with the charged needle and the plug thus be contaminated, they must be removed by heating the inoculating needle red-hot and

scorching them off with it. When the platinum wires are not in use they may be laid in a rack made by bending up the ends of a piece of tin (as in Fig. 18). To prevent contamination of cultures by bacteria falling on the plugs while these are exposed to the air during inoculation manipulations, some bacteriologists singe the plugs in the flame before replacing. This is, however, in most cases, a needless precaution. If the top of a plug be dusty, it is best to singe it before extraction.

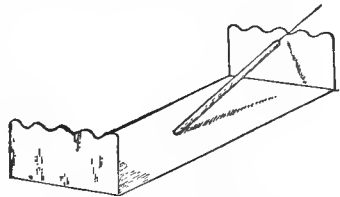

FIG. 18. — Rack for platinum needles.

THE METHODS OF THE SEPARATION OF AEROBIC ORGANISMS. *Plate-cultures.*

The general principle underlying the methods of separation is the distribution of the bacteria in one of the solid media liquefied by heat and the dilution of the mixture so that the growths produced by the individual bacteria — called colonies — shall be suitably apart. In order to render the colonies easily accessible, the medium is made to solidify in as thin a layer as possible, by being poured out on glass plates — hence the term “plate-cultures,” — or in Petri’s dishes.

As the optimum temperature varies with different bacteria, it is necessary to use both gelatin and agar media. Many pathogenic organisms, *e.g.* pneumococcus, *B. diphtheriæ*, etc., grow too slowly on gelatin to allow its ready use. On the other hand, many organisms, *e.g.* some occurring in water, do not develop on agar incubated at 37° C.

Separation by Gelatin Media. — As the naked-eye and microscopic appearances of colonies are often very characteristic, plate-cultures, besides use in separation, are often taken advantage of in the description of individual organisms. The plate-culture method can also be used to test whether a tube-culture is or is not pure. The suspected culture is plated (three plates being prepared, as will be described). If all the colonies are the same, then the cultures may be held to be pure.

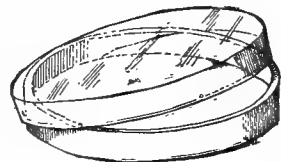

FIG. 19. — Petri’s capsule or dish. (Cover shown partially raised.)

Either simple plates of glass 4 inches by 3 inches are used, or, what are more convenient, circular glass cells with similar overlapping covers. The latter are known as Petri's dishes or capsules (Fig. 19). They are usually 3 inches in diameter and half an inch deep. The advantage of these is that they do not require to be kept level by a special apparatus while the medium is solidifying, and can be readily handled afterwards without admitting impurities. Whether plates or Petri dishes are used, they are washed, dried with a clean cloth, and sterilised for one hour in dry air at 170° C., the plates being packed in sheet-iron boxes made for the purpose (see Fig. 20).

1. *Petri's Dishes.* — While in certain circumstances, as when the number of colonies has to be counted, it is best to use plates of glass, in the usual laboratory routine Petri's dishes are to be preferred for the above reasons.

The contents of three gelatin tubes, marked *a*, *b*, *c*,¹ are liquefied by placing in a beaker of water at any temperature between 25° C. and 38° C. Inoculate *a* with the bacterial mixture. The amount of the latter to be taken varies, and can only be regulated by experience. If the microscope shows enormous numbers of different kinds of bacteria present, just as much as adheres to the point of a straight platinum needle is sufficient. If the number of bacilli is small, one to three loops of the mixture may be transferred to the medium. Shake *a* well, but not so as to cause many fine air-bubbles to form. Transfer two loops of gelatin from *a* to *b*. Shake *b* and transfer two loops to *c*. The plugs of the tubes are in each case replaced and the tubes returned to the beaker. The contents of the three tubes are then poured out into three dishes. In doing so the plug of each tube is removed and the mouth of the tube passed two or three times through the Bunsen flame, the tube being meantime rotated round a longitudinal axis. Any organisms on its rim are thus killed. The dishes are labelled and set aside till growth takes place.

The colonies appear as minute rounded points, whitish or variously coloured. Their characters can be more minutely studied by means of a hand-lens or by inverting the dish on the stage of a microscope and examining with a low power

¹ For marking glass vessels it is convenient to use the red, blue, or yellow wax pencils made for the purpose by Faber.

through the bottom. From their characters, colour, shape, contour, appearance of surface, liquefaction or non-liquefaction of the gelatin, etc., the colonies can be classified into groups. Further aid in the grouping of the varieties is obtained by making film preparations and examining them microscopically. Gelatin or agar tubes may then be inoculated from a colony of each variety, and the growths obtained are then examined both as to their purity and as to their special characters, with a view to their identification (p. 112).

2. *Glass Plates* (Koch).—When plates of glass are to be used, an apparatus on which they may be kept level while the medium is solidifying, is, as has been said, necessary. An apparatus devised by Koch is used (Figs. 20, 21). This consists of a circular plate of glass (with the upper surface ground, the lower polished) on which the plate used for pouring out the medium is placed.

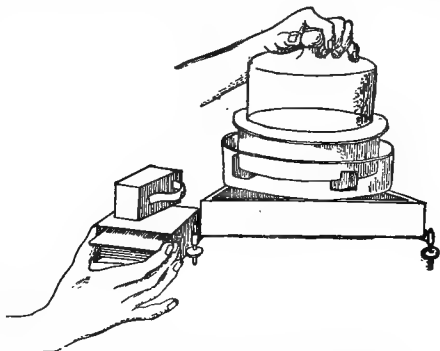

FIG. 20.—Koch's levelling apparatus for use in preparing plates. Hands shown in first position for transferring sterile plate from iron box to beneath bell-jar, where it subsequently has the medium poured out upon it.

The latter is protected from the air during solidification by a bell-jar. The circular plate and bell-jar rest on the flat rim of a circular glass trough, which is filled quite full with a mixture of ice and water, to facilitate the lowering of the temperature of whatever is placed beneath the bell-jar. The glass trough rests on corks on the bottom of a large circular trough, which catches any water that may be spilled. This trough in turn rests on a wooden triangle with a foot at each corner, the height of which can be adjusted, and which thus constitutes the levelling apparatus. A spirit level is placed where the plate is to go, and the level of the ground-glass plate thus assured. There is also prepared a "damp chamber," in which the plates are to be stored after being made. This consists of a circular glass trough with a similar cover. It is sterilised by being washed outside and inside with perchloride of mercury 1-1000, and a circle of filter paper moistened with the

same is laid on its bottom. Glass benches on which the plates may be laid are similarly purified.

To separate organisms by this method three tubes, *a*, *b*, *c*, are inoculated as in using Petri's dishes. The hands having been washed in perchloride of mercury 1-1000 and dried, the plate-box is opened, and a plate lifted by its opposite edges and transferred to the levelled ground glass (as in Figs. 20, 21). The bell-jar of the leveller being now lifted a little, the gelatin in tube *a* is poured out on the surface of the sterile plate, and while still fluid is spread by stroking with the rim of the tube. After the medium solidifies, the plate is transferred to the moist chamber as rapidly as possible, so as to avoid atmospheric contamination. In doing

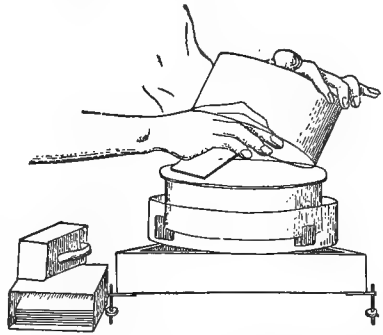

FIG. 21. — Koch's levelling apparatus. Hands shown in second position just as the plate is lowered on to the ground-glass surface. By executing the transference of the plate from the box in this way, the surface which was undermost in the latter is uppermost in the leveller, and thus never meets a current of air which might contaminate it.



FIG. 22. — Esmarch's tube for roll-culture.

ing this, it is advisable to have an assistant to raise the glass covers. Tubes *b* and *c* are similarly treated, and the resulting plates stacked in series on the top of *a*. The chamber is labelled and set aside for a few days till the colonies appear in the gelatin plates. The further procedure is of the same nature as with Petri's dishes.

3. *Esmarch's Roll Tubes*. — Here the principle is that of dilution as before. In each of three test-tubes $1\frac{1}{4}$ or $1\frac{1}{2}$ inch in diameter, gelatin to the depth of $\frac{1}{2}$ of an inch is placed. These are sterilised. The gelatin is melted and inoculated in series with the bacterial mixture as in making plate-cultures, but instead of being poured out it is rolled in a nearly horizontal position under a cold tap or on a block of ice, as devised by Booker, till it solidifies as a uniformly thin layer on the inside of the tube.

Practically we deal with a cylindrical plate of gelatin instead of a flat one. A convenient form of tube for this method is one

with a constriction a short distance below the plug of cotton wool (Fig. 22). The great disadvantage of the method is, that if organisms liquefying the gelatin be present, the liquefied gelatin contaminates the rest of the gelatin.

Separation by Agar Media. — 1. *Agar Plates.* — The only difference between the technique here and that with gelatin depends on the difference in the melting-points of the two media. Agar, we have said, melts at 98° C., and becomes again solid a little under 40° C. As it is dangerous to expose organisms to a temperature above 42° C., it is necessary in preparing tubes of agar to be used in plate-cultures to first melt the agar, by boiling in a vessel of water for a few minutes, and then to cool them to about 42° C. before inoculating. The manipulation must be rapidly carried out, as the margin or time, before solidification occurs, is narrow; otherwise the details are the same as for gelatin. Esmarch's tubes are not suitable for use here, as the agar does not adhere well to the sides. If to the agar 2 per cent of a strong watery solution of pure gum arabic is added, Esmarch's tubes may, however, be used.

2. *Separation by Stroking Mixture on Surface of Agar Media.* — The bacterial mixture, instead of being mixed in the medium, is spread out on its surface. The method may be used both when the bacteria to be separated are in a fluid, and when contained in a fairly solid tissue or substance, such as a piece of diphtheritic membrane. In the case of a tissue, for example, a small proportion entangled in the loop of a platinum needle is stroked in successive parallel longitudinal strokes on sloped agar, the same aspect being brought in contact with the agar in all the strokes. Three strokes may be made on each tube, and three tubes are usually sufficient. In this process the organisms on the surface of the tissue are gradually rubbed off, and when growth has taken place it will be found that in the later strokes the colonies are less numerous than in the earlier, and sufficiently far apart to enable parts of them to be picked off without the needle touching any but one colony. When, as in the case of diphtheritic membrane, putrefactive organisms are likely to be present on the surface of the tissue, these can be in great part removed by washing it well in cold water previously sterilised (*vide* "Diphtheria"). In the case of liquids, the loop is charged and similarly stroked. Tubes thus inoculated must be put in

the incubator in the upright position and must be handled carefully so that the condensation water, which always is present in incubated agar tubes, may not run over the surface. Agar, poured out in a Petri's dish and allowed to stand till firm, may be used instead of successive tubes. Here a sufficient number of strokes can be made in one dish. Sloped blood-serum tubes may be used instead of agar. The method is rapid and easy and gives good results.

Separation of Pathogenic Bacteria by Inoculation of Animals. — It is found difficult and often impossible to separate by ordinary plate methods certain pathogenic organisms, such as *B. tuberculosis*, *B. mallei*, and the pneumococcus, when such occur in conjunction with other bacteria. These grow best on special media, and the first two (especially the tubercle bacillus) grow so slowly that the other organisms present outgrow them, cover the whole plates, and make separation impossible. The method adopted in such cases is to inoculate an animal with the mixture of bacilli, wait until the particular disease develops, kill the animal, and with all aseptic precautions (*vide* p. 120) inoculate tubes of suitable media from characteristic lesions situated away from the seat of inoculation, *e.g.* from spleen in the case of *B. tuberculosis*, spleen or liver in the case of *B. mallei*, and heart blood in the case of pneumococcus.

Separation by killing Non-spored Forms by Heat. — This is a method which has a limited application. As has been said, the spores of a bacterium resist heat more than the vegetative forms. When a mixture contains spores of one bacterium and vegetative forms of this and other bacteria, then if the mixture be boiled for a few minutes all the vegetative forms will be killed, while the spores will remain alive and will develop subsequently. This method can be easily tested in the case of cultivating *B. subtilis* from hay infusion. A little chopped-up hay is placed in a flask of water, which is boiled for about ten minutes. On this being allowed to cool and stand, in a day or two a scum forms on the surface, which is found to be a pure culture of the bacillus *subtilis*. The method is also often used to aid in the separation of *B. tetani*, *vide infra*.

THE PRINCIPLES OF THE CULTURE OF ANAEROBIC ORGANISMS.

All ordinary media, after preparation, may contain traces of free oxygen, and will absorb more from the air on standing. For the growth of anaerobes this oxygen may be gotten rid of in two ways. (1) By the prolonged passing of an inert gas, such as hydrogen, through the medium (liquefied if necessary), and further, the medium must be kept in an atmosphere of the same gas, while growth is going on. (2) By absorption through the use of pyrogallic acid in an alkaline solution as described by Buchner. Media for anaerobes may be kept in contact with the air, if they contain a reducing agent which does not interfere with bacterial growth. Such an agent takes up any oxygen which may already be in the medium, and prevents further absorption. The reducing body used is generally glucose, though formate of sodium may be similarly employed. The preparation of such media has already been described (pp. 38, 40). In this case the medium ought to be of considerable thickness.

The Supply of Hydrogen for Anaerobic Cultures. — The gas is generated in a large Kipp's apparatus from pure sulphuric acid and pure zinc.

It is passed through three wash-bottles, as in Fig. 23. In the first is placed a solution of lead acetate (1 in 10 of water) to remove any traces of sulphuretted hydrogen. In the second is placed a 1 in

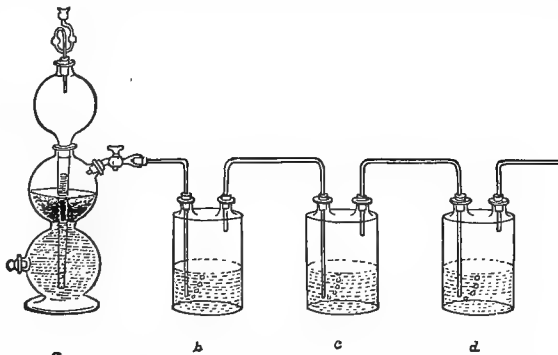

FIG. 23. — Apparatus for supplying hydrogen for anaerobic cultures.

a. Kipp's apparatus for manufacture of hydrogen. *b.* Wash-bottle containing 1-10 solution of lead acetate. *c.* Wash-bottle containing 1-10 solution of silver nitrate. *d.* Wash-bottle containing 1-10 solution of pyrogallic acid. (*b, c, and d* are intentionally drawn to a larger scale than *a* to show details.)

10 solution of silver nitrate to remove any arseniatted hydrogen which may be present if the zinc is not quite pure. In the third is a 10 per cent solution of pyrogallic acid in caustic potash solution (1 : 10) to remove any traces of oxygen. The tube lead-

ing from the last bottle to the vessel containing the medium ought to be sterilised by passing through a Bunsen flame, and should have a small plug of cotton wool in it to filter the hydrogen germ-free.

Separation of Anaerobic Organisms. — (a) *By Roll-tubes.* — A $1\frac{1}{4}$ inch test-tube has as much gelatin put into it as would be used in the Esmarch roll-tube method. It is corked with an india-rubber stopper having two tubes passing through it, as in Fig. 24. The ends of the tubes are partly drawn out as shown, and covered with plugs of cotton wool. Three such test-tubes are prepared, and they are sterilised in the steam steriliser (p. 31). After sterilisation the gelatin is melted and one tube inoculated with the mixture containing the anaerobes; the second is inoculated from the first, and the third from the second, as in making ordinary gelatin plates.

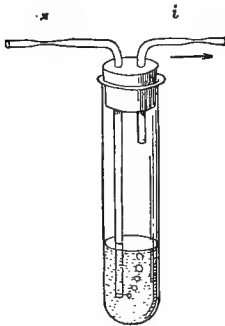

FIG. 24. — Esmarch's roll-tube adapted for culture containing anaerobes.

After inoculation the gelatin is kept liquid by the lower ends of the tubes being placed in water at about 30° C., and hydrogen is passed in through tube *x* for twenty minutes. The gas-supply tubes are then completely sealed off at *x* and *i*, and each test-tube is rolled as in Esmarch's method till the gelatin solidifies as a thin layer on the internal surface. A little hard paraffin may be run between the rim of the test-tube and the stopper, and round the perforations for the gas-supply tubes, to ensure that the apparatus is air-tight. The gelatin is thus in an atmosphere of hydrogen in which the colonies may develop. The latter may be examined and isolated in a way which will be presently described. The method is admirably suited for all anaerobes which grow at the ordinary temperature.

(b) *By Novy's and Buchner's Apparatus.* — The separation of anaerobes may be more readily carried out than in the foregoing methods by making dilutions of the bacteria in agar, glucose agar, or gelatin, and pouring into Petri's dishes and placing them in either a Novy's anaerobic jar (see Fig. 25) or in a modified Buchner apparatus. If one uses the Novy jar, the air is displaced by allowing a good stream of hydrogen gas from a Kipp generator to pass through it for at least 30

minutes before closing the cock in the top of the jar. In effecting displacement of the air it is necessary to observe to adjust the cock so that the gas enters directly into the jar from above and finds its way out through the combined rubber and glass tubing adjustment from below.

In the alternative method, use is made of an ordinary chemical desiccating jar of suitable size, 6 inches in diameter, in the lower compartment of which is placed about 150 c.c. of a 1 per cent sodium hydrate solution in which is dissolved 10 grammes of pyrogallic acid. Into the upper portion of the jar are placed the Petri's dish cultures, and at once the cover of the vessel, previously smeared with vaseline on its contact surface, is firmly affixed. These vessels are then placed for forty-eight hours in the thermostat before examining.



FIG. 25. — Novy's anaerobic jar.

(c) *By Bulloch's Apparatus for Anaerobic Culture.* — This can be recommended for plating out mixtures containing anaerobes,

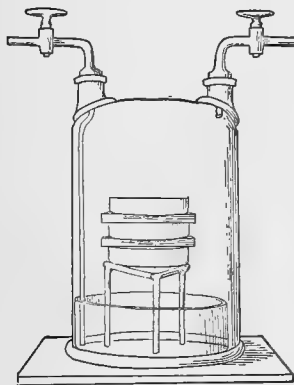

FIG. 26. — Bulloch's apparatus for anaerobic plate-cultures.

and for obtaining growths (especially surface growths) of the latter. It consists (Fig. 26) of a glass plate as base on which a bell-jar can be firmly luted down with unguentum resinæ. In the upper part of the bell-jar are two apertures furnished with ground stoppers, and through each of the latter passes a glass tube on which is a stopcock. One tube, bent slightly just after passing through the stopper, extends nearly to the bottom of the chamber; the other terminates immediately below the stopper. In using the apparatus there is set on the base-

plate a shallow dish, of slightly less diameter than that of the bell-jar, and having a little heap of from two to four grammes of dry pyrogallic acid placed in it towards one side. Culture plates made in the usual way can be stacked on a frame of glass rods

resting on the edges of the dish, or a beaker containing culture tubes can be placed in it. The bell-jar is then placed in position so that the longer glass tube is situated over that part of the bottom of the shallow dish farthest away from the pyrogallic acid, and the bottom and stoppers are luted. The air in the bell-jar is now expelled by passing a current of coal-gas through the short glass tube, and both stoppers are closed. A partial vacuum is then effected in the jar by connecting the short tube up with an air-pump, opening the tap, and giving a few strokes of the latter. A solution of 7 grammes solid caustic potash dissolved in 145 c.c. water is made, and into the vessel containing it a rubber tube connected with the long glass tube is made to dip, and the stopper of the latter being opened, the fluid is forced into the chamber, spreads over the bottom of the shallow dish, and, coming in contact with the acid, sodium pyrogallate is formed which absorbs any free oxygen still present. Before the whole of the fluid is forced in, the rubber tube is placed in a little water, and this, passing through the glass tubes, washes out the soda and prevents erosion of the glass. The whole apparatus may be placed in the incubator till growth occurs.

It is often advisable in dealing with material suspected to contain anaerobes to inoculate an ordinary deep glucose agar tube with it, and incubating for 24 or 48 hours, to then apply an anaerobic separation method to the resultant growth. Sometimes the high powers of resistance of spores to heat may be taken advantage of in aiding the separation (*vide* "Tetanus").

Cultures of Anaerobes. — When by one or other of the above methods separate colonies have been obtained, growth may be maintained on media in contact with ordinary air. The media generally used are those which contain reducing agents, and the test-tubes containing the medium must be filled to a depth of 4 inches. They are sterilised as usual and are called "deep" tubes. The long straight platinum wire is used for inoculating, and it is plunged well down into the "deep" tube. A little air gets into the upper part of the needle track, and no growth takes place there, but in the lower part of the needle track growth occurs. From such "deep" cultures growths may be maintained indefinitely by successive sub-cultures in similar tubes. Even ordinary gelatin and agar can be used in the same way if the medium is heated to boiling-point before use to expel any absorbed oxygen.

Cultures of Anaerobes in Liquid Media. — It is necessary to employ such in order to obtain the toxic products of the growth of anaerobes. Glucose

broth is most convenient. It is placed either (1) in a conical flask with a lateral opening and a perforated india-rubber stopper, through which a bent glass tube passes, as in Fig. 27, *a*, by which hydrogen may be delivered, or (2) in a conical flask with a rubber stopper furnished with two holes, as in Fig. 27, *b*, through a tube in one of which hydrogen is

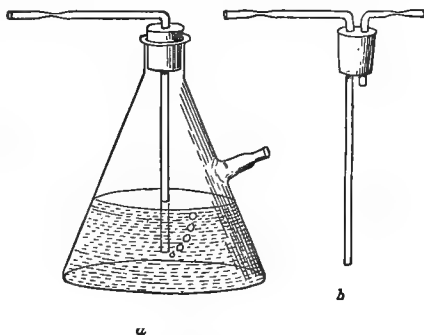

FIG. 27.

a. Flask for anaerobes in liquid media. Lateral nozzle and stopper fitted for hydrogen supply. *b.* A stopper arranged for a flask without lateral nozzle.

delivered, while through the tube in the other the gas escapes. The inner end of the gas delivery tube must in either case be below the surface of the liquid; the inner end of the lateral nozzle in the one case, and the inner end of the escape tube in the other, must of course be above the surface in the liquid. The single tube in the one case and the two tubes in the other ought to be partially drawn out in a flame to facilitate subsequent complete sealing. The ends of the tubes through which the gas is to pass are previously protected by pieces of cotton wool tied on them. It is well previously to place in the tube, through which the hydrogen is to be delivered, a little plug of cotton wool. The flask being thus prepared, it is sterilised by methods B (2)-or B (3). On cooling it is ready for inoculation. In the case of the flask with the lateral nozzle, the cotton-wool covering having been momentarily removed a wire charged with the organism is passed down to the bouillon. In the other kind of flask the stopper must be removed for an instant to admit the wire. The flask is then connected with the hydrogen apparatus by means of a short piece of sterile india-rubber tubing, and hydrogen is passed through for half an hour. In the case of flask (1), the lateral nozzle is plugged with molten paraffin covered with alternate layers of cotton wool and paraffin, the whole being tightly bound on with string. The entrance tube is now completely drawn off in the flame before being discon-

nected from the hydrogen apparatus. In the case of flask (2), first the exit tube and then the entrance tube are sealed off in the flame before the flask is disconnected from the hydrogen apparatus. It is well in the case of both flasks to run some melted paraffin all over the rubber stopper. Sometimes much gas is evolved by anaerobes, and in dealing with an organism where this will occur, provision must be made for its escape. This is conveniently done by leading down the exit tube, and letting the end just dip into a trough of mercury (Fig. 28), or into mer-

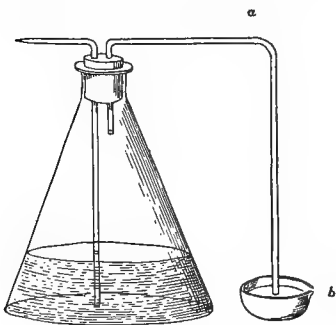

FIG. 28. — Flask arranged for culture of anaerobes which develop gas.

b is a trough of mercury into which exit tube dips.

cury in a little bottle tied on to the end of the exit tube. The pressure of gas within causes an escape at the mercury contact, which at the same time acts as an efficient valve. The method of culture in fluid media is used to obtain the soluble products of such anaerobes as the tetanus bacillus.

Dr. W. H. Park of New York has recently introduced a very simple method for making anaerobic cultures in fluid media.

An Erlenmeyer flask containing a suitable quantity of medium is boiled in a water bath for ten or fifteen minutes, to drive off all dissolved oxygen, then rapidly cooled down and inoculated. Hot melted paraffin is now poured into the flask until it reaches a depth of 2 or 3 mm., and upon solidifying it forms a perfect seal, excluding the air completely, yet not adhering to the glass so strongly as to prevent escape of gases should any be formed by the growing anaerobes.

Wright's Method of Anaerobic Culture. — Utilising Buchner's pyrogallic acid medium for the removal of oxygen, Wright has contrived two very ingenious methods for anaerobic culture in ordinary test-tubes. In the first method, which is applicable to both solid and fluid media (Fig. 29), after inoculating, the cotton plug, always made of absorbent cotton, is cut off flush with the extremity of the tube, and pushed inwards to a distance of 1 cm. It is then impregnated with 1 c.c. of a watery solution of pyrogallic acid (freshly prepared by adding to one part of water an

approximately equal bulk of pyrogallic acid), and adding to that 1 c.c. of a 5 per cent solution of sodium hydrate. A rubber stopper is next tightly fitted into the end of the tube, and the apparatus is then ready for incubating. The second method, suitable for fluid media only, consists of a system of soft rubber and glass tubes arranged in an ordinary culture tube, as shown in Fig. 30. The small glass tube A is drawn out slightly at both ends

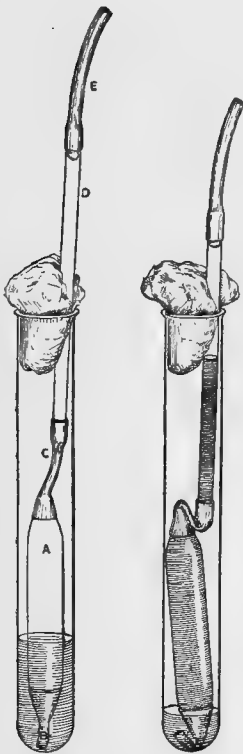

By permission, from Mallory & Wright's "Pathological Technique."

FIGS. 30, 31. — Wright's method for the cultivation of anaerobes in fluid media.

and capped by pieces of soft rubber tubing, into one of which is inserted a short length of glass tubing of a much smaller calibre than A, and which is plugged with cotton at its upper end, where a small piece of rubber tubing is affixed. Into the tube containing



By permission, from Mallory & Wright's "Pathological Technique."

FIG. 29. — Wright's method for the cultivation of anaerobes in solid media.

such an apparatus the usual quantity of bouillon is poured, and the whole is sterilised by steam, care being taken that the rubber portions are not bent. To prepare a culture it is advisable to boil the broth over a free flame before inoculating, so as to drive off as much dissolved oxygen as possible, then immerse the tube in cold water. When

cool, inoculate the bouillon and suck it up into the system of tubes well above C, then, pinching E between the fingers to

prevent back flow of the fluid, press downwards so as to buckle up the tubing at B and C (Fig. 31). This forms both a water and air tight compartment in A, and readily allows anaerobic growth.

When it is desired to grow anaerobes on the surface of a solid medium such as agar, tubes of the form shown in Fig. 32,

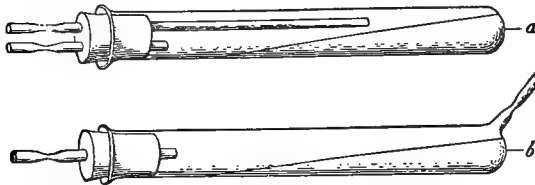

FIG. 32. — Tubes for anaerobic cultures on the surface of solid media.

a and *b*, may be used. A stroke culture having been made, the air is replaced by hydrogen as just described, and the tubes are

fused at the constrictions. Such a method is of great value when it is required to get the bacteria free from admixture of medium, as in the case of staining flagella. By the use of Novy's jar anaerobes may be made to grow on all media in ordinary culture tubes.

MISCELLANEOUS METHODS.

Collodion, or Celloidin Sacs. — These were introduced by Metschnikoff, Roux, and Salimbeni during their studies on the spirillum of Asiatic cholera, and further exploited by Nocard and Roux in their research upon the cause of pleuro-pneumonia of cattle. The usefulness of such a sac lies in the fact that living cultures can be introduced into the body of an animal without coming into direct contact with its tissues or body fluids, whilst their soluble products can, through the osmotic properties of the collodion, pass outwards and be absorbed by the tissues, and at the same time the animal fluids can pass within and nourish the bacteria. Thus a ready means is afforded of exalting virulence of bacteria, of producing agglutinative and other phenomena, without great difficulties being thrown in the way, such as otherwise might happen. The method used by the French investigators in making the sacs, as stated by Novy, is rather an involved and laborious proceeding, and lately a newer and easier method has been recommended by McCrae, wherein gelatin capsules are coated with collodion and the resulting sac is mounted on glass tubing and prepared for final use. McCrae's

method has been further improved upon by Harris, whose scheme is briefly given as follows:—

To the smaller end of a gelatin capsule such as is used by veterinary surgeons (Fig. 33, A), a piece of glass tubing about 4 cm. long and 3 mm. in inside diameter is affixed by gently heating the tubing and causing it to adhere (Fig. 33, B). The bore of the tubing is then cleared of obstructing gelatin, the junction of glass and gelatin is painted around with a solution of moderately thick collodion or celloidin and allowed to dry. Then the whole capsule is dipped in the solution, removed, and rotated so as to give a perfectly even coating to the capsule. When set, the capsule is allowed to thoroughly dry, and if necessary is again coated and dried, and is reinforced at three points (Fig. 33, C) and once more dried. The gelatin is removed by filling up the capsule with water by means of a fine bore pipette of the Pasteur type, and boiled a couple of minutes in a pan of water, then the gelatin is sucked out by means of the pipette and the sac is refilled with bouillon. Sterilisation is effected by placing the sac in

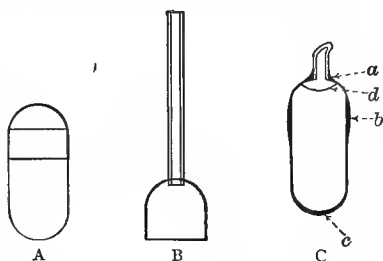

FIG. 33.

A. Empty gelatin capsule, actual size. "No. 12 Veterinary," P. D. & Co.

B. Glass tube sealed into end of capsule.

C. Sac ready for insertion. *a*, *b*, *c*, points of reinforcement; *d*, limit for height of the column of fluid inside.

a tube of broth, sac end uppermost, with enough broth in it to cover the sac to the depth of 1 cm., and either autoclaving for five minutes under one atmosphere pressure or by steaming for three successive days in the Arnold steriliser. The sac is inoculated by first removing some of its contents (Fig. 33 C) under aseptic conditions, and then introducing a small quantity of the desired bacterium in suspension, or in fluid culture, by means of a sterile pipette; it is then to be seized with sterilised forceps by the glass shank, and the latter brought in contact with the small flame of a blast lamp and sealed off (see Fig. 33, C). The inoculated sac is next to be tested for tightness by incubating it in a bouillon culture tube, after first washing it thoroughly with sterile water to remove any organisms which may have alighted upon it during the exposure to the air

consequent upon inoculating and sealing procedures; if after incubation no growth occurs in the broth outside the capsule, it is then ready for insertion into the abdominal cavity of the animal.

Hanging-drop Cultures. — It is often necessary to observe micro-organisms alive, either to watch the method and rate of their multiplication, or to investigate whether or not they are motile. This is effected by making hanging-drop cultures. The method in the form to be described is only suitable for aerobes. For this special slides are necessary. Two forms are in use and are shown in Fig. 34. In A there is ground out on one surface

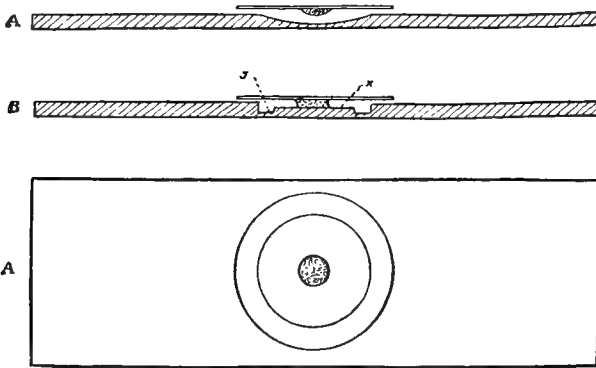

FIG. 34.

A, A. Hollow-ground slide for hanging-drop cultures shown in plan and section.
B. Another form of slide for similar cultures.

a hollow having a diameter of about half an inch. That shown in B explains itself. The slide to be used and a cover-glass are sterilised by hot air in a Petri's dish, or simply by being heated in a Bunsen and laid in a sterile Petri to cool. In the case of A one or other of two manipulation methods may be employed. (1) If the organism be growing in a liquid culture, a loop of the liquid is placed on the middle of the under surface of the sterile cover-glass, which is held in forceps, the points of which have been sterilised in a Bunsen flame. If the organism be growing in a solid medium, a loopful of sterile bouillon is placed on the cover-glass in the same position, and a *very* small quantity of the culture (picked up with a platinum needle) is rubbed up in the bouillon. The edge of the hollow is smeared with vaseline, or immersion oil, the cover is then carefully lowered over the

cell on the slide, the drop not being allowed to touch the wall or the edge of the cell, and the preparation is then complete and may be placed under the microscope. If necessary, it may be first incubated and then examined on a warm stage. (2) The sterile cover-glass is placed on a sterile plate (an ordinary glass plate used for plate-cultures is convenient). The drop is then placed on its *upper* surface, the details being the same as in the last case. The edge of the cell in the slide is then painted with vaseline, and the slide, held with the hollow surface downwards, is lowered on to the cover-glass, to the rim of which it of course adheres. The slide with the cover attached is then quickly turned right side up, and the preparation is complete.

In the case of B the drop of fluid is placed on the centre of the table *x*. The drop must be thick enough to come in contact with the cover-glass when the latter is lowered on the slide, and not large enough to run over into the surrounding trench *y*. The cover-glass is then lowered on to the drop, and vaseline is painted along the margin of the cover-glass. The method of microscopic examination is described on page 87.

Anaerobic Hanging-drop Cultures. — The growth and examination of bacteria in hanging-drops under anaerobic conditions involve considerable difficulty, but may be carried out in an apparatus devised by Graham Brown (Fig. 35). It consists of two brass plates (*a* and *a'*) which can be approximated by screws, and which have two rounded apertures in their middle, $\frac{3}{4}$ inch in diameter. These support two rubber rings, an upper thinner one (*b*) and a lower thick one (*d*), their inner diameter being the same as that of the apertures in the plates. Between *b* and *d* is placed a stout cover-glass of suitable size (*c*); *d* is separated from the plate *a'* by a square plate of glass *e* (a portion of an ordinary glass slide for microscopical purposes does well). Two small metal tubes *f* are inserted through the rubber *d*. Method of use: Fix up the apparatus as shown above,

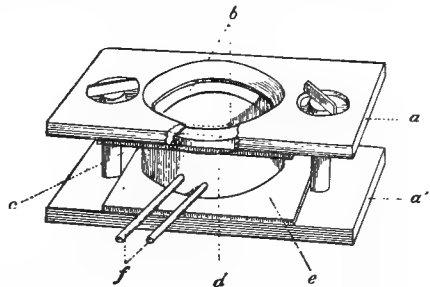

FIG. 35.—Graham Brown's chamber for anaerobic hanging-drops.

(A portion of one edge of upper plate is shown cut away.)

the screws being just tight enough to keep the parts in position, and sterilise in the steam steriliser. Screw up more firmly so as to make the rubber bulge slightly. Fill a hypodermic syringe with some sterile glucose bouillon, push the needle through the rubber *d*, and, tilting the point of the needle against the glass *c*, slowly inject enough to form a drop on the under surface of *c*. Withdraw the syringe and inoculate its point with the bacterium, again introduce and inoculate the drop. Pass hydrogen through one of the tubes for fifteen minutes, close the ends of the tubes, and incubate at the required temperature. The apparatus can be put on the stage of a microscope and examined from time to time.

Hanging-block Cultures. — Applying the principle of the hanging-drop culture to solid media, Hill has introduced a new method for the more accurate study of the morphology and development of bacteria, which is equally applicable to aerobic or anaerobic forms. Ordinary plain agar is melted down and poured into a Petri's dish to the depth of one-quarter of an inch and solidified; a piece is then cut out of it about one-quarter or one-third of an inch square and affixed to a sterile slide. The upper surface of this block is then inoculated with a bouillon culture of the selected organism in the manner of making a cover-slip preparation, and the whole is covered with a small sterile dish and set in the thermostat to dry for five or ten minutes. This step being completed, a sterile cover-slip is placed upon the inoculated surface, avoiding as far as possible the imprisonment of air-bubbles, and cemented down with melted agar by means of a platinum loop. The cover-slip with the agar block is now to be removed from the slide and sealed to a moist chamber with paraffin; the preparation can now be studied at room temperature, or transferred to a warm stage. For the observation of anaerobes an alkaline solution of pyrogallol may be introduced into the moist chamber, which is then made air-tight.

Thermal Death-point Test. — It is sometimes necessary to determine the death-point of a bacterium by exposure to moist heat. This is most accurately performed by the aid of Sternberg's glass bulbs made in the fashion shown in Fig. 36. A twenty-four-hour-old broth culture of the given bacterium, prepared beforehand, is to be poured out into a sterile Petri's dish,

then having taken a bulb and sterilised the point and broken it off with sterile forceps, the bulbous end is to be rapidly passed through the flame of a Bunsen burner four or five times to expel some of the air, and the sterile point of the shank is to be dipped into the fluid in the dish, and as the bulb cools the fluid runs slowly up the shank and falls into the bulb below. It is well not to fill the bulb more than one-quarter,



FIG. 36.—Sternberg's bulb adapted for thermal death-point test.

as a great bulk of fluid is to be avoided, interfering as it does with the delicacy of the test. Removing the bulb from the fluid, its point is carefully sealed in the flame and it is then deposited in a small galvanised sheet-iron box perforated with many small holes, or into a stout, finely meshed wire box; both bulb and box are then to be placed in a water bath with enough water in it to submerge the box to the depth of at least one inch, and kept for the required time at a constant temperature. [In testing vegetative forms of bacteria, it is recommended to begin with an exposure of five minutes at 50° C., then ten minutes at 50° C., and so on, for every five succeeding degrees up to 65°. Spores are tested in boiling water with exposures varying from one minute up to twenty, or more.] After conditions of time and temperature have been fulfilled, the bulb is removed, the shank wiped dry, the point broken off by forceps under sterile precautions, and the shank grasped by the forceps near the bulb, which is now held uppermost so as to permit of the ready discharge of the contents. This step is accomplished by introducing the shank of the bulb into a tube of previously melted agar, whose temperature is 42° C., and, bringing the upper empty end of the bulb near to the lowermost portion of Bunsen flame, expansion of the air at once drives the contents into the agar, when they are to be well mixed and poured into a sterile Petri's dish, and incubated for 72 hours, and examined for evidences of growth.* Caution must be observed in expelling the contents of the bulb, lest the flame come into direct contact and vitiate the experiment.

The Counting of Colonies. — An approximate estimate of the number of bacteria present in a given amount of a fluid (say, water) can be arrived at by counting the number of colonies

which develop when that amount is added to a tube of suitable medium, and the latter plated and incubated. An ordinary plate should be used in such a case, and the medium poured out in as rectangular a shape as possible. For the counting, an apparatus such as is shown in Fig. 37 is employed. This consists of a sheet of glass ruled into squares as indicated, and supported by its corners on wooden blocks.

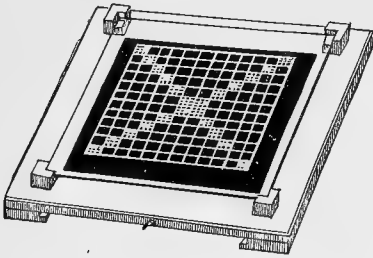

FIG. 37.—Apparatus for counting colonies (Wolf hügels).

The table to which these blocks are attached has a dark surface. The plate-culture containing the colonies is laid on the top of the ruled glass. The number of colonies in, say, twenty of the smaller squares, is then counted, and an average struck. The total number of squares covered by the medium is then taken, and by a simple calculation the total number of colonies present can be obtained. Plate-cultures in Petri's dishes are sometimes employed for purposes of counting. The bottoms of such dishes are, however, never flat, and the thickness of the medium thus varies in different parts. If these dishes are to be used, a circle of the same size as the dish can be drawn with Chinese white on a black card, the circumference divided into equal arcs, and radii drawn. The dish is then laid on the card, the number of colonies in a few of the sectors counted, and an average struck as before. In counting colonies it is always best to aid the eye with a small hand-lens.

The Bacteriological Examination of the Blood. —(a) This may be done by taking a small drop from the skin surface, *e.g.* the lobe of the ear. The part should be thoroughly washed with 1-1000 corrosive sublimate and dried with sterile cotton wool. It is then washed with absolute alcohol to remove the antiseptic, drying being allowed to take place by evaporation. A prick is then made with a sterile surgical needle; the drop of blood is caught with a sterile platinum loop and smeared on the surface of agar or blood serum. Film preparations for microscopic examination may be made at the same time. It is rare to obtain growths from the blood of the human subject

The Bacteriological Examination of the Blood. —(a) This may be done by taking a small drop from the skin surface, *e.g.* the lobe of the ear. The part should be thoroughly washed with 1-1000 corrosive sublimate and dried with sterile cotton wool. It is then washed with absolute alcohol to remove the antiseptic, drying being allowed to take place by evaporation. A prick is then made with a sterile surgical needle; the drop of blood is caught with a sterile platinum loop and smeared on the surface of agar or blood serum. Film preparations for microscopic examination may be made at the same time. It is rare to obtain growths from the blood of the human subject

under such conditions (*vide* special chapters), and if colonies appear the procedure should be repeated to exclude the possibility of accidental contamination.

(*b*) But when it is possible a much greater quantity of blood should be obtained to make the examination of any real value. A vein at the bend of the elbow affords the readiest opportunity of getting blood. One proceeds as follows: A bandage is applied tightly around the middle third of the upper arm, and the skin over the selected area is rendered as aseptic as possible by scrubbing with hot water and soap, washing off the soap with sterile water, wiping with alcohol and ether, and rubbing well with bichloride of mercury, 1-1000. Then the operator, having disinfected his hands, enters a swollen vein with the point of a syringe of 10-15 c.c. capacity and withdraws not less than 10 c.c. of blood. The puncture made by the syringe is closed with sterile absorbent cotton and collodion. The blood must be quickly distributed amongst six tubes of melted agar and plated, or divided between five flasks containing 150-200 c.c. of sterile broth, and these incubated for two or three days and then subjected to study.

In examining the blood of the *spleen* a portion of the skin over the organ is sterilised in the same way, a few drops are withdrawn from the organ by a sterile hypodermic syringe and cultures made. (For microscopic methods, *vide* p. 88 *et seq.*)

Bacteriological Examination of the Cerebro-spinal Fluid—Lumbar Puncture.—This diagnostic procedure, which is sometimes called for in cases of meningitis, can be carried out with a sterilised “antitoxin needle” as follows: The patient should lie on the right side, with knees somewhat drawn up and left shoulder tilted somewhat forward, so that the back is fully exposed. The skin over the lumbar region is then carefully sterilised, as above described, and the hands of the operator should be similarly treated. The spines of the lumbar vertebræ having been counted, the left thumb or forefinger is pressed into the space between the 3rd and 4th spines in the middle line; the needle is then inserted about half an inch to the right of the middle line at this level and pushed through the tissues, its course being directed slightly inwards and upwards, till it enters the sub-arachnoid space. When this occurs fluid passes along the needle, sometimes actually spurting out, and should be

received in a sterile test-tube. Several cubic centimetres of fluid can thus usually be obtained, no suction being required; thereafter it can be examined bacteriologically by the usual methods. The depth of the sub-arachnoid space from the surface varies from a little over an inch in children to three inches, or even more, in adults — the length of the needle must be suited accordingly. In making the puncture it is convenient to have either a sterile syringe attached, or to have the thick end of the needle covered with a pad of sterile wool, which is of course removed at once when the fluid begins to flow.

The Bacteriological Examination of Urine. — In such an examination care must be taken to prevent the contamination of the urine by extraneous organisms. In the male it is usually sufficient to wash thoroughly the glans penis and the meatus with 1-1000 corrosive sublimate — the tips of the meatus being everted for more thorough cleansing. The urine is then passed into a series of sterile flasks, the first of which is rejected in case contamination has occurred. In the female, after similar precautions as regards external cleansing, the catheter must be used. The latter must be boiled for half an hour, and anointed with olive oil sterilised by half an hour's exposure in a plugged flask to a temperature of 120° C. Here, again, it is well to reject the urine first passed. It is often advisable to allow the urine to stand in a cool place for some hours, to then withdraw the lower portion with a sterile pipette, to centrifugalise this, and to use the urine in the lower parts of the centrifuge tubes for microscopic examination or culture.

Filtration of Cultures. — For many purposes it is necessary to filter all the organisms from fluids in which they may have been growing. This is especially done in obtaining the soluble toxic products of bacteria. The only filter capable of keeping back such minute bodies as bacteria is that formed from a tube of unglazed porcelain as introduced by Chamberland. The efficiency of such a filter depends on the fineness of the grain of the clay from which it is made; the finest is the Kitasato filter and the Chamberland "B" pattern; the next finest is the Chamberland "F" pattern, which is quite good enough for ordinary work. There are several filters, differing slightly in detail, all possessing the common principle. Sometimes the fluid is forced through the porcelain tube. In one form the

filter consists practically of an ordinary tap screwed into the top of a porcelain tube. Through the latter the fluid is forced and passes into a chamber formed by a metal cylinder which surrounds the porcelain tube. The fluid escapes by an aperture at the bottom. Such a filter is very suitable for domestic use, or for use in surgical operating-theatres. As considerable pressure is necessary, it is evident it must be put on a pipe leading directly from the main. Sometimes, when fluids to be filtered are very albuminous, they are forced through a porcelain cylinder by compressed carbonic acid gas. In ordinary bacteriological work, however, it is usually more convenient to suck the fluid through the porcelain by exhausting the air in the receptacle into which it is to flow. This is conveniently done by means of a Geissler's water-exhaust pump (Fig. 38, *g*), which must be fixed to a tap leading directly from the main. The connection with the tap must be effected by means of a piece of thick-walled rubber tubing as short as possible, wired on to tap and pump, and firmly lashed externally with many turns of strong tape. Before lashing with the tape the tube may be strengthened by fixing round it with rubber solution strips of the rubbered canvas used for mending punctures in the outer case of a bicycle tire.

A manometer tube *b* and a receptacle *c* (the latter to catch any back flow of water from the pump if the filter accidentally breaks) are intercepted between the filter and the pump. These are usually arranged on a board *a*, as in Fig. 38. Between the tube *f* and the pump *g*, and between the tube *d* and the filter, it is convenient to insert lengths of flexible lead tubing connected up at each end with short, stout-walled rubber tubing.

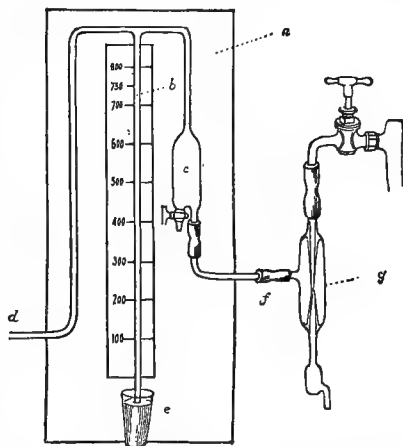

FIG. 38.—Geissler's vacuum-pump arranged with manometer for filtering cultures. (The tap and pump are intentionally drawn to a larger scale than the manometer board to show details.)

Various modifications of the filter are used. (*a*) An apparatus

Various modifications of the filter are used. (*a*) An apparatus

is arranged as in Fig. 39. The fluid to be filtered is placed in the cylindrical vessel *a*. Into this a "candle" or "bougie" of

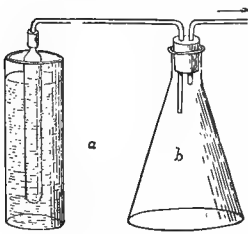

FIG. 39.—Chamberland's candle and flask arranged for filtration.

porcelain dips. From the upper end of the bougie a glass tube with thick rubber connections, as in Fig. 39, proceeds to flask *b* and passes through one of the two perforations with which the rubber stopper of the flask is furnished. Through the other opening a similar tube proceeds to the exhaust-pump. When the latter is put into action the fluid is sucked through the porcelain and passes over into flask *b*.

This apparatus is very good, but not suitable for small quantities of fluid.

(*b*) A very good apparatus can be arranged with a lamp funnel and the porcelain bougie. These may be fitted up in two ways. (1) An india-rubber washer is placed round the bougie *c* at its glazed end (*vide* Fig. 40). On this the narrow end of the funnel *d*, which must, of course, be of an appropriate size, rests. A broad band of sheet

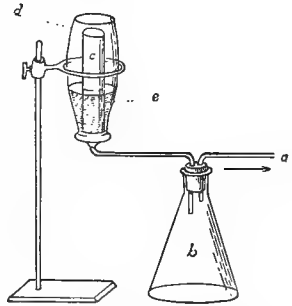

FIG. 40.—Chamberland's bougie arranged with lamp funnel for filtering a small quantity of fluid.

rubber is then wrapped round the lower end of the funnel and the projecting part of the bougie.

It is firmly wired to the funnel above and to the bougie below. The extreme point of the latter is left exposed, and the whole apparatus, being supported on a stand, is connected by a glass tube with the lateral tube of the flask *b*; the tube *a* is connected with the exhaust-pump. The fluid to be filtered is placed between the funnel and the bougie in the space *e*, and is sucked through into the flask *b*.

(2) This modification is shown in Fig. 41. Into the narrow part of the funnel an india-rubber stopper is fitted, which has a perforation in it

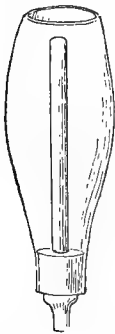

FIG. 41.—Bougie inserted through rubber stopper for same purpose as in Fig. 39.

sufficiently large to receive the candle, which it should grasp tightly.

(c) Muencke's modification of the Chamberland principle is seen in Fig. 42. It consists of a thick-walled flask, *a*, the lower part conical, the upper cylindrical, with a strong flange on the lip. There are two lateral tubes, one horizontal to connect with exhaust-pipe, and one sloping, by which the contents may be poured out. Passing into the upper cylindrical part of the flask is a hollow porcelain cylinder *b*, of less diameter than the cylindrical part of flask *a*. It is closed below, open above, and rests by a projecting rim on the flange of the flask, an asbestos washer, *c*, being interposed. The fluid to be filtered is placed in the porcelain cylinder, and the whole top covered, as shown at *f*, with an india-rubber cap with a central perforation; the tube *d* is connected with the exhaust-pump and the tube *e*

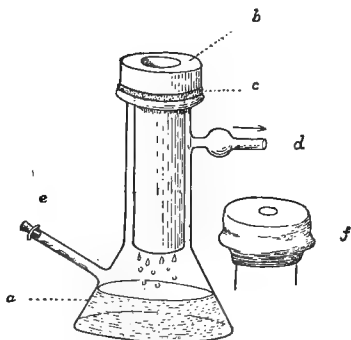

FIG. 42.—Muencke's modification of Chamberland's filter.

plugged with a rubber stopper. When a large quantity of fluid is to be filtered, a receptacle such as that shown in Fig. 43 may be used. The tap in its bottom enables the filtrate to be removed without the apparatus being unshipped, but it is difficult to get the tap to fit so accurately as not to allow air to pass into the vacuum chamber.

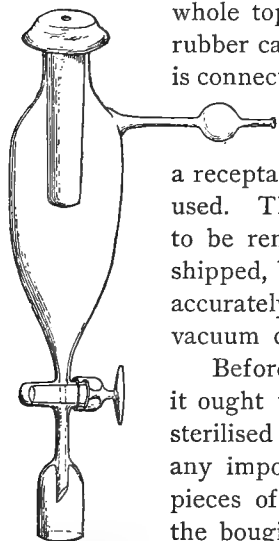

FIG. 43.—Flask fitted with porcelain bougie for filtering large quantities of fluid.

Before any one of the above apparatus is used, it ought to be connected up as far as possible and sterilised in the Koch's steriliser. The ends of any important unconnected parts ought to have pieces of cotton wool tied over them. After use the bougie is to be sterilised in the autoclave, and after being dried is to be passed carefully through a Bunsen flame, to burn off all organic matter. If the latter is allowed to accumulate, the pores become filled up.

The success of filtration must be tested by inoculating tubes of media from the filtrate, and observing if growth takes place,

as there may be minute perforations in the candles sufficiently large to allow bacteria to pass through. Filtered fluids keep for a long time if the openings of the glass vessels in which they are placed are kept thoroughly closed, and if these vessels be kept in a cool place in the dark. A layer of sterile toluol about half an inch thick ought to be run on to the top of the filtered fluid to protect the latter from the atmospheric oxygen.

Instead of being filtered off, the bacteria may be killed by various antiseptics, chiefly volatile oils, such as oil of mustard (Roux). These oils are stated to have no injurious effect on the chemical substances in the fluid, and they may be subsequently removed by evaporation. It is not practicable to kill the bacteria by heat when their soluble products are to be studied, as many of the latter are destroyed by a lower temperature than is required to kill the bacteria themselves.

The Observation of Bacterial Fermentations in Sugars.—

The capacity of certain species of bacteria to originate fermentations in sugars constitutes an important biological factor. The end-products of such fermentations may be various. They differ according to the sugar employed and according to the species under observation, and frequently a species which will ferment one sugar has no effect on another. The substances finally produced, speaking roughly, may be alcohols, acids, or gaseous bodies (chiefly carbon dioxide, hydrogen, and methane). For the estimation of the two former groups complicated chemical procedure may be necessary. The formation of gases is, however, usually taken as the criterion of the possession of fermentative properties. Generally speaking, it is reliable, and the methods to be pursued are simple. It must not be forgotten, however, that some organisms give rise to sulphuretted hydrogen by breaking up the proteid present. The formation of this gas can be detected by the blackening of lead acetate when it is added to the gas-containing medium. The following are the chief methods for detecting the formation of gas:—

(1) *Gelatin Shake Cultures* (Fig. 44, *a*).—The gelatin in the tube is melted as for making plates; while liquid it is inoculated with the growth to be observed, and shaken to distribute the organisms throughout the jelly. It is then allowed to solidify, and is set aside at a suitable temperature. If the bacterium

used is a gas-forming one, then, as growth occurs, little bubbles appear round the colonies. These frequently coalesce to form bubbles of a larger size, and those which are superficial in process of time diffuse out of the medium. This method is very frequently used for studying gas formation by *B. coli*.

(2) *Durham's Tubes* (Fig. 44, *b*).—The plug of a tube which contains about one-third more than usual of a liquid medium is removed, and a small test-tube is slipped into the latter mouth downwards. The plug is replaced and the tube sterilised thrice at 100° C. The air remaining in the smaller tube is thereby expelled. The tube is then inoculated with the bacterium to be tested. Any gas developed collects in the upper part of the inner tube.

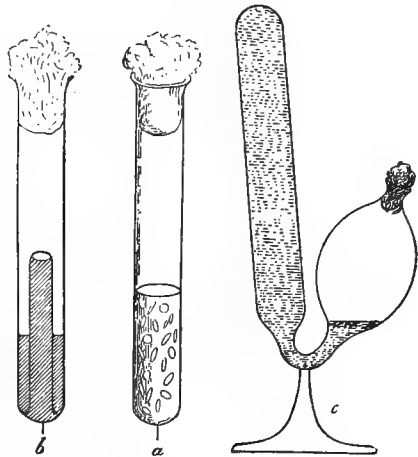

FIG. 44.—Tubes for demonstrating gas-formation by bacteria.

a, tube with "shake" culture.

b, Durham's fermentation tube.

c, ordinary form of fermentation tube (Smith's).

(3) *The Fermentation Tube* (Fig. 44, *c*).—This consists of a tube of the form shown, and the figure also indicates the extent to which it ought to be filled. It is inoculated in the bend with the gas-forming organism, and when growth occurs the gas collects in the upper part of the closed limit, the medium being displaced into the bulb.

H. W. Hill has advantageously modified the ordinary fermentation tube of Smith (Fig. 45) by having the bulb made larger so as to accommodate twice the quantity of fluid contained in the branch, thus avoiding wetting of the plugs during sterilisation; also, in having replaced the sealed end of the branch by a snugly fitting, hollow, ground-glass thimble, or stopper, permitting one to examine the contents of the branch, either chemically or bacteriologically, without contamination by fluid in the bulb, such as happens when using the ordinary form of the tube. In carrying out this examination it is obviously necessary to first replace

the cotton plug by a sterile rubber stopper before opening up the closed arm.

The composition of the medium is, of course, of great importance, and in testing the effect of a bacterium on a given sugar it is essential that this sugar alone be present. The first method is usually used with ordinary gelatin, and the gas-formation in most cases results from fermentation of the glucose naturally present in the medium from transformation of the glycogen of muscle. (It is only a more delicate method of demonstrating what sometimes occurs along the line of growth in an ordinary gelatin stab-culture.) The amount of glucose naturally present, however, varies much, and therefore glucose should be added to the medium if the effects on this sugar are to be observed. When other sugars — lactose, mannite, etc. — are to be tested, these should be added either to a simple peptone solution as Durham recommends, or to bouillon previously freed from dextrose as described below — fermentation being observed by either of the methods (2) or (3).

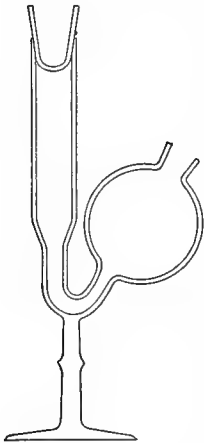

FIG. 45. — Hill's modification of Smith's fermentation tube.

To obtain a "dextrose-free" bouillon, Smith advises that the beef infusion, prepared by extracting in the cold or at 60° C. for twelve hours, be inoculated in the evening with a rich fluid culture of *B. coli* and placed in the thermostat over night. Early the following morning the infusion, covered with a layer of froth, is boiled, filtered, peptone and salt added, and neutralisation and sterilisation carried out as usual. As a test for the complete removal of the sugar, a fermentation tube of the broth when inoculated with *B. coli* will no longer give a growth in the closed arm of the tube, the fluid there remaining perfectly clear. When the various sugars are added to such a broth, it is strongly advised to sterilise by the intermittent method, for the heat of the autoclave is almost sure to produce chemical changes in the sugars through the presence of alkali and other constituents in the medium.

The Observation of Indol formation by Bacteria. — The formation of indol from albumin by a bacterium sometimes constitutes an important specific characteristic. To observe indol production the bacterium is grown preferably at incubation temperature on a fluid medium containing peptone. The latter may either be ordinary dextrose-free bouillon or peptone solution

(see p. 43). Indol production is recognised by the fact that when acted on by nitric acid *in the presence of nitrites*, a nitroso-indol compound is produced, which has a rosy red colour. Some bacteria (*e.g.* the cholera vibrio) produce nitrites as well as indol, but often, in making the test (*e.g.* in the case of *B. coli*), the nitrites must be added. This may be effected by using yellow nitric acid (which of course contains nitrous acid) for the test, or by adding to an ordinary tube of medium 1 c.c. of a .02 per cent solution of potassium nitrite, and testing with pure nitric or sulphuric acid. In any case only a drop of the acid need be added to say 10 c.c. of medium. If no result be obtained at once, it is well to allow the tube to stand for an hour, as sometimes the reaction is very slowly produced. The amount of indol produced by a bacterium seems to vary very much with certain unknown qualities of the peptone, and differences in ability to form indol from a given sample of peptone are noticeable, too, in races of bacteria of the same species. It is well therefore to test a series of peptones with an organism (such as the *B. coli*) known to produce indol, and noting the sample with which the best reaction is obtained, to reserve it for making media to be used for the detection of this product.

The Drying of Substances in vacuo. — As many substances, for example toxins and antitoxins, with which bacteriology is concerned would be destroyed by drying with heat as is done in ordinary chemical work, it is necessary to remove the water at the ordinary room temperature. This is most quickly effected by drying *in vacuo* in the presence of some substance such as strong sulphuric acid which readily takes up water vapour. The vacuum produced by a water-pump is here not available, as in such a vacuum there

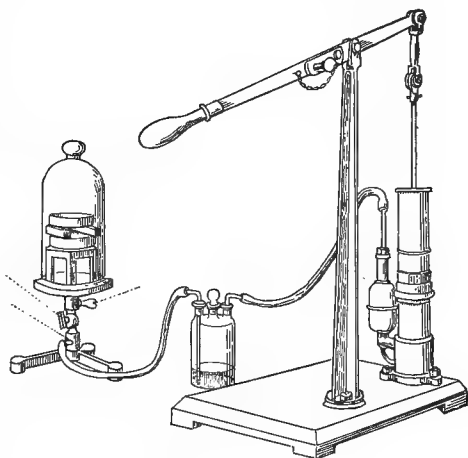

FIG. 46. — Geryk's air-pump for drying *in vacuo*.

readily takes up water vapour. The vacuum produced by a water-pump is here not available, as in such a vacuum there

must always be water vapour present. An air-pump is therefore to be employed. Here we have found the Geryk pump most efficient, and it has this further advantage, that its internal parts are lubricated with an oil of very low vapour density so that almost a perfect vacuum is obtainable. The apparatus is shown in Fig. 46. The vacuum chamber consists of a bell-jar set on a brass plate. A perforation in the centre of the latter leads into the pipe *a*, which can be connected by strong walled rubber tubing with the air-pump, and which can be cut off from the latter by a stopcock *b*. In using the apparatus the substance to be dried is poured out in flat dishes (one-half of a Petri dish does very well), and these are stacked alternately with similar dishes of strong sulphuric acid on a stand which rests on the brass plate. The edge of the bell-jar is well luted with unguentum resinæ and placed in position and the chamber exhausted. In a few hours, if, as is always advisable, each dish have contained only a thin layer of fluid, the drying will be complete. The vacuum is then broken by admitting air very slowly through a bye-pass *c*, and the bell-jar is removed. In such an apparatus it is always advisable, as is shown in the figure, to have interposed between the pump and the vacuum chamber a Wolff's bottle containing sulphuric acid. This protects the oil of the pump from contamination with water vapour. Whenever the vacuum is produced the rubber tube should be at once disconnected from *a*, the cock *b* being shut. It is advisable when the apparatus is exhausted to cover the vacuum chamber and the Wolff's bottle with wire guards covered with strong cloth in case, under the external pressure, the glass vessels give way.

The Storing and Incubation of Cultures. — Gelatin cultures must be grown at a temperature below their melting-point, *i.e.* for 10 per cent gelatin, below 22° C. They are usually kept in ordinary rooms, which vary, of course, in temperature at different times, but which have usually a range of from about 12° C. to 18° C. Agar and serum media are usually employed to grow bacteria at a higher temperature, corresponding to that at which the organisms grow best, usually 37° C. in the case of pathogenic organisms. For the purpose of maintaining a uniform temperature incubators are used. These vary much in the details of their structure, but all consist of a chamber with double walls

between which some fluid (water or glycerin and water) is placed, which, when raised to a certain temperature, ensures a fairly constant distribution of the heat round the chamber. The latter is also furnished with double doors, the inner being usually of glass. Heat is supplied from a burner fixed below. These burners vary much in design. Sometimes a mechanism devised in Koch's laboratory is affixed, which automatically turns off the gas if the light be accidentally extinguished. Between the tap supplying the gas, and the burner, is interposed a gas regulator. Such regulators vary in design, but for ordinary chambers which require to be kept at a constant temperature, Reichert's is as good and simple as any and is not expensive. It is shown in Fig. 47.

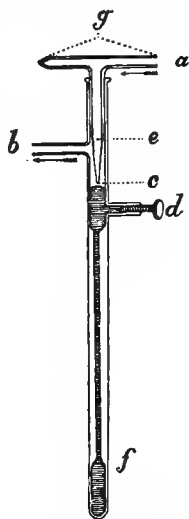

FIG. 47. — Reichert's gas regulator.

It consists of a long tube *f* closed at the lower end, open at the upper, and furnished with two lateral tubes. The lower part is filled with mercury up to a point above the level of the lower lateral tube. The end of the latter is closed by a brass cap through which a screw *d* passes, the inner end of which lies free in the mercury. The height of the latter in the perpendicular tube can thus be varied by increasing or decreasing the capacity of the lateral tube by turning the screw a few turns out of or into it. Into the upper open end of the perpendicular tube fits accurately a bent tube, *g*, drawn out below to a comparatively small open point, *c*, and having in its side a little above the point a minute needle-hole called the peephole or bye-pass *e*. To fix the apparatus the long mercury bulb is placed in the jacket of the chamber to be controlled. tube *a* is connected to gas supply, tube *b* with the burner. The upper level of the mercury should be some distance below the lower open end of tube *c*. The burner is now lit. The gas passes in at *a* through *c* and *e* and out at *b* to the burner. When the thermometer in the interior of the chamber indicates that the desired temperature has been reached, the screw *d* is turned till the mercury reaches the end of the tube *c*. Gas can only now pass through the peephole *e*, and the flame goes down. The contents of the jacket cool, the mercury contracts off the end of tube *c*, and the flame rises. This alternation going on, the temperature of the chamber is kept very nearly constant. If the mercury cuts off the gas supply before the desired temperature is reached, and the screw *d* is as far out as it will go, then some of the mercury must be removed. Similarly, if when the desired temperature is reached and the screw *d* is as far in as it can go, the mercury does not reach *c*, some more must be introduced. If the amount of gas which passes through the peephole is sufficient still to raise the temperature of the chamber when *c* is closed by the rise of the mercury, then the peephole is too large. Tube *c* must be unshipped

and *e* plastered over with sealing-wax, which is pricked, while still soft, with a very fine needle. The gas flame, when only the peephole is supplying gas, ought to be sufficiently large not to be blown out by small currents of air. If the pressure of gas supplied to a regulator varies much in the 24 hours a pressure regulator ought to be interposed between the gas-tap and the instrument. Several varieties of these can be obtained. In all cases *g* ought to be fixed to *b* with a turn of wire. Greater accuracy in regulation can be obtained if some liquid paraffin ("albolene") is deposited upon the surface of the mercury to the depth of 3 or 4 mm.

The varieties of incubators are, as we have said, numerous. The most complicated and expensive are made by German

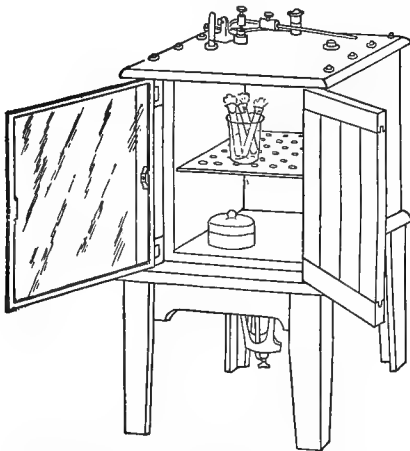

FIG. 48.—Hearson's incubator for use at 37° C.

manufacturers. Many of these are unsatisfactory. They easily get out of order and are difficult to repair. We have found those of Hearson, of London, extremely good, and in proportion to their size much cheaper than the German articles. They are fitted with an admirable regulator. In America, manufacturers will be found who can supply incubators the equal of any of the foreign makes on the market. It is

preferable in using an incubator to connect the regulator with the gas supply and with the Bunsen by flexible metal tubing. It is necessary to see that there is not too much evaporation from the surface of cultures placed within incubators, otherwise they may quickly dry up. It is thus advisable to raise the amount of water vapour in the interior by having in the bottom of the incubator a flat dish full of water, from which evaporation may take place. Tubes which will require to be long in the incubator should have their plugs covered either by india-rubber caps or by pieces of sheet rubber tied over them. These caps should be previously sterilised in 1-1000 corrosive sublimate, and then dried. Before they are placed on the tubes the cotton-wool plug ought to be well singed in a flame. Or plugs may be impregnated with paraffin applied at boiling heat, which thoroughly prevents the growth of moulds

or bacteria through the cotton and the escape of water by evaporation. "Cool" incubators are often used for incubating gelatin at 21° to 22° C. An incubator of this kind, fitted with a low-temperature Hearson's regulator, is very satisfactory.

Permanent Preservation of Cultures. — This may be conveniently effected by means of formalin vapour. The cotton wool of the tube containing the culture to be preserved is removed and soaked in formalin (40 per cent formic aldehyde). It is then replaced and covered with an india-rubber cap. After exposure to the vapour in this way for two or three days, the culture will be found to be dead. The final stage in the process is to close the open end of the tube so as to prevent evaporation. Melted sealing-wax or other substance may be poured over the cotton wool, which is first burned off down to the tube, the whole being then covered by an india-rubber cap, or the upper end of the tube may be melted in a Bunsen flame, and thus sealed. In the latter case, tubes longer than those generally employed should be used, so as to leave a longer portion at the top beyond the medium, otherwise in sloped tubes part of the medium is apt to be melted. Cultures preserved in this way maintain their form practically unchanged for several years, though many coloured growths are apt to lose the colour. Liquefied gelatin usually becomes solidified by the action of formalin vapour, so that the tubes can be freely handled. In the case of agar tubes, any water of condensation should first of all be carefully poured off.

General Laboratory Rules. — On the working bench of every bacteriologist there should be a large dish of 1-1000 solution of mercuric chloride in water. Into this, all tubes, vessels, plates, hanging-drop cultures, etc., which have contained bacteria, and with which he has finished, ought to be at once plunged (in the case of tubes, the tube and plug should be put in separately).

On no account whatever are such infected articles to be left lying about the laboratory. The basin is to be repeatedly cleaned out. All the glass is carefully washed in repeated changes of tap water to remove the last trace of perchloride of mercury, a very minute quantity of which is sufficient to inhibit growth. Old cultures which have been stored for a time and from which fresh sub-cultures have been made ought to be steamed in the Koch steriliser for two or three hours, or in the

autoclave for a shorter period, and the tubes thoroughly washed out. Besides a basin of mercuric chloride solution for infected apparatus, etc., there ought to be a second reserved for the worker's hands in case of any accidental contamination. When, as in public health work, a large number of tubes are being daily put out of use, they may be put into an enamelled slop-pail, and this when full is placed in the steam steriliser.

A white glazed tile on which a bell-jar can be set is very convenient to have on a bench. Infective material in watch-glasses can be placed thus under cover while investigation is going on, and if anything is spilled the whole can be easily disinfected. In making examinations of organs containing virulent bacteria, the hands should be previously dipped in 1-1000 mercuric chloride and allowed to remain wet with this lotion. No food ought to be partaken of in the laboratory, and pipes, etc., are not to be laid with their mouthpieces on the bench. No label is to be licked with the tongue. Before leaving the laboratory the bacteriologist ought to wash the hands and forearms with 1-1000 mercuric chloride and then with yellow soap. In the case of any fluid containing bacteria being accidentally spilt on the bench or floor, 1-1000 mercuric chloride is to be at once poured on the spot. The air of the laboratory ought to be kept as quiet as possible.

CHAPTER III.

MICROSCOPIC METHODS—GENERAL BACTERIOLOGICAL DIAGNOSIS—INOCULATION OF ANIMALS.

The Microscope.—For ordinary bacteriological work a good microscope is essential. It ought to have a heavy stand, with rack and pinion and fine adjustment, a double mirror (flat on one side, concave on the other), a good condenser, with an iris diaphragm, and a triple nose-piece. It is best to have three objectives, either Zeiss A, D, and $\frac{1}{2}$ inch oil immersion, or the lenses of other makers corresponding to these. The oil immersion lens is essential. It is well to have two eyepieces, say Nos. 2 and 4 of Zeiss or lenses of corresponding strengths. The student must be thoroughly familiar with the focussing of the light on the lens by means of the condenser, and also with the use of the immersion lens. It may here be remarked that when it is desired to bring out in sharp relief the margins of unstained objects, *e.g.* living bacteria in a fluid, a narrow aperture of the diaphragm should be used, whereas, in the case of stained bacteria, when a pure colour picture is desired, the diaphragm ought to be widely opened. The flat side of the mirror ought to be used along with the condenser. When the observer has finished for the time being with the immersion lens he ought to wipe off the oil with a piece of silk or very fine washed linen. If the oil has dried on the lens it may be moistened with xylol—never with alcohol, which will dissolve the material by which the lens is fixed in its metal carrier.

Microscopic Examination of Bacteria. 1. **Hanging-drop Preparations.**—Micro-organisms may be examined: (1) alive or dead in fluids; (2) in film preparations; (3) in sections of tissues. In the two last cases advantage is always taken of the affinity of bacteria for certain stains. When they are to be examined in fluids a drop of the liquid may be placed on a slide

and covered with a cover-glass.¹ It is more usual, however, to employ hanging-drop preparations. The technique of making these has already been described (p. 68). In examining them microscopically, it is necessary to use a very small diaphragm. It is best to focus the edge of the drop with a low-power objective, and, arranging the slide so that part of the edge crosses the centre of the field, to clamp the preparation in this position. A high-power lens is then turned into position and lowered by the coarse adjustment to a short distance above its focal distance; it is now carefully screwed down by the fine adjustment, the eye being kept at the tube meanwhile. The shadow of the edge will be first recognised, and then the bacteria must be carefully looked for. Often a dry lens is sufficient, but for some purposes the oil immersion is required. If the bacteria are small and motile a beginner may have great difficulty in seeing them, and it is well to practise at first on some large non-motile form such as anthrax. In fluid preparations the natural appearance of bacteria may be studied, and their rate of growth determined. The great use of such preparations, however, is to find whether or not the bacteria are motile, and for determining this point it is advisable to use either broth or agar cultures not more than twenty-four hours old. In the latter case a small fragment of growth is broken down in broth or in sterile water. Sometimes it is an advantage to colour the solution in which the hanging-drop is made up with a minute quantity of an aniline dye, say a small crystal of gentian-violet to 100 c.c. of bouillon. Such a degree of dilution will not have any effect on the vitality of the bacteria. Ordinarily, living bacteria will not take up a stain, but even though they do not, the contrast between the unstained bacteria and the tinted fluid will enable the observer more easily to recognise them.

2. **Film Preparations.** (a) *Dry Method.*—This is the most extensively applicable method of microscopically examining bacteria. Fluids containing bacteria, such as blood, pus, scrapings of organs, can be thus investigated, as also cultures in fluid and solid media. The first requisite is a perfectly clean cover-glass. Many methods are recommended for obtaining such. The test

¹In bacteriological work it is essential that cover-glasses of No. 1 thickness (*i.e.* .14 mm. thick) should be used, as those of greater thickness are not suitable for a $\frac{1}{2}$ in. lens.

of this being accomplished is that, when the drop of fluid containing the bacteria is placed upon the glass, it can be uniformly spread with the platinum needle all over the surface without showing any tendency to retract into droplets.

The best method to pursue is to keep the cover-slips in a vessel containing 95 per cent alcohol. When required for use a slip is taken and polished with a piece of old linen or cotton cloth, which must be perfectly clean; then placing the cover-slip in the forceps, pass it through the flame six or eight times, not too slowly so as to risk destroying it, and it will be found that the lowermost surface will be perfectly free from any greasy substance. Another method is that recommended by Van Ermengem. The cover-glasses are placed for some time in a mixture of concentrated sulphuric acid 6 parts, potassium bichromate 6 parts, water 100 parts, then washed thoroughly in water and stored in absolute alcohol. For use, a cover-glass is either dried by wiping with a clean duster or is simply allowed to dry. This method will amply repay the trouble, and really saves time in the end. A clean cover having been obtained, the film preparation can now be made. If a fluid is to be examined, a loopful may be placed on the cover-glass, and either spread out

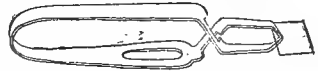

FIG. 49. — Cornet's forceps for holding cover-glasses.



FIG. 50. — Stewart's cover-glass forceps.

over the surface with the needle, or another clean cover may be placed on the top of the first, the drop thus spread out between them and the two then drawn apart. When a culture on a solid medium is to be examined a loopful of distilled water is placed on the cover-glass and a minute particle of growth rubbed up in it and spread over the glass. The great mistake made by beginners is to take too much of the growth. The point of the straight needle should just touch the surface of the culture, and when this is rubbed up in the droplet of water and the film dried, there should be an opaque cloud just visible on the cover-glass. When the film has been spread it must next be dried by

being waved backwards and forwards at arm's length above a Bunsen flame. The film must then be fixed on the glass by being passed four or five times quickly through the flame. In doing this a good plan is to hold the cover-glass between the right forefinger and thumb; if the fingers just escape being burned no harm will accrue to the bacteria in the film.

In making films of a thick fluid such as *pus* it is best to deposit a small quantity centrally on the cover-slip, then to place another cover on top and draw the two apart. The result will be a film of uniform depth throughout, available at almost all parts for examination. Scrapings of organs are very convenient if only the presence or absence of organisms is inquired after. Such scrapings may be smeared directly on the cover-glasses.

In the case of *blood*, a fairly large drop should be allowed to spread itself between two cover-glasses, which are then to be slipped apart, and being held between the forefinger and thumb are to be dried by a rapid to-and-fro movement in the air. A film prepared in this way may be too thick at one edge, but at the other is beautifully thin. If it is desired to preserve the red blood corpuscles in such a film it may be fixed by one of the following methods: by being placed (*a*) in a hot-air chamber at 120° C. for half an hour; (*b*) in a mixture of equal parts of alcohol and ether for half an hour, then washed and dried; (*c*) in formol-alcohol (Gulland) (formalin 1 part, absolute alcohol 9 parts) for five minutes, then washed and dried; or (*d*) in a saturated solution of corrosive sublimate for two or three minutes, then washed well in running water and dried. (Fig. 78 shows a film prepared by the last method.) In the case of *urine*, the specimen must be allowed to stand, and films made from any deposit which occurs; or, what is still better, the urine is centrifugalised, and films made from the deposit which forms. After dried films are thus made from urine it is an advantage to place a drop of distilled water on the film and heat gently to dissolve the deposit of salts; then wash in water and dry. In this way a much clearer picture is obtained when the preparation is stained. Preparations of broth or milk-cultures can be rendered free of stain-retaining material by allowing glacial acetic acid to act upon the film, after fixation, for five seconds, and then washing thoroughly in water.

Films dried and fixed by the above methods are now ready to be stained by the methods to be described below.

(b) *Wet Method.*—If it is desired to examine the fine histological structure of the cells of a discharge as well as to investigate the bacteria present, it is advisable to substitute “wet” films for the “dried” films, the preparation of which has been described. The nuclear structure, mitotic figures, etc., are by this method well preserved, whereas these are considerably distorted in dried films. The initial stages in the preparation of wet films are the same as above, but instead of being dried in air they are placed, while still wet, film downwards in the fixative. The following are some of the best fixing methods:—

(a) A saturated solution of perchloride of mercury in .75 per cent sodium chloride; fix for five minutes. Then place the films for half an hour, with occasional gentle shaking, in .75 per cent sodium chloride solution to wash out the corrosive sublimate; they are thereafter washed in successive strengths of methylated spirit. After this treatment the films are stained and treated as if they were sections.

(b) Formol-alcohol—formalin 1 part, absolute alcohol 9. Fix films for three minutes; then wash well in methylated spirit. This is an excellent and very rapid method.

(c) Another excellent method of fixing has been devised by Gulland. The fixing solution has the composition—absolute alcohol, 25 c.c., pure ether, 25 c.c., alcoholic solution of corrosive sublimate (2 gm. in 10 c.c. of alcohol), about 5 drops. The films are placed in this solution for five minutes or longer. They are then washed well in water, and are ready for staining. A contrast stain can be applied at the same time as the fixing solution, by saturating the 25 c.c. of alcohol with eosin before mixing. Thereafter the bacteria, etc., may be stained with methylene-blue or other stain, as described below. This method has the advantage over (a) that, as a small amount of corrosive sublimate is used, less washing is necessary to remove it from the preparation, and deposits are less liable to occur.

3. **Examination of Bacteria in Tissues.**—For the examination of bacteria in the tissues, the latter must be fixed and hardened, in preparation for being cut with a microtome. Fixation consists in so treating a tissue that it shall permanently maintain, as far as possible, the condition it was in when removed from the body. Hardening consists in giving such a fixed tissue sufficient consistence to enable a thin section of it to be cut. A tissue, after being hardened, may be cut in a freezing microtome, but far finer results can be obtained by

embedding the tissue in solid paraffin and cutting with some of the more delicate microtomes of which, for pathological purposes, the small Cambridge rocker is by far the best. For bacteriological purposes embedding in celloidin is not advisable, as the celloidin takes on the aniline dyes which are used for staining bacteria, and is apt thus to spoil the preparation, and besides thinner sections can be obtained by the paraffin method.

The Fixation and Hardening of Tissues.—The following are amongst the best methods for bacteriological purposes:—

(a) *Absolute alcohol* may be used for the double purpose of fixing and hardening. If the piece of tissue is not more than $\frac{1}{8}$ inch in thickness it is sufficient to keep it in this reagent for one or two days. If the pieces are thicker a longer exposure is necessary, and in such cases it is better to change the alcohol at the end of the first twenty-four hours. The tissue must be tough without being hard, and the necessary consistence, as estimated by feeling with the fingers, can only be judged of after some experience. If the tissues are not to be cut at once, they may be preserved in 50 per cent spirit.

(b) *Formol-alcohol*—formalin 1, absolute alcohol 9. Fix for not more than twenty-four hours; then place in absolute alcohol if the tissue is to be embedded at once, in 50 per cent spirit if it is to be kept for some time. For small pieces of tissue fixation for twelve hours or even less is sufficient. The method is a rapid and very satisfactory one.

(c) *Corrosive sublimate* is an excellent fixative agent. It is best used as a saturated solution in .75 per cent sodium chloride solution. Dissolve the sublimate in the salt solution by heat; the separation of crystals on cooling shows that the solution is saturated. For small pieces of tissue $\frac{1}{8}$ inch in thickness, twelve hours' immersion is sufficient. If the pieces are larger, twenty-four hours is necessary. They should then be tied up in a piece of gauze, and placed in a stream of running water for from twelve to twenty-four hours, according to the size of the pieces, to wash out the excess of sublimate. They are then placed for twenty-four hours in each of the following strengths of methylated spirit (free from naphtha¹): 30 per cent, 60 per cent, and 90 per cent. Finally they are placed in absolute alcohol for twenty-four hours and are then ready to be prepared for cutting.

If the tissue is very small, as in the case of minute pieces removed for diagnosis, the stages may be all compressed into twenty-four hours. In fact, after fixation in corrosive the tissue may be transferred directly to absolute alcohol, the perchloride of mercury being removed after the sections are cut, as will be afterwards described.

¹ In Britain ordinary commercial methylated spirit has wood naphtha added to it to discourage its being used as a beverage. The naphtha being insoluble in water, a milky fluid results from the dilution of the spirit. By law, chemists can only sell 8 ounces of pure spirit at a time. Most pathological laboratories are, however, licensed by the Excise to buy pure spirit in large quantities.

(d) *Methylated Spirit*. — Small pieces of tissue may be placed in methylated spirit, which is to be changed after the first day. In six to seven days they will be hardened. If the pieces are large, a longer time is necessary.

The Cutting of Sections. — 1. *By Means of the Freezing Microtome*. — Pieces of tissue hardened by any of the above methods must have all the alcohol removed from them by washing in running water for twenty-four hours. They are then placed for from twelve to twenty-four hours (according to their size) in a thick syrupy solution containing two parts of gum arabic and one part of sugar. They are then cut on a freezing microtome (of which Cathcart's is a good example) and placed for a few hours in a bowl of water so that the gum and syrup may dissolve out. They are then stained, or they may be stored in methylated spirit.

2. *Embedding and Cutting in Solid Paraffin*. — This method gives by far the finest results, and should always be adopted when practicable. The principle is the impregnation of the tissue with paraffin in the melted state. This paraffin when it solidifies gives support to all the tissue elements. The method involves that, after hardening, the tissue shall be thoroughly dehydrated, and then thoroughly permeated by some solvent of paraffin which will expel the dehydrating fluid and prepare for the entrance of the paraffin. The solvents most in use are chloroform, cedar oil, xylol, and turpentine; of these chloroform and cedar oil are the best, the former being preferred as it permeates the tissue more rapidly. The more gradually the tissues are changed from reagent to reagent in the processes to be gone through, the more successful is the result. A necessity of the process is an oven with hot-water jacket, in which the paraffin can be kept at a constant temperature just above its melting-point, a gas regulator, *e.g.* Reichert's, being of course necessary. The tissues occurring in pathological work have a tendency to become brittle if overheated, and therefore the best results are not obtained by using paraffin melting about 58° C., such as is employed in most biological laboratories. We have used for some years a mixture of one part of paraffin melting at 48° and two parts of paraffin melting at 54° C. This mixture has a melting-point between 52° and 53° C., and it serves all ordinary purposes well. An excellent quality of paraffin is that known as the "Cambridge paraffin," but many scientific-instrument

makers supply paraffins which, for ordinary purposes, are quite as good, and much cheaper. The successive steps in the process of paraffin embedding are as follows:—

1. Pieces of tissue, however hardened, are placed in fresh absolute alcohol for twenty-four hours in order to complete their dehydration.
2. Transfer now to a mixture of equal parts of absolute alcohol and chloroform for twenty-four hours.
3. Transfer to pure chloroform for twenty-four hours. At the end of this time the tissues should sink, or float heavily.
4. Transfer now to a mixture of equal parts of chloroform and paraffin, and place on the top of the oven for from twelve to twenty-four hours. If the temperature there is not sufficient to keep the mixture melted, then they must be put inside.
5. Place in pure melted paraffin in the oven for twenty-four hours. For holding the paraffin containing the tissues, small tin dishes such as are used by pastry-cooks will be found very suitable. There must be a considerable excess of paraffin over the bulk of tissue present, otherwise sufficient chloroform will be present to vitiate the final result and not give the perfectly hard block obtained with pure paraffin. With experience, the persistence of the slightest trace of chloroform can be recognised by smell.

In the case of very small pieces of tissue the time given for each stage may be much shortened, and where haste is desirable Nos. 2 and 4 may be omitted. Otherwise it is better to carry out the process as described.

6. Cast the tissues in blocks of paraffin as follows: Pairs of L-shaped pieces of metal made for the purpose by instrument makers must be at hand. By laying two of these together on a glass plate, a rectangular trough is formed. This is filled with melted paraffin taken from a stock in a separate dish. In it is immersed the piece of tissue, which is lifted out of its pure paraffin bath with heated forceps. The direction in which it is to be cut must be noted before the paraffin becomes opaque. When the paraffin has begun to set, the glass plate and trough have cold water run over them. When the block is cold, the metal L's are broken off, and, its edges having been pared, it is stored in a pill-box.

The Cutting of Paraffin Sections.—Sections must be cut as thin as possible, the Cambridge rocking microtome being, on the whole, most suitable. They should not exceed $8\ \mu$ in thickness, and ought, if possible, to be about $4\ \mu$. For their manipulation it is best to have



FIG. 51.—Needle with square of paper on end for manipulating paraffin sections.

two needles on handles, two camel's-hair brushes on handles, and a needle with a rectangle of stiff writing paper fixed on it as in the diagram (Fig. 51). When cut, sections are floated on the surface of a beaker of water kept at a

temperature about 10° C. below the melting-point of the paraffin. On the surface of the warm water they become perfectly flat.

Fixation on Ordinary Slides. (a) Gulland's Method.—A supply of slides well cleaned being at hand, one of them is thrust obliquely into the water below the section, a corner of the section is fixed on it with a needle, and the slide withdrawn. The surplus of water being wiped off with a cloth, the slide is placed on a support, with the section downwards, and allowed to remain on the top of the paraffin oven or in a bacteriological incubator for from twelve to twenty-four hours. It will then be sufficiently fixed on the slide to withstand all the manipulations necessary during staining and mounting.

(b) Fixation by Mann's Method.—This has the advantage of being more rapid than the previous one. A solution of albumin is prepared by mixing the white of a fresh egg with ten parts of distilled water and filtering. Slides are made perfectly clean with alcohol. One is dipped into the solution and its edge is then drawn over one surface of another slide so as to leave on it a thin film of albumin. This is repeated with the others. As each is thus coated, it is leant, with the film downwards, on a ledge till dry, and then the slides are stored in a wide stoppered jar till needed. The floating out is performed as before. The albuminised side of the slide is easily recognised by the fact that if it is breathed on, the breath does not condense on it. The great advantage of this method is that the section is fixed after twenty to thirty minutes' drying at 37° C. If the tissue has been hardened in any of the bichromate solutions and embedded in paraffin, this or some corresponding method of fixing the sections on the slide must be used.

Preparation of Paraffin Sections for Staining.—Before staining, the paraffin must be removed from the section. This is best done by dropping on xylol out of a drop-bottle. When the paraffin is dissolved out, the superfluous xylol is wiped off with a cloth and a little absolute alcohol dropped on. When the xylol is removed the superfluous alcohol is wiped off and a little 50 per cent methylated spirit dropped on. During these procedures sections must on no account be allowed to dry. The sections are now ready to be stained. Deposits of crystals of corrosive sublimate often occur in sections which have been fixed by this reagent. These can be readily removed by placing the sections, before staining, for a few minutes in equal parts of Gram's iodine solution (p. 102) and water, and then washing out the iodine with methylated spirit.

To save repetition we shall in treating of stains suppose that, with paraffin sections, the above preliminary steps have already been taken, and further, that sections cut by a freezing microtome are also in spirit and water.

Dehydration and Clearing. — It is convenient, first of all, to indicate the final steps to be taken after a specimen is stained. *Dry films* after being stained are washed in water, dried and mounted in xylol-balsam; *wet films* and *sections* must be dehydrated, cleared, and then mounted in xylol-balsam.

Dehydration is most commonly effected with absolute alcohol. Alcohol, however, sometimes decolorises the stained organisms more than is desirable, and therefore Weigert devised the following method for dehydrating and clearing by aniline oil, which, though it may decolorise somewhat, does not do so to the same extent as alcohol. As much as possible of the water being removed, the section placed on a slide is partially dried by draining with fine blotting paper. Some aniline oil is placed on the section and the slide moved to and fro. The section is dehydrated and becomes clear. The process may be accelerated by heating gently. The preparation is then treated with a mixture of two parts of aniline oil and one part of xylol, and then with xylol alone, after which it is mounted in xylol-balsam. Paraffin sections can usually be dehydrated and cleared by the mixture of aniline oil and xylol alone.

Sections stained for bacteria should always be *cleared*, at least finally, in xylol, for the same reason that xylol-balsam is to be used for mounting films, viz., that it dissolves out aniline dyes less readily than such clearing reagents as clove oil, etc. Xylol, however, requires the previous dehydration to have been more complete than clove oil, which will clear a section readily when the dehydration has been only partially effected by, say, methylated spirit. If a little decolorisation of a section is still required before mounting, clove oil may be used to commence the clearing, the process being finished with xylol. With a little experience the progress, not only of these processes but also of staining, can be very accurately judged of by observing the appearance under a low objective.

THE STAINING OF BACTERIA.

Staining Principles. — To speak generally, the protoplasm of bacteria reacts to stains in a manner similar to the nuclear chromatin, though sometimes more and sometimes less actively. The bacterial stains *par excellence* are the basic aniline dyes.

These dyes are more or less complicated compounds derived from the coal-tar product aniline ($C_6H_5 \cdot NH_2$). Many of them have the constitution of salts. Such compounds are divided into two groups according as the staining action depends on the basic or the acid portion of the molecule. Thus the acetate of rosaniline derives its staining action from the rosaniline. It is therefore called a basic aniline dye. On the other hand, ammonium picrate owes its action to the picric acid part of the molecule. It is therefore termed an acid aniline dye. These two groups have affinities for different parts of the animal cell. The basic stains have a special affinity for the nuclear chromatin, the acid for the protoplasm and various formed elements. Thus it is that the former — the basic aniline dyes — are especially the bacterial stains.

The number of basic aniline stains is very large. The following are the most commonly used: ¹—

Violet Stains. — Methyl-violet, R-5R (synonyms: Hoffmann's violet, dahlia).

Gentian-violet (synonyms: benzyl-violet, Pyoktanin).

Crystal violet.

Blue Stains. — Methylene-blue ² (synonym: phenylene-blue).

Victoria-blue.

Thionin-blue.

Red Stains. — Basic fuchsin (synonyms: basic rubin, magenta).

Safranin (synonyms: fuchsia, Giroflé).

Brown Stain. — Bismarck-brown (synonyms: vesuvin, phenylene-brown).

It is of the greatest importance that the stains used by the bacteriologist should be good, and therefore it is advisable to obtain those prepared by Grübler of Leipzig. One is then perfectly sure that one has got the right stain.

Of the stains specified, the violets and reds are the most intense in action, especially the former. It is thus easy in using them to overstain a specimen. Of the blues, methylene-blue probably gives the best differentiation of structure, and it is difficult to overstain with it. Thionin-blue also gives good differentiation and does not readily overstain. Its tone is deeper

¹ For further information on this subject the student is referred to Rawitz, "Leitfaden für histologische Untersuchungen," Jena, 1895, from which the synonyms used in the text are taken.

² This is to be distinguished from methyl-blue, which is a different compound.

than that of methylene-blue and it approaches the violets in tint. Bismarck-brown is a weak stain, but is useful for some purposes. Formerly it was much used in photomicrographic work, as it was less actinic than the other stains. It is not, however, needed now, on account of the improved sensitiveness of plates.

It is most convenient to keep saturated alcoholic solutions of the stains made up, and for use to filter a little into about ten times its bulk of distilled water in a watch-glass. A solution of good body is thus obtained. Most bacteria (except those of tubercle, leprosy, and a few others) will stain in a short time in such a fluid. Watery solutions may also be made up, *e.g.* a saturated watery solution of methylene-blue or a 1 per cent solution of gentian-violet. Stains must always be filtered before use; otherwise there may be deposited on the preparation granules which it is impossible to wash off. The violet stains in solution in water have a great tendency to decompose. Only small quantities should therefore be prepared at a time.

The Staining of Cover-glass Films. — Films are made from cultures as described above. The cover-glass may be floated on

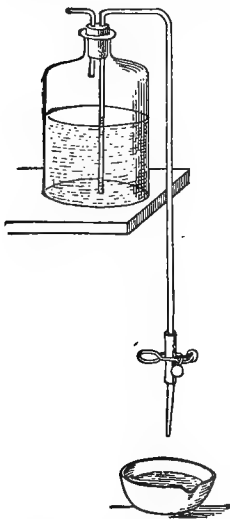

FIG. 52. — Syphon wash-bottle for distilled water used in washing preparations.

the surface of the stain in a watch-glass, or the cover-glass, held in forceps with the film side uppermost, may have as much stain poured on it as it will hold. When the preparation has been exposed for the requisite time, usually a few minutes, it is well washed in tap water in a bowl, or with distilled water with such a simple contrivance as that figured (Fig. 52). The figure explains itself. When the film has been washed, the surplus of water is drawn off with a piece of filter paper, the preparation is carefully dried high over a flame, a drop of xylol-balsam is applied, and the cover-glass mounted on a slide. It is sometimes advantageous to examine films in a drop of water in place of balsam. The films can be subsequently dried and mounted permanently. In the case of tubercle, special stains are necessary (p. 104), but with this exception, practically all bacterial films made from cultures can be stained in this way.

Some bacteria, *e.g.* typhoid, glanders, take up the stains rather slowly, and for these the more intensive stains, red or violet, are to be preferred.

Films of *fluids from the body* (blood, pus, etc.) can be generally stained in the same way, and this is often quite sufficient for diagnostic purposes. The blue dyes are here preferable, as they do not readily overstain. Should overstaining occur it is easily remedied by decolorising for a few seconds in glacial acetic acid, 1-1000, and removing the acid by thoroughly washing in water. In the case of such fluids, if the histological elements also claim attention, it is best first to stain the cellular protoplasm with a one to two per cent watery solution of eosin (which is an acid dye), and then to use a blue which will stain the bacteria and the nuclei of the cells. In the case of films made from urine, where there is little or no albuminous matter present, the bacteria may be imperfectly fixed on the slide, and are thus apt to be washed off. In such a case it is well to modify the staining method. A drop of stain is placed on a slide, and the cover-glass, film side down, lowered upon it. After the lapse of the time necessary for staining, a drop of water is placed at one side of the cover-glass and a little piece of filter paper at the other side. The result is that the stain is sucked out by the filter paper. By adding fresh drops of water and using fresh pieces of filter paper, the specimen is washed without any violent application of water, and the bacteria are not displaced.

For the general staining of films a saturated watery solution of methylene-blue will be found to be the best stain to commence with.

The Use of Mordants and Decolorising Agents. — In films of blood and pus, and still more so in sections of tissues, if the above methods are used, the tissue elements may be stained to such an extent as to quite obscure the bacteria. Hence many methods have been devised in which the general principle may be said to be (*a*) the use of substances which, while increasing the staining power, tend to fix the stain in the bacteria, and (*b*) the subsequent treatment by substances which decolorise the overstained tissues to a greater or less extent, while they leave the bacteria coloured. The staining capacity of a solution may be increased —

(*a*) By the addition of substances such as carbolic acid, aniline oil, or metallic salts, all of which probably act as mordants.

(b) By the addition of alkalis, such as caustic potash or ammonium carbonate, in weak solution.

(c) By the employment of heat.

(d) By long duration of the staining process.

As decolorising agents we use chiefly mineral acids (hydrochloric, nitric, sulphuric), vegetable acids (especially acetic acid), alcohol (either methylated spirit or absolute alcohol), or a combination of spirit and acid, *e.g.* methylated spirit with a drop or two of hydrochloric acid added, also various oils, *e.g.* aniline, clove, etc. In most cases about thirty drops of acetic acid in a bowl of water will be sufficient to remove the excess of stain from overstained films and sections. More of the acid may, of course, be added if necessary.

Hot water also decolorises to a certain extent; overstained films can be readily decolorised by placing a drop of water on the film and heating gently over a flame.

When preparations have been sufficiently decolorised by an acid, they should be well washed in tap water, or in distilled water with a little lithia carbonate added.

The methods embracing the use of a stain with a mordant, and a decoloriser, are very numerous, and we can only enumerate the best of them.

We sometimes have to deal with bacteria which show a special tendency to be decolorised. This tendency can be obviated by adding a little of the stain to the alcohol, or aniline oil, employed in dehydration. In the latter case a little of the stain is rubbed down in the oil. The mixture is allowed to stand. After a little time a clear layer forms on the top with stain in solution, and this can be drawn off with a pipette.

When methylene-blue, methyl-violet, or gentian-violet is used the stain can, after the proper degree of decolorisation has been reached, be fixed in the tissues by treating for a minute with ammonium molybdate ($2\frac{1}{2}$ per cent in water).

The Formulæ of some of the more commonly used Stain Combinations.

1. *Löffler's Methylene-blue.*

Saturated solution of methylene-blue in alcohol	30 c.c.
Solution of potassium hydrate in distilled water (1-10,000)	100 c.c.

(This dilute solution may be conveniently made by adding 1 c.c. of a 1 per cent solution to 99 c.c. of water.)

Sections may be stained in this mixture for from a quarter of an hour to several hours. They do not readily overstain. The tissue containing the bacteria is then decolorised if necessary with $\frac{1}{2}$ -1 per cent acetic acid, till it is a pale blue-green. The section is washed in water, rapidly dehydrated with alcohol or aniline oil, cleared in xylol, and mounted.

The tissue may be contrast stained with eosin. If this is desired, after decolorisation wash with water, place for a few seconds in 1 per cent solution of eosin in absolute alcohol, rapidly complete dehydration with pure absolute alcohol, and proceed as before.

Films may be stained with Löffler's blue by five minutes' exposure or longer in the cold. They usually do not require decolorisation, as the tissue elements are not overstained.

2. *Kühne's Methylene-blue.*

Methylene-blue	1.5 gr.
Absolute alcohol	10 c.c.
Carbolic acid solution (1-20)	100 „

Stain and decolorise as with Löffler's blue, or decolorise with very weak hydrochloric acid (a few drops in a bowl of water).

3. *Carbol-thionin-blue.*—Make up a stock solution consisting of 1 gramme of thionin-blue dissolved in 100 c.c. carbolic acid solution (1-40). For use, dilute 1 volume with 3 of water and filter. Stain sections for five minutes or upwards. Wash very thoroughly with water, otherwise a deposit of crystals may occur in the subsequent stages. Decolorise with very weak acetic acid. A few drops of the acid added to a bowl of water is quite sufficient. Wash again thoroughly with water. Dehydrate with absolute alcohol. Thionin-blue stains more deeply than methylene-blue, and gives equally good differentiation. It is very suitable for staining typhoid and glanders bacilli in sections. Cover-glass preparations stained by this method do not usually require decolorisation. As a contrast stain, 1 per cent watery solution of eosin may be used before staining with the thionin.

4. *Gentian-violet in Aniline Oil Water.*—Two solutions have here to be made up. (a) Aniline oil water. Add exactly 2 c.c. aniline oil to 98 c.c. distilled water in a flask, and shake violently till as much as possible of the oil has dissolved. Filter twice through the same paper and keep in a covered bottle to prevent access of light. (b) Make a saturated solution of gentian-violet in alcohol. When the stain is to be used, 25 parts of (b) is added to 75 parts of (a), and the mixture filtered. This mixture will not readily decompose and may be used for several months if kept from the prolonged action of light, although it may require occasional filtering to remove accumulated crystalline deposit. Stain sections for a few minutes; then decolorise with methylated spirit. Sometimes it is advantageous to add to the methylated spirit a little hydrochloric acid (2-3 minims to 100 c.c.). This staining solution is not so much used by itself for tissues, as in Gram's method, which is presently to be described, but makes an excellent stain for most bacterial films.

5. *Carbol-gentian-violet.*—1 part saturated alcoholic solution of gentian-

violet is mixed with 10 parts of 5 per cent solution of carbolic acid. It is used as No. 4.

6. *Carbol-fuchsin* (see p. 104). — This is a very powerful stain, and, when used in the undiluted condition, $\frac{1}{2}$ –1 minute's staining is usually sufficient. It is better, however, to dilute with five to ten times its volume of water and stain for a few minutes. In this form it has a very wide application. Methylated spirit with or without a few drops of acetic acid is the most convenient decolorising agent. Then dehydrate thoroughly, clear, and mount.

Various other staining combinations might be given, but the above are the best and most widely used. If the reader has thoroughly grasped the remarks made above on the general principles which underlie the staining of bacteria, he will be able to use any combination to which his attention may be directed. We may only add here that different organisms take up and hold different stains with different degrees of intensity, and thus duration of staining and degree of decolorisation must be varied. It may be laid down as a general rule that, so long as organisms retain the stain, the greater the decolorisation of the tissues in which they lie, the clearer will be the results.

Gram's Method and its Modifications. — In the methods already described the tissues, and more especially the nuclei, retain some stain when decolorisation has reached the point to which it can safely go without the bacteria themselves being affected. In the method of Gram, now to be detailed, this does not occur, for the stain can here be removed completely from the ordinary tissues, and left only in the bacteria. All kinds of bacteria, however, do not retain the stain in this method, and therefore in the systematic description of any species it is customary to state whether it is, or is not, stained by Gram's method — by this is meant, as will be understood from what has been said, *whether the particular organism retains the colour after the latter has been completely removed from the tissues*. It must, however, be remarked that some tissue elements may retain the stain as firmly as any bacteria, *e.g.* keratinised epithelium, calcified particles, the granules of mast cells, and sometimes altered red blood corpuscles, etc.

In Gram's method the essential feature is the treating of the tissue, after staining, with a solution of iodine. This solution is spoken of as Gram's solution (sometimes as Lugol's), and has the following composition: —

Iodine	1 part.
Potassium iodide	2 parts.
Distilled water	300 „

The following is the method:—

1. Stain in aniline oil gentian-violet or in carbol-gentian-violet (*vide* pp. 101, 102) for about five minutes, and wash in water.

2. Treat the section or film with Gram's solution till its colour becomes a purplish black—generally about half a minute or a minute is sufficient for the action to take place.

3. Decolorise with absolute alcohol or methylated spirit till the colour has almost entirely disappeared, the tissues having only a faint violet tint.

4. Dehydrate completely, clear with xylol, and mount. In the case of film preparations, the specimen is simply washed in water, dried, and mounted.

In stage (3) the process of decolorisation is more satisfactorily performed by using clove oil after sufficient dehydration with alcohol, the clove oil being afterwards removed by xylol.

As a *contrast* stain for the tissues carmalum or lithia carmine is used before staining with gentian-violet (1). As a contrast stain for other bacteria which are decolorised by Gram's method carbol-fuchsin diluted with ten volumes of water, or a saturated watery solution of Bismarck-brown, may be used before stage (4).

As applied to bacterial films special conditions must be observed. The film must always be prepared from an agar slant-culture between 12 and 24 hours old, and is then to be treated as follows:—

1. Stain in aniline gentian-violet for 1½ minutes.
2. Wash in water.
3. Stain in Gram's solution for 1½ minutes.
4. Decolorise in absolute alcohol for at least four minutes, or until all stain is completely discharged.
5. Mount in balsam.

The following modifications of Gram's method may be given:—

1. *Weigert's Modification.*—The contrast staining of the tissues and stages (1) and (2) are performed as above.

(3) After using the iodine solution the preparation is dried by blotting and then decolorised by aniline-xylol (aniline oil 2, xylol 1).

(4) Wash well in xylol and mount in xylol-balsam. Film preparations after being washed in xylol may be dried, and thereafter dilute carbol-fuchsin may be used to stain bacteria which have been decolorised.

This modification probably gives the most uniformly successful results.

2. *Nicolle's Modification.*—Carbol-gentian-violet is used as the stain. Treatment with iodine is carried out as above and decolorisation is effected with a mixture of acetone (1 part) and alcohol (2 parts).

3. *Kühne's Modification*.—(1) Stain for five minutes in a solution made up of equal parts of saturated alcoholic solution of crystal-violet ("Krystall-violet") and 1 per cent solution of ammonium carbonate.

(2) Wash in water.

(3) Place for two to three minutes in Gram's iodine solution, or in the following modification by Kühne:—

Iodine	2 parts.
Potassium iodide	4 "
Distilled water	100 "

For use, dilute with water to make a sherry-coloured solution.

(4) Wash in water.

(5) Decolorise in a saturated alcoholic solution of fluorescein (a saturated solution in methylated spirit does equally well).

(6) Dehydrate, clear, and mount.

Stain for Tubercle and Other Acid-fast Bacilli.—These bacilli cannot be well stained with a simple watery solution of a basic aniline dye. This fact can easily be tested by attempting to stain a film of a tubercle culture with such a solution. They require a powerful stain containing a mordant, and must be exposed to the stain for a long time, or the action of the latter may be aided by a short application of heat. When once stained, however, they resist decolorising even with very powerful acids; they are therefore called "acid-fast." The smegma bacillus also resists decolorising with strong acids (p. 256), and a number of other acid-fast bacilli have recently been discovered (p. 254). Any combination of gentian-violet or fuchsin with aniline oil or carbolic acid or other mordant will stain the bacilli named, but the following methods are most commonly used:—

Ziehl-Neelsen Carbol-fuchsin Stain.

Basic fuchsin	1 part.
Absolute alcohol	10 parts.
Solution of carbolic acid (1-20)	100 "

1. Place the specimen in this fluid, and having heated it till steam rises, allow it to remain there for five minutes, or allow it to remain in the cold stain for from twelve to twenty-four hours. (Films and paraffin sections are usually stained with hot stain, loose sections with cold; in hot stain the latter shrink.)

2. Decolorise with 20 per cent solution of strong sulphuric acid, nitric acid, or hydrochloric acid, in water. In this the tissues become yellow.

3. Wash well with water. The tissues will regain a faint pink tint. If the colour is distinctly red, the decolorisation is insufficient, and the specimen must be returned to the acid. As a matter of practice, it is best to remove the preparation from the acid every few seconds and wash in water, replacing the specimen in the acid and re-washing till the proper pale pink tint is obtained. Then wash in alcohol for half a minute and replace in water.

4. Contrast stain with a saturated watery solution of methylene-blue for half a minute, or with saturated Bismarck-brown for from two to three minutes.

5. Wash well with water. In the case of films, dry and mount. In the case of sections, dehydrate, clear, and mount.

Fraenkel's Modification of the Ziehl-Neelsen Stain.

Here the process is shortened by using a mixture containing both the decolorising agent and the contrast stain.

The sections or films are stained with the carbol-fuchsin as above described, and then placed in the following decolorising solution:—

Distilled water	50 parts.
Absolute alcohol	30 „
Nitric acid	20 „
Methylene-blue in crystals to saturation.	

They are treated with this till the red colour has quite disappeared and been replaced by blue. The subsequent stages are the same as in No. 5, *supra*.

Leprosy bacilli are stained in the same way, but are rather more easily decolorised than tubercle bacilli, and it is better to use only 5 per cent sulphuric acid in decolorising.

In the case of specimens stained either by the original Ziehl-Neelsen method, or by Fraenkel's modification, the tubercle or leprosy bacilli ought to be bright red, and the tissue blue or brown, according to the contrast stain used. Other bacteria which may be present are also coloured with the contrast stain.

Gabbett's Methylene-blue Solution.

Methylene-blue	2 grms.
Sulphuric acid	25 c.c.
Distilled water	75 c.c.

This is very similar to Fraenkel's decoloriser and contrast stain, and is used in the same manner. It has this one disadvantage, that it will not decolorise smegma bacilli should these be present in urinary sediments or in tissues from portions of the genito-urinary tract.

The Staining of Spores.— If bacilli containing spores are stained with a watery solution of a basic aniline dye, the spores remain unstained. The spores either take up the stain less readily than the protoplasm of the bacilli or they have a resisting envelope which prevents the stain penetrating to the protoplasm. Like the tubercle bacilli, when once stained they retain the colour with considerable tenacity. The following is the simplest method for staining spores:—

1. Stain cover-glass films as for tubercle bacilli.
2. Decolorise with 1 per cent sulphuric acid in water or with methylated spirit. This removes the stain from the bacilli.
3. Wash in water.
4. Stain with saturated watery methylene-blue for half a minute.
5. Wash in water, dry, and mount in balsam.

The result is that the spores are stained red, the protoplasm of the bacilli blue.

The spores of some organisms lose the stain more readily than those of others, and for some, methylated spirit is a sufficiently strong decolorising agent for use. If sulphuric acid stronger than 1 per cent is used, the spores of many bacilli are readily decolorised.

Möller's Method.— The following method, recommended by Möller, is much more satisfactory than the previous. Before being stained, the films are placed in chloroform for 2 minutes, and then in a 5 per cent solution of chromic acid for $\frac{1}{2}$ –2 minutes, the preparation being well washed after each reagent. Thereafter they are stained and decolorised as above.

The Staining of Capsules.— The two following methods may be recommended in the case of capsulated bacteria:—

(a) *Welch's Method.*— This depends on the fact that in many cases the capsules can be fixed with glacial acetic acid.

Films when fixed are placed in this acid for a few seconds.

The superfluous acid is removed with filter paper and the preparation is treated with gentian-violet in aniline-oil water repeatedly till all the acetic acid is removed.

Then wash with 0.85–2.0 per cent solution of sodium chloride and examine in the same solution.

Occasionally such preparations can be kept permanently in a balsam mounting.

The capsule appears as a pale violet halo around the deeply stained bacterium.

(b) *Rizhard Muir's Method.*— The following fixative and mordant is made up.

Saturated watery solution of corrosive sublimate	. 2
Tannic acid solution — 20 per cent 2
Saturated solution of potash alum 5

1. Films containing the bacteria are dried and then fixed in the above fluid for two minutes.
2. Wash in water, then in spirit, and again in water.
3. Stain with carbol-fuchsin for 2-3 minutes, heating gently.
4. Wash in water, place the film in the mordant for 2-3 minutes, and wash again in water.
5. Stain for 2 minutes in a saturated watery solution of methylene-blue.
6. Differentiate in methylated spirit, dehydrate in alcohol, clear in xylol, and mount in xylol-balsam.

The bacteria are deep crimson and the capsules of a blue tint. Fig. 79 is from a film stained by this method.

The Staining of Flagella. — The staining of the flagella of bacteria is the most difficult of all bacteriological procedures, and it requires considerable practice to ensure that good results shall be obtained. Many methods have been introduced, of which the three following are the most satisfactory.

Preparation of Films. — In all the methods of staining flagella, young cultures on agar should be used, say a culture incubated for from twelve to eighteen hours at 37° C. A very small portion of the growth is taken on the point of a platinum needle and carefully mixed in a little water in a watch-glass; the amount should be such as to produce scarcely any turbidity in the water. A film is then made by placing a drop on a clean cover-glass and carefully spreading it out with the needle. It is allowed to dry in the air, and is then passed twice or thrice through a flame, care being taken not to overheat it. But as ordinarily practised, there is far too much handling of the bacteria in the preparing of films, whereby large numbers of the organisms are more or less denuded of their flagella, in consequence giving poor results. To avoid this, Kendall recommends the following procedure: A tube containing 5 c.c. of sterile water is gently inoculated with enough of an 18-24-hour-old agar culture of a bacterium to produce a very faint turbidity in the upper half of the water. The tube is then placed in the thermostat for one hour, so as to let any clumps sediment as much as possible and permit of slight development. Without disturbing the fluid in any manner, two or three loopfuls of this culture are placed upon a clean cover-slip, without spreading, and dried in the thermostat, when they are to be fixed in the flame and stained by any of the methods recommended. The cover-glasses used should always

be cleaned in the mixture of sulphuric acid and potassium bichromate described on page 89.

1. *Pitfield's Method as modified by Richard Muir.*

Prepare the following solutions : —

A. *The Mordant.*

Tannic acid, 10 per cent watery solution, filtered	. 10 c.c.
Corrosive sublimate, saturated watery solution	. 5 c.c.
Alum, saturated watery solution 5 c.c.
Carbol-fuchsin (<i>vide</i> p. 104) 5 c.c.

Mix thoroughly. A precipitate forms, which must be allowed to deposit, either by centrifugalising or simply by allowing to stand. Remove the clear fluid with a pipette and transfer to a clean bottle. The mordant keeps well for one or two weeks.

B. *The Stain.*

Alum, saturated watery solution 10 c.c.
Gentian-violet, saturated alcoholic solution 2 c.c.

The stain should not be more than two or three days old when used. It may be substituted in the mordant in place of the carbol-fuchsin.

The film having been prepared as above described, pour over it as much of the mordant as the cover-glass will hold. Heat gently over a flame till steam begins to rise, allow to steam for about a minute, and then wash well in a stream of running water for about two minutes. Then dry carefully over the flame, and when thoroughly dry pour on some of the stain. Heat as before, allowing to steam for about a minute, wash well in water, dry, and mount in a drop of xylol-balsam.

This method has yielded the best results in our hands.

2. *Löffler's Method.*

Two solutions must be made up as follows : —

A. *The Mordant.*

Tannic acid, 20 per cent aqueous solution	. . 10 c.c.
Ferrous sulphate, cold saturated aqueous solution	. 5 c.c.
Fuchsin, saturated alcoholic solution	. . . 1 c.c.

Mix well, set aside for a few days and filter always before using. This mordant improves with age.

B. *The Stain.* — Either carbol-fuchsin or aniline gentian-violet will be found to be eminently satisfactory if filtered before using.

Make a film as above described, and holding the cover-glass in a pair of forceps, pour on as much of the mordant A as the cover-glass will hold. Heat it carefully above a flame till steam begins to rise and then move the preparation gently in and out of the hot-air column over the flame for about 2 minutes. Wash well in distilled water till every trace of mordant appears to be gone.

If necessary, wash with absolute alcohol till only the film itself appears tinted violet with the mordant. Filter a few drops of stain B on to the cover, again heat till steam rises and leave in the warm stain for 2 minutes. Wash well in distilled water, dry, and mount in xylol-balsam.

3. *Van Ermengen's Method.*

The films are prepared as above described. Three solutions are here necessary:—

Solution A. (*Bain fixateur*)—

Osmic acid, 2 per cent solution	1 part.
Tannin, 10–25 per cent solution	2 parts.

Place the films in this for one hour at room temperature, or heat over a flame till steam rises and keep in the hot stain for five minutes. Wash with distilled water, then with absolute alcohol for three to four minutes, and again in distilled water, and treat with

Solution B. (*Bain sensibilisateur*)—

.5 per cent solution of nitrate of silver in distilled water. Allow films to be in this a few seconds. Then without washing transfer to

Solution C. (*Bain reducteur et renforçateur*)—

Gallic acid	5 grms.
Tannin	3 „
Fused potassium acetate	10 „
Distilled water	350 c.c.

Keep in this for a few seconds. Then treat again with solution B till the preparation begins to turn black. Wash, dry, and mount.

It is better, as Mervyn Gordon recommends, to leave the specimen in B for two minutes and then to transfer to C for one and a half to two minutes, and not to transfer again to B. It will also be found an advantage to use a fresh supply of C for each preparation, a small quantity being sufficient. The beginner will find the typhoid bacillus or the bacillus coli communis very suitable organisms to stain by this method.

Although the results obtained by this method are sometimes excellent, they vary considerably. Frequently both the organisms and flagella appear of abnormal thickness. This is due to the fact that the process on which the method depends is a precipitation rather than a true staining. The pictures on the whole are less faithful than in the first method.

THE TESTING OF AGGLUTINATIVE AND SEDIMENTING PROPERTIES OF SERUM.

By agglutination is meant the aggregation into clumps of uniformly disposed bacteria in a fluid, by sedimentation the formation of a deposit composed of such clumps when the

fluid is allowed to stand. Sedimentation is thus the naked-eye evidence of agglutination. The blood serum may acquire this clumping power towards a particular organism under certain conditions; these being chiefly met with when the individual is suffering from the disease produced by the organism, or has recovered from it, or when a certain degree of immunity has been produced artificially by injections of the organism. The nature of this property will be discussed later. Here we shall only give the technique by which the presence or absence of the property may be tested. There are two chief methods, a microscopic and a naked eye, corresponding to the effects mentioned above. In both, the essential process is the bringing of the diluted serum into contact with the bacteria uniformly disposed in a fluid. In the former this is done on a glass slide, and the result is watched under the microscope; the occurrence of the phenomenon is shown by the aggregation of the bacteria into clumps, and if the organism is motile this change is preceded or accompanied by more or less complete loss of motility. In the latter method the mixture is placed in an upright thin glass tube; sedimentation is shown by the formation within a given time (say 12 or 24 hours) of a somewhat flocculent layer at the bottom, the fluid above being clear. Two points should be attended to; (*a*) controls should always be made with normal serum, and (*b*) the serum to be tested should never be brought in the undiluted condition into contact with the bacteria. The stages of procedure are the following:—

1. Blood is conveniently obtained by pricking the lobe of the ear, which should previously have been washed with a mixture of alcohol and ether and allowed to dry. The blood is drawn up into the bulbous portion of a capillary pipette, such as in Fig. 53, *a*. (These pipettes can be readily made by drawing out quill glass tubing in a flame. It is convenient always to have several ready for use.) The pipette is kept in the upright position, one end being closed. For purposes of transit, break off the bulb at the constriction and seal the ends. After the serum has separated from the coagulum the bulb is broken through near its upper end, and the serum removed by means of another capillary pipette. The serum is then to be diluted.

2. The serum may be diluted (*a*) by means of a graduated pipette—either a leucocytometer pipette (Fig. 53, *b*) or some corresponding form. In this way successive dilutions of 1-10, 1-20, 1-100, etc., can be rapidly made. This is the best method. (*b*) By means of a capillary pipette with a mark on the tube the serum is drawn up to the mark and then blown out into a glass capsule; equal quantities of bouillon are successively measured in the same

way and added till the requisite dilution is obtained. (c) By means of a platinum needle with a loop at the end (Delépine's method). A loopful of serum is placed on a slide, and the desired number of similar loopfuls of bouillon are separately placed around on the slide. The drops are then mixed.

A very convenient and rapid method of combining the steps 1 and 2 is to draw a drop of *blood* up to the mark 1 or .5 on a leucocytometer pipette and draw the bouillon after it till the bulb is filled. A dilution of 10 or 20 times is thus obtained. Then blow the mixture into a U-shaped tube (Fig. 53, c) and centrifugalise or simply allow the red corpuscles to separate by standing. (In this method of course the dilution is really greater than if pure serum were used, and allowance must therefore be made in comparing results.) The presence of red corpuscles is no drawback in the case of the microscopic method, but when sedimentation tubes are used the corpuscles should be separated first.

3. The bacteria to be tested should be taken from young cultures, preferably not more than twenty-four hours old, incubated at 37° C. They may be used either as a bouillon culture or as an emulsion made by adding a small portion of an agar culture to bouillon. In the latter case the mass of bacteria on a platinum loop should be gently broken down at the margin of the fluid in a watch-glass. When a thick turbidity is thus obtained, any remaining fragments should first be removed and then the organisms should be uniformly mixed with the rest of the fluid. The bacterial emulsion ought to have a faint but distinct turbidity. (When the exact degree of sedimenting

power of a serum is to be tested—expressed as the highest dilution in which it produces complete sedimentation within twenty-four hours—a standard quantity (by weight) of bacteria must be added to a given quantity of bouillon. This is not necessary for clinical diagnosis.)

4. To test *microscopically*, mix equal quantities (measured by a marked capillary pipette) of the diluted serum and the bacterial emulsion on a glass slide, cover with a cover-glass and examine under the microscope. The form of glass slide used for hanging-drop cultures (Fig. 34) will be found very suitable. The ultimate dilution of the serum will, of course, be double the original dilution.

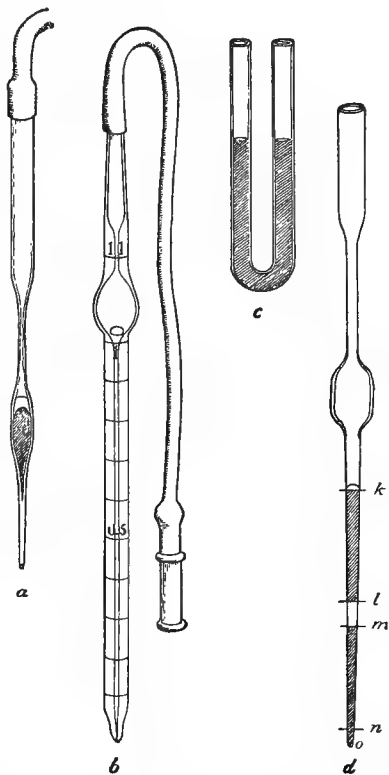

FIG. 53.—Tubes used in testing agglutinating and sedimenting properties of serum.

To observe *sedimentation* mix equal parts of diluted serum and of bacterial emulsion and place in a thin glass tube—a simple tube with closed end or a U-tube. Keep in upright position for twenty-four hours. One of Wright's sedimentation tubes is shown in Fig. 53, *d*. Diluted serum is drawn up to fill the space *mn*, a small quantity of air is sucked up after it to separate it from the bacterial emulsion, which is then drawn up in the same quantity; the diluted serum will then occupy the position *kl*. The fluids are then drawn several times up into the bulb and returned to the capillary tube so as to mix, and finally blown carefully down close to the lower end, which is then sealed off. The sediment collects at the lower extremity.

GENERAL BACTERIOLOGICAL DIAGNOSIS.

Under this heading we have to consider the general routine which is to be observed by the bacteriologist when any material is submitted to him for examination. The object of such examination may be to determine whether any organisms are present, and if so, what organisms; or the bacteriologist may simply be asked whether a particular organism is or is not present. In any case his inquiry must consist (1) of a microscopic examination of the material submitted; (2) of an attempt to isolate the organisms present; and (3) of the identification of the organisms isolated. We must, however, before considering these points look at a matter often neglected by those who seek a bacteriological opinion, viz.: the *proper methods of obtaining and transferring to the bacteriologist the material which he is to be asked to examine*. The general principles here are (1) that every precaution must be adopted to prevent the material from being contaminated with extraneous organisms; (2) that nothing be done which may kill any organisms which may be proper to the inquiry; and (3) that the bacteriologist obtain the material as soon as possible after it has been removed from its natural surroundings.

The sources of materials to be examined, even in pathological bacteriology alone, are of course so varied that we can but mention a few examples. It is, for instance, often necessary to examine the contents of an abscess. Here the skin must be carefully purified by the usual surgical methods; the knife used for the incision is preferably to be sterilised by boiling, the first part of the pus which escapes allowed to flow away (as it might be spoiled by containing some of the antiseptics used in the purification) and a little of what subsequently escapes allowed to flow

into a sterile test-tube. If test-tubes sterilised in a laboratory are not at hand, an ordinary test-tube may be a quarter filled with water, which is then well boiled over a spirit lamp. The tube is then emptied and plugged with a plug of cotton wool, the outside of which has been singed in a flame. Small stoppered bottles may be sterilised and used in the same way. A discharge to be examined may be so small in quantity as to make the procedure described impracticable. It may be caught on a piece of sterile plain gauze, or of plain absorbent wool, which is then placed in a sterile vessel. Wool or gauze used for this purpose, or for swabbing out, say the throat, to obtain shreds of suspicious matter, must have no antiseptic impregnated in it, as the latter may kill the bacteria present and make the obtaining of cultures impossible.

Fluids from the body cavities, urine, etc., may be secured with sterile pipettes. To make one of these, take nine inches of ordinary quill glass tubing, draw out one end to a capillary diameter, and place a little plug of cotton wool in the other end. Insert this tube through the cotton plug of an ordinary test-tube and sterilise by heat. To use it, remove test-tube plug with the quill tube in its centre, suck up some of the fluid into the latter, and replace in its former position in the test-tube. (Fig. 54.) Another method very convenient for transport is to make two constrictions on the glass tube at suitable distances, according to the amount of fluid to be taken. The fluid is then drawn up into the part between the constrictions, but so as not to fill it completely. The tube is then broken through at both constrictions and the thin ends are sealed by heating in a flame.

Solid organs to be examined should, if possible, be obtained whole. They may be treated in one of two ways. 1. The surface over one part about an inch broad is seared with a cautery heated to dull red heat. All superficial organisms are thus killed. An incision is made in this seared zone with a sterile scalpel, and small quantities of the juice are removed by a platinum loop to make cover-glass preparations and plate or smear cultures. 2. An

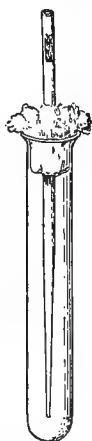

FIG. 54.—Test-tube and pipette arranged for obtaining fluids containing bacteria.

alternative method is as follows: The surface is sterilised by soaking it well with 1 to 1000 corrosive sublimate for half an hour. It is then dried, and the capsule of the organ is cut through with a sterile knife, the incision being further deepened by tearing. In this way a perfectly uncontaminated surface is obtained. Hints are often obtained from the clinical history of the case as to what the procedure ought to be in examination. Thus, as a matter of practice, cultures of tubercle and often of glanders bacilli can be easily obtained only by inoculation experiments. Typhoid bacilli need hardly be looked for in the fæces after the first ten days of the disease, and so on.

Routine Procedure in Bacteriological Examination of Material.

— In the case of a discharge regarding which nothing is known the following procedure should be adopted: (1) Several cover-glass preparations should be made. One ought to be stained with saturated watery methylene-blue, one with a stain containing a mordant such as Ziehl-Neelsen carbol-fuchsin, one by Gram's method. (2) (a) Gelatin plates should be made and kept at room temperature, (b) a series of agar plates or successive strokes on agar tubes (p. 57) should be made and incubated at 37° C. Method (b) of course gives results more quickly. If microscopic investigation reveals the presence of bacteria, it is well to keep the material in a cool place till next day when, if no growth has appeared in the incubated agar, some other culture medium (*e.g.* blood serum or agar smeared with blood) may be employed. If growth has taken place, say in the agar plates, one with about 200 or fewer colonies should be made the chief basis for research. In such a plate the first question to be cleared up is: Do all the colonies present consist of the same bacterium? The shape of the colony, its size, the appearance of the margin, the graining of the substance, its colour, etc., are all to be noted. One precaution is necessary, *viz.*, it must be noted whether the colony is on the surface of the medium or in its substance, as colonies of the same bacterium may exhibit differences according to their position. The arrangement of the bacteria in a surface colony may be still more minutely studied by means of *impression preparations*. A cover-glass is carefully cleaned and sterilised by passing quickly several times through a Bunsen flame. It is then placed on the surface of the medium and gently pressed down on the colony. The edge is then raised by a sterile needle, it is

seized with forceps, dried high over the flame, and treated as an ordinary cover-glass preparation. In this way very characteristic appearances may sometimes be noted and preserved, as in the case of the anthrax bacillus. The colonies on a plate having been classified, a microscopic examination of each group may be made by means of cover-glass preparations, and tubes of gelatin and agar are inoculated from each representative colony. Each of the colonies used must be marked for future reference, preferably by drawing a circle round it on the under surface of the plate or Petri's dish with one of Faber's wax pencils, a number or letter being added for easy reference.

The general lines along which observation is to be made¹ in the case of a particular bacterium may be indicated as follows:—

1. *Microscopic Appearances.*—For ordinary descriptive purposes, young cultures, say of 24 hours' growth, on agar should be used, though appearances in older cultures, such as involution forms, etc., may also require attention. Note (1) the form, (2) the size, (3) the appearance of the protoplasmic contents, especially as regards uniformity or irregularity of staining, (4) the method of grouping, (5) the staining reactions. Has it a capsule? Does the bacterium stain with simple watery solutions? Does it require the use of stains containing mordants? How does it behave towards Gram's method? It is important to investigate the first four points both when the organism is in the fluids or tissues of the body and when growing in artificial media, as slight variations occur. It must also be borne in mind that slight variations are observed, according to the kind and consistence of the medium in which the organism is growing. (6) Is it motile, and has it flagella? If so, how are they arranged? (7) Does it form spores, and if so, under what conditions as to temperature, etc.?

2. *Growth Characteristics.*—Here the most important points on which information is to be asked are, What are the characters of growth, and what are the relations of growth (1) to temperature, (2) to oxygen? These can be answered from some of the following experiments:—

¹The student is asked to consult the recommendations of the Bacteriological Committee of the American Public Health Association, and also Chester's "A Manual of Determinative Bacteriology," where much greater detail is given than is permissible within the size and scope of this work.

A. Growth on gelatin. (1) Stab-culture. Note (*a*) rate of growth; (*b*) form of growth, (*a*) on surface, (*β*) in substance; (*c*) presence or absence of liquefaction; (*d*) colour; (*e*) presence or absence of gas formation and of characteristic smell; (*f*) relation to reaction of medium. (2) Streak-culture. (3) Shake-culture. (4) Plate-cultures. Note appearances of colonies (*a*) superficial, (*b*) deep. (5) Growth in fluid gelatin at 37° C.

B. Growth on agar at 37° C. (1) Stab. (2) Streak. Also on glycerin agar, blood agar, etc. Appearances of colonies in agar plates.

C. Growth in bouillon. (*a*) Character of growth, (*b*) smell, (*c*) reaction.

D. Growth on special media. (1) Solidified blood serum. (2) Potatoes. (3) Lactose and other sugar media. Does fermentation occur, and is gas formed? (4) Milk. Is it curdled or turned sour? (5) Litmus media. Note changes in colour. (6) Peptone solution. Is indol formed?

E. What is the viability of organism on artificial media?

3. *Results of inoculation experiments on animals.*

By attention to such points as these a considerable knowledge is attained regarding the bacterium, which will lead to its identification. In the case of many well-known organisms, however, a few of the above points taken together will often be sufficient for the recognition of the species, and experience teaches what are the essential points as regards any individual organism. In the course of the systematic description of the pathogenic organisms, it will be found that all the above points will be referred to, though not in every case.

The methods by which the morphological and biological characteristics of any growth may be observed have already been fully described. It need only be pointed out here that in giving descriptions of bacteria the greatest care must be taken to state every detail of investigation. Thus in any description of microscopic appearances the age of the growth from which the preparation was made, the medium employed, the temperature at which development took place, must be noted, along with the stain which was used; and with regard to the latter it is always preferable to employ one of the well-known staining combinations, such as Löffler's methylene-blue. Especial care is necessary in stating the size of a bacterium. The apparent size often shows slight variations dependent on the stain used and the growth conditions of the culture. Accurate measurements of bacteria can only be made by preparing microphotographs of a definite magnification and measuring the sizes on the negatives. From these

the actual sizes can easily be calculated. In describing bacterial cultures it must be borne in mind that the appearances often vary with the age. It is suggested that in the case of cultures grown at from 36° to 37° C. the appearances between 24 and 48 hours should be made the basis of description, and in the case of cultures grown between 18° and 22° C. the appearances between 48 and 72 hours should be employed. The culture fluids used must be made up and neutralised by the precise methods already described. The investigator must give every detail of the methods he has employed in order that his observations may be capable of repetition.

INOCULATION OF ANIMALS

The animals generally chosen for inoculation are the mouse, the rat, the guinea-pig, the rabbit, and the pigeon. Great caution must be shown in drawing conclusions from isolated experiments on rabbits, as these animals often manifest exceptional symptoms, and are very easily killed. Dogs are, as a rule, rather insusceptible to microbic disease, and the larger animals are too expensive for ordinary laboratory purposes. In the case of the mouse and rat the variety must be carefully noted, as there are differences in susceptibility between the wild and tame varieties, and between the white and brown varieties of the latter. In the case of the wild varieties, these must be kept in the laboratory for a week or two before use, as in captivity they are apt to die from very slight causes, and, further, each individual should be kept in a separate cage, as they show great tendencies to cannibalism. Of all the ordinary animals the most susceptible to microbic disease is the guinea-pig. Practically all inoculations are performed by means of the hypodermic syringe. The best variety is made on the ordinary model with metal mountings, asbestos washers, and preferably furnished with platinum iridium needles. Before use the syringe and the needle are sterilised by boiling for five minutes. The materials used for inoculation are cultures, animal exudations, or the juice of organs. If the bacteria already exist in a fluid there is no difficulty. The syringe is most conveniently filled out of a shallow conical test-glass which ought previously to have been covered with a cover of filter paper and sterilised. If an inoculation is to be made from organisms growing on the surface of a solid medium, either a little ought to be scraped off and shaken up in sterile distilled water or 75 per cent salt solution to make an emulsion, or a little sterile fluid is poured on the growth and the latter

scraped off into it. This fluid is then filtered into the test-glass through a plug of sterile glass wool. This is easily effected by taking a piece of $\frac{5}{8}$ in. glass tubing 3 in. long, drawing one end out to a fairly narrow point, plugging the tube with glass wool above the point where the narrowing commences, and sterilising by heat. By filtering an emulsion through such a pipette, flocculi which might block the needle are removed. If a solid organ or an old culture is used for inoculation it ought to be rubbed up in a sterile porcelain or metal crucible with a little sterile distilled water, by means of a sterile glass rod, and the emulsion filtered as in the last case.

The methods of inoculation generally used are: (1) by scarification of the skin; (2) by subcutaneous injection; (3) by intraperitoneal injection; (4) by intravenous injection; (5) by injections into special regions, such as the anterior chamber of the eye, the substance of the lung, etc. Of these (2), (3), and (4) are most frequently used. When an anæsthetic is to be administered, this is conveniently done by placing the animal, along with a piece of cotton wool or sponge soaked in chloroform, under a bell-jar or inverted glass beaker of suitable size.

1. *Scarification.*—A few parallel scratches are made in the skin of the abdomen previously cleansed, just sufficiently deep to draw blood, and the infective material is rubbed in with a platinum eyelet. The disadvantage of this method is that the

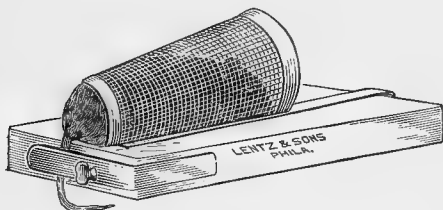

FIG. 55.—Apparatus for holding a mouse preparatory to subcutaneous inoculation.

inoculation is easily contaminated. The method is only occasionally used.

2. *Subcutaneous Injection.*—A hypodermic syringe is charged with the fluid to be inoculated.

The hair is cut off the part to be inoculated, and the skin purified with 1 to 1000 corrosive sublimate. The skin is then pinched up, and, the needle being inserted, the requisite dose is administered. The wound is then sealed with a little collodion.

3. *Intraperitoneal Injection.*—This may be performed by means of a special form of needle. The needle is curved, and

has its opening, not at the point, but in the side in the middle of the arch (Fig. 56). The hair over the lower part of the abdomen is cut, and the skin purified with an antiseptic. The whole thickness of the abdominal walls is then pinched up by an assistant, between the forefingers and thumbs of the two hands. The needle is then plunged through the fold thus formed. The result is that the hole in the side of the needle is within the abdominal cavity, and the inoculation can thus be made. Intraperitoneal inoculation can also be practised with an ordinary needle. The mode of procedure is similar, but after the needle is plunged through the abdominal fold, it is partially withdrawn till the point is felt to be free in the peritoneal cavity, when the injection is made. There is little risk of injuring the intestines by either method.



FIG. 56. — Hollow needle with lateral aperture (at *a*) for intraperitoneal inoculations.

4. *Intravenous Injection.* — The vein most usually chosen is one of the auricular veins; preferably the posterior lateral branch. The part has the hair removed, the skin is purified, and the vein made prominent by pressing on it between the point of inoculation and the heart. The needle is then plunged into the vein and the fluid injected. That it has perforated the vessel will be shown by the escape of a little blood; and that the injection has taken place into the lumen of the vessel will be known by the absence of the small swelling which occurs in subcutaneous injections. If preferred, the vein may be first laid bare by snipping the skin over it. The needle is then introduced.

5. *Inoculation into the Anterior Chamber of the Eye.* — Local anæsthesia is established by applying a few drops of 2 per cent solution of hydrochlorate of cocaine. The eye is fixed by pinching up the orbital conjunctiva with a pair of fine forceps, and the edge of the cornea being perforated by the hypodermic needle, the injection is easily accomplished.

Sometimes inoculations are made by planting small pieces of pathological tissues in the subcutaneous tissue. This is especially done in the case of glanders and tubercle. The skin over the back is purified, and the hair cut. A small incision is made with a sterile knife, and the skin being separated from the subjacent

tissues by means of the ends of a blunt pair of forceps, a little pocket is formed into which a piece of the suspected tissue is inserted. The wound is then closed with a suture, and collodion is applied. In the case of guinea-pigs, the abdominal wall is to be preferred as the site of inoculation, as the skin over the back is extremely thick.

Injections are sometimes made into other parts of the body, *e.g.* the pleuræ and the cranium. It is unnecessary to describe these, as the application of the general principles employed above, together with those of modern aseptic surgery, will sufficiently guide the investigator as to the technique which is requisite.

After inoculation, the animals ought to be kept in comfortable cages, which must be capable of easy and thorough disinfection subsequently. For this purpose galvanised iron wire cages are the best. They can easily be sterilised by boiling them in the large fish-kettle which it is useful to have in a bacteriological laboratory for such a purpose. It is preferable to have the cages opening from above. Otherwise material which may be infective may be scratched out of the cage by the animal. The general condition of the animal is to be observed, how far it differs from the normal, whether there is increased rapidity of breathing, etc. The temperature is usually to be taken. This is generally done *per rectum*. The thermometer (the ordinary 5 min. clinical variety) is smeared with vaseline, and the bulb inserted just within the sphincter, where it is allowed to remain for a minute; it is then pushed well into the rectum, again remaining for five minutes. If this precaution be not adopted, a reflex contraction of the vessels may take place, which is likely to vitiate the result by giving too low a reading.

Autopsies on Animals dead or killed after Inoculation.— These should be made as soon as possible after death. It is necessary to have some shallow troughs, constructed either of metal or of wood covered with metal, conveniently with sheet lead, and having a perforation at each corner to admit a tape or strong cord. The animal is tightly stretched out in the trough and tied in position. The size of the trough will, therefore, have to vary with the size of the outstretched body of the animal to be examined. In certain cases it is well to soak the surface of the animal in carbolic acid solution (1 to 20), or in corrosive

sublimate (1 to 1000), before it is tied out. This not only to a certain extent disinfects the skin, but, what is more important, prevents hairs which might be affected with pathogenic products from getting into the air of the laboratory. The instruments necessary are scalpels (preferably with metal handles), dissecting forceps, and scissors. They are to be sterilised by boiling for five minutes. This is conveniently done in one of the small portable sterilisers used by surgeons. Two sets at least ought to be used in an autopsy, and they may be placed, after boiling, on a sterile glass plate covered by a bell-jar. It is also necessary to have a medium-sized hatchet-shaped cautery, or other similar piece of metal. It is well to have prepared a few freshly drawn-out capillary tubes stored in a sterile cylindrical glass vessel, and also some larger sterile glass pipettes. The hair of the abdomen of the animal is removed. If some of the peritoneal fluid is wanted, a band should be cauterised down the linea alba from the sternum to the pubes, and another at right angles to the upper end of this; an incision should be made in the middle of these bands, and the abdominal walls thrown to each side. One or more capillary tubes should then be filled with the fluid collected in the flanks, the fluid being allowed to run up the tube and the point sealed off; or a larger quantity, if desired, is taken in a sterile pipette. If peritoneal fluid be not wanted, then an incision may be made from the episternum to the pubes, and the thorax and abdomen opened in the usual way. The organs ought to be removed with another set of instruments, and it is convenient to place them pending examination in sterilised deep Petri's dishes. It is generally advisable to make cultures and film preparations from the heart's blood. To do this, open the pericardium, sear the front of the right ventricle with a cautery, make an incision in the middle of the part seared, and remove some of the blood with a capillary tube for future examination, or, introducing a platinum eyelet, inoculate tubes and make cover-glass preparations at once. To examine any organ, sear the surface with a cautery, cut into it, and inoculate tubes and make film preparations with a platinum loop. For removing small parts of organs for making inoculations on tubes, a small platinum spud is very useful, as the ordinary wires are apt to become bent. Place pieces of the organs in some preservative fluid for microscopic examination. The organs ought not to be

touched with the fingers. When the *post mortem* is concluded the body should have corrosive sublimate or carbolic acid solution poured over it, and be forthwith burned. The dissecting trough and all the instruments ought to be boiled for half an hour. The amount of precaution to be taken will, of course, depend on the character of the bacterium under investigation, but as a general rule every care should be used.

CHAPTER IV.

BACTERIA IN AIR, SOIL, AND WATER. ANTISEPTICS.

It is impossible here to do more than indicate the chief methods which are employed by bacteriologists in the investigation of the bacteria present in air, soil, and water, and to add an outline of the chief results obtained. In dealing with the latter the subject has been approached mainly from the standpoint of the bearings which the results have towards human pathology. In dealing with antiseptics, so far as possible the effects of the various agents on the chief pathogenic bacteria have been given, though in many cases our information is very imperfect.

AIR.

Very little information of value can be obtained from the examination of the air, but the following are the chief methods used, along with the results obtained. More can be learned from the examination of atmospheres experimentally contaminated than by the investigation of the air as it exists under natural conditions.

Methods of Examination.—The methods employed vary with the objects in view. If it be sought to compare the relative richness of different atmospheres in organisms, and if the atmospheres in question be fairly quiescent, then it is sufficient to expose gelatin plates for definite times in the rooms to be examined. Bacteria, or the particles of dust carrying them, fall on the plates, and from the number of colonies which develop a rough idea of the richness of the air in bacteria can be obtained. Petri states that in five minutes the number of bacteria present in 10 litres of air are deposited on 100 square centimetres of a gelatin plate.

More complete results are available when some method is employed by which the bacteria in a given quantity of air are examined. The oldest method employed, and one which is still used, is that of Hesse. The apparatus is shown in Fig. 57. It consists of a cylindrical tube *a* about 20 inches long and 2 inches in diameter. At one end this is closed by a rubber cork having a piece of quill tubing *f* passing through it and projecting some distance into the interior. For use the tube is sterilised in a tall Koch,

and then a quantity of peptone gelatin, sufficient to cover the whole interior to the thickness of an ordinary gelatin plate, is poured in. This gelatin is kept from escaping by the projection of the quill tubing into the lumen of the large tube. A plug of cotton wool is now placed in the outer end of the quill tubing.

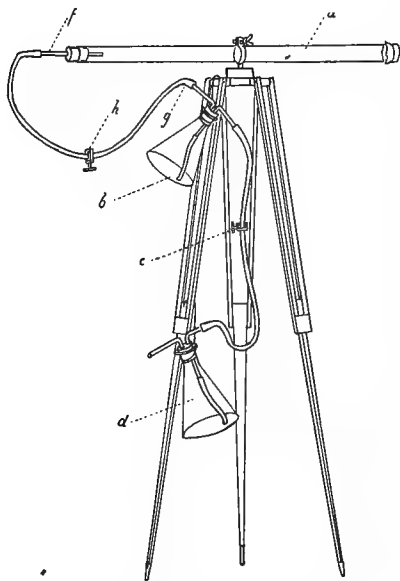

FIG. 57.—Hesse's tube, mounted for use.

Over the other end of the large tube is tied a sheet of rubber having a hole about a quarter of an inch in diameter in its centre, and over this again is tied a piece of similar but unperforated sheet rubber. The tube is then sterilised in the tall Koch. On removal from this it is rolled, after the manner of an Esmarch's tube (*q.v.*) till the gelatin is set as a layer over its interior, and it is then placed horizontally on the tripod as shown. The other part of the apparatus is an aspirator by means of which a known quantity of air can be brought in contact with the gelatin. It consists of two conical glass flasks connected by means of a tube which passes through the cork of each down to the bottom of the flask. When this tube is filled with water, it, of course, can act as a syphon tube between volumes of water in the flasks. Such a syphon system being established, the levels of the water are marked on the flasks, and to one a litre of water is added, and by depressing flask *b* the whole litre can be got into it and the connecting tube *c* is then clamped. The two flasks are then connected by a rubber tube with the tube *f*, the clamp on *c* is opened, and the passing of a litre of water into *d* will draw a litre of air through the gelatin tube, when the outer rubber sheet is removed from the end and the clamp *h* opened. By disconnecting at *g* and reversing the syphon flasks, another litre can be sucked through, and so any desired quantity of air can be brought in contact with the gelatin. The speed ought not to be more than 1 litre in two minutes, and in such a case practically all the organisms will be found to have fallen out of the air on to the gelatin in the course of their transit. This fact can be tested by interposing between the tube *a* and the aspirator a second tube prepared in the same way, which ought, of course, to show no growth. When forty-eight hours at 20° C. or four days at lower temperature have elapsed, the colonies which develop in *a* may be counted. The disadvantage of the method is that if particles of dust carrying more than one bacterium alight on the gelatin, these bacteria develop in one colony, and thus the enumeration results may be too low; difficulties may also arise from liquefying colonies developing in the upper parts of the tube and running over the gelatin.

Petri's Sand-filter Method.—A glass tube open at both ends, and about $3\frac{1}{2}$ inches long and half an inch wide, is taken, and in its centre is placed a transverse diaphragm of very fine iron gauze (Fig. 58, *e*); on each side of this is placed some fine quartz sand which has been well washed, dried, and burned to remove all impurities, and this is kept in position by cotton plugs. The whole is sterilised by dry heat. One plug is removed and a sterile rubber cork *c* inserted, through which a tube *d* passes to an exhausting apparatus. The tube is then clamped in an upright position in the atmosphere to be examined, with the remaining plug *f* uppermost. The latter is removed and the air sucked through. Difficulty may be experienced from the resistance of the sand if quick filtration be attempted. The best means to adopt is to use an air-pump

—the amount of air drawn per stroke of which is accurately known—and have a manometer (as in Fig. 38) interposed between the tube and the pump. Between each two strokes of the air-pump the mercury is allowed to return to zero. After the required amount of air has passed, the sand *a* is removed, and is distributed among a number of sterile gelatin tubes which are well shaken; plate-cultures are then made, and when growth has occurred the colonies are enumerated; the sand *b* is similarly treated and acts as a control.

The Sedgwick-Tucker Method.—A third and better method is that of Sedgwick and Tucker, whose apparatus combines the qualities of both filter and culture tubes, whilst the employment of finely granulated sugar as the filtering medium removes the very obvious objections to the use of sand. The apparatus consists of a glass tube some 30 or 35 cm. long and 4 cm. wide, drawn out at one end into a neck to retain a cotton plug, whilst into the other end is fused a smaller piece of glass tubing about 15 cm. long and .5 cm. wide. The surface of the larger portion is ruled by a diamond into square centimetres to facilitate the counting of colonies (see Fig. 59). To retain the filtering medium in position, a small piece of tightly rolled fine-meshed brass-wire cloth is inserted into this narrow tubing about 5 cm. from its lower end. After cleansing and drying, the bore of the smaller part of the apparatus is filled with No. 50 granulated sugar, which is lightly packed by gently tapping, both ends are

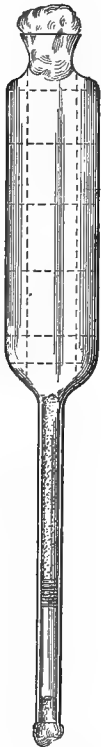

By permission, from Abbott's
"Bacteriology."

FIG. 59.—The Sedgwick-Tucker
aerobioscope.

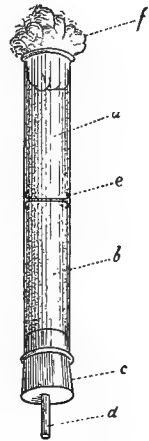

FIG. 58.—Petri's
sand filters.

plugged with cotton, and the filter is then sterilised for two or three hours at 120° C.—a higher temperature is liable to char the sugar. When used, the filter is to be affixed by its lower end to the aspirating pump and kept in an upright position, the upper plug of cotton is now removed and aspiration carried out. When this is ended, the cotton plug, having meantime been placed in a sterile receptacle, is re-inserted, the apparatus disconnected, the sugar by gentle rapping transferred to the upper portion, 15 c.c. of sterile liquefied gelatin poured into the filter, the filter plugged, and the sugar dissolved. The filter is now to be treated as an Esmarch roll-tube, by being rolled on ice until the gelatin sets, when the apparatus is set aside at room temperature for incubation. This method gives very accurate results.

When it is necessary to examine air for particular organisms, special methods must often be adopted. Thus in the case of the suspected presence of tubercle bacilli a given quantity of air is drawn through a small quantity of water and then injected into a guinea-pig.

It must be admitted that comparatively little information bearing on the harmlessness or harmfulness of the air is obtainable by the mere enumeration of the living organisms present, for under certain conditions the number may be increased by the presence of many individuals of a purely non-pathogenic character. The organisms found in the air belong to two groups—firstly, a great variety of bacteria; secondly, yeasts and the spores of moulds and of the lower fungi. With regard to the spores, the organisms from which they are derived often consist of felted masses of threads, from which are thrust into the air special filaments, and in connection with these the spores are formed. By currents of air these latter can easily be detached, and may float about in a free condition. With the bacteria, on the other hand, the case is different. Usually these are growing together in little masses on organic materials, or in fluids, and it is only by the detachment of minute particles of the substratum that the organisms become free. The entrance of bacteria into the air, therefore, is associated with conditions which favour the presence of dust, minute droplets of fluid, etc. The presence of dust in particular would specially favour a large number of bacteria being observed, and this is the case with the air in many industrial conditions, where the bacteria, though numerous, may be quite innocuous. Great numbers of bacteria thus may not indicate any condition likely to injure health, and this may be true also even when the bacteria come from the crowding together of a number of healthy human beings. On the other hand,

there is no doubt that disease germs can be disseminated by means of the air. The possibility of this has been shown experimentally by infecting the mouth with the *B. prodigiosus*, which is easily recognised by its brilliantly coloured colonies, and then studying its subsequent distribution. Most important here is the infection of the air from sick persons. The actions of coughing, sneezing, speaking, and even of deep breathing, distribute, often to a considerable distance, minute droplets of secretions from the mouth, throat, and nose, and these may float in the air for a considerable time. Even five hours after an atmosphere has been thus infected evidence may be found of bacteria still floating free. Before this time, however, most of the bacteria have settled upon various objects, where they rapidly dry, and are no longer displaceable by ordinary air currents. The diseases of known etiology where infection can thus take place are diphtheria, influenza, pneumonia, and phthisis; and here also probably whooping-cough, typhus fever, and measles are to be added, though the morbid agents are unknown. In the case of phthisis, the alighting of tubercle bacilli has been demonstrated on cover-glasses held before the mouths of patients while talking, and animals made to breathe directly in front of the mouths of such patients have become infected with tuberculosis. Apart from direct infection from individuals, however, pathogenic bacteria may be spread in some cases from the splashing of infected water, as from a sewage outfall. This possibility has to be recognised especially in the cases of typhoid and cholera. Besides infection through fluid particles, infection can be caused in the air by dust coming, say, from infected skin or clothes, etc. Flügge, in dealing with this subject in an experimental inquiry, distinguishes between large particles of dust which require an air current moving at the rate of 1 cm. per second to keep them suspended, and the finer dust which can be kept in suspension by currents moving at from 1 to 4 mm. per second. In the former case, when once the particles alight they cannot be displaced by currents of air except when these are moving at, at least, 5 m. per second, but the brushing, shaking, or beating of objects may, of course, distribute them. In the case of the finer dust the particles will remain for long suspended, and when they have settled can be more easily displaced, as by the waving of an arm, breathing, etc. With regard

to infection by dust, a most important factor, however, is whether or not the infecting agent can preserve its vitality in a dry condition. In the case of a sporing organism such as anthrax, vitality is preserved for long periods of time, and great resistance to drying is also possessed by the tubercle and diphtheria bacilli; but apart from such cases there is little doubt that infection is usually necessarily associated with the transport of most particles, and is thus confined to a limited area around a sick person. Among diseases which may occasionally be thus spread cholera and typhoid have been classed. Considerable controversy has arisen with regard to certain outbreaks of the latter disease, which have apparently been spread by dusty winds, although we have the fact that the typhoid bacillus does not survive being dried even for a short time. It appears, however, that in such epidemics the transport of infection by means of insects carried by the wind has not been entirely excluded; in fact, the common house-fly comes strongly under suspicion of being the carrier of infection during epidemics of typhoid fever and cholera, where fecal discharges may have been carelessly disposed of.

SOIL.

The investigation of the bacteria which may be found in the soil is undertaken from various points of view. Information may be desired as to the change its composition undergoes by a bacterial action, the result of which may be an increase in fertility and thus in economic value. Under this head may be grouped inquiries relating to the bacteria which convert ammonia and its salts into nitrates and nitrites, and to the organisms concerned in the fixation of the free nitrogen of the air. The discussion of the questions involved in such inquiries is outside the scope of the present chapter, which is more concerned with the relation of the bacteriology of the soil to questions of public health. So far as this narrower view is concerned, soil bacteria are chiefly of importance in so far as they can be washed out of the soils into potable water supplies. An important aspect of this question thus is as to the significance of certain bacteriological appearances in a water in relation to the soil from which it has come or over which it has flowed. In this country (Great Britain) these questions have been chiefly

investigated by Houston, and it is from his papers that the following account is chiefly taken.

Methods of Examination. — For examination of soil on surface or not far from surface, Houston recommends tin troughs 10 in. by 3 in. and pointed at one extremity, to be wrapped in layers of paper and sterilised by dry heat. If several of these be provided, then the soil can be well rubbed up and a sample secured and placed in a sterile test-tube for examination as soon as convenient after collection. If samples are to be taken at some depth beneath the surface, then a special instrument, of which many varieties have been devised, must be used. The general form of these is that of a gigantic gimlet stoutly made of steel. Just above the point of the instrument the shaft has in it a hollow chamber, and a sliding lateral door in this can be opened and shut by a mechanism controlled at the handle. The chamber being sterilised and closed, the instrument is bored to the required depth, the door is slid back, and by varying devices it is effected that the chamber is filled with earth; the door is closed and the instrument withdrawn.

In any soil the two important lines of inquiry are first as to the total number of organisms (usually reckoned per gramme of the fresh sample), and secondly as to the varieties of organisms present. The number of organisms present in a soil is often, however, so enormous that it is convenient to submit only a fraction of a gramme to examination. The method employed is to weigh the tube containing the soil, shake out an amount of about the size of a bean into a litre of distilled water, and re-weigh the tube. The amount placed in the water is distributed as thoroughly as possible by shaking, and, if necessary, by rubbing down with a sterile glass rod, and small quantities measured from a graduated pipette are used for the investigation. For estimating the total number of organisms present in the portion of soil used, small quantities, say .1 c.c. and 1 c.c., of the fluid are added to melted tubes of ordinary alkaline peptone gelatin; after being shaken, the gelatin is plated, incubated at 22° C., and the colonies are counted as late as the liquefaction, which always occurs round some of them, will allow. From these numbers the total number of organisms present in the amount of soil originally present can be calculated.

The numbers of bacteria in the soil vary very much. According to Houston's results, fewest occur in uncultivated sandy soils, these containing on an average 100,000 per gramme. Peaty soils, though rich in organic matter, also give low results, it being possible that the acidity of such soils inhibits free bacterial growth. Garden soils yield usually about 1,500,000 bacteria per gramme, but the greatest numbers are found in soils which have been polluted by sewage, when the figures may rise to 115,000,000. In addition to the enumeration of the numbers of bacteria present, it is a question whether something may not be gained from a knowledge of the number of spores present in a soil relative to the total number of bacteria. This is a

point which demands further inquiry, especially by the periodic investigation of examples of different classes of soils. The method is to take 1 c.c. of such a soil emulsion as that just described, add it to 10 c.c. of gelatin, heat for ten minutes at 80° C. to destroy the non-spored bacteria, plate, incubate, and count as before.

Besides the enumeration of the numbers of bacteria present in a soil, an important question in its bacteriological examination lies in inquiring what kinds of bacteria are present in any particular case. Practically this resolves itself into studying the most common bacteria present, for the complete examination of the bacterial flora of any one sample would occupy far too much time. Of these common bacteria the most important are those from whose presence indications can be gathered of the contamination of the soil by sewage, for from the public health standpoint this is by far the most important question on which bacteriology can shed light.

Bacillus mycoides. — This bacillus is 1.6 to 2.4 μ in length and about .9 μ in breadth. It grows in long threads which often show motility. It can be readily stained by such a combination as carbol-thionin, and retains the dye in Gram's method. All ordinary media will support its growth, and in surface growths on agar or potato spore formation is readily produced. Its optimum temperature is about 18° C. On gelatin plates it shows a very characteristic appearance. At first under a low power it shows a felted mass of filaments throwing out irregular shoots from the centre, and later to the naked eye these appear to be in the form of thick threads like the growth of a mould. They rapidly spread over the surface of the medium, and the whole resembles a piece of wet teased-out cotton wool. The gelatin is liquefied.

Cladothrices. — Of these several kinds are common in the soil. The ordinary *cladothrix dichotoma* is among them. This organism appears as colourless flocculent growth with an opaque centre, and can be seen under the microscope to send out into the medium apparently branched threads which vary in thickness, being sometimes 2 μ across. They consist of rods enclosed in a sheath. These rods may divide at any point, and thus the terminal elements may be pushed along the sheath. Sometimes the sheath ruptures, and thus by the extrusion of these dividing cells and their further division the branching appearance is originated. Reproduction takes place by the formation of gonidia in the interior of the terminal cells. These gonidia acquire at one end a bundle of flagella, and for some time swim free before becoming attached and forming a new colony. Houston describes as occurring in the soil another variety, which with similar microscopic characters appears as a brownish growth with a pitted surface, and diffusing a Bismarck-brown pigment into the gelatin which it liquefies.

A few experiments made with an ordinary field soil will, however, famil-

iarise the worker with the non-pathogenic bacteria usually present. We have referred to these two because of their importance. In regard to pathogenic organisms, especially in relation to possible sewage contamination, attention is to be directed to three groups of organisms, those resembling the *B. coli*, the bacillus enteritidis sporogenes, and the streptococcus pyogenes. The characters of the first two of these will be found in the chapter on Typhoid Fever; of the third in Chapter VII. For the detection of these bacteria Houston recommends the following procedure:—

(a) The *B. coli* group. A third of a gramme of soil is added to 10 c.c. phenol broth (*vide* chapter on Typhoid Fever) and incubated at 37° C. In this medium very few if any other bacteria except those of the *B. coli* group will grow, so that if after twenty-four hours a turbidity appears, some of the latter may be suspected to be present. In such a case a loopful of the broth is shaken up in 5 c.c. sterile distilled water, and of this one or two loopfuls are spread over the surface of a solid plate of phenol gelatin in a Petri's dish either by means of the loop or of a small platinum spatula, and the plate is incubated at 20° C. Any colonies which resemble *B. coli* are then examined by the culture methods detailed under that organism. Further, all organisms having the microscopic appearances of *B. coli*, and which generally conform to its culture reactions, are to be reckoned in the *coli* group.

(b) The *Bacillus enteritidis sporogenes*. To search for this organism one gramme of the soil is thoroughly distributed in 100 c.c. sterile distilled water, and of this 1 c.c., .1 c.c., and .01 c.c. is added to each of three sterile milk tubes. These are heated to 80° C. for ten minutes and then cultivated anaerobically at 37° C. for twenty-four hours. If the characteristic appearances seen in such cultures of the *B. enteritidis* (*q.v.*) are developed, then it may fairly safely be deduced that it is this organism which has produced them.

(c) The *Streptococcus pyogenes*. The method here is to pour out a tube of agar into a Petri's dish, and when it has solidified to spread out .1 c.c. of the emulsion of soil over it and incubate at 37° C. for twenty-four hours. At this temperature many of the non-pathogenic bacteria grow with difficulty, and thus the number of colonies which develop is relatively small. Colonies having appearances resembling those of the streptococcus (*q.v.*) can thus be investigated.

We may now give in brief the results at which Houston has arrived by the application of these methods. First of all, un-cultivated soils contain very few, if any, representatives of the *B. mycoides*, and this is also true to a less extent of the cladotriches. Cultivated soils, on the other hand, do practically always contain these organisms. With regard to the *B. coli*, its presence in a soil must be looked on as indicative of recent pollution with excremental matter. The presence of *B. enteritidis sporogenes* is also evidence of such pollution, but from the fact that it is a sporing organism this pollution may not have been recent. With regard to the streptococci, on the other hand, the

opinion is advanced that their presence is, on account of their want of viability outside the animal body, to be looked on as evidence of extremely recent excremental pollution. The very great importance of these results in relation to the bacteriological examination of water supplies will be at once apparent, and will be referred to again in connection with the subject of water.

While such means have been advanced for the obtaining of indirect evidence of excremental pollution of soil, and therefore of a pollution dangerous to health from the possible presence of pathogenic organisms in excreta, investigations have also been conducted with regard to the viability in the soil of pathogenic bacteria, especially of those likely to be present in excreta, namely, the typhoid and cholera organisms. The solution of this problem is attended with difficulty, as it is not easy to identify these organisms when they are present in such bacterial mixtures as naturally occur in the soil. Now there is evidence that bacteria when growing together often influence each other's growth in an unfavourable way, so that it is only by studying the organisms in question when growing in unsterilised soils that information can be obtained as to what occurs in nature. For instance, it has been found that the *B. typhosus*, when grown in an organically polluted soil which has been sterilised, can maintain its vitality for fifteen weeks, but if the conditions occurring naturally be so far imitated by growing it in soil in the presence of a pure culture of one or other certain soil bacteria, it is found that sometimes the typhoid bacillus, sometimes the soil bacterium, in the course of a few weeks, or even in a few days, disappears. Further, the character of the soil exercises an important effect on what happens; for instance, the typhoid bacillus soon dies out in a virgin sandy soil, even when it is the only organism present. In experiments made by sowing cultures of cholera and diphtheria in plots in a field it was found that after, at the longest, forty days they were no longer recognisable. Further, it is a question whether ordinary disease organisms, even if they remain alive, can multiply to any great extent in nature. If we are dealing with a sporing organism such as the *B. anthracis*, the capacity for remaining in a quiescent condition of potential pathogenicity is, of course, much greater.

WATER.

In the bacteriological examination of water three lines of inquiry may have to be followed. First, the number of bacteria per cubic centimetre may be estimated. Second, the kinds of bacteria present may be investigated. Third, it may be necessary to ask if a particular organism is present, and, if so, in what number per cubic centimetre it occurs.

Methods. — All samples of water taken for analysis should be, if possible, treated at once by one or other of the methods indicated below. This is especially necessary in warm weather, where the delay even of an hour or two in transportation of the sample to the laboratory will greatly increase the number of bacteria present, and lead to erroneous ideas of the actual character of the water under examination. When transportation is unavoidable, the samples should be packed in ice, and sent forward with the shortest possible delay to the laboratory. The collection of water is usually made in four-ounce, wide-mouthed, stoppered bottles, which are to be sterilised by dry heat (the stopper must be sterilised separately from the bottle, and not inserted in the latter until both are cold; otherwise it will be so tightly held as to make removal very difficult). In using such a bottle for collecting water from rivers, ponds, or lakes at various depths it is advisable to make use of one of the several mechanical devices commonly used for such work (see Fig. 60), in which the bottle is secured in a metal frame at one end of a graduated pole, and lowered into the water; the stopper then is extracted half its distance up the neck of the bottle by pulling upon a spring-wire attachment which clutches the stopper, and when the bottle is full the wire being released from the finger carries back the stopper into place. The operator is warned not to touch the water-bed in making a collection, nor surface scum, for such contain large numbers of bacteria, and in the collection of water from a house-tap it is advisable that the water be let run for at least an hour or two previous to taking the sample.

Upon arrival at the laboratory, if the samples had to be transported, the bottles are shaken vigorously and by means of sterile pipettes of 1 c.c. capacity, divided into tenths, quantities of water varying from $\frac{1}{10}$ to 1 c.c. are transferred to melted tubes of gelatin or agar, whose reaction is 1.5+ (acid), and plated, and incubated at a temperature not over 22° C. nor under 16° C. Where a water is suspected to contain large numbers of bacteria it is well to transfer 1 c.c. to a small flask containing 99 c.c. of sterile water, and, shaking thoroughly,



FIG. 60. — Apparatus for collecting water samples (after Abbott).

remove fractions of a cubic centimetre as before, and place in the incubator. Upon the second, third, and fourth days the colonies which have developed should be counted by means of Lafar's counter (if Petri's dishes have been used) or a Wolffhügel apparatus if glass plates were employed (see Fig. 37). These counters are suitable pieces of glass upon whose surfaces are ruled square centimetres and fractions thereof, which render errors in counting very small indeed.

Where a plate contains comparatively few colonies the whole number of squares should be counted, but where a large number of colonies are present one may count ten or fifteen representative squares at random and determine approximately the total number of colonies present. All such counts are then to be properly reckoned as bacteria per cubic centimetre, allowing that each colony has originated from a single bacterium (this is not, however, strictly the case, but where the sample has been vigorously shaken before plating, it is for all practical purposes sufficiently near the truth).

Regarding what may be considered as an impure water and one to be condemned, no hard and fast statement can be made, for under natural conditions some waters contain a much higher number of bacteria than do others. So to arrive at a proper basis for judging of the conditions of purity or impurity, frequent repeated analyses must be made throughout a year with especial reference to species determination, more particularly as regards the presence of bacillus coli, and the condition of the watershed rigidly examined.

With regard to the objects with which the bacteriological examination of water may be undertaken, though these may be of a purely scientific character, they usually aim at contributing to the settlement of questions relating to the potability of waters, to their use in commerce, and to the efficiency of processes undertaken for the purification of waters which have undergone pollution. The last of these objects is often closely associated with the first two, as the question so often arises whether a purification process is so efficient as to make the water again fit for use.

Water derived from any natural source contains bacteria, though, as in the case of some artesian wells and some springs, the numbers may be very small, *e.g.* 4 to 100 per c.c. In rain, snow, and ice there are often great numbers, those in the first two being derived from the air. Great attention has been paid to the bacterial content of wells and rivers. With regard to the former, precautions are necessary in arriving at a judgment. If the water in a well has been standing for some time, multiplication of bacteria may give a high value. To meet this difficulty, if practicable the well ought to be pumped dry and then allowed to fill, in order to get at what is really the important point,

namely, the bacterial content of the water entering the well. Again, if the sediment of the well has been stirred up a high value is obtained. Ordinary wells of medium depth contain from 100 to 2000 per c.c. With regard to rivers very varied results are obtained. In any one river the numbers present vary at different seasons of the year, whilst the prevailing temperature, the presence or absence of decaying vegetation, or of washings from land, and dilution with large quantities of pure spring water, are other important features. Thus the Franklands found the rivers Thames and Lea purest in summer, and this they attributed to the fact that in this season there is most spring water entering, and very little water as washings off land. In the case of other rivers the bacteria have been found to be fewest in winter. Thus a great many circumstances must be taken into account in dealing with mere enumerations of water bacteria. Such enumerations are only useful when they are taken simultaneously over a stretch of river, with special reference to the sources of the water entering the river. Thus it is usually found that immediately below a sewage effluent the bacterial content rises, though in a comparatively short distance the numbers may decrease enormously, and it may be that the river as far as numbers are concerned may appear to return to its previous bacterial content. The numbers of bacteria present in rivers vary so enormously that there is little use in quoting figures, most information being obtainable by comparative enumerations before and after a given event has occurred to a particular water. Such a method is thus of great use in estimating the efficacy of the filter beds of a town water supply. These usually remove from 95 to 98 per cent of the bacteria present. Again, it is found that the storage of water diminishes the number of bacteria present. The highest counts of bacteria per c.c. are observed with sewage; for example, in the London sewage the numbers range from six to twelve millions.

Much more important than the mere enumeration of the bacteria present in a water is the question whether these include forms pathogenic to man. The chief interest here, so far as Europe is concerned, lies in the fact that typhoid fever is so frequently water-borne, but cholera and certain other intestinal diseases have a similar source. The search in waters for the organisms concerned in these diseases is a matter of the greatest

difficulty, for each belongs to a group of organisms morphologically similar, very widespread in nature, and many of which have little or no pathogenic action. The biological characters of these organisms will be given in the chapters devoted to the diseases in question, but here it may be said that from the public health standpoint the making of their being found a criterion for the condemning of a water is impracticable. There is no doubt that the typhoid and cholera bacteria can exist for some time in water—at least this has been found to be the case when sterile water has been inoculated with these bacteria. But to what extent the same is true when they are placed in natural conditions, which involve their living in the presence of other organisms, is unknown, for it may be safely said that by no known method can the presence of either be demonstrated in the complex mixtures which occur in nature. With regard to the typhoid bacillus, of late the tendency has been to seek for the presence of indirect bacteriological evidence which might point in the direction of the possibility of the presence of this organism.

Methods of detecting *B. coli* in Water.—The isolation of *B. coli* is brought about in several ways. One method aims at giving the total number of colonies per cubic centimetre by plating various fractions of 1 c.c. in a 2 per cent lactose agar, to which neutral litmus tincture has been added, and incubating at 37° C. It is found that a large number of water bacteria will not grow at this temperature, whereas *B. coli* grows well, its colonies becoming coloured red by the action of the bacilli on the lactose and thus are readily identified.

Theobald Smith recommends the use of the fermentation tube. A series of such tubes, containing 1 to 2 per cent of glucose broth, are inoculated with variable quantities of water and incubated for 48 hours at 37° C., and those showing 25–40 per cent of gas are removed and plates made from their contents and search made for the presence of *B. coli* by the usual cultural tests.

Stone has broadened the application of the fermentation method of Smith by removing .5 c.c. of the contents of those tubes showing the proper quantity of gas, and adding it to a tube containing 10 c.c. of neutral broth and .3 c.c. of Parietti's solution,¹ and placing in the thermostat for 24 hours at 38° C. If growth results, .5 c.c. is removed to a fermentation tube and incubated as before; then if no gas is formed it is presumed that the fermenting organism met with was not *B. coli*, but on the other hand, if gas is formed *B. coli* is doubtless present and can readily be identified by plating out and cultivating on the various media.

1 Parietti's solution consists of	Carbolic acid	.	.	5 grammes.
	Hydrochloric acid (pure)	.	.	4 "
	Water (distilled)	.	.	100 cc.

MacConkey has devised bile-salt media, which he claims is of great aid in identifying *B. coli* and its close relations. Incubation must proceed at 42° C.

<i>A. Bile-salt Agar.</i>	<i>B. Bile-salt Broth.</i>
Agar 1.5 grms.	Sodium taurocholate (pure) 0.5 grms.
Sodium taurocholate (pure) .5 "	Peptone 2.0 "
Peptone 2.0 "	Glucose 0.5 "
Water 100.0 c.c.	Water 100.0 c.c.
This is boiled, clarified, and filtered as usual, then,	Boil, filter, and add sufficient neutral litmus; fill fermentation tubes (Smith's or Durham's) and sterilise as usual in Koch steriliser.
Lactose 1.0 gm.	
is added, and the medium tubed and sterilised for three successive days in a Koch steriliser.	

In the agar medium the surface colonies of *B. coli* are found to be large, round, whitish, with yellow centres and quite opaque, whilst in the medium surrounding the deep colonies is a distinct hazy halo around each, which soon diffuses throughout the entire medium, if the deep colonies are at all numerous. The high temperature of incubation, in combination with the ingredients, proves unfavourable to development of bacteria other than intestinal forms. Grünbaum and Hume advise the addition of 1 per cent of a half per cent watery solution of neutral red to this medium, its qualities being thereby greatly enhanced. Surface colonies of *B. coli*, and the medium in their immediate locality, are coloured a bright violet-red, whilst the typhoid colonies are yellowish-white, and the medium surrounding them assumes an amber hue. This reaction is very sharp if the medium, before sterilisation, is standardised by adding .4 cc. normal sodium hydrate solution per litre, after making neutral to litmus. Where the broth is used, gas-formation and cloudiness betoken the presence of *B. coli*; in absence of gas-formation, cloudiness may point to the presence of *B. typhosus* or *B. faecalis alkaligenes*, which can readily be confirmed, or not, by the usual means of identification.

The whole question turns on the possibility of recognising bacteriologically the contamination of water with sewage. Klein and Houston here insist on the fact that in crude sewage the *B. coli* or the members of the coli group are practically never fewer than 100,000 per c.c., and therefore if in a water this organism forms a considerable proportion of the total number of organisms present, then there is grave reason for suspecting sewage pollution. As, however, this organism is fairly widespread in nature, they hold that valuable supporting evidence is found in the presence of the *B. enteritidis sporogenes* and of the streptococci, both of which are probably constant inhabitants of the human intestine. The spores of the former usually number 100 per c.c. in sewage, and the presence of the

latter can always be recognised in .001 grm. of human fæces. The deductions to be drawn from the presence of these in water are the same as those to be drawn from their presence in soil. A further point here is that it is well, wherever practicable, that the indirect evidence as to the potability of a water which is usually derived from chemical analysis should be supplemented by a bacteriological search for the three groups of organisms mentioned. It has been found that in water artificially polluted with sewage containing them, they can be detected by bacteriological methods in mixtures from ten to a hundred times more dilute than those in which the pollution can be detected by purely chemical methods.

Bacterial Treatment of Sewage.—Of late years the opinion has been growing that the most appropriate method of dealing with the disposal of sewage is to imitate as far as possible the processes which occur in nature for the breaking up of organic material. These practically depend entirely on bacterial action. Hence the rationale of the most approved methods of sewage disposal is to encourage the growth of bacteria which naturally exist in sewage, and which are capable of breaking up organic compounds and of converting the nitrogen into nitrates and nitrites. The technique by which this is accomplished is very varied and sometimes rather empirical, but probably the general principles underlying the different methods are comparatively simple. It is probable that for the complete destruction of the organic matter of sewage both aerobic and anaerobic bacteria are required, though on this point there may be some difference of opinion. Certainly very fair results are obtained when apparently the conditions chiefly favour aerobic organisms alone. This is usually effected by running the sewage on to beds of coke, allowing it to stand for some hours, slowly running the effluent out through the bottom of the bed, and leaving the bed to rest for some hours before recharging. The final result is better if the effluent be afterwards run over another similar coke-bed. According to some authorities the sewage, as it runs into the first bed, takes up from the air considerable free oxygen, which, however, soon disappears during the stationary period, so that on leaving the first bed the sewage contains little oxygen. In the latter part of its stay it has thus been submitted to anaerobic conditions. Further, while by the passage of the effluent

out of the first bed oxygen is sucked in, it rapidly disappears, and during the greater part of the resting stage the interstices of the bed are filled with carbonic acid gas, with nitrogen partly derived from the air, partly from putrefactive processes, and thus in the filter anaerobic conditions prevail, under which the bacteria can act on the deposit left on the coke. On this latter point there is difference of opinion, for, in examining London sewage, Clowes has found oxygen present in abundance from four to forty hours after the sewage has been run off. Probably the best results in sewage treatment are obtained when it is practicable to introduce a step where there can be no doubt that the conditions are anaerobic. This involves as a preliminary stage the treatment of the sewage in what is called a septic tank, and the method has been adopted at Exeter, Sutton, and Yeovil in England, and very fully worked out in America by the State Board of Health of Massachusetts. In the explanation given of the rationale of this process, sewage is looked on as existing in three stages. (1) First of all, *fresh sewage*—the newly mixed and very varied material as it enters the main sewers. (2) Secondly, *stale sewage*—the ordinary contents of the main sewers. Here there is abundant oxygen, and as the sewage flows along there occurs by bacterial action a certain formation of carbon dioxide and ammonia which combine to form ammonium carbonate. This is the sewage as it reaches the purification works. Here a preliminary mechanical screening may be adopted, after which it is run into an air-tight tank—the septic tank. (3) It remains there for from twenty-four to thirty-six hours, and becomes a foul-smelling fluid—the *septic sewage*. The chemical changes which take place in the septic tank are of a most complex nature. The sewage entering it contains little free oxygen, and therefore the bacteria in the tank are probably largely anaerobic, and the changes which they originate consist of the formation of comparatively simple compounds of hydrogen with carbon, sulphur, and phosphorus. As a result there is a great reduction in the amount of organic nitrogen, of albuminoid ammonia, and of carbonaceous matter. The latter fact is important, as the clogging of ordinary filter beds is largely due to the accumulation of such material, and of matters generally consisting of cellulose. One further important effect is that the size of the deposited matter is decreased,

and therefore it is more easily broken up in the next stage of the process. This consists of running the effluent from the septic tank on to filter beds, preferably of coke, where a further purification process takes place. By this method there is first an anaerobic treatment succeeded by an aerobic; in the latter the process of nitrification occurs by means of the special bacteria concerned. The results are of a most satisfactory nature.

Sometimes the effluent from a sewage purification system contains as many bacteria as the sewage entering, but, especially by means of the septic tank method, there is often a marked diminution. It is said by some that pathogenic bacteria do not live in sewage, but in an effluent *B. coli*, *B. enteritidis*, and streptococci have been constantly found, so that the observation is of little value, and it is only by great dilution and prolonged exposure to the conditions present in running water that such an effluent can be again a part of a potable water.

ANTISEPTICS.

The death of bacteria is judged of by the fact that when they are placed on a suitable food medium no development takes place. Microscopically it would be observed that division no longer occurred, and that in the case of motile species movement would have ceased, but such an observation has only scientific interest. From the importance of being able to kill bacteria an enormous amount of work has been done in the way of investigating the means of doing so by chemical means, and the bodies having such a capacity are called antiseptics. It is now known that the activity of these agents is limited to the killing of bacteria outside the animal body, but still even this is of high importance.

Methods. — These vary very much. In early inquiries a great point was made of the prevention of putrefaction, and work was done in the way of finding how much of an agent must be added to a given solution such as beef infusion, urine, etc., in order that the bacteria accidentally present might not develop; but as bacteria vary in their powers of resistance, the method was unsatisfactory, and now an antiseptic is usually judged of by its effects on pure cultures of definite pathogenic microbes, and in the case of a sporing bacterium the effect on both the vegetative and spore forms is investigated. The organisms most used are the *staphylococcus pyogenes*, *streptococcus pyogenes*, and the organisms of typhoid, cholera, diphtheria, and anthrax — the latter being most used for testing the action on spores. The best method to employ

is to take sloped agar cultures of the test organism, scrape off the growth, and mix it up with a small amount of distilled water and filter this emulsion through a plug of sterile glass wool held in a small sterile glass funnel, add a measured quantity of this fluid to a given quantity of a solution of the antiseptic in distilled water, then after the lapse of the period of observation to remove one or two loopfuls of the mixture and place them in a great excess of culture medium. Here it is preferable to use fluid agar, which is then plated and incubated; such a procedure is preferable to the use of bouillon tubes, as any colonies developing can easily be recognised as belonging to the species of bacterium used. In dealing with strong solutions of chemical agents it is necessary to be sure that the culture fluid is in great excess, so that the small amount of the antiseptic which is transferred with the bacteria may be diluted far beyond the strength at which it still can have any noxious influence. Sometimes it is possible at the end of the period of observation to change the antiseptic into inert bodies by the addition of some other substance and then test the condition of the bacteria, and if the inert substances are fluid there is no objection to this proceeding, but if in the process a precipitate results, then it is better not to have recourse to such a method, as sometimes the bacteria are carried down with the precipitate and may escape the culture test. The advisability of, when possible, thus chemically changing the antiseptic was first brought to notice by the criticism of Koch's statements as to the efficacy of mercuric chloride in killing the spores of the *B. anthracis*. The method he employed in his experiments was to soak silk threads in an emulsion of anthrax spores and dry them. These were then subjected to the action of the antiseptic, well washed in water, and laid on the surface of agar. It was found, however, that with threads exposed to a far higher concentration of the corrosive sublimate than Koch had stated was sufficient to prevent growth, if the salt were broken up by the action of ammonium sulphide and this washed off, growth of anthrax still occurred when the threads were laid on agar. The explanation given was that the antiseptic had formed an albuminate with the case of each spore, and that this prevented the antiseptic from acting upon the contained protoplasm. Such an occurrence only takes place with spores, and the method given above, in which the small amount of antiseptic adhering to the bacteria is swamped in an excess of culture fluid, can safely be followed, especially when a series of antiseptics is being compared.

The Action of Antiseptics. — In inquiries into the actions of antiseptics attention to a great variety of factors is necessary, especially when the object is not to compare different antiseptics with one another, but when the absolute value of any body is being investigated. Thus the medium in which the bacteria to be killed are situated is important; the more albuminous the surroundings are, the greater degree of concentration is required. Again, the higher the temperature at which the action is to take place, the more dilute may the antiseptic be, or the shorter the exposure necessary for a given effect to take place. The most

important factor, however, to be considered is the chemical nature of the substances employed. Though nearly every substance which is not a food to the animal or vegetable body is more or less harmful to bacterial life, yet certain bodies have a more marked action than others. Thus it may be said that the most important antiseptics are the salts of the heavy metals, certain acids, especially mineral acids, certain oxidising and reducing agents, a great variety of substances belonging to the aromatic series, and volatile oils generally. In comparing different bodies belonging to any one of these groups the chemical composition or constitution is very important, and if such comparisons are to be made, the solutions compared must be equimolecular; in other words, the action of a molecule of one body must be compared with the action of a molecule of another body. This can be done by dissolving the molecular weight in grammes in say a litre of water (see p. 36). When this is done important facts emerge. Thus, generally speaking, the compounds of a metal of high atomic weight are more powerful antiseptics than those of one belonging to the same series, but of a lower atomic weight. Among organic bodies again substances with high molecular weight are more powerful than those of low molecular weight—thus butyric alcohol is more powerful than ethylic alcohol—and important differences among the aromatic bodies are associated with their chemical constitution. Thus among the cresols the ortho- and para- bodies resemble each other in general chemical properties, and stand apart from metacresol; they also are similar in antiseptic action, and are much stronger than the meta- body. The same may be observed in the other groups of ortho-, meta-, and para- bodies. Again, such a property as acidity is important in the action of a substance, and, generally speaking, the greater the avidity of an acid to combine with an alkali, the more powerful an antiseptic it is. With regard to oxidising agents and reducing agents, probably the possession of such properties has been overrated as increasing bactericidal potency. Thus in the case of such reducers as sulphurous acid and formic acid, the effect is apparently chiefly due to the fact that these substances are acids. Formic acid is much more efficient than formate of sodium. In the case of permanganate of potassium, which is usually taken as the type of oxidising agents in this connection, it can be

shown that the greater amount of the oxidation which takes place when this agent is brought into contact with bacteria occurs after the organisms are killed. Such an observation is, however, not conclusive as to the non-efficiency of the oxidation process, for the death of the bacteria might be due to the oxidation of a very small part of the bacterial protoplasm. Apart from the chemical nature of antiseptic agents, the physical factors concerned in their solution, especially when they are electrolytes, probably play a part in their action. The part played by such factors is exemplified in the important fact that a strong solution acting for a short time will have the same effect as a weaker solution acting for a longer time. From what has been said it will be realised that the real causes of a material being an antiseptic are very obscure, and at present we can only have a remote idea of the factors at work.

The Actions of Certain Antiseptics. — Here we can only briefly indicate certain results obtained with the more common members of the group.

Chlorine. — All the halogens have been found to be powerful antiseptics, but from the cheapness with which it can be produced chlorine has been most used; not only is it the chief active agent in the somewhat complex action of bleaching powder, but it is also the chief constituent of several proprietary substances, of which "Electrozone" is a good example. This last substance is made from electrolysing sea water, when magnesia and chlorine being liberated, magnesium hypochlorite and magnesium chloride are formed. In the action of this substance free hypochlorous acid is formed, and the effect produced is thus similar to that of bleaching powder. Nissen, investigating the action of the latter, found that $1\frac{1}{2}$ per cent killed typhoid bacilli in fæces; and Rideal found that 1 part to 400–500 disinfected sewage in fourteen minutes, and Delépine's results show that 1 part to 50 (equal to .66 per cent of chlorine) rapidly kills the tubercle bacillus, and 1 part to 10 (equal to 3.3 per cent) killed anthrax spores. Klein found that .05 per cent of chlorine killed most bacterial spores in five minutes.

Iodine Trichloride. — This is a very unstable compound of iodine and chlorine, and though it has been much used as an antiseptic, seeing that the substance only remains as ICl_3 in an atmosphere of chlorine gas, it is open to doubt whether the

effects described are not due to a very complicated action of free hydrochloric acid, hydriodic acid, and of oxyacids of chlorine and iodine produced by its decomposition. It is stated, however, that the action is very potent: a 1 per cent solution is said instantly to kill even anthrax spores, but if the spores be in bouillon, death occurs after from ten to twelve minutes. In serum the necessary exposure is from thirty to forty minutes. A solution of 1-1000 will kill the typhoid, cholera, and diphtheria organisms in five minutes.

Nascent Oxygen. — This is chiefly available in two ways — firstly, when in the breaking up of ozone the free third atom of the ozone molecule is seeking to unite with another similar atom; secondly, when peroxide of hydrogen is broken up into water and an oxygen atom is thereby liberated. In commerce the activity of “Sanitas” compounds is due to the formation of ozone by the slow oxidation of the resin, camphor, and thymol they contain.

Perchloride of Mercury. — Of all the salts of the heavy metals this has been most widely employed, and must be regarded as one of the most powerful and useful of known antiseptics. In testing this action on anthrax spores there is no doubt that in the earlier results its potency was overrated from a neglect of the fact already alluded to, that in the spore-case an albuminate of mercury was formed which prevented the contained protoplasm from developing, while not depriving it of life. It has been found, however, that this salt in a strength of 1-100 will kill the spores in twenty minutes, although an hour's exposure to 1-1000 has no effect. The best results are obtained by the addition to the corrosive sublimate solution of .5 per cent of sulphuric acid or hydrochloric acid; the spores will then be killed by a seventy-minute exposure to a 1-200 solution. When, however, organisms in the vegetative condition are being dealt with, much weaker solutions are sufficient; thus anthrax bacilli in blood will be killed in a few minutes by 1-2000, in bouillon by 1-40,000, and in water by 1-500,000. Plague bacilli are killed by one to two minutes' exposure to 1-3000. Generally speaking, it may be said that a 1-2000 solution must be used for the practically instantaneous killing of vegetative organisms.

Perchloride of mercury is one of the substances which have been used for disinfecting rooms by distributing it from a spray

producer, of which the "Equifex" may be taken as a type. With such a machine it is calculated that 1 oz. of perchloride of mercury used in a solution of 1-1000 will probably disinfect 3000 square feet of surface. Such a procedure has been extensively used in the disinfection of plague houses, but the use of a stronger solution (1-500 acidulated) is probably preferable.

Formalin as a commercial article is a 40 per cent solution of formaldehyde in water. This is a substance which of late years has come much into vogue, and it is undoubtedly a valuable antiseptic. A disadvantage, however, to its use is that, when diluted and exposed to air, amongst other changes which it undergoes it may be transformed, under little understood conditions, into trioxymethylene and paraformaldehyde, these being polymers of formaldehyde. The bactericidal values of these mixtures are thus indefinite. Formalin may be used either by applying it in its liquid form or as a spray, or the gas which evaporates at ordinary temperatures from the solution may be utilised. To disinfect such an organic mixture as pus containing pyogenic organisms a 10 per cent solution acting for half an hour is necessary. In the case of pure cultures, a 5 per cent solution will kill the cholera organism in three minutes, anthrax bacilli in a quarter of an hour, and the spores in five hours. When such organisms as pyogenic cocci, cholera spirillum, and anthrax bacillus infect clothing, an exposure to the full strength of formalin for two hours is necessary, and in the case of anthrax spores, for twenty-four hours. Silk threads impregnated with the plague bacillus were found to be sterile after two minutes' exposure to formalin.

The action of formalin vapour has been much studied, as its use constitutes a cheap method of treating infected rooms, in which case some spray-producing machine is employed. It is stated that a mixture of 8 c.c. of formalin with 40 c.c. of water is sufficient when vaporised to disinfect 1 c.m., so far as non-sporing organisms are concerned. It is stated that 1 part formalin in 10,000 of air will kill the cholera vibrio in one hour, diphtheria bacillus in three hours, the staphylococcus pyogenes in six hours, and anthrax spores in thirteen hours. In the case of organisms which have become dry it is probable, however, that much longer exposures are necessary, but on this point we have not definite information.

Formalin gas has only a limited application ; it has little effect on dry organisms, and in the case of wet organisms must, in order to be effective, probably become dissolved so as to give the moisture a proportion analogous to the strengths given above with regard to the vapour.

Sulphurous Acid. — This substance has long been in use, largely from the cheapness with which it can be produced by burning sulphur in the air. An atmosphere containing 98 per cent will kill the pyogenic cocci in two minutes if they are wet, and in twenty minutes if they are dry ; and anthrax bacilli are killed by thirty minutes' exposure, but to kill anthrax spores an exposure of one to two hours to an atmosphere containing 11 per cent is necessary. For a small room the burning of about a pound and a half (most easily accomplished by moistening the sulphur with methylated spirit) is usually considered sufficient. It has been found that if bacteria are protected, as by being in the middle of small bundles of clothes, no effect is produced even by an atmosphere containing a large proportion of the sulphurous acid gas. The practical applications of this agent are therefore limited.

Potassium Permanganate. — The action of this agent very much depends on whether it can obtain free access to the bacteria to be killed or whether these are present in a solution containing much organic matter. In the latter case the oxidation of the organic material throws so much of the salt out of action that there may be little left to attack the organisms. Koch found that to kill anthrax spores a 5 per cent solution required to act for about a day ; for most organisms a similar solution acting for shorter periods has been found sufficient, and in the case of the pyogenic cocci a 1 per cent solution will kill in ten minutes. There is little doubt that such weaker solutions are of value in disinfecting the throat on account of their non-irritating properties, and good results in this connection have been obtained in cases of diphtheria. A solution of 1 in 10,000 has been found to kill plague bacilli in five minutes.

Carbolic Acid. — Of all the aromatic series this is the most extensively employed antiseptic. All ordinary bacteria in the vegetative condition, and of these the staphylococcus pyogenes is the most resistant, are killed in less than five minutes by a a to 3 per cent solution in water, so that the 5 per cent solution

usually employed in surgery leaves a margin of safety. But for the killing of such organisms as anthrax spores a very much longer exposure is necessary; thus Koch found it necessary to expose these spores for four days to ensure disinfection. The risk of such spores being present in ordinary surgical procedure may be overlooked, but there might be risk of tetanus spores not being killed, as these will withstand fifteen hours' exposure to a 5 per cent solution.

In the products of the distillation of coal there occur, besides carbolic acid, many bodies of a similar chemical constitution, and many mixtures of these are in the market—the chief being creolin, izal, and lysol, all of which are agents of value. Of these lysol is perhaps the most noticeable, as from its nature it acts as a soap and thus can remove fat and dirt from the hands. A one-third per cent solution is said to destroy the typhoid and cholera organisms in twenty minutes. A 1 per cent solution is sufficient for ordinary surgical procedures.

Iodoform.—This is an agent regarding the efficacy of which there has been much dispute. There is little doubt that it owes its efficiency to its capacity for being broken up by bacterial action in such a way as to set free iodine, which acts as a powerful disinfectant. The substance is therefore of value in the treatment of foul wounds, such as those of the mouth and rectum, where reducing bacteria are abundantly present. It acts more slightly where there are only pyogenic cocci, and it seems to have a specially beneficial effect in tubercular affections. In certain cases its action may apparently be aided by the presence of the products of tissue degeneration.

From the results which have been given it will easily be recognised that the choice of an antiseptic and the precise manner in which it is to be employed depend entirely on the environment of the bacteria which are to be killed. In many cases it will be quite impossible, without original inquiry, to say what course is likely to be attended with most success.

CHAPTER V.

FUNGI: NON-PATHOGENIC AND PATHOGENIC.

IT is quite outside the scope of the present volume to describe any bacteria other than those giving rise to disease processes. In the course of his work the bacteriologist frequently meets with ordinary saprophytic organisms. These may occur in diseased organs in which putrefaction has already begun to take place, and they may therefore appear in cultures made from such organs. Their source in cultures may, further, be by contamination from the air, or from the use of insufficiently sterilised vessels or instruments. The positive characters of the pathogenic bacteria will be given, and from these other bacteria must be distinguished by the application of the methods of diagnosis already detailed, or by the special methods still to be described. There occur, however, from time to time as contaminations of bacterial cultures, organisms of a more complicated structure than the bacteria, namely fungi, and therefore we shall describe a few of the typical forms of these.

The fungi have probably descended from the algæ, or both have had a common ancestor. This is shown by the close resemblances in structure and development which the two groups present to each other. The chief differences centre round the degeneration of structure which the adoption of parasitism and saprophytism entails on the fungi. In the algæ, reproduction takes place in both sexual and non-sexual ways. In the former case, certain cells called gametes are set apart, and by the union of two of these—the embryonic male and female elements—a new cell called a zygospore is formed which after a period of rest grows into a new individual. Sometimes there is a more definite male element, the antherozoid, and a female element, the oosphere, and the coalescence of these forms an oospore which subsequently behaves like a zygospore. In the non-sexual reproduction there are formed certain cells

called sporangia, the protoplasm of which, without being reinforced from that of another cell, proceeds to break up into the elements of new individuals, often called, when motile, swarm-spores. Both forms of reproduction are usually manifested by each species. The degradation of the fungi consists in the gradual loss of the faculty of sexual reproduction, so that, in the most extreme species of the group, it does not appear at all and only asexual reproduction can be traced. We shall now describe a few of the typical forms of these lower fungi which are often met with in bacteriological work.

Mucorinæ: Mucor Mucedo. — This form occurs especially in the putrefaction of horse dung and also in other putrefactions. To the naked eye it appears as a white or brownish-white mass of fine filaments, from which, here and there, rise special filaments often several inches long, having at their terminations spherical brown swellings, the reproductive elements. Microscopically, the plant consists of branching non-septate filaments. Such a structure is called a mycelium. The non-sexual is the commonest form of reproduction (*vide* Fig. 61, A4). One of the filaments grows out, at its termination a septum forms, and a globular swelling (the sporangium) appears. This sporangium possesses a definite membrane. Within it from the septum grows a club-shaped mass of protoplasm called the columella, to which are attached the swarm-spores formed from the breaking up of the rest of the protoplasm. When ripe the brood cell bursts, the brown swarm-spores are cast off, and from each a new individual arises. Under certain circumstances sexual reproduction occurs (*vide* Fig. 61, A1-3). Two filaments approach each other, and a small piece of the protoplasm of each being cut off by a septum, these parts coalesce. A zygospore is thus formed from which a new filamentous individual arises.

Ascomycetæ: Oidium Lactis (Fig. 61, B). — This is a common organism in sour milk and sour bread. It can easily be cultivated on gelatin where the colonies appear to consist of fine white filaments radiating from a centre. Microscopically here and there the filaments (which may be branched) are broken up, especially at the ends, into short, rod-shaped or oval segments, often referred to as the oidia. These behave like spores. Non-sexual reproduction also takes place by the formation, within certain special sporangia in the filament called asci, of a definite

number of spores, to which the special name of ascospores is applied.

Perisporiaceæ: (1) *Aspergillus Niger* (*vide* Fig. 61, C). — This, with other varieties of the same group is of frequent

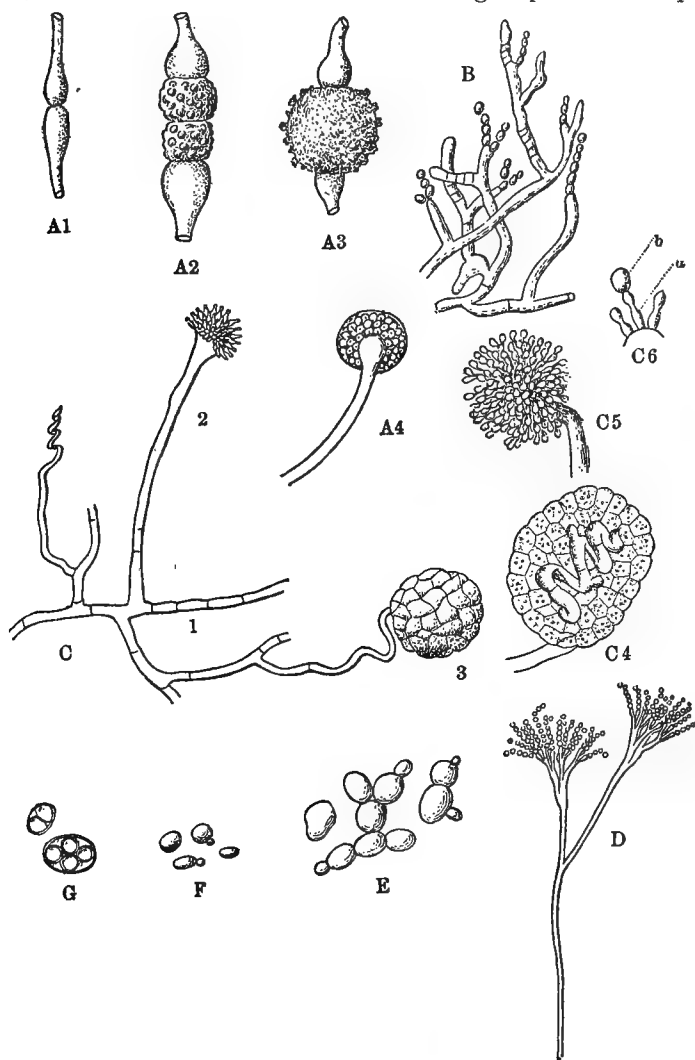

FIG. 61. — A. *Mucor mucedo*; (1), (2), (3) stages in formation of a zygospore; (4) a sporangium containing spores. B. *Oidium lactis*. C. *Aspergillus glaucus* (De Bary); (1) mycelium; (2) and (5) gonidiophore bearing spores; (3), (4) a perithecium (4 contains rudimentary asci); (6) piece of gonidiophore; (a) sterigma; (b) spore. D. Branched gonidiophore of *penicillium glaucum* bearing spores. E, F. *Saccharomyces cerevisiae*, cells are budding. G. Ditto, formation of endospores (after Hansen).

occurrence, especially in vegetable putrefactions. It grows readily in gelatin. It consists, to the naked eye, like the other fungi described, of a mass of felted filaments which microscopically are seen to form a septate branching mycelium. Though it is a matter of doubt whether sexual reproduction takes place, two forms of reproduction occur, the variety depending largely on the nutrition of the plant. The less common form is effected by means of the formation of structures known as perithecia, and it may perhaps be that the perithecia owe their formation to a sexual act. From a mycelial branch there arises a filament (or hypha) which becomes specially coiled and transversely septate at its end. From the base of the lowest coil of the spiral two or three hyphæ grow up towards its apex. One of these, being the first to reach the apex, was regarded by De Bary as a male organ. The others, by branching copiously, produce a mass of closely woven hyphæ, which form a closed wall to this structure, which is the perithecium referred to. Within it numerous asci arise as the ultimate ramifications of branches given off by the central coiled hypha. Inside each ascus eight ascospores are produced. Ultimately all the structures lying within the perithecium, save the spores, undergo disintegration, so that the mature perithecium consists of a small hollow sphere within which lie the loose spores. These latter are ultimately freed by the decay of the wall of the perithecium and develop into new individuals. The commonest method of reproduction is by the formation of spores (gonidia or conidia), which are clearly of non-sexual origin. These are formed externally in the hyphæ and not inside sporangia. A filament grows out, and at its termination a club-shaped swelling is formed on which a series of flask-shaped cells, called sterigmata (*vide* Fig. 61, C6), are perched. At the free end of each of these, an oval body, the spore or gonidium is formed, and this becoming free, can give rise to a new individual.

(2) **Penicillium Glaucum.** — This is perhaps the most common of all the fungi met with in bacteriological work. It is the common green cheese mould, and its spores are practically omnipresent. The mycelium is like that of the aspergillus. Perithecium formation takes place, but the commonest mode of reproduction is by gonidia (*vide* Fig. 61, D). A filament (called a gonidiophore) grows out, and at its end breaks up into a num-

ber of finger-like branches. On the point of each of these a flask-shaped sterigma is developed. On the end of this a row of oval spores appears. These break off, and can give rise to new individuals.

Yeasts and Torulæ: Saccharomyces, Torula, Mycoderma. — These are of the greatest importance, of course, in brewing and baking. They only concern us as being of not uncommon occurrence in the air. They consist of round or oval cells usually many times larger than bacteria. They often reproduce themselves by budding (*vide* Fig. 60, E, F), a portion of the cell protruding, and finally being cut off to form a new individual. Endogenous spore formation also occurs (*vide* Fig. 60, G). Many of the torulæ, when growing in colonies, are brilliantly coloured. What their true morphological relationships are it is difficult to say, but they present many analogies to the oidia of such forms as *oidium lactis*.

A knowledge of the above type forms will enable the student to recognise the more common fungi as such, when they present themselves to him. For further information on this group he is referred to De Bary's book on *The Fungi*. Certain fungi closely related to the above are pathogenic agents. Some aspergilli have been found to grow in the animal tissues and to produce death, and to the fungi also belong the *saprolegnia ferax* (the cause of a disease of salmon), the *tinea tonsurans* and the *Achorion Schoenleinii*.

Blastomycetic Dermatitis. — In America and Germany within recent years attention has been called by Gilchrist, Busse, Stokes, Schenck, Ophüls, Montgomery, and many others, to a class of diseases of the skin, resembling epithelioma and tuberculosis, which, in the course of development, may become generalised throughout the body and result fatally, and *post mortem* showing more or less extensive tuberculoid conditions of the internal organs and tissues. In the pus of abscesses and in sections of diseased tissue from all cases reported, round bodies with doubly contoured walls, occasionally budding, and closely resembling yeast cells, have been described, and cultures from most of the cases have yielded a blastomycetic organism which undoubtedly is identical to those bodies seen in the tissues. Although presenting some variations amongst themselves in culture media, Ricketts believes them to be of very closely related species of

the genus oidia, excepting those of Schenck and Hektoen, which have been classified by Erwin Smith as belonging to the genus *Sporotricha*, and named by him *Sporotrix Schenckii*.

Morphology.—As seen in the pus or tissues (Fig. 62) these bodies appear usually as spherical cells, measuring in diameter 10–15 μ , possessed of a cell membrane about .5–1.5 μ in thickness, their contents are made up of small and large granules of varying degrees of refractibility and vacuoles. No nuclei

have been demonstrated.

Budding forms (Fig. 63), resembling those of ordinary yeast cells, are often met with, and it would appear as if budding were the usual method of reproduction; some cells, however, contain small round bodies, which some have considered endospores (Fig. 64), but when brought into cultural conditions these bodies have remained unaltered, and thus it is extremely doubtful if they have any reproductive function

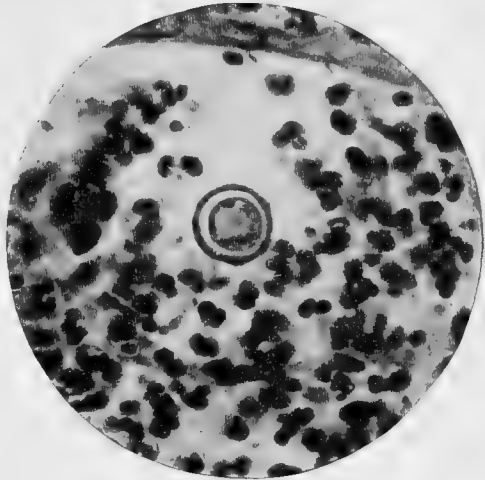

FIG. 62.—*Blastomyces dermatitidis* (Gilchrist): section through an abscess cavity showing the organism with doubly-contoured membrane $\times 1000$. [By the kind permission of Dr. T. Caspar Gilchrist.]

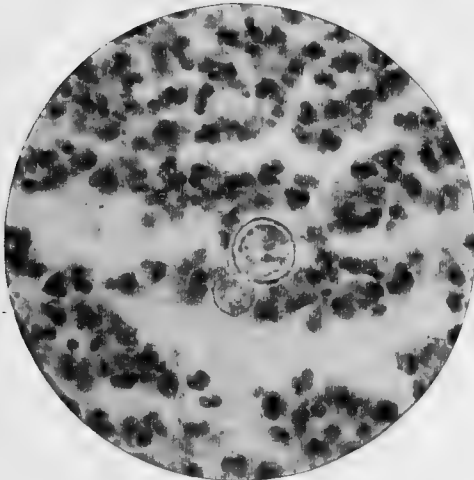

FIG. 63.—*Blastomyces dermatitidis* (Gilchrist): showing the budding form of the organism lying in the pus of an abscess cavity $\times 1000$. [By the kind permission of Dr. T. Caspar Gilchrist.]

whatever. Involution forms are occasionally encountered and appear as shrunken empty capsules of irregular contour.

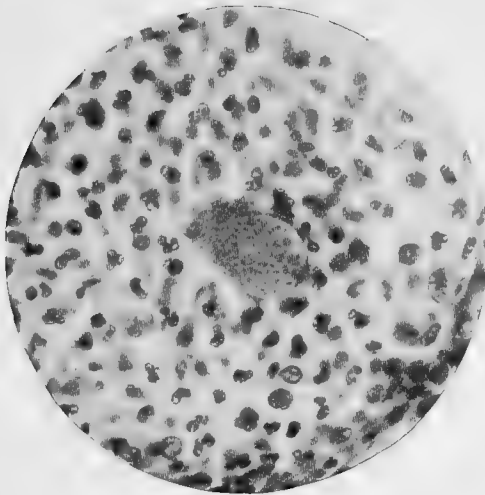

FIG. 64. — *Blastomyces dermatitidis* (Gilchrist): the sporulating(?) form in an abscess cavity, showing eruption of spores(?) through a rent in the cell membrane $\times 1000$. [By the kind permission of Dr. T. Caspar Gilchrist.]

mycelial development has ever been found in the lesions. In artificial conditions, such as afforded by various cultural media, the organisms undergo considerable modifications. Three types of cell growth can be distinguished: (1) round or oval budding cells much smaller than those seen in the tissues; (2) segmented, branching mycelial threads, occasionally budding; (3) aerial hyphæ bearing conidia.

Cultural Characters. — Ricketts in a comparative study divides the organisms into three groups: (1) those growing upon slanted agar or beerwort agar with a moist, smooth, whitish, pasty surface, and usually appearing upon the inoculated medium within 24–48 hours; (2) those having a granular, semi-moist surface, slightly elevated, and incorporated with the medium — after a time the surface of the growth becomes markedly plicated; (3) those at first scarcely rising above the surface, delicate, feathery, radiate, semi-moist, and of a gray-white colour, closely incorporated with the medium, and after several days' growth developing aerial hyphæ with conidia, in some cases resembling the growth of a mould, and in the others being dry and as if dusted with flour. The two latter groups require from 2–10 days after the medium has been inoculated before growth develops. Gilchrist is of the opinion that these last two groups of Ricketts are identical, as he has observed both types of growth occurring in the same culture at different times. In liquid media the organisms of the first type grow at the bottom of the tube

in a flocculent manner, leaving the fluid clear; the second variety produces a membranous top growth, with irregular masses of round cells and mycelial tufts at the bottom or adhering to the sides of the tube, the membrane so formed may through increasing weight sink and be replaced by a new formation; the third type forms no top growth, nor clouds the medium, but grows as small, discrete woolly tufts at the bottom. On agar or gelatin plates the colonies of the first type are round, moist, glossy, white, opaque, and elevated, and under the low power of the microscope are found to be coarsely granular, and individual cells can be seen at their peripheries. The second type shows roundish colonies having the characters described upon agar slants; microscopically the colonies are made up of branching segmented mycelium radiating outwards from the centre of the colony. In the third type the colonies have the general characters of the slant agar growth, and under the microscope appear to be made up of long radiating, branching segmented mycelium, which here and there shows occasional budding.

Fermentation of glucose and maltose with the production of alcohol, acetic acid, and carbon dioxide takes place with some varieties, whilst in others no fermentation occurs at all. Cane sugar and lactose are not fermented by any variety.

Litmus milk is rendered usually neutral or alkaline by the growth, whilst acidity and coagulation of the casein is very rare.

Gelatin in some instances is liquefied slowly.

Pathogenic Properties. — Towards the lower animals pathogenic properties vary very much with the culture, recently isolated cultures as a rule proving more virulent than older ones. Mice, guinea-pigs, and dogs are most susceptible, succumbing often to subcutaneous and intraperitoneal inoculations, whilst the white rat, rabbit, sheep, and horse are more refractory; in all, the lesions may be localized in the form of abscesses, or general infection may ensue where subcutaneous inoculation is practised.

Methods of Examination and Isolation. — Pus from subcutaneous abscesses, or scrapings made with a curette from the inflamed indurated skin growth are to be placed on a slide and thoroughly macerated in a thirty per cent solution of sodium hydrate, which dissolves the pus or tissue cells and permits of the more ready identification of the blastomycetes, which are

recognized by their large size, doubly contoured membrane, and refractile granular contents, and perhaps by evidences of budding at some portion of the cell wall. Staining of the pus or scrapings is not so satisfactory as an examination of the fresh material, but this can be carried out by making films and staining in an old solution of Löffler's methylene-blue or by Gram's method, as described in Chapter III.

Isolation in pure culture is most readily effected by the use of saccharine media, such as glucose or maltose broth (or agar), beerwort or beerwort agar or gelatin (see Chapter II.), yet in spite of all efforts some cases yield negative results. Inoculation of the media is made from pus, scrapings of the growth, or even with very small pieces of excised tissue from the growing edge of the lesion, and incubation at 37° C. is to be prolonged for two weeks before any culture is declared negative. The appearance of round or oval, budding and non-budding cells, alone or mixed with branching or budding mycelial threads, together with general characters described above, may be regarded as of a positive nature. Animal inoculations should likewise be carried out.

CHAPTER VI.

RELATIONS OF BACTERIA TO DISEASE—THE PRODUCTION OF TOXINS BY BACTERIA.

Introductory.— It has already been stated that a strict division of micro-organisms into *saprophytes* and true *parasites* cannot be made. No doubt there are organisms, such as the bacillus of leprosy and the spirillum of relapsing fever, which as yet have not been cultivated outside the animal body, and others, such as the gonococcus, which are in natural conditions always parasites associated with disease. But these latter can lead a saprophytic existence in specially prepared conditions, and there are many of the disease-producing organisms, such as the organisms of typhoid and cholera, which can flourish readily outside the body, even in ordinary conditions. The conditions of growth are, however, of very great importance in the study of the modes of infection in the various diseases, though they do not form the basis of a scientific division.

A similar statement applies to the terms *pathogenic* and *saprophytic*, and even to the terms *pathogenic* and *non-pathogenic*. By the term pathogenic is meant the power which an organism has of producing morbid changes or effects in the animal body, either under natural conditions or in conditions artificially arranged, as in direct experiment. Now we know of no organisms which will in all circumstances produce disease in all animals, and, on the other hand, many bacteria described as harmless saprophytes will produce pathological changes if introduced in sufficient quantity. When, therefore, we speak of a pathogenic organism, the term is merely a relative one, and indicates that in certain circumstances the organism will produce disease, though in the science of human pathology it is often used for convenience as implying that the organism produces disease in man in *natural* conditions.

Modifying Conditions.—In studying the pathogenic effects in any instance, both the micro-organisms and the animal affected must be considered, and not only the species of each, but also its exact condition at the time of infection. In other words, the resulting disease is the product of the sum total of the characters of the infecting agent, on the one hand, and of the subject of infection, on the other. We may, therefore, state some of the chief circumstances which modify each of these two factors involved and, consequently, the diseased condition produced.

1. *The Infecting Agent.*—In the case of a particular species of bacterium its effect will depend chiefly upon (*a*) its virulence, and (*b*) the number introduced into the body. To these may be added (*c*) the path of infection.

The *virulence*, *i.e.* the power of multiplying in the body, and producing disease, varies greatly in different conditions, and the methods by which it can be diminished or increased will be afterwards described (*vide* Chapter XX.). One important point is that when a bacterium has been enabled to invade and multiply in the tissues of an animal, its virulence for that species is often increased. This is well seen in the case of certain bacteria which are normally present on the skin or mucous surfaces. Thus it has been repeatedly proved that the bacillus coli cultivated from a septic peritonitis is much more virulent than that taken from the bowel of the same animal. The virulence may be still more increased by inoculating from one animal to another in series—the method of *passage*. Widely different effects are, of course, produced on the virulence being altered. For example, a streptococcus which produces merely a local inflammation or suppuration may produce a rapidly fatal septicæmia when its virulence is raised. Virulence also has a relation to the animal employed, as occasionally on being increased for one species of animal it is diminished for another. For example, streptococci, on being inoculated in series through a number of mice, acquire increased virulence for these animals, but become less virulent for rabbits. (Knorr.)

The *number* of the organisms introduced, *i.e.* the dose of the infecting agent, is another point of importance. The healthy tissues can usually resist a certain number of pathogenic organisms of given virulence, and it is only in a few instances that

one or two organisms introduced will produce a fatal disease, *e.g.* the case of anthrax in white mice. The healthy peritoneum of a rabbit can resist and destroy a considerable number of pyogenic micrococci without any serious result, but if a larger dose be introduced, a fatal peritonitis may follow. Again, a certain quantity of a particular organism injected subcutaneously may produce only a local inflammatory change, but in the case of a larger dose the organisms may gain entrance to the blood stream and produce septicæmia. There is, therefore, for a particular animal, a minimum lethal dose which can be determined by experiment only; a dose, moreover, which is modified by various circumstances difficult to control.

The path of infection may alter the result, serious effects often following a direct entrance into the blood stream. Staphylococci injected subcutaneously in a rabbit may produce only a local abscess, whilst on intravenous injection multiple abscesses in certain organs may result and death may follow. Local inflammatory reaction with subsequent destruction of the organisms may be restricted to the site of infection or may occur also in the lymphatic glands in relation. The latter therefore act as a second barrier of defence, or as a filtering mechanism which aids in protecting against blood infection. This is well illustrated in the case of "poisoned wounds." In some other cases, however, the organisms are very rapidly destroyed in the blood stream, and Klempner has found that, in the dog, subcutaneous injection of the pneumococcus produces death more readily than intravenous injection.

2. *The Subject of Infection.* — Amongst healthy individuals susceptibility and, in inverse ratio, resistance to a particular microbe may vary according to (*a*) species, (*b*) race and individual peculiarities, (*c*) age. Different species of the lower animals show the widest variation in this respect, some being extremely susceptible, others highly resistant. Then there are diseases, such as leprosy, gonorrhœa, etc., which appear to be peculiar to the human subject and have not yet been transmitted to animals. And further there are others, such as cholera and typhoid, which do not naturally affect animals, and the typical lesions of which cannot be experimentally reproduced in them, or appear only imperfectly, although pathogenic effects follow inoculation with the organisms. In the case of the human sub-

ject, differences in susceptibility to a certain disease are found amongst different races and also amongst individuals of the same race, as is well seen in the case of tubercle and other diseases. Age also plays an important part, young subjects being more liable to certain diseases, *e.g.* to diphtheria. Further, at different periods of life certain parts of the body are more susceptible, for example, in early life, the bones and joints to tubercular and acute suppurative affections.

In increasing the susceptibility of a given individual, conditions of *local or general diminished vitality* play the most important part. It has been experimentally proved that conditions such as exposure to cold, fatigue, starvation, etc., all diminish the natural resistance to bacterial infection. Rats naturally immune can be rendered susceptible to glanders by being fed with phloridzin, which produces a sort of diabetes, a large amount of sugar being excreted in the urine (Leo). Guinea-pigs may resist subcutaneous injection of a certain dose of the typhoid bacillus, but if at the same time a sterilised culture of the bacillus coli be injected into the peritoneum, they quickly die of a general infection. Also a local susceptibility may be produced by injuring or diminishing the vitality of a part. If, for example, previous to an intravenous injection of staphylococci, the aortic cusps of a rabbit be injured, the organisms may settle there and set up an ulcerative endocarditis; or if a bone be injured, they may produce suppuration at the part, whereas in ordinary circumstances these lesions would not take place. The action of one species of bacterium is also often aided by the simultaneous presence of other species. In this case the latter may act simply as additional irritants which lessen the vitality of the tissues, but in some cases their presence also appears to favour the development of a higher degree of virulence of the former.

These facts, established by experiment (and many others might be given), illustrate the important part which local or general conditions of diminished vitality may play in the production of disease in the human subject. This has long been known by clinical observation. In normal conditions the blood and tissues of the body, with the exception of the skin and certain of the mucous surfaces, are bacterium-free, and if a few organisms gain entrance, they are destroyed. But if the vitality becomes lowered their entrance becomes easier and the pos-

sibility of their multiplying and producing disease greatly increased. In this way the favouring part played by fatigue, cold, etc., in the production of diseases of which the direct cause is a bacterium, may be understood. It is important to keep in view in this connection that many of the inflammation-producing and pyogenic organisms are normally present on the skin and various mucous surfaces. The action of a certain organism may devitalise the tissues to such an extent as to pave the way for the entrance of other bacteria; we may mention the liability of the occurrence of pneumonia, erysipelas, and various suppurative conditions in the course of or following infective fevers. In some cases the specific organism may produce lesions through which the other organisms gain entrance, *e.g.* in typhoid, diphtheria, etc. It is not uncommon to find in the bodies of those who have died from chronic wasting disease, collections of micrococci or bacilli in the capillaries of various organs, which have entered in the later hours of life; that is to say, the bacterium-free condition of the blood has been lost in the period of prostration preceding death.

The methods by which the natural resistance may be specifically increased belong to the subject of immunity, and are described in the chapter on that subject.

Modes of Bacterial Action. — In the production of disease by micro-organisms there are two main factors involved, namely, (*a*) the multiplication of the living organisms after they have entered the body, and (*b*), the production by them of poisons which may act both upon the tissues around and upon the body generally. The former corresponds to *infection*, the latter is of the nature of *intoxication* or poisoning. In different diseases one of these is usually the more prominent feature, but both are always more or less concerned.

1. *Infection and Distribution of the Bacteria in the Body.* — After pathogenic bacteria have invaded the tissues, or in other words after infection by bacteria has taken place, their further behaviour varies greatly in different cases. In certain cases they may reach and multiply in the blood stream, producing a fatal septicæmia. In the lower animals this multiplication of the organisms in the blood throughout the body may be very extensive (for example, the septicæmia produced by the pneumococcus in rabbits); but in septicæmia in man, it very seldom, if ever,

occurs to so great a degree, the organisms rarely remain in large numbers in the circulating blood, and their detection in it during life by microscopic examination is rare, and even culture methods may give negative results unless a large amount of blood is used, yet it is interesting to note that the researches of Schottmüller, Auerbach and Unger, Cole and others, show that in various septicæmias, pneumonia, and typhoid fever the blood may contain at certain periods of the diseases the specific micro-organisms in a relatively large percentage of cases.

However, in fatal cases where blood cultures are negative during life, the organisms may be found *post mortem* lying in large numbers within the capillaries of various organs, *e.g.* in cases of septicæmia produced by streptococci. (Relapsing fever forms an exception, as in it numerous organisms may be seen in a drop of blood.) In the human subject more frequently one of two things happens. In the first place, the organisms may remain local, producing little reaction around them, as in tetanus, or a well-marked lesion, as in diphtheria, pneumonia, etc. Or, in the second place, they may pass by the lymph or blood stream to other parts or organs in which they settle, multiply, and produce lesions, as in tubercle.

2. *Production of Chemical Poisons.* — In all these cases the growth of the organisms is accompanied by the formation of *chemical products*, which act generally or locally in varying degree as toxic substances. The toxic substances become diffused throughout the system, and their effects are manifested chiefly by symptoms such as the occurrence of fever, disturbances of the circulatory, respiratory, and nervous systems, etc. In some cases corresponding changes in the tissues are found, for example, the changes in the nervous system in diphtheria, to be afterwards described. The general toxic effects may be so slight as to be of no importance, as in the case of a local suppuration, or they may be very intense, as in tetanus, or again, less severe but producing cachexia by their long continuance, as in tuberculosis.

The occurrence of *local tissue changes or lesions* produced in the neighbourhood of the bacteria, as already mentioned, is one of the most striking results of bacterial action, but these also must be traced to chemical substances formed in or around the bacteria, and either directly or through the medium of ferments.

In this case it is more difficult to demonstrate the mode of action, for in the tissues the chemical products are formed by the bacteria slowly, continuously, and in a certain degree of concentration, and these conditions cannot be exactly reproduced by experiment. It is also to be noted that more than one poison may be produced by a given bacterium. Thus in diphtheria, for example, the products which produce the local inflammatory reaction and necrosis are in all probability not the same as those which affect the nerve cells and fibres. Further, it is very doubtful whether all the chemical substances formed by a certain bacillus growing in the tissues are also formed by it in cultures outside the body. The separated toxin of diphtheria, like various vegetable and animal toxins (*vide infra*), however, possesses a local toxic action of very intense character, often producing extensive necrotic change.

The injection of large quantities of many different pathogenic organisms in the *dead* conditions results in the production of a local inflammatory change which may be followed by suppuration, this effect being possibly brought about by certain substances in the bacterial protoplasm common to various species, or at least possessing a common physiological action (Buchner and others). When dead tubercle bacilli, however, are introduced into the blood stream, nodules do result in certain parts which have a resemblance to ordinary tubercles. In this case the bodies of the bacilli evidently contain a highly resistant and slowly acting substance which gradually diffuses around and produces effects (*vide* "Tuberculosis").

The action of bacteria as mechanical irritants plays a very small part in the processes of disease; and the differences in their effects, though regulated by the position and rate of growth of the organisms, can be accounted for only by the formation of definite chemical substances which act on the tissues.

Summary. — We may say then that the action of bacteria as disease-producers, as in fact their power to exist and multiply in the living body, depends upon the chemical products formed directly or indirectly by them. This action is shown by *tissue changes* produced in the vicinity of the bacteria or throughout the system, and by *toxic symptoms* of great variety of degree and character.

We shall first consider the effects of bacteria on the body generally, and afterwards the nature of the chemical products.

EFFECTS OF BACTERIAL ACTION.

These may be for convenience arranged in a tabular form as follows:—

A. *Tissue Changes.*

- (1) Local changes, *i.e.* changes produced in the neighbourhood of the bacteria.

Position (*a*) At primary lesion.

(*b*) At secondary foci.

Character (<i>a</i>) Tissue reactions	} Acute or Chronic.
(<i>b</i>) Degeneration and necrosis	

- (2) Produced at a distance from the bacteria, directly or indirectly, by the absorption of toxins.

(*a*) In special tissues —

(*a*) as the result of damage, *e.g.* nerve cells and fibres, secreting cells, vessel walls,
or

(*β*) changes of a reactive nature in the blood-forming organs.

(*b*) General anatomical changes, the effects of malnutrition or of increased waste.

B. *Changes in Metabolism.*

The occurrence of fever, of errors of assimilation and elimination, etc.

A. Tissue Changes produced by Bacteria. — The effects of bacterial action are so various as to include almost all known pathological changes. However varied in character, they may be classified under two main headings — (*a*) those of a degenerative or necrotic nature, the direct result of damage, and (*b*) those of reactive nature, defensive or reparative. The former are the expression of the necessary vulnerability of the tissues, the latter of protective powers evolved for the benefit of the organism. In the means of defence, both leucocytes and the fixed cells of the tissues are concerned. Both show phagocytic properties, *i.e.* have the power of taking up bacteria into their protoplasm. The

cells are guided towards the focus of infection by chemiotaxis, and thus we find that different bacteria attract different cells. The most rapid and abundant supply of phagocytes is seen in the case of suppurative conditions, where the neutrophile leucocytes of the blood are chiefly concerned. When the local lesion is of some extent there is usually an increase of these cells in the blood—a neutrophile leucocytosis. And further, recent observations have shown that associated with this there is in the bone-marrow an increased number of the mother-cells of these leucocytes—the neutrophile myelocytes. The passage of the neutrophile leucocytes from the marrow into the blood, with the resulting leucocytosis, is also apparently due to the absorbed bacterial toxins acting chemiotactically on the marrow. These facts abundantly show that the means of defence is not a mere local mechanism, but that increased proliferative activity in distant tissues is called into play. In addition to direct phagocytosis by these leucocytes, there is now abundant evidence that an important function is the production in the body of bactericidal and other antagonistic substances. In other cases the cells chiefly involved are the mononuclear hyaline leucocytes, and with them the endothelial cells, *e.g.* of serous membranes, often play an important part in the defence; this is well seen in typhoid fever, where the specific bacillus appears to have little or no action on the neutrophile leucocytes. In other cases, again, the reaction is chiefly on the part of the connective cells, though their proliferation is always associated with some variety of leucocytic infiltration and usually also with the formation of new blood-vessels. Such a connective-tissue reaction occurs especially in slow infections or in the later stages of an acute infection. The tissue changes resulting from cellular activity in the presence of bacterial invasion are naturally very varied—of this examples will be found in subsequent chapters; but they may be said to be manifestations of the two fundamental processes of (*a*) increased functional activity—movement, phagocytosis, secretion, etc.—and (*b*) increased formative activity—cell growth and division. The exudation from the blood-vessels has been variously interpreted. There is no doubt that the exudate has bactericidal properties and also acts as a diluting agent, but it must still be held as uncertain whether the process of exudation ought to be regarded as primarily defensive or as

the direct result of damage to the endothelium of the vessels. It may also be pointed out that the various changes referred to are none of them peculiar to bacterial invasion; they are examples of the general laws of tissue change under abnormal conditions, and they can all be reproduced by chemical substances in solution or in a particulate state. What constitutes their special feature is their progressive or spreading nature, due to the bacterial multiplication.

(1) *Local Lesions*. — In some diseases the lesion has a special site; for example, the lesion of typhoid fever and, to a less extent, that of diphtheria. In other cases it depends entirely upon the point of entrance, *e.g.* malignant pustule and the conditions known as wound infections. In others, again, there is a special tendency for certain parts to be affected, as the upper parts of the lungs in tubercle. In some cases the site has a mechanical explanation.

When organisms gain an entrance to the blood from a primary lesion, directly or by the lymphatic system, they may become destroyed, or they may settle in certain organs and produce their characteristic effects. The organs specially liable to be affected in this way vary in different diseases. Pyogenic cocci show a special tendency to settle in the capillaries of the kidneys and produce miliary abscesses, whilst these lesions rarely occur in the spleen. On the other hand, the nodules in disseminated tubercle or glanders are much more numerous in the spleen than in the kidneys, which in the latter disease are usually free from them. The important point is that the position of the disseminated lesions is not to be explained by a mechanical process, such as embolism, but depends upon a special relation between the organisms and the tissues, which may be spoken of either as a selective power on the part of the organisms or a special susceptibility of tissues, possibly in part due to their affording to the organisms more suitable conditions of nutriment. Even in the case of the lesions produced by dead tubercle bacilli, a certain selective character is observed.

Acute Local Lesions. — The local inflammatory reaction presents different characters in different conditions. It may be accompanied by abundant fibrinous exudation, or by great catarrh (in the case of an epithelial surface), or by hæmorrhage, or by œdema; it may be localised or spreading in character; it

may be followed by suppuration, or may lead to necrosis. A few examples may be given. A great many different organisms cause an abundant fibrinous exudation. This, along with necrosis of epithelium, is the action of the diphtheria bacillus on a mucous membrane, and also of streptococci in certain conditions; it is produced in the alveoli of the lung in croupous pneumonia by the pneumococcus and probably by other organisms, whilst fibrinous inflammation in serous cavities is produced by a great many different bacteria. The last statement also applies to numerous suppurative and catarrhal conditions. The inflammatory change in a Peyer's patch in typhoid fever, though fibrinous exudation is less marked, is followed by necrosis, while in the malignant pustule of man necrotic change attended by considerable hæmorrhage is one of the chief features. The great variety in local reaction is well illustrated in the case of skin lesions produced by bacteria. The necrotic or degenerative changes affecting especially the more highly developed elements are chiefly produced by the direct action of the bacterial poisons, though aided by the disturbances of nutrition involved in the vascular phenomena.

In many of the acute inflammatory conditions, if not attended by a fatal result, the disease comes to a natural termination after a certain time, *e.g.* in pneumonia, erysipelas, etc. This fact, the explanation of which is not yet fully understood, has an important relation to the subject of immunity, and will be discussed later. It may also be pointed out that a well-marked inflammatory reaction is often found in animals which occupy a medium position in the scale of susceptibility, and that an organism which causes a general infection in a certain animal may produce only a local inflammation when its virulence is lessened.

Chronic Local Lesions.—In a considerable number of diseases produced by bacteria the local tissue reaction is a more chronic process than those described. In other words, the specific irritant is less intense, so that there is less vascular disturbance and a greater preponderance of the proliferative processes, leading to new formation of connective tissue or a modified connective tissue. This formation may occur in foci here and there, so that nodules of greater or less consistence result, or it may be more diffuse. Such changes especially occur in the

diseases often known as the *infective granulomata*, of which tubercle, leprosy, glanders, actinomycosis, syphilis, etc., are examples. A hard and fast line, however, cannot be drawn between such conditions and those described above as acute. In glanders, for example, especially in man, the lesion produced by the glanders bacillus often approaches very nearly to an acute suppurative change, and sometimes actually is of this nature. Whilst in these diseases the fundamental change is the same, viz., a reaction to an irritant of minor intensity, the exact structural characters and arrangement vary in different diseases. In some cases the disease may be identified by the histological changes alone, but on the other hand this is often impossible. These changes often include the occurrence of degenerations or of actual necrosis in the newly formed tissue. In the granulomata, infection of other parts from the primary lesion takes place chiefly by the blood-vessels and lymphatics, though sometimes along natural tubes such as the bronchi, intestine, etc. The organs specially liable to be the site of secondary lesions vary in different diseases, as already explained.

(2) *General Lesions produced by Toxins.*—In the various infective conditions produced by bacteria, changes commonly occur in certain organs unassociated with the presence of the bacteria; these are produced by the action of bacterial products circulating in the blood. Many such lesions can be produced experimentally. The secreting cells of various organs, especially the kidney and liver, are specially liable to change of this kind. Cloudy swelling, which may be followed by fatty change or by actual necrosis with granular disintegration, is common. Hyaline change in the walls of arterioles may occur, and in certain chronic conditions waxy change is brought about in a similar manner. The latter has been produced in animals by the repeated injection of the staphylococcus aureus. Capillary hæmorrhages are not uncommon, and are in many cases due to an increased permeability of the vessel walls, aided by changes in the blood plasma, as evidenced sometimes by diminished coagulability. Similar hæmorrhages may follow the injection of some bacterial toxins, *e.g.* of diphtheria, and also of vegetable poisons, *e.g.* ricin and abrin. Skin eruptions occurring in the exanthemata are probably produced in the same way, though

in many of these diseases the causal organism has not yet been isolated. We have, however, the important fact that corresponding skin eruptions may be produced by poisoning with certain drugs. In the nervous system degenerative changes have been found in diphtheria, both in the spinal cord and in the peripheral nerves, and have been reproduced experimentally by the products of the diphtheria bacilli. There is also experimental evidence that the bacillus coli communis and the streptococcus pyogenes may, by means of their products, produce areas of softening in the spinal cord, and this may furnish an explanation of some of the lesions found clinically. It is also possible that some serous inflammations may be produced in the same way.

B. Disturbances of Metabolism, etc. — It will easily be realised that such profound tissue changes as have been detailed cannot occur without great interference with the normal bodily metabolism. General malnutrition and cachexia are of common occurrence, and it is a striking fact found by experiment that after injection of bacterial products, *e.g.* of the diphtheria bacillus, a marked loss of body weight often occurs which may be progressive, and ultimately lead to the death of the animal. In bacterial disease assimilation is often imperfect, for the digestive glands are affected, it may be, by actual poisoning by bacterial products, it may be by the occurrence of fever. The fatty degenerations which are so common are indicative of a breaking down of the proteid molecules, and are associated with increased urea production, while the degeneration of the kidney epithelium renders the excretion of waste products deficient or impossible, and this is not infrequently the immediate cause of death. But of all the changes in metabolism the most difficult to understand is the occurrence of that interference with the heat-regulating mechanism which results in fever. The degree and course of the latter vary, sometimes conforming to a more or less definite type, where the bacilli are selective in their field of operation, as in croupous pneumonia or typhoid, sometimes being of a very irregular kind, especially when the bacteria from time to time invade fresh areas of the body, as in pyæmic affections. The main point of interest regarding the development of fever is as to whether it is a direct effect of the circulation of bacterial toxins, or if it is to be looked on as part of

the reaction of the body against the irritant. This question has still to be settled, and all that we can do is to adduce certain facts bearing on it. Thus in diphtheria and tetanus, where toxic action leading to degeneration plays such an important part, fever may be a very subsidiary feature, except in the terminal stage of the latter disease; and in fact in diphtheria profoundly toxic effects may be produced without the least interference with heat regulation. On the other hand, in bacterial disease, where defensive and reparative processes predominate, fever is rarely absent, and it is nearly always present when an active leucocytosis is going on. In this connection it may be remarked that several observers have found that, when a relatively small amount of the dead bodies of certain bacteria are injected into an animal, fever occurs; while the injection of a large amount of the same is followed by subnormal temperatures and rapidly fatal collapse. It might appear as if this indicated that the occurrence of fever had a beneficial effect, but this is one of the points at issue. Certainly such an effect is not due to the bacteria being unable to multiply at the higher degrees of temperature occurring in fever, for this has been shown not to be the case. Whether the increase of bodily temperature indicates the occurrence of changes, *e.g.* in the way of the production of bactericidal bodies, etc., is a question, and all attempts made hitherto towards its solution have been unsuccessful. On the one hand, it is stated that the maintaining, during an illness due to bacteria, of an animal's body at its normal temperature by means of anti-pyretics favours its recovery; and on the other hand it has been found that the placing of such an animal in an atmosphere at a temperature above its normal also favours recovery. It is evident that the experiments are not parallel, and, in fact, that from the latter no conclusion can be drawn, as the additional factor of the condition of the heat-regulating mechanism, when the bodily temperature rises, is also introduced. If we consider the site of the heat production in fever we again are in difficulties. It might appear as if the tissue destruction, indicated by the occurrence of fatty degeneration, would lead to heat development, but frequently excessive heat production with increased proteid metabolism occurs without any discoverable changes in the tissues; and further, in phosphorus poisoning there is little fever with great tissue destruction. The increased work performed by the heart

in most bacterial infections no doubt contributes to the rise of bodily temperature. But we must bear in mind that in fever there is more than mere increase of heat production — there is also a diminished loss of heat from interference with the nervous mechanism of the sweat apparatus. The known facts would indicate that in fever there may be a factor involving the nervous system to be taken into account. The whole subject is thus very obscure.

Symptoms. — Many of the symptoms occurring in bacterial affections are produced by the histological changes mentioned, as can be readily understood; whilst in the case of others, corresponding changes have not yet been discovered. Of the latter, those associated with fever, with its disturbances of metabolism and manifold affections of the various systems, are the most important. The nervous system is especially liable to be affected — convulsions, spasms, coma, paralysis, etc., being common. The symptoms due to disturbance or abolition of the functions of secretory glands also constitute an important group, forming, as they do, a striking analogy to what is found in the action of various drugs.

These tissue changes and symptoms are given only as illustrative examples, and the list might easily be greatly amplified. The important fact, however, is that *nearly all, if not quite all, the changes found throughout the organs (without the actual presence of bacteria), and also the symptoms occurring in infective diseases, can either be experimentally reproduced by the injection of bacterial poisons or have an analogy in the action of drugs.*

THE TOXINS PRODUCED BY BACTERIA.

Early Work on Toxins. — We know that bacteria are capable of giving rise to poisonous bodies within the animal body and also in artificial media. As we shall see, we know comparatively little of the actual nature of such bodies, and therefore we apply to them as a class the general term *toxins*. The necessity for accounting for the general pathogenic effects of certain bacteria, which in the corresponding diseases were not distributed throughout the whole body, directed attention to the probable existence of such toxins; and the first to systematically study the production of such poisonous bodies was Brieger. This observer isolated from putrefying substances, and also from bacterial

cultures, nitrogen-containing bodies, which he called *ptomaines*. Similar bodies occurring in the ordinary metabolic processes of the body had previously been described and called *leucomaines*. Ptomaines isolated from pathogenic bacteria in no case, except perhaps in tetanus, reproduced the symptoms of the disease. The methods by which they were isolated were faulty, and they have therefore only a historic interest.

The introduction of the principle of rendering fluid cultures bacteria-free by filtration through unglazed porcelain, and its application by Roux and Yersin to obtain, in the case of the *B. diphtheriæ*, a solution containing a toxin which reproduced the symptoms of this disease (*vide* Chapter XVI.), encouraged the further inquiry as to the nature of this toxin. The products of the *B. diphtheriæ* were investigated again by Brieger, now in conjunction with C. Fraenkel. The method employed was precipitation by alcohol, and the material obtained gave certain reactions of the parent fluids. This substance, if it did not consist entirely of the diphtheria toxin, certainly contained the latter, and from resemblances observed in it to serum albumin, was called by its discoverers a *toxalbumin*. Similar toxic bodies were obtained from the bacteria of tetanus, typhoid, and cholera, and also from the staphylococcus aureus, but with these, though death occurred from their injection, no characteristic symptoms or pathological effects were observed. They probably consisted largely of albumoses,¹ and contained the toxic bodies in mixture with other substances.

The Occurrence of Bacterial Toxins. — The following may be regarded as the chief facts regarding bacterial toxins which have

¹ In the digestion of albumins by the gastric and pancreatic juices the albumoses are a group of bodies formed preliminarily to the elaboration of peptone. Like the latter they differ from the albumins in their not being coagulated by heat, and in being slightly dialysable. They differ from the peptones in being precipitated by dilute acetic acid in presence of much sodium chloride, and also by neutral saturated sulphate of ammonia. Both are precipitated by alcohol. The first albumoses formed in digestion are proto-albumose and hetero-albumose, which differ in the insolubility of the latter in hot and cold water (insolubility and coagulability are quite different properties). They have been called the primary albumoses. By further digestion both pass into the secondary albumose, deuterio-albumose, which differs slightly in chemical reactions from the parent bodies, *e.g.* it cannot be precipitated from watery solutions by saturated sodium chloride unless a trace of acetic acid be present. Dys-albumose is probably merely a temporary modification of hetero-albumose. Further digestion of deuterio-albumose results in the formation of peptone.

been revealed by the study, partly of the bodily tissues of animals infected by the bacteria concerned, partly by what occurs in artificial cultures of these bacteria. The dead bodies of certain species have been found to be very toxic. When, for instance, tubercle bacilli are killed by heat and injected into a susceptible animal tubercular nodules are found to develop round the sites where they have lodged. From this it is inferred that they must have contained characteristic toxins, seeing that characteristic lesions result. The bodies of the cholera vibrio are likewise toxic. Such *intracellular* toxins, as they have been called, may appear in the fluids in which the bacteria are living (1) by excretion in an unaltered or altered condition, (2) by the disintegration of the bodies of the organisms which we know are always dying in any bacterial growth. Sometimes, on the other hand, the media in which bacteria are growing become extremely toxic. This is much greater in some cases than in others. The two best examples of bacteria thus producing soluble toxins are the diphtheria and tetanus bacilli. In these and similar cases, when bouillon cultures are filtered bacterium-free by means of a porcelain filter, highly toxic fluids are obtained, which on injection into animals reproduce the highly characteristic symptoms of the corresponding diseases. In the case of the *B. anthracis* and of many others, at any rate when growing in artificial media, such toxin production is much less marked, a filtered bouillon culture being relatively non-toxic. It is probable, however, that this may not occur when the bacillus is growing in an animal body, for we have often here well-marked evidence of pathogenic effects being produced at a distance from the actual focus of bacterial growth. This is further an instance of what we have strong reason to believe sometimes occurs, namely, that the toxins produced by bacteria, when these are growing in the animal body, differ somewhat from the toxins produced by the same bacteria growing in artificial media. Poisons appearing in cultures have been called *extracellular* toxins, but, as we shall see, we cannot as yet say whether they are excreted by the bacteria, or whether they are produced by the bacteria acting on the constituents of the media. We therefore cannot as yet draw a hard and fast line between intra- and extracellular toxins, but the terms are convenient, and may apply to two actually different sets of bodies. That the poisonous capacities of a

bacterium may be very complicated is shown by what is known in the case of the vibrio cholerae, where the poisons which dissolve out into the culture fluid are quite different in their nature from those which act when the dead bacteria are injected into an animal. The extracellular toxins are the more easily obtainable in large quantities, and it is their nature and effects which are best known.

The Nature of Toxins. — Nearly all of what little is known regarding this subject relates to the extracellular toxins. The earlier investigations upon toxins suggested that analogies exist between the modes of bacterial action and what takes place in ordinary gastric digestion, and the idea has been worked out for certain pathogenic bacteria by Sidney Martin. This observer took, not solutions artificially made up with albumoses, but the natural fluids of the body or definite solutions of albumins, and, further, never subjected the results of the bacterial growth to heat above 40°. C. or to any stronger agent than absolute alcohol. He found that albumoses and sometimes peptones were formed by the action of the pathogenic bacteria studied, and further, that the precipitate containing these albumoses was toxic. In certain cases the process of splitting up of the albumins went further than in peptic digestion, and organic bases or acids might be formed. According to Martin, the characteristic symptoms of the diseases could be explained by compound actions, in which the albumoses were responsible for some of the effects, the other bodies for others. A similar digestive action has been traced in the case of the tubercle bacillus by Kühne.

Further evidence that bacterial toxins are either albumoses or bodies having a still smaller molecule is furnished by C. J. Martin. This worker, by filling the pores of a Chamberland bougie with gelatin, has obtained what is practically a strongly supported colloid membrane through which dialysis can be made to take place under the great pressure say of compressed oxygen. He finds that in such an apparatus toxins, at least the two kinds tried, will pass through just as an albumose will.

Brieger and Boer, working with bouillon cultures of diphtheria and tetanus, have, by precipitation with zinc chloride, separated bodies which show characteristic toxic properties, but which have the reactions neither of peptone, albumose, nor albuminate, and

the nature of which is unknown. It has also been found that the bacteria of tubercle, tetanus, diphtheria, and cholera can produce toxins when growing in proteid-free fluids. In the case of diphtheria, when the toxin is produced in such a fluid a proteid reaction appears. Of course this need not necessarily be caused by the toxin. Further investigation is here required, for Ushinsky, applying Brieger and Boer's method to a toxin so produced, states that the toxin body is not precipitated by zinc salts, but remains free in the medium. If the toxins are really non-proteid they may, on the one hand, be the final product of a digestive action, or they may be the manifestation of a separate vital activity on the part of the bacteria. On the latter theory the toxicity of the toxalbumins of Brieger and Fraenkel, and of the toxic albumoses of Martin, may be due to the precipitation of the true toxins along with these other bodies. From the chemical standpoint this is quite possible. When we take into account the extraordinary potency of these poisons (in the case of tetanus the fatal dose of the pure poison for a guinea-pig must often be less than .000001 gr.), we must realise that all attempts by present chemical methods to isolate them in a pure condition are not likely to be successful, and of their real nature we know nothing. Amongst the properties of the extracellular toxins, however, are the following: They are certainly all uncrystallisable; they are soluble in water and they are dialysable; they are precipitated along with proteids by concentrated alcohol, and also by ammonium sulphate; if they are proteids they are either albumoses or allied to the albumoses; they are relatively unstable, having their toxicity diminished or destroyed by heat (the degree of heat which is destructive varies much in different cases), light, and by certain chemical agents. Their potency is often altered in the precipitations practised to obtain them in a pure or concentrated condition, but among the precipitants ammonium sulphate has little if any harmful effect. Regarding the toxins which are more intimately associated with the bacterial cell we know much less, but it is probable that their nature is similar, though some of them at least are not so easily injured by heat, *e.g.* in the case of the tubercle bacilli already mentioned. In the case of all toxins the fatal dose for an animal varies directly with the species, body weight, age, and previous conditions as to, *e.g.*, food, temperature, etc. In estimating the

minimal lethal dose of a toxin these factors must be carefully considered.

The following is the best method of obtaining concentrated extracellular toxins. The toxic fluid is placed in a shallow dish, and ammonium sulphate crystals are well stirred in till no more dissolve. Fresh crystals to form a bulk nearly equal to that of the whole fluid are added, and the dish set in an incubator at 37° C. over night. Next day a brown scum of precipitate will be found floating on the surface. This contains the toxin. It is skimmed off with a spoon, placed in watch-glasses, and these are dried *in vacuo* and stored in the dark, also *in vacuo*, or in an exsiccator containing strong sulphuric acid. For use the contents of one are dissolved up in a little normal saline solution.

The comparison of the action of bacteria in the tissues in the production of these toxins to what takes place in the gastric digestion, has raised the question of the possibility of the elaboration by these bacteria of *ferments* by which the process may be started. The problem of toxin formation is thus complicated. Sidney Martin has described toxic albumoses as occurring in all the diseases he investigated, viz., anthrax, ulcerative endocarditis, diphtheria, and tetanus. In each of these cases, therefore, we would be led to suppose that ferments might be produced, which we may look on as the primary toxic agent which acts by digesting surrounding material and producing albumoses which form the secondary poisons. From the standpoint of the bacterium this process would simply be a preparation of food for further intracellular digestion. Hitherto all attempts at the isolation of bacterial ferments of such a nature have failed.

The question of fermentation has been chiefly discussed with regard to what happens in diphtheria and tetanus. Apart from the fact that a digestive action has occurred, which the presence of albumoses in the body of an animal dead of these diseases affords, the chief available evidence for the existence of ferments lies in this, that the toxic products of the bacteria involved lose their toxicity by exposure to a temperature which puts an end to the diastatic activity of such an undoubted ferment as that of the gastric juice. If a bouillon containing diphtheria toxin be heated at 65° C. for one hour, it is found to have lost much of its toxic effect, and in the case of *B. tetani* all the toxicity is lost by exposure at this temperature. In both diseases there is a still further fact which is adduced in favour of a ferment being concerned in the toxic action, namely, the existence of a definite

period of incubation between the injection of the toxic bodies and the appearance of symptoms. This may be interpreted as showing that after the introduction of say a filtered bouillon culture, further chemical substances are formed in the body before the actual toxic effect is produced. In the case of tetanus at least the delay, however, may be explained by the fact that the poison apparently has to travel up the nerve trunks before the real poisonous action is developed. With some poisons presently to be mentioned which are closely allied to the bacterial toxins an incubation period may not exist. It would not be prudent to dogmatise as to whether the toxins do or do not belong to such an ill-defined group of substances as the ferments. It may be pointed out, however, that the essential concept of a ferment is that of a body which can originate change without itself being changed, and no evidence has been adduced that toxins fulfil this condition. Another property of ferments is that, so long as the products of fermentation are removed, the action of a given amount of ferment is indefinite. Again, in the case of toxins no evidence of such an occurrence has been found. A certain amount of a toxin is always associated with a given amount of disease effect, though a process of elimination of waste products must be all the time going on in the animal's body. Again, too much importance must not be attached to loss of toxicity by toxins at relatively low temperatures. Many proteids show a tendency to change at such temperatures; for instance, if egg albumin be kept long enough at 55° C. nearly the whole of it will be coagulated. Such considerations suggest that the relation of toxic action to fermentation must be left an open question.

Similar Vegetable and Animal Poisons. — Within recent years it has been found that the bacterial poisons belong to a group of toxic bodies all presenting very similar properties, other members of which occur widely in the vegetable and animal kingdoms. Among plants the best-known examples are the ricin and abrin poisons, obtained by making watery emulsions of the seeds of the *Ricinus communis* and the *Abrus precatorius* (jequirity) respectively. From the *Robinia pseudacacia* another poison — robin — belonging to the same group is obtained. The chemical reactions of ricin and abrin correspond to those of the bacterial toxins. They are soluble in water, they are precipitable by alcohol, but being less easily dialysable than the albumoses they have been called toxalbumins. Their toxicity is seriously impaired by boiling, and they also gradually become less toxic on being kept. Both are among the most powerful poisons known — ricin being the more fatal. When they are in-

jected subcutaneously a period of twenty-four hours usually elapses—whatever be the dose—before symptoms set in. Both tend to produce great inflammation at the seat of inoculation, which in the case of ricin may end in an acute necrosis; in fatal cases hæmorrhagic enteritis and nephritis may be found. Both act as irritants to mucous membranes, abrin especially being capable of setting up most acute conjunctivitis.

It is also certain that the poisons of scorpions and of poisonous snakes belong to the same group. The poisons derived from the latter are usually called venins, and a very representative group of such venins derived from different species has been studied. To speak generally there is derivable from the natural secretions of the poison glands a series of venins which have all the reactions of the bodies previously considered. Like ricin and abrin, they are not so easily dialysable as bacterial toxins, and therefore have also been classed as toxalbumins. Their properties are also similar; many of them are destroyed by heat, but the degree necessary here also varies much. There is also evidence that in a crude venin there may be several poisons differently sensitive to heat. All the venins are very powerful poisons, but here there is practically no period of incubation—the effects are almost immediate. The toxicity of the venins varies much with the animal employed, but chiefly with the species of snake from which it was derived. For instance, .47 milligramme of crude venin from the Indian cobra will kill a rabbit in three or four hours. In the case of the American rattlesnake the dose would be 3.5 milligrammes, and in that of the Australian *hoplocephalus variegatus* 2.5 milligrammes. The general effects of these vary with the dose, and slight variations also exist between the effects of venins of different snakes. Thus cobra poison is said to produce rapid paralysis of the lips, tongue, larynx, and respiratory apparatus, from which death results. On the other hand, the venin of the *daboia* of Ceylon is said to cause violent general convulsions, succeeded by paralysis, but with very little respiratory affection. In the case of a dose not sufficient to cause immediate death from its general effects, often the most acute and widespread necrosis may occur in a few hours round the site of inoculation.

The Theory of Toxic Action.—While we know little of the chemical nature of any toxins, we may, from our knowledge of their properties, group together the tetanus and diphtheria poisons, ricin, abrin, snake poisons, and scorpion poisons. Besides the points of agreement already noted, all possess the further property that, as will be afterwards described, when introduced into the bodies of susceptible animals they stimulate the production of substances called antitoxins. The nature of the antagonism between toxin and antitoxin will be discussed later. Here, to explain what follows, it may be stated (1) that the molecule of toxin most probably forms a chemical combination with the molecule of antitoxin, and (2) that it has been shown that toxin molecules may lose much of their toxic power and

still be capable of uniting with exactly the same proportion of antitoxin molecules. From these and other circumstances, Ehrlich has advanced the view that the toxin molecule has a very complicated structure, and contains two atom-groups. One of these, the *haptophorous* (*ἄπτειν*, to bind to), is that by which combination takes place with the antitoxin molecule and also with presumably corresponding molecules naturally existing in the tissues. The other atom-group he calls the *toxophorous*, and it is to this that the toxic effects are due. This atom-group is bound to the cell elements, *e.g.* the nerve cells in tetanus, by the haptophorous group. Ehrlich holds that the toxophorous group is the more complicated and also the less stable. It is known that, for instance, a diphtheria toxin obtained by the filtration of a bouillon culture loses its toxicity when subjected to such physical agencies as light and heat, and to certain chemical substances. Ehrlich explains this on the theory that the toxophorous group undergoes disintegration. And if we suppose that the haptophorous group remains unaffected, we can then understand how a toxin may have its toxicity diminished and still require the same proportion of antitoxin molecules for its neutralisation. To the bodies whose toxophorous atom-groups have become degenerated, Ehrlich gives the name *toxoids*, and more recently he has called them *toxones*. He states that he has found evidence that similar bodies may be directly formed by the diphtheria bacillus and not as the result of subsequent degeneration. Such observations are of importance, not only as throwing light on the constitution of the toxin molecule, but also as affording an explanation of how altered toxins (toxoids) can act as immunising agents by stimulating antitoxin formation. The theory may also afford an explanation of what has been suspected, namely, that in some instances toxins derived from different sources may be related to one another. For example, Ehrlich has pointed out that ricin produces in a susceptible animal body an antitoxin which corresponds almost completely with that produced by another vegetable poison, robin (*vide supra*), though ricin and robin are certainly different. This may be due to the fact that robin is a toxoid of ricin, *i.e.* their haptophorous groups correspond, while their toxophorous differ. The evidence on which Ehrlich's deductions are based is of a very weighty character, and will be again referred to in the chapter on Immunity.

CHAPTER VII.

INFLAMMATORY AND SUPPURATIVE CONDITIONS.

THIS subject is an exceedingly wide one, and embraces a great many pathological conditions which in their general characters and results are widely different. Thus in addition to suppuration, various inflammations, ulcerative endocarditis, septicæmia, and pyæmia, will come up for consideration. With regard to these the two following general statements, established by bacteriological research, may be made in introducing the subject. In the first place, there is no one specific organism for any one of these conditions; various organisms may produce them, and not infrequently more than one organism may be present together. In the second place, the same organism may produce widely varying results under different circumstances,—at one time a local inflammation or abscess, at another multiple suppurations or a general septicæmia. The principles on which this diversity in results depends have already been explained (p. 158).

It may be well to emphasise some of the chief points in the pathology of these conditions. In *suppuration* the two main phenomena are—(a) a progressive immigration of leucocytes, chiefly of the polymorpho-nuclear (neutrophile) variety, and (b) a liquefaction or digestion of the supporting elements of the tissue along with necrosis of the cells of the part. The result is that the tissue affected becomes replaced by the cream-like fluid called pus. A suppurative inflammation is thus to be distinguished on the one hand from an inflammation without destruction of tissue, and on the other from necrosis or death *en masse*, where the tissue is not liquefied, and leucocyte accumulation may be slight. When, however, suppuration is taking place in a very dense fibrous tissue, liquefaction may be incomplete, and a portion of dead tissue or slough may remain in the centre, as is the case in boils. In the case of suppuration in a serous cavity the two chief factors are the progressive

leucocytic accumulation and the disappearance of any fibrin which may be present.

The liquefaction of the formed tissue elements in suppuration depends chiefly upon a peptonising action of the organisms or of ferments produced by them, and the progressive leucocytic aggregation is most probably the effect of microbic products which attract the leucocytes, or in other words exert a *positive chemiotaxis*. From this it might be inferred that suppuration is almost exclusively related to the presence of living organisms, and this is found to be actually the case. Many experiments have been performed to determine whether suppuration can be produced by various chemical substances, such as croton oil, nitrate of silver, turpentine, etc., care, of course, being taken to ensure the absence of bacteria. The general result obtained by independent observers is that as a rule suppuration does not follow, but that in certain animals and with certain substances it may, the pus being free from bacteria. It is still, however, questioned by some whether the pus thus produced really corresponds histologically and chemically with that due to bacterial action. Buchner showed that suppuration may be produced by the injection of dead bacteria, *e.g.* sterilised cultures of *bacillus pyocyaneus*, etc. The subject has now more a scientific than a practical interest, and the general statement may be made that practically all cases of true suppuration met with clinically are due to the action of living micro-organisms.

The term *septicæmia* is applied to conditions in which the organisms multiply within the blood and give rise to symptoms of general poisoning, without, however, producing abscesses in the organs. In all cases of septicæmia the organisms are more numerous in the capillaries of internal organs than in the peripheral circulation, and, in the case of the human subject, it is often impossible to detect any in the blood during life, though they may be seen in large numbers in the capillaries of the kidneys, liver, etc., *post mortem*. The essential fact in *pyæmia*, on the other hand, is the occurrence of multiple abscesses in internal organs and other parts of the body. In most of the cases of typical pyæmia, common in pre-antiseptic days, the starting-point of the disease was a septic wound with bacterial invasion of a vein, leading to thrombosis and secondary embolism. Multiple foci of suppuration may be produced, however, in other

ways, as will be described below (p. 196). If the term *pyæmia* be used to embrace all such conditions, their method of production should always be distinguished.

BACTERIA AS CAUSES OF INFLAMMATION AND SUPPURATION.

A considerable number of species of bacteria have been found in acute inflammatory and suppurative conditions, and of these many have been proved to be causally related, whilst of some others the exact action has not yet been fully determined.

Ogston, who was one of the first to study this question (in 1881), found that the organisms most frequently present were micrococci, of which some were arranged irregularly in clusters (staphylococci), whilst others formed chains (streptococci). He found that the former were more common in circumscribed acute abscesses, the latter in spreading suppurative conditions. Rosenbach shortly afterwards (1884), by means of cultures, differentiated several varieties of micrococci, to which he gave the following special names: *staphylococcus pyogenes aureus*, *staphylococcus pyogenes albus*, *streptococcus pyogenes*, *micrococcus pyogenes tenuis*. Other organisms have been met with in suppuration, such as *staphylococcus epidermidis albus* (Welch), *staphylococcus pyogenes citreus*, *staphylococcus cereus albus*, *staphylococcus cereus flavus*, *bacillus pyogenes fætidus* (Passet), *bacillus coli communis*, *bacillus lactis aerogenes*, *bacillus aerogenes capsulatus*, *bacillus pyocyaneus*, *micrococcus tetragenus*, *pneumococcus*, *pneumobacillus*, *diplococcus intracellularis meningitidis*, and others.

In secondary inflammations and suppurations following acute diseases the corresponding organisms have been found in some cases, such as gonococcus, pneumococcus of Fraenkel, pneumobacillus of Friedländer, and the typhoid bacillus.

Suppuration is also produced by the actinomyces and the glanders bacillus, and sometimes chronic tubercular lesions have a suppurative character.

Staphylococcus pyogenes aureus. — *Microscopical Characters.* — This organism is a spherical coccus about $.9 \mu$ in diameter, which grows irregularly in clusters or masses (Fig. 65), and occasionally short chains of 4 to 10 units may be seen, but may readily be distinguished from short chains of Streptococcus by the fact that the lines of division between cocci lie parallel with

the long axis of the chain. It stains readily with all the basic aniline dyes, and retains the colour in Gram's method.

Cultivation. — It grows readily in all the ordinary media at the room temperature, though much more rapidly at the temperature of the body. In stab-cultures in *peptone gelatin* a streak of growth is visible on the day after inoculation, and on the second or third day, liquefaction commences at the top. As liquefaction proceeds, the growth falls to the bottom as a flocculent deposit, which soon assumes a bright yellow colour,

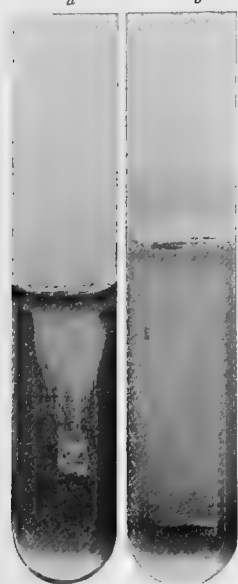

FIG. 66. — Two stab-cultures of *staphylococcus pyogenes aureus* in gelatin, (a) 10 days old, (b) 3 weeks old: showing liquefaction of the medium and characters of growth. Natural size.

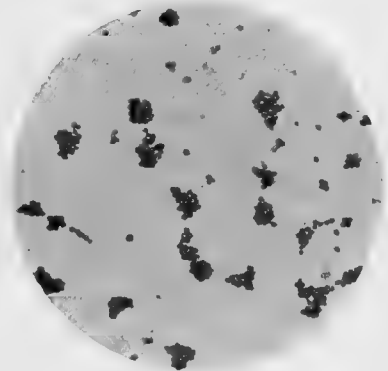

FIG. 65. — *Staphylococcus pyogenes aureus*, young culture on agar, showing clumps of cocci. Stained with weak carbol-fuchsin. $\times 1000$.

while a yellowish film may form on the surface, the fluid portion still remaining turbid. Ultimately liquefaction extends out to the wall of the tube (Fig. 66). In *gelatin plates* colonies may be seen with the low power of the microscope in twenty-four hours, as little balls somewhat granular on the surface and of brownish colour. On the second day they are visible to the naked eye as whitish yellow points, which afterwards become more distinctly yellow. Liquefaction occurs around these, and little cups are formed, at the bottom of which colonies form little yellowish masses. On *agar*, a stroke-culture forms a line of abundant yellowish growth, with smooth, shining surface, well formed after twenty-four hours at 37° C. Later it becomes bright orange in colour, and resembles a streak of oil paint. Single colonies on the surface of agar are circular discs of similar appearance, which may reach 2 mm. or more in diameter. On

potatoes; it grows well at ordinary temperature, forming a somewhat abundant layer of orange colour. In *bouillon* it produces a uniform turbidity, which afterwards settles to the bottom as an abundant layer, which assumes a brownish-yellow tint. In the various media it renders the reaction acid, and it coagulates but does not peptonise milk, in which it readily grows. The cultures have a somewhat sour odour.

It has considerable tenacity of life outside the body, cultures in gelatin often being alive after having been kept for several months. It also requires a rather higher temperature to kill it than most spore-free bacteria, viz. 80° C. for half an hour (Lübbert).

The *staphylococcus pyogenes albus* is similar in character, with the exception that its growth on all the media is white. The colour of the *staphylococcus aureus* may become less distinctly yellow after being kept for some time in culture, but it rarely assumes the white colour of the *staphylococcus albus*, and it has not been found possible to transform the one organism into the other.

Staphylococcus epidermidis albus (Welch) is, according to its discoverer, the most common organism inhabiting the skin, occurring not only on its superficial parts, but deeper down, in the hair follicles, and the ducts of the sebaceous and sweat glands, where it is not effected by the most efficient methods of disinfection. Welch regards it as being a "sport" of *staphylococcus pyogenes albus* and possessed of weak pathogenic powers. It is the usual cause of "stitch abscesses," following upon operative measures. Culturally it shows no variations from the phenomena observed with *staphylococcus pyogenes albus*, excepting that it requires a relatively longer period of time to accomplish the same. It is probably an attenuated variety of the *staphylococcus albus*.

The *staphylococcus pyogenes citreus*, which is less frequently met with, differs in the colours of the cultures being a lemon yellow, and is less virulent than the other two.

The *staphylococcus cereus albus* and *staphylococcus cereus flavus* are of much less importance. They produce a wax-like growth on gelatin without liquefaction; hence their name.

Streptococcus pyogenes.—This organism is a coccus of slightly larger size than the *staphylococcus aureus*, about 1 μ in diameter, and forms chains which may contain a large number of members, especially when it is growing in fluids (Fig. 67). The chains vary somewhat in length in different specimens, and on this ground varieties have been distinguished, e.g. the *strepto-*

coccus brevis and *streptococcus longus* (*vide infra*). As division may take place in many of the cocci in a chain at the same time, the appearance of a chain of diplococci is often met with, the line of division lying always at right angles to the long axis of the chain. In young cultures the cocci are fairly uniform in size, but after a time their size presents considerable variations, many swelling up to twice their normal diameter. These are to be regarded as involution forms. In its staining reactions the streptococcus resembles the staphylococci described, being readily coloured by Gram's method.

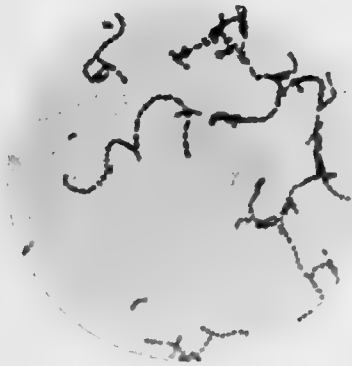

FIG. 67.—*Streptococcus pyogenes*; young culture on agar, showing chains of cocci. Stained with weak carbol-fuchsin. $\times 1000$.

Cultivation.—In cultures outside the body the streptococcus pyogenes grows much more slowly than the staphylococci, and also dies out more readily, being in every respect a more delicate organism.



FIG. 68.—Culture of the *streptococcus pyogenes* on an agar plate, showing numerous colonies—three successive strokes. Twenty-four hours' growth. Natural size.

In *peptone gelatin* a stab-culture shows, about the second day, a thin line which in its subsequent growth is seen to be formed of a row of minute rounded colonies of whitish colour, which may be separate at the lower part of the puncture. They do not usually exceed the size of a small pin's head, this size being reached about the fifth or sixth day. The growth does not spread on the surface and no liquefaction of the medium occurs. The colonies in gelatin plates have a corresponding appearance, being minute spherical points of whitish colour. On the *agar* media growth takes place along the stroke as a collection of small circular discs of semi-translucent appearance, which show a great tendency to remain separate (Fig. 68). The separate colonies

show a great tendency to remain separate (Fig. 68). The separate colonies

remain small, rarely exceeding 1 mm. in diameter. Cultures on agar kept at the body temperature may often be found to be dead after ten days. On *potato*, as a rule, no visible growth takes place. In *bouillon*, growth forms numerous minute granules which afterwards fall to the bottom, the deposit, which is usually not very abundant, having a sandy appearance. The appearance in broth, however, presents variations which have been used as an aid to distinguish different species of streptococci. It has been found that those which form the longest chains grow most distinctly in the form of spherical granules, those forming short chains giving rise to a finer deposit. To a variety which forms distinct spherules of minute size the term *streptococcus conglomeratus* has been given. The question as to the existence of varieties of streptococcus pyogenes will be discussed below.

Bacillus coli communis.—The microscopic and cultural characters are described in the chapter on typhoid fever. The *bacillus lactis aerogenes* and the *bacillus pyogenes fetidus* closely resemble it; they are either varieties or closely related species. The former is distinguished morphologically by its general coccus or diplococcus form, and culturally by its growth on gelatin, etc., by producing more abundant gas formation in sugar media and in acting upon the starch of potato with gas production. In milk cultures its coagulative action is more rapid, and usually in this medium exhibits encapsulation. In gelatin its growth is more luxuriant and whiter than that of *B. coli*.

Bacillus aerogenes capsulatus sometimes invades the tissues before death, and is characterised by the formation of bubbles of gas in the infected parts. Its characters are described in Chapter XVII.

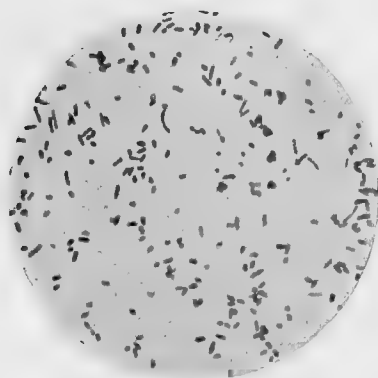

FIG. 69.—*Bacillus pyocyaneus*; young culture on agar.

Stained with weak carbol-fuchsin. $\times 1000$.

Bacillus pyocyaneus.—This organism occurs in the form of minute rods 1.5 to 3 μ in length and less than .5 μ in thickness (Fig. 69). Occasionally two or three are found attached end to end. They are actively motile, and do not form spores. They stain readily with the ordinary basic stains, but are decolorised by Gram's method.

Cultivation.—It grows readily on all the ordinary media at the room temperature, the cultures being distinguished by the formation of a greenish pigment. In puncture cultures in peptone-gelatin a greyish line appears in

twenty-four hours, and at its upper part a small cup of liquefaction forms within forty-eight hours. At this time a slightly greenish tint is seen in the superficial part of the gelatin. The liquefaction extends pretty rapidly, the fluid portion being turbid and showing masses of growth at its lower part. The green colour becomes more and more marked and diffuses through the gelatin. Ultimately liquefaction reaches the wall of the tube. In plate cultures the colonies appear as minute whitish points, those in the surface being the larger. Under a low power of the microscope they have a brownish yellow colour and show a modulated surface, the superficial colonies being thinner and larger. Liquefaction soon occurs, the colonies on the surface forming shallow cups with small irregular masses of growth at the bottom, the deep colonies small spheres of liquefaction. Around the colonies a greenish tint appears. On agar the growth forms an abundant slimy greyish layer which afterwards becomes greenish and has a metallic sheen, and a bright green colour diffuses through the whole substance of the medium. On potatoes the growth is an abundant reddish-brown layer resembling that of the glanders bacillus, and the potato sometimes shows a greenish discoloration. Milk is slightly acidified, and peptonised without coagulation as a rule.

From the cultures there can be extracted by chloroform a coloured body pyocyanin, which belongs to the aromatic series, and crystallises in the form of long, delicate bluish-green needles. On the addition of a weak acid its colour changes to a red.

In man, many observers have described it as being associated with abscess formation, pericarditis, pyelitis, dysentery, etc. It has likewise distinct pathogenic action in certain animals. Subcutaneous injection of small doses in rabbits may produce a local suppuration, but if the dose be large, spreading hæmorrhagic œdema results, which may be attended by septicæmia.

Intravenous injection may produce, according to the dose, rapid septicæmia with nephritis, or sometimes a more chronic condition of wasting attended by albuminuria.

Micrococcus tetragenus. — This organism, first described by Gaffky, is characterised by the fact that it divides in two planes at right angles to one another (Fig. 70), and is thus generally found in the tissues in groups of four or tetrads, which are often seen to be surrounded by a capsule. The cocci measure $1\ \mu$ in diameter. They stain readily with all the ordinary stains, and also retain the stain in Gram's method.

It grows readily on all the media at the room temperature. In a puncture culture on peptone-gelatin a pretty thick whitish line forms along the track of the needle, whilst on the surface there is a thick rounded disc of whitish colour. The gelatin is not liquefied.

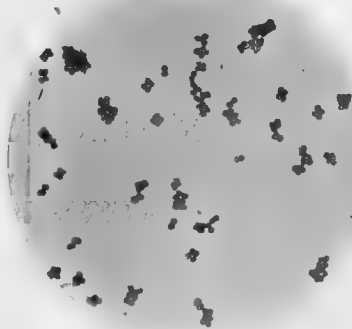

FIG. 70. — *Micrococcus tetragenus*; young culture on agar, showing tetrads. Stained with weak carbol-fuchsin. $\times 1000$.

On the surface of agar and of potato the growth is an abundant moist layer of the same colour. The growth on all the media has a peculiar viscid or tenacious character, owing to the gelatinous character of the sheaths of the cocci.

White mice are exceedingly susceptible to this organism. Subcutaneous injection is followed by a general septicæmia, the organism being found in large numbers in the blood throughout the body. Guinea-pigs are less susceptible; sometimes only a local abscess with a good deal of necrotic change results; sometimes there is also septicæmia.

Diplococcus intracellularis meningitidis. — This organism was first found by Weichselbaum in the purulent exudate in a number of cases of cerebro-spinal meningitis, and has since been found by other observers in some epidemics of the disease. It occurs in large numbers in the pus in the form of a rounded or oval diplococcus (with the long axis lying transversely), chiefly in the interior of leucocytes (Fig. 71).

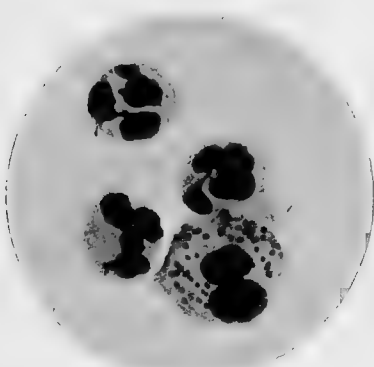

FIG. 71. — Film preparation of exudation from a case of meningitis, showing the diplococci within leucocytes.

Stained with carbol-thionin-blue. $\times 1000$.

In fact, it closely resembles the gonococcus both in morphological characters and in arrangement. Like the latter also it loses the stain in Gram's method. Its conditions of growth outside the body are somewhat limited. It grows best on glycerin agar and Löffler's blood serum, forming a number of transparent colonies which run together to form a thin layer. Growth occurs most rapidly at the temperature of the body, and entirely ceases at the ordinary room temperature. Individual cultures die out after two to six days, but growth can be maintained indefinitely in successive subcultures. Inoculation by ordinary methods shows that it has little virulence for guinea-pigs, rabbits, etc. A number of experiments have been

performed by introducing pure cultures under the dura, and in some cases meningitis and encephalitis have resulted, but the disease as it affects the human subject is not fully reproduced. From the constancy with which it has been found in the various cases of some epidemics there can be little doubt that it is the causal agent in a certain proportion of cases of cerebro-spinal meningitis (p. 201). It is of interest to note that in a considerable number of such cases it has been detected during the disease in the nasal secretion, whereas in normal individuals it is very rare.

Bacillus acnes. — According to Gilchrist this organism is the undoubted cause of a pustular disease of the skin known as acne vulgaris. The morphology of the organism as seen in smear preparations made direct from the pus of an acne nodule, resembles very closely that of *B. coli*, the bacilli being short and plump with rounded ends; very rarely branching forms are met with, although in old cultures such forms are not uncommon. The bacilli

stain readily with the common aniline dyes, occasionally showing plasmolytic vacuolation; they retain the stain in Gram's method. They are non-motile, but Brownian movement is very active. No spores have been observed. Growth occurs best at 37° C. on glycerin agar, whose reaction is 3·0 + to phenol-phthaleine, on blood serum (Löffler's), and in bouillon, less frequently in litmus milk. No growth is noticeable on potato, gelatin, or in Dunham's medium. For successful isolation from an acne node, glycerin agar or Löffler's blood serum should be used, and the material from the nodule should not be smeared over the surface but deposited in pieces about 2 c.mm. and allowed to incubate a week or ten days. Then these small whitish masses (which are in truth the bacilli themselves) will be found to have increased in bulk and thrown out an extending grey zone of growth; their consistency is somewhat pultaceous, and they may be moved about *en masse* with the needle. Old cultures take on a pink or light maroon colour, or sometimes a yellow-drab.

In well-marked cases of the disease the blood of the patient will cause agglutination of the bacilli in dilutions of 1-50, 1-60, and 1-100.

The organism is pathogenic to mice and guinea-pigs, either upon subcutaneous or intraperitoneal inoculation.

Experimental Inoculation. — We shall consider chiefly the staphylococcus pyogenes aureus and the streptococcus pyogenes, as these have been most fully studied.

It may be stated at the outset that the occurrence of suppuration depends upon the number of organisms introduced into the tissues, the number necessary varying not only in different animals, but also in different parts of the same animal, a smaller number producing suppuration in the anterior chamber of the eye, for example, than in the peritoneum. The virulence of the organism also may vary, and corresponding results may be produced. Especially is this so in the case of the streptococcus pyogenes.

The *staphylococcus aureus*, when injected *subcutaneously* in suitable numbers, produces an acute local inflammation which is followed by suppuration, in the manner described above. The spread of the suppuration goes *pari passu* with the growth of the cocci. Wherever the condition is spreading the cocci are present in the tissues at the margin, but after it has ceased to spread they are practically confined to the pus. In the latter case reaction occurs on the part of the connective tissues in the form of cellular proliferation and formation of new capillaries, which lead to the formation of a granulation tissue barrier. If a large dose is injected, the cocci may enter the blood stream in sufficient numbers to cause secondary suppurative foci in internal organs (*cf.* intravenous injection).

Intravenous injection in rabbits, for example, produces interesting results which vary according to the quantity used. If a considerable quantity be injected, the animal may die in twenty-four hours of a general septicæmia, numerous cocci being present in the capillaries of the various organs, often forming plugs. If a smaller quantity be used, the cocci gradually disappear from the circulating blood; some become destroyed, while others settle in the capillary walls in various parts and produce minute abscesses. These are most common in the kidneys, where they occur both in the cortex and medulla as minute yellowish areas surrounded by a zone of intense congestion and hæmorrhage. Similar small abscesses may be produced in the heart wall, in the liver, under the periosteum, and in the interior of bones, and occasionally in the striped muscles. Very rarely indeed, in experimental injection, do the cocci settle on the healthy valves of the heart. If, however, when the organisms are injected into the blood, there be any traumatism of a valve, or of any other part of the body, they show a special tendency to settle at these weakened points.

Experiments on the *human subject* have also proved the pyogenic properties of those organisms. Garré inoculated scratches near the root of his finger-nail with a pure culture, a small cutaneous pustule resulting; and by rubbing a culture over the skin of the forearm he caused a carbuncular condition which healed only after some weeks. Confirmatory experiments of this nature have been made by Bockhart, Bumm, and others. Harris has observed an infection to occur upon the palmar surfaces of the fingers of both hands, the organisms having, in the absence of any demonstrable lesion, passed down the sweat ducts to the deeper lying tissues.

When tested experimentally the staphylococcus pyogenes albus has practically the same pathogenic effects as the staphylococcus aureus.

The *streptococcus pyogenes* is an organism the virulence of which varies much according to the diseased condition from which it has been obtained, and also one which loses its virulence rapidly in cultures. Even highly virulent cultures, if grown under ordinary conditions, in the course of time lose practically all pathogenic power. By passage from animal to animal, however, the virulence may be much increased, and *pari passu* the effects of inoculation are correspondingly varied. Marmorek,

for example, found that the virulence of a streptococcus can be enormously increased by growing it alternately (*a*) in a mixture of human blood serum and bouillon (*vide* p. 46), and (*b*) in the body of a rabbit; ultimately, after several passages it possesses a super-virulent character, so that even an extremely minute dose introduced into the tissues of a rabbit produces rapid septicæmia, with death in a few hours. It has been proved by Marmorek's experiments, and those of others, that the same species of streptococcus may produce at one time merely a passing local redness, at another a local suppuration, at another a spreading erysipelatous condition, or again a general septicæmic infection, according as its virulence is artificially increased. Such experiments are of extreme importance as explaining to some extent the great diversity of lesions in the human subject with which streptococci are associated.

Varieties of Streptococci. — Formerly the streptococcus pyogenes and the streptococcus erysipelatis were regarded as two distinct species, and various points of difference between them were given. Further study, and especially the results obtained by modifying the virulence, have shown that these distinctions cannot be maintained, and now nearly all authorities are agreed that the two organisms are one and the same, erysipelas being produced when the streptococcus pyogenes of a certain standard of virulence gains entrance to the lymphatics of the skin. Petruschky, moreover, has shown conclusively that a streptococcus cultivated from pus may cause erysipelas in the human subject. He obtained a pure culture of a streptococcus from a case of purulent peritonitis secondary to parametritis, the patient having never suffered from erysipelas. By inoculations with this culture he produced typical erysipelas in two women suffering from cancer.

More recently a distinction has been drawn between a *streptococcus longus*, which forms long chains, and is pathogenic to rabbits or mice, and a *streptococcus brevis*, which occurs in the mouth in normal conditions, and is without pathogenic properties when tested experimentally. The growth of the former in bouillon forms a somewhat granular deposit, that of the latter a more abundant and flocculent deposit. Marmorek has, however, found that the same streptococcus may at one time grow in short, at another in long chains, and Kolle has shown that a streptococcus, which originally grew in long chains, formed only short chains after being repeatedly passed through the body of the mouse, the appearance of the growth in bouillon being corre-

spondingly altered (p. 186). There does not, therefore, seem at present sufficient evidence for looking upon these two varieties as distinct species. It is sufficient to bear in mind that streptococci in the normal mouth are usually non-virulent, and grow in short chains. On the other hand, in some cases of very virulent streptococcus infection in the human subject we have found the organism occurring only in very short chains. The *streptococcus conglomeratus*, so called from the appearance of the growth in bouillon, is to be regarded merely as another variety, which forms very long chains and is usually possessed of a high degree of virulence, though its distinctive characters are not permanent. It has often been obtained from the fauces in scarlet fever.

We may accordingly conclude that, though it cannot be definitely stated that all the streptococci concerned in the production of disease in the human subject are of the same species, we have not the means of classifying them as distinct species.

Bacillus coli communis.—The virulence of this organism also varies much and can be increased by passage from animal to animal. Injection into the serous cavities of rabbits produces a fibrinous inflammation which becomes purulent if the animal lives sufficiently long. If, however, the virulence of the organism be of a high order, death takes place before suppuration is established, and there is a septicæmic condition, the organisms occurring in large numbers in the blood. Intravenous injection of a few drops of a virulent bouillon culture usually produces a rapid septicæmia with scattered hæmorrhages in various organs.

Other Effects.—It has been found by independent observers that in cases where rabbits recover after intravenous injection of bacillus coli communis, a certain proportion suffer from paralysis and sometimes from atrophy of muscles, especially of the posterior limbs, these symptoms being due to lesions of the cells in the anterior cornua of the spinal cord. Somewhat similar results have been obtained by others after inoculations with staphylococci and streptococci, a certain proportion only of the animals showing paralytic symptoms and corresponding changes in the spinal cord. The lesions are believed to be due chiefly to the action of the products of the organisms on the highly organised nervous elements. Much further research requires to be done before the importance of these results can be properly estimated, but it is not improbable that they will throw light on the causation of nervous lesions which occur in the human subject, and the etiology of which at present is quite obscure. Some observers, chiefly of the French school, consider that paralysis associated with cystitis, in which the bacillus coli communis is often present, may have such a causation, and that paralytic conditions following acute infective fevers may be produced by the products of pyogenic cocci, which frequently occur in these conditions.

Lesions in the Human Subject.—The following statement may be made with regard to the occurrence of the chief organisms mentioned, in the various suppurative and inflammatory conditions in the human subject. The account is, however, by no means exhaustive, as clinical bacteriology has shown that practically every part of the body may be the site of a lesion produced by the pyogenic bacteria. It may also be noted that acute catarrhal conditions of cavities or tubes are in many cases also to be ascribed to their presence.

The *staphylococci* are the most common causal agents in localised abscesses, in pustules on the skin, in carbuncles, boils, etc., in acute suppurative periostitis, in catarrhs of mucous surfaces, in ulcerative endocarditis, and in various pyæmic conditions. They may also be present in septicæmia.

Streptococci are especially found in spreading inflammation with or without suppuration; in diffuse phlegmonous and erysipelatous conditions, suppurations in serous membranes and in joints (Fig. 72). They also occur in acute suppurative periostitis and ulcerative endocarditis.

Secondary abscesses in lymphatic glands and lymphangitis are also, we believe, more frequently caused by streptococci than staphylococci. They also produce fibrinous exudation on the mucous surfaces, leading to the formation of false membrane in many of the cases of non-diphtheritic inflammation of the throat, which are met with in scarlatina¹ and other conditions, and they are also the organisms most frequently

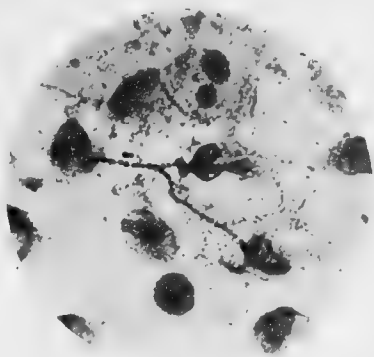

FIG. 72.—Streptococci in acute suppuration. Corrosive film; stained by Gram's method and safranin. $\times 1000$.

present in acute catarrhal inflammations of this situation. In puerperal peritonitis they are frequently found in a condition of purity, and they also appear to be the most frequent cause of puerperal septicæmia, in which condition they may be found after death in the capillaries of various organs. In pyæmia

¹ True diphtheria may also occasionally be associated with this disease, usually as a sequel.

they are frequently present, though in most cases associated with other pyogenic organisms. Some cases of enteritis in infants—streptococcic enteritis—are also apparently due to a streptococcus, which, however, presents in cultures certain points of difference from the streptococcus pyogenes.

The *bacillus coli communis* is found in a great many inflammatory and suppurative conditions in connection with the alimentary tract—for example, in suppuration in the peritoneum, or in the extraperitoneal tissue with or without perforation of the bowel, in the peritonitis following strangulation of the bowel, in appendicitis and the lesions following it, in suppuration around the bile-ducts, etc. It may also occur in lesions in other parts of the body,—endocarditis, pleurisy, etc., which in some cases are associated with lesions of the intestine, though in others such cannot be found. It is also frequently present in inflammation of the urinary passages, cystitis, pyelitis, abscesses in the kidneys, etc., these lesions being in fact most frequently caused by this or closely allied organisms.

In certain cases of enteritis it is probably the causal agent, though this is difficult of proof, as it is much increased in numbers in practically all abnormal conditions of the intestine. We may remark that it has been repeatedly proved that the bacillus coli cultivated from various lesions is more virulent than that in the intestine, its virulence having been heightened by growth in the tissues.

The *micrococcus tetragenus* is often found in suppurations in the region of the mouth or in the neck, and also occurs in various lesions of the respiratory tract, in phthysical cavities, abscesses in the lungs, etc. Sometimes it is present alone, and probably has a pyogenic action in the human subject under certain conditions. In other cases it is associated with other organisms. Recently one or two cases of pyæmia have been described in which this organism was found in a state of purity in the pus in various situations. In this latter condition the pus has been described as possessing an oily, viscous character, and as being often blood-stained.

The *bacillus pyocyaneus* is rarely found alone in pus, though it is not infrequent along with other organisms. We have met with it twice in cases of multiple abscesses, in association with the staphylococcus pyogenes aureus. Lately some diseases in

children have been described in which the bacillus pyocyaneus has been found throughout the body; in these cases the chief symptoms have been fever, gastro-intestinal irritation, pustular or petechial eruptions on the skin, and general marasmus.

Suppurative and inflammatory conditions, associated with the organisms of special diseases, will be described in the respective chapters.

Mode of Entrance and Spread.—Many of the organisms of suppuration have a wide distribution in nature, and many also are present on the skin and mucous membranes of healthy individuals. Staphylococci are commonly present on the skin, and also occur in the throat and other parts, and streptococci can often be cultivated from the secretions of the mouth in normal conditions. The pneumococcus of Fraenkel and the pneumobacillus of Friedländer have also

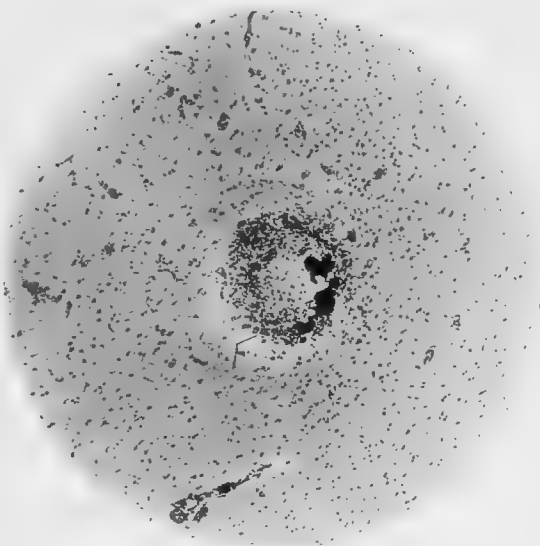

FIG. 73.—Minute focus of commencing suppuration in brain—case of acute ulcerative endocarditis. In the centre a small hæmorrhage; to right side dark masses of staphylococci; zone of leucocytes at periphery.

Alum carmine and Gram's method. $\times 50$.

been found in the mouth and in the nasal cavity, whilst the bacillus coli communis is a normal inhabitant of the intestinal tract. The entrance of these organisms into the deeper tissues when a surface lesion occurs can be readily understood. Their action will, of course, be favoured by any depressed condition of vitality. Though in normal conditions the blood is bacterium-free, we must suppose that from time to time a certain number of such organisms gain entrance to it from trifling lesions of the skin or mucous surfaces, the possibilities of

entrance from the latter being especially numerous. In most cases they are killed by the action of the healthy serum or cells of the body, and no harm results. If, however, there be a local weakness, they may settle in that part and produce suppuration, and from this other parts of the body may be infected. Such a supposition as this is necessary to explain many inflammatory and suppurative conditions met with clinically. In some cases of multiple suppurations due to staphylococcus infection, which we have had the opportunity to examine, only an ap-

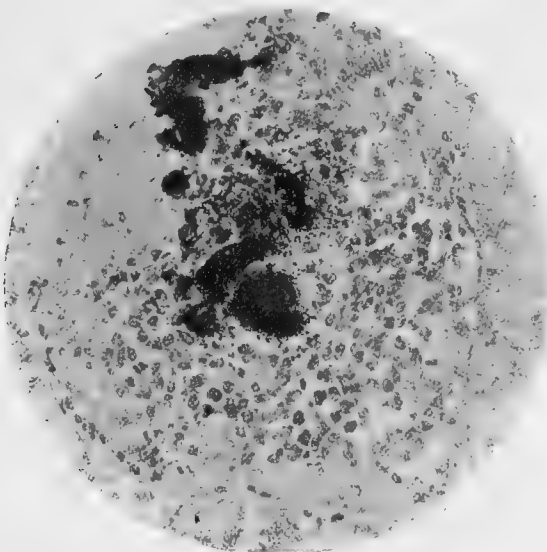

FIG. 74.— Secondary infection of a glomerulus of kidney by the staphylococcus aureus, in a case of ulcerative endocarditis. The cocci (stained darkly) are seen plugging the capillaries and also lying free. The glomerulus is much swollen, infiltrated by leucocytes, and partly necrosed.

Paraffin section; stained by Gram's method and Bismarck-brown. $\times 300$.

parently unimportant surface lesion was present; whilst in others no lesion could be found to explain the origin of the infection. The tonsils may at certain times be the portals of entry for sundry bacteria giving rise to suppurative conditions, or to those of general infection. The term *cryptogenetic* has been applied by some writers to such cases in

which the original point of infection cannot be found, but its use is scarcely necessary.

The paths of secondary infection may be conveniently summarised thus: First, by lymphatics. In this way the lymphatic glands may be infected, and also serous sacs in relation to the organs where the primary lesion exists. Second, by natural channels, such as the ureters and the bile-ducts, the spread being generally associated with an inflammatory condition of the

lining epithelium. In this way the kidneys and liver respectively may be infected. Third, by the blood-vessels: (*a*) by a few organisms gaining entrance to the blood from a local lesion, and settling in a favourable nidus or a damaged tissue, the original path of infection often being obscure; (*b*) by a septic phlebitis with suppurative softening of the thrombus and resulting embolism; and we may add (*c*) by a direct extension along a vein, producing a spreading thrombosis and suppuration within the vein. In this way suppuration may spread along the portal vein to the liver from a lesion in the alimentary canal, the condition being known as pyelo-phlebitis suppurativa.

Although many of the lesions produced by the bacteria under consideration have already been mentioned, certain conditions may be selected for further consideration on account of their clinical importance or bacteriological interest.

Ulcerative Endocarditis. — This condition has been proved to be a bacterial infection of the valves of the heart, and may be produced by various organisms, chiefly pyogenic. Of these the staphylococci and streptococci are most frequently found. In some cases of ulcerative endocarditis following pneumonia, the pneumococcus (Fraenkel's) is present; in others pyogenic cocci, especially streptococci. Other organisms have been cultivated from different cases of the disease, and some of these have received special names; for example, the diplococcus endocarditidis encapsulatus, bacillus endocarditidis griseus (Weichselbaum), micrococcus zymogenes (MacCallum and Hastings), and others. In some cases the bacillus coli communis has been found, and occasionally in endocarditis following typhoid the typhoid bacillus has been described as the organism present, but further observations on this point are desirable. The gonococcus also has been shown to affect the heart valves (p. 230), though this is a very rare occurrence. Tubercle nodules on the heart valves have been found in a few cases of acute tuberculosis, though no vegetative or ulcerative condition is produced.

In some cases, though we believe not often, the organisms may attack healthy valves, producing a *primary* ulcerative endocarditis, but more frequently the valves have been the seat of previous endocarditis, *secondary* ulcerative endocarditis being thus produced. In both conditions the affection of the valves usually occurs in the course of suppurative or inflammatory

conditions elsewhere, *e.g.* in osteomyelitis, in septic inflammations of the urinary passages, in pyæmia and septicæmia, in the course of or following infective fevers, and not very infrequently as a sequel to acute pneumonia. In some cases, especially when the valves have been previously diseased, the source of the infection is quite obscure. It is evident that as the vegetations are composed for the most part of unorganised material, they do not offer the same resistance to the growth of

bacteria, when a few reach them, as a healthy cellular tissue does.

On microscopic examination of the diseased valves the organisms are usually to be found in enormous numbers, sometimes forming an almost continuous layer on the surface, or occurring in large masses or clusters in spaces in the

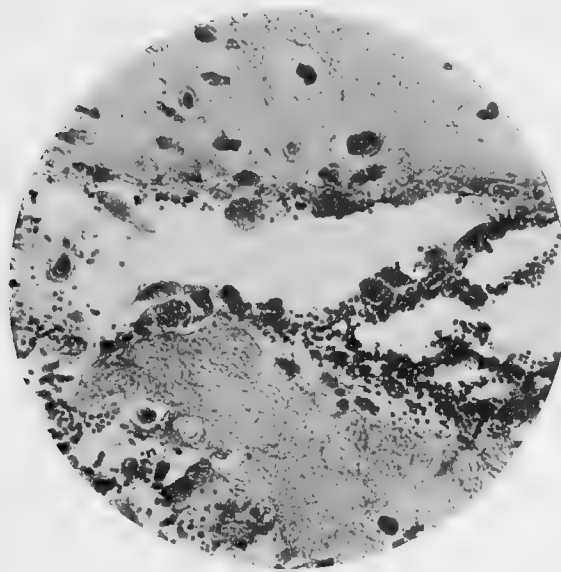

FIG. 75.—Section of a vegetation in ulcerative endocarditis, showing numerous staphylococci lying in the spaces. The lower portion is a fragment in process of separation.

Stained by Gram's method and Bismarck-brown. $\times 600$.

vegetation (Fig. 75). By their action a certain amount of softening or breaking down of the vegetations occurs, and the emboli thus produced act as the carriers of infection to other organs, and give rise to secondary suppurations.

Experimental.—Occasionally ulcerative endocarditis is produced by the simple intravenous injection of staphylococci and streptococci into the circulation, but this is a very rare occurrence. It often follows, however, when the valves have been previously injured. Orth and Wyssokowitsch at a comparatively early date produced the condition by damaging the aortic cusps by a glass rod introduced through the carotid, and afterwards injecting staphylo-

cocci into the circulation. Similar experiments have since been repeated with streptococci, pneumococci, and other organisms, with like result. Ribbert found that if a potato culture of the staphylococcus aureus were rubbed down so as to form an emulsion in salt solution, and then injected into the circulation, some minute fragments became arrested at the attachment of the chordæ tendineæ and produced an ulcerative endocarditis.

Acute Suppurative Periostitis and Osteomyelitis. — Special mention is made of this condition on account of its comparative frequency and gravity. The great majority of cases are caused by the pyogenic cocci, of which one or two varieties may be present, the staphylococcus aureus, however, occurring most frequently. Pneumococci have been found alone in some cases, and in a few cases following typhoid fever, apparently well authenticated, the typhoid bacillus has been found alone. In others again the bacillus coli communis is present.

The affection of the periosteum or interior of the bones by these organisms, which is especially common in young subjects, may take place in the course of other affections produced by these organisms or in the course of infective fevers, but in a great many cases the path of entrance cannot be determined. In the course of this disease serious secondary infections are always very liable to follow, such as small abscesses in the kidneys, heart wall, lungs, liver, etc., suppurations in serous cavities, and ulcerative endocarditis; in fact, some cases present the most typical examples of extreme general staphylococcus infection. The entrance of the organisms into the blood stream from the lesion of the bone is especially favoured by the arrangement of the veins in the bone and marrow.

Experimental. — Multiple abscesses in the bones and under the periosteum may occur in simple intravenous injection of the pyogenic cocci into the blood, and are especially liable to be formed when young animals are used. These abscesses are of small size, and do not spread in the same way as in the natural disease in the human subject.

In experiments on healthy animals, however, the conditions are not analogous to those of the natural disease. We must presume that in the latter there is some local weakness or susceptibility which enables the few organisms which have reached the part by the blood to settle and multiply. Moreover, if a bone be experimentally injured, *e.g.* by actual fracture or by stripping off the periosteum, before the organisms are injected, then a much more extensive suppuration occurs at the injured part.

Erysipelas. — A spreading inflammatory condition of the skin may be produced by a variety of organisms, but the disease

in the human subject in its characteristic form is almost invariably due to a streptococcus, as was shown by Fehleisen in 1884. He obtained pure cultures of the organism, and gave it the name of streptococcus erysipelatis; and, further, by inoculations on the human subject as a therapeutic measure in malignant disease, he was able to reproduce erysipelas. As stated above, however, one after another of the supposed points of difference between the streptococcus of erysipelas and that of suppuration has broken down, and it is now generally held that erysipelas is produced by the streptococcus pyogenes of a certain degree of virulence. It must be noted, however, that erysipelas passes from patient to patient as erysipelas, and purulent conditions due to streptococci do not appear liable to be followed by erysipelas. On the other hand, the connection between erysipelas and puerperal septicæmia is well established clinically.

In a case of erysipelas the streptococci are found in large numbers in the lymphatics of the cutis and underlying tissues, just beyond the swollen margin of the inflammatory area. As the inflammation advances they gradually die out, and after a time their extension at the periphery comes to an end. The streptococci may extend to serous and synovial cavities and set up inflammatory or suppurative change,—peritonitis, meningitis, and synovitis may thus be produced.

Meningitis.—Although almost any of the above-mentioned pyogenic organisms may be concerned in the causation of meningitis, some general statements may be made regarding it. A considerable number of cases of meningitis, especially in children, are due to the pneumococcus. In many instances where no other lesions are present the extension is by the Eustachian tube to the middle ear and thence to the brain; in other cases the path of infection is by means of the blood stream, usually from some inflammatory lesion in the lungs. Meningitis is not infrequently produced by a streptococcus, especially when middle ear disease is present, less frequently by one of the staphylococci. Occasionally more than one organism may be concerned. In meningitis following influenza, the influenza bacillus has been found in a few cases, and in tubercular meningitis the tubercle bacillus of course is present, especially in the nodules along the sheaths of the vessels. The pneumobacillus and *B. typhosus* also have been found in a few cases of meningitis.

In a number of the earlier cases of *epidemic cerebro-spinal meningitis* the pneumococcus was described as the organism present, but later observations made in different parts of the world show that the organism usually concerned is undoubtedly the diplococcus *intracellularis meningitidis*. In acute cases, and especially in the earlier stages, it is usually present in large numbers, but in the more chronic it occurs sparsely, and its presence may be demonstrated only with difficulty. The organism can usually be obtained by means of lumbar puncture. Certain sporadic cases of meningitis are also due to this organism, and it is extremely probable that the diplococcus of simple basal meningitis in children described by Still is merely a modification of this meningococcus.

Conjunctivitis.—A considerable number of organisms are concerned in the production of conjunctivitis and its associated lesions. Of these a number appear to be specially associated with this region. Thus a small organism, generally known as the Koch-Weeks bacillus, is the most common cause of acute contagious conjunctivitis, especially prevalent in Egypt, but also having a very wide distribution. This organism morphologically resembles the influenza bacillus, and its conditions of growth are even more restricted, as it rarely grows on blood agar, the best medium being serum agar. Another organism exceedingly like the previous, apparently differing from it only in the rather wider conditions of growth, is Muller's bacillus. It has been cultivated by him in a considerable proportion of cases of trachoma, but its relation to this condition is still a matter of dispute. Another bacillus which is now well recognised is the diplo-bacillus of conjunctivitis first described by Morax. It is especially common in the more subacute cases of conjunctivitis. Eyre found it in 2.5 per cent of all cases of conjunctivitis. Its cultural characters are given below. The xerosis bacillus (Chap. XVI.) has been found in xerosis of the conjunctiva, in follicular conjunctivitis, and in other conditions; it appears to occur sometimes also in the normal conjunctiva. Acute conjunctivitis is also produced by the pneumococcus, epidemics of the disease being sometimes due to this organism, and also by streptococci and staphylococci. True diphtheria of the conjunctiva caused by the Klebs-Löffler bacillus also occurs, whilst in gonorrhœal conjunctivitis, often of an acute purulent type, the gonococcus is present.

Diplo-bacillus of Conjunctivitis.— This organism, discovered by Morax, is a small plump bacillus, measuring $1 \times 2 \mu$, and usually occurring in pairs (Fig. 76). It is non-motile, does not form spores, and is decolorised by Gram's method. It does not grow on the ordinary gelatin and agar media, the addition of blood or serum being necessary. On serum it forms small rounded colonies which produce small pits of liquefaction; hence it is sometimes called the *bacillus lacunatus*. In cultures it is distinctly pleomorphous, and involution forms also occur. It is non-pathogenic to the lower animals.

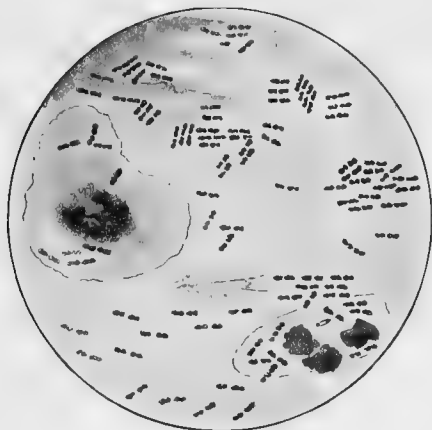

FIG. 76.— Film preparation of conjunctival secretion showing the diplo-bacillus of conjunctivitis.¹ $\times 1000$.

Acute Rheumatism.— There are many facts which seem to indicate the infective nature of this disease, and investigations from

this point of view have yielded results of which mention may here be made. A number of organisms have been cultivated from the affected tissues by different observers, and have been supposed to have a special relation to the disease.

Achalme, Thiroloix, Bettencourt, and others of the French school describe the occurrence of an anaerobic bacillus, similar in appearance to *B. anthracis*, in many cases of acute rheumatism, which they claim bears an etiological relationship to the disease. Hewlett, in England, in the only case he examined, isolated a bacillus similar in characteristics to that of Achalme. And in America, Gwyn, from a case of chorea rheumatica, isolated an anaerobic bacillus from blood cultures during life, which he identified as *B. aerogenes capsulatus*, and which corresponded to Achalme's description of his bacillus; neither Hewlett nor Gwyn were certain in what relationships their organisms stood to the disease. Foullerton and Rist declare that Achalme's bacillus is identical to Klein's *Bac. enteritidis sporogenes* (which in turn is the same as that first described by Welch in America as *Bac. aerogenes capsulatus*), and has no bearing upon the cause of acute rheumatism. But the organism

¹ We are indebted to Dr. J. W. Eyre for the use of this figure.

which appears to have strongest claims is a small diplococcus observed by Triboulet, Westphal and Wassermann, Meyer, and Allaria, the characters and action of which have been investigated especially by Poynton and Paine. These latter observers found this organism in eight successive cases of acute rheumatism, and obtained pure cultures both from the blood during life and also from some of the lesions after death; they also found it, on microscopic examination, in all the important lesions of the disease. The organism is a minute coccus about $.5 \mu$ in diameter; in the tissues it usually occurs in pairs, in fluid cultures it forms short chains, whilst on solid media it is irregularly arranged in masses. It stains readily with the ordinary basic dyes, but loses the stain in Gram's method. For isolation the best medium was found to be a mixture of bouillon and milk, rendered slightly acid by lactic acid; from growths on this medium sub-cultures may be made on blood agar, on which the organism produces small circular, yellowish-white colonies, showing under a low magnification a slightly granular appearance. On intravenous injection of pure cultures in rabbits they found as results, polyarthritis and synovitis, valvulitis and pericarditis—without any suppurative change; along with these there were also marked symptoms referable to the lesions of the heart, joints, etc. These results are of a definite nature, and it remains to be seen to what extent they receive confirmation at the hands of other observers, especially when the experimental inquiries are made with animals naturally susceptible to disorders resembling human rheumatism.

Singer, as a result of a study of five fatal cases of acute rheumatism and two of chorea rheumatica, isolated a streptococcus in pure culture from five cases; streptococcus and staphylococcus aureus, in association, from two cases; and staphylococcus aureus, alone, from one case; and sections of the various tissues and of the cardiac vegetations upon staining showed streptococci and diplococci in more or less abundance. He believes that there should not be any claim allowed for specificity, such as Wassermann, and Poynton and Paine hold for their micrococci, but is of the opinion that acute rheumatism is only one of the many expressions of the variable activities of the ordinary pyogenic cocci. Menzer also inclines to Singer's views, as a result of a study of two cases of acute rheumatism,

wherein he isolated a streptococcus which he regarded simply as streptococcus pyogenes.

Methods of Examination in Inflammatory and Suppurative Conditions.— These are usually of a comparatively simple nature, and include (1) microscopic examination, (2) the making of cultures.

(1) The pus or other fluids should be examined microscopically, first of all by means of film preparations in order to determine the characters of the organisms present. The films should be stained (*a*) by one of the ordinary solutions, such as carbolfuchsin-blue (p. 101), or a saturated watery solution of methylene-blue; and (*b*) by Gram's method. The use of the latter is of course of high importance as an aid in the recognition.

(2) As most of the pyogenic organisms grow readily on the agar media at 37° C., pure cultures can be more rapidly obtained by plating in the ordinary way than by using gelatin. When the presence of either pneumococci or streptococci is suspected, this method ought always to be used, sub-cultures preferably at first being made in milk. Inoculation experiments may be carried out as occasion arises.

In cases of suspected blood infection the examination of the blood is to be carried out by the methods already described (p. 72).

CHAPTER VIII.

INFLAMMATORY AND SUPPURATIVE CONDITIONS, *CONTINUED*: THE ACUTE PNEUMONIAS.

Introductory.— The term Pneumonia is applied to several conditions which present differences in pathological anatomy and in origin. All of these, however, must be looked on as varieties of inflammation in which the process is modified in different ways, depending on the special structure of the lung or of the parts which compose it. There is, first of all, and, in adults, the commonest type, the acute croupous or lobar pneumonia, in which an inflammatory process attended by abundant fibrinous exudation affects, by continuity, the entire tissue of a lobe or of a large portion of the lung. It departs from the course of an ordinary inflammation in that the reaction of the connective tissue of the lung is relatively slight, and there is usually no tendency for organisation of the inflammatory exudation to take place. Secondly, there is the acute catarrhal or lobular pneumonia, where a catarrhal inflammatory process spreads from the capillary bronchi to the air vesicles, and in these a change, consisting largely of proliferation of the endothelium of the alveoli, takes place which leads to consolidation of patches of the lung tissue. Up till 1889 acute catarrhal pneumonia was comparatively rare except in children. In adults it was chiefly found as a secondary complication to some condition such as diphtheria, typhoid fever, etc. Since the recent epidemics of influenza, however, it has been of much more frequent occurrence in adults, has assumed a very fatal tendency, and has presented the formerly quite unusual feature of being sometimes the precursor of gangrene of the lung. Besides these two definite types other forms also occur. Thus instead of a fibrinous material the exudation may be of a serous or hæmorrhagic or of a purulent character. Cases of mixed fibrinous and catarrhal pneumonia also occur, and in the

catarrhal there may be great leucocytic emigration. Hæmorrhages also may occur here.

Besides the two chief types of pneumonia there is another group of cases which are somewhat loosely denominated septic pneumonias, and which may arise in two ways: (1) by the entrance into the trachea and bronchi of discharges, blood, etc., which form a nidus for the growth of septic organisms; these often set up a purulent capillary bronchitis and lead to infection of the air cells and also of the interstitial tissue of the lung; (2) from secondary pyogenic infection by means of the blood stream from suppurative foci in other parts of the body. (See Chapter VII., pp. 195 *et seq.*) In these septic pneumonias various changes, resembling those found in the other types, are often seen round the septic foci.

In pneumonias, therefore, there may be present a great variety of types of inflammatory reaction. We shall see that with all of them bacteria have been found associated. Special importance is attached to acute croupous pneumonia on account of its course and characters, but reference will also be made to the other forms.

Historical. — Acute lobar pneumonia for long was supposed to be an effect of exposure to cold; but many observers were dissatisfied with this view of its etiology. Not only did cases occur where no such exposure could be traced, but it had been observed that the disease sometimes occurred epidemically, and was occasionally contracted by hospital patients lying in beds adjacent to those occupied by pneumonia cases. Further, the sudden onset and definite course of the disease conformed to the type of an acute infective fever; it was thus suspected by some to be due to a specific infection. This view of its etiology was promulgated by Friedländer, whose results (published in 1882–83) were briefly as follows. In pneumonic lungs there were cocci, adherent usually in pairs, and possessed of a definitely contoured capsule. These cocci could be isolated and grown on gelatin, and on inoculation in mice they produced a kind of septicæmia with inflammation of the serous membranes. The blood and the exudation in serous cavities contained numerous capsulated diplococci. Various criticisms of Friedländer's views soon appeared, the chief being that pneumonia was not produced by him in animals, and there is little doubt that many of the organisms seen by Friedländer were really Fraenkel's pneumococcus, to be presently described.

By many observers it had been found that the sputum of healthy men, when injected into animals, sometimes caused death, with the same symptoms as in the case of the injection of Friedländer's coccus; and in the blood and serous exudations of such animals capsulated diplococci were found. In fact, it was thus first discovered by G. M. Sternberg of Washington, in September,

1880, and by Pasteur, in December of the same year. A. Fraenkel found that the sputum of pneumonic patients was much more fatal and more constant in its effects than that of healthy individuals. The cocci which were found in animals dead of this "sputum septicæmia," as it was called, differed from Friedländer's cocci in several respects to be presently studied. Fraenkel further investigated a few cases of pneumonia, and isolated from them cocci identical in microscopic appearances, cultures, and pathogenic effects, with those isolated in sputum septicæmia. The most extensive investigations on the whole question were those of Weichselbaum, published in 1886. This author examined 129 cases of the disease, and included in his survey not only acute croupous pneumonia, but lobular and septic pneumonias. From them he isolated four groups of organisms. (1) *Diplococcus pneumoniae*. This he described as an oval or lancet-formed coccus, corresponding in appearance and growth characters to Fraenkel's coccus. (2) *Streptococcus pneumoniae*. This on the whole presented similar characters to the last but it was more vigorous in its growth, and could grow below 20° C., though it preferred a temperature of 37° C. (3) *Staphylococcus pyogenes aureus*. (4) *Bacillus pneumoniae*. This was a short, rod-shaped organism, which in Weichselbaum's opinion was identical with Friedländer's pneumococcus. Of these organisms the diplococcus pneumoniae was by far the most frequent. It also occurred in all forms of pneumonia. Next in frequency was the streptococcus pneumoniae, and lastly the bacillus pneumoniae. Inoculation experiments were also performed by Weichselbaum with each of the three characteristic cocci he isolated. The diplococcus pneumoniae and the streptococcus pneumoniae both gave pathogenic effects of a similar kind in certain animals.

The general result of these earlier observations was to establish the occurrence in connection with pneumonia of two species of organisms, each having its distinctive characters, viz. :—

1. *Fraenkel's pneumococcus*, which is recognised to be identical with the coccus of "sputum septicæmia," with Weichselbaum's diplococcus pneumoniae, and probably also with his streptococcus pneumoniae.

2. *Friedländer's pneumococcus* (now known as Friedländer's pneumobacillus), which is almost certainly the same as the bacillus pneumoniae of Weichselbaum.

We shall use the terms "Fraenkel's pneumococcus" and "Friedländer's pneumobacillus," as these are now usually applied to the two organisms.

Microscopic Characters of the Bacteria of Pneumonia.—*Methods.*—The organisms present in acute pneumonia can best be examined in film preparations made from pneumonic lung (preferably from a part in a stage of acute congestion or early hepatisation), or from the gelatinous parts of pneumonic sputum,

(here again preferably when such sputum is either rusty or occurs early in the disease), or in sections of pneumonic lung. Such preparations may be stained by any of the ordinary weak

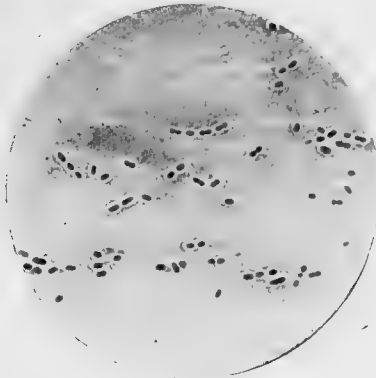

FIG. 77. — Film preparation of pneumonic sputum, showing numerous pneumococci (Frænkel's) with unstained capsules; some are arranged in short chains. Stained with carbol-fuchsin. $\times 1000$.

stains, such as a watery solution of methylene-blue, but Gram's method is to be preferred, with safranin or Bismarck-brown as a contrast stain. Ziehl-Neelsen carbol-fuchsin is also very suitable; it is best either to stain with it for only a few seconds, or to overstain and then decolorise with alcohol till the ground of the preparation is just tinted. The capsules can be stained by the methods already described (p. 106). In such preparations as the above,

and even in specimens taken from the lungs immediately after death (as may be quite well done by means of a hypodermic syringe), putrefactive and other bacteria may be present, but those to be looked for are capsulated organisms, which may be of either or both of the varieties mentioned.

(1) *Frænkel's Pneumococcus*. — This organism occurs in the form of a small oval coccus, about $1\ \mu$ in longest diameter, arranged generally in pairs (diplococci), but also in chains of four to ten (Fig. 77). The free ends are often pointed like a lancet, hence the term *diplococcus lancetatus* has also been applied to it. These cocci have round them a capsule, which, in films stained by ordinary methods, usually appears as an unstained halo, but is sometimes stained more deeply than the ground of the preparation. This difference in staining depends, in part at least, on the amount of decolorisation to which the preparation has been subjected. The capsule is rather broader than the body of the coccus, and has a sharply defined external margin. This organism takes up the basic aniline stains with great readiness and also *retains the stain in Gram's method*. It is the organism of by far the most frequent occurrence in true croupous pneumonia, and in fact may be said to be rarely absent.

(2) *Friedländer's Pneumobacillus*. — As seen in the sputum and tissues, this organism both in its appearance and arrangement, as also in the presence of a capsule, somewhat resembles Fraenkel's pneumococcus, and it was at first described as the "pneumococcus." The form, however, is more of a short rod shape, and it has blunt, rounded ends; it is also rather broader than Fraenkel's pneumococcus. It is now usually classed amongst the bacilli, especially in view of the fact that in cultures elongated rod forms may occur (Fig. 78). The capsule has the same general characters as that of Fraenkel's organism. Friedländer's pneumobacillus stains readily with the basic aniline stains, but *loses the stain in Gram's method*, and is, accordingly, coloured with the contrast stain, —

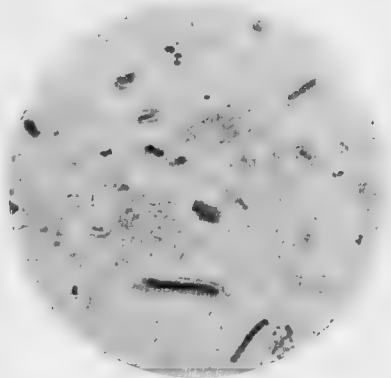

FIG. 78. — Friedländer's pneumobacillus, showing the variations in length, also capsules. Film preparation from exudate in a case of pneumonia. $\times 1000$.

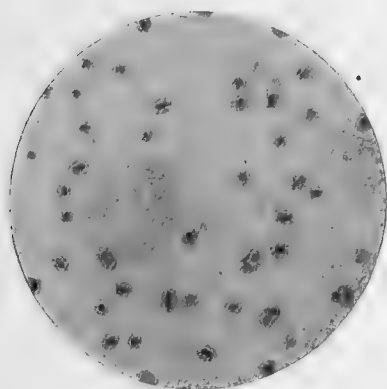

FIG. 79. — Fraenkel's pneumococcus in serous exudation at site of inoculation in a rabbit, showing capsules. Stained by Rd. Muir's method. $\times 1000$.

safranin or Bismarck-brown, as above recommended. A valuable means is thus afforded of distinguishing it from Fraenkel's pneumococcus in microscopic preparations.

Friedländer's organism is much less frequently present in pneumonia than Fraenkel's; sometimes it is associated with the latter, very rarely it occurs alone.

In sputum preparations the capsule of both pneumococci may not be recognisable, and the same is sometimes true of lung preparations. This is probably due to changes which occur in the capsule as the result of changes in the vitality of the organisms. Sometimes

in preparations stained by ordinary methods the difficulty of recognising the capsule when it is present is due to the refractive index of the fluid in which the specimen is mounted being almost identical with that of the capsule. This difficulty can always be overcome by having the groundwork of the preparation tinted.

The Cultivation of Fraenkel's Pneumococcus. — It is usually difficult, and sometimes impossible, to isolate this coccus directly from pneumonic sputum. On culture media it has not a vigorous growth, and when mixed with other bacteria it is apt to be overgrown by the latter. To get a pure culture it is best to insert a small piece of the sputum beneath the skin of a rabbit or a mouse. In about forty-eight hours the animal will die, with numerous capsulated pneumococci throughout its blood. From the heart blood, cultures can be easily obtained. Cultures can also be got *post mortem* from the lungs of pneumonic patients by streaking a number of agar or blood-agar tubes with a scraping taken from the area of acute congestion or commencing red hepatisation, and incubating them at 37° C. The colonies of the pneumococcus appear as almost transparent small discs which have been compared to drops of dew (Fig. 80). This method is also sometimes successful in the case of sputum.

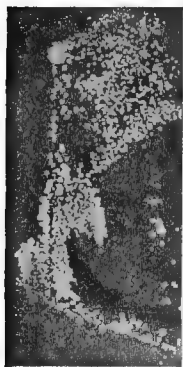

FIG. 80. — Stroke-culture of Fraenkel's pneumococcus on blood agar. The colonies are unusually large and distinct. Twenty-four hours' growth at 37° C. Natural size.

The appearances presented in cultures by different varieties of the pneumococcus vary somewhat. It always grows best on blood serum on Pfeiffer's blood agar or in milk. It usually grows well on ordinary agar or in bouillon, but not so well on glycerin agar. In a stroke culture on *blood serum* growth appears as an almost transparent pellicle along the track, with isolated colonies at the margin. On *agar* media it is more manifest, but otherwise has similar characters. The appearances are similar to those of a culture of streptococcus pyogenes, but the growth is less vigorous, and is more delicate in appearance. A similar statement also applies to cultures in *gelatin* at 22° C., growth in a stab-culture appearing as a row of minute points which remain of small size; there is, of course, no

liquefaction of the medium. On agar plates colonies are almost invisible to the naked eye, but under a low power of the microscope appear to have a compact finely granular centre and a pale transparent periphery. In *bouillon*, growth forms a slight turbidity, which settles to the bottom of the vessel as a slight dust-like deposit. On *potatoes*, as a rule, no growth appears. Cultures on such media may be maintained for one or two months, if fresh sub-cultures are made every four or five days, but they tend ultimately to die out. They also rapidly lose their virulence, so that four or five days after isolation from an animal's body their pathogenic action is already diminished. Eyre and Washbourn, however, have succeeded in maintaining cultures in a condition of constant virulence for at least three months by growing the organisms on agar smeared with rabbits' blood. The agar must be prepared with Witte's peptone, must not be heated over 100° C., and after neutralisation (rosolic acid being used as the indicator) must have .5 per cent of normal sodium hydrate added. The tubes when inoculated are to be kept at 37.5° C. and sealed to prevent evaporation. In none of the ordinary artificial media do pneumococci develop a capsule, but in milk cultures capsules are usually to be demonstrated. They usually appear as diplococci, but in preparations made from the surface of agar or from bouillon, shorter or longer chains may be observed (Fig. 81). After a few days' growth they lose their regular shape and size, and involution forms appear. Usually the pneumococcus does not grow below 22° C., but forms in which the virulence has disappeared often grow well at 20° C. Its optimum temperature is 37° C., its maximum 42° C. It is preferably an aerobe, but can exist without oxygen. It prefers a slightly alkaline medium to a neutral, and does not grow on an acid medium. These facts show that when growing outside the body on artificial media, the pneumococcus is a comparatively



FIG. 81. — Fraenkel's pneumococcus from a pure culture on blood agar of twenty-four hours' growth, some in pairs, some in short chains. Stained with weak carbol-fuchsin. $\times 1000$.

delicate organism. There has been described by Eyre and Washbourn a non-pathogenic type of the pneumococcus which may be found in the healthy mouth, and which may also be produced during the saprophytic growth of the virulent form. From the latter it differs generally in its more vigorous growth, in producing a uniform cloud in bouillon, in slowly liquefying gelatin, and in growing on potato.



FIG. 82. — Stab-culture of Friedländer's pneumobacillus in peptone gelatin, showing the nail-like appearance; ten days' growth. Natural size.

the whole resembles a white round-headed nail driven into the gelatin (Fig. 82). Hence the name "nail-like" which has been applied. Occasionally bubbles of gas develop along the line of growth. There is no liquefaction of the medium. On sloped *agar* it forms a very white growth with a shiny lustre, which, when touched with a

The Cultivation of Friedländer's Pneumobacillus. — This organism, when present in sputum or in a pneumonic lung, can be readily separated by making ordinary gelatin plate-cultures, or a series of successive strokes on agar tubes. The surface colonies always appear as white discs, which become raised from the surface so as to appear like little knobs of ivory. From these, pure cultures can be readily obtained. The appearance of a stab-culture in gelatin growth is very characteristic. At the site of the puncture there is on the surface a white growth heaped up, it may be fully one-eighth of an inch above the level of the gelatin; along the needle track there is a white granular appearance, so that



FIG. 83. — Friedländer's pneumobacillus,¹ from a young culture on agar; showing some rod-shaped forms. Stained with thionin-blue. $\times 1000$.

¹ The apparent size of this organism, on account of the nature of its sheath, varies much according to the stain used. If stained with a strong stain, e.g. carbol-fuchsin, its thickness appears nearly twice as great as is shown in the figure.

platinum needle, is found to be of a viscous consistence. In cultures much longer rods are formed than in the tissues of the body (Fig. 83). On the surface of *potatoes* it forms an abundant moist white layer, in which it is usual to find many small gas-bubbles. Friedländer's bacillus has active fermenting powers on sugars, though varieties isolated by different observers vary in the degree in which such powers are possessed. It always seems capable of acting on dextrose, lactose, maltose, dextrin, and mannite, and sometimes also on glycerin. The substances produced by the fermentation vary with the sugar fermented, but include ethylic alcohol, acetic acid, lævolactic acid, succinic acid, along with hydrogen and carbonic acid gas. The amount of acid produced from lactose seems only exceptionally sufficient to cause coagulation of milk. It is said that this bacillus is identical with an organism common in sour milk, and also a normal inhabitant of the human intestine, viz., the bacterium *lactis aerogenes* of Escherich. This latter bacillus, however, is non-pathogenic and always acidifies and coagulates milk within 24-48 hours, with more or less active formation of gas.

The Occurrence of the Pneumobacteria in Pneumonia and other Conditions.—Capsulated organisms have been found in every variety of the disease—in acute croupous pneumonia, in bronchopneumonia, in septic pneumonia. In the great majority of these it is Fraenkel's pneumococcus which, both microscopically and culturally, has been found to be present. Friedländer's pneumobacillus occurs in only about 5 per cent of the cases. It may be present alone or associated with Fraenkel's organism. In a case of croupous pneumonia the pneumococci are found all through the affected area in the lung, especially in the exudation in the air-cells. They also occur in the pleural exudation and effusion, and in the lymphatics of the lung. The greatest number are found in the parts where the inflammatory process is most recent, *e.g.* in an area of acute congestion in a case of croupous pneumonia, and therefore such parts are preferably to be selected for microscopic examination, and as the source of cultures. Sometimes there occur in pneumonic consolidation areas of suppurative softening, which may spread diffusely. In such areas the pneumococci occur with or without ordinary pyogenic organisms, streptococci being the commonest concomitants. In other cases, especially when the condition is secondary to influenza, gangrene

may supervene and lead to destruction of large portions of the lung. In these a great variety of bacteria, both aerobes and anaerobes, are to be found.

In ordinary broncho-pneumonias also, Fraenkel's pneumococcus is usually present, sometimes along with pyogenic cocci; in the broncho-pneumonias secondary to diphtheria it may be accompanied by the diphtheria bacillus, and also by pyogenic cocci; in typhoid pneumonias the typhoid bacillus or the *B. coli* may be alone present or be accompanied by the pneumococcus, and in influenza pneumonias the influenza bacillus may occur. In septic pneumonias the pyogenic cocci in many cases are the only organisms discoverable, but the pneumococcus may also be present. Especially important, as we shall see, from the point of view of the etiology of the disease, is the occurrence in other parts of the body of pathological conditions associated with the presence of the pneumococcus. By direct extension to neighbouring parts empyema, pericarditis, and lymphatic enlargements in the mediastinum and neck may take place; in the first the pneumococcus may occur either alone or with pyogenic cocci. But distant parts may be affected, for from the blood stream both in the early and later stages of pneumonia, pneumococci have been isolated by Prochaska and Cole, thus explaining why the pneumococcus may be found in suppurations and inflammations in various parts of the body (subcutaneous tissue, peritoneum, joints, kidneys, liver, etc.), in otitis media, ulcerative endocarditis (p. 197), and meningitis. These conditions may take place either as complications of pneumonia, or they may constitute the primary disease. The occurrence of meningitis is of special importance, for next to the lungs the meninges appear to be the parts most liable to attack by the pneumococcus. A large number of cases have been investigated by Netter, who gives the following tables of the relative frequency of the primary infections by the pneumococcus in man:—

(1) In adults—

Pneumonia . . .	65.95 per cent	Empyema . . .	8.53 per cent
Broncho-pneumonia } Capillary bronchitis }	15.85 ”	Otitis . . .	2.44 ”
Meningitis . . .	13.00 ”	Endocarditis . . .	1.22 ”
		Liver abscess . . .	1.22 ”

(2) In children 46 cases were investigated. In 29 the primary affection was otitis media, in 12 broncho-pneumonia, in 2 meningitis, in 1 pneumonia, in 1 pleurisy, in 1 pericarditis.

Thus in children the primary source of infection is in a great many cases an otitis media, and Netter concludes that infection takes place in such conditions from the nasal cavities.

Experimental Inoculation.— The *pneumococcus* of Fraenkel is pathogenic to various animals, though the effects vary somewhat with the virulence of the race used. The susceptibility of different species, as Gamaléia has shown, varies to a considerable extent. The rabbit, and especially the mouse, are very susceptible; the guinea-pig, the rat, the dog, and the sheep occupy an intermediate position; the pigeon is immune. In the more susceptible animals the general type of the disease produced is not pneumonia, but a general *septicæmia*. Thus, if a rabbit or a mouse be injected simultaneously with

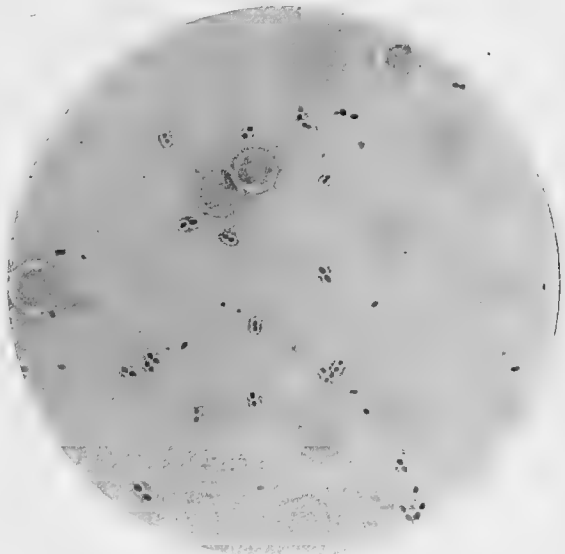

FIG. 84.— Capsulated pneumococci in blood taken from the heart of a rabbit, dead after inoculation with pneumonic sputum. Dried film, fixed with corrosive sublimate. Stained with carbol-fuchsin and partly decolorised. $\times 1000$.

pneumonic sputum, or with a scraping from a pneumonic lung, death occurs in from twenty-four to forty-eight hours. There is some fibrinous infiltration at the point of inoculation, the spleen is often enlarged and firm, and the blood contains capsulated pneumococci in large numbers (Fig. 84). If the seat of inoculation be in the lung, there generally results pleuritic effusion on both sides, and in the lung there may be a process somewhat resembling the early stage of acute croupous pneumonia in man. There are often also pericarditis and enlargement of spleen. We have already stated that cultures of the pneumococci on artificial media in a few days begin to lose their virulence.

Now, if such a partly attenuated culture be injected subcutaneously into a rabbit, there is greater local reaction; pneumonia, with exudation of lymph on the surface of the pleura, and a similar condition in the peritoneum, may occur. In sheep greater immunity is marked by the occurrence, after subcutaneous inoculation, of an enormous local sero-fibrinous exudation, and by the fact that few pneumococci are found in the blood stream. Intrapulmonary injection in sheep is followed by a typical pneumonia, which is generally fatal. The dog is still more immune; in it also intrapulmonary injection is followed by a fibrinous pneumonia, which is only sometimes fatal. Inoculation by inhalation appears only to have been performed in the susceptible mouse and rabbit; here also septicæmia resulted.

The general conclusion to be drawn from these experiments thus is that in highly susceptible animals virulent pneumococci produce a general septicæmia; whereas in more immune species there is an acute local reaction at the point of inoculation, and if the latter be in the lung, then there may result pneumonia, which, of course, is merely a local acute inflammation occurring in a special tissue, but identical in essential pathology with an inflammatory reaction in any other part of the body. When a dose of pneumococci sufficient to kill a rabbit is injected subcutaneously in the human subject, it gives rise to a local inflammatory swelling with redness and slight rise of temperature, all of which pass off in a few days. It is therefore justifiable to suppose that man occupies an intermediate place in the scale of susceptibility, probably between the dog and the sheep, and that when the pneumococcus gains an entrance to his lungs, the local reaction in the form of pneumonia occurs.

Analogies to the facts just stated are afforded in the case of other diseases caused by bacteria. Thus, for example, the anthrax bacillus produces in the human subject more marked inflammatory reaction, and is more restricted to the local lesions, than in the much more susceptible guinea-pig, in which it produces a rapidly fatal septicæmia. An analogous result is also obtained when, instead of taking animals of different susceptibility, the same species of animal is used, but the virulence of the organism is altered; for example, a streptococcus, as already stated, producing at one time an erysipelatous condition, causes an acute septicæmia when its virulence is increased.

The occurrence in the lung of inflammatory conditions due to other causes does not make it less likely that the great majority of cases of acute pneumonia which occur under natural conditions have as the causal agent the pneumococcus. For in the latter we have an organism with certain very definite microscopic and biological characters, which is certainly present in the great majority of, if not in all, cases of the disease. Its action as a producer of general septicæmia in animals, we have seen, finds a perfectly rational explanation in the different degrees of susceptibility which exist towards it in different species. In this connection the occurrence of manifestations of general infection associated with pneumonia in man is of the highest importance. We have seen that meningitis and other inflammations are not very rare complications of the disease, and such cases form a link connecting the local disease in the human subject with the general septicæmic processes which may be produced artificially in the more susceptible representatives of the lower animals.

A fact which has, in the minds of some, rather militated against the pneumococcus being the cause of pneumonia, is the discovery of this organism in the saliva of healthy men. This fact was early pointed out by Pasteur, Sternberg, and also by Fraenkel, and their observations have been confirmed by many other observers. It can certainly be isolated from the mouths of a considerable proportion of normal men, from their nasal cavities, etc., being probably in any particular individual more numerous at some times than at others, and sometimes being entirely absent. This can be proved, of course, by inoculation of susceptible animals. Such a fact, however, does not necessarily imply that the pneumococcus is not the cause of pneumonia. It only indicates the importance of predisposing causes in the etiology of the disease, and it is further to be observed that we have corresponding facts in the case of the diseases caused by pyogenic staphylococci, streptococci, the bacillus coli, etc. It is probable that by various causes the vitality and power of resistance of the lung are diminished, and that then the pneumococcus gains an entrance. In relation to this possibility we have the very striking facts that in the irregular forms of pneumonia, secondary to such conditions as typhoid and diphtheria, the pneumococcus is very frequently present, alone or with

other organisms. Apparently the effects produced by such bacteria as the *B. typhosus* and the *B. diphtheriæ* can devitalize the lung to such an extent that secondary infection by the pneumococcus is more likely to occur and set up pneumonia. We can therefore understand how much less definite devitalising agents such as cold, alcoholic excess, etc., can play an important part in the causation of pneumonia. In this way also other abnormal conditions of the respiratory tract, a slight bronchitis, etc., may play a similar part.

It is more difficult to explain why sometimes the pneumococcus is associated with a spreading inflammation, as in croupous pneumonia, whilst at other times it is localised to the catarrhal patches in broncho-pneumonia. It is quite likely that in the former condition the organism is possessed of a different order of virulence, though of this we have no direct proof. We have, however, a closely analogous fact in the case of erysipelas, which, we have stated reasons for believing, is produced by a streptococcus which, when less virulent, causes only local inflammatory and suppurative conditions.

Summary. — We may accordingly summarise the facts regarding the relation of Fraenkel's pneumococcus to the disease by saying that it can be isolated from nearly all cases of acute croupous pneumonia, and also from a considerable proportion of other forms of pneumonia. When injected into the lungs of moderately insusceptible animals it gives rise to pneumonia. If, in default of the crucial experiment of intrapulmonary injection in the human subject, we take into account the facts we have discussed, we are justified in holding that it is the chief factor in causing croupous pneumonia, and also plays an important part in other forms. Pneumonia, in the widest sense of the term, is, however, not a specific affection, and various inflammatory conditions in the lungs can be set up by the different pyogenic organisms, by the bacilli of diphtheria, of influenza, etc.

The possibility of Friedländer's *pneumobacillus* having an etiological relationship to pneumonia has been much disputed. Its discoverer found that it was pathogenic towards mice and guinea-pigs, and to a less extent towards dogs. Rabbits appeared to be immune. The type of the disease was of the nature of a septicæmia. No extended experiments, such as those performed by Gamaléia with Fraenkel's coccus, have been done, and there-

fore we cannot say whether any similar pneumonic effects are produced by it in partly susceptible animals. The organism appears to be present alone in a small number of cases of pneumonia, and the fact that it also appears to have been the only organism present in certain septicæmic complications of pneumonia, such as empyema and meningitis, render it possible that it may be the causal agent in a few cases of the disease.

In the septic pneumonias the different pyogenic organisms already described are found, and sometimes in ordinary pneumonias, especially the catarrhal forms, other organisms, such as the *B. coli* or its congeners, may be the causal agent.

The Toxins of Fraenkel's Pneumococcus. — Pneumonia in its commonest types is a disease which presents in many respects the characters of an acute poisoning. In very few cases does death take place from the functions of the lungs being interfered with to such an extent as to cause asphyxia. It is from cardiac failure, from grave interference with the heat-regulating mechanism, and from a general nervous depression that death usually results. These considerations, taken in connection with the fact that in man the pneumococci are usually confined to the lung, suggest that they may produce their general effects by means of toxins. The subject has been investigated by Emerich and Fowitsky and by G. and F. Klemperer. The latter isolated from recent bouillon cultures, by the methods of Brieger and Fraenkel (p. 172), bodies having the reactions of the toxalbumins obtained in the case of other bacteria. When injected, these toxalbumins (which they called "pneumotoxin") produced symptoms in rabbits, and when they were derived not from bouillon cultures but from the blood of animals dead of the disease, they could produce fatal effects. This work was done before media had been devised on which the pneumococcus can live for a number of weeks, and therefore only the toxins resulting from a few days' growth were used. Of the nature of the poisons which were obtained we know nothing. Carnot describes a toxin which, when introduced into an animal's lung, gave rise to pneumonic conditions, and also secondarily produced changes in the heart and symptoms of cardiac affection similar to those occurring during the disease in the human subject.

Immunisation against the Pneumococcus. — Animals can be immunised against the pneumococcus either by inoculation with

attenuated cultures or by the injection of toxic bodies derived from cultures. The former can be effected by cultures which have become attenuated by growth on artificial media, or by the naturally attenuated cocci which occur in the sputum after the crisis of the disease. Netter effected immunisation by injecting an emulsion of the dried spleen of an animal dead of pneumococcus septicæmia. Here the cocci were attenuated by the drying. Virulent cultures killed by heating at 62° C. have also been used, immunisation being here accomplished by the intracellular toxins. The Klemperers found that injection of rusty sputum kept at 60° C. for one to two hours and then filtered, and of filtered or unfiltered bouillon cultures similarly treated, had a like result. In all cases one or two injections of the modified bacteria or toxin were sufficient for immunisation. It was three days in the case of intravenous injection, and fourteen days in the case of subcutaneous injection, before immunity was established, and the latter lasted a month or more. The immunity was accompanied by the development in the blood of antitoxic substances which had no effect either outside or inside the body in killing the pneumococci, but merely neutralised their toxins. Such antitoxins not only protected a rabbit against subsequent inoculation with pneumococci, but if injected within twenty-four hours after inoculation, prevented death. A protective serum has also been obtained by Washbourn, who, as already described, has succeeded in obtaining pneumococcus cultures of constant virulence. This observer immunised a pony by using (1) broth cultures killed by one hour's exposure to 60° C.; (2) living agar cultures; (3) living broth cultures. From this animal a serum of high protective power was obtained. It protected susceptible animals against many times an otherwise fatal dose, and it also had a curative action, only, however, when injected very soon after inoculation. To what the protective properties of such sera are due requires further investigation. In this connection an interesting fact observed by Mennes may be noted, namely, that normal leucocytes only become phagocytic towards pneumococci when they are lying in the serum of an animal immunised against this bacterium.

If in these sera antitoxins are present this may shed new light on what occurs in man in the case of recovery from pneumonia. The view has been advanced that the crisis so

characteristic of a non-fatal case of the disease takes place when the balance of antitoxin against toxin is in favour of the former. The pneumococci after the crisis, as has been proved both culturally and by inoculation experiments, are still vital and virulent, though not so virulent as when the fever is at its height. On them directly the antitoxin has no effect, but any toxin now elaborated by them is neutralised, and has no longer either local or general pathogenic effects.

A fact interesting as corroborating the view that the pneumococcus is really the cause of acute lobar pneumonia is that the serum of patients who have recovered from pneumonia has in a certain proportion of cases a protective effect against the pneumococcus in rabbits. So far as our knowledge goes, such a protective serum is specific, or, in other words, protects only against the organism by the action of which its protective properties have been produced, and therefore it must be against the pneumococcus that the human subject requires protection in pneumonia.

The Klemperers treated a certain number of cases of human pneumonia by serum derived from immune animals, and apparently with a certain measure of success, and Washbourn's serum has also been used. Although the use of these sera apparently causes the temperature to fall, and in some cases appears to hasten a crisis, further experience is necessary before their value in therapeutics can be properly estimated.

If a small amount of a culture of Fraenkel's pneumococcus be placed in an anti-pneumococcic serum, an aggregation of the bacteria into clumps occurs. Such an agglutination, as it is called, is frequently observed under similar circumstances with other bacteria. The phenomenon is not invariably associated with the presence of protective bodies in a serum, but it has been used for diagnostic purposes in the differentiation of sore throats due to pneumococcus infection from those due to other bacteria. Whether the method is reliable has still to be proved.

Methods of Examination.—These have been already described, but may be summarised thus: (1) Microscopic. Stain films from the densest part of the sputum or from the area of spreading inflammation in the lung by Gram's method and by carbol-fuchsin, etc. (p. 102), in the latter case without decolorising the groundwork of the preparation.

(2) By cultures. (a) *Fraenkel's pneumococcus*. With similar material make successive strokes on agar, blood agar, or blood serum, or by inoculation of milk tubes. The most certain method, however, is to inject some of the material containing the suspected cocci into a rabbit. If the pneumococcus be present the animal will die, usually within forty-eight hours, with numerous capsulated pneumococci in its heart blood. With the latter inoculate tubes of the above media and observe the growth. In some cases of severe pneumococcic infection the organism may be cultivated from the blood obtained by venesection (p. 73). (b) *Friedländer's pneumobacillus* can be readily isolated either by ordinary agar and gelatin plates or by successive strokes on agar media.

CHAPTER IX.

GONORRHŒA, SOFT SORE, SYPHILIS.

GONORRHŒA.

Introductory. — The micrococcus now known to be the cause of gonorrhœa, and now called the *gonococcus*, was first described by Neisser, who in 1879 gave an account of its microscopical characters as seen in the pus of gonorrhœal affections, both of the urethra and of the conjunctiva. He considered that this organism was peculiar to the disease, and that its characters were distinctive. Later it was successfully isolated and cultivated on solidified blood serum by Bumm and others. Its characters have since been minutely studied, and by inoculations of cultures on the human subject its causal relationship to the disease has been conclusively established.

The Gonococcus. — Microscopical Characters. — The organism of gonorrhœa is a small micrococcus which usually is seen in the diplococcus form, the adjacent margins of the two cocci being flattened, or even slightly concave, so that between them there is a small oval interval which does not stain. An appearance is thus presented which has been compared to that of two beans placed side by side (*vide* Fig. 85). When division takes place in the two members of a diplococcus a tetrad is formed, which, however, soon separates into two sets of diplococci—that is to say, arrangement as diplococci is much commoner than as tetrads. Cocci in process of degeneration are seen as spherical elements of various size, some being considerably swollen.

These organisms are found in large numbers in the pus of acute gonorrhœa, both in the male and female, and for the most part are contained within the leucocytes. In the earliest stage, when the secretion is glairy, a considerable number are lying free, or are adhering to the surface of desquamated epithelial cells, but when it becomes purulent the large proportion within

leucocytes is a very striking feature. In the leucocytes they lie within the protoplasm, especially superficially, and are often so numerous that the leucocytes appear to be filled with them, and their nuclei are obscured. As the disease becomes more chronic, the gonococci gradually become diminished in number, though even in long-standing cases they may still be found in considerable numbers. They are also present in the purulent secretion of gonorrhœal conjunctivitis, also in various parts of the female genital organs when these parts are the seat of true gonorrhœal infection, and they have been found in some cases

in the secondary infections of the joints in the disease, as will be described below.

Staining.—The gonococcus stains readily and deeply with a watery solution of any of the basic aniline dyes—methylene-blue, fuchsin, etc. It is, however, easily decolourised, and it completely loses the stain by Gram's method—an important point in the microscopical examination.

Cultivation of the Gonococcus.—This is attended with

FIG. 85.—Portion of film of gonorrhœal pus, showing the characteristic arrangement of the gonococci within leucocytes. Stained with fuchsin. $\times 1000$.

some difficulty, as the suitable media and conditions of growth are somewhat restricted. The most suitable media are solidified blood serum (especially human serum and rabbit's serum), blood agar, and Wertheim's medium, which consists of one part of fluid serum added to two parts of liquefied agar at a temperature of 45° C. and then allowed to solidify by cooling. The serum may be obtained from the blood of the human placenta; pleuritic, hydrocele, or other effusion may also be used. Growth takes place best at the temperature of the body, and ceases altogether at 25° C. Cultures are obtained by taking some pus on the loop of the platinum needle and inoculating one of the media mentioned by leaving minute quantities here and there on the surface. The medium may be used either as ordinary "sloped tubes" or as a thin layer in a Petri's dish.

The young colonies are visible within forty-eight hours, and often within twenty-four hours. They appear around the points of inoculation as small semi-transparent discs of irregularly rounded shape, the margin being undulated and sometimes showing small processes. The colonies vary somewhat in size and tend to remain more or less separate. They generally reach their maximum size on the fourth or fifth day, and are usually found to be dead on the ninth day, often much earlier. On the medium of Wertheim the period of active growth and the duration of life are somewhat longer. Even if impurities are present, pure sub-cultures can generally be obtained by the above methods from colonies of the gonococcus which may be lying separate. In the early stage of the disease the organism is present in the male urethra in practically pure condition, and if the meatus of the urethra be sterilised by washing with weak solution of corrosive sublimate and then with absolute alcohol, and the material for inoculation be expressed from the deeper part of the urethra, cultures may often be obtained which are pure from the first. By successive sub-cultures at short intervals, growth may be maintained indefinitely, and the organism gradually flourishes more luxuriantly.

In culture the organisms have similar microscopic characters to those described (Fig. 86), but show a remarkable tendency to undergo degeneration, becoming swollen and of various sizes, and staining very irregularly. Degenerated forms are seen even on the second day, whilst in a culture four or five days old comparatively few normal cocci may be found. The less suitable the medium the more rapidly does degeneration take place.

On ordinary agar and on glycerin agar growth does not take place, or is so slight that these media are quite unsuitable for

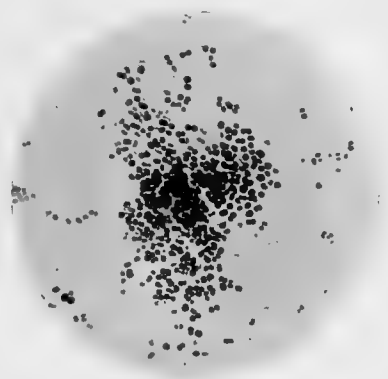

FIG. 86.—Gonococci, from a pure culture on blood agar of twenty-four hours' growth. Some already are beginning to show the swollen appearance common in older cultures.

Stained with carbol-thionin-blue. $\times 1000$.

purposes of culture. The organism does not grow on gelatin,¹ potato, etc.

Plate-cultures.—The following ingenious method of plate-culture was introduced by Wertheim for the culture of the gonococcus. The medium of culture is a mixture of human blood serum and of ordinary agar (2 per cent) in equal parts. The serum, in a fluid and sterile condition, is put in suitable quantities into two or three test-tubes and brought to a temperature of 45° C. These are then successively inoculated with the pus or other material in the same manner as gelatin tubes for ordinary plates (*vide* p. 54). To each tube is added an equal part of ordinary agar which has been thoroughly liquefied by heating and allowed to cool also to 45° C. The mixture is then thoroughly shaken up and quickly poured out on a plate or Petri's dish and allowed to solidify, the plates being then incubated at a temperature of 37° C. The colonies of the gonococcus are just visible in twenty-four hours, and are seen both in the substance of the medium and on the surface. The deep colonies when examined with a lens are minute and slightly nodulated spheres, sometimes showing little processes, whilst those on the surface are thin discs of larger diameter with wavy margin and rather darker centre. In this way the gonococcus may be separated from fluids which are contaminated with a considerable number of other organisms.

Relations to the Disease.—The gonococcus is invariably present in the urethral discharge in gonorrhœa, and also in other parts of the genital tract when these are the seat of true gonorrhœal infection. Its presence in these different positions has been demonstrated not only by microscopic examination but also by culture. From the description of the conditions of growth in culture, it will be seen that a life outside the body in natural conditions is practically impossible—a statement which corresponds with the clinical fact that the disease is always transmitted directly by contagion. Inoculations of pure cultures on the urethra of lower animals, and even of apes, is followed by no effect, but a similar statement can be made with regard to inoculations of gonorrhœal pus itself. In fact, hitherto it has been found impossible to reproduce the disease by any means in the lower animals. On a considerable number of occasions inoculations of pure cultures have been made on the human urethra, both in the male and female, and the disease, with all its characteristic symptoms, has resulted. (Such

¹ Turro has announced that he has cultivated the gonococcus on acid gelatin, *i.e.* ordinary peptone gelatin which has not been neutralised. We have failed to obtain any growth of the gonococcus on this medium, even when inoculation was made from a vigorous growth on blood agar.

experiments have been performed independently by Bumm, Steinschneider, Wertheim, and others.) The causal relationship of the organism to the disease has therefore been completely established, and it is interesting to note how the conditions of growth and the pathogenic effects of the organism agree with the characters of the natural disease.

Intraperitoneal injections of pure cultures of the gonococcus in white mice produce a localised peritonitis with a small amount of suppuration, the organisms being found in large numbers in the leucocytes (Wertheim). They also penetrate the peritoneal lining and are found in the sub-endothelial connective tissue, but they appear to have little power of proliferation, they soon disappear, and the inflammatory condition does not spread. Injection of pure cultures into the joints of rabbits, dogs, and guinea-pigs causes an acute inflammation, which, however, soon subsides, whilst the gonococci rapidly die out; a practically similar result is obtained when dead cultures are used. These experiments show that while the organism, when present in large numbers, can produce a certain amount of inflammatory change in these animals, it has little or no power of multiplying and spreading in their tissues.

Toxin of the Gonococcus. — De Christmas has cultivated the gonococcus in a mixture of ^{one}part of ascitic fluid and three parts of bouillon, and has found that the fluid after twelve days' growth has toxic properties. At this period all the organisms are dead; such a fluid constitutes the "toxin." The toxic substances are precipitated along with the proteids by alcohol, and the precipitate after being desiccated possesses the toxic action. In young rabbits injection of the toxin produces suppuration; this is well seen in the anterior chamber of the eye, where hypopyon results. The most interesting point, however, is with regard to its action on mucous surfaces; for, while in the case of animals it produces no effect, its introduction into the human urethra causes acute catarrh, attended with purulent discharge. He found that no tolerance to the toxin resulted after five successive injections at intervals. In a recent publication he points out that the toxin has marked effects on intracerebral injection; he also claims to have produced an anti-toxin. He claims that the toxin diffuses out in the culture medium, and does not merely result from disintegration of the organisms. This has, however, been called in question by other investigators.

Distribution in the Tissues. — The gonococcus having been thus shown to be the direct cause of the disease, some additional facts may be given regarding its presence both in the primary and secondary lesions. In the human urethra the gonococci penetrate the mucous membrane, passing chiefly between the epithelial cells, causing a loosening and desquamation of many of the latter and inflammatory reaction in the tissues below, attended with great increase of secretion. There occurs also a gradually increasing emigration of leucocytes, which take up a

large number of the organisms. The organisms also penetrate the subjacent connective tissue, and are especially found along with extensive leucocytic emigration around the lacunæ. Here also many are contained within leucocytes. Even, however, when the gonococci have disappeared from the urethral discharge, they may still be present in the deeper part of the mucous membrane of the urethra, possibly also in the prostate, and may thus be capable of producing infection. The prostatic secretion may sometimes be examined by making pressure on the prostate from the rectum when the patient has almost emptied his bladder, the secretion being afterwards discharged along with the remaining urine. (Foulerton.) In acute gonorrhœa there is often a considerable degree of inflammatory affection of the prostate and vesiculæ seminales, but whether these conditions are always due to the presence of gonococci in the affected parts we have not at present the data for determining. A similar statement also applies to the occurrence of orchitis and also of cystitis in the early stage of gonorrhœa. Gonococci have, however, been obtained in pure culture from periurethral abscess and from epididymitis. During the more chronic stages other organisms may appear in the urethra, aid in maintaining the irritation, and produce some of the secondary results. The bacillus coli, the pyogenic cocci, etc., are often present, and may extend along the urethra to the bladder and set up cystitis, though in this they may be aided by the passage of a catheter. It is then also that buboes usually occur, often associated with the presence of a small ulcer in the urethra. Though the bacteriology of these cannot yet be said to be fully worked out, they are certainly sometimes produced by the ordinary pyogenic organisms and by some varieties of diplococci which are often present in the urethra in abnormal conditions. It may be mentioned here that Wertheim cultivated the gonococcus from a case of chronic gonorrhœa of two years' standing, and by inoculation on the human subject proved it to be still virulent.

In the disease in the female, gonococci are almost invariably present in the urethra, the situation affected next in frequency being the cervix uteri. They do not appear to infect the lining epithelium of the vagina of the adult unless some other abnormal condition be present, but they do so in the gonorrhœal vulvo-vaginitis of young subjects. They have also been found

in suppurations in connection with Bartholini's glands, and sometimes produce an inflammatory condition of the mucous membrane of the body of the uterus. They may also pass along the Fallopian tubes and produce inflammation of the mucous membrane there. From the pus in cases of pyosalpinx they have been cultivated in a considerable number of cases. According to the results of various observers they are present in one out of four or five cases of this condition, usually unassociated with other organisms. Further, in a large proportion of the cases in which the gonococcus has not been found no organisms of any kind have been obtained from the pus, and in these cases the gonococci may have been once present, and have subsequently died out. Lastly, they may pass to the peritoneum and produce peritonitis, which is usually of a local character, but cases of acute diffuse peritonitis are recorded by Meija, Frank, Cushing, Hunner and Harris. It is chiefly to the methods of culture supplied by Wertheim that we owe our extended knowledge of such conditions.

In *gonorrhœal conjunctivitis* the mode in which the gonococci spread through the epithelium to the subjacent connective tissue is closely analogous to what obtains in the case of the urethra. Their relation to the leucocytes in the purulent secretion is also the same. Microscopic examination of the secretion alone in acute cases often gives positive evidence, and pure cultures may be readily obtained on blood agar. As the condition becomes more chronic the gonococci are less numerous and a greater portion of other organisms may be present.

Relations to Joint Affections, etc.—The relations of the gonococcus to the sequelæ of gonorrhœa form a subject of great interest and importance, and the application of recent methods of examination show that the organism is much more frequently present in such conditions than the earlier results indicated. The following statements may be made with regard to them. First, in a considerable number of cases of arthritis following gonorrhœa, the gonococcus has been found microscopically, and pure cultures have been obtained, *e.g.* by Neisser, Lang, Bordoni-Uffreduzzi, and many others. A similar statement applies to inflammation of the sheaths of tendons following gonorrhœa. Secondly, in a large proportion of cases no organisms have been found. It is, however, possible that in a number

of these the gonococci may have been present in the synovial membrane, as it has been observed that they may be much more numerous in that situation than in the fluid. Thirdly, in some cases, especially in those associated with extensive suppuration, occasionally of a pyæmic nature, various pyogenic cocci have been found to be present. In the instances in which the gonococcus has been found in the joints, the fluid present has been described as being usually of a whitish-yellow tint, somewhat turbid, and containing shreds of fibrin-like material, sometimes purulent in appearance. In one case Bordoni-Uffreduzzi cultivated the gonococcus from a joint affection, and afterwards produced gonorrhœa in the human subject by inoculating with the cultures obtained. In another case in which pleurisy was present along with arthritis the gonococcus was cultivated from the fluid in the pleural cavity. The existence of a *gonorrhœal endocarditis* has been established by recent observations. Cases apparently of this nature occurring in the course of gonorrhœa had been previously described, but the complete bacteriological test has now been satisfied in several instances. In one case Lenhartz produced gonorrhœa in the human subject by inoculation with the organisms obtained from the vegetations. That a true *gonorrhœal septicæmia* may also occur has also been established, cultures of the gonococcus having been obtained from the blood during life on more than one occasion (Thayer and Blumer, Thayer and Lazear, Ahmann, Wilson, and Harris and Johnston).

Methods of Diagnosis. — For microscopical examination dried films of the suspected pus, etc., may be stained by any of the simple solutions of the basic aniline stains. We prefer methylene, or thionin-blue, as they do not overstain, and the films do not need to be decolorised. Staining for one minute is sufficient. It is also advisable to stain by Gram's method, and it is a good plan to put at one margin of the cover-glass a small quantity of culture of staphylococcus aureus if available, in order to have a standard by which to be certain that the supposed gonococci are really decolorised. Regarding the value of microscopic examination alone, we may say that the presence of a large number of micrococci in a urethral discharge having the characters, position, and staining reactions described above, is practically conclusive that the case is one of gonorrhœa. There is no other condition

in which the sum total of the microscopical characters is present. We consider that it is sufficient for purposes of *clinical* diagnosis, and therefore of great value; in the acute stage a diagnosis can thus be made earlier than by any other method. The mistake of confusing gonorrhœa with such conditions as a urethral chancre with urethritis, will also be avoided. Even in chronic cases the typical picture is often well maintained, and microscopic examination alone gives a definite positive result. When other organisms are present, and especially when the gonococci are few in number, it is difficult, and in some cases impossible, to give a definite opinion, as a few gonococci mixed with other organisms cannot be recognised with certainty. This is often the condition in chronic gonorrhœa in the female. Microscopic examination, therefore, though often giving positive results, will sometimes be inconclusive. As regards lesions in other parts of the body, microscopic examination alone is quite insufficient; it is practically impossible, for example, to distinguish by this means the gonococcus from the diplococcus intracellularis of meningitis. Cultures alone supply the absolute test, and this test should never be neglected when a diagnosis is rendered absolutely necessary in reference to moral social status, or to medico-legal inquiry. We then have recourse to the plate method, using Wertheim's medium, or hydrocele-fluid agar.

SOFT SORE.

Within recent years a considerable amount of attention has been directed to the bacteriology of this condition, owing to the discovery of a somewhat characteristic bacillus in the affected parts. This organism was first described by Ducrey in 1889, who found it in the purulent discharge from the ulcerated surface; and, later, in 1892, Unna described its appearance and distribution as seen in sections through the sores. The statements of these observers regarding the presence and characters of this organism have been fully confirmed by other observers.

Microscopical Characters. — This organism appears in the form of minute oval rods measuring about 1.5μ in length, and $.5 \mu$ in thickness. It is found mixed with other organisms in the purulent discharge from the surface, and is chiefly arranged in small groups or in short chains. When studied in sections through the ulcer it is found in the superficial part of the floor,

but more deeply situated than other organisms, and may be present in a state of purity amongst the leucocytic infiltration. In this position it is usually arranged in chains which may be of considerable length, and which are often seen lying in parallel rows between the cells. The bacilli chiefly occur in the free condition, but occasionally a few may be contained within leucocytes.

This bacillus takes up the basic aniline stains fairly readily, but loses the colour very rapidly when a decolorising agent is applied. Accordingly, in film preparations when dehydration is not required, it can be readily stained by most of the ordinary combinations, though Löffler's or Kühne's methylene-blue solutions are preferable, as they do not overstain. In sections, however, great care must be taken in the process of dehydration, and the aniline-oil method (*vide* p. 96) should be used for this purpose, as alcohol decolorises the organism very readily. A little of the methylene-blue or other stain may be with advantage added to the aniline oil used for dehydrating.

This organism has not yet been successfully cultivated outside the body, though practically every medium has been tried for this purpose. Ducrey, however, succeeded in separating it from other organisms by the following method. He produced a series of pustules by successive inoculations in the human subject on the skin, which had been previously sterilised, the pustules being afterwards protected from contamination by watch-glasses fixed in position. He found that in this method the other organisms gradually died off, while the characteristic bacilli persisted, and at about the fifth or sixth inoculation might be present alone. Further, the pus containing the bacilli in a pure condition still produced the typical lesion on inoculation. Even when the organisms were thus separated he failed to obtain any growth on the numerous media which he employed.

The evidence that this organism is the causal agent in the affection accordingly rests on the facts well established that the organism is apparently always present in the discharge from the sore, and in its tissues; that it has been observed hitherto in no other form of ulceration; and that it is sharply marked off from saprophytic organisms by the fact that it has not been obtained in cultures outside the body.

Regarding the presence of this organism in the buboes associated with soft sore, there is some uncertainty. A considerable

number of observers have failed to find it, and have also failed to produce a characteristic soft sore by inoculation with pus withdrawn from a bubo under aseptic precautions. When a chancroid condition follows in a bubo which has been opened, they accordingly consider that it has been secondarily inoculated with the bacillus. On the other hand, one or two observers have found the bacillus in unopened buboes. Audry, for example, in a bubo before suppuration had occurred, found it lying in little groups of two or three within leucocytes in the lymph channels; and in this case inoculation with the material from the bubo produced the typical lesion. Krefting also found it in buboes in some cases. It is therefore possible that the buboes associated with soft sore are caused by the same organisms, but that as suppuration occurs they in great part die off. It seems certain at least, from the results of various workers, that in many cases the ordinary pyogenic organisms are not present in the suppurating buboes.

In connection with the two diseases, gonorrhœa and soft sore, it is of special interest to note in the case of the former how restricted are the conditions of growth outside the body of the organism which produces the disease, and in the case of the latter, that attempts to cultivate the supposed causal organism outside the body have entirely failed.

However, Besançon, Griffon and Le Sourd claim to have grown Ducrey's bacillus on human blood agar, as well as on that of the dog and the hare, where all the morphological peculiarities before described were reproduced. In the condensation-water growth in tube-cultures, the bacilli grew out in long wavy chains, whilst in uncoagulated hare's blood the bacilli were so short as to resemble chains of streptococci. The viability and virulence of blood-agar cultures were maintained for a relatively long period: a culture of the eleventh generation still produced typical chancres, although on hare's blood the viability was very brief. Due credence cannot be given to this research until further confirmation.

SYPHILIS.

Regarding the relation of bacteria to this disease, we cannot be said at present to possess much definite knowledge. Most interest, however, is attached to the observations of Lustgarten,

who in 1884 described a characteristic bacillus both in the primary sore and in the lesions in internal organs. He found it in all of sixteen cases which he examined. This bacillus somewhat resembles the tubercle bacillus in shape and size. It occurs in the form of slender rods, straight or slightly bent, about 3 to 4 μ in length, often forming little clusters either within cells or lying free in the lymphatic spaces. Like the tubercle bacillus it takes up the basic aniline stains with difficulty, but it is much more easily decolorised by mineral acids. Lustgarten stained the tissues for twenty-four to forty-eight hours in aniline-water solution of gentian-violet; and then, after washing them in alcohol, placed them for ten seconds in a 1.5 per cent solution of permanganate of potassium. They were then treated with sulphurous acid, which removes the brown precipitate formed, and decolorises the sections. They were then washed in water, dehydrated, and mounted. The observations of other workers have given contradictory results. De Michele and Radice, for example, found Lustgarten's bacilli in the tissues in forty-five out of sixty-four cases examined, while, on the other hand, other observers have failed to find them.

Apart, however, from negative results obtained by many, criticism has been made in other ways. It has been alleged by some that Lustgarten's bacilli is merely the *smegma bacillus* which has penetrated the affected tissues. This explanation, however, would not account for the presence of the bacilli in the internal organs, where they were observed by Lustgarten and others. And further, there are minor points of difference between this smegma bacillus and Lustgarten's bacillus. It has also been suggested by some that the organisms described by Lustgarten are merely tubercle bacilli which have been accidentally present in the affected tissues. Those, however, who have found the former organism in the tissues agree that it can be readily distinguished from the tubercle bacillus, as it does not resist decolorising with strong acids. This explanation of the presence of these bacilli in the tissues is really without definite support.

The organism has not been cultivated outside the body, though, in view of what we know with regard to some other diseases, this fact in itself does not form a grave objection. In the absence, however, of definite evidence as to its invariable presence in the lesions, its relations to the disease are still highly

problematical. It may also be noticed that this organism has been found in the tertiary lesions, which are usually believed to be non-infectious.

Other organisms have been described as present in syphilitic lesions, notably one quite recently by Van Niessen. This organism is a pleomorphous bacillus belonging to the higher bacteria. He claims not only to have demonstrated it, both in the tissues and in the blood, but to have obtained it in pure culture from a number of cases. On the other hand, Schüller states that he has found a protozoon-like organism in a great variety of syphilitic lesions. The latest researches are those reported by Joseph and Piorkowski, who have cultivated on sterile placenta a certain bacillus from the semen of twenty-five syphilitics and from the blood in two cases. Their description of the bacillus shows it to have many characters in common with those organisms which resemble *B. diphtheriæ*. Four cases supposed to be free of syphilitic taint when examined in the same manner showed none of the bacilli. Until confirmation of these results has been obtained it is unnecessary to give details.

CHAPTER X.

TUBERCULOSIS.

THE cause of tubercle was proved by Koch in 1882 to be the organism now universally known as the tubercle bacillus. Probably no other single discovery has had a more important effect on medical science and pathology than this. It has not only shown what is the real cause of the disease, but has also supplied infallible methods for determining what are tubercular lesions and what are not, and has also given the means of studying the modes and paths of infection. A definite answer has in this way been supplied to many questions which were previously the subject of endless discussion.

Historical. — Klencke in 1843 made the statement that he had produced tuberculosis in rabbits by intravenous injection of tubercular material, but he only concluded from these experiments that the cells of tubercles could multiply and reproduce the disease, and he appears to have placed little importance on the discovery. Villemin has the honour of having been the first to investigate the infectious character of tubercle by systematic experiments, and to demonstrate the regularity with which tuberculosis can be transmitted by inoculation with tubercular material. His first observations were published in 1865. He produced tuberculosis in animals not only by tubercular material from the human subject, but also by portions of what were known as the *Perlsucht* nodules in cattle, and came to the conclusion that *Perlsucht* was due to the same virus as tubercle. He concluded that this virus was comparable in its mode of action with that of other infectious diseases. These views, however, aroused a storm of opposition from all sides. The opposition was at first chiefly on theoretical grounds, but later also from experimental results. Investigators who repeated Villemin's experiments obtained similar results so far as the production of tuberculosis by tubercular material was concerned, but many found that tuberculosis also followed inoculation with non-tubercular material (such as pus from pyæmic abscesses, portions of decomposed tissue, etc.), and even by the mere introduction of setons. The general opinion came to be strongly against the existence in tubercle of an infective agent of specific nature, and along with this there prevailed great confusion as to the distinction between tubercular and non-tubercular lesions.

By the work of Armani and of Cohnheim and Salomonsen (1870-80) it had been demonstrated that tubercle was an infective disease. The latter

observers found on inoculation of the anterior chamber of the eye of rabbits with tubercular material that in many cases the results of irritation soon disappeared, but that after a period of incubation, usually about twenty-five days, small tubercular nodules appeared in the iris; afterwards the disease gradually spread, leading to a tubercular disorganisation of the globe of the eye. Later, the lymphatic glands became involved, and finally the animal died of acute tuberculosis. The question remained as to the nature of the virus, the specific character of which was thus established, and this question was answered by the work of Koch.

The announcement of the discovery of the tubercle bacillus was made by Koch in March, 1882, and a full account of his researches appeared in 1884 (*Mitth. a. d. K. Gsndhtsamte.*, Berlin). Koch's work on this subject will remain as a classical masterpiece of bacteriological research, both on account of the great difficulties which he successfully overcame and the completeness with which he demonstrated the relations of the organism to the disease. The two chief difficulties were, first, the demonstration of the bacilli in the tissues, and, secondly, the cultivation of the organism outside the body. For, with regard to the first, the tubercle bacillus cannot be demonstrated by a simple watery solution of a basic aniline dye, and it was only after prolonged staining for twenty-four hours with a solution of methylene-blue with caustic potash added, that he was able to reveal the presence of the organism. Then, in the second place, all attempts to cultivate it on the ordinary media failed, and he only succeeded in obtaining growth on solidified blood serum, the method of preparing which he himself devised, inoculations being made on this medium from the organs of animals artificially rendered tubercular. The fact that growth did not appear till the tenth day at the earliest, might easily have led to the hasty conclusion that no growth took place. All difficulties were, however, successfully overcome. He cultivated the organism by the above method from a great variety of sources, and by a large series of inoculation experiments on various animals, performed by different methods, he conclusively proved that bacilli from these different sources produced the same tubercular lesions and were really of the same species. His work was the means of showing conclusively that such conditions as lupus, "white swelling" of joints, scrofulous disease of glands, etc., are really tubercular in nature.

Tuberculosis in Animals.—Tuberculosis is not only the most widely spread of all diseases affecting the human subject, and produces a mortality greater than any other, but there is probably no other disease which affects the domestic animals so widely. We need not here describe in detail the various tubercular lesions in the human subject, but some facts regarding the disease in the lower animals may be given, as this subject is of great importance in relation to the infection of the human subject.

Amongst the domestic animals the disease is commonest in cattle (bovine tuberculosis), and in them the lesions are very various, both in their character

and distribution. In most cases the lungs are affected, and contain numerous rounded nodules, many being of considerable size; these may be softened in the centre, but are usually of pretty firm consistence and may be calcified. There may be in addition caseous pneumonia, and also small tubercular granulations. Along with these changes in the lungs, the pleuræ are also often affected, and show numerous nodules, some of which may be of large size, firm and pedunculated, the condition being known in Germany as *Perlsucht*, in France as *pommelière*. Lesions similar to the last may be chiefly confined to the peritoneum and pleuræ. In other cases, again, the abdominal organs are principally involved. The udder becomes affected in a certain proportion of cases of tuberculosis in cows — in 3 per cent according to Bang — but primary affection of this gland is very rare. Tuberculosis is also a comparatively common disease in pigs, in which animals it in many cases affects the abdominal organs, in other cases produces a sort of caseous pneumonia, and sometimes is met with as a chronic disease of the lymphatic glands, the so-called “scrofula” of pigs. Tubercular lesions in the muscles are less rare in pigs than in most other animals. In the horse the abdominal organs are usually the primary seat of the disease, the spleen being often enormously enlarged and crowded with nodules of various shapes and sizes; sometimes, however, the primary lesions are pulmonary. In sheep and goats tuberculosis is a rare occurrence, especially in the former animals. It also occurs spontaneously in dogs, cats, and in the large carnivora. It is also sometimes met with in monkeys in confinement, and leads to a very rapid and widespread affection in these animals, the nodules having a special tendency to soften and break down into a pus-like fluid.

Tuberculosis in fowls (avian tuberculosis) is a common and very infectious disease, nearly all the birds in the poultry-yard being sometimes affected. The relation of the different forms of tuberculosis is discussed below.

From these statements it will be seen that the disease in animals presents great variations in character, and may differ in many respects from that met with in the human subject. The tubercle nodules may be of so large a size, *e.g.* in the horse and ox, as to be described as sarcoma-like; they may be tough and firm, with little or no caseation, or they may be softened in the centre, more resembling abscesses, or again there may be an eruption of very minute granulations. However different their naked-eye appearances may be, they are built up histologically on the same plan, and of greater importance still is the fact that they are all produced by the tubercle bacillus. An account of the lesions experimentally produced will be given later.

Tubercle Bacillus. — **Microscopical Characters.** — Tubercle bacilli are minute rods which usually measure 2.5 to 3.5 μ in length, and .3 μ in thickness, *i.e.* in proportion to their length

they are comparatively thin organisms (Figs. 87 and 88). Sometimes, however, longer forms, up to $5\ \mu$ or more in length, are met with, both in cultures and in the tissues. They are straight or slightly curved, and are of uniform thickness, or may show slight swelling at their extremities. When stained they appear uniformly coloured, or may present small uncoloured spots along their course, with darkly stained parts between. In the case of the tubercle bacillus, as of many other organisms, a considerable amount of discussion has taken place as to the occurrence of spores.

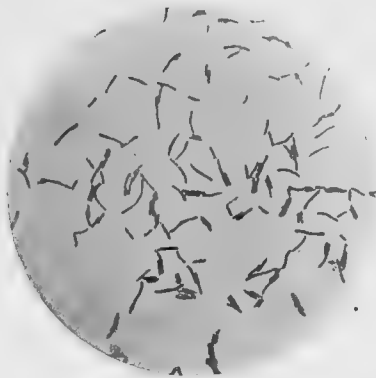

FIG. 87.—Tubercle bacilli, from a pure culture on glycerin agar. Stained with carbol-fuchsin. $\times 1000$.

In such a minute organism it is extremely difficult to recognise the exact characters of the unstained points. Accordingly,

we find that some consider these to be spores, while others find that it is impossible to stain them by any means whatever, and consider that they are really of the nature of vacuoles. Against their being spores is also the fact that many occur in one bacillus. Others again hold that

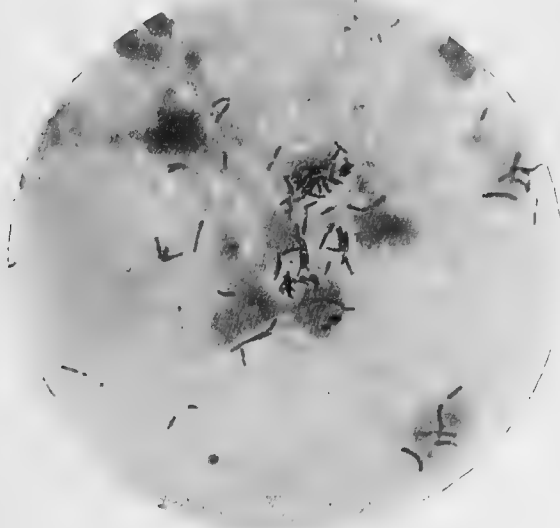

FIG. 88.—Tubercle bacilli in phthisical sputum; they are longer than is often the case. Film preparation, stained with carbol-fuchsin and methylene-blue. $\times 1000$.

some of the condensed and highly stained particles are spores.

It is impossible to speak definitely on the question at present. We can only say that the younger bacilli stain uniformly, and that in the older forms inequality in staining is met with, but it has not been proved that this indicates spore formation.

The bacilli in the tissues occur scattered irregularly or in little masses. They are usually single, or two are attached end to end and often form in such a case an obtuse angle. True chains are not formed, but occasionally short filaments are met with. In cultures the bacilli form masses in which the rods are closely applied to one another and arranged in a more or less parallel manner. Tubercle bacilli are quite devoid of motility.

Aberrant Forms.—Though such are the characters of the organism as usually met with, other appearances are sometimes found. In old cultures, for example, very much larger elements may occur. These may be in the form of long filaments, which may be swollen or clubbed at their extremities, may be irregularly beaded, and may even show the appearance of branching. Such forms have been studied by Metchnikoff, Maffucci, Klein, and others. Their significance has been variously interpreted, for while some look upon them as degenerated or involution forms, others regard them as indicating a special phase in the life history of the organism, allying it with the higher bacteria. Recent observations, however, go to establish the latter view, and this is now generally accepted by authorities. It has also been found that under certain circumstances tubercle bacilli in the tissues produce a radiating structure closely similar to that of the actinomyces. This was found to be the case by Babes and also by Lubarsch, when the bacilli were injected under the dura mater and directly into certain solid organs, such as the kidneys in the rabbit. Club-like structures are also present at the periphery; these are usually not acid-fast, but they retain the stain in the Weigert-Gram method. Similar results have also been obtained with other acid-fast bacilli, which will be mentioned below, and these would appear to form a group of organisms closely allied to the streptothriceæ, the bacillary parasitic form being one stage of the life history of the organism.

Staining Reaction.—The tubercle bacillus takes up the ordinary stains very slowly and faintly, and for successful staining

one of the most powerful solutions ought to be employed, *e.g.* gentian-violet or fuchsin, along with aniline-oil water or solution of carbolic acid. Further, such staining solutions require to be applied for a long time, or the staining must be accelerated by heat, the solution being warmed till steam arises and the specimen allowed to remain in the hot stain for two or three minutes. One of the best and most convenient methods is the Ziehl-Neelsen method (see p. 104). The bacilli present this further peculiarity, however, that after staining has taken place they resist decolorising by solutions which readily remove the colour from the tissues and from other organisms which may be present. Such decolorising agents are sulphuric or nitric acid in 20 per cent solution, or 2 per cent solution of hydrochloric acid in 80 per cent alcohol. Preparations can thus be obtained in which the tubercle bacilli alone are coloured by the stain first used, and the tissues can then be coloured by a contrast stain. Within recent years certain other bacilli have been discovered which present the same staining reactions as tubercle bacilli; they are therefore called "acid-fast" (*vide infra*). Tubercle bacilli, also stain by Gram's method, but the results are inferior to those obtained with carbolic fuchsin.

Bulloch and Macleod, by treating tubercle bacilli with hot alcohol and ether, extracted a wax which gave the characteristic staining reactions of the bacilli themselves. The remains of the bacilli, further, when extracted with caustic potash, yielded a body which was probably a chitin, and which was acid-fast when stained for twenty-four hours with carbol-fuchsin.

Cultivation. — The medium first used by Koch was inspissated blood serum (*vide* p. 43). If inoculations are made on this medium with tubercular material free from other organisms, there appear from the tenth to fourteenth day minute points of growth of dull whitish colour, rather irregular, and slightly raised above the surface. Koch compared the appearance of these to that of small dry scales. In such cultures they usually reach only a comparatively small size and remain separate, becoming confluent only when many occur close together. In sub-cultures, however, growth is more luxuriant and may come to form a dull wrinkled film of whitish colour, which may cover the greater part of the surface of the serum and at the bottom of the tube may grow over the surface of the condensation water on to the

glass (Fig. 89, A). The growth is always of a dull appearance and has a considerable degree of consistence, it being difficult to dissociate a portion thoroughly in a drop of water. In older cultures the growth may acquire a slightly brownish or buff colour.



FIG. 89. — Cultures of tubercle bacilli on glycerin agar.

A and B. Mammalian tubercle bacilli; A is an old culture, B, one of a few weeks' growth. C. Avian tubercle bacilli. The growth is whiter and smoother on the surface than the others.

When the small colonies are examined under a low power of the microscope they are seen to be extending at the periphery in the form of wavy or sinuous streaks which radiate outward and which have been compared to the flourishes of a pen. The central part shows similar markings closely interwoven. These streaks are composed of masses of the bacilli arranged in a more or less parallel manner.

On *glycerin agar*, which was first introduced by Nocard and Roux as a medium for the culture of the tubercle bacillus, growth takes place in sub-cultures at an earlier date and progresses more rapidly than on serum, but, strangely enough, this medium is not suitable for obtaining cultures from the tissues, inocu-

lations with tubercular material usually yielding a negative result. The growth has practically the same characters as on serum, but is more luxuriant. The organism, however, tends to lose its virulence more rapidly than when grown on serum. In *glycerin broth*, especially when the layer is not deep, tubercle bacilli grow readily in the form of little white masses which fall to the bottom and form a powdery layer. If, however, the growth be started on the surface it spreads superficially as a dull whitish, wrinkled pellicle which may reach the walls of the flask; this mode of growth is specially suitable for the production of tuberculin (*vide infra*). The culture has a peculiar fruity and not unpleasant odour. On ordinary agar and on gelatin media no growth takes place.

It was at one time believed that the tubercle bacillus would only grow on media containing animal fluids, but of late years it has been found that growth takes place also on a purely vegetable medium, as was first shown by Pawlowsky in the case of potatoes. Sander has shown that the bacillus grows readily on potato, carrot, macaroni, and on infusion of these substances, especially when glycerin is added. He also found that cultures from tubercular lesions could be obtained on glycerin potato (p. 47). In sub-culture the bacillus also grows well upon potato which has been sterilised in 2 per cent glucose broth after the manner of glycerinated potato.

The optimum temperature for growth is 37° to 38° C. Growth ceases above 42° and usually below 28° , but on long-continued cultivation outside the body and in special circumstances, growth may take place at a lower temperature, *c.g.* Sander found that growth took place in glycerin-potato broth even at 22° to 23° C.

Powers of Resistance. — Tubercle bacilli have considerable powers of resistance to external influences, and can retain their vitality for a long time outside the body in various conditions; in fact, in this respect they may be said to occupy an intermediate position between spores and spore-free bacilli. Dried phthisical sputum has been found to contain still virulent bacilli (or their spores?) after two months, and similar results are obtained when the bacilli are kept in distilled water for several weeks. So also they resist for a long time the action of putrefaction, which is rapidly fatal to many pathogenic organisms. Sputum has been found to contain living tubercle bacilli even after being allowed to putrefy for several weeks (Fraenkel, Baumgarten), and the bacilli have been found to be alive in tubercular organs which have been buried in the ground for a similar period. They are not killed by being exposed to the action of the gastric juice for six hours, or to a temperature of -3° C. for three hours, even when this is repeated several times. It has been found that when completely dried they can resist a temperature of 100° C. for an hour, but, on the other hand, exposure in the moist condition to 70° C. for the same time is usually fatal. Theobald Smith, from an interesting series of thermal death-point tests, concludes that bacilli suspended in distilled water, normal salt solution, bouillon and milk are destroyed at 60° C. in 15 to 20 minutes, the larger number being destroyed in 5 to 10 minutes. In milk suspensions, however, the pellicle which forms during heating at 60° C. may

contain living bacilli after one hour. It may be stated that raising the temperature to 100° C. kills the bacilli in fluids and in tissues, but in the case of large masses of tissue care must be taken that this temperature is reached throughout. They are killed in less than a minute by exposure to 5 per cent carbolic acid, and both Koch and Straus found that they are rapidly killed by being exposed to the action of direct sunlight.

Action on the Tissues.—The *local lesion* produced by the tubercle bacillus is the well-known tubercle nodule, but though the typical structure is often described as consisting of a central giant-cell surrounded by a zone of comparatively large and somewhat spindle-shaped cells (epithelioid cells), and again by an outer zone of lymphocytes or small uninucleated leucocytes, the structure varies in different situations and according to the intensity of the action of the bacilli.

A considerable discussion has taken place as to the exact origin of the elements composing the tubercle follicle. In the case of the iris its formation was fully studied by Baumgarten, and his views we consider to be correct regarding the ordinary mode of formation. Before describing the exact changes which occur in the tissues, it may be stated that the action of the bacillus is twofold. On the one hand it induces tissue reaction in the form of leucocytic infiltration and proliferative changes, and on the other hand, it causes degenerative changes in the cells around, which afterwards result in their death.

After the bacilli gain entrance to a connective tissue such as that of the iris, their first action appears to be on the connective-tissue cells, which become somewhat swollen and undergo mitotic division, the resulting cells being distinguishable by their large size and pale nuclei. These constitute the so-called epithelioid cells. These proliferative changes may be well seen on the fifth day after inoculation or even earlier. A small focus of proliferated cells is thus formed in the neighbourhood of the bacilli and about the same time numbers of leucocytes—chiefly lymphocytes—begin to appear at the periphery and gradually become more numerous.

Soon, however, the action of the bacilli as cell-poisons comes into prominence, the changes first occurring in the centre of the focus. The epithelioid cells become swollen and somewhat hyaline, their outlines become indistinct, whilst their nucleus

stains faintly, and ultimately loses the power of staining. The cells in the centre, thus altered, gradually become fused into a homogeneous substance and this afterwards becomes somewhat granular in appearance. If the central necrosis does not take place quickly, then giant-cell formation may occur in the centre of the follicle, this constituting one of the characteristic features of the tubercular lesion, or after the occurrence of caseation giant-cells may be formed in the cellular tissue around. The centre of a giant-cell often shows signs of degeneration, such as hyaline change and vacuolation, or it may be more granular than the rest of the cell.

Though there has been a considerable amount of discussion as to the mode of origin of the giant-cells, we think there can be little doubt that in most cases they result from enlargement of single epithelioid cells, the nucleus of which undergoes proliferation without the protoplasm dividing. These epithelioid cells may sometimes be the lining cells of capillaries. Sometimes cells a little larger than epithelioid cells may be seen, which contain only two or three nuclei; these may be young giant-cells. Some consider that the giant-cells result from a fusion of the epithelioid cells; but, though there are occasionally appearances which indicate such a mode of formation, it cannot be regarded as of common occurrence. In some cases of acute tuberculosis, when the bacilli become lodged in a capillary the endothelial cells of its wall may proliferate, and thus a ring of nuclei be formed round a small central thrombus. Such an occurrence gives rise to an appearance closely resembling a typical giant-cell. According to the view here stated, both the epithelioid and the giant-cells are of connective tissue origin; and we can see no sufficient evidence for the view held by some observers, chiefly of the French school, that they are formed from leucocytes which have emigrated from the capillaries.

There can be no doubt, we think, from a careful study of the tubercular lesions, that the cell necrosis and subsequent caseation depend upon the products of the bacilli, and are not due to the fact that the tubercle nodule is non-vascular. This non-vascularity itself is to be explained by the circumstance that young capillaries cannot grow into a part where tubercle bacilli are active, and that the already existing capillaries become thrombosed, owing to the action of the bacillary products on

their walls, and ultimately disappear. At the periphery of tubercular lesions there may be considerable vascularity and new formation of capillaries.

The *general symptoms of tuberculosis* — pyrexia, perspiration, wasting, etc., are to be ascribed to the absorption and distribution throughout the system of the toxic products of the bacilli; in the case of phthisical cavities and like conditions where other bacteria are present, the toxins of the latter also play an important part. The occurrence of waxy change in the organs is believed by some to be chiefly due to the products of other, especially pyogenic, organisms, secondarily present in the tubercular lesions. This matter, however, requires further elucidation.

Presence and Distribution of the Bacilli. — A few facts may be stated regarding the presence of bacilli, and the numbers in which they are likely to be found in tubercular lesions. On the one hand, they may be very few in number and difficult to find, and on the other hand, they may be present in very large numbers, sometimes forming masses which are easily visible under the low power of the microscope.

They are usually very few in number in chronic lesions, whether these are tubercle nodules with much connective tissue formation or old caseous collections. In caseous material one can sometimes see a few bacilli faintly stained, along with very minute unequally stained granular points, some of which may possibly be spores of the bacilli. Whether they are spores or not, the important fact has been established that tubercular material in which no bacilli can be found microscopically, may be proved, on experimental inoculation into animals, to be still virulent. In such cases the bacilli may be present in numbers so small as to escape observation, or it may be that their spores only are present. In subacute lesions, with well-formed tubercle follicles and little caseation, the bacilli are generally scanty. They are most numerous in acute lesions, especially where caseation is rapidly spreading, for example, in such conditions as caseous catarrhal pneumonia (Fig. 90), acute tuberculosis of the spleen in children, which is often attended with a good deal of rapid caseous change, etc. In acute miliary tuberculosis a few bacilli can generally be found in the centre of the follicles; but here they are often much more scanty than one would expect. The tubercle bacillus is one which not only has compara-

tively slow growth, but retains its form and staining power for a much longer period than most organisms. This is true of the bacilli both in cultures and also in the tissues.

As regards their position in the tissues, the bacilli are usually scattered irregularly or in small groups amongst the cells or granular material. Most of the bacilli lie free, and their occurrence within the cells is relatively uncommon, there

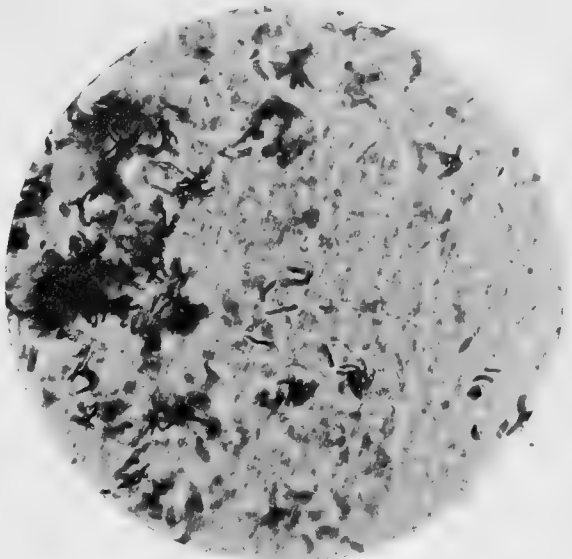

FIG. 90.—Tubercle bacilli in section of human lung in acute phthisis. The bacilli are seen lying singly, and also in large masses to left of field. The pale background is formed by caseous material. Stained with carbol-fuchsin and Bismarck-brown. $\times 1000$.

being in this respect a contrast to what is seen in the lesions in leprosy. Occasionally we find them within the giant-cells, in which they may be arranged in a somewhat radiate manner at the periphery, occasionally also in epithelioid cells and in leucocytes; but these are by no means frequent sites in the human subject.

The above statements, however, apply only to tuberculosis in the human subject, and even in this case there are exceptions. In the ox, on the other hand, the presence of tubercle bacilli within giant-cells is a very common occurrence; and it is also common to find them in considerable numbers scattered irregularly throughout the cellular connective tissue of the lesions, even when there is little or no caseation present (Fig. 91).

In tuberculosis in the horse, and in avian tuberculosis, the numbers of bacilli may be enormous, even in lesions which are not specially acute; and considerable variation both in their

number and in their site is met with in tuberculosis of other animals.

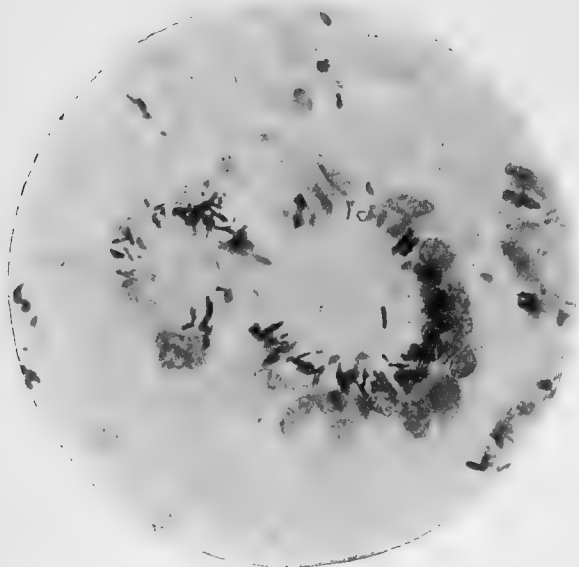

FIG. 91.—Tubercle bacilli in giant-cells, showing the radiate arrangement at the periphery of the cells. Section of tubercular udder of cow. Stained with carbol-fuchsin and Bismarck-brown. $\times 1000$.

In discharges from tubercular lesions which are breaking down, tubercle bacilli are usually to be found. In the sputum of phthisical patients their presence can be demonstrated almost invariably at some period, and sometimes their numbers are very large (for method of

staining see p. 104). Several examinations may, however, require to be made; this should always be done before any conclusion as to the non-tubercular nature of a case is come to. In cases of genito-urinary tuberculosis they are usually present in the urine; but as they are much diluted it is difficult to find them unless a very complete formation of deposit is allowed to take place. This deposit is examined in the same way as the sputum. It is, however, much easier to obtain their separation by means of the centrifuge. If this method is employed, bacilli can usually

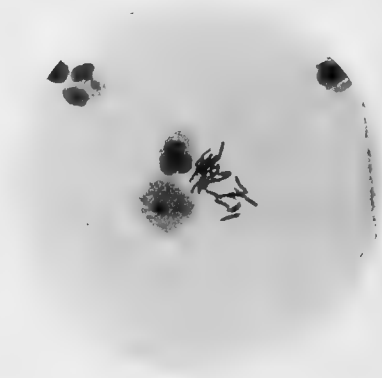

FIG. 92.—Tubercle bacilli in urine; showing one of the characteristic clumps, in which they often occur. Stained with carbol-fuchsin and methylene-blue. $\times 1000$.

be detected, though sometimes their number may be very small ; here, especially, repeated examinations may be necessary. The bacilli often occur in little clumps, as shown in Fig. 92. In tubercular ulceration of the intestine their presence in the fæces may be demonstrated, as was first shown by Koch ; but in this case their discovery is usually of little importance, as the intestinal lesions, as a rule, occur only in advanced stages when diagnosis is no longer a matter of doubt.

Experimental Inoculation. — Tuberculosis can be artificially produced in animals by infection in a great many different ways — by injection of the bacilli into the subcutaneous tissue, into the peritoneum, into the anterior chamber of the eye, into the veins ; by feeding the animals with the bacilli ; and, lastly, by making them inhale the bacilli suspended in the air.

The exact result, of course, varies in different animals and according to the method of inoculation, but we may state generally that when introduced into the tissues of a susceptible animal, the bacilli produce locally the lesions above described, terminating in caseation ; that there occurs a tubercular affection of the neighbouring lymphatic glands, and that lastly there may be a rapid extension of the bacilli to other organs by the blood stream and the production of general tuberculosis. Of the animals used for the purpose, the guinea-pig is most susceptible.

When a guinea-pig is inoculated subcutaneously with tubercle bacilli from a culture, or with material containing them, such as phthisical sputum, a local swelling gradually forms which is usually well marked about the tenth day. This swelling becomes softened and caseous, and may break down, leading to the formation of an irregularly ulcerated area with caseous lining. The lymphatic glands in relation to the parts can generally be found to be enlarged and of somewhat firm consistence, about the end of the second or third week. Later, in them also caseous change occurs, and a similar condition may spread to other groups of glands in turn, passing also to those on the other side of the body. During the occurrence of these changes, the animal loses weight, gradually becomes cachectic, and ultimately dies, sometimes within six weeks, sometimes not for two or three months. *Post mortem*, in addition to the local and glandular changes, an acute tuberculosis is usually present,

the spleen being specially affected. This organ is swollen, and is studded throughout by numerous tubercle nodules, which may be minute and grey, or larger and of a yellowish tint. If death has been long delayed, calcification may have occurred in some of the nodules. Tubercle nodules, though rather less numerous, are also present in the liver and in the lungs, the nodules in the latter organs being usually of smaller size though occasionally in large numbers. The extent of the general infection varies; sometimes the chronic glandular changes constitute the outstanding feature.

Intraperitoneal injection of pure cultures produces a local lesion in the form of an extensive tubercular infiltration and thickening of the omentum, sometimes attended with acute tubercles all over the peritoneum. There is a caseous enlargement of the retroperitoneal and other lymphatic glands, and later there may be a general tuberculosis. *Intravenous* injection produces a typical acute tuberculosis, the nodules being usually more numerous and of smaller size, while death follows more rapidly, the larger the numbers of bacilli injected. Guinea-pigs, when fed with tubercle bacilli, or with sputum or portions of tissue containing them, readily contract an intestinal form of tuberculosis, lesions being present in the lymphoid tissue of the intestines, in the mesenteric glands, and later in the internal organs.

Rabbits are less susceptible than guinea-pigs, and in them the effects of subcutaneous inoculation are very variable; sometimes the lesions remain local, sometimes a general tuberculosis is set up. Otherwise the reactions are much of the same nature. Dogs are much more highly resistant, but tuberculosis can be produced in them by intraperitoneal injection of pure cultures (Koch), or by intravenous injection (Maffucci). In the latter case there results an extensive eruption of minute miliary tubercles. Tuberculosis can also be easily produced in susceptible animals by making them inhale the bacilli.

Varieties of Tuberculosis. 1. *Human and Bovine Tuberculosis.* — Although variations in the virulence of the tubercle bacilli from different sources had been repeatedly observed, no systematic comparison had up till recently been made, and it was generally accepted that all mammalian tuberculosis was due to the same organisms, and in particular that tuberculosis could

be transmitted from the ox to the human subject. The matter has become one of special interest owing to Koch's address at the Tuberculosis Congress in 1901, in which he stated his conclusion that human and bovine tuberculosis are practically distinct, and that if a susceptibility of the human subject to the latter really exists, infection is of very rare occurrence, — so rare that it is not advisable to take any measures against it. Previously to this, Theobald Smith had pointed out differences between mammalian and bovine tubercle bacilli, the most important being that the latter possess a much higher virulence to the guinea-pig, rabbit, and other animals, and in particular that human tubercle bacilli, on inoculation into oxen, produce either no disease or only local lesions without any dissemination. He also found that the bovine bacilli on cultivation grow less vigorously for a time, and tend to be shorter and straighter than the human bacilli. Koch's conclusions were based chiefly on the result of his inoculations in the bovine species with human tubercle bacilli, the result being confirmatory of Smith's, and, secondly, on the supposition that infection of the human subject through the intestine is of very rare occurrence. With regard to this opinion, we must disagree with Koch, as in our experience there is considerable evidence that in young subjects the intestinal canal is a comparatively common path of entrance; and, moreover, the presence of pulmonary lesions does not prove that infection has occurred by inhalation, as in many cases the pulmonary lesions are secondary to those in the bronchial glands, whilst the infection of the cervical or mesenteric glands is of still older standing. There may also be infection of the mesenteric glands without actual lesions in the intestine. That the ox is little susceptible to human bacilli may be accepted, but it does not follow that the converse is true, namely, that the human subject cannot be infected from the bovine species, seeing that bovine tubercle bacilli have been found to have a greater virulence for all animals tested than bacilli from the human subject. Moreover, there are cases, notably those recorded by Ravenel, in which direct inoculation of the human subject with bovine tubercle has occurred. Even if the human subject is little susceptible to bovine tuberculosis, it is quite likely, in view of the large proportion of young subjects exposed to infection, that the number of cases of tuberculosis pro-

duced in this way is by no means small. And furthermore, although the ox is little susceptible to human tubercle bacilli, tuberculosis with general infection has been produced in calves by means of them on more than one occasion. Such a result has been obtained by Ravenel, and also, in this country, by Delépine. There are also facts which go to show that tubercle bacilli cultivated from lesions in young children have a higher degree of virulence for animals than those obtained from adults; that is, they resemble more the bovine tubercle bacilli; this is what one might expect if the bacilli in question had come comparatively recently from the tissues of the ox. As at present the subject is still under investigation in this and other countries, it would not be justifiable to dogmatise, but in the meantime, we see no sufficient reason to depart from the view entertained up to this time, that the tubercle bacilli infecting mammals are of one and the same species, though differences in virulence obtain, and that milk containing tubercle bacilli is a highly important source of infection to the human subject. It may also be added that tubercle bacilli obtained from other mammals than the ox generally correspond more closely, as regards their virulence or inoculation, with bovine than with human bacilli.

2. *Avian Tuberculosis*. — In the tubercular lesions in birds there are found bacilli which correspond in their staining reactions and in their morphological characters with those in mammals, but differences are observed in cultures, and also on experimental inoculation. These differences were first described by Maffucci and by Rivolta, but special attention was drawn to the subject by a paper read by Koch at the International Medical Congress in 1890. Koch stated that he had failed to change the one variety of tubercle bacillus into the other, though he did not conclude therefrom that they were quite distinct species. The following points of difference may be noted.

On glycerin agar and on serum, the growth of tubercle bacilli from birds is more luxuriant, has a moister appearance (Fig. 89.C), and, moreover, takes place at a higher temperature, 43.5° C., than is the case with ordinary tubercle bacilli. Experimental inoculation brings out even more distinct differences. Tubercle bacilli derived from the human subject, for example, when injected into birds, usually fail to produce tuberculosis, whilst those of avian origin very readily do so. Birds are also very susceptible to the disease when fed

with portions of the organs of birds containing tubercle bacilli, but they can consume enormous quantities of phthisical sputum without becoming tubercular (Straus, Wurtz, Nocard). No doubt, on the other hand, there are cases on record in which the source of infection of a poultry yard has apparently been the sputum of phthisical patients. Again, tubercle bacilli cultivated from birds have not the same effect on inoculation of mammals, as ordinary tubercle bacilli. When guinea-pigs are inoculated subcutaneously they usually resist infection, though occasionally a fatal result follows. In the latter case, usually no tubercles visible to the naked eye are found, but numerous bacilli may be present in internal organs, especially in the spleen, which is much swollen. Further, intravenous injection even of large quantities of avian tubercle bacilli, in the case of dogs, leads to no effect, whereas ordinary tubercle bacilli produce acute tuberculosis. [The rabbit, on the other hand, is comparatively susceptible to avian tuberculosis (Nocard).]

There is, therefore, abundant evidence that the bacilli derived from the two classes of animals show important differences, and, reasoning from analogy, we might infer that probably the human subject also would be little susceptible to infection from avian tuberculosis. The question remains, are these differences of a permanent character? The matter seems permanently settled by the experiments of Nocard, in which mammalian tubercle bacilli have been made to acquire all the characters of those of avian origin. The method adopted was to place bacilli from human tuberculosis in small collodion sacs containing bouillon, and then to insert each sac in the peritoneal cavity of a fowl. The sacs were left *in situ* for periods of from four to eight months. They were then removed, cultures were made from their contents, fresh sacs were inoculated from these cultures and introduced into other fowls. In such conditions the bacilli are subjected only to the tissue juices, the wall of the sac being impervious both to bacilli and to leucocytes, etc. After one sojourn of this kind, and still more so after two, the bacilli are found to have acquired some of the characters of avian tubercle bacilli, but are still non-virulent to fowls. After the third sojourn, however, they have acquired this property, and produce in fowls the same lesion as bacilli derived from avian tuberculosis. It therefore appears that the bacilli of avian tuberculosis are not a distinct and permanent species, but a variety which has been modified by growth in the tissues of the bird. Evidently also there are degrees of this modification according to the period of time during which the bacilli have passed from bird to

bird, as in some cases inoculation with tubercle bacilli of avian origin has produced ordinary tubercle nodules in guinea-pigs (Courmont and Dor). We may add that tuberculin prepared from avian tubercle bacilli has the same action as the ordinary tuberculin.

3. *Tuberculosis in the Fish.* — Bataillon, Dubard, and Terre cultivated from a tubercle-like disease in a carp, a bacillus which, in staining reaction and microscopic characters, closely agrees with the tubercle bacillus. The lesion with which it was associated was an abundant growth of granulation tissue in which numerous giant-cells were present. It forms, however, luxuriant growth at the room temperature, the growth being thick and moist like that of avian tubercle bacilli (Fig. 94, *c*). Growth does not occur at the body temperature, though by gradual acclimatisation a small amount of growth has been obtained up to 36° C. Furthermore, the organism appears to undergo no multiplication when injected into the tissues of mammals, and attempts to modify this characteristic have so far been unsuccessful. An interesting fact, however, in connection with this subject is that it has been found possible to alter the conditions of growth of the tubercle bacillus from the human subject so that it flourishes at lower temperature than normal. This has been effected by allowing it to remain for some time in the tissues of the frog, its optimum temperatures of growth after a time being 28°–30° C. and Moeller, by a similar proceeding in the case of the blindworm, produced marked modification, so that the organism no longer grew above 28° C., whereas it flourished at the room temperature. Dubard also states that he has succeeded in making the tubercle bacillus from a human source assume the characters of the bacillus of fish tuberculosis.

All the above facts taken together indicate that tubercle bacilli may become modified in relative virulence and in conditions of growth by sojourn in the tissues of various animals. This modification appears slight, though of definite character in the case of bovine tuberculosis, more distinct in the case of avian tuberculosis, and much more marked, if not permanent, in the case of fish tuberculosis, that is, of course, in their relations to the bacilli from the human subject.

Other Acid-fast Bacilli. — Within recent years a number of bacilli presenting the same staining reaction as the tubercle

bacilli have been discovered. Such bacilli have a comparatively wide distribution in nature, as they have been obtained from various species of grass, from butter and milk, from manure, and from the surfaces of animal bodies. Microscopically, they agree more or less closely with tubercle bacilli, though many are shorter and plumper; many of them show filamentous and branching forms under certain conditions of culture. Moreover, on injection, they produce granulation-tissue modules which may closely resemble tubercles, although on the whole there is a greater tendency to softening and suppuration, and usually they are localised at the site of inoculation. The most important point of distinction is the fact that their multiplication on artificial media is much more rapid, growth usually being visible within forty-eight hours and often within twenty-four hours. Moreover, in most instances, growth occurs at the room temperature. The general character of the cultures in this group is a somewhat irregular layer, often with wrinkled surface, dry or moist in appearance, and varying in tint from white to yellow or reddish brown. The number of such organisms is constantly being added to, but the following may be mentioned as examples:—

Moeller's Grass Bacilli, I. and II.—The former was found in infusions of Timothy-grass (*Phleum pratense*). It is extremely acid-fast, morphologically resembles the tubercle bacillus, and in cultures may show club formation and branching. The lesions produced closely resemble tubercles. The colonies, visible in thirty-six hours, are scale-like and of greyish-white colour. Moeller's bacillus II. was obtained from the dust of a hay-loft. The colonies at first are moist and somewhat tenacious, but afterwards run together, and are of a dull yellowish colour (Fig. 93). The general results of inoculation resemble those of grass bacillus I. but are less marked. Moeller also obtained a similar organism from milk. He also discovered a third acid-fast bacillus which obtained from manure and therefore called the "Mistbacillus" (dung bacillus). This organism has analogous characters, though presenting minor differences. It also has pathogenic effects.

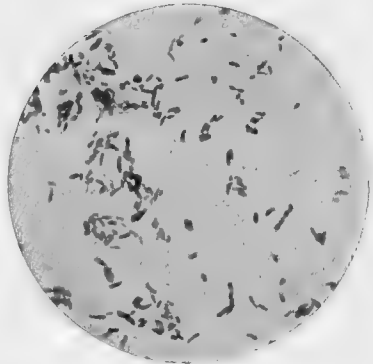

FIG. 93.—Moeller's Timothy-grass bacillus. From a culture on agar. Stained with carbol-fuchsin, and treated with 20 per cent sulphuric acid. $\times 1000$.

Petri and Rabinowitsch independently cultivated an acid-fast bacillus from

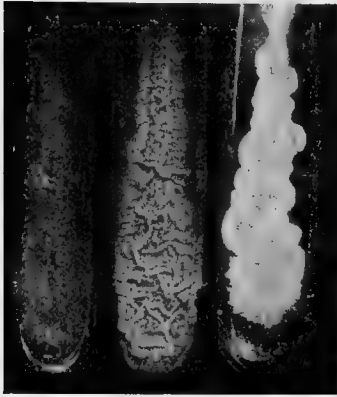

FIG. 94.— Cultures of acid-fast bacilli grown at room temperature.

- (a) Moeller's Timothy-grass bacillus I.
 (b) The Petri-Rabinowitsch butter-bacillus.
 (c) Bacillus of fish tuberculosis.

Smegma Bacillus.— This organism is of importance, as in form and staining reaction it somewhat resembles the tubercle bacillus and may be mistaken for it. It occurs often in large numbers in the smegma præputiale and in the region of the external genitals, especially where there is an accumulation of fatty matter from the secretions. Morphologically it is a slender, slightly curved organism, like the tubercle bacillus but usually distinctly shorter (Fig. 95). Like the tubercle bacillus it stains with some difficulty and resists decolorisation with strong mineral acids. Most observers ascribe the latter fact to the fatty matter with which it is surrounded, and find that if the specimen is treated with alcohol the organism is easily decolorised. Czaplewski, however, who claims to have cultivated it on various media, finds that in culture it shows resistance to decolorisation both with alcohol and with acids, and considers, therefore, that the reaction is not due to the surrounding fatty medium. We have found that in smegma it can be readily decolorised by a minute's exposure to alcohol after the usual treat-

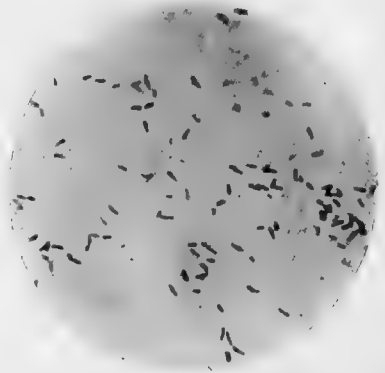

FIG. 95.—Smegma bacilli. Film preparation of smegma. Ziehl-Neelsen stain. $\times 1000$.

¹ For further details on this subject, *vide* Potet, "Études sur les bacilles dites acidophiles." Paris, 1902.

ment with sulphuric acid, or by using the acid-alcohol decoloriser, and thus can be readily distinguished from the tubercle bacillus. We, moreover, believe that minor points of difference in the microscopic appearances of the two organisms are quite sufficient to make the experienced observer suspicious if he should meet with the smegma bacillus in urine, and lead him to apply the decolorising test. Difficulty will only occur when a few scattered bacilli retaining the fuchsin occur.

There doubtless occur in smegma distinct acid-resisting bacterial species. One of these, cultivated by Laser, Czaplewski, and Neufeld, morphologically resembles the diphtheria bacillus, and loses its acid-resisting property in artificial cultures. The bacillus cultivated from smegma by A. Moeller by the aid of human serum is probably identical with the genuine smegma bacillus first described by Tavel, Alvarez, and Matterstock, and resists decolorisation by acids even after prolonged artificial cultivation. This latter bacillus closely resembles the tubercle bacillus in morphology, but it grows at lower temperatures in ordinary media and is non-pathogenic.

Cowie has recently found that acid-fast bacilli are of common occurrence in the secretions of the external genitals, mammæ, etc., in certain of the lower animals, and that these organisms vary in appearance. He considers that the term "smegma bacillus" probably represents a number of allied species.

Validity of the staining reaction.—The question may be asked—Do these results modify the validity of the staining reaction of tubercle bacilli as a means of diagnosis? The source of any acid-fast bacilli in question is manifestly of importance, and it may be stated that when these have been obtained from some source outside the body, or where contamination from without has been possible, their recognition as tubercle bacilli cannot be established by microscopic examination alone. In the case of material coming from the interior of the body, however, sputum, etc., the condition must be looked on as different, and although an acid-fast bacillus (not tubercle) has been found by Rabinowitsch in a case of pulmonary gangrene we have no sufficient data for saying that acid-fast bacilli other than the tubercle bacillus flourish within the tissues of the *human* body except in such rare instances as to be practically negligible. (To this statement the case of the leprosy bacillus is of course an exception.) Accordingly, up till now, the microscopic examination of sputum, etc., cannot be said to have its validity shaken, and we have the results of enormous clinical experience that such examination is practically of unvarying value. Nevertheless the facts established with regard to other acid-fast bacilli must be kept carefully in view, and great care must be exercised when only

one or two bacilli are found, especially if they deviate in their morphological characters from the tubercle bacillus.

Action of Dead Tubercle Bacilli. — The remarkable fact has been established by independent investigators that tubercle bacilli in the dead condition, when introduced into the tissues in sufficient numbers, can produce tubercle-like nodules. Prudden and Hodenpyl, by intravenous injection in rabbits of cultures sterilised by heat, produced in the lungs small nodules in which giant-cells, but no caseation, were occasionally present, and which were characterised by more growth of fibrous tissue than in ordinary tubercle. The subject has been very fully investigated with confirmatory results by Straus and Gamaléia, who find that, if the number of bacilli introduced into the circulation is large, there result very numerous tubercle nodules with well-formed giant-cells, and occasionally traces of caseation. The bacilli can be well recognised in the nodules by the ordinary staining method. In these experiments the bacilli were killed by exposure to a temperature of 115° C. for ten minutes before being injected. Similar nodules can be produced by intraperitoneal injection. Subcutaneous injection, on the other hand, produces a local abscess, but in this case no secondary tubercles are found in the internal organs. Further, in many of the animals inoculated by the various methods a condition of marasmus sets in and gradually leads to a fatal result, there being great emaciation before death. These experiments, which have been confirmed by other observers, show that even after the bacilli are dead they preserve their staining reactions in the tissues for a long time, and also that there are apparently contained in the bodies of the dead bacilli certain substances which act locally, producing proliferative, and to a less extent degenerative, changes, and which also markedly affect the general nutrition. The long period during which the tubercle bacillus, as compared with other organisms, retains even when dead its morphological and staining characters, is a very striking feature. S. Stockman has recently found that an animal inoculated with large numbers of dead tubercle bacilli afterwards gives the tuberculin reaction.

Practical Conclusions. — From the facts above stated with regard to the conditions of growth of the tubercle bacilli, their powers of resistance, and the paths by which they can enter the body and produce disease (as shown by experiment), the man-

ner by which tuberculosis is naturally transmitted can be readily understood. Though the experiments of Sander show that tubercle bacilli can multiply on vegetable media to a certain extent at warm summer temperature, it is doubtful whether all the conditions necessary for growth are provided to any extent in nature. At any rate, the great multiplying ground of tubercle bacilli is the animal body, and tubercular tissues and secretions containing the bacilli are the chief, if not the only, means by which the disease is spread. The tubercle bacilli leave the body in large numbers in the sputum of phthisical patients, and when the sputum becomes dried and pulverised they are set free in the air. Their powers of resistance in this condition have already been stated. As examples of the extent to which this takes place, it may be said that their presence in the air of rooms containing phthisical patients has been repeatedly demonstrated. Williams placed glass plates covered with glycerin in the ventilating shaft of the Brompton Hospital, and after five days found, by microscopic examination, tubercle bacilli on the surface, whilst Klein found that guinea-pigs kept in the ventilating shaft became tubercular. Cornet produced tuberculosis in rabbits by inoculating them with dust collected from the walls of a consumptive ward. Tubercle bacilli are also discharged in considerable quantities in the urine in tubercular disease of the urinary tract, and also by the bowel when there is tubercular ulceration; but, so far as the human subject is concerned, the great means of disseminating the bacilli in the outer world is dried phthisical sputum, and the source of danger from this means can scarcely be overestimated. Every phthisical patient ought to be looked upon as a fruitful source of infection to those around, and should only expectorate on to pieces of rag which are afterwards to be burnt, or into special receptacles which are to be then sterilised either by boiling or by the addition of a 5 per cent solution of carbolic acid.

Another great source of infection is in all probability the milk of cows affected with tuberculosis of the udder. In such cases the presence of tubercle bacilli in the milk can usually be readily detected by centrifugalising it, and then examining the deposit microscopically, or by inoculating an animal with it. As pointed out by Woodhead and others, the milk from cows thus affected is probably the great source of *tabes mesenterica*, which

is so common in young subjects. In these cases there may be tubercular ulceration of the intestine, or it may be absent. Woodhead found that out of 127 cases of tuberculosis in children, the mesenteric glands showed tubercular affection in 100, and that there was ulceration of the intestine in 43. It is especially in children that this mode of infection occurs, as in the adult ulceration of the intestine is rare as a primary affection, though it is common in phthisical patients as the result of infection by the bacilli in the sputum which has been swallowed. There is less risk of infection by means of the flesh of tubercular animals, for, as stated by the recent Tuberculosis Commission, in the first place, tuberculosis of the muscles of oxen being very rare, there is little chance of the bacilli being present in the flesh unless the surface has been smeared with the juice of the tubercular organs, as in the process of cutting up the parts; and in the second place, even when present they will be destroyed if the meat is thoroughly cooked.

We may state, therefore, that the two great modes of infection are by inhalation, and by ingestion, of tubercle bacilli. By the former method the tubercle bacilli will in most cases be derived from the human subject; in the latter, probably from tubercular cows, though inhaled tubercle bacilli may also be swallowed, and contamination of food by tubercular material from the human subject may occur. Both in inhalation and in ingestion, tubercle bacilli may lodge about the pharynx and thus come to infect the pharyngeal lymphoid tissue, tonsils, etc., tubercular lesions of these parts being much more frequent than was formerly supposed. Thence the cervical lymphatic glands may become infected, and afterwards other groups of glands, bones, or joints, and internal organs.

Koch's Tuberculin. — In 1890-91 Koch introduced a substance called "tuberculin," as a curative agent for tubercular affections. He stated that if in a guinea-pig suffering from the effects of a subcutaneous inoculation with tubercle bacilli, a second subcutaneous inoculation of tubercle bacilli was practised in another part of the body, superficial ulceration occurred in the primary tubercular nodule, the wound healed, and the animal did not succumb to tuberculosis. This reaction was further studied by means of the above-mentioned tuberculin, which consisted of a concentrated glycerin bouillon culture of

tubercle in which the bacilli had been killed by heat. It contains the dead and often macerated bacilli, the substances indestructible by boiling which existed in these bacilli, non-volatile products formed by them from the food material when alive, and the concentrated remains of the bouillon and glycerin. The injection of .25 c.c. of tuberculin into a healthy man causes, in from three to four hours, malaise, tendency to cough, laboured breathing, and moderate pyrexia; all of which pass off in twenty-four hours. The injection (the site of the injection being quite unimportant), however, of .01 c.c. into a tubercular person gives rise to similar symptoms, but in a much more aggravated form, and in addition there occurs around any tubercular focus great inflammatory reaction, resulting in necrosis and a casting off of the tubercular mass, when this is possible, as for instance in the case of lupus. The bacilli are, it was shown, not killed in the process.

Koch's theory of the action of the substance was that the tubercle bacillus ordinarily secretes a body having a necrotic action on the tissues. When this is injected into a tubercular patient, the proportion present round a tubercular focus is suddenly increased, inflammatory reaction takes place around, and necrosis of the spreading margin occurs very rapidly, the material containing the living or dead bacilli being thrown off *en masse* instead of being disintegrated piecemeal. It appears, however, that this explanation may not be the true one, for, on the one hand, other substances besides products of the tubercle bacillus may give rise to similar effects in tubercular animals, and, on the other, a similar reaction can take place in other diseases where there is locally in the body a deposit of new tissue. Matthes has, for instance, found that albumoses and peptones isolated from the ordinary peptic digestion of various albumins give the same reaction in tubercular guinea-pigs. The injection of milk, lactic acid, ricin, all give a similar result. Before the discovery of tuberculin, Gamaléia had found that tubercular animals were very susceptible to the toxins of the vibrio Metchnikovi, and later Metchnikoff found that a similar susceptibility existed towards the toxins of the bacillus of fowl cholera.

The hopes which the introduction of tuberculin raised that a curative agent against tuberculosis had been discovered were soon found not to be justified. It was very difficult to see how the necrosed material which it produced and which contained the still living bacilli could be got rid of either naturally, as would be necessary in the case of a small tubercular deposit in a lung or a lymphatic gland, or artificially, as in a complicated joint-cavity where surgical interference could be undertaken.

Not only so, but the ulceration which might be the sequel of the necrosis appeared to open a path for fresh infection. Soon facts were reported which justified these criticisms. Cases where rapid acute tubercular conditions ensued on the use of tuberculin were reported, and in a few months the treatment was practically abandoned. The conditions in guinea-pigs on which the discovery was based have since been found not to be of universal occurrence.

The Toxins of the Tubercle Bacillus. — The fact that tuberculin was a powerfully toxic agent stimulated the study of its constituents in the belief that among these the toxins of the tubercle bacillus were present. It was found to contain several albumoses, alkaloids, extractives, and inorganic salts. The albumoses originated a tuberculin reaction in tubercular guinea-pigs, but as has been stated this is also true of ordinary albumoses. It may be stated that the tuberculin reaction is obtained with the products of the growth of the bacillus in a non-proteid medium. But further, a similar reaction has taken place when tuberculin has been injected into persons suffering from diseases other than tubercle, *e.g.* cancer, sarcoma, syphilis. Further investigations on this subject are thus required. The toxins of tubercle are thus possibly not of the nature of albumoses. Of their real nature we are still ignorant. From what is known, it is possible that they do not to any great extent diffuse out into the culture media. It has been found that if tubercle cultures are filtered germ-free, the filtrate does not give such a marked tuberculin reaction as the unfiltered fluid. Maragliano has found that such a fluid, however, causes in animals lowering of temperature and sweating, and further that if it is heated at 100° C. it now gives a much more marked tuberculin reaction. It is thus possible that more than one toxic body may be formed by the tubercle bacillus, but from what has been said it will be realised that to consider the occurrence of the tuberculin reaction as indicating the presence of the products of the tubercle bacillus is not at present justifiable.

The Use of Tuberculin in the Diagnosis of Tuberculosis in Cattle. — This is now the chief use to which tuberculin is put. In cattle, tuberculosis may be present without giving rise to apparent symptoms. It is thus important from the point of view of human infection that an early diagnosis should be made.

The method is applied as follows. The animals are kept twenty-four hours in their byres and the temperature is taken every three hours, from four hours before the injection till twenty-four after. The average temperature in cattle is 102.2° F.; 30 to 40 centigrammes of tuberculin are injected, and if the animal be tubercular the temperature rises 2° or 3° F. in eight to twelve hours and continues elevated for ten to twelve hours. Bang, who has worked most at the subject, lays down the principle that the more nearly the temperature approaches 104° F. the more reason for suspicion is there. He gives a record of 280 cases where the value of the method was tested by subsequent *post-mortem* examination. He found that with proper precautions the error was only 3.3 per cent. The method is largely practised on the Continent, and ought to be more widely applied.

Koch's New Tuberculin. — Koch in 1897 published the results of further researches on tuberculosis. These consisted (1) of an attempt to immunise animals against the tubercle bacillus by employing its intracellular toxins; (2) of trying to utilise such an immunisation to aid the tissues of an animal already attacked with tubercle the better to combat the effects of the bacilli. The method of obtaining the intracellular toxins was as follows. Bacilli from young virulent cultures were dried *in vacuo*, and disintegrated with an agate pestle and mortar, treated with distilled water and centrifugalised. The clear fluid was decanted, and is called by Koch "tuberculin O." It has the properties of the ordinary tuberculin. The remaining deposit was again dried, bruised, treated with water and centrifugalised, the clear fluid being again decanted, and this process was repeated with successive residues till no residue remained. These fluids put together constitute what Koch calls "tuberculin R." It is said to contain the substances present in the bacilli, which are insoluble in glycerin and only produce a tuberculin reaction in large doses. When injected into animals in repeated and increasing doses, $\frac{1}{500}$ mgrm. being the initial dose, it is said to produce immunity against the original extract, against "tuberculin O," and against living and virulent tubercle bacilli; but regarding this, opinions differ. Cases of early phthisis in man and of lupus have been treated with "tuberculin R," no dose being given which raises the

temperature more than $.5^{\circ}$ F. Though cases of lupus have been recorded in which improvement has taken place, little success has attended the use of this substance as a remedial agent.

Immunisation against the Tubercle Bacillus : Anti-tubercular Serum. — Tuberculosis differs from other diseases, against which animals can be immunised, in that there is no evidence that one attack protects against a second. Further, we have no means of obtaining truly attenuated tubercle bacilli. Many attempts at immunisation have, however, been made. It has been thought by some that the tubercle bacilli from so-called scrofulous glands are less virulent than those say from phthisis, but apparently here sufficient attention has not been paid to the difference of the numbers of bacilli injected in each case, and this appears to be a very important point. Experiments have also been brought forward which appear to show that the injection of bacilli from avian tuberculosis could protect the dog against bacilli derived from man. But these are not yet conclusive. Further, many attempts have been made at immunisation against the tubercle bacillus by the employment of its toxic products. The most successful have been those of Maragliano. We have seen that this author distinguishes between the toxic bodies contained in the bodies of the bacilli (which withstand, unchanged, a temperature of 100° C.) and those secreted into the culture fluid (which are destroyed by heat). The substance used by him for immunising his animals consists of three parts of the former and one of the latter. The animals employed are the dog, the ass, the horse. The serum obtained from these is capable of protecting healthy animals against an otherwise fatal dose of tuberculin, but very little importance can be attached to this result. Maragliano does not appear to have studied the effects of this serum on tubercular animals, but it has been tried in a great number of cases of human tuberculosis, 2 c.c. being injected subcutaneously every two days. Improvement is said to have taken place in a certain proportion, especially of mild non-febrile cases.

Methods of Examination. — (1) *Microscopic Examination.* — Tuberculosis is one of the comparatively few diseases in which a diagnosis can usually be definitely made by microscopic examination alone. In the case of sputum, one of the yellowish frag-

ments which are often present ought to be selected; dried films are then prepared in the usual way and stained by the Ziehl-Neelsen method (p. 104). In the case of urine or other fluids a deposit should first be obtained by centrifugalising a quantity in a test-tube, or by allowing the fluids to stand in a tall glass vessel (an ordinary burette is very convenient). Film preparations are then made with the deposit and treated as before. If a negative result is obtained in a suspected case, repeated examination should be undertaken. To avoid risk of contamination with the smegma bacillus the meatus of the urethra should be cleansed and the urine first passed should be rejected, or the urine may be drawn off with a sterile catheter. As stated above it is only exceptionally that difficulty will arise to the experienced observer from this cause. (For points to be attended to, *vide* p. 257.)

(2) *Inoculation.*—The guinea-pig is the most suitable animal. If the material to be tested is a fluid it is injected subcutaneously or into the peritoneum; if solid or semi-solid it is placed in a small pocket in the skin or it may be thoroughly broken up in sterile water or other fluid and the emulsion injected. By this method, material in which no tubercle bacilli can be found microscopically may sometimes be shown to be tubercular.

(3) *Cultivation.*—Owing to the difficulties this is usually quite impracticable as a means of diagnosis, and it is also unnecessary. The best method to obtain pure cultures is to produce tuberculosis in a guinea-pig by inoculation with tubercular material, and to kill the animal after a period of four or five weeks. Then with portions of a tubercular organ, *e.g.* the spleen, tubes of solidified blood serum (preferably that of the dog, obtained aseptically and coagulated by an exposure of three hours to a temperature of 75° C. in the slanting position) are to be inoculated under the strictest aseptic precautions. The portions of tissue should be moderately small, and should be gently rubbed over the surface of the medium and brought to rest. The tubes are then to be incubated at 37° C. for a week or ten days, when the pieces of tissue are again to be rubbed over the surface of the medium, turned over, and once more incubated for a similar period of time, when growth may possibly be seen in isolated spots on the surface of the serum or ex-

tending beyond the edges of the introduced tissue. It is to be recommended that the tubes of serum be kept in the horizontal position during incubation, lest on account of the low density of the medium, the upright position should damage the extent of surface necessary for growth.

(4) *Agglutination.*—Within the last three years Arloing and Courmont announced that they had been able to obtain agglutination of the tubercle bacillus with the blood serum of tuberculous patients, in a manner analogous to that introduced by Gruber and Widal in the diagnosis of typhoid fever. The technique is full of difficulties and the reaction is not often obtained in dilutions of 1 in 25, but usually much lower, as 1 in 10, 1 in 15. C. Fraenkel, Neisser, Dieudonné, Beck, and Rabinowitsch have shown that the reaction is unreliable, being often absent in patients undoubtedly tuberculous. And quite recently Koch has demonstrated that the reaction may appear in non-tuberculous cases in dilutions of 1 in 25, or in one case (muscular rheumatism) as high as 1 in 50, and he fully agrees with the others above cited that the reaction is too uncertain to be of any practical value. Furthermore, it is of interest that serum which agglutinates tubercle bacilli will agglutinate also many of the other acid-resisting bacilli which for this and other reasons may be regarded as allied to B. tuberculosis.

CHAPTER XI.

LEPROSY.

LEPROSY is a disease of great interest, alike in its clinical and pathological aspects; whilst from the bacteriological point of view also, it presents some striking peculiarities. The invariable association of large numbers of characteristic bacilli with all leprous lesions is a well-established fact, and yet, so far, attempts to cultivate the bacilli outside the body, or to produce the disease experimentally in animals, have been attended with failure. Leprosy, so far as is known, is a disease which is confined to the human subject, but it has a very wide geographical distribution. It occurs in certain parts of Europe—Norway, Russia, Greece, etc., but is commonest in Asia, occurring in Syria, Persia, etc. It is prevalent in Africa, being especially found along the coast, in the Pacific Islands, in the warmer parts of North and South America, and also to a small extent in the northern part of North America. In all these various regions the disease presents the same general features, and the study of its pathological and bacteriological characters, wherever such has been carried on, has yielded similar results.

Pathological Changes.—Leprosy is characteristically a chronic disease, in which there is a great amount of tissue change, with comparatively little necessary impairment of the general health. In other words, the local effects of the bacilli are well marked, often extreme, whilst the toxic phenomena are proportionately at a minimum.

There are two chief forms of leprosy. The one, usually called the tubercular form, — *lepra tuberosa* or *tuberculosa*, — is characterised by the growth of granulation tissue in a nodular form or as a diffuse infiltration in the skin, in mucous membranes, etc., great disfigurement often resulting. In the other form, the anæsthetic, — maculo-anæsthetic of Hansen and Looft, — the outstanding changes are in the nerves, with consequent anæsthesia, paralysis of muscles, and trophic disturbances.

In the *tubercular* form the disease usually starts with the appearance of erythematous patches attended by a small amount of fever, and these are followed by the development of small nodular thickenings in the skin, especially of the face, of the backs of hands and feet, and of the extensor aspects of arms and legs. These nodules enlarge and produce great distortion of

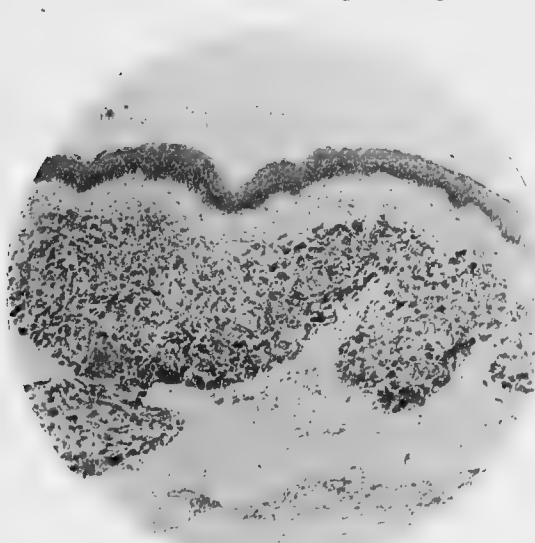

FIG. 96.— Section through leprosy skin, showing the masses of cellular granulation tissue in the cutis; the dark points are clumps of bacilli deeply stained.

Paraffin section; Ziehl-Neelsen stain. $\times 80$.

the surface, so that, in the case of the face, an appearance is produced which has been described as "leonine." The thickenings occur chiefly in the cutis (Fig. 96), to a less extent in the subcutaneous tissue. The epithelium often becomes stretched over them, and an oozing surface becomes developed, or actual ulceration may occur. The cor-

nea and other parts of the eye, the mucous membrane of the mouth, larynx, and pharynx, may be the seat of similar nodular growths. Internal organs, especially the spleen, liver, and testicles, may become secondarily affected. In all situations the change is of the same nature, — a sort of chronic inflammatory condition attended by abundant formation of granulation tissue, nodular or diffuse in its arrangement. In this tissue a large proportion of the cells are of rounded or oval shape, like hyaline leucocytes; a number of these may be of comparatively large size, and may show vacuolation of their protoplasm and a vesicular type of nucleus. These are often known as "lepra cells." Amongst the cellular elements there is a varying amount of stroma, which in the earlier lesions is scanty and

delicate, but in the older lesions may be very dense. Periarthritis is a common change, and very frequently the superficial nerves become involved in the nodules and undergo atrophy. The tissue in the leprous lesions is comparatively vascular, at least when young, and, unlike tubercular lesions, never shows caseation. Some of the lepra cells may contain several nuclei, but we do not meet with cells resembling in their appearance tubercle giant-cells, nor does an arrangement like that in tubercle follicles occur.

In the *anæsthetic* form the lesion of the nerves is the outstanding feature. These are the seat of diffuse infiltrations which lead to the destruction of the nerve fibres. In the earlier stages, in which the chief symptoms are pains along the nerves, there occur patches on the skin, often of considerable size, the margins of which show a somewhat livid congestion. Later, these patches become pale in the central parts, and the periphery becomes pigmented. There then follow remarkable series of trophic disturbances in which the skin, muscles, and bones are especially involved. The skin often becomes atrophied, parchment-like, and anæsthetic; frequently pemphigoid bullæ or other skin eruptions occur. The bones become atrophied, and, owing to the irregular affection of the muscles, great distortion of the extremities may result. Partly owing to injury to which the feet and arms are liable from their anæsthetic condition, and partly owing to trophic disturbances, necrosis and separation of parts are liable to occur. In this way great distortion results. The lesions in the nerves are of the same nature as those described above, that is, they are the result of a chronic inflammatory process, but the granulation tissue is less in amount, and has a greater tendency to undergo cicatricial contraction. This is to be associated with the fact that the bacilli are present in fewer numbers.

Bacillus of Leprosy.—This bacillus was first observed in leprous tissues by Hansen in 1871, and was the subject of several communications by him in 1874 and later. Further researches, first by Neisser in 1879, and afterwards by observers in various parts of the world, agreed in their main results, and confirmed the accuracy of Hansen's observations. The bacilli as seen in scrapings of ulcerated leprous nodules, or in sections, have the following characters. They are thin rods of practically the same

size as tubercle bacilli, which they also resemble both in appearance and in staining reaction. They are straight or slightly curved, and usually occur singly, or two may be attached end to end; but they do not form chains. When stained they may have a uniform appearance, or the protoplasm may be frag-

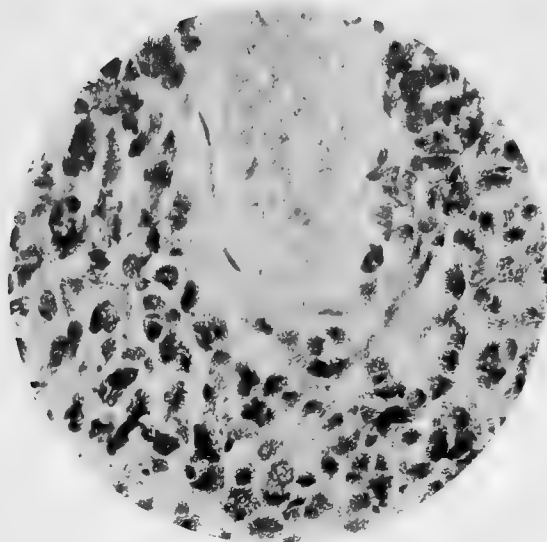

FIG. 97.—Superficial part of leprosy skin; the cells of the granulation tissue appear as dark patches, owing to the deeply stained bacilli in their interior. In the upper part a process of epithelium is seen.

Paraffin section; stained with carbol-fuchsin and Bismarck-brown. $\times 500$.

mented, so that they appear like short rows of cocci. They often appear tapered at one or both extremities; occasionally there is slight club-like swelling. Degenerated and partially broken down forms are also seen. They take up the basic aniline stains rather more readily than tubercle bacilli, but in order to stain them deeply a powerful stain,

such as carbol-fuchsin, is necessary. When stained, they strongly resist decolorising, though they are more easily decolorised than tubercle bacilli. The best method is to stain with carbol-fuchsin as for tubercle bacilli, but to use a weaker solution of sulphuric acid, say 5 per cent, in decolorising; in the case of films and thin sections, decolorising with such a solution for fifteen seconds is usually sufficient. Thereafter the tissues are coloured by a contrast stain, such as a watery solution of methylene-blue (*vide* p. 104). The bacilli are also readily stained by Gram's method. Regarding the presence of spores practically nothing is known, though some of the unstained or stained points may be of this nature. We have, however, no means of testing their powers of resistance. Leprosy bacilli are non-motile.

Position of the Bacilli. — They occur in enormous numbers in the leprous lesions, especially in the tubercular form. In fact, so numerous are they that the granulation tissue in sections, properly stained as above, presents quite a red colour under a low power of the microscope. The bacilli occur for the most part within the protoplasm of the round cells of the granulation tissue, and are often so numerous that the structure of the cells is

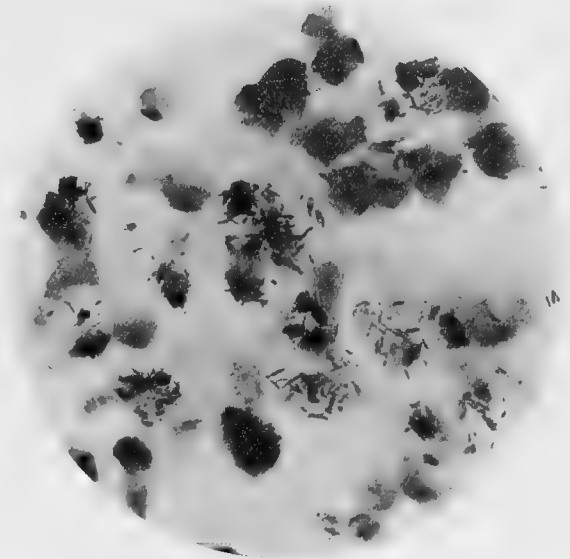

FIG. 98. — High-power view of portion of leprous nodule, showing the arrangement of the bacilli within the cells of the granulation tissue.

Paraffin section; stained with carbol-fuchsin and methylene-blue.
 × 1100.

quite obscured (Fig. 97). They are often arranged in bundles which contain several bacilli lying parallel to one another, though the bundles lie in various directions (Fig. 98). The appearance thus presented by the cells filled with bacilli is very characteristic. Bacilli are also found free in the lymphatic spaces, but the greater number are undoubtedly contained within the cells. They are also found in spindle-shaped connective-tissue cells, in endothelial cells, and in the walls of blood-vessels. They are for the most part confined to the connective tissue, but a few may be seen in the hair follicles and glands of the skin. Occasionally one or two may be found in the surface epithelium, where they probably have been carried by leucocytes, but this position is, on the whole, exceptional. They also occur in large numbers in the lymphatic glands associated with the affected parts. In the internal organs—liver, spleen, etc., when leprous lesions are present, the bacilli

are also found, though in relatively smaller numbers. In the nerves in the anæsthetic form they are comparatively few, and in the sclerosed parts it may be impossible to find any. There are few also in the skin patches referred to above as occurring in this form of the disease.

Their spread is chiefly by the lymphatics, though distribution by the blood stream also occurs. They have been said to be found in the blood during the presence of fever and the eruption of fresh nodules, and they have also been observed in the blood-vessels *post mortem*, being chiefly contained within leucocytes. Recent observations (*e.g.* those of Doutrelepont and Wolters) show that the bacilli may be more widely spread throughout the body than was formerly supposed. A few may be detected in some cases in various organs which show no structural change, especially in their capillaries. The brain and spinal cord are practically exempt.

Relations to the Disease. — Attempts to cultivate the leprosy bacilli outside the body have so far been unsuccessful. From time to time announcements of successful cultivations have been made, but one after another has proved to be erroneous. A similar statement may be made with regard to experiments on animals. If a piece of leprosy tissue be introduced subcutaneously in an animal, such as the rabbit, a certain amount of induration may take place around it, and the bacilli may be found unchanged in appearance weeks or even months afterwards, but no multiplication of the organisms occurs. The only exception to this statement is afforded by the experiments of Melcher and Orthmann, who inoculated the anterior chamber of the eye of rabbits with leprosy material, the inoculation being followed by an extensive growth of nodules in the lungs and internal organs, which they affirmed contained leprosy bacilli. It has been questioned, however, by several authorities whether the organisms in the nodules were really leprosy bacilli, and up to the present we cannot say that there is any satisfactory proof that the disease can be transmitted to any of the lower animals.

It would also appear that the disease is not readily inoculable in the human subject. In a well-known case described by Arning, a criminal in the Sandwich Islands was inoculated in several parts of the body with leprosy tissue. Two or three

years later, well-marked tubercular leprosy appeared and led to a fatal result. This experiment, however, is open to the objection, that the individual before inoculation had been exposed to infection in a natural way, having been frequently in contact with lepers. In other cases inoculation experiments on healthy subjects, and inoculations in other parts of leprosy individuals have given negative results. It has been supposed by some that the failure to obtain cultures and to reproduce the disease experimentally may be partly due to the bacilli in the tissues being dead. That many of the leprosy bacilli are in a dead condition is quite possible, in view of the long period during which dead tubercle bacilli introduced into the tissues of animals retain their form and staining reaction. There is also the fact that from time to time in leprosy subjects there occur attacks of a certain amount of fever, which are followed by a fresh outbreak of nodules, and it would appear that especially at these times multiplication of the bacilli takes place more actively.

The facts stated with regard to cultivation and inoculation experiments go to distinguish the leprosy bacillus all the more strongly from other organisms. Some have supposed that leprosy is a form of tubercle, or tubercle modified in some way, but for this there appears to us to be no evidence. Both from the pathological and from the bacteriological point of view the diseases are distinct. It should also be mentioned that tubercle is a not uncommon complication in leprosy subjects, in which case it presents the ordinary characters.

The mode by which leprosy is transmitted has been the subject of great controversy, and is one on which authorities still hold opposite opinions. Some consider that it is a hereditary disease, or at least that it is transmitted from a parent to the offspring; others again that it is transmitted by direct contact. There appears to be no doubt, however, that on the one hand leprosy subjects may bear children free from leprosy, and that, on the other hand, healthy individuals entering a leprosy district may contract the disease, though this rarely occurs. Of the latter occurrence there is the well-known instance of Father Damien, who contracted leprosy after going to the Sandwich Islands. In view of all the facts there can be little doubt that leprosy in certain conditions may be transmitted

by direct contact, though its contagiousness is not of a high order.

Methods of Diagnosis. — Film preparations should be made with the discharge from any ulcerated nodule which may be present, or from the scraping of a portion of excised tissue, and should be stained as above described. The presence of large numbers of bacilli situated within the cells and giving the staining reaction of leprosy bacilli, is conclusive. It is more satisfactory, however, to make microscopic sections through a portion of the excised tissue, when the structure of the nodule and the arrangement of the bacilli can be readily studied. The points of difference between leprosy and tubercle have already been stated, and in most cases there is really no difficulty in distinguishing the two conditions.

CHAPTER XII.

GLANDERS AND RHINOSCLEROMA.

GLANDERS.

THE bacillus of glanders (*bacillus mallei*; Fr. *bacille de la morve*; Ger. *Rotzbacillus*) was discovered by Löffler and Schütz, the announcement of this discovery being made towards the end of 1882. They not only obtained pure cultures of this organism from the tissues in the disease, but by experiments on horses and other animals conclusively established its causal relationship. These have been fully confirmed. The same organism has also been cultivated from the disease in the human subject, first by Weichselbaum in 1885, who obtained it from the pustules in a case of acute glanders in a woman, and by inoculation of animals obtained results similar to those of Löffler and Schütz.

Within recent years a substance, *mallein*, has been obtained from the cultures of the glanders bacillus by a method similar to that by which tuberculin was prepared, and has been found to produce corresponding effects in animals suffering from glanders to those produced by tuberculin in tuberculous animals.

The Natural Disease.—Glanders chiefly affects the equine species—horses, mules, and asses. Horned cattle, on the other hand, are quite immune, whilst goats and sheep occupy an intermediate position, the former being rather more susceptible and occasionally suffering from the natural disease. It also occurs in some of the carnivora—cats, lions and tigers in menageries, which animals are infected from the carcasses of animals affected with the disease. Many of the small rodents are highly susceptible to inoculation (*vide infra*).

Glanders is also found in man as the result of direct inoculation on some wound of the skin or other part by means of the discharges or diseased tissues of an animal affected, and hence is commonest amongst grooms and others whose work brings them into contact with horses.

In horses the lesions are of two types, to which the names "glanders" proper and "farcy" have been given, though both may exist together. In glanders proper the septum nasi and adjacent parts are chiefly affected, there occurring in the mucous membrane nodules which are at first firm and of somewhat translucent grey appearance. The growth of these is attended usually by inflammatory swelling and profuse catarrhal discharge. Afterwards the nodules soften in the centre, break down, and give rise to irregular ulcerations. Similar lesions, though in less degree, may be found in the respiratory passages. Associated with these lesions there is usually implication of the lymphatic glands in the neck, mediastinum, etc.; and there may be in the lungs, spleen, liver, etc., nodules of the size of a pea or larger, of greyish or yellow tint, firm or somewhat softened in the centre, and often surrounded with a congested zone. The term "farcy" is applied to the affection of the superficial lymphatic vessels and glands, which is specially seen where infection takes place through an abrasion of the skin, such as is often produced by the rubbing of the harness. The lymphatic vessels become irregularly thickened, so as to appear like knotted cords, and the associated lymphatic glands become enlarged and firm, though suppurative softening usually follows, and there may be ulceration. These thickenings are often spoken of as "farcy buds" and "farcy pipes." In farcy also, secondary nodules may occur in internal organs and the nasal mucous membrane. In the ass the disease runs a more acute course than in the horse.

In man the disease is met with in two forms, an acute and a chronic; though intermediate forms also occur, and chronic cases may take on the characters of the acute disease. The site of inoculation is usually on the hand or arm, by means of some scratch or abrasion, or possibly along a hair follicle, sometimes on the face, and occasionally on the mucous membrane of the mouth, nose, or eye. In the *acute* form there appears at the site of inoculation inflammatory swelling, attended usually with spreading redness, and the lymphatics in relation to the part also become inflamed, the appearances being those of a "poisoned wound." These local changes are soon followed by marked constitutional disturbance, and by an eruption on the surface of the body, at first papular and afterwards pustular, and later there may form in the subcutaneous tissue and muscles larger masses which soften and suppurate, the pus being often mixed with blood; suppuration may occur also in the joints. In some cases the nasal mucous membrane may be secondarily infected, and thence inflammatory swelling may spread to the tissues of the face; in others it remains free. The patient usually dies in two or three weeks, sometimes sooner, with the symptoms of rapid pyæmia. In addition to the lesions mentioned there may be foci, usually

suppurative, in the lungs (attended often with pneumonic consolidation), in the spleen, liver, bone-marrow, salivary glands, etc. In the *chronic* form the local lesion results in the formation of an irregular ulcer with thickened margins and sanious, often foul, discharge. The ulceration spreads deeply as well as superficially, and the thickened lymphatics also have a great tendency to ulcerate, though the lymphatic system is not so prominently affected as in the horse. Deposits may form in the subcutaneous tissue and muscles, and the mucous membrane may become affected. The disease may run a very chronic course, lasting for months, and recovery may occur, though, on the other hand, the disease may take on a more acute character and rapidly become fatal.

The Glanders Bacillus. — *Microscopical Characters.* — The glanders bacilli are minute rods, straight or slightly curved, with rounded ends, and about the same length as tubercle bacilli, but distinctly thicker (Fig. 99). They show, however, considerable variations in size and in appearance, and their protoplasm is often broken up into a number of deeply-stained portions with unstained intervals between. These characters are seen both in the tissues and in cultures, but, as in the case of many organisms, irregularities in form and size are more pronounced in cultures (Fig. 100); short filamentous forms 8 to 12 μ in length are sometimes met with, but these are on the whole rare. The organism is non-motile, but brownian motion is marked.

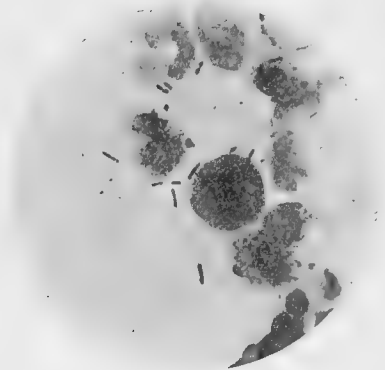

FIG. 99. — Glanders bacilli amongst broken-down cells. Film preparation from a glanders nodule in a guinea-pig. Stained with weak carbol-fuchsin. $\times 1000$.

In the tissues, the bacilli usually occur irregularly scattered amongst the cellular elements; a few may be contained within leucocytes and connective-tissue corpuscles, but the position of most is extracellular. They are most abundant in the acute lesions, in which they may be found in considerable numbers; but in the chronic nodules, especially when softening has taken

place, they are few in number, and it may be impossible to find any in sections. They have less powers of persistence, and disappear in the tissues much more quickly, than tubercle bacilli.

There has been dispute as to whether or not they contain

spores. Some consider certain of the unstained portions to be of that nature, and it has been claimed that these can be stained by the method for staining spores (Rosenthal). But it is very doubtful that such is the case; the appearances correspond rather with mere breaks in the protoplasm, such as are met with in many other bacilli which do not contain spores, and the comparatively low powers of resistance of glanders bacilli containing these so-called spores is strongly against their

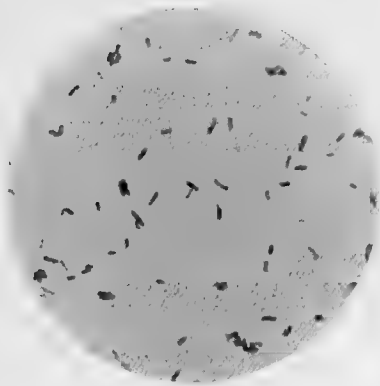

FIG. 100.—Glanders bacilli from a pure culture on glycerin agar. Stained with carbolfuchsin and partially decolorised to show segmentation of protoplasm. $\times 1000$.

being of that nature. The power of resistance is after all the important practical point.

Staining.—The glanders bacillus differs widely from the tubercle bacillus in its staining reactions. It stains with simple watery solutions of the basic stains, but somewhat faintly (better when an alkali or a mordant, such as carbolic acid, is added), and even when deeply stained it readily loses the colour when a decolorising agent such as alcohol is applied. We have obtained the best results by carbol-thionin-blue (p. 101), and we prefer to dehydrate by the aniline-oil method. In film preparations of fresh glanders nodules the bacilli can be readily found by staining with any of the ordinary combinations, *e.g.* carbol-thionin-blue or weak carbol-fuchsin. By using a stain of suitable strength no decolorising agent is necessary, the film being simply washed in water, dried, and mounted. Gram's method is quite inapplicable, the glanders bacilli rapidly losing the stain in the process.

Cultivation.—(For the methods of separation, *vide infra*.) The glanders bacillus grows readily on most of the ordinary media, but a somewhat high temperature is necessary, growth taking place most rapidly at 35° to 37° C. Though a certain

amount of growth occurs down to 21° C., a temperature above 25° C. is always desirable.

On *agar* and *glycerin agar* in stroke-cultures growth appears along the line as a uniform streak of greyish-white colour and somewhat transparent appearance, with moist-looking surface, and when touched with a needle is found to be of rather slimy consistence. Later it spreads laterally for some distance, and the layer becomes of slightly brownish tint. On *serum* the growth is somewhat similar but more transparent, the separate colonies being in the form of round and almost clear drops. In sub-cultures on these media at the body temperature growth is visible within twenty-four hours, but when fresh cultures are made from the tissues it is not visible till the second day. Serum, however, is much more suitable for cultivating from the tissues than the agar media; on the latter it is sometimes difficult to obtain growth.

In *broth*, growth forms at first a uniform turbidity, but soon settles to the bottom, and after a few days forms a pretty thick flocculent deposit of slimy and somewhat tenacious consistence.

On *potato* at 30° to 37° C. the glanders bacillus flourishes well and produces a characteristic appearance; incubation at a high temperature, however, being necessary. Growth proceeds rapidly, and on the third day has usually formed a transparent layer of slightly yellowish tint, like clear honey in appearance. On subsequent days, the growth still extends and becomes darker in colour and more opaque, till about the eighth day it has a reddish-brown or chocolate tint, while the potato at the margin of the growth often shows a greenish-yellow staining. The characters of the growth on potato along with the microscopical appearances are quite sufficient to distinguish the glanders bacillus from every other known organism (sometimes the cholera organism and the *B. pyocyaneus* produce a somewhat similar appearance, but they can be readily distinguished by their other characters). Potato is also a suitable medium for starting cultures from the tissues; in this case minute transparent colonies become visible on the third day and afterwards present the appearances just described.

Powers of Resistance. — The glanders bacillus is not killed at once by drying, but usually loses its vitality after fourteen days in the dry condition, though sometimes it lives longer. It is not

quickly destroyed by putrefaction, having been found to be still active after remaining two or three weeks in putrefying fluids. In cultures the bacilli retain their vitality for three or four months, if, after growth has taken place, they be kept at the temperature of the room; on the other hand, they are often found to be dead at the end of two weeks when kept constantly at the body temperature. They have comparatively feeble resistance to heat and antiseptics. Löffler found that they were killed in ten minutes in a fluid kept at 55° C., and in from two to three minutes by a 5 per cent solution of carbolic acid. Boiling water and the ordinarily used antiseptics are very rapid and efficient disinfectants.

We may summarise the characters of the glanders bacillus by saying that in its morphological characters it resembles somewhat the tubercle bacillus, but is thicker, and differs widely from it in its staining reactions. For its cultivation the higher temperatures are necessary, and the growth on potato presents most characteristic features.

Experimental Inoculation. — In horses subcutaneous injection of the glanders bacillus in pure culture reproduces all the important features of the disease. This fact was established at a comparatively early date by Löffler and Schütz, who, after one doubtful experiment, successfully inoculated two horses in this way, the cultures used having been grown for several generations outside the body. In a few days swellings formed at the sites of inoculation, and later broke down into unhealthy-looking ulcers. One of the animals died; after a few weeks the other, showing symptoms of cachexia, was killed. In both animals, in addition to ulcerations on the surface with involvement of the lymphatics, there were found *post mortem*, nodules in the lungs, softened deposits in the muscles, and also affection of the nasal mucous membrane, — nodules, and irregular ulcerations. The ass is even more susceptible than the horse, the disease in the former running a more rapid course, but with similar lesions. The ass can be readily infected by simple scarification and inoculation with glanders secretion, etc. (Nocard).

Of small animals, field-mice and guinea-pigs are the most susceptible. Strangely enough, house-mice and white mice enjoy an almost complete immunity. In field-mice subcutaneous inoculation is followed by a very rapid disease, usually leading

to death within eight days, the organisms becoming generalised and producing numerous minute nodules, especially in the spleen, lungs, and liver. In the guinea-pig the disease is less acute, though secondary nodules in internal organs are usually present in considerable numbers. At the site of inoculation an inflammatory swelling forms, which soon softens and breaks down, leading to the formation of an irregular crateriform ulcer with indurated margins. The lymphatic vessels become infiltrated, and the corresponding lymphatic glands become enlarged to the size of peas or small nuts, softened, and semi-purulent. The animal sometimes dies in two or three weeks, sometimes not for several weeks. Secondary nodules, in varying numbers in different cases, may be present in the spleen, lungs, bones, nasal mucous membrane, testicles, ovaries, etc.; in some cases a few nodules are found in the spleen alone. Intraperitoneal injection in the male guinea-pig is followed, as pointed out by Straus, by a very rapid and semi-purulent affection of the tunica vaginalis, shown during life by great swelling and redness of the testicles, which changes may be noticeable in two or three days. By this method there occur also numerous small nodules on the surface of the peritoneum. Rabbits are less susceptible than guinea-pigs, and the effect of subcutaneous inoculation is somewhat uncertain. Accidental inoculation of the human subject with pure cultures of the bacillus has in more than one instance been followed by the acute form of the disease and a fatal result.

Mayer has found that when the glanders bacillus is injected along with melted butter into the peritoneum of a guinea-pig, it shows filamentous, branching, and club-shaped forms; in other words, it presents the characters of a streptothrix. Lubarsch, on the other hand, in a comparative study of the results of inoculation with acid-fast and other bacilli, found none of the above characters in the case of the glanders bacillus (cf. "Tubercle").

Action on the Tissues. — From the above facts it will be seen that in many respects glanders presents an analogy to tubercle as regards the general characters of the lesions and the mode of spread. When the tissue changes in the two diseases are compared, certain differences are found. The glanders bacillus causes a more rapid and more marked inflammatory reaction. There is more leucocytic infiltration and less proliferative change which might lead to the formation of epithelioid cells. Thus the centre of an early glanders nodule shows a dense aggregation of

leucocytes, many of which are polymorpho-nuclear, and have recently emigrated from the vessels, whilst the tissue elements between may be more or less degenerating, or may show proliferative changes. And further, the inflammatory change may be followed by suppurative softening of the tissue, especially in certain situations, such as the subcutaneous tissue and lymphatic glands. The nodules, therefore, in glanders, as Baumgarten puts it, occupy an intermediate position between miliary abscesses and tubercles. The diffuse coagulative necrosis and caseation which are so common in tubercle do not occur to the same degree in glanders, and typical giant-cells are not formed. The nodules in the lungs show leucocytic infiltration and thickening of the alveolar walls, whilst the vesicles are filled with catarrhal cells; *i.e.* there is reaction both on the part of the connective tissue, and of the endothelium of the air vesicles, whilst at the periphery of the nodules connective-tissue growth is present in proportion to their age. The tendency to spread by the lymphatics is always a well-marked feature, and when the bacilli gain entrance to the blood stream, they soon settle in the various tissues and organs. Accordingly, even in acute cases it is usually quite impossible to detect the bacilli in the circulating blood, though sometimes they have been found. It is an interesting fact, shown by observations of the disease both in the human subject and in the horse, as well as by experiments on guinea-pigs, that the mucous membrane of the nose may become infected by means of the blood stream — another example of the tendency of organisms to settle in special sites.

Mode of Spread. — Glanders usually spreads from a diseased animal by direct contagion with the discharge from the nose or from the sores, etc. So far as infection of the human subject goes, no other mode is known. There is no evidence that the disease is produced in man by inhalation of the bacilli in the dried condition. Some authorities consider that pulmonary glanders may be produced in this way in the horse, whilst others maintain that in all cases there is first a lesion of the nasal mucous membrane or of the skin surface, and that the lung is affected secondarily. Babes, however, found that the disease could be readily produced in susceptible animals by exposing them to an atmosphere in which pulverised cultures of the bacillus had been. He also found that inunction of the skin

with vaseline containing the bacilli might produce the disease, the bacilli in this case entering along the hair follicles.

Agglutination of Glanders Bacilli. — Shortly after the discovery of agglutination in typhoid fever, M'Fadyean showed that the serum of glandered horses possessed the power of agglutinating glanders bacilli. His later observations show that in the great majority of cases of glanders a 1 in 50 dilution of the serum produces marked agglutination in a few minutes, whilst in the great majority of non-glandered animals no effect is produced under these conditions. The test performed in the ordinary way is, however, not absolutely reliable, as exceptions occasionally occur in both directions, *i.e.* negative results by glandered animals and positive results by non-glandered animals. He finds that a more delicate and reliable method is to grow the bacillus in bouillon containing a small proportion of the serum to be tested. In this way he has obtained a distinct sedimenting reaction with a serum which did not agglutinate at all distinctly in the ordinary method. Further observations are still required to determine the precise value of the test.

Mallein and its Preparation. — Mallein is obtained from cultures of the glanders bacillus grown for a suitable length of time, and, like tuberculin, is really a mixture comprising (1) substances in the bodies of the bacilli and (2) their soluble products, not destroyed by heat, along with substances derived from the medium of growth. It was at first obtained from cultures on solid media by extracting with glycerin or water, but is now usually prepared from cultures in glycerin bouillon. Such a culture, after being allowed to grow for three or four weeks, is sterilised by heat either in the autoclave at 115° C. or by steaming at 100° C. on successive days. It is then filtered through a Chamberland filter. The filtrate constitutes fluid mallein. Usually a little carbolic acid (.5 per cent) is added to prevent it from decomposing. Of such mallein 1 c.c. is usually the dose for a horse (M'Fadyean). Foth has prepared a dry form of mallein by throwing the filtrate of a broth culture, evaporated to one-tenth of its bulk, into twenty-five or thirty times its volume of alcohol. A white precipitate is formed, which is dried over calcium chloride and then under an air-pump. A dose of this dry mallein is .05 to .07 gm.

The Use of Mallein as a Means of Diagnosis. — In using mallein for the diagnosis of glanders, the temperature of the animal ought to be observed for some hours beforehand, and, after subcutaneous injection of a suitable dose, it is taken at definite intervals, — according to M'Fadyean at the sixth, tenth, fourteenth, and eighteenth hours afterwards, and on the next day. Here both the local reaction and the temperature are of importance. In a glandered animal, at the site of inoculation there is a somewhat painful local swelling which reaches a diameter of five inches at least, the maximum size not being attained until twenty-four hours afterwards. The temperature rises 1.5° to 2° C., or more, the maximum generally occurring in from eight to sixteen hours. If the temperature never rises as much as 1.5°, the reaction is considered doubtful. In the negative reaction given by an animal free from glanders, the rise of temperature does not usually exceed 1°, the local swelling reaches the diameter of three inches at most, and has much diminished at the end of twenty-four hours. In the case of dry mallein, local reaction is less

marked. Veterinary authorities are practically unanimous as to the great value of the mallein test as a means of diagnosis. We cannot as yet speak as to its applicability to diagnosis of the disease in the human subject.

Methods of Examination and Diagnosis. — Microscopic examination in a case of suspected glanders will at most reveal the presence of bacilli corresponding in their characters to the glanders bacillus. An absolute diagnosis cannot be made by this method. Cultures may be obtained by making successive strokes on blood serum or on glycerin agar (preferably the former), and incubating at 37° C. The colonies of the glanders bacillus do not appear till two days after. This method often fails unless a considerable number of the glanders bacilli are present. Another method is to dilute the secretion or pus with sterile water, to varying degrees, and then to smear the surface of potato with the mixture, the potatoes being incubated at the above temperature. The colonies on potatoes may not appear till the third day. The most certain method, however, is that of Straus by inoculation of a male guinea-pig, either by subcutaneous or intraperitoneal injection. By the latter method, as above described, lesions are much more rapidly produced, and are more characteristic. If, however, there have been other organisms present, the animal may die of a septic peritonitis, though even in such a case the glanders bacilli will be found to be more numerous in the tunica vaginalis, and may be cultivated from this situation. Frothingham recommends injection of the suspected material into not one guinea-pig, but three or four, leaving a small portion of the injection beneath the skin; by so doing there is less chance of failure due either to increased resistance on the part of one animal, or to lessened resistance towards the organisms in another causing an early fatal peritonitis. He also warns one against a negative diagnosis being made unless several tests have been executed. In the case of horses, etc., a diagnosis will, of course, be much more easily and rapidly effected by means of mallein.

RHINOSCLEROMA.

This disease is considered here as, from the anatomical changes, it also belongs to the group of infective granulomata. It is characterised by the occurrence of chronic nodular thickenings in the skin or mucous membrane of the nose, or in the

mucous membrane of the pharynx, larynx, or upper part of the trachea. It is scarcely ever met with in this country, but is of not very uncommon occurrence on the Continent, especially in Austria. In the granulation tissue of the nodules there are to be found numerous round and rather large cells, which have peculiar characters and are often known as the cells of Mikulicz. Their protoplasm contains a collection of somewhat gelatinous material which may fill the cell and push the nucleus to the side. Within these cells there is present a characteristic bacillus, occurring in little clumps or masses chiefly in the gelatinous material. A few bacilli also lie free in the lymphatic spaces around. This organism was first observed by Frisch, and is now known as the bacillus of rhinoscleroma. The bacilli have the form of short oval rods, which, when lying separately, can be seen to possess a distinct capsule, and which in all their microscopical characters correspond closely with Friedländer's pneumobacillus. They are usually present in the lesions in a state of purity. It was at first stated that they could be stained by Gram's method, but more recent observations show that like Friedländer's organism they lose the stain.

From the affected tissues this bacillus can be easily cultivated by the ordinary methods. In the characters of its growth in the various culture media it presents a close similarity to that of the pneumobacillus, as it also does in its fermentative action in milk and sugar-containing fluids. The nail-like appearance of the growth on gelatin is said to be less distinct, and the growth on potatoes is more transparent and may show small bubbles of gas; otherwise it resembles the pneumobacillus. It is doubtful whether any distinct line of difference can be drawn between the two organisms so far as their microscopical and cultural characters are concerned.

The evidence that the organisms described are the cause of this disease consists in their constant presence and their special relation to the affected tissues, as already described. From these facts alone it is highly probable that they are the active agents in the production of the lesions. Experimental inoculation has thrown little light on the subject, though one observer has described the production of nodules on the conjunctivæ of guinea-pigs. The relation of the rhinoscleroma organism to that of Friedländer is, however, still a matter of doubt, and the

matter has been further complicated by the fact that a bacillus possessing closely similar characters has been found to be very frequently present in *ozæna*, and is often known as the *bacillus ozænae*. The last-mentioned organism is said to have more active fermentative powers. From what has been stated it will be seen that a number of organisms, closely allied in their morphological characters, have been found in the nasal cavity in healthy or diseased conditions. From what we know, however, of other diseases, it is not improbable that though presenting these close resemblances, they may be distinct species, and may cause distinct pathological conditions in man. The subject is one on which more light is still required.

CHAPTER XIII.

ACTINOMYCOSIS AND ALLIED DISEASES.

ACTINOMYCOSIS is a disease of special interest, inasmuch as it is the most important example of a microbic affection in which the parasite belongs to the higher order of bacteria. It is related, by the characters of the pathological changes, to the diseases which have been described.

The disease affects man in common with certain of the domestic animals, though it is more frequent in the latter, especially in oxen, swine, and horses. The parasite was first discovered in the ox by Bollinger, and described by him in 1877, the name *actinomyces* or *ray fungus* being from its appearance applied to it by the botanist Harz. In 1878 Israel described the parasite in the human subject, and in the following year Ponfick identified it as being the same as that found in the ox. Since that time a large number of cases have been observed in the human subject, the result of investigation being to show that it affects man much more frequently than was formerly supposed.

It is, however, very probable that the term *actinomyces* does not represent one parasite but a number of closely allied species, as cultures obtained from various sources have presented considerable differences. It is also to be noted that other distinct species of streptothrix¹ have been cultivated from isolated cases of disease in the human subject where the lesions resembled more or less closely those of actinomycosis. In one or two instances the organism has been found to be "acid-fast," and there is no doubt that the actinomyces group is closely related through intermediate forms with the tubercle group (*vide* p. 240).

Naked-eye Characters of the Parasite.—The actinomyces grows in the tissues in the form of little round masses or colonies, which, when fully developed, are easily visible to the naked

¹ See footnote to p. 16.

eye, the largest being about the size of a small pin's head, whilst all sizes below this may be found. When suppuration is present, they lie free in the pus; when there is no suppuration, they are embedded in the granulation tissue, but are usually surrounded by a zone of softer tissue. They may be transparent or jelly-like, or they may be opaque and of various colours — white, yellow, greenish, or almost black. The appearance depends upon their age and also upon their structure, the younger colonies being more or less transparent, the older ones being generally opaque. Their colour is modified by the presence of pigment and by degenerative change, which is usually accompanied by a yellowish coloration. They are generally of soft, sometimes tallow-like, consistence, though sometimes in the ox they are gritty, owing to the presence of calcareous deposit. They may be readily found in the pus by spreading it out in a thin layer on a glass slide and holding it up to the light. They are sometimes described as being always of a distinctly yellow colour, but this is only occasionally the case; in fact, in the human subject they occur much more frequently as small specks of semi-translucent appearance, and of greenish-grey tint.

Microscopical Characters. — The parasite, which is now generally regarded as belonging to the streptothrix group of the higher bacteria (the actinomycetes group of Lachner-Sandoval, p. 16), presents pleomorphous characters. In the colonies, as they grow in the tissues, three morphological elements may be described, namely, filaments, coccus-like bodies, and clubs.

1. The *filaments* are comparatively thin, measuring about $.5 \mu$ in diameter, but they are often of great length. They are composed of a central protoplasm enclosed by a sheath. The latter, which is most easily made out in the older filaments with granular protoplasm, occasionally contains granules of dark pigment. In the centre of the colony the filaments interlace with one another, and form an irregular network which may be loose or dense; at the periphery they are often arranged in a somewhat radiating manner, and run outwards in a wavy or even spiral course. They also show branching, a character which at once distinguishes them from the ordinary bacteria. Between the filaments there is a finely granular or homogeneous ground substance. Most of the colonies at an early stage are chiefly

constituted by filaments loosely arranged; but later, part of the growth may become so dense that its structure cannot be made out. This dense part, starting excentrically, may grow round the colony to form a hollow sphere, from the outer surface of which filaments radiate for a short distance (Fig. 101). The filaments usually stain uniformly in the younger colonies, but some, especially in the older colonies, may be segmented so as to give the appearance of a chain of bacilli or of cocci, though

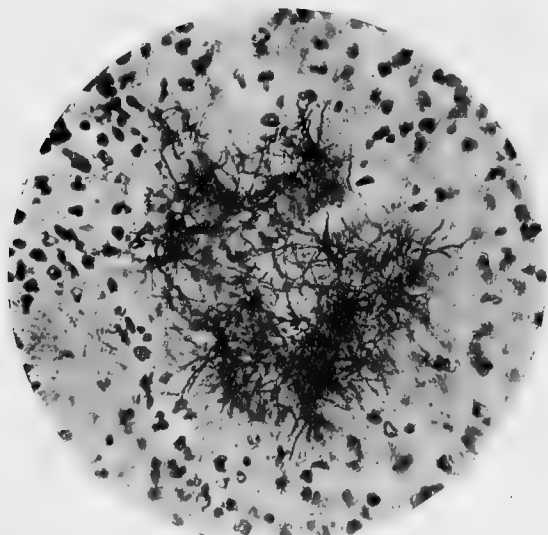

FIG. 101.—Actinomycosis of human liver, showing a colony of the parasite composed of a felted mass of filaments surrounded by pus.

Paraffin section; stained by Gram's method and with safranin. $\times 500$.

the sheath enclosing them may generally be distinguished. Rod-shaped and spherical forms may also be seen lying free.

2. *Coccus-like Bodies*.—The formation of these from filaments has already been described, but it is doubtful if all are of the same nature. Like other species of streptothrix, the actinomyces when growing on a culture medium shows on its surface filaments growing upwards in the air, the protoplasm of which becomes segmented into rounded spores or gonidia. In natural conditions outside the body these gonidia become free and act as new centres by growing out into filaments. They have somewhat higher powers of resistance than the filaments, though less than the spores of most of the lower bacteria. It is

probable that some of the spherical bodies formed within filaments when growing in the tissues have the same significance, *i.e.* are gonidia, whilst others may be merely the result of degenerative change. Some observers have described young colonies largely composed of spherical forms, as if these multiplied by division, but this latter point is still doubtful. Both the filaments and the spherical bodies are readily stained by Gram's method.

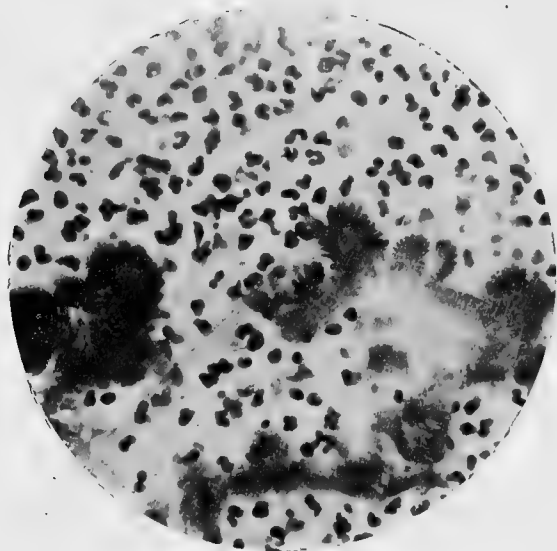

FIG. 102. — Actinomyces in human kidney, showing clubs radially arranged and surrounded by pus. The filaments had practically disappeared.

Paraffin section; stained with hæmatoxylin and rubin. $\times 500$.

3. *Clubs*. — These are elongated pear-shaped bodies which are seen at the periphery of the colony, and are formed by a sort of hyaline swelling of the sheath around the free extremity of a filament (Figs. 102, 103). They are usually homogeneous and structureless in appearance. In the human subject the clubs are often comparatively fragile structures which are easily broken down and may sometimes be dissolved in water. Sometimes they are well seen when examined in the fresh condition, but in hardened specimens are no longer distinguishable. In specimens stained by Gram's method they are not coloured by the violet, but take readily a contrast stain, such as picric acid, rubin, etc.; sometimes a darkly-stained filament can be seen

running for a distance in the centre, and may have a knob-like extremity. In many of the colonies in the human subject the clubs are absent. In the ox, on the other hand, where there are much older colonies, the clubs constitute the most prominent feature, whilst in most colonies the filaments are more or less degenerated, and it may sometimes be impossible to find any. They often form a dense fringe around the colony, and when stained by Gram's method retain the violet stain. They have, in fact, undergone some further chemical change which produces

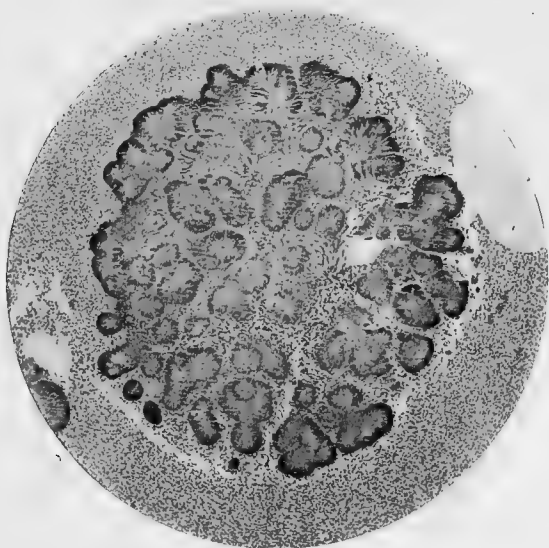

FIG. 103. — Colonies of actinomycosis, showing general structural arrangement and clubs at periphery. From pus in human subject. Stained by Gram and safranin. $\times 60$.

the altered staining reaction. Clubs showing intermediate staining reaction have been described by M'Fadyean. The view that the clubs are organs of fructification has been abandoned by most authorities, and there appears to us little evidence in support of it.

Tissue Lesions. — In the human subject the parasite produces by its growth a chronic inflammatory change, usually ending in a suppuration which slowly spreads. In some cases there is a comparatively large production of granulation tissue, with only a little softening in the centre, so that the mass feels solid. This

condition is sometimes found in the subcutaneous tissue, especially when the disease has not advanced far, and also in dense fibrous tissue. In most cases, however, and especially in internal organs, suppuration is the outstanding feature. This is to be associated with abundant growth of the parasite in the filamentous form. In an organ such as the liver, multiple foci of suppuration are seen at the spreading margin of the disease, presenting a honeycomb appearance which is somewhat characteristic, whilst the colonies of the parasite may be seen in the pus with the naked eye. In the older parts the abscesses have become confluent, and formed large areas of suppuration. The pus is usually of greenish-yellow colour and of somewhat slimy character.

In cattle the tissue reaction is more of a formative type, there being abundant growth of granulation tissue, which may result in large tumour-like masses, usually of more or less nodulated character, and often consisting of well-developed fibrous tissue containing areas of younger formation in which irregular abscess formation is usually present. The cells immediately around the colonies are usually irregularly rounded, or may even be somewhat columnar in shape, whilst farther out they become spindle-shaped and concentrically arranged. It is not uncommon to find leucocytes or granulation tissue invading the substance of the colonies, and portions of the parasite, etc., may be contained within leucocytes or within small giant-cells which are sometimes present. A similar invasion of old colonies by leucocytes is sometimes seen in human actinomycosis.

Origin and Distribution of Lesions.—The lesions in the human subject may occur in almost any part of the body, the paths of entrance being very various. In many cases the entrance takes place in the region of the mouth—probably around a decayed tooth—by the crypts of the tonsil, or by some abrasion. Swelling and suppuration may then follow in the vicinity and may spread in various directions. The periosteum of the jaw or the vertebræ may thus become affected, caries or necrosis resulting, or the pus may spread deeply in the tissues of the neck, and may even pass into the mediastinum. Occasionally the parasite may enter the tissues from the œsophagus, and in a considerable number of cases the primary lesion is in some part of the intestine, generally of the large intestine. The parasite penetrates

the wall of the bowel, and may be found deeply between the coats, surrounded by purulent material. Ulceration, and sometimes a considerable amount of necrosis, may follow. Thence it may spread to the peritoneum or to the extraperitoneal tissue, the retrocæcal connective tissue and that around the rectum being not uncommonly seats of suppuration produced in this way. A peculiar affection of the intestine has been described, in which slightly raised plaques are found both in the large and small intestines, these plaques being composed almost exclusively of masses of the actinomyces along with epithelial cells. This, however, is a very rare condition. The path of entrance may also be by the respiratory passages, the primary lesion being pulmonary or peribronchial; extensive suppuration in the lungs may result. Infection may also occur by the skin surface, and, lastly, by the female genital tract, as in a case recorded by Grainger Stewart and Muir, in which both ovaries and both Fallopian tubes were affected.

When the parasite has invaded the tissues by any of these channels, secondary or "metastatic" abscesses may occur in internal organs. The liver is the organ most frequently affected, though abscesses may occur in the lungs, brain, kidneys, etc. In such cases the spread takes place by the blood stream, and it is possible that leucocytes may be the carriers of the infection, as it is not uncommon to find leucocytes in the neighbourhood of a colony containing small portions of the filaments in their interior.

In the ox, on the other hand, the disease usually remains quite local, or spreads by continuity. It may produce tumour-like masses in the region of the jaw or neck, or it may specially affect the palate or tongue, in the latter producing enlargement and induration, with nodular thickening on the surface—the condition known as "woody tongue."

Source of the Parasite.—There is a considerable amount of evidence to show that outside the body the parasite grows on grain, especially on barley. Both in the ox and in the pig the parasite has been found growing around fragments of grain embedded in the tissues. There are besides, in the case of the human subject, a certain number of cases in which there was a history of penetration of a mucous surface by a portion of grain, and in a considerable proportion of cases the patient has been

exposed to infection from this source. The position of the lesions in cattle is also in favour of such a view.



FIG. 104. — Cultures of the actinomycetes on glycerin agar, of about three weeks' growth, showing the appearances which occur. The growth in A is at places somewhat corrugated on the surface. Natural size.

like drops of amber. The growths tend to remain separate, and even when they become confluent, the nodular character is maintained. They have a tough consistence, being with difficulty broken up, and adhere firmly to the surface of the agar. Older growths often show on the surface a sort of corrugated aspect, and may sometimes present the appearance of having been dusted with a brownish-yellow powder (Fig. 104). The organism grows well in the anaerobic condition on agar, and for this

Cultivation (for methods of isolation see later). — The actinomycetes grows on a variety of media, though on all its rate of growth is somewhat slow. Growth takes place at the ordinary room temperature, but very slowly, the temperature of the body being much more suitable, and it would seem that an anaerobic condition is more productive of positive results in many instances than where oxygen is not excluded.

On *agar* or *glycerin agar* at 37° C., growth is generally visible on the third or fourth day in the form of little transparent drops which gradually enlarge and form rounded projections of a reddish-yellow tint and somewhat transparent appearance,

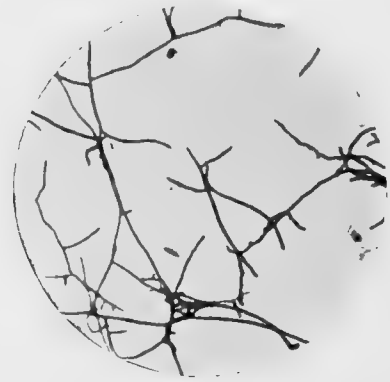

FIG. 105. — Actinomycetes from a culture on glycerin agar, showing the branching of the filaments. Stained with fuchsin. $\times 1000$.

purpose unopened eggs also, either in the fresh or boiled condition, have been used, inoculation being effected by drilling in the shell a small hole which is afterwards closed. The growth on *potatoes* is somewhat similar to that on agar.

On *gelatin* the same tendency to grow in little spherical masses is seen, and the medium becomes very slowly liquefied. When this occurs the liquefied portion has a brownish colour and somewhat syrupy consistence, and the growths may be seen at the bottom, as little balls, from the surface of which filaments radiate.

In the cultures at an early stage the growth is composed of branching filaments, which stain uniformly (Fig. 105), but later some of the superficial filaments may show segmentation into gonidia. True clubs are not formed in cultures, though slight bulbous thickenings may be seen at the end of some of the filaments.

Varieties of Actinomyces and Allied Forms.—It is probable that in the cases of the disease described in the human subject there are more than one variety or species of parasite belonging to the same group. Gasperini has described several varieties of *actinomyces bovis* according to the colour of the growths, and a similar condition may obtain in the case of the human subject. Furthermore a considerable number of *streptothrices* have been found in cases of disease in the human subject, the associated lesions varying in character from tubercle-like nodules on the one hand to suppurative processes on the other. The organisms cultivated from such sources differ according to their microscopic characters (for example, some form “clubs,” whilst others do not), according to their conditions of growth, staining reactions, etc. Of these only a few examples may here be mentioned, but it may be noted that the importance of the streptothrices as causes of disease is constantly being extended. Wolff and Israel cultivated from two cases of “actinomycosis” in man a streptothrix which differs in so many important points from the actinomyces that it is now regarded as a distinct species. Another species was cultivated by Eppinger from a brain abscess, and called by him “cladotrix asteroides,” from the appearance of its colonies on culture media. In the tissues it grows in a somewhat diffuse manner and does not form clubs; in rabbits and guinea-pigs it produces tubercle-like lesions. Flexner observed a streptothrix in the lungs associated with lesions somewhat like a rapid phthisis, and applied the name “pseudo-tuberculosis hominis streptothricea”; an apparently similar condition has been described by Buchholz. Berestnew cultivated two species of streptothrix from suppurative lesions, one of which is acid-fast and grows only in anaerobic conditions. Quite recently Birt and Leishman have described another acid-fast streptothrix obtained from cirrhotic nodules in the lungs of a man. This organism grows readily on ordinary media, forming a white powdery growth which afterwards assumes a pinkish

colour; it is pathogenic for guinea-pigs, in which it causes caseous lesions. There is, further, the streptothrix *maduræ* described below.

In diseases of the lower animals several other forms have been found. For example, a streptothrix has been shown by Nocard to be the cause of a disease of the ox, — “*farcin du bœuf*,” — a disease in which also there occur tumour-like masses of granulation tissue. Dean has cultivated from a nodule in a horse another streptothrix, which produces tubercle-like nodules in the rabbit, with club formation; it has close resemblances to the organism of Israel and Wolff. The so-called diphtheria of calves and “bacillary necrosis” in the ox are probably both produced by another streptothrix or leptothrix which grows diffusely in the tissues in the form of fine felted filaments. Further investigation may show that some of these or other species may occur in the human subject in conditions which are not yet differentiated.

Experimental Inoculation. — Inoculation of smaller animals, such as rabbits and guinea-pigs, has usually failed to give positive results. This was the case, for example, in the important series of experiments by Boström, and it may be assumed that these animals are little susceptible to the actinomycetes. The disease has, however, been experimentally produced in the bovine species both by cultures from the ox and from the human subject. Inoculation with the streptothrix of Israel and Wolff produces nodular lesions both in rabbits and in guinea-pigs, and a similar result has been obtained with several of the other species of streptothrix mentioned above.

Methods of Examination and Diagnosis. — As actinomycosis cannot be diagnosed with certainty apart from the discovery of the parasite, a careful examination of the pus in obscure cases of suppuration should always be undertaken. As already stated, the colonies can be recognised with the naked eye, especially when some of the pus is spread out on a piece of glass. If one of these is washed in salt solution and examined unstained, the clubs, if present, are at once seen on microscopic examination. Or the colony may be stained with a simple reagent such as picrocarmine, and mounted in glycerin or Farrant’s solution. To study the filaments, a colony should be broken down on a cover-glass, dried, and stained with a simple solution of any of the basic aniline dyes, such as gentian-violet, though better results are obtained by carbol-thionin-blue; or by carbol-fuchsin diluted with five parts of water. If the specimen be overstained, it may be decolorised by weak acetic acid. Cover-glass preparations of this kind and also of cultures are readily stained by

these methods, but in the case of sections of the tissues Gram's method, or a modification of it, should be used to show the filaments, etc., a watery solution of rubin being afterwards used to stain the clubs. By this method, very striking preparations may be obtained.

To obtain cultures, tubes of one per cent glucose broth whose reaction is 1.5 per cent acid to phenol-phthaleine, and tubes of glycerin agar of similar reaction, should be inoculated with portions of the colonies and incubated, anaerobically as well as aerobically, at 37° C. Owing to the slow growth of the actinomyces, however, the obtaining of pure cultures is difficult, unless the pus is free from contamination with other organisms.

MADURA DISEASE.

Madura disease, or mycetoma, resembles actinomycosis both as regards the general characters of the lesions and the occurrence of the parasite in the form of colonies or "granules." There is no doubt, however, that the two conditions are distinct, and it also appears established that the two varieties of Madura disease (*vide infra*) are produced by different organisms. This disease is comparatively common in India and in various other parts of the tropics: it has also been met with in Algiers and in America. Madura disease differs from actinomyces not only in its geographical distribution, but also in its clinical characters. Its course, for example, is of an extremely chronic nature, and though the local disease is incurable except by operation, the parasite never produces secondary lesions in internal organs. Vincent also found that iodide of potassium, which has a high value as a therapeutic agent in many cases of actinomycosis, had no effect in the case of Madura disease studied by him. It most frequently affects the foot; hence the disease is often spoken of as "Madura foot." The hand is rarely affected. In the parts affected there is a slow growth of granulation tissue which has an irregularly nodular character, and in the centre of the nodules there occurs purulent softening which is often followed by the formation of fistulous openings and ulcers. There are great enlargement and distortion of the part and frequently caries and necrosis of the bones. Within the softened cavities and also in the spaces between the fibrous tissue, small rounded bodies or granules, bearing a certain

resemblance to the actinomyces, are present. These may have a yellowish or pinkish colour, compared from their appearance to fish roe, or they may be black like grains of gunpowder, and may by their conglomeration form nodules of considerable size. Hence a *pale variety* and a *black variety* of the disease have been distinguished; in both varieties the granules mentioned reach a rather larger size than in actinomycosis. These two conditions will be considered separately.

Pale Variety. — When the roe-like granules are examined microscopically, they are found, like the actinomyces, to show in their interior an abundant mass of branching filaments with mycelial arrangement (Fig. 106). There may also be present at

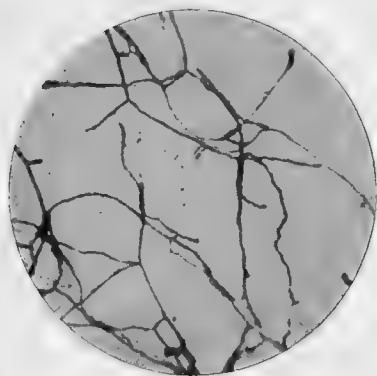

FIG. 106. — *Streptothrix maduræ*, showing branching filaments. From a culture on agar. Stained with carbol-thionin-blue. $\times 1000$.

the periphery club-like structures, as in actinomyces; sometimes they are absent. These structures often have an elongated wedge shape, forming an outer zone to the colony, and in some cases the filaments can be found to be connected with them. Vincent obtained cultures of the parasite from a case in Algiers, and found it to be a distinct species: it is now known as the *streptothrix maduræ*. Morphologically it closely resembles the actinomyces, but it presents certain

differences in cultural characters. In gelatin it forms raised colonies of a yellowish colour, with umbilication of the centre, and there is no liquefaction of the medium. On agar the growth assumes a reddish colour; the organism flourishes well in various vegetable infusions in which the actinomyces does not grow. On all the media growth only takes place in aerobic conditions. Experimental inoculation of various animals has failed to reproduce the disease. There is therefore no doubt that the *streptothrix maduræ* and the actinomyces are distinct species.

Black Variety. — There has been considerable discussion regarding the relation of this variety of the disease to that just

described. Kanthack considered that the parasite was the same in both, and occurred in the black variety in a degenerated form. Boyce and Surveyor, on the other hand, pointed out differences, and especially that in the black variety the parasite is more highly organised and the branching filaments are thicker; hence they believed that it belonged to the hyphomycetes. The observations of J. H. Wright, who obtained pure cultures of a hyphomycete, are confirmatory of this view. The pigment may be dissolved by soaking the granules for a few minutes in hypochlorite of sodium solution, and the granule may then be crushed out beneath a cover-glass and examined microscopically. The black granules are composed of a somewhat homogeneous ground-substance impregnated with pigment, and in this there is a mycelium of thick filaments or hyphæ, many of the segments of which are swollen; at the periphery the hyphæ form a zone with radiate arrangement. In many of the older granules the parasite is largely degenerated and presents an amorphous appearance. Wright planted over sixty of the black granules in various culture media, and obtained cultures of a hyphomycete from about a third of these. The organism grows well on agar, bouillon, potato, etc.; on agar it forms a felted mass of greyish colour, and in old cultures black granules appear amongst the mycelium. Microscopically the parasite appears as a mycelium of thick branching filaments with delicate transverse septa; in the older threads the segments become swollen, so that strings of oval-shaped bodies result. No signs of spore formation were noted. Inoculation of animals with cultures gave negative results, as did also direct inoculation with the black granules from the tissues.

CHAPTER XIV.

ANTHRAX.¹

OTHER NAMES:—SPLENIC FEVER, MALIGNANT PUSTULE,
WOOLSORTER'S DISEASE. GERMAN, MILZBRAND; FRENCH,
CHARBON.²

Introductory.—Anthrax is a disease occurring epidemically among the herbivora, especially sheep and oxen, in which animals it has the characters of a rapidly fatal form of septicæmia with splenic enlargement, attended by an extensive multiplication of characteristic bacilli throughout the blood. The disease does not occur as a natural affection in man, but may be communicated to him directly or indirectly from animals, and it may then appear in certainly two and possibly three forms. In the first there is infection through the skin, in which a local lesion, the "malignant pustule," occurs. In the second form infection takes place through the respiratory tract. Here very aggravated symptoms centred in the thorax, with rapidly fatal termination, follow. Thirdly, an infection may probably take place through the intestinal tract, which is now the first part to give rise to symptoms. In all these forms of the affection in the human subject, the bacilli are in their distribution much more restricted to the local lesions than is the case in the ox, their growth and spread being attended by inflammatory œdema and often by hæmorrhages.

Historical Summary.—Historical researches leave little doubt that from the earliest times anthrax has occurred among cattle. For a long time its pathology was not understood, and it went by many names. During the

¹ In even recent works on surgery the term "anthrax" may be found applied to any form of carbuncle. Before its true pathology was known the local variety of the disease which occurs in man and which is now called "malignant pustule" was known as "malignant carbuncle."

² This must be distinguished from "charbon symptomatique," which is quite a different disease.

early part of the present century much attention was paid to it, and, with a view to finding out its nature and means of spread, various conditions attaching to its occurrence, such as those of soil and weather, were exhaustively studied. Pollender in 1849 pointed out that the blood of anthrax animals contained numerous rod-shaped bodies which he conjectured had some causal connection with the disease. In 1863 Davaine announced that they were bacteria, and originated the name *bacillus anthracis*. He stated that unless blood used in inoculation experiments on animals contained them, death did not ensue. Though this conclusion was disputed, still by the work of Davaine and others the causal relationship of the bacilli to the disease had been nearly established when the work of Koch appeared in 1876. This constituted that observer's first contribution to bacteriology, and did much to clear up the whole subject. Koch confirmed Davaine's view that the bodies were bacteria. He observed in the blood of anthrax animals the appearance of division, and from this deduced that multiplication took place in the tissues. He observed them under the microscope dividing outside the body, and noticed spore formation taking place. He also isolated the bacilli in pure culture outside the body, and by inoculating animals with them, produced the disease artificially. In his earlier experiments he failed to produce death by feeding susceptible animals both with bacilli and spores, and as the intestinal tract was, in his view, the natural path of infection, he considered as incomplete the proof of this method of the spontaneous occurrence of anthrax in herds of animals. Koch's observations were, shortly afterwards, confirmed in the main by Pasteur, though controversy arose between them on certain minor points. Moreover, further research showed that the disease could be produced in animals by feeding them with spores, and thus the way in which the disease might spread naturally was explained.

The Bacillus Anthracis. — Anthrax as a disease in man is of comparative rarity. Not only, however, is the bacillus anthracis easy of growth and recognition, but in its growth it illustrates many of the general morphological characters of the whole group of bacilli, and is therefore of the greatest use to the student. Further, its behaviour when inoculated in animals illustrates many of the points raised in connection with such difficult questions as the general pathogenic effects of bacteria, immunity, etc. Hence an enormous amount of work has been done in investigating it in all its aspects.

If a drop of blood is taken immediately after death from an auricular vein of a cow, for example, which has died from anthrax, and examined microscopically, it will be found to contain a great number of large non-motile bacilli. On making a cover-glass preparation from the same source, and staining with watery methylene-blue, the characters of the bacilli can be better made out. They are about 1.2μ thick or a little thicker, and

6 to 8 μ long, though both shorter and longer forms also occur. The ends are sharply cut across, or may be slightly dimpled so as to resemble somewhat the proximal end of a phalanx. Their

protoplasm is very finely granular, and sometimes appears surrounded by a thin unstained capsule. When several bacilli lie end to end in a thread, the capsule seems common to the whole thread (Fig. 111). They stain well with all the basic aniline dyes and are not decolorised by Gram's method.

Plate-cultures.—From a source such as that indicated, it is easy to isolate the bacilli by making gelatin or agar plates. If, after twelve hours' incubation at 37°C., the latter be examined under a low objective, colonies will be observed. They are to be recognised by beautiful wavy wreaths, like locks of hair, radiating from the centre and apparently terminating in a point, which, however,

FIG. 107.—Surface colony of the anthrax bacillus on an agar plate, showing the characteristic appearances. $\times 30$.

on examination with a higher power is observed to be a filament which turns upon itself (Fig. 107). The whole colony is, in fact, probably one long thread. Such colonies are very suitable for making impression preparations (*vide p. 114*) which preserve permanently the appearances described. On examining such with a high power, the wreaths are seen to be made up of bundles of long filaments lying parallel with one another, each filament consisting of a chain of bacilli lying end to end, and similar to those observed in the blood (Fig. 108).



FIG. 108.—Anthrax bacilli, arranged in chains from a twenty-four hours' culture on agar at 37°C. Stained with fuchsin. $\times 1000$.

On gelatin plates, after from twenty-four to thirty-six hours.

at 20° C., the same appearances manifest themselves, and later they are accompanied by liquefaction of the gelatin. In gelatin plates, however, instead of the characteristically wreathed appearance at the margin, the colonies sometimes give off radiating spikelets irregularly nodulated, which produce a star-like form. These spikelets are composed of spirally twisted threads.

From such plates the bacilli can be easily isolated, and the appearances of pure cultures on various media studied.

Appearances of Cultures. — In *bouillon*, after twenty-four hours' incubation at 37° C., there is usually the appearance of irregularly spiral threads or flocculi suspended in the liquid or lying at the bottom of the tube. These, on being examined, are seen to be made up of bundles of parallel chains of bacilli. Later, growth is more abundant, and forms a flocculent mass at the bottom of the fluid.

In *gelatin* stab-cultures, the characteristic appearance can be best observed when a low proportion, say $7\frac{1}{2}$ per cent, of gelatin is present, and when the tube is directly inoculated from anthrax blood. In about two days there radiate out into the medium from the needle track numberless very fine spikelets which enable the cultures to be easily recognised. These spikelets are longest at the upper part of the needle track (Fig. 109). Not much spreading takes place on the surface of the gelatin, but here liquefaction commences, and gradually spreads down the stab and out into the medium, till the whole of the gelatin may be liquefied. Gelatin sloped cultures exhibit a thick felted growth, the edges of which show the wreathed appearance seen in plate-cultures. Liquefaction here soon ploughs a trough in the surface of the medium. Sometimes "spiking" does not take place in gelatin stab-cultures, only little round particles of growth occurring down the needle track, followed by liquefaction. As has been shown by Richard Muir, this property of spiking can be restored by growing the bacillus for twenty-four hours on blood agar at 37° C. *Agar* sloped cultures have the appearance of similar



FIG. 109. — Stab-culture of the anthrax bacillus in peptone-gelatin; seven days' growth. It shows the "spiking" and also, at the surface, commencing liquefaction. Natural size.

cultures in gelatin, though, of course, no liquefaction takes place. *Blood serum* sloped cultures present the same appearances as those on agar. The margin of the surface growth on any of the solid media shows the characteristic wreathing seen in plate colonies. On *potatoes* there occurs a thick felted white mass of bacilli showing no special characters. Such a growth, however, is useful for studying sporulation. *Litmus milk* is feebly acidified, loosely coagulated, and slowly peptonised.

The anthrax bacillus will thus grow readily on any of the ordinary media. It can usually be sufficiently recognised by its microscopic appearance, by its growth on agar or gelatin plates, and by its growth in gelatin stab-cultures. The growth on plates is specially characteristic, and is simulated by no other pathogenic organism. Among the non-pathogenic bacteria the only organism which has similar colonies is the bacillus figurans, and the resemblance is only a distant one. One variety of *B. subtilis* has been observed to bear a striking general resemblance to *B. anthracis*, however.

The Biology of Bacillus Anthracis. — Koch found that the bacillus anthracis grows best at a temperature of 35° C. Growth, *i.e.* multiplication, does not take place below 12° C. or above 45° C. In the spore-free condition the bacilli have comparatively low powers of resistance. They do not stand long exposure to 60° C., and if kept at ordinary temperature in the dry condition they are usually found to be dead after a few days. The action of the gastric juice is rapidly fatal to them, and they are accordingly destroyed in the stomachs of healthy animals. They are also soon killed in the process of putrefaction. They can, however, be cooled below the freezing-point without dying. The bacillus can grow without oxygen, but some of its vital functions are best carried on in the presence of this gas. Thus in anthrax cultures the liquefaction of gelatin always commences at the surface and spreads downwards. Growth is more rapid in the presence of oxygen, and spore formation does not occur in its absence. The organism may be classed as a facultative anaerobe.

Sporulation. — Under certain circumstances sporulation occurs in anthrax bacilli. The morphological appearances are of the ordinary kind. A little highly refractile speck appears in the protoplasm about the centre of the bacillus; this gradually

increases in size until it forms an oval body, about the same thickness as the bacillus, lying in the bacillary protoplasm (Fig. 110). The latter gradually loses its staining capacities and finally disappears. The spore thus lies free as an oval highly refractile body which does not stain by ordinary methods, but which can be easily stained by the special methods described for such a purpose (p. 106). When the spore is again about to assume the bacillary form the capsule is apparently absorbed, and the protoplasm within grows out, taking on the ordinary rod-shaped form.

According to most observers sporulation never occurs within the body of an animal suffering from anthrax. Koch attributes this, probably rightly, to the absence of free oxygen. The latter gas he found necessary to the occurrence of spores in cultures outside the body. Many, however, are inclined to assign as the cause of sporulation the absence of the optimum pabulum, which in the case of anthrax is afforded by the animal tissues. Besides these conditions there is another factor necessary to sporulation, viz., a suitable temperature. The optimum temperature for spore production is 32° C. Koch found that spore formation did not occur below 18° C. Above 42° C. not only does sporulation cease, but Pasteur found that if bacilli were kept at this temperature for eight days they did not regain the capacity when again grown at a lower temperature. In order to make them again capable of sporing it is necessary to adopt special measures, such as passage through the bodies of a series of susceptible animals.

Anthrax spores have extremely high powers of resistance. In a dry condition they will remain viable for a year or more. Koch found they resisted boiling for five minutes; and dry heat at 140° C. must be applied for several hours to kill them with certainty. Unlike the bacilli, they can resist the action of the



FIG. 110. — Anthrax bacilli containing spores (the darkly coloured bodies); from a three days' culture on agar at 37° C.

Stained with carbol-fuchsin and methylene-blue. $\times 1000$.

gastric juice for a long period of time. They are often used as test objects by which the action of germicides is judged. For this purpose an emulsion is made by scraping off a surface culture and rubbing it up in a little sterile water. Into this sterile silk threads are dipped, which, after being dried over strong sulphuric acid in a desiccator, can be kept for long periods of time in an unchanged condition. For use they are placed in the germicidal solution for the desired time, then washed with water to remove the last traces of the reagent and laid on the surface of agar or placed in bouillon, in order that if death has not occurred growth may be observed.

Anthrax in Animals.— Anthrax occurs from time to time epidemically in sheep, cattle, and, more rarely, in horses and deer. These epidemics are found in various parts of the world, although they are naturally most far-reaching where legal precautions to prevent the spread of infection are non-existent. All the countries of Europe are from time to time visited by the disease, but in some it is much more common than in others. In Britain the death-rate is small, but in France the annual mortality among sheep was probably 10 per cent of the total number in the country, and among cattle 5 per cent. These figures, however, have been largely modified by the system of preventive treatment which will be presently described. In sheep and cattle the disease is specially virulent. An animal may suddenly drop down, with symptoms of collapse, quickening of pulse and respiration, and dyspnoea, and death may occur in a few minutes. In less acute cases the animal is apparently out of sorts, and does not feed; its pulse and respiration are quickened; rigours occur, succeeded by high temperature; there is a sanguineous discharge from the bowels, and bloody mucus may be observed about the mouth and nose. There may be convulsive movements, there is progressive weakness, with cyanosis, death occurring in from twelve to forty-eight hours. In the more prolonged cases widespread œdema and extensive enlargement of lymphatic glands are marked features; and in the glands, especially about the neck, actual necrosis with ulceration may occur, constituting the so-called anthrax carbuncles. Such subacute conditions are especially found among horses, which are by nature not so susceptible to the disease as cattle and sheep.

On *post-mortem* examination of an ox dead of anthrax, the most noticeable feature—one which has given the name “splenic fever” to the disease—is the enlargement of the spleen, which may be two or three times its natural size. It is of dark-red colour, and on section the pulp is very soft and friable, sometimes almost diffuent. A cover-glass preparation may be made from the spleen and stained with watery methylene-blue. On examination it will be found to contain enormous numbers of bacilli mixed with red corpuscles and leucocytes, chiefly lymphocytes and the large mononucleated variety (Fig. 111). Pieces of the organ may be hardened in absolute alcohol, and sections cut in paraffin. These are best stained by Gram’s method. Microscopic examination of such shows that the structure of the pulp is considerably disintegrated, whilst the bacilli swarm throughout the organ, lying irregularly amongst the cellular elements.

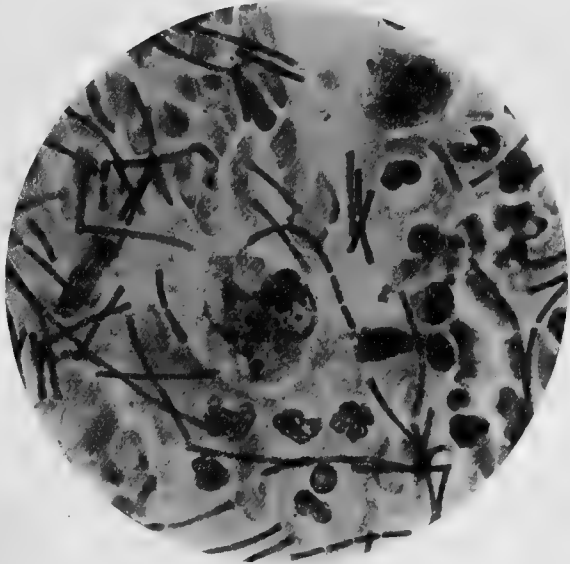

FIG. 111.—Scraping from spleen of guinea-pig dead of anthrax, showing the bacilli mixed with leucocytes, etc. (Same appearance as in the ox.)

“Corrosive film” stained with carbol-thionin-blue. $\times 1000$.

The liver is enlarged and congested, and may be in a state of acute cloudy swelling. The bacilli are present in the capillaries throughout the organ, but are not so numerous as in the spleen. The kidney is in a similar condition, and here the bacilli are chiefly found in the capillaries of the glomeruli, which often appear as if injected with them. The lungs are congested and may show catarrh, whilst bacilli are present in large numbers throughout the capillaries, and may also be found

in the air cells, probably as the result of rupture of the capillaries. The blood throughout the body is usually fluid and of dark colour.

The lymphatic system generally is much affected. The glands, especially the mediastinal, mesenteric, and cervical glands, are enlarged and surrounded by œdematous tissue, the lymphatic vessels are swollen, and both glands and vessels may contain numberless bacilli. The heart may be in a state of cloudy swelling, and the blood in its cavities contains bacilli, though in smaller numbers than that in the capillaries. The intestines are enormously congested, the epithelium more or less desquamated, and the lumen filled with a bloody fluid. From all the organs the bacilli can be easily isolated by stroke-cultures on agar.

It is important to note the existence of great differences in susceptibility to anthrax in different species of animals. Thus the ox, sheep (except those of Algeria, which only succumb to enormous doses of the bacilli), guinea-pig, and mouse are all very susceptible, the rabbit slightly less so. The last three are of course most used for experimental inoculation. We have no data to determine whether the disease occurs among these in the wild state. Less susceptible than this group are the horse, deer, goat, in which the disease occurs from time to time in nature. Anthrax also occurs epidemically in the pig, often from the ingestion of the organs of other animals dead of the disease. It is, however, doubtful if all cases of disease in the pig described on clinical grounds as anthrax are really such, and a careful bacteriological examination is always advisable. The human subject may be said to occupy a medium position between the highly susceptible and the relatively immune animals. The white rat is highly immune to the disease, while the brown rat is susceptible. Adult carnivora are also very immune, and the birds and amphibia are in the same position.

With these differences in susceptibility there are also great variations in the pathological effects produced in the natural or artificial disease. This is especially the case when we consider the distribution of the bacilli in the bodies of the less susceptible animals. Instead of the widespread occurrence described above, they may be confined to the point where they first gained access to the body and the lymphatic system in relation to it, or may

be only very sparsely scattered in organs such as the spleen (which is often not enlarged), the lungs, or kidneys. Nevertheless the cellular structure of the organs even in such a case may show changes, a fact which is important when we consider the essential pathology of the disease.

Experimental Inoculation.—Of the animals commonly used in laboratory work, white mice and guinea-pigs are the most susceptible to anthrax, and are generally used for test inoculations. If a small quantity of anthrax bacilli be injected into the subcutaneous tissue of a guinea-pig a fatal result follows, usually within two days. *Post mortem* around the site of inoculation the

tissues, owing to intense inflammatory œdema, are swollen and gelatinous in appearance, small hæmorrhages are often present, and on microscopic examination numerous bacilli are seen. The internal organs show congestion and cloudy swelling, with sometimes small hæmorrhages, and their capillaries contain enormous

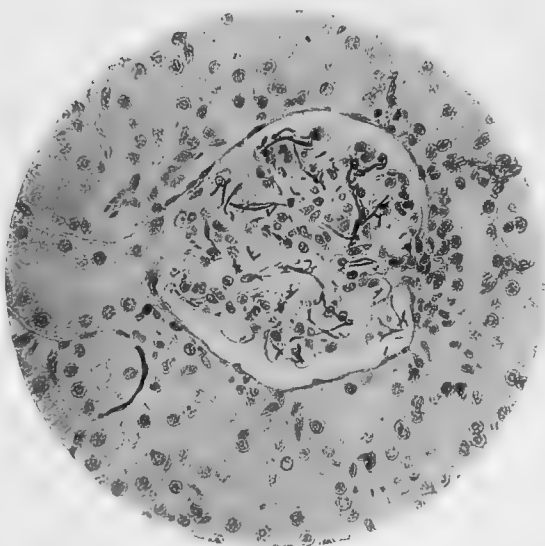

FIG. 112. — Portion of kidney of a guinea-pig dead of anthrax, showing the bacilli in the capillaries, especially of the glomerulus. Paraffin section; stained by Gram's method and Bismarck-brown. $\times 300$.

numbers of bacilli, as has already been described in the case of the ox (Fig. 112); the spleen also shows a corresponding condition. Highly susceptible animals may be infected by being made to inhale the bacilli or their spores, and also by being fed with spores, a general infection rapidly occurring by both methods.

Anthrax in the Human Subject.—As we have noted, man occupies a middle position in the scale of susceptibility to anthrax. It is always communicated to him from animals,

and usually is seen among those whose trade leads them to handle the carcasses or skins of animals which have died of the disease. It occurs in two principal forms, the main difference between which is the site of entrance of the organism into the body. In one, the path of entrance is through cuts or abrasions in the skin, or through the hair follicles. A local condition called a "malignant pustule" develops, which may lead to a general infection. This variety occurs chiefly among butchers and those who work among hides (foreign ones especially). In Britain the workers of the latter class chiefly liable are the hide-porters and hide-workers in South-eastern London. In the other variety of the disease the site of infection is the trachea and bronchi, and here a fatal result almost always follows. The cause is the inhalation of dust or threads from wool, hair, or bristles, which have been taken from animals dead of the disease, and which have been contaminated with blood or secretions containing the bacilli, these having afterwards formed spores. This variety is often referred to as "woolsorter's disease," from its occurring in the centres of the woolstapling trade (in England, chiefly in Yorkshire), but it also is found in places where there are hair and brush factories.

(1) *Malignant Pustule*. — This usually occurs on the exposed surfaces, — the face, hands, forearms, and back, the last being a common site among hide-porters. One to three days after inoculation a small red painful pimple appears, soon becoming a vesicle, which may contain clear or blood-stained fluid, and is rapidly surrounded by an area of intense congestion. Central necrosis occurs and leads to the malignant pustule proper, which in its typical form appears as a black eschar often surrounded by a ring of vesicles, these in turn being surrounded by a congested area. From this pustule as a centre subcutaneous œdema spreads, especially in the direction of the lymphatics; the neighbouring glands are enlarged. There is fever with general malaise. On microscopic section of the typical pustule, the central eschar is noticed to be composed of necrosed tissue and degenerating blood cells; the vesicles are formed by the raising of the stratum corneum from the rete Malpighi. Beneath them and in their neighbourhood the cells of the latter are swollen and œdematous, the papillæ being enlarged and flattened out and infiltrated with inflammatory exudation, which

also extends beneath the centre of the pustule. In the tissue next the eschar necrosis is commencing. The subcutaneous tissue is also œdematous, and often infiltrated with leucocytes. The bacilli exist in the periphery of the eschar and in the neighbouring lymphatics, and, to a certain extent, in the vesicles. It is very important to note that widespread œdema of a limb, enlargement of neighbouring glands, and fever may occur while the bacilli are still confined to the immediate neighbourhood of the pustule. Sometimes the pathological process goes no further, the eschar becomes a scab, the inflammation subsides, and recovery takes place. In the majority of cases, however, if the pustule be not excised, the œdema spreads, invasion of the blood stream may occur, and the patient dies with, in a modified degree, the pathological changes detailed with regard to the acute disease in cattle. In man the spleen is usually not much enlarged, and the organs generally contain few bacilli. The actual cause of death is therefore the absorption of toxins. It may here be said that early excision of an anthrax pustule, especially when it is situated in the extremities, is followed, in a large proportion of cases, by recovery.

(2) *Woolsorter's Disease*. — The pathology of this affection was worked out in this country especially by Greenfield. The local lesion is usually situated in the lower part of the trachea or in the large bronchi, and is in the form of swollen patches in the mucous membrane often with hæmorrhage into them. The tissues are œdematous, and the cellular elements are separated, but there is usually little or no necrosis. There is enormous enlargement of the mediastinal and bronchial glands, and hæmorrhagic infiltration of the cellular tissue in the region. There are pleural and pericardial effusions, and hæmorrhagic spots occur beneath the serous membranes. The lungs show collapse and œdema. There may be cutaneous œdema over the chest and neck, with enlargement of glands, and the patient rapidly dies with symptoms of pulmonary embarrassment, and with a varying degree of pyrexia. It is to be noted that in such cases, though numerous bacilli are present in the bronchial lesions, in the lymphatic glands, and affected tissues in the thorax, comparatively few may be present in the various organs, such as the kidney, spleen, etc., and sometimes it may be impossible to find any.

(3) *Intestinal Infection.*— It is probable that infection occasionally takes place through the intestine; but this condition is rare. In such cases there is a local lesion in the intestinal mucous membrane, of similar nature to that in the bronchial form, with a corresponding affection of the mesenteric glands.

The Toxins of the Bacillus Anthracis.— Various theories were formerly held as to the mode in which the anthrax bacillus produces its effects. One of the earliest was the mechanical, according to which it was supposed that the serious results were produced by extensive blocking of the capillaries in the various organs by the bacilli. According to another, it was supposed that the bacilli used up the oxygen of the blood, thus leading to starvation of the tissues. Though such modes of action may occur to a small extent, we now know that in anthrax, as in other diseases, the important local and general effects are produced by specific poisons formed by the bacilli. We have therefore to consider the nature of these toxic bodies.

During the years 1889–90 several papers were published dealing with the toxins of the bacillus anthracis. Hankin, investigating the means of conferring immunity against the disease, isolated from cultures in a bouillon made from Liebig's meat juice an albumose which he considered to be the toxin. His reason for thinking so was that, while the injection of very small doses of this substance (one five-millionth to one ten-millionth of the weight of an animal) lengthened the incubation period of the disease, and might even ward off a fatal attack, the injection of larger doses hastened the death of the animal. Very full researches on the subject were carried out by Sidney Martin. This observer used alkali-albumin on which to grow the bacillus, this medium approaching most closely to the environment of the latter when growing in the animal body. From cultures in this medium, concentrated by evaporation either at 100° C. or in vacuo at 35° to 45° C., there were isolated proto-albumose, deuterio-albumose, and traces of peptone. The albumoses differed from those which occur in ordinary digestion, in being strongly alkaline in their reaction. This alkalinity, Martin held, was due to traces of an alkaloidal body of which the albumoses were the precursors, and which were formed when the process of digestion of the alkali-albumin by the bacillus was allowed to go on further. By the albumoses

and the alkaloid, pathogenic effects were produced in animals closely similar to those produced by the bacilli themselves. Martin adduced evidence to show that, of the symptoms of the disease, the fever was mostly due to the albumoses, while the œdema and congestion were mostly due to the alkaloid, which acted as a local irritant. He showed that prolonged boiling destroyed the activity of the albumoses, but not that of the alkaloid. Further, from the body fluids of animals dead of anthrax he isolated poisonous bodies similar to those produced by the bacilli growing in this artificial medium. Hankin, in a later research with Wesbrook, arrived at the conclusion that the bacillus anthracis produces a ferment which, diffusing out into the culture fluid, elaborates albumoses from the proteids present in it. The bacilli also produce albumoses directly without the intervention of a ferment. The albumoses produced in the latter way, when injected in small doses, cause in susceptible animals immunity against subsequent inoculation with virulent bacilli, but are only toxic to animals not very susceptible to the disease. Marmier, after cultivating the *B. anthracis* in peptone solution containing certain salts, removed all the albumoses from the resultant liquid, and from them, either by dialysis or extraction with glycerin, isolated a body which gave no reactions of albuminoid matter, peptone, propeptone, or alkaloid. This he considers the toxin. It killed animals susceptible to anthrax by a sort of cachexia, and in suitably small doses could be used to immunise them against subsequent inoculation with virulent bacilli. It was chiefly retained within the bacilli when these were growing in the most favourable conditions. Unlike the toxins of tetanus and diphtheria, and unlike ferments, it was not destroyed by heating to 110° C. The toxin produced by the *B. anthracis* growing in a fluid medium remains intimately associated with the bacterial protoplasm, as such cultures when filtered are relatively non-toxic.

From this account of the researches into the toxins of the *B. anthracis*, it will be seen that our knowledge is far from complete. It is difficult to say what interpretation is to be put on the results of Hankin and Wesbrook. The researches of Marmier rather indicate that, as is the case with the toxins of other bacilli, the toxin of anthrax may belong to a group of non-proteid bodies of whose chemical nature we are in complete

ignorance. Be this as it may, the results detailed open up a way for our arriving at an idea of the true pathology of the disease. The bacilli in all parts of the body, whether directly or intermediately by ferments, produce bodies toxic to tissue cells. Further, bacilli confined locally produce by this means effects on distant tissues. This explains how in certain cases, while the bacilli are still locally confined, there may occur œdema spreading from the pustule, and pyrexia.

The Spread of the Disease in Nature. — We have seen that the *B. anthracis* rarely, if ever, forms spores in the body, and if the bacilli could be confined to the blood and tissues of carcasses of animals dying of the disease, it is certain that anthrax in an epidemic form would rarely occur. For it has been shown by many observers that in the course of the putrefaction of such a carcase the anthrax bacilli rapidly die out, and that after ten days or a fortnight very few remain. But it must be remembered that while still alive, an animal is shedding into the air by the bloody excretions from the mouth, nose, and bowel, myriads of bacilli which may rapidly spore, and thus arrive at a very resistant stage. These lie on the surface of the ground and are washed off by surface water. At certain seasons of the year the temperature is, however, sufficiently high to permit of their germination, and also of their multiplication, as they can undoubtedly grow on the organic matter which occurs in nature. They can again form spores. It is in the condition of spores that they are dangerous to susceptible animals. In the bacillary stage, if swallowed, they will be killed by the acid gastric contents; but as spores, they can pass uninjured through the stomach, and, gaining an entrance into the intestine, infect its wall, and ultimately reach, and multiply in, the blood. It is known that in the great majority of cases of the disease in sheep and oxen, infection takes place thus from the intestine. It was thought by Pasteur that worms were active agents in the natural spread of the disease by bringing to the surface anthrax spores. Koch made direct experiments on this point, and could get no evidence that this was the case. He thinks it much more probable that the recrudescence of epidemics in fields where anthrax carcasses have been buried is due to persistence of spores on the surface which has been infected by the cattle when alive.

The Disposal of the Carcasses of Animals dead of Anthrax. — It is extremely important that anthrax carcasses should be disposed of in such a way as to prevent their becoming future sources of infection. If anthrax be suspected as the cause of death no *post-mortem* examination should be made, but only a small quantity of blood be removed from an auricular vein for bacteriological investigation. If such a carcass be now buried in a deep pit surrounded by quicklime, little danger of infection will be run. The bacilli being confined within the body will not spore, and will die during the process of putrefaction. The danger of sporulation taking place is, of course, much greater when an animal has died of an unknown disease which on *post-mortem* examination has proved to be anthrax, but similar measures for burial must be here adopted. In some countries anthrax carcasses are burned, and this, if practicable, is of course the best means of treating them. The chief source of danger to cattle subsequently, however, proceeds from the infection of fields, yards, and byres with the offal, and the discharge from the mouths, of anthrax animals. All material that can be recognised as such should be burned along with the straw in which the animals have lain. The stalls or buildings in which the anthrax cases have been must be limewashed. Needless to say, the greatest care must be taken in the case of men who handle the animal or its carcass that they have no wounds on their persons, and that they thoroughly disinfect themselves by washing their hands, etc., in 1 to 1000 solution of corrosive sublimate, and that all clothes soiled with blood, etc., from anthrax animals be thoroughly boiled or steamed for half an hour before being washed.

The Immunising of Animals against Anthrax. — Having ascertained that there was ground for believing that in cattle one attack of anthrax protected against a second, Pasteur (in the years 1880–82) elaborated a method by which a mild form of the disease could be given to animals, which rendered harmless a subsequent inoculation with virulent bacilli. He found that the continued growth of anthrax bacilli at 42° to 43° C. caused them to lose their capacity of producing spores, and also gradually to lose their virulence, so that after twenty-four days they could no longer kill either guinea-pigs, rabbits, or sheep. Such cultures constituted his *premier vaccin*, and protected against the subsequent inoculation with bacilli which had been grown for twelve days at the same temperature, and the attenuation of which had therefore not been carried so far. The latter constituted the *deuxième vaccin*. It was further found that sheep thus twice vaccinated now resisted inoculation with a culture which usually would be fatal. The method was to inoculate a sheep on the inner side of the thigh by the subcutaneous injection, from a hypodermic syringe, of about five drops of the *premier vaccin*; twelve days later to again inoculate with the

deuxième vaccin; fourteen days later an ordinary virulent culture was injected without any ill result. This method was applicable also to cattle and horses, about double the dose of each vaccine being here necessary. Extended experiments in France generally confirmed earlier results, and the method was, before long, used to mitigate the disease, which in many departments was endemic and a very great scourge. Since that time the method has been regularly in use. It is difficult to arrive at a certain conclusion as to its merits. Undoubtedly a certain number of animals die of anthrax either after the first or second vaccination, or during the following vaccination. At the end of a year the immunity is lost in about 40 per cent of the animals vaccinated; and thus to be permanently efficacious the process would have to be repeated every year. Further, the immunity is much higher in degree if, after the first and second vaccinations, an inoculation with virulent anthrax is performed. Everything being taken into account, however, there is no doubt that the mortality from natural anthrax is much diminished by this system.

Statistics are available for the twelve years 1882-93. During that time 3,296,815 sheep were vaccinated, with a mortality, either after the first or second vaccination, or during the subsequent twelve months, of .94 per cent, as contrasted with the ordinary mortality in all the flocks of the districts of 10 per cent. During the same time 438,824 cattle were vaccinated, with a mortality of .34 per cent, as contrasted with a probable mortality of 5 per cent if they had been unprotected.

Other means of immunising animals against anthrax have been elaborated, but these have a more strictly scientific interest. In dealing with the toxins of anthrax we have already referred to the work of Hankin and Wesbrook on this point. We have also seen that Marmier succeeded in immunising animals by using a toxin isolated by him. Even, however, as a method of immunising animals for scientific observations Pasteur's method still obtains.

Serum Anticharbonneux.—The properties of the serum of animals vaccinated against anthrax have been investigated by Marchoux. The animals were immunised in the usual way. The serum of sheep and especially of rabbits was found to afford a certain degree of protection to susceptible animals against subsequent inoculation with virulent bacilli. It also exhibited

a small degree of curative action. When it was injected immediately after inoculation with the bacilli a certain number of the animals survived, but in proportion as the symptoms of the disease (œdema, fever, etc.) were established, so was the curative effect diminished, even though large doses of the serum were employed. These results have been in the main confirmed by other observers. The difficulties in the way of the therapeutic use of such sera, which aim at the killing of infecting bacteria, will be discussed in connection with Immunity: here it need only be said that different bodies must be present in a serum in order that it may be efficacious, and if all the factors are not present, then a serum may have little or no action. In this connection it may be mentioned that, according to de Nittis, the serum of a pigeon immunised against anthrax will protect a guinea-pig against a fatal infection. The serum of an immune guinea-pig, on the other hand, will not protect a fresh guinea-pig or a mouse against such an infection.

Methods of Examination. — These include (a) microscopic examination; (b) the making of cultures; and (c) test inoculations.

(a) *Microscopic Examination.* — In a case of suspected malignant pustule, film preparations should be made from the fluid in the vesicles or from a scraping of the incised or excised pustule, and stained with a watery solution of methylene-blue and also by Gram's method. By this method practically conclusive evidence may be obtained; but sometimes the result is doubtful, as the bacilli may be very few in number. In all cases confirmatory evidence should be obtained by culture. Occasionally they are so scanty that both film preparations made from different parts and even cultures may give negative results, and yet a few bacilli may be found when a section of the pustule is examined. It should be noted that the greatest care ought to be taken in manipulating a pustule before excision, as the diffusion of the bacilli into the surrounding tissues may be aided and the condition greatly aggravated. The examination of the blood in cases of anthrax in man usually gives negative results, with the exception of very severe cases, when a few bacilli may be found in the blood shortly before death, though even then they may be absent.

(b) *Cultivation.* — A small quantity of the material used for microscopic examination should be taken on a platinum needle,

and successive strokes made on agar tubes, which are then incubated at 37° C. At the end of twenty-four hours anthrax colonies will appear, and can be readily recognised from their wavy margins, by means of a hand lens. They should also be examined microscopically by means of film preparations.

(c) *Test Inoculations.*—A little of the suspected material should be mixed with some sterile bouillon or water, and injected subcutaneously into a guinea-pig or mouse, or it may be introduced into the subcutaneous tissue by means of a seton. If anthrax bacilli are present, the animal usually dies within two days, with the changes in internal organs already described.

CHAPTER XV.

TYPHOID FEVER—BACILLI ALLIED TO THE TYPHOID BACILLUS.

OTHER NAMES:—ENTERIC FEVER: GASTRIC FEVER. GERMAN, TYPHUS ABDOMINALIS: ABDOMINALTYPHUS: UNTERLEIBS-TYPHUS. FRENCH, LA FIÈVRE TYPHOÏDE.

Historical Summary.—The first definite descriptions of what is now known as the *bacillus typhosus* appeared about 1880–81, when it was described by Eberth, Koch, and Klebs; and on account of priority of publication by the first-named observer it is often called Eberth's bacillus. Eberth in certain cases of the disease found on microscopic examination characteristic bacilli in the intestinal ulcers, in the spleen, and in the lymphatic glands, but made no attempts to grow them outside the body. Gaffky (1884) confirmed Eberth's observations and obtained from the spleen pure cultures in gelatin. He further described very fully the morphological character of the bacilli, and held that the bacilli were not putrefactive, as they did not produce putrefactive effects on artificial media; but all his attempts to reproduce by their means the disease in different species of animals (including monkeys) were unsuccessful. The position, therefore, was that in the great majority of cases of typhoid fever, characteristic bacilli could be found and isolated in pure culture, but that these did not give rise to the disease in animals.

The question of the significance of the occurrence of the *B. typhosus* was complicated when, in 1885, Escherich, working on the first appearance of organisms in the bowel of the new-born infant, described a bacillus which he named the *bacillus coli communis*, sometimes called Escherich's bacillus. This also was shown to be identical with the *bacillus neapolitanus* which Emmerich found in the intestines of the victims of a cholera epidemic at Naples. Weisser, who worked at the subject, pointed out that the *B. coli* was a normal inhabitant of the human intestine; and, further, comparing the growth characters of this bacillus with those of the typhoid bacillus, noted the similarities which exist between the two microbes. From this time forward, the

question of the morphological relationships of the two organisms has played an important part in the bacteriological investigation of the subject. There has been much controversy as to whether they are varieties of the same species, the result of which is a growing conviction that the two are really distinct.

The Bacillus Typhosus.—*Microscopic Appearances.*—It is sometimes difficult to find the typhoid bacilli in the organs of a typhoid patient. Numerous sections of different parts of a spleen, for example, may be examined before a characteristic group is found. The best tissues for examination are a Peyer's patch where ulceration has not yet commenced or where it is just commencing, the spleen, the liver, or a mesenteric gland. The spleen and liver are better than the other tissues named, as in the latter the presence of the *B. coli* is more frequent. From scrapings of such solid organs dried films may be prepared and stained for a few minutes in the cold by any of the strong staining solutions, *e.g.* with carbol-thionin-blue, or with Ziehl-Neelsen's carbol-fuchsin diluted with five parts of distilled water. As a rule decolorising is not necessary. For the proper observation of the arrangement of the bacilli in the tissues, paraffin sections should be prepared and stained in carbol-thionin-blue for a few

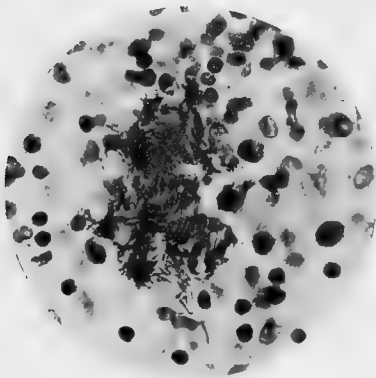

FIG. 113.—A specially large clump of typhoid bacilli in a spleen. The individual bacilli are only seen at the periphery of the mass. (In this spleen enormous numbers of typhoid bacilli were shown by cultures to be present in a practically pure condition.) Paraffin section; stained with carbol-thionin-blue. $\times 500$.

minutes, or in Löffler's methylene-blue for one or two hours. The bacilli take up the stain somewhat slowly, and as they are also easily decolorised, the aniline-oil method of dehydration may be used with advantage (*vide p. 100*). In such preparations the characteristic appearance to be looked for is the occurrence of groups of bacilli lying between the cells of the tissue (Fig. 113). The individual bacilli are $2\ \mu$ to $4\ \mu$ long, with somewhat oval ends, and $.5\ \mu$ in thickness. Sometimes filaments $8\ \mu$ to $10\ \mu$ long may be observed, though they are

less common than in cultures. It is evident that one of the short oval forms may frequently in a section be viewed end-

wise, in which case the appearance will be circular. This appearance accounts for some, at least, of the coccus-like forms which have been described. The bacilli are decolorised by Gram's method.

Isolation and Appearances of Cultures. — To grow the organism artificially it is best to isolate it from the spleen or gall-bladder, as it exists there in greater numbers than in the other organs, and may be the sole organism present even some time after death. The spleen is removed whole, and a portion of its capsule is seared with a cautery to destroy all superficial contaminating organisms. A small incision is made into the organ with a sterile knife, a little of the pulp removed by a platinum needle, and agar or gelatin plates are prepared, or successive strokes made on agar tubes. In like manner the gall-bladder is seared and punctured and cultures made from the bile. On the agar media the growths are visible after twenty-four hours' incubation at 37° C. On agar plates the superficial colonies appear as circular spots, dull white by reflected light, bluish-grey by transmitted light. Colonies in the substance of the agar are small, and appear as minute round points. When viewed under a low objective, the surface colonies are found to be very transparent (requiring a small diaphragm for their definition), finely granular in appearance, and with a very coarsely crenated and well-defined margin. The deep colonies are usually spherical, sometimes lenticular in shape, and are smooth or finely granular on the surface, and more opaque than the superficial colonies. On making cover-glass preparations, the bacilli are found to present the same microscopic appearances as are observed in preparations from solid organs, except that there may be a greater number of the longer forms which may almost be called filaments (Fig. 113). The same is true of films made from young gelatin colonies. Sometimes the diversity in the

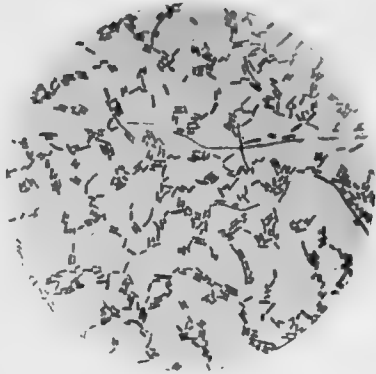

FIG. 114. — Typhoid bacilli; from a young culture on agar, showing some filamentous forms. Stained with weak carbol-fuchsin. $\times 1000$.

length of the bacilli is such as to throw doubts on the purity of the culture. Its purity, of course, can be readily tested by preparing plates from it in the usual way. As a general rule in a

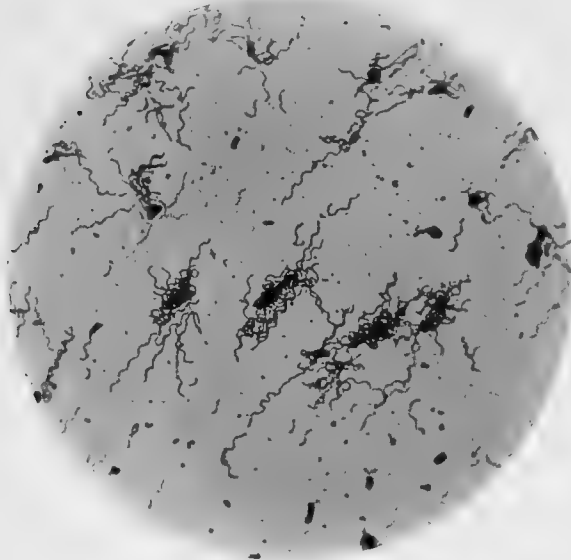

FIG. 115. — Typhoid bacilli, from a young culture on agar, showing flagella. Stained by Van Ermengem's method. $\times 1000$.

young (twenty-four to forty-eight hours old) colony, grown at a uniform temperature, the bacilli are plump, and the protoplasm stains uniformly. In old cultures or in cultures which have been exposed to change of temperature, the protoplasm stains only in parts; there may be an ap-

pearance of irregular vacuolation either at the centre or at the ends of the bacilli. There is no evidence that spore formation occurs in the typhoid bacillus.

Motility. — In hanging-drop preparations the bacilli are found to be actively motile. The smaller forms have a darting or rolling motion, passing quickly across the field, whilst some show rapid rotatory motion. The filamentous forms have an undulating or serpentine motion, and move more slowly. Hanging-drop preparations ought to be made from agar or broth cultures not more than twenty-four hours old. In older cultures the movements are less active.

Flagella. — On being stained by the appropriate methods (*vide p. 107*) the bacilli are seen to possess many long wavy flagella which are attached all along the sides and to the ends (Fig. 115). They are more numerous, longer, and more wavy than those of the *B. coli*.

Characters of Cultures. — Stab-cultures in *peptone gelatin* give

a somewhat characteristic appearance. On the surface of the medium growth spreads outwards from the puncture as a thin film or pellicle, with irregularly wavy margin (Fig. 116, A). It is semi-transparent and of a bluish-white colour. Ultimately this surface growth may reach the wall of the tube. Not infrequently, however, the surface growth is not well marked. Along the stab there is an opaque whitish line of growth, of finely nodose appearance. There is no liquefaction of the medium, and no formation of gas. In stroke-cultures there is a thin bluish-white film, but it does not spread to such an extent as in the case of the surface growth of a stab-culture (Fig. 116, B). In



FIG. 116.

A. Stab-culture of the typhoid bacillus in gelatin, five days' growth.

B. Stroke-culture of the typhoid bacillus on gelatin, six days' growth.

C. Stab-culture of the bacillus coli in gelatin, nine days' growth; the gelatin is split in its lower part owing to the formation of gas.

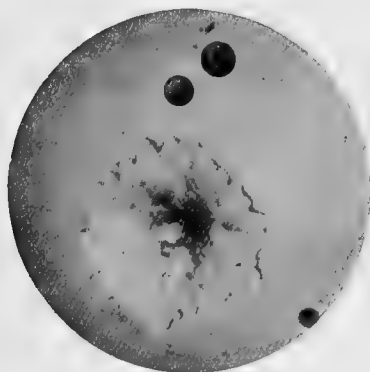

FIG. 117. — Colonies of the typhoid bacillus (one superficial and three deep) in a gelatin plate. Three days' growth at room temperature. $\times 15$.

gelatin plates also the superficial and deep colonies present corresponding differences. The former are delicate semi-transparent films, with wavy margin, and are much larger than the colonies in the substance, which appear as small round points (Fig. 117). These appearances, which are well seen on the third or fourth day, resemble those seen in agar plates, as already described in the method of isolation; but on gelatin the surface colonies are rather more transparent than those on

agar. Their characters, as seen under a low power of the microscope, also correspond.

In stroke-cultures on *agar* there is a bluish-grey film of growth, with fairly regular margins, but without any characteristic features. This film is loosely attached to the surface, and can be easily scraped off.

The growth on *potatoes* is most important. For several days (at ordinary temperature) after inoculation there is apparently no growth. If looked at obliquely, the surface appears wet, and if the surface is scraped with the platinum loop, a glistening track is left; a cover-glass preparation shows numerous bacilli. Later, however, a slight pellicle with a dull, somewhat velvety surface, may appear, and this may even assume a brown appearance. These characteristic appearances are only seen when a fresh potato with an acid reaction has been used. In America, at least, the so-called invisible growth upon potato which was formerly looked upon as the most important means of recognition has proven to be a very unreliable test. For, on potatoes from some sections of the country, a growth quite like that of *B. coli* is more often the rule than the exception. This can possibly be due either to the variety of the potato, or to some variation in its composition dependent upon the character of the soil in which it grows, acidity apparently having nothing to do with the phenomena of visible or invisible growths.

* In *bouillon* incubated at 37° C. for twenty-four hours, there is simply a uniform turbidity. Cover-glass preparations made from such sometimes show filamentous forms of considerable length, without apparent segmentation.

In *litmus milk* a slight degree of acidity is produced, causing the milk to assume a lilac colour; more rarely, in some instances this acidity diminishes and is lost, being replaced by a strong degree of alkalinity. No coagulation of casein occurs.

Conditions of Growth, etc. — The optimum temperature of the typhoid bacillus is about 37° C., though it also flourishes well at the room temperature. It will not grow below 9° C. or above 42° C. Growth takes place in anaerobic as well as in aerobic conditions. Its powers of resistance correspond with those of most non-sporing bacteria. It is killed by exposure for half an hour at 60° C., or for two or three minutes at 100° C. Typhoid bacilli kept in distilled or ordinary tap

water have usually been found to be dead after three weeks (Frankland).

The *Bacillus coli communis*.—This bacillus is the chief organism present in the small intestine in normal conditions, and, with many other bacteria, it also inhabits the large intestine. During typhoid fever, and other pathological conditions affecting the intestines, it is relatively and absolutely enormously increased in the latter situation, where it may sometimes be almost the only bacillus present. Its relations to various suppurative and inflammatory conditions are described in the chapter on Suppuration (p. 196). Microscopically it has the same appearances and staining reaction as the typhoid bacillus, and like the latter also presents variations in size, though it is usually somewhat shorter (Fig. 118). It is usually sluggishly motile, but occasionally motility seems to be quite absent, and it possesses lateral flagella, which, however, are fewer in number and somewhat shorter than those of the typhoid bacillus. It is easily isolated from the stools of men and animals by any of the ordinary methods. After, *e.g.* twenty-four hours' incubation at 37° C. on agar, there are large superficial colonies and small deep colonies in the plates. To the naked eye they are denser and more glistening than those of typhoid when viewed by transmitted light, and rather of a brownish-white colour. Under a low objective the colonies, again, appear denser than those of the typhoid bacillus and more granular. On ordinary gelatin and agar media the appearances are similar to those of the typhoid bacillus, but the growth is whiter, thicker, and more opaque, and gives the impression of having greater vigour. In the case of gelatin stab-cultures a few gas bubbles sometimes develop in the medium (Fig. 116, C) due to presence of muscle sugar in the beef infusion. On potatoes in forty-eight hours there is a distinct film of growth of brownish tint and moist-looking surface, which rapidly spreads

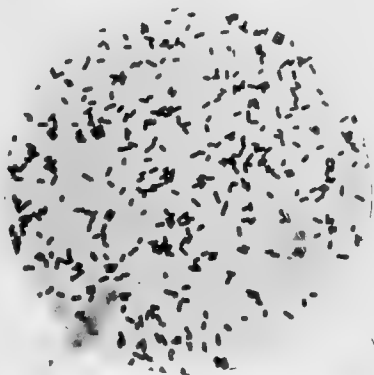

FIG. 118. — *Bacillus coli communis*. Film preparation from a young culture on agar. Stained with weak carbol-fuchsin. $\times 400$.

and becomes thicker. This contrasts very markedly with the colourless film of the *B. typhosus*. Litmus milk assumes within eighteen hours a marked acidity as shown by the red colour of the medium, and the milk is usually coagulated at any period within four days to one month. Occasionally some varieties are met with which actually fail to cause coagulation.

The Comparative Culture Reactions of the *B. typhosus* and the *B. coli*. — The importance of the relationships between the *B. typhosus* and the *B. coli* has caused great attention to be paid to their biological characters, in order to facilitate the distinction of the one from the other. Some of these we have already noted. Of the morphological characters the growth on potatoes is the most important. As has been pointed out by Wathelet, and also by Klein, differences exist in the growth of the two bacilli in melted gelatin. A gelatin tube is inoculated, and, instead of being kept at the room temperature, is placed in the incubator at 37° C., at which temperature it is of course fluid. In such cultures, in the case of the *B. typhosus*, there is a general turbidity of the gelatin, while with the *B. coli* there are large flocculi developed which float on the surface. It is, however, to physiological differences between the bacilli, rather than to morphological, that importance is to be attached. Several important points are to be studied hereon.

(1) *The Fermentation of Sugars.* — Chantemesse and Widal were the first to show that the *B. coli* produced an acid fermentation in lactose (milk sugar). Their method was as follows: To tubes of 2 per cent lactose bouillon about 1 gramme of sterilised calcium carbonate was added in each case, and the tubes were then sterilised. On inoculating such a tube with *B. coli*, the acid produced by the fermentation (chiefly lactic acid) acts on the calcium carbonate, setting free bubbles of carbon dioxide which collect on the surface of the liquid. The production of acid in lactose gelatin by the *B. coli* can also be observed by adding to tubes sufficient blue litmus to make the whole distinctly blue. If a stab-culture be made in such a tube, a red colour diffuses out in the gelatin from the line of growth, and bubbles of gas also form. Later the medium becomes decolorised by reduction of the litmus. The addition of lactose or other sugars to a simple solution of peptone, however, gives more accurate results (p. 80). The fermentation of lactose by *B. coli*

may also be demonstrated by means of Petruschky's litmus-whey (p. 41).

The fermentation of sugars is a very important effect of the growth of the *B. coli*.¹ In a culture on a medium equally rich in lactose, for example, and peptone, the former will be broken up and the latter be left practically unaffected. According to the first results of Chantemesse and Widal, the *B. typhosus* did not ferment lactose; and Péré stated that though it cannot ferment cane sugar or lactose, it can originate such a change in arabinose, galactose, levulose, and dextrose, but with regard to the last this is very doubtful. Petruschky, however, holds that it can break up lactose in litmus-whey. Much seems to depend upon what other constituents are present in the medium, and also on its reaction. The fermentative power of the typhoid bacillus is undoubtedly much less active than that of the *B. coli*; and as a matter of practical experience the formation of bubbles of gas in Chantemesse and Widal's lactose medium is rarely observed. The test may, therefore, be taken in conjunction with others, as of use in diagnosing the identity of the bacillus.

Dextrose agar and dextrose gelatin (2 per cent) are also valuable media. The typhoid bacillus in all cases produces no gas in these media, while with the *B. coli* gas production is observed in from twenty-four to forty-eight hours.

Curdling of Milk by the B. Coli. — This probably depends on the fermentation of the lactose of the milk, and the throwing down of the casein by the resulting lactic acid; but the action may be a more complicated one, as milk can be curdled by organisms which do not possess acid-forming properties.

Formation of Acids in Ordinary Media. — If ordinary litmus bouillon or gelatin be inoculated with the *B. typhosus* or the *B. coli*, a production of acid will be observed during the early period of growth, but the acid reaction is more quickly produced by the *B. coli*.

With such media Péré found that in the case of both microbes there was for forty-eight hours a production of acid. At the end of five days, however, typhoid cultures were alkaline, and in cultures of *B. coli* the acidity, though present, was diminished. Ordinary media contain sugars derived from the

¹ For fuller information the student is referred to the valuable article of Professor Theobald Smith on "The Fermentation-tube," in the Wilder Quarter-Century Book, 1893, p. 187.

meat from which they are made, and the acidity might proceed from the fermentation of these. In media made with pure syntonin or peptone, though there was an initial slight acid formation, especially with the *B. coli*, still in the case of both organisms at the end of four days the reaction was alkaline. The reaction is, therefore, probably a double one, but the resulting acidity in ordinary cases may be due to fermentative changes in carbohydrates. Here again the acid-forming capacities of the *B. typhosus* are inferior to those of the *B. coli*.

(2) *Production of Gas by the B. coli.*—The production of gas in various media by the *B. coli* can be demonstrated by any of the methods described (p. 78). Shake-cultures are usually employed. According to Klein the gas produced is methane. We have found, however, that in a shake-culture in peptone solution with 10 per cent gelatin added the *B. coli* produces no gas, but bubbles rapidly form if the medium has added to it a trace of lactose. No such development of gas occurs in a shake-culture of typhoid in any of these media.

(3) *Formation of Indol.*—Among the bacteria capable of forming indol is to be classed the *B. coli*. Indol can be recognised in bouillon cultures of the *B. coli* three to four days old by the usual tests (*vide* p. 80). As there is no evidence that it can produce nitrites, a small quantity of the latter must be added. The typhoid bacillus rarely gives this reaction when growing in ordinary conditions, but on the other hand, it appears that some varieties of the *B. coli* fail to produce it also. Peckham, however, has found that if the typhoid bacillus be grown in peptone solution,¹ after a few generations of three days each it may acquire the property of producing indol. The formation of indol by an organism after the first transference to peptone solution from one of the ordinary media may, however, be accepted as evidence in favour of the organism not being the

¹ Peckham directs this medium to be made as follows:—

Beef muscle	225 grms.
Trypsin	4 "
Sodium chloride	5 "
Water	1 litre

The beef as old as can be gotten, so as to avoid muscle sugar being present, is chopped fine and put into 500 c.c. of water and the mixture made alkaline with sodium carbonate. The vessel containing the mixture is placed upon a water bath at 40° C. and the trypsin is added. Digest from one to one and a half hours, again render alkaline and bring the mixture to the boil, strain through gauze and filter when cold. The reaction of the medium must be such as to require 20–30 c.c. of a decimal solution of caustic soda to bring it to the neutral point of phenol-phthaleine.

typhoid bacillus. It is to be noted here that the presence of lactose or dextrose in a medium prevents the production of indol by the *B. coli*. The indol reaction thus ought to be sought for in a sugar-free medium.

(4) *Agar containing Neutral-red.*—The method here is to take sterile tubes of this medium (see p. 42) and either make stab or shake cultures and incubate for twenty-four hours at 37° C. In the case of the typhoid bacillus no change in the colour occurs, but in the case of the *B. coli* there is developed a beautiful canary yellow with a greenish fluorescence. The value of the medium as a means of differentiating the two organisms is still *sub judice*. Fitz Gerald and Dreyer have shown that a very important factor is the reaction of agar or glucose agar, and consider the difference in the effects of the two bacteria only one of degree. They state that the best results are obtained by employing as a medium a 3 per cent lactose bouillon, to which .5 per cent of a 1 per cent watery neutral-red has been added.

(5) *The Media of Capaldi and Proskauer.*—The first of these is a medium free of albumin, in which *B. coli* grows well and freely produces acid, while the typhoid bacillus hardly grows at all, and certainly will produce no change in the reaction. Its composition is as follows:—

Asparagin	0.2 grms.
Mannite	0.2 ”
Sodium chloride	0.02 ”
Magnesium sulphate	0.01 ”
Calcium chloride	0.02 ”
Potassium monophosphate	0.2 ”
Water (distilled)	100.00 c.c.

The second medium contains albumin, and is such that the *B. coli* produces no acid, while the typhoid bacillus grows well and produces an acid reaction. It consists of:—

Witte's peptone	2.0 grms.
Mannite	0.1 ”
Water (distilled)	100.0 c.c.

After the constituents of each medium are mixed and dissolved it is steamed for one and a half hours and litmus solution added (the tint being judged of by experience), and the medium is then

made neutral—the first medium, being usually naturally acid, by sodium hydrate, the second, being usually alkaline, by citric acid. The medium is then filtered, filled into tubes containing 5 c.c., and these are sterilised. After inoculation the characteristic appearances ought to manifest themselves in about twenty hours.

(6) *Growth on Phenolated Media.*—It was at one time thought the addition of .2 per cent carbolic acid to the ordinary media inhibited the growth of all bacteria but the typhoid bacillus. It has been found, however, that the growth of the *B. coli* is also unaffected by such a medium, though it prevents the growth of most putrefactive organisms which liquefy gelatin.

(7) *The Application of the Agglutination Test in distinguishing B. typhosus from B. coli.*—The scope of the application of this test will be discussed later (see Immunity). Here we may say that a negative result obtained with a suspected *B. typhosus* culture is of greater value than a positive result obtained with a suspected *B. coli* culture. The test is only to be taken in conjunction with the other means of differentiating the two organisms and is not strictly a crucial one.

It will thus be seen that the diagnosis between the *B. typhosus* and the *B. coli* is a matter of no small difficulty. The points to be attended to in making such a diagnosis have been given above. There is no evidence that the one organism ever passes into the other. Klein has found that both after prolonged sojourn in distilled and tap water, and also after passage through the bodies of a series of animals, each organism still preserves its original characters. Statements as to their identity usually rest on theoretical considerations, or on purely negative evidence. Great difficulties sometimes arise in consequence of a bacillus being found which, while giving a number of the characteristics of either one or the other, fails to give some of the characteristic tests, or only gives them very slowly. This is especially true of organisms related to the *B. coli*. It has consequently become common to speak of the typhoid group and the coli group in order that such varieties may be included. In the coli group cases may be met with which do not give an indol reaction (the so-called paracolony group), which do not curdle milk, or which do not produce gas, and Gordon even includes varieties producing alkali, or slowly liquefying gelatin. Three of the most important varieties, the bacillus enteritidis

(Gaertner), the so-called paracolou bacillus, and the bacillus of psittacosis may be described.

Bacillus Enteritidis (Gaertner).—In 1888 Gaertner, in investigating a number of cases of illness resulting from eating the flesh of a diseased cow, isolated, not only from the meat but from the spleen of a man who died, a bacillus *which presents all the characteristics of the B. typhosus except that it ferments dextrose* and is very pathogenic to animals. In the latter, whatever the method of introduction, there is an intense hæmorrhagic enteritis with swelling of the lymph follicles. The distribution of the bacilli varies in different cases, but usually they are present in the solid organs. In man also the symptoms are centred in the intestine, and hence the name given to the bacillus. During recovery a very characteristic point is the occurrence of desquamation of the epidermis. Since it was described by Gaertner others have isolated the bacillus under similar circumstances. Its toxic products have been found to be very pathogenic to animals, and in man cases of illness have occurred when broth made from the diseased flesh has been partaken of. When there is an infection by the bacillus itself, symptoms usually begin after twenty-four hours. Many cases, however, of an earlier illness have occurred, no doubt due to the action of toxins already existing in the meat. During the last few years, in some epidemics of meat-poisoning, similar bacilli differing slightly from Gaertner's bacillus have been isolated, *e.g.* by Durham, and it is probable that here also we have to do not with one variety but with a group of bacilli, probably of the same species and possessing more or less similar pathogenic properties.

The Paracolou (Paratyphoid) Bacillus.—Under the names paracolou or paratyphoid bacillus, Widal, Gwyn, Schottmüller, and others in Europe and America, have described bacilli associated with continued fevers, whose clinical features were identical with those of typhoid fever, but in none of which could the presence of *B. typhosus* be positively determined by either blood reaction or by cultural means. Morphologically, these bacilli resemble *B. typhosus* closely, but may be readily differentiated from it both culturally and by serum reaction. They ferment glucose, but not lactose or saccharose; litmus milk at first strikes a mild acid reaction, with a blue-green créam-ring, but about the fourth or fifth day gradually loses this acidity and slowly becomes alkaline, with no coagulative phenomena; the potato growth is usually like that of *B. coli*, but may be at times almost invisible; the production of indol is inconstant. Typhoid sera fail to agglutinate paracolou bacilli, and *vice versa*, paracolou sera never clump *B. typhosus*; and further, the serum from one paracolou infection may not be able to agglutinate the bacilli derived from another. From *B. coli* they are easily distinguished by their fermentative reactions and by their behaviour in litmus milk. Their position is undoubtedly in that group designated by Durham, in his interesting study of colon bacillus and allied forms, as the *B. enteritidis* group.

The Psittacosis Bacillus.—When parrots are imported from the tropics in large numbers many die of a septicæmic condition in which an enteritis, it may be hæmorrhagic, is a marked feature. There is intense congestion of all the organs and peritoneal ecchymoses. From the spleen, bone marrow, and blood there has been isolated a short actively motile bacillus with rounded

ends which does not stain by Gram's method. *It grows on all ordinary media, and on potato resembles B. coli. It does not liquefy gelatin, does not ferment lactose, does not curdle milk, and gives no indol reaction.* The parrot is most susceptible to its action, but it also causes a fatal hæmorrhagic septicæmia in guinea-pigs, rabbits, mice, pigeons, and fowls, the bacilli after death being chiefly in the solid organs. From affected parrots the disease appears to be readily communicable to man, chiefly, it is probable, from the feathers being soiled by infective excrement. Several small epidemics have been recognised and investigated in Paris. After about ten days' incubation, headache, fever, anorexia occur, followed by great restlessness, delirium, vomiting, often diarrhœa, and albuminuria. Frequently broncho-pneumonia supervenes, and a fatal result has followed in about a third of the cases observed. The organism has been isolated from the blood of the heart. The psittacosis bacillus is evidently one of the typhoid group, a fact which is further borne out by the observation that it is clumped by a typhoid serum — 1-10 (normal serum having no result). The clumping is, however, said to be incomplete, as the bacilli between the clumps may retain their motility. It differs from the typhoid bacillus in its growth on potatoes and in its pathogenicity.

Pathological Changes in Typhoid Fever. — Here we confine our attention solely to the bacteriological aspects of the disease. The inflammation and ulceration in the *Peyer's patches and solitary glands of the intestines* are the central features. In the early stage there is produced an acute inflammatory condition, attended with extensive leucocytic emigration and sometimes with small hæmorrhages. At this period the typhoid bacilli are most numerous in the patches, groups being easily found between the cells. The subsequent necrosis is evidently in chief part the result of the action of the toxic products of the bacilli, which gradually disappear from their former positions, though they may still be found in the deeper tissues and at the spreading margin of the necrosed area. They also occur in the lymphatic spaces of the muscular coat. It is to be remarked that the number of the ulcers arising in the course of a case bears no relation to its severity. Small ulcers may occur in the lymphoid follicles of the large intestine. In this regard some interesting observations have of late been made by Chiari and Krause, Flexner and Harris, Lartigau, and Ophüls, wherein they state that these typical ulcerative lesions of the intestine may be entirely wanting, (or so poorly developed as to be overlooked [Opie and Bassett]), and yet the bacilli be found in the various organs or blood.

The *mesenteric glands*, corresponding to the affected part of the intestine are usually enlarged, sometimes to a very great

extent, the whole mesentery being filled with glandular masses. In such glands there may be acute inflammation, and occasionally necrosis in patches occurs. Sometimes on section the glands are of a pale-yellowish colour, the contents being diffuent and consisting largely of leucocytes. Typhoid bacilli may be isolated both from the glands and the lymphatics connected with them, but the *B. coli* is in addition often present.

The *spleen* is enlarged, — on section usually of a fairly firm consistence, of a reddish-pink colour, and in a state of congestion. Of all the solid organs it usually contains the bacilli in greatest numbers. They can be seen in sections, occurring in clumps between the cells, there being no evidence of local reaction round them (Fig. 113). Similar clumps may occur in the *liver* in any situation, and without any local reaction. In this organ, however, there are often small foci of leucocytic infiltration, in which, so far as our experience goes, bacilli cannot be demonstrated. Clumps of bacilli may also occur in the *kidney*.

In addition to these local changes in the solid organs there are also widespread *cellular degenerations* in the solid organs which suggest the circulation of soluble poisons in the blood.

In the *lungs* there may be bronchitis, patches of congestion and of acute broncho-pneumonia. In these, typhoid bacilli may sometimes be observed, but evidence of a toxic action depressing the powers of resistance of the lung tissue is found in the fact that the pneumococcus is frequently found in such complications of typhoid fever.

The studies of Voinot and of Nichols show that the *nervous system* is often seriously affected by marked alterations in the motor nerve cells of the ventral horns of the spinal cord and in the cells of the posterior root ganglia, with extensive degeneration of the peripheral nerves as well. Meningitis and brain abscess have been reported by McDaniel and McClintock.

The *blood* in typhoid fever in probably 80 per cent of all cases contains the specific bacillus, as shown by the researches of Schottmüller, Auerbach and Unger, and Cole; at times the bacilli precede the appearance of the agglutination phenomenon. Judging from the results obtained by Karlinski, Richardson, Gwyn, and others *B. typhosus* can be isolated from the *urine* in 25 per cent of all cases of the disease. That the *rose-spots* contain the bacilli seems undoubtedly proven by the researches of Neufeld, Curschmann, and Richardson.

To sum up the pathology of typhoid fever we have in it a disease, the centre of which lies in the lymphoid tissue in and connected with the intestine. In this situation we must have an irritant, against which the inflammatory reaction is set up, and

which in the intestine is sufficiently powerful to cause necrosis. The affections of the other organs of the body suggest the circulation in the blood of poisonous substances capable of depressing cellular vitality, and producing histological changes.

Suppurations occurring in connection with Typhoid Fever. — With regard to the relation of the typhoid bacillus to such conditions, statements as to its isolation from pus, etc., can be accepted only when all the points available for the diagnosis of the organism have been attended to. On this understanding the following summary may be given. In a small proportion of the cases examined the typhoid bacillus has been the only organism found. This has been the case in subcutaneous abscesses, in suppurative periostitis, suppuration in the parotid, submaxillary, and thyroid glands, abscesses in the kidneys, etc., and probably also in one or two cases of ulcerative endocarditis. But in the majority of cases other organisms, especially the *B. coli* and the pyogenic micrococci, have been obtained, the typhoid bacillus having been searched for in vain. It has, moreover, been experimentally shown, notably by Dmochowski and Janowski, that suppuration can be experimentally produced by injection in animals, especially in rabbits, of pure cultures of the typhoid bacillus, the occurrence of suppuration being favoured by conditions of depressed vitality, etc. These observers also found that when typhoid bacilli were injected along with pyogenic staphylococci, the former died out in the pus more quickly than the latter. Accordingly, in clinical cases where the typhoid bacillus is present alone, it is improbable that other organisms were present at an earlier date.

Pathogenic Effects produced in Animals by the Typhoid Bacillus. — There is no disease known to veterinary science which can be said to be identical with typhoid, nor is there any evidence of the occurrence of the typhoid bacillus under ordinary pathological conditions in the bodies of animals. All attempts to communicate the disease to animals by feeding them on typhoid dejecta have been unsuccessful, and though pathogenic effects have been produced by introducing pure cultures in food, the disease has borne no resemblance to human typhoid. The most successful experiments have been those of Remlinger, who continuously fed rabbits on vegetables soaked in water containing typhoid bacilli. In a certain proportion of animals symptoms

appeared about the sixth day, and the contamination of the food was then stopped. The illness which followed was characterised by general weakness, diarrhoea, and pyrexia (the temperature curve being of the nature of that seen in human typhoid), and the agglutination reaction (*vide infra*) was obtained. In some cases recovery took place after eight to twelve days' illness; sometimes death after twelve to eighteen days. *Post mortem* there was observed congestion of the small intestine, especially of the last part, and of Peyer's patches, enlargement of mesenteric glands and spleen, and in the latter typhoid bacilli were present. The blood was sterile. The chief objection which can be urged against these experiments is that they were performed in the rabbit—an animal very liable to be affected by pathogenic agents in peculiar ways.

While feeding experiments are thus rather unsatisfactory, the same may be said of the results of subcutaneous or intraperitoneal infection. Here, again, pathogenic effects can easily be produced by the typhoid bacillus, but these effects are of the nature of a short acute illness characterised by pyrexia, rapid loss of weight, inability to take food, and frequently ending fatally in from twenty-four to forty-eight hours. The type of disease is thus very different from what occurs naturally in man. In such injection experiments the results vary considerably, sometimes scarcely any effect being produced by a large dose of a culture. This is no doubt due to the fact that different cases of the bacillus vary much in virulence. Ordinary laboratory cultures are often almost non-pathogenic. They can, however, be made virulent in various ways. This Chantemesse and Widal effected by injecting along with the typhoid culture the sterilised products of the streptococcus pyogenes, and Sanarelli used for the same purpose sterilised cultures of the *B. coli*, which were injected intraperitoneally at the same time as a typhoid bacillus was introduced subcutaneously. After this procedure had been repeated through a series of animals, a culture of typhoid was obtained of exalted virulence. Sidney Martin has obtained virulent cultures by passing bacilli, derived directly from the spleen of a person dead of typhoid fever, through the peritoneal cavities of a series of guinea-pigs.

Sanarelli, studying the effects of the intraperitoneal injection of a few drops of a culture of highly exalted virulence, found

that the Peyer's patches and solitary glands of the intestine were enormously infiltrated, sometimes almost purulent, and that they contained typhoid bacilli, as also did the mesenteric lymphatics and glands, and the spleen. Sanarelli states that by whatever path the bacilli were introduced into the body, the brunt of the pathological effects thus always fell on the intestine and abdominal organs. These results are interesting, but are not conclusive of the etiological relationship of the typhoid bacillus to human typhoid. In the latter it is probable that the pathological changes are due on the one hand to the direct local reactive effects of the tissues, and on the other to the absorption of poisons, and therefore the artificial disease does not reproduce all the incidents of that naturally arising.

The Toxic Products of the Typhoid Bacillus.—Here very little light has been thrown on the pathology of the disease, but the general results may be outlined. By alternately precipitating a filtered bouillon culture with alcohol, and redissolving in water, a toxalbumin (*vide* Chapter V.) has been obtained which has pathogenic effects of an indefinite kind. The toxic effects of the bacterial protoplasm have been investigated by Sanarelli, who killed glycerin bouillon cultures at 60° C., and allowed the bodies of the bacteria to macerate. A clear toxic fluid could be decanted, which, when injected subcutaneously, killed guinea-pigs in twenty-four hours, with progressive fall of temperature, abdominal pain, distention, and bloody stools. *Post mortem* there were present peritoneal exudation, enlarged spleen, congestion of the intestine, and, according to Sanarelli, a special infiltration of the lymphoid patches. Sidney Martin found that the bodies of bacteria killed by chloroform vapour were more toxic (especially after being heated) than filtered cultures. Diarrhoea was a constant symptom after injection, but no change in the Peyerian patches was observed. Martin found that virulent cultures of the *B. coli* gave similar results when similarly treated, and the effects of both closely resemble those of ricin and abrin.

The general result of these and similar investigations is that there exist in the bodies of typhoid bacilli toxic substances, that in artificial cultures do not pass to any great degree out into the surrounding medium, and that though they produce effects on the intestine, there is evidence that such effects are not

peculiar to the toxins of the *B. typhosus*. As to the nature of the typhoid toxins, we know nothing. Martin has, however, found that in the case of the typhoid bacillus there is very little digestive action, such as occurs with the bacilli of diphtheria and tetanus.

The Immunisation of Animals against the Typhoid Bacillus. —

In considering this question we must note: (1) immunisation against the living bacilli; (2) immunisation against their toxins; and (3) the relations between these two conditions. Earlier observers had been successful in accustoming mice to the typhoid bacillus by the successive injections of small and gradually increasing doses of living cultures of the bacillus. Later, Brieger, Kitasato, and Wassermann found that a bouillon made from an extract of the thymus gland contained bodies which were inimical to the virulence of the typhoid bacillus, though the medium was sufficiently nutritive to permit of their multiplication. A culture three days old in such a bouillon, killed by heating at 60° C. for fifteen minutes, and injected into mice, was without fatal effect. Ten days later it was found that these mice could tolerate an otherwise fatal dose of the original living virulent culture. The experiments were repeated on guinea-pigs with a similar result, and it was also found that the serum of a guinea-pig thus immunised could, if transferred to another guinea-pig, protect the latter from the subsequent injection of a dose of typhoid bacilli to which it would naturally succumb. Chantemesse and Widal, Sanarelli, and also Pfeiffer, succeeded in immunising guinea-pigs against the subsequent intraperitoneal injection of virulent living typhoid bacilli, by repeated and gradually increasing intraperitoneal or subcutaneous doses of typhoid cultures in bouillon, in which the bacilli had been killed by heat or chloroform vapour. Experiments performed with serum derived from typhoid patients and convalescents indicate that similar effects occur in those who have successfully resisted the natural disease. Thus many observers had noticed that the serum of men convalescent from typhoid had an inimical effect on typhoid bacilli. Pfeiffer found that the serum of healthy men might have such an action but in a much less degree. The method was to mix the serum and the bacilli in a little bouillon, and inject the whole intraperitoneally into guinea-pigs. He found that when the latter did not die, the bacilli became

motionless and apparently dead, and that plate-cultures made after a time from the exudation containing them, remained sterile. The serum of such patients has, therefore, *antibacterial* powers, but there is no evidence that it contains any antitoxic bodies (see chapter on Immunity). Pfeiffer, for example, found that on adding serum from typhoid convalescents to the bodies of typhoid bacilli killed by heat, and injecting the mixture into guinea-pigs, death took place as in control animals which had received these toxic agents alone. Sanarelli also found that while the injection of similar toxic fluids rendered the animal immune to a certain dose of living bacilli, it still could be killed by a further dose of the toxin. Pfeiffer found that by using the serum of immunised goats he could, to a certain extent, protect other animals against the subsequent injection of virulent living typhoid bacilli. On trying to use the agent in a curative way, *i.e.* injecting it only after the bacilli had begun to produce their effects, he got little or no result.

There is thus evidence that the serum of persons who have recovered from typhoid fever, and the serum of animals artificially immunised against virulent typhoid bacilli, protect from these bacilli. There is no evidence that the serum has much power in neutralising the intracellular toxins of these bacilli. We have thus this very important fact. Animals are immunised by injections of the toxins of a bacillus; their serum, however, has no effect in neutralising its toxins, but only aids in the destruction of the bacilli which produce the toxins. Similar results have been obtained in the case of cholera.

The Pathogenicity of the *B. coli* and its Relation to that of the Typhoid Bacillus.—We have already seen that the *B. coli* is probably responsible for the occurrence of some of the abscesses which follow typhoid fever. It is also apparently the cause of some cases of summer diarrhœa (*cholera nostras*), and of infantile diarrhœa. Its numbers in the intestine are greatly increased during typhoid fever, and also during any pathological condition affecting the intestine. Intraperitoneal injection in guinea-pigs is occasionally fatal. Subcutaneous injection results in local abscesses, and sometimes in death from cachexia. Sanarelli found that the *B. coli* isolated from typhoid stools was much more virulent than when isolated from the stools of healthy persons. He holds that the increase in virulence is due to the effect of the typhoid toxins, and devised an ingenious experiment which seems to prove this point. This increased virulence of the *B. coli* in the typhoid intestine makes it possible that some of the pathological changes in typhoid may be due, not to the typhoid bacillus, but to the *B. coli*. Some of the general symptoms

may be intensified by the absorption of toxic products formed by it and by other organisms. It is to be noted that lesions produced in guinea-pigs are very similar to those of the *B. typhosus*. Differences of behaviour of the two bacilli, in connection with their pathological effects, have been brought forward as confirmatory of the fact of their being distinct species. Thus Sanarelli accustomed the intestinal mucous membrane of guinea-pigs to toxins derived from an old culture of the *B. coli*, by introducing day by day small quantities of the latter into the stomach. When a relatively large dose could be tolerated, it was found that the introduction in the same way of a small quantity of typhoid toxin was followed by fatal result. Pfeiffer also found that while the serum of convalescents from typhoid paralysed the typhoid bacilli, it had no more effect on similar numbers of *B. coli* than the serum of healthy men.

General View of the Relationship of the *B. typhosus* to Typhoid Fever. — 1. We have in typhoid fever a disease having its centre in and about the intestine, and acting secondarily on many other parts of the body. In the parts most affected there is always a bacillus present, microscopically resembling other bacilli, especially the *B. coli*, which is a normal inhabitant of the animal intestine. This bacillus can be isolated from the characteristic lesions of the disease and from other parts of the body as described, and further, it is found by culture reactions to differ from the *B. coli*. The whole series of culture reactions, however, must be investigated before a particular bacillus is identified as the *B. typhosus*, and no weight must be attached to any observations made on the subject when this has not been done. Here the important point, however, is that a bacillus giving all the reactions of the typhoid bacillus has never been isolated except from cases of typhoid fever, or under circumstances that make it possible for the bacillus in question to have been derived from a case of typhoid fever. There is no evidence that the *B. coli* can be transformed into the typhoid bacillus, or the typhoid bacillus into the *B. coli*, though of course this does not preclude the possibility of the one having been originally derived from the other. All practically are now agreed that two separate bacilli exist, the *B. coli* and the *B. typhosus*.

2. Against the etiological relationship of the latter to the disease several facts may be adduced. First, there is the comparative difficulty of the isolation of the *B. typhosus* from the stools of typhoid patients. We have pointed out, however, that the latter can be isolated during the first ten days of the disease, and that the extraordinary multiplication of the *B. coli*, which takes place in any pathological condition of the intestine,

sufficiently explains the failures in the later stages. The second and great difficulty in the way of accepting the etiological relationship of the *B. typhosus* lies in the comparative failure to cause the disease in animals. We have noted, however, that in nature animals do not suffer from typhoid fever.

3. The observations of Pfeiffer and others on the protective power against typhoid bacilli shown, on testing in animals, to belong to the serum of typhoid patients and convalescents, and the peculiar action of such serum in immobilising and causing clumping of the bacilli (*vide infra*) are also of great importance. Additional important evidence of the typhoid bacillus being the cause of typhoid fever is found in the fact that vaccination by means of the dead bacilli (*vide infra*) has a marked effect in preventing the disease arising in a protected population exposed to infection, and also in lowering the mortality when the fever attacks those who have been inoculated. These facts may thus be accepted as indirect but practically conclusive evidence of the pathogenic relationships of the typhoid bacillus to the disease.

According to our present results we must thus hold that the bacillus typhosus constitutes a distinct species of bacterium, and that there is every reason for accepting it as the cause of typhoid fever. Evidence of an important nature confirmatory of this view is, we think, found in the fact that cases have occurred where bacteriologists have accidentally infected themselves by the mouth with pure cultures of the typhoid bacillus, and after the usual incubation period have developed typhoid fever. Several cases of this kind have been brought to our notice and are not, we think, vitiated by the fact that other similar instances have occurred without the subsequent development of illness. These latter would be accounted for by a low degree of susceptibility on the part of the individual or to a want of pathogenicity in the cultures.

The Serum Diagnosis of Typhoid Fever.—This method of diagnosis is based on the fact that living and actively motile typhoid bacilli, if placed in the diluted serum of a patient suffering from typhoid fever, within a very short time lose their motility and become aggregated into clumps. The researches which led up to the discovery will be described in the chapter on Immunity. We shall find that in many diseases the serum has this property of causing agglutination of cultures of the

causal bacterium. The principles on which the possession of the faculty depends, and also its significance, are obscure, and even in the case of the typhoid bacillus, where an enormous amount of work has been done, we do not know the true interpretation of some of the facts which have been observed.

The methods by which the test can be applied have already been described (p. 109).

(1) It will be there seen that the loss of motility and clumping may be observed microscopically. If a preparation be made by the method detailed (typhoid serum in a dilution of, say, 1-50 having been employed), and examined at once under the microscope, the bacilli will usually be found actively motile, darting about in all directions. In a short time, however, these movements gradually become slower, the bacilli begin to adhere to one another, and ultimately become completely immobile and form clumps by their aggregation, so that no longer are any free bacilli noticeable in the preparation. When this occurs the reaction is said to be complete. If the clumps be watched still longer a swelling up of the bacilli will be observed, with a granulation of the protoplasm, so that their forms can with difficulty be recognised. In a preparation similarly made with non-typhoid serum the individual bacilli can be observed separate and actively motile for many hours.

(2) A corresponding reaction visible to the naked eye is obtained by the "sedimentation test," the method of applying which has also been described (p. 112). Here at the end of twenty-four hours the bacilli form a mass like a precipitate at the bottom of the mixture of bacterial emulsion and diluted typhoid serum, while the upper part remains clear. A similar preparation made with normal serum shows a diffuse turbidity at the end of twenty-four hours. The test in this form has the disadvantage of taking longer time than the microscopic method, but it is useful as a control; in nature it is similar.

Such is what occurs in the case of a typical reaction. There are several details, however, which require attention, and on which the value of the method as a means of diagnosis largely depends. The *race of typhoid bacillus* employed is important. All races do not give uniformly the same results, though it is not known on what this difference of susceptibility depends. The bacteriologist must, therefore, apply a process of selection to the races at his

disposal, with a view to obtaining one which gives the best result in the greatest number of undoubted cases of typhoid fever, and which gives as little reaction as possible with normal sera or sera derived from other diseases. This latter point is important, as some races react very readily to non-typhoid sera. Again, care must be taken as to the *state of the culture* used. The suitability of a culture may be impaired by varying the conditions of its growth. Continued growth of a race in surroundings very favourable to vegetable activity makes it less suitable for use in the test, as the bacilli tend naturally to adhere in clumps, which may be mistaken for those produced by the reaction. Wyatt Johnson recommends that the stock culture should be kept growing on agar at room temperature and maintained by agar sub-cultures made once a month. For use in applying the test, bouillon sub-cultures are made and incubated for twenty-four hours at 37° C. As the reaction of the medium has also an important effect on the sensitiveness of a culture, he recommends that such bouillon should first be made neutral to phenol-phthaleine, and then have added to it 3 or 4 per cent of normal hydrochloric acid. When these precautions are taken a growth occurs which only gives a uniform turbidity in the bouillon without any adhesion of the bacilli in masses. It is usually, however, quite safe to use bouillon prepared in the ordinary way. The relation of the *dilution of the serum* to the occurrence of clumping is most important. It has been found that if the degree of dilution be too small a non-typhoid serum may cause clumping. If possible, observations should always be made with dilutions of 1-10, 1-30, 1-50, 1-100. To speak generally, the more dilute the serum, the longer time is necessary for a complete reaction. Some typhoid sera have, however, very powerful agglutinating properties, and may in a comparatively short time produce a reaction when diluted many hundreds of times. The conditions giving rise to such sera are not known, and the cases from which they are derived are not necessarily of a severe type. With highly diluted sera not only may the reaction be delayed but it may be incomplete. Here, what is usually seen is that the clumps formed are small, many bacilli being left free. These latter may either have been rendered motionless or they may still be motile. No diagnosis is conclusive which is founded on the occurrence of such an incomplete clumping alone. Seeing

that low dilutions sometimes give a reaction with non-typhoid sera, great discussion has taken place as to what is the minimum dilution at which, when complete clumping occurs, it may safely be said that the reaction is due to the specific action of a typhoid serum. The general consensus of opinion, with which our own experience agrees, is that when a serum in a dilution of 1-30 causes complete clumping in half an hour, it may safely be said that it has been derived from a case of typhoid fever. Suspicion should be entertained as to the diagnosis if a lower dilution is required, or if a longer time is required.¹

The Dried-blood Method.—This method was introduced by Wyatt Johnston of Montreal, and is especially useful for routine work in health departments, where obviously critical methods cannot be readily employed. As practised by health boards, the physician is instructed to cleanse the lobe of the ear or the tip of a finger of the patient with soap and water and alcohol, to draw blood by pricking the part with a needle and permitting a drop or two of blood to be deposited separately upon a provided sterile glass slide or aluminium strip and allowing the blood to dry (in lieu of glass or aluminium, non-absorbent paper may be used). Upon reaching the laboratory the sample is covered by approximately five times its amount of water and allowed to stand two minutes, then one loopful is removed to a cover-slip and to it is added one loopful of the preparation of typhoid bacilli, and the whole is treated as a hanging drop in the manner carried out in quantitative examination.

The reaction given by the serum in typhoid fever usually begins to be observed about the seventh day of the disease, though occasionally it has been found as early as the fifth day, and sometimes it does not appear till the third week or later. Usually it gradually becomes more marked as the disease advances, and it is still given by the blood of convalescents from typhoid, but cases occur in which it may permanently disappear before convalescence sets in. How long it lasts after the end of the disease has not yet been fully determined, but in many cases it has been found after several months at least. As a rule, up to a certain point, the reaction is more marked where the fever is of a pronounced character, whilst in the milder cases it is less

¹ By American observers it is usually conceded that a diagnosis may be made, using a dilution of 1-50, with a time limit of two hours, without falling into error.

pronounced. In certain grave cases, however, the reaction has been found to be feeble or almost absent, and accordingly some hold that a feeble reaction when the disease is manifestly severe is of bad omen. In some cases, which from the clinical symptoms were almost certainly typhoid, the reaction has apparently been found to be absent.

It has been found that the reaction is not only obtained with living bacilli, but in certain circumstances also with bacilli that have been killed. This last may be effected by keeping the bacilli at 60° C. for an hour. If a higher temperature be used, sensitiveness to agglutination is impaired. The capacity is also still retained if a germicide be employed. Here Widal recommends the addition of one drop of formalin to 150 drops of culture. The reaction, however, tends to be less complete. It may be remarked that while clumping is taking place where dead cultures are used, active brownian movements among the free bacteria may be noticed, which may lead the observer to doubt whether the bacilli are really dead.

Besides the blood serum it has been found that the reaction is given in cases of typhoid fever by pericardial and pleural effusions, by the bile and by the milk, and also to a slight degree by the urine. The blood of a foetus may have little agglutinating effect, though that of its mother may have given a well-marked reaction; sometimes, however, the foetal blood gives a well-marked reaction. It may here also be mentioned that a serum will stand exposure for an hour at 58° C. without having its agglutinating power much diminished. Higher temperatures, however, cause the property to be lost.

The Agglutination of Organisms other than the B. typhosus by Typhoid Serum.—It was at first thought that reaction in typhoid fever would afford a reliable method of distinguishing the typhoid bacillus from the *B. coli*. Though many races of the latter give no reaction with a typhoid serum, there are others which react positively. Usually, however, a lower dilution and a longer time are required for a result to be obtained, and the reaction is often incomplete. It has also been found that other organisms belonging to the typhoid group, *e.g.* Gaertner's bacillus and perhaps the bacillus of psittacosis, react in a similar way. The reaction as a method of distinguishing between these forms is thus not reliable, but in certain cases it may be of value

in giving confirmation to other tests. There is a point in this connection regarding which further light is required. Many races of *B. coli* in use have been isolated from typhoid cases, and we as yet do not know what effect a sojourn in such circumstances may have on its subsequent sensitiveness to agglutination by typhoid serum.

The discovery that the exhibition of agglutination is not confined to the *B. typhosus* has caused great attention to be paid to the sensitiveness to different sera shown by it and by other allied organisms. It has been found that not only typhoid sera but the sera of healthy persons, and of those suffering from diseases other than typhoid fever, may occasionally clump typhoid bacilli even when considerably diluted. It has not, however, been sufficiently noted that, as Christophers has pointed out, a large proportion of similar sera will clump the *B. coli* in dilutions of from 1-20 to 1-200, and no doubt many of the reactions shown by typhoid sera towards *B. coli* are due to the pre-existence in the individuals of an agglutinative property towards the bacillus. It has been shown that both the *B. coli* and the *B. typhosus* may be clumped by the normal serum of the horse, the ass, and the rabbit, and it has been found that the serum of an animal immunised against either of these bacilli sometimes clumps both, and sometimes also in addition the *B. enteritidis*, though usually the dilutions necessary differ. It may also be remarked that in such immunised animals the best agglutinating result is usually obtained with subcultures of the race by which immunisation was effected.

With regard to the value of the serum reaction there is little doubt. In nearly 95 per cent of cases of typhoid it can be obtained in such a form that no difficulty is experienced if the precautions detailed above are observed. The causes of possible error may be summarised as follows: the serum of the person may naturally have the capacity of clumping typhoid bacilli; there may have been an attack of typhoid fever previously with persistence of agglutinative capacity; the case may be one of disease caused by an allied bacillus; the disease may have a quite different cause, and yet the serum may react with typhoid bacilli; the disease may be typhoid fever and yet no reaction may occur. The most important of these sources of error is that with which diseases caused by allied organisms are

concerned, as it is probable that all the forms which these take in man have not been recognised. The very wide application of the reaction has elicited the fact that it is given in many cases of slight, transient, and ill-defined febriculæ, which occur especially when typhoid fever is prevalent. Our knowledge of these is still insufficient to justify our setting all of them down as cases of aborted typhoid. There is no doubt that, taking all the facts into account, the cases where the reaction gives undoubtedly correct information so far outnumber those in which an error may be made that it must be looked on as a most valuable aid to diagnosis. In concluding we may say that the fact of a typhoid serum clumping allied bacilli in no way, so far as our present knowledge goes, justifies doubt being cast on the specific relation of the typhoid bacillus to typhoid fever.

Vaccination against Typhoid.—The principles of the immunisation of animals against typhoid bacilli have been applied by Wright and Semple to man in the following way. Typhoid bacilli are obtained of such virulence that a quarter of a twenty-four hours' old sloped agar culture when administered hypodermically will kill a guinea-pig of from 350 to 400 grammes. Vaccination can be accomplished by emulsifying such a culture in bouillon, and killing it by heating for five minutes at 60° C. For use, from one-twentieth to one-fourth of the dead culture is injected hypodermically, usually in the flank. The vaccine now sent out by Wright, however, consists of a portion of a bouillon culture similarly treated. The effects of the injection are some tenderness locally and in the adjacent lymphatic glands, and it may be local swelling, all of which come on in a few hours, and may be accompanied by a general feeling of restlessness and a rise of temperature, but the illness is over in twenty-four hours. During the next ten days the blood of the individual begins to manifest, when tested, a positive Widal's reaction, and further, Wright has found that usually after the injection there is a marked increase in the capacity of the blood serum to kill the typhoid bacilli *in vitro*. There is little doubt that these observations indicate that the vaccinated person possesses a degree of immunity against the bacillus, and this conclusion is borne out by the results obtained in the use of the vaccine as a prophylactic against typhoid fever. Extensive observations have been made in the British army in India, and also in the South African

Field Force, in which the efficacy of the treatment was put to test. Though in isolated cases not much difference has been observed among those treated as compared with those untreated, yet the broad general result may be said to leave little doubt that on the one hand protective inoculation diminishes the tendency for the individual to contract typhoid fever, and on the other, if the disease be contracted, the likelihood of its having a fatal result is diminished. Thus in India, of 4502 soldiers inoculated, .98 per cent contracted typhoid, while of 25,851 soldiers in the same stations who were not inoculated, 2.54 per cent took the disease. In Ladysmith during the siege there were 1705 soldiers inoculated, among whom 2 per cent of cases occurred, and 10,529 uninoculated, among whom 14 per cent suffered from typhoid. In Harrismith, Birt's statistics show that in typhoid occurring in uninoculated persons the mortality was 14.25 per cent, while among 263 inoculated the mortality was 6.8 per cent. Wright has collected statistics dealing in all with 49,600 individuals, of whom 8600 were inoculated, and showed a case incidence of 2.25 per cent, with a case mortality of 12 per cent; in the remaining 41,000 uninoculated the case incidence was 5.75 per cent and the case mortality 21 per cent. The best results seem to be obtained when ten days after the first inoculation a second similar inoculation is practised. Wright has found that in certain cases immediately after inoculation there is a fall in the bactericidal power of the blood, and he is of opinion that this indicates a temporary increased susceptibility to the disease. He therefore recommends that when possible the vaccination should be carried out some time previous to the exposure to infection. There can be very little doubt that in this method an important prophylactic measure has been discovered.

Anti-typhoid Serum.—Bokenham immunised a horse by filtered bouillon cultures of the typhoid bacillus, and found that the serum had neutralising power for the bacilli when the latter mixed with it were injected into guinea-pigs. When injection of the serum was followed by injection of bacilli, the pathogenic action of the latter was to a certain extent prevented, and there was also evidence of the serum possessing curative properties.

Methods of Examination.—The methods of microscopic examination, and of isolation of typhoid bacilli from the spleen *post mortem*, have already been described. They may be iso-

lated from the Peyer's patches, lymphatic glands, etc., by a similar method.

During life, typhoid bacilli may be obtained in culture in the following ways:—

(a) *From the Blood.*—As stated before, several observers have shown that in about 80 per cent of all cases of typhoid fever, in the earlier weeks of the disease, it is possible to obtain the bacilli from the blood by use of appropriate methods (see p. 72).

(b) *From the Spleen.*—This is the most certain method of obtaining the typhoid bacillus during the continuance of a case. The skin over the spleen is purified, and, a sterile hypodermic syringe being plunged into the organ, there is withdrawn from the splenic pulp a droplet of fluid, from which plates are made. In a large proportion of cases of typhoid the bacillus may be thus obtained, failure only occurring when the needle does not happen to touch a bacillus. Numerous observations have shown that, provided the needle be not too large, the procedure is quite safe. Its use, however, is scarcely called for.

(c) *From the Urine.*—Typhoid bacilli are present in the urine in about twenty-five per cent of cases, especially late in the disease, probably chiefly when there are groups in the kidney substance. For methods of examining suspected urine, see p. 74.

(d) *From the Stools.*—During the first ten days of a case of typhoid fever, the bacilli can be isolated from the stools by the ordinary plate methods—preferably in phenolated gelatin. After that period, though the continued infectiveness of the disease indicates that they are still present, their isolation is practically hopeless.

Numerous special media have from time to time been devised for the purpose of readily isolating and identifying the bacilli from the stools. The most have for their object the restraining of the majority of intestinal bacteria by having materials incorporated which prove unfavorable to their development, whilst readily permitting that of *B. typhosus*. Such media are commonly known by their author's names, *e.g.*, Elsner, Capaldi, Remey, Hiss, Piorkowski, Drigalski and Conradi (see references in chapter on Bibliography). All are more or less of doubtful value owing to difficulties presented in acquiring proficiency in their manufacture or application.

We have seen that after ulceration is fairly established by the sloughing of the necrosed tissue, the numbers present in

the patches are much diminished and therefore there are fewer cast off into the intestinal lumen, and that in addition there is a correspondingly great increase of the *B. coli*, which thus causes any typhoid bacilli in a plate to be quite outgrown. From the fact that the ulcers in a case of typhoid may be very few in number, it is evident that there may be at no time very many typhoid bacilli in the intestine. We may add that the microscopic examination of the stools is useless as a means of diagnosing the presence of the typhoid bacillus.

Isolation from Water Supplies. — A great deal of work has been done on this subject. It is evident that if it is difficult to isolate the bacilli from the stools it must *a fortiori* be much more difficult to do so when the latter are enormously diluted by water. The *B. typhosus* has, however, been isolated from water during epidemics. This was done by Klein in the outbreaks in recent years at Worthing and Rotherham. The *B. coli* is, as might be expected, the organism most commonly isolated in such circumstances. In the case of both bacteria, the whole series of culture reactions must be gone through before any particular organism isolated is identified as the one or the other; probably there are saprophytes existing in nature which only differ from them in one or two reactions. In the examination of water, the addition of .2 per cent carbolic acid to the medium inhibits to a certain extent the growth of other bacteria, while the *B. typhosus* and the *B. coli* are unaffected. In examining waters, the ordinary plate methods are generally used. Klein, however, filters a large quantity through a Berkefeld filter, and, brushing off the bacteria retained on the porcelain, makes cultures. A much greater concentration of the bacteria is thus obtained. On the whole there is little to be gained from this attempt to isolate the typhoid bacillus from water in any particular case, and it is much more useful for the bacteriologist to bend his energies towards the obtaining of the indirect evidence of contamination of water by sewage, to the nature of which attention has been called in Chapter IV.

BACILLARY DYSENTERY.

Dysentery has for long been recognised as including a number of different pathological conditions, and within more recent times

amœbic and non-amœbic forms have been distinguished. Of the latter bacteria have been believed to be the causal agents, and an organism described by Shiga in 1898 has almost been established as the cause of a large proportion of cases. Shiga's observations were made in Japan, and the confirmatory results obtained by Kruse in Germany, by Flexner and by Strong and Harvie in the Philippine Islands, and more recently by Vedder and Duval in the United States, tend to show that the distribution of the specific organism is world-wide. The last-mentioned observers also compared the bacteria obtained from these different localities and found them to be identical. Further interest is attached to the rôle played by this organism by the researches of Duval and Bassett, who seemingly have isolated the bacillus from the fæces in forty-two cases of summer diarrhœa in infants, and from scrapings of the intestinal mucosa at autopsy, and in one case from the mesenteric glands and liver. Spronck working in Holland confirms the work of Duval and Bassett by similar results in three cases of the same disease. The evidence for the relationship of the organism to the disease consists chiefly in the apparently constant presence of the organism in the dejecta in this class of dysentery, the agglutination of this organism by the

serum of patients suffering from the disease, and in the production of a curative serum through the immunising of sheep and asses with pure cultures of the bacillus. The relation of amœbæ to dysentery will be discussed in the Appendix.

Bacillus dysentericæ
(Shiga). — *Morphological Characters.*—This bacillus morphologically closely resembles the typhoid bacillus, but is on the whole somewhat plumper, and filamentous forms are comparatively rare (Fig. 118A). Involution forms sometimes occur, specially in glucose agar.

FIG. 118 A. — *B. dysentericæ*; from an agar culture 48 hours old. Stained with aniline-gentian-violet. $\times 1000$.

Most observers have found no trace of motility, while others say that it is slightly motile. Vedder and Duval have, however, by modification of Van Ermengem's process, demonstrated the presence of numerous lateral flagella, which are of great fineness, but of considerable length. No spore formation occurs; the organism is stained readily by the ordinary dyes, but is decolorised by Gram's method.

Cultural Characters.—In these also considerable resemblance is presented to the typhoid bacillus. In *gelatin* a whitish line of growth occurs along the puncture, but the superficial film-like growth is usually absent, or at least poorly marked. In plate-cultures also the superficial growths are smaller, and have less of the film-like character than those of the typhoid organism. On *agar* growth occurs as a smooth film with regular margins, but after two or three days, especially if the surface be moist, there occurs, as Vedder and Duval have described, an outgrowth of lateral offshoots on the surface of the medium. In *agar plates* the colonies resemble those of the typhoid organism, being of smaller size and less opaque than those of the bacillus coli. In peptone *bouillon* a uniform haziness is produced and the indol reaction is not usually given. This organism does not ferment grape and other sugars, there being no evolution of gas by ordinary methods. In *litmus milk* there is developed at first a slight degree of acidity, which is followed by a phase of increased alkalinity; no coagulation of the milk occurs. On *potato* the organism forms a transparent or whitish layer, which, however, in the course of a few days assumes a brownish-red or dirty-gray colour, with some discoloration of the potato at the margin of the growth.

Powers of Resistance.—The bacillus is killed by ten minutes' exposure to moist heat at 55° C. Shiga gives the following data regarding the action of some chemical solutions upon this organism: a 5 per cent solution of carbolic acid destroys it in a few minutes, whereas a 1 per cent solution requires half an hour; a brief exposure to a $\frac{1}{20000}$ solution of bichloride of mercury suffices to kill it; five minutes' exposure in a 10 per cent solution of 95 per cent alcohol causes its destruction. Exposure to direct sunlight for thirty minutes kills the bacillus. Drying is resisted for several days.

Relations to the Disease.—This organism has been found in

large numbers in the dejecta, especially in acute cases, where it may be present in almost pure cultures. The organism does not appear to spread deeply or to invade the general circulation. In the more chronic cases it is difficult to obtain on account of the large number of the bacillus coli and other bacteria present.

Pathology. — As already stated, both acute and chronic cases are marked by the presence of this organism. In the former, where death may occur in from one to six days, the chief changes, according to Flexner, are a marked swelling and corrugation of the mucous membrane, with hæmorrhage and pseudo-membrane at places. There is extensive coagulation-necrosis with fibrinous exudation and abundance of polymorphonuclear leucocytes, and the structure of the mucous membrane, as well as that of the muscularis mucosæ, is often lost in the exudation. There is also great thickening of the sub-mucosa, with great infiltration of leucocytes, these being chiefly of the character of "plasma cells." In the more chronic forms the changes correspond, but are more of a proliferative character. The mucous membrane is granular, and superficial areas are devoid of epithelium, whilst ulceration and pseudo-membrane are present in varying degree.

Agglutination. — All the above-mentioned observers agree regarding the agglutination of this bacillus by the serum — that is, in the cases of dysentery from which the organism can be cultivated. The reaction is most marked after from six to seven days in the acute cases, and is usually given in a dilution of from one in twenty to one in fifty within an hour, though sometimes much higher dilutions give a positive result. In the more chronic cases the reaction is less marked, and here the sedimentation method is to be preferred. Agglutination of this organism has not been obtained with serum from cases other than those of dysentery, nor has a bacillus been cultivated from other such sources. The reaction is also absent in those cases of dysentery which are manifestly of amœbic nature (p. 529).

Pathogenic Properties. — Mice and guinea-pigs are especially susceptible both to subcutaneous and intraperitoneal inoculation, dying frequently within 24 to 48 hours. Cats also die from subcutaneous inoculation, but are resistant when fed with the organism, excepting after doses of croton oil, when they fre-

quently succumb. Rabbits as a rule recover from subcutaneous inoculation, which usually produces well-marked local swelling; but in two instances Flexner was able to cause death in rabbits following upon subcutaneous inoculation, both with a Philippine culture and with one of Kruse's, and in each animal lesions were found in the colon quite analogous to those seen in the human subject. Dogs generally die within 5 to 6 days after being fed with cultures, developing well-marked diarrhœa, and *post mortem* the large intestine is usually found to be much swollen. Monkeys were found by Flexner to be most resistant, subcutaneous inoculation producing only a local swelling, which rapidly passed away and caused no apparent illness, even large doses of croton oil followed by food contaminated with the bacilli failed to produce infection.

It will be seen that the evidence furnished is practically conclusive as to the causal relationship between this bacillus and one form of dysentery, a form, moreover, which is both widespread and embraces a large proportion of cases of the disease, and especially of importance is the fact that observations made independently in different countries have yielded practically identical results on this point.

Method of Examination. — So far as is known the bacilli are found only in the dejecta, especially amongst the small portions of bloody mucous present therein in acute cases, and in the small shreds of mucous membrane should these be found. In thirty-six cases examined, Shiga obtained the bacillus in thirty-four from the dejecta, and in two others *post mortem* from the intestinal mucous membrane. Preferably agar plates are to be employed in culture work, and these are to be incubated at 37° C. Vedder and Duval found that if colonies which appeared after twelve hours were marked with a pencil, there was a greater probability of obtaining the bacillus of dysentery from those which appeared later, most of those appearing early being colonies of bacillus coli. To attain an early recognition of the nature of these later appearing colonies, it is recommended that sub-cultures from them be made at once in glucose agar, thereby differentiating the gas formers from the non-gas formers without loss of time. It is desirable in conducting an examination to obtain sufficient blood of the patient or cadaver to enable one to carry out an agglutination test upon the isolated bacilli. In the

examination of chronic cases of the disease *post mortem*, it is usually difficult to isolate the bacillus on account of the large number of bacillus coli and other bacteria present; in such cases it is advisable to scrape the ulcerated mucosa with a sterile knife and from the scrapings make numerous dilutions in agar. Lactose litmus agar may be found helpful in differentiating colon colonies from those of bacillus dysenteriae inasmuch as the former colonies appear red through the production of lactic acid, whilst the latter, not forming acid, remain blue.

Bacillus Dysenteriae (Ogata).—Ogata obtained this bacillus in an extensive epidemic in Japan in which no amœbæ were present. He found in sections of the affected tissues enormous numbers of small bacilli of about the same thickness as the tubercle bacillus, but very much shorter. These bacilli were sometimes found in a practically pure condition. They were actively motile and could be stained by Gram's method. He also obtained pure cultures from various cases and tested their pathogenic effects. They grew well on gelatin at the ordinary temperature, producing liquefaction, the growth somewhat resembling that of the cholera spirillum. By injection into cats and guinea-pigs, as well as by feeding them, this organism was found to have distinct pathogenic effects; these were chiefly confined to the large intestine, hæmorrhagic inflammation and ulceration being produced. It still remains to be determined whether this organism has a causal relationship to one variety of dysentery.

BACILLUS ENTERITIDIS SPOROGENES.

This organism was first isolated by Klein from the evacuations in an outbreak of diarrhœa following the ingestion of milk which contained the microbe, and it was subsequently found by him in certain cases of infantile diarrhœa and of summer diarrhœa, in certain instances in milk, and as a constant inhabitant of sewage (see Chapter IV.). In films made from the stools in diarrhœa cases where it is present it can be microscopically recognised as a bacillus 1.6μ to 4.8μ in length and $.8\mu$ in breadth, staining by ordinary stains and retaining the dye in Gram's method. It often contains a spore near one of the ends, or sometimes nearer the centre. It is slightly motile, and in cultures can be shown to possess a small number of terminal flagella. It grows well under anaerobic conditions on ordinary media, especially on those containing reducing agents. On agar the colonies are circular, grey, and translucent, and under a low power are seen to have a granular appearance. On this medium spore formation does not occur, but is easily obtained if the organism is grown on solidified blood serum, which, further, is liquefied during growth. On gelatin plates liquefaction commences after twenty-four hours at 20° C. The bacillus grows well on 2 per cent dextrose gelatin, and besides the liquefaction there is here great gas evolution. Spore formation can be seen to take place in this medium, but the degree seems to be in inverse ratio to the amount of gas formation. Very typical is the growth

on milk, and it is by this medium that isolation can be best effected. A small quantity of the material suspected to contain the bacillus is placed in 15 to 20 c.c. of sterile milk, which is then heated for ten minutes at 80° C. to destroy all vegetative bacteria; the tube is cooled, placed under anaerobic conditions, and incubated at 37° C. for from twenty-four to thirty-six hours. If the bacillus be present there is abundant gas formation, and almost complete separation of the curd from the whey takes place. The former adheres to the sides of the tube in shreds, and large masses gather with the cream on the top of the fluid, all being torn by the gas evolved. The whey is only slightly turbid and contains numerous bacilli. The growth has an odour of butyric acid. If a small quantity (say 1 c.c.) of the whey be injected into a guinea-pig, the animal becomes ill in a few hours and dies in twenty-four hours. At the point of inoculation the skin and subcutaneous tissues, and sometimes even the subjacent muscles, are green and gangrenous and evil-smelling, there is considerable œdema, and there may also be gas formation. The exudation is crowded with bacilli, which, however, are not generally distributed in any numbers throughout the body. These pathogenic properties of the bacillus enteritidis sporogenes are important in its recognition, for its culture reactions taken alone are very similar to those of the bacillus butyricus of Botkin.

Not a few American and Continental workers exhibit some hesitancy in accepting the status of *B. enteritidis sporogenes* as established by Klein; for his published descriptions are not free from the suspicion of the existence of cultural impurities involved in the technique employed. In fact, excepting the presence of motility and flagella, the above description corresponds closely to that of *B. aerogenes capsulatus* (Welch), and cultures of *B. enteritidis sporogenes* received at the Pathological Laboratory of the Johns Hopkins University, through the courtesy of Dr. Klein, agreed in every detail to pure cultures of *B. aerogenes capsulatus* (Welch), previously described by Welch and Nuttall.

CHAPTER XVI.

DIPHTHERIA.

THERE is no better example of the valuable contributions of bacteriology to scientific medicine than that afforded in the case of diphtheria. Not only has research supplied, as in the case of tubercle, a means of distinguishing true diphtheria from conditions which resemble it, but the study of the toxins of the bacillus has explained the manner by which the pathological changes and characteristic symptoms of the disease are brought about, and has led to the discovery of the most efficient means of treatment, namely, the anti-diphtheritic serum.

Historical. — As in the case of many other diseases, various organisms which have no causal relation to the disease were formerly described in the false membrane. The first account of the bacillus now known to be the cause of diphtheria was given by Klebs in 1883, who described its characters in the false membrane, but made no cultivations. It was first cultivated by Löffler from a number of cases of diphtheria, his observations being published in 1884, and to him we owe the first account of its characters in cultures and of some of its pathogenic effects on animals. The organism is for these reasons known as the Klebs-Löffler bacillus, or simply as Löffler's bacillus. By experimental inoculation with the cultures obtained, Löffler was able to produce false membrane on damaged mucous surfaces, but he hesitated to conclude definitely that this organism was the cause of the disease, for he did not find it in all the cases of diphtheria examined, he was not able to produce paralytic phenomena in animals by its injection, and, further, he obtained the same organism from the throat of a healthy child. This organism became the subject of much inquiry, but its relationship to the disease may be said to have been definitely established by the brilliant researches of Roux and Yersin, who made an extensive study of its character and life history, and showed that the most important features of the disease could be produced by means of the separate toxins of the organism. Their experiments were published in 1888-90. Further light has been thrown on the subject by the work of Sidney Martin, who has found that there can be separated from the organs in cases of diphtheria substances which act as nerve poisons, and also produce other phenomena met with in diphtheria.

General Facts. — Without giving a description of the pathological changes in diphtheria, it will be well to mention the

outstanding features which ought to be considered in connection with its bacteriology. In addition to the formation of false membrane, which may prove fatal by mechanical effects, the chief clinical phenomena are the symptoms of general poisoning, great muscular weakness, tendency to syncope, and albuminuria; also the striking paralyses which occur later in the disease, and which may affect the muscles of the pharynx, larynx, and eye, or less frequently the lower limbs (being sometimes of paraplegic type), all these being grouped together under the term "post-diphtheritic paralyses." It may be stated here that all these conditions have been experimentally reproduced by the action of the bacillus of diphtheria, or by its toxins. Other bacteria are, however, concerned in producing various secondary inflammatory complications in the region of the throat, such as ulceration, gangrenous change, and supuration, which may be accompanied by symptoms of general septic poisoning.

The detection of the bacillus of Löffler in the false membrane or secretions of the mouth is to be regarded as supplying the only certain means of diagnosis of diphtheria. With the exception of the tubercle bacillus, there is probably no organism which has been the subject of so much routine examination, and the opinion of all who are competent to judge may be said to be unanimous on this subject.

Bacillus Diphtheriæ. — *Microscopical Characters.* — If a film preparation be made from a piece of diphtheria membrane (in the manner described below) and stained with methylene-blue, the bacilli are found to have the following characters. They are slender rods, straight or slightly curved, and usually about 3μ in length, their thickness being a little greater than that of the tubercle bacillus. The size, however, varies somewhat in different cases, and for this reason varieties have been distinguished as small and large, and even of intermediate size. It is sufficient to mention here that in some cases most are about 3μ in length, whilst in others they may measure fully 5μ . Corresponding differences in size are found in cultures. They stain deeply with the blue, sometimes being uniformly coloured, but often showing, in their substance, little granules more darkly stained, so that a dotted or beaded appearance is presented. Sometimes the ends are swollen and more darkly stained than

the rest; often, however, they are rather tapered off (Fig. 119). In some cases the terminal swelling is very marked, so as to amount to clubbing, and with some specimens of methy-

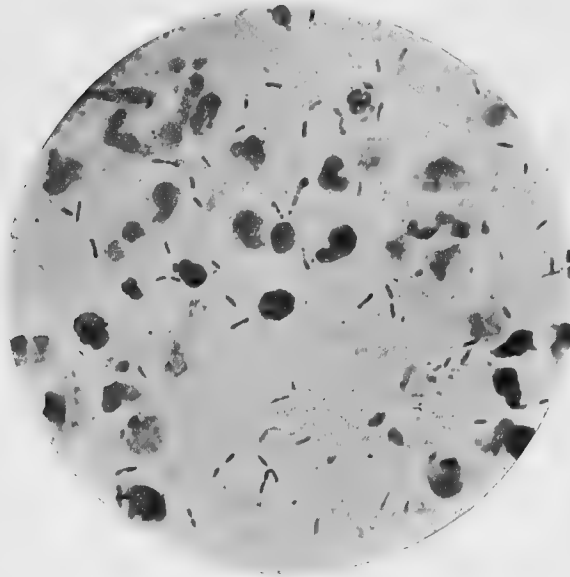

FIG. 119. — Film preparation from diphtheria membrane; showing numerous diphtheria bacilli. One or two degenerated forms are seen near the centre of the field. (Cultures made from the same piece of membrane showed the organism to be present in practically pure condition.)

Stained with methylene-blue. $\times 1000$.

lene-blue these swellings and granules stain of a violet tint. Distinct clubbing, however, is less frequent than in cultures. There is a want of uniformity in the appearance of the bacilli if compared side by side. They usually lie irregularly scattered or in clusters, their individual bacilli being disposed in all directions. Some

may be contained within leucocytes. They do not form chains, but occasionally forms longer than those mentioned may be found, and these specially occur in the spaces between the fibrin as seen in sections.

Distribution of the Bacillus. — The diphtheria bacillus may be found in the membrane wherever it is formed, and may also occur in the secretions of the pharynx and larynx in the disease. It may be mentioned that distinctions formerly drawn between true diphtheria and non-diphtheritic conditions from the appearance and site of the membrane, have no scientific value, the only true criterion being the presence of the diphtheria bacillus. The occurrence of a membranous formation produced by streptococci has already been mentioned (p. 193).

In diphtheria the membrane has a somewhat different struc-

ture according as it is formed on a surface covered with stratified squamous epithelium as in the pharynx, or on a surface covered by ciliated epithelium as in the trachea. In the former situation necrosis of the epithelium occurs either uniformly or in patches, and along with this there is marked inflammatory reaction in the connective tissue beneath, attended by abundant fibrinous exudation. The necrosed epithelium becomes raised up by the fibrin, and its interstices are also filled by it. The fibrinous exudation also occurs around the vessels in the tissue

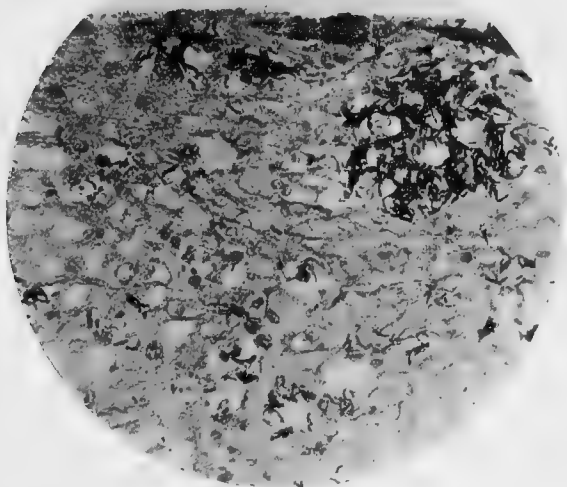

FIG. 120. — Section through a diphtheritic membrane in trachea, showing diphtheria bacilli (stained darkly) in clumps, and also scattered amongst the fibrin. Some streptococci are also shown, towards the surface on the left side.

Stained by Gram's method and Bismarck-brown. $\times 1000$.

beneath, and in this way the membrane is firmly adherent. In the trachea, on the other hand, the epithelial cells rapidly become shed, and the membrane is found to consist almost exclusively of fibrin with leucocytes, the former arranged in a reticulated or somewhat laminated manner, and varying in density in different parts. The membrane lies upon the basement membrane, and is less firmly adherent than in the case of the pharynx.

The position of the diphtheria bacilli varies somewhat in different cases, but they are most frequently found lying in oval or irregular clumps in the spaces between the fibrin, towards

the superficial, that is, usually, the oldest part of the false membrane (Fig. 120). There they may be in a practically pure condition, though streptococci and occasionally some other organisms may be present along with them. They may occur also deeper, but are rarely found in the fibrin around the blood-vessels. On the surface of the membrane they may be also seen lying in large numbers, but are there usually accompanied by numerous other organisms of various kinds. Occasionally a few bacilli have been detected in the lymphatic glands. As Löffler first described, they may be found after death in pneumonic patches in the lung, this being a secondary extension by the air passages. They have also been occasionally found by various observers in the spleen, liver, and other organs after death. This occurrence is probably to be explained by an entrance into the blood stream shortly before death, similar to what occurs in the case of other organisms, *e.g.* the bacillus coli communis. The diphtheria bacillus may also infect other mucous membranes. It is found in true diphtheria of the conjunctiva, and may also occur in similar affections of the vulva and vagina: some of these cases have been treated successfully with diphtheria antitoxin. The pseudo-diphtheria bacillus, however, may also occur in these situations.

Association with other Organisms.—The diphtheria organism is sometimes present alone in the membrane, but more frequently is associated with some of the pyogenic organisms, the streptococcus pyogenes being the commonest. The staphylococci, and occasionally the pneumococcus or the bacillus coli, may be present in some cases. Streptococci are often found lying side by side with the diphtheria bacilli in the membrane, and also penetrating more deeply into the tissues. In some cases of tracheal diphtheria we have found streptococci alone at a lower level in the trachea than the diphtheria bacilli, where the membrane was thinner and softer, the appearance in these cases being as if the streptococci acted as excitors of inflammation and prepared the way for the bacilli. It is still a matter of dispute as to whether the association of the diphtheria bacillus with the pyogenic organisms is a favourable sign or the contrary, though on experimental grounds the latter is the more probable. We know, however, that some of the complications of diphtheria may be due to the action of pyogenic organisms. The exten-

sive swelling of the tissues of the neck, sometimes attended by suppuration in the glands, and also various hæmorrhagic conditions, have been found to be associated with their presence; in fact, in some cases the diphtheritic lesion enables them to get a foothold in the tissues, where they exert their usual action and may lead to extensive suppurative change, to septic poisoning, or to septiciæmia. In cases where a gangrenous process is super-added, a great variety of organisms may be present, some of them being anaerobic.

Against such complications anti-diphtheritic serum produces no favourable effect, as its action is specific and only neutralises the toxins of the diphtheria bacillus. In view of this fact, in some cases the anti-streptococcic serum has been used along with it, and it is apparent that in such conditions the bacteriological examination of the parts affected may afford valuable indications as to treatment.

Cultivation. — The diphtheria bacillus grows best in cultures at the temperature of the body; growth still takes place at 22° C., but ceases at 20° C. The best media are the following: Löffler's original medium (p. 45), solidified blood serum, alkaline blood serum (Lorrain Smith), blood agar, and the ordinary agar media. If inoculations be made on the surface of blood serum with a piece of diphtheria membrane, colonies of the bacillus appear within twenty-four hours, and often before any other growths are visible. The colonies are small circular discs of opaque, whitish colour, their centre being thicker and of darker greyish appearance when viewed by transmitted light than the periphery. On the second or third day they may reach 3 mm. in size, but when numerous they remain smaller. Upon agar plates the surface colonies at the end of twenty-four to forty-eight hours' incubation resemble those of streptococcus pyogenes, but are usually larger and have a tendency towards wavy margins. Under the low power of the microscope such colonies

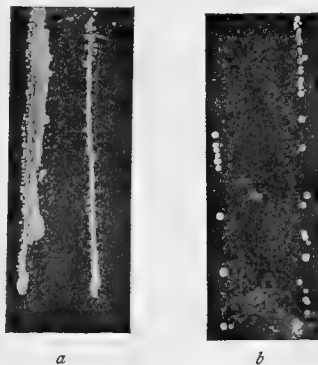

FIG. 121. — Cultures of the diphtheria bacillus on an agar plate; twenty-six hours' growth.

- (a) Two successive strokes;
 (b) isolated colonies from the same plate.

are found to be of a grey-yellow colour, translucent, rather coarsely granular, often nucleated and reticulated. The deep

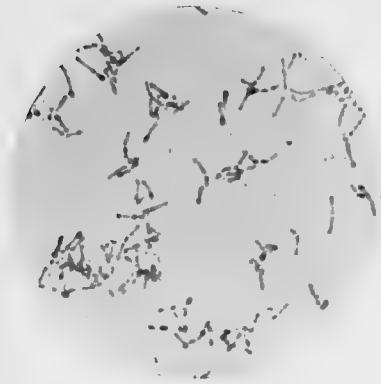

FIG. 122.—Diphtheria bacilli from a twenty-four hours' culture on agar. Stained with methylene-blue. $\times 1000$.

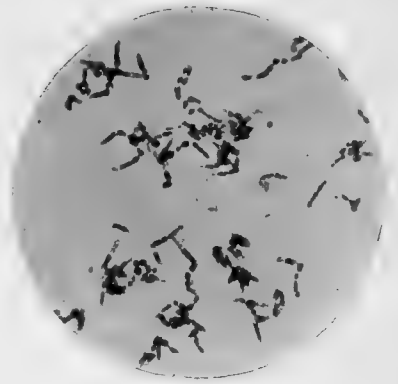

FIG. 123.—Diphtheria bacilli of larger size than in previous figure, showing also irregular staining of protoplasm. From a three days' agar culture.

Stain: weak carbol-fuchsin. $\times 1000$.

colonies show nothing very striking. In stroke-cultures the growth forms a continuous layer of the same dull whitish colour, the margins of which often show single colonies partly or completely separated.

On *gelatin* at 22° C. a puncture culture shows a line of dots along the needle track, whilst at the surface a small disc forms, rather thicker in the middle. In none of the media does any liquefaction occur. In *bouillon* the organism produces a turbidity which soon settles to the bottom and forms a powdery layer on the wall of the vessel. By starting the growth on the surface and keeping the flasks at rest a distinct scum forms, and this is especially suitable for the development of toxin.



FIG. 124.—Involution forms of the diphtheria bacillus; from an agar culture of seven days' growth.

Stained with carbol-thionin-blue. $\times 1000$.

Ordinary bouillon becomes acid during the first two or three days, and several days later again acquires

an alkaline reaction. If, however, the bouillon is glucose-free (p. 80) the acid reaction does not occur.

In these media the bacilli show the same characters as in the membrane, but the irregularity in staining is more marked (Figs. 122, 123). They are at first fairly uniform in size and shape, but later involution forms are present. Many are swollen at their ends into club-shaped masses which stain deeply, and the protoplasm becomes broken up into globules with unstained parts between (Fig. 124). Some become thicker throughout, and segmented so as to appear like large cocci, and others show globules at their ends, the rest of the rod appearing as a faintly stained line. Occasionally branched forms are met with in agar or blood-serum cultures, which take the shape of a three-rayed star usually. Lately, Hill has demonstrated the fact that even more complex branching forms are by no means rare and can be observed to occur in "hanging-block" preparations upon a warm stage within the course of a few hours. The bacilli are non-motile, and do not form spores.

Staining. — They take up the basic aniline dyes, *e.g.* methylene-blue in watery solution, with great readiness, and stain deeply, the granules often giving the metachromatic reaction as described. They also retain the colour in Gram's method, though they are more easily decolorised than the pyogenic cocci.

Neisser has recently introduced the following stain as an aid to the diagnosis of the diphtheria bacillus. Two solutions are used as follows: (*a*) 1 gm. methylene-blue (Grübler) is dissolved in 20 c.c. of 96 per cent alcohol, and to the solution are added 950 c.c. of distilled water and 50 c.c. of glacial acetic acid; (*b*) 2 grms. Bismarck-brown (vesuvin) dissolved in a litre of distilled water. Films are stained in (*a*) for 1-3 seconds or a little longer, washed in water, stained for 3-5 seconds in (*b*), dried, and mounted. The protoplasm of the diphtheria bacillus is stained a faint brown colour, the granules a blue colour. Neisser considers that this reaction is characteristic of the organism, provided that *cultures* on Löffler's serum are used and examined after 9-24 hours' incubation at 34-35° C., but more extended observations show that this reaction has only a relative value. Satisfactory results are not always obtained in the case of films prepared from membrane, etc., but there is no doubt that here also the method is one of considerable value.

Powers of Resistance, etc. — In cultures the bacilli possess long duration of life; at the room temperature they may survive for two months or longer. In the moist condition, whether in

cultures or in membrane, they have a low power of resistance, being killed at 60° C. in a few minutes. On the other hand, in the dry condition, they have great powers of endurance. In membrane which is perfectly dry, for example, they can resist a temperature of 98° C. for an hour. Dried diphtheria membrane, kept in the absence of light and at the room temperature, has been proved to contain diphtheria bacilli still living and virulent at the end of several months. The presence of light, moisture, or a higher temperature, causes them to die out more rapidly. Corresponding results have been obtained with bacilli obtained from cultures and kept on dried threads. These facts, especially with regard to drying, are of great importance, as they show that the contagium of diphtheria may be preserved for a long time in the dried membrane.

Effects of Inoculation. — In considering the effects produced in animals by experimental inoculations of pure cultures, we have to keep in view the local changes which occur in diphtheria, and also the symptoms of general poisoning.

Löffler in his original paper stated that in the case of rabbits, guinea-pigs, pigeons, and fowls, the bacilli taken from pure cultures produced no change on healthy mucous membranes, but when the latter were injured by scarification or otherwise, inoculation caused the formation of false membrane. A similar result was obtained when the trachea was inoculated after tracheotomy had been performed. In this case the surrounding tissues became the seat of a blood-stained œdema, and the lymphatic glands were enlarged, the general picture resembling pretty closely that of laryngeal diphtheria. These results have been amply confirmed by other observers. The membrane produced by such experiments is usually less firm than in human diphtheria, and the bacilli are not generally found in such large numbers in the membrane. Rabbits inoculated after tracheotomy often die, and Roux and Yersin were the first to observe that in some cases paralysis may appear before death.

Subcutaneous injection, in guinea-pigs, of diphtheria bacilli in a suitable dose, produces death within thirty-six hours. On section at the site of inoculation there is seen a small patch of greyish membrane, whilst in the tissues around there is extensive inflammatory œdema, often associated with hæmorrhages, and there is also some swelling of the corresponding lymphatic

glands. The internal organs show general congestion, the supra-renal capsules being especially reddened and often showing hæmorrhage. The renal epithelium may show cloudy swelling, and there is often effusion into the pleural cavities. After injection the bacilli increase in number for a few hours, but multiplication soon ceases, and at the time of death they may be less numerous than when injected. The bacilli remain practically local, cultures made from the blood and internal organs giving usually negative results, though sometimes a few colonies may be obtained. When streptococci or staphylococci are injected at the same time, a larger number of diphtheria bacilla enter the circulation (Métin). If a non-fatal dose of a culture be injected, a local necrosis of the skin and subcutaneous tissue may follow at the site of inoculation.

In rabbits, after subcutaneous inoculation, results of the same nature follow, but these animals are less susceptible than guinea-pigs, and the dose requires to be proportionately larger. Roux and Yersin found that after intravenous injection the bacilli rapidly disappeared from the blood, and even after the injection of 1 c.c. of a broth culture no trace of the organisms could be detected by culture after twenty-four hours: nevertheless the animals died with symptoms of general toxæmia, nephritis also being often present (cf. "Cholera," p. 417). The dog and sheep are also susceptible to inoculation with virulent bacilli, but the mouse and rat enjoy a high degree of immunity.

Klein found that cats also were susceptible to inoculation. The animals usually die after a few days, and *post mortem* there is well-marked nephritis. He also found that after subcutaneous injection in cows, a vesicular eruption appeared on the teats of the udder, the fluid in which contained diphtheria bacilli. At the time of death the diphtheria bacilli were still alive and virulent at the site of injection. The most striking result of these experiments is that the diphtheria bacilli passed into the circulation and were present in the eruption of the udder. He considers that this may throw light on certain epidemics of diphtheria in which the contagion was apparently carried by the milk. Other observers have, however, failed to obtain similar results. Dean and Todd, in investigating an outbreak of diphtheria traceable to milk supplied, found a vesicular eruption on the teats of the udder in which diphtheria bacilli were present. They, however, came to the conclusion that these bacilli were not the cause of the eruption, but were the result of a secondary contamination, probably from the saliva of the milkers. The occurrence of a true infection with the diphtheria bacillus in the horse has been recently described by Cobbett.

The Toxins of Diphtheria. — As in the above experiments the symptoms of poisoning and ultimately a fatal result occur when the bacilli are diminishing in number, or even after they have practically disappeared, Roux and Yersin inferred that the chief effects were produced by toxins, and this supposition they proved to be correct. They showed that broth cultures of three or four weeks' growth freed from bacilli by filtration were highly toxic. The filtrate when injected into guinea-pigs and other animals produces practically the same effects as the living bacilli; locally there is less fibrinous exudation but a considerable amount of inflammatory œdema, and, if the animal survive long enough, necrosis in varying degree of the superficial tissues may follow. The toxicity may be so great that .05 c.c. or even less may be fatal to a guinea-pig in twenty-four hours.

After injection either of the toxin or of the living bacilli, when the animals, such as guinea-pigs, rabbits, dogs, etc., survive long enough, paralytic phenomena may occur. The hind limbs are usually affected first, the paralysis afterwards extending to other parts, though sometimes the fore limbs and neck first show the condition. Sometimes symptoms of paralysis do not appear till two or three weeks after inoculation. After paralysis has appeared, a fatal result usually follows in the smaller animals, but in dogs recovery may take place. There is evidence that these paralytic phenomena are produced by toxoids, *i.e.* modified toxins (p. 179), as they may occur when there is injected along with the toxin sufficient antitoxin to neutralise the more rapidly acting toxin proper. One point of much interest is the high degree of resistance to the toxin possessed by mice and rats. Roux and Yersin, for example, found that 2 c.c. of toxin, which was sufficient to kill a rabbit in sixty hours, had no effect on a mouse, whilst of this toxin even $\frac{1}{15}$ c.c. produced extensive necrosis of the skin of the guinea-pig.

Preparation of the Toxin. — The obtaining of a very active toxin in large quantities is an essential in the preparation of anti-diphtheritic serum. Certain conditions favour the development of a high degree of toxicity, *viz.*, a free supply of oxygen, the presence of a large proportion of peptone or albumin in the medium, and the absence of substances which produce an acid reaction. In the earlier work a current of sterile air was made to pass over the surface of the medium, as it was found that by

this means the period of acid reaction was shortened and the toxin formation favoured. This expedient is now considered unnecessary if an alkaline medium free from glucose is used, as in this no acid reaction is developed: it is then sufficient to grow the cultures in shallow flasks. The absence of glucose — an all-important point — may be attained by the method described above (p. 80), or by using for the preparation of the meat extract flesh which is just commencing to putrefy (Spronck). L. Martin uses a medium composed of equal parts of freshly prepared peptone (by digesting pigs' stomachs with HCl at 35° C.), and glucose-free veal bouillon. In this medium he has obtained a toxin of which $\frac{1}{500}$ c.c. is the fatal dose to a guinea-pig of 500 grms. He finds that glucose, glycerin, saccharose, and galactose lead to the production of an acid reaction, whilst glycogen does not. The latter fact explains how some observers have found that bouillon prepared from *quite* fresh flesh is suitable for toxin formation. There is in all cases a period at which the toxicity reaches a maximum, usually in 2–3 weeks, occurring earlier the more rapidly the toxin is formed; later the toxicity diminishes. Martin found that in his medium the maximum was reached on the 8th–10th day. It may be added that the power of toxin formation varies much in different races of the diphtheria bacillus, and that many may require to be tested ere one suitable is obtained.

Properties and Nature of the Toxin. — The toxic substance in filtered cultures is a relatively unstable body. When kept in sealed tubes in the absence of light, it may preserve its powers little altered for several months, but, on the other hand, it gradually loses them when exposed to the action of light and air. Heating at 58° C. for two hours destroys the toxic properties in great part, but not altogether. When, however, the toxin is evaporated to dryness, it has much greater resistance to heat. One striking fact, discovered by Roux and Yersin, is that after an organic acid, such as tartaric acid, is added to the toxin the toxic property disappears, but that it can be in great part restored by again making the fluid alkaline.

The toxic body in filtered cultures can be precipitated by alcohol, and is also carried down by calcium phosphate. It is, however, soluble in water and dialyses somewhat slowly through animal membranes. By repeated precipitation and again dis-

solving, aided by dialysis, a solution is obtained which, on evaporating to dryness, gives a whitish-yellow powder containing the toxic body, though not in a chemically pure condition. From the characters described, Roux and Yersin considered that it belonged to the group of diastases or enzymes.

The true chemical nature of the diphtheria toxin is still unknown, and the matter is further complicated by the possibility that if a ferment is formed by the bacilli it may produce other toxic bodies of a non-diastatic nature. Guinochet showed that toxin was also formed by the bacilli when grown in urine with no proteid bodies present. After growth had taken place he could not detect proteid bodies in the fluid, but on account of the very minute amount of toxin present, their absence could not be excluded. Uschinsky also found that toxic bodies were produced by diphtheria bacilli when grown in a proteid-free medium.¹ It follows from this that if the true toxin is a proteid, it may be formed by synthesis within the bodies of the bacilli, as well as by a change in the proteids of the culture fluid. Brieger and Boer have separated from diphtheria cultures a toxic body which gives no proteid reaction (*vide* p. 174).

Toxic bodies have also been obtained from the tissues of those who have died from diphtheria. Roux and Yersin, by using a filtered watery extract from the spleen from very virulent cases of diphtheria, produced in animals death after wasting and paralysis, and also obtained similar results by employing the urine. The subject of toxic bodies in the tissues has, however, been specially worked out by Sidney Martin. He has separated from the tissues, and especially from the spleen, of patients who have died from diphtheria, by precipitation with alcohol, chemical substances of two kinds, namely, albumoses (proto- and deutero-, but especially the latter), and an organic acid. The albumoses, when injected into rabbits, especially in repeated doses, produce fever, diarrhoea, paresis, and loss of weight, with ultimately a fatal result. As in the experiments with the toxin from cultures, the posterior limbs are first affected; afterwards the respiratory muscles, and finally the heart, are implicated. He further found

¹ Uschinsky's medium has the following composition: water, 1000 parts; glycerin, 30-40; sodium chloride, 5-7; calcium chloride, .1; magnesium sulphate, .2-.4; di-potassium phosphate, .2-.25; ammonium lactate, 6-7; sodium asparaginate, 3-4.

that this paresis is due to well-marked changes in the nerves. The medullary sheaths first become affected, breaking up into globules; ultimately the axis cylinders are involved, and may break across, so that degeneration occurs in the peripheral portion of the nerve fibres. Such changes occur irregularly in patches, both sensory and motor fibres being affected. Fatty change takes place in the associated muscle fibres. There may also be a similar condition in the cardiac muscle. The organic acid has a similar but weaker action. Substances obtained from diphtheria membrane have an action like that of the bodies obtained from the spleen, but in higher degree. Martin considers that this is due to the presence in the membrane of an enzyme which has a proteolytic action within the body, resulting in the formation of poisonous albumoses. According to this view the actual toxic bodies are not the direct product of the bacillus, but are formed by the enzyme which is produced by it locally in the membrane. Cartwright Wood has also found that when diphtheria cultures in an albumin-containing medium are filtered germ-free and exposed to 65° C. for an hour (the supposed ferments being thus destroyed), there still remain albumoses which produce febrile reaction and are active in developing immunity. The existence of ferments, though a possibility, cannot, however, be considered to be yet completely proved. Nor is it yet certain whether the proteids obtained by precipitation from cultures and from the tissues are in themselves toxic, or whether the toxic bodies are carried down along with them.

Immunity.— This is described in the general chapter on Immunity. It is sufficient to state here that a high degree of immunity, against both the bacilli and their toxins, can be produced in various animals by gradually increasing doses either of the bacilli or of their filtered toxins (*vide* Chapter XX.).

Variations in the Virulence of the Diphtheria Bacillus.— In cultures on serum the diphtheria bacilli retain their virulence fairly well, but they lose it much more quickly on less suitable media, such as glycerin agar. Roux and Yersin found that, when the bacilli were grown at an abnormally high temperature, namely, 39.5° C., and in a current of air, the virulence diminished so much that they became practically innocuous. When the virulence was much diminished, these observers found that it could be restored if the bacilli were inoculated into animals along

with streptococci, inoculation of the bacilli alone not being successful for this purpose. If, however, the virulence had fallen very low, even the presence of the streptococci was insufficient to restore it. As a rule, the cultures most virulent to guinea-pigs are obtained from the gravest cases of diphtheria, though to this rule there are frequent exceptions. It has been abundantly established that after the cure of the disease, the bacilli may persist in the mouth for weeks and months, though they often quickly disappear. Roux and Yersin found, by making cultures at various stages after the termination of the disease, that these bacilli in the mouth gradually become attenuated. These observations are of importance in relation to the subject of the pseudo-diphtheria bacillus. At present it would scarcely be safe to make a definite statement as regards the relation of virulence to the size of the bacilli. Perhaps the majority of observers have found that the bacilli of the larger form are usually more virulent than those of the shorter form; but this is not invariably the case, as sometimes short forms are obtained which possess an extremely virulent character. Both the long and the short forms may become attenuated in the same way.

The so-called Pseudo-diphtheria Bacillus.—Under this term more than one species of bacillus has been described and considerable confusion has arisen. (*a*) The name has been applied by some observers to an organism differing from the diphtheria bacillus solely in its want of virulence. Such an organism must be regarded merely as the diphtheria bacillus in an attenuated condition, and should be spoken of as such. (*b*) On the other hand, there have been cultivated several species of bacilli which resemble the diphtheria bacillus in some respects, but differ from it in certain important points. They have not all the morphological and staining characters in young cultures, and do not produce an acid reaction in broth containing glucose; along with these characters minor differences in cultures may be present. Such organisms have been cultivated from the throat, both in the healthy condition, in non-diphtheritic affections, and also in true diphtheria along with the diphtheria bacillus. The term “pseudo-diphtheria” if used at all should be applied to such organisms. The type most commonly met with is a shorter bacillus than the diphtheria bacillus, with usually a single unstained septum running across it, though sometimes

there may be more than one (Fig. 125); it does not form acid from glucose, is non-pathogenic to the guinea-pig, and its colonies after a time tend to become whiter and more opaque than those of the diphtheria bacillus. Involution forms may sometimes be produced by it. The name "Hofmann's bacillus" is often used to denote such an organism. This organism is of comparatively common occurrence: Cobbett found it 157 times in an examination of 692 persons, of whom 650 were not suffering from diphtheria.

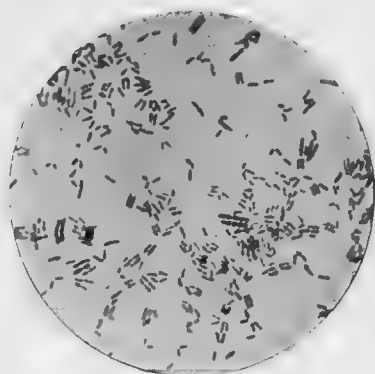

FIG. 125. — Pseudo-diphtheria bacillus (Hofmann's). Young agar culture. Stained with thionin-blue. $\times 1000$.

Löffler, in 1887, was the first to describe a bacillus having closely the characters of the diphtheria bacillus, but differing from it in its want of virulence. He looked upon it as a distinct species, and gave it the name of the *pseudo-diphtheria bacillus*. Hofmann, in 1888, published an account of his investigations on this subject. He obtained the pseudo-diphtheria bacillus from the throat in healthy conditions, and also in non-diphtheritic affections. His conclusions with regard to the distinct character of this bacillus were similar to those of Löffler. Since that time the organism has been the subject of much research and discussion. Roux and Yersin, on the other side, found a "pseudo-diphtheria" bacillus corresponding in all its characters with a greatly attenuated diphtheria bacillus, and concluded that it was really of the same nature. They failed to make it virulent by any method; but this result was also obtained in the case of artificially attenuated diphtheria bacilli. Biggs has found that there are two varieties of pseudo-diphtheria bacilli, both differing from the true diphtheria bacillus; one of these produces an acid reaction in broth containing glucose, whilst the other does not. According to his statistics the two varieties appear to occur with about the same frequency, and these observations have been in the main confirmed by Cobbett and Phillips. Hewlett and Knight find evidence that a true diphtheria bacillus may be modified so as to show the microscopic and cultural characters of the pseudo-diphtheria type, this evidence being obtained both by successive examinations of the throat after diphtheria and by modifying cultures artificially. They also claimed to have in one instance transformed a bacillus of the Hofmann type into a genuine diphtheria bacillus. Richmond and Salter, by the passage through finches and other birds, also record successful transformation of a Hofmann bacillus into the true *B. diphtheriæ*. Lesieur, in a recent and exhaustive study upon the relationship existing between *B. diphtheriæ* and the so-called *B. pseudo-diphthericus*, records several interesting facts.

By the long-continued action of diffuse daylight in a dry room, he was enabled to transform three species of virulent *B. diphtheriæ* into forms which were non-virulent and which could not be distinguished from the real Hofmann bacillus. And again, by the aid of collodion sac cultures passed through one or two generations in the peritoneal cavities of rabbits; by repeatedly transferring cultures of *B. pseudo-diphthericus* every second or third day to nutrient broth and incubating at 37° C.; and by cultivating the bacilli in broth with *staphylococcus pyogenes aureus*, he was able to transform these apparent Hofmann bacilli into bacilli having the characters of *B. diphtheriæ*, proving virulent to guinea-pigs, and having their virulence counteracted by antitoxin. Some pseudo-diphtheria bacilli, however, resisted all attempts at alteration, and Lesieur therefore concludes that the majority of non-virulent diphtheria-like bacilli met with are probably true *B. diphtheriæ*, which, through unknown conditions, have lost virulence and undergone morphological alterations; the minority, only, can lay claim to the term "pseudo-diphtheria" bacilli, and probably include several species.

As a rule the appearances of the colonies and the microscopical characters enable a rapid diagnosis to be made in suspected diphtheria cases. In some cases, however, difficulty may be met with; and in the first place, all the minor cultural characters must be carefully examined, including the reaction produced in broth. By this procedure it may be determined whether the organism in question differs in any points from the diphtheria bacillus. A *positive* result on inoculating a guinea-pig (say with 1 c.c. of a 24 hours' broth culture) will be conclusive, but we consider that for all practical purposes an organism having all the microscopical and cultural characters of the diphtheria bacillus may be accepted as such. Even if it is non-virulent, it is probably only an attenuated diphtheria bacillus. L. Martin, moreover, has recently pointed out that some races of diphtheria bacillus are so attenuated that 1 c.c. of a 24 hours' growth in bouillon does not cause death in a guinea-pig, yet the true nature is shown not only by their microscopical characters, etc., but also by the fact that on more prolonged growth they form small quantities of toxin, which is neutralised by diphtheria antitoxin. Neisser also, as the result of an extended inquiry, comes to a similar conclusion with regard to the virulence, and considers that the characteristic staining, the morphological characters, and the production of acid in glucose broth, when taken together, afford conclusive evidence as to the identity of the diphtheria bacillus.

The question, however, has a special interest in regard to the

origin and spread of the disease. As is well known, the disease usually spreads by infection, direct or indirect, from patient to patient; but sometimes it appears to start afresh, as it were. In the latter case the existence of the non-virulent diphtheria bacilli may possibly afford an explanation of the occurrence, as such bacilli are sometimes found even in healthy subjects. The possibility of the transformation of the pseudo-diphtheria ("Hofmann's") into the true diphtheria bacillus has been the subject of much controversy, but it cannot be regarded as sufficiently established that such a transformation may be effected, still less that the former organism is related to the origin and spread of diphtheria.

Xerosis bacillus. — The term has been given to an organism first observed by Kuschbert and Neisser in xerosis of the conjunctiva, and which has been since found in many other affections of the conjunctiva and even in normal conditions. Morphologically it is practically similar to the diphtheria bacillus, and even in cultures presents very minor differences. It is, however, non-virulent to animals, and, according to Eyre, does not produce an acid reaction in neutral bouillon; in this way it can be distinguished from the diphtheria bacillus.

Action of the Diphtheria Bacillus. — Summary. — From a study of the morbid changes in diphtheria and of the results produced experimentally by the bacillus and its toxins, the following summary may be given of its action in the body. Locally, the bacillus produces inflammatory change with fibrinous exudation, but at the same time cellular necrosis is also an outstanding feature. Though false membranes have not been produced by the toxins, a necrotic action may result when these are injected subcutaneously. The toxins also act upon the blood-vessels, and hence œdema and tendency to hæmorrhage are produced; this action on the vessels is also exemplified by the general congestion of organs. The hyaline change in the walls of arterioles and capillaries so often met with in diphtheria is another example of the action of the toxin. The toxins have also a pernicious action on highly developed cells and on nerve fibres. Thus, in the kidney, cloudy swelling occurs, which may be followed by actual necrosis of the secreting cells, and along with these changes albuminuria is present. The action is also well seen in the case of the muscle fibres of the heart, which may undergo a sort of hyaline change, followed by granular disintegration or by an actual fatty degeneration. These changes

are of great importance in relation to heart failure in the disease. Changes of a somewhat similar nature have been recently observed in the nerve cells of the central nervous system, those lying near the capillaries, it is said, being affected first. There is also the striking change on the peripheral nerves, which is shown first by the disintegration of the medullary sheaths, as already described. It is, however, still a matter of dispute to what extent these nerve lesions are of primary nature or secondary to changes in the nerve cells.

Methods of Diagnosis.—The bacteriological diagnosis of diphtheria depends on the discovery of the bacillus. As the bacillus occurs in largest numbers in the membrane, a portion of this should be obtained whenever it is possible, and transferred to a sterile test-tube. (The tube can be readily sterilised by boiling some water in it.) If, however, membrane cannot be obtained, a scraping of the surface with a platinum loop may be sufficient. Where the membrane is confined to the trachea the bacilli are often present in the secretions of the pharynx, and may be obtained from that situation by swabbing it with cotton wool (non-antiseptic), the swab being put into a sterile tube or bottle for transport. A convenient method is to twist a piece of cotton wool round the roughened end of a piece of very stout iron wire, six inches long, and pass the other end of the latter through a cotton plug inserted in the mouth of a test-tube (compare Fig. 54, the wire taking the place of the pipette), and sterilise. In use the wire and plug are extracted in one piece, and after swabbing are replaced in the tube for transit. A scraping may be made off the swab for microscopic examination, and the swab may be smeared over the surface of a serum tube to obtain a culture.

The means for identifying the bacillus are (*a*) *By microscopical examination.*—For microscopical examination it is sufficient to tease out a piece of the membrane with forceps and rub it on a cover-glass, or if it be somewhat dry a small drop of distilled water should be added. The films are then dried in the usual way and stained with any ordinary basic stain, though methylene-blue is on the whole to be preferred, used either as a saturated watery solution or in the form of Löffler's solution. After staining for two or three minutes the films are washed in water, dried, and mounted. As a rule no decolorising is necessary, as

the blue does not overstain. Neisser's stain (p. 363) may also be used with advantage. Any secretion from the pharynx or other part is to be treated in the same way. The value of microscopical examination alone depends much upon the experience of the observer. In some cases the bacilli are present in characteristic form in such numbers as to leave no doubt in the matter. In other cases a few only may be found, mixed with large quantities of other organisms, and sometimes their characters are not sufficiently distinct to render a definite opinion possible. We have frequently obtained the bacillus by means of cultures, when the result of microscopical examination of the same piece of membrane was non-conclusive. As already said, however, microscopical examination alone is more reliable after the observer has had experience in examining cases of diphtheria and making cultures from them.

(b) *By making Cultures.*—For this purpose a piece of the membrane should be separated by forceps from the pharynx or other part when that is possible. It should be then washed well in a tube containing sterile water, most of the surface impurities being removed in this way. A fragment is then fixed in a platinum loop by means of sterile forceps, and a series of stroke-cultures are made on the surface of any of the media mentioned (p. 361), the same portion of the membrane being always brought into contact with the surface. The tubes are then placed in the incubator at 37° C., and, in the case of the serum media and blood agar, the circular colonies of the diphtheria bacillus are visible in twenty-four hours. A small portion of a colony is then removed by means of a platinum needle, stained, and examined in the usual way, the characteristic appearance of the organism being readily recognised.

In cases where a suspicion arises that the organism found is the pseudo-diphtheria bacillus, bouillon containing a trace of glucose should be inoculated and incubated at 37° C. The reaction should be tested after one and after two days' growth. If it remains alkaline, the diphtheria bacillus may be excluded. If an acid reaction results, then all the microscopical and cultural characters must be carefully observed, and the virulence of the bacillus may be ascertained by inoculating a guinea-pig, say with 1 c.c. of a broth culture of two days' growth. (See also pp. 370, 371, 372.)

CHAPTER XVII.

TETANUS.¹

SYNONYMS. — LOCKJAW. GERMAN, WUNDSTARRKRAMPF.
FRENCH, TETANOS.

Introductory. — Tetanus is a disease which in natural conditions affects chiefly man and the horse. Clinically it is characterised by the gradual onset of general spasms of the voluntary muscles, commencing in those of the jaw and the back of the neck, and extending to all the muscles of the body. These spasms are of a tonic nature, and, as the disease advances, succeed each other with only a slight intermission of time. There are often, towards the end of a case, fever and rise of respiration and pulse rate. The disease is usually associated with a wound received from four to fourteen days previously, and which has been defiled by earth or dung. Such a wound may be very small. The disease is, in the majority of cases, fatal. *Post mortem* there is little to be observed on naked-eye examination. The most marked feature is the occurrence of patches of congestion in the spinal cord, and especially the medulla.

Historical. — The general association of the development of tetanus with the presence of wounds, though these might be very small, suggested that some infection took place through the latter, but for long nothing was known as to the nature of this infection. Carle and Rattone in 1884 announced that they had produced the disease in a number of animals by inoculation with material from a wound in tetanus. They thus demonstrated the transmissibility of the disease. Nicolaier (1885) infected mice and rabbits with garden earth, and found that many of them developed tetanus. Suppuration occurred in the neighbourhood of the point of inoculation, and in this pus, besides other organisms, there was always present, when tetanus had occurred, a bacillus having certain constant microscopic characters. Inoculation of fresh animals with such pus reproduced the disease. Nicolaier's attempts at its isolation by the ordinary gelatin plate-culture method were, however, un-

¹ This disease is not to be confused with the "tetany" of infants, which in its essential pathology probably differs from tetanus. This remark of course does not exclude the possibility of the occurrence of true tetanus in very young subjects.

successful. He succeeded in getting it to grow in liquid blood serum, but always in mixture with other organisms. Infection of animals with such a culture produced the disease. These results were confirmed by Rosenbach, who, though failing to obtain a pure culture, cultivated the other organisms present, and inoculated them, but with negative results. He further pointed out, as characteristic of the bacillus, its development of terminal spores. In 1889, Kitasato succeeded in isolating, from the local suppuration of mice inoculated from a human case, several bacilli, only one of which, when injected in pure culture into animals, caused the disease, and which was now named the *B. tetani*. This organism is the same as that observed by Nicolaier and Rosenbach. Kitasato found that the cause of earlier culture failures was the fact that it could only grow in the absence of oxygen. The pathology of the disease was further elucidated by Faber, who, having isolated bacterium-free poisons from cultures, reproduced the symptoms of the disease.

Bacillus Tetani. — If in a case of tetanus naturally arising in man there be a definite wound with pus formation or necrotic change, the bacillus tetani may be recognised in film preparations from the pus, if the characteristic spore formation has occurred (Fig. 126). If, however, the tetanus bacilli have not formed spores, they appear as somewhat slender rods, without presenting any characteristic features. There is usually present in such pus a great variety of other organisms — cocci and bacilli.

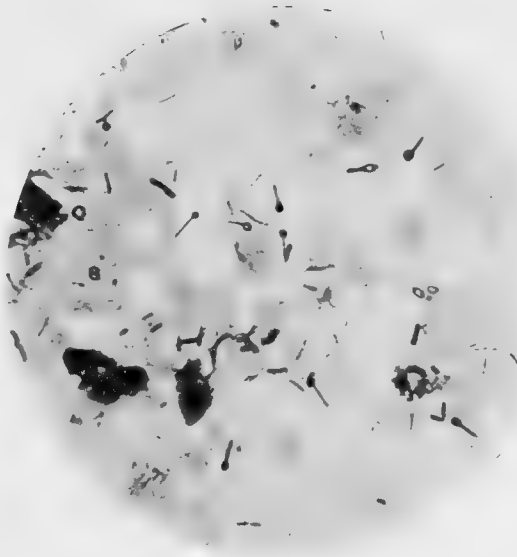

FIG. 126. — Film preparation of discharge from wound in a case of tetanus, showing several tetanus bacilli of "drumstick" form. (The thicker bacillus with oval and not quite terminal spore, in the upper part of the field towards the right side, is not a tetanus bacillus but a putrefactive anaerobe which was obtained in pure culture from the wound.) Stained with gentian-violet. $\times 1000$.

The characters of the bacillus are, therefore, best studied in cultures. It is then seen to be a slender organism, usually about

$4\ \mu$ to $5\ \mu$ in length and $.4\ \mu$ in thickness, with somewhat rounded ends. Besides occurring as short rods it also develops filamentous

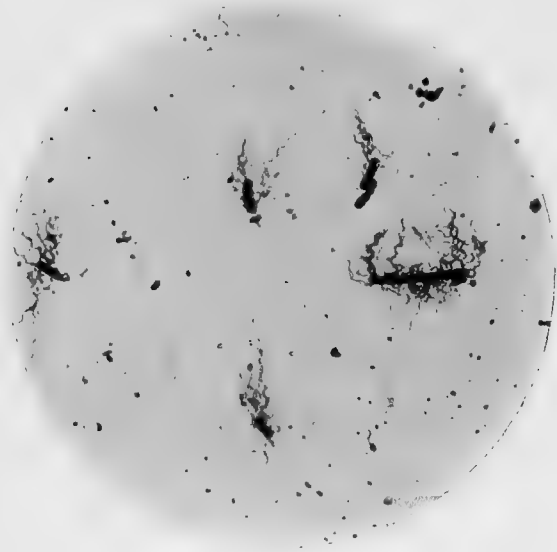

FIG. 127.—Tetanus bacilli, showing flagella. Stained by Rd. Muir's method. $\times 1000$.

forms, the latter being more common in fluid media. It stains readily by any of the usual stains and also by Gram's method. A feature in it is the uniformity with which the protoplasm stains. It is very slightly motile, and its motility can be best studied in an anaerobic hanging-drop preparation (p. 69).

When stained by the special methods already described, it is found to possess numerous delicate flagella attached both at the sides and at the ends (Fig. 127). These flagella, though they may be of considerable length, are usually curled up close to the body of the bacillus. The formation of flagella can be best studied in preparations made from surface anaerobic cultures (p. 66). As is the case with many other anaerobic flagellated bacteria the flagella, on becoming detached, often become massed together in the form of spirals of striking appearance (Fig. 128). At incubation temperature *B. tetani* readily forms spores, and then presents

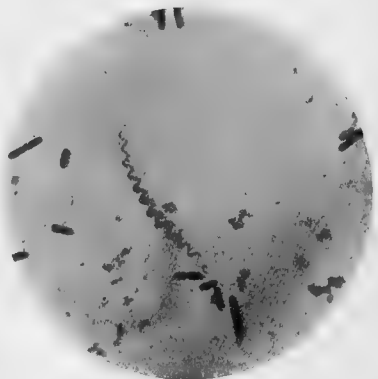

FIG. 128.—Spiral composed of numerous twisted flagella of the tetanus bacillus. Stained by Rd. Muir's method. $\times 1000$.

a very characteristic appearance. The spores are round, and in diameter may be three or four times the thickness of the bacilli. They are developed at one end of a bacillus, which thus assumes what is usually described as the drumstick form (Figs. 126, 129). Upon rare occasions a spore may form at each pole of a bacillus, producing a dumb-bell form (see Fig. 130). In a specimen stained with a watery solution of gentian-violet or methy-

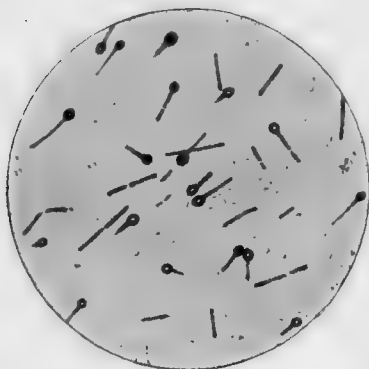

FIG. 129.—Tetanus bacilli; some of which possess spores. From a culture in glucose agar, incubated for three days at 37° C. Stained with carbol-fuchsin. $\times 1000$.



FIG. 130.—Bipolar spore formation in a glucose agar culture of *B. tetani*. (Dr. Chas. H. Potter.) $\times 1000$.

lene-blue, the spores are uncoloured except at the periphery, so that the appearance of a small ring is produced; if a powerful stain such as carbol-fuchsin be applied for some time, the spores become deeply coloured like the bacilli. Further, especially if the culture preparation be heated, the spores may become free in the culture medium.

Isolation.—The isolation of the tetanus bacillus is somewhat difficult. By inoculation experiments in animals, its natural habitat has been proved to be garden soil, and especially the contents of dung heaps, where it probably leads a saprophytic existence, though its function as a saprophyte is unknown. From such sources and from the pus of wounds in tetanus, occurring naturally or experimentally produced, it has been isolated by means of the methods appropriate for anaerobic bacteria. The best methods for dealing with such pus are as follows:—

(1) The principle is to take advantage of the resistance of the spores of the bacillus to heat. A sloped tube of inspissated

serum or a deep tube of glucose agar is inoculated with the pus and incubated at 37° C. for forty-eight hours, at the end of which time numerous spore-bearing bacilli can often be observed microscopically. The culture is then kept at 80° C. for from three-quarters to one hour, with the view of killing all organisms except those which have spored. A loopful is then added to glucose gelatin, and roll-tube cultures are made in the usual way and kept in an atmosphere of hydrogen at 22° C.; after five days the plates are ready for examination. Kitasato compares the colonies in gelatin plates to those of the *B. subtilis*. They consist of a thick centre with shoots radiating out on all sides. They liquefy the gelatin more slowly than the *B. subtilis*. This method of isolation is not always successful, partly because along with the tetanus bacilli, both in its natural habitats outside the body and in the pus of wounds, other spore-forming obligatory and facultative anaerobes occur, which grow faster than the tetanus bacillus, and thus overgrow it.

(2) If in any discharge the spore-bearing tetanus bacilli be seen on microscopic examination, then a method of isolation based on the same principle as the last may be adopted. Inoculations with the suspected material are made in half a dozen deep tubes of glucose agar, previously melted and kept at a temperature of 100° C. After inoculation they are again placed in boiling water and kept for varying times, say for half a minute, for one, three, four, five, and six minutes respectively. They are then plunged in cold water till cool, and thereafter placed in the incubator at 37° C., in the hope that in one or other of the tubes all the organisms present will have been killed, except the tetanus spores which can develop in pure culture.

(3) Some method of anaerobically making plates, such as that of Bulloch or Novy, may be employed. The isolation of the tetanus bacillus is in many cases a difficult matter, and various expedients require to be tried.

Characters of Cultures. — Pure cultures having been obtained, sub-cultures can be made in deep upright glucose gelatin or agar tubes. On *glucose gelatin* in such a tube there commences, an inch or so below the surface, a growth consisting of fine straight threads, rather longer in the lower than in the upper parts of the tube, radiating out from the needle track (Fig. 131). Slow lique-

faction of the gelatin takes place, with slight gas formation. In *agar* the growth is somewhat similar, consisting of small nodules along the needle track, with irregular short offshoots passing out into the medium (Fig. 134, A). There is slight formation of gas, but, of course, no liquefaction. Growth also occurs in *blood serum* and also in *glucose bouillon* under anaerobic conditions. The latter is the medium usually employed for obtaining the soluble products of the organism. There is in it at first a slight turbidity, and later a thin layer of a powdery deposit on the walls of the vessel. All the cultures give out a peculiar burnt odour of rather unpleasant character.

Conditions of Growth, etc. — The *B. tetani* grows best at 37° C. The minimum growth temperature is about 14° C., and below 22° C. growth takes place very slowly. Growth takes place only in the absence of oxygen, the organism being a strict *anaerobe*. Sporulation may commence at the end of twenty-four hours in cultures grown at 37° C., — much later at lower temperatures. Like other spores, those of tetanus are extremely resistant. They can usually withstand boiling for five minutes, and can be kept in a dry condition for many months without being killed or losing their virulence. They have also high powers of resistance to antiseptics.

Pathogenic Effects. — The proof that the *B. tetani* is the cause of tetanus is complete. It can be isolated in pure culture, and when re-injected in pure culture it reproduces the disease. It may be impossible to isolate it from some cases of the disease, but the cause of this very probably is the small numbers in which it sometimes occurs.

(a) *The Disease as arising Naturally.* — The disease occurs naturally, chiefly in horses and in man. Other animals may, however, be affected. There is usually some wound, often of a ragged character, which has either been made by an object soiled with earth or dung, or which has become contaminated with these substances. There is often purulent or fœtid discharge, though this may be absent. Microscopic examination



FIG. 131. — Stab-culture of the tetanus bacillus in glucose gelatin, showing the lateral shoots (Kitasato). Natural size.

of sections may show at the edges of the wound necrosed tissue in which the tetanus bacilli may be very numerous. If a scraping from the wound be examined microscopically, bacilli resembling the tetanus bacillus may be recognised. If these have spored, there can be practically no doubt as to their identity, as the drumstick appearance which the terminal spore gives to the bacillus is not common among other bacilli. Care must be taken, however, to distinguish it from other thicker bacilli with oval spores placed at a short distance from their extremities, such forms being common in earth, etc., and also met with in contaminated wounds (Fig. 126). It is important to note that the wound through which infection has taken place may be very small, in fact, may consist of a mere abrasion. In some cases, especially in the tropics, it may be merely the bite of an insect. The absence of a definite channel of infection has given rise to the term "idiopathic" tetanus. There is, however, practically no doubt that all such cases are true cases of tetanus, and that in all of them the cause is the *B. tetani*. The latter has also been found in the bronchial mucous membrane in some cases of the so-called rheumatic tetanus, the cause of which is usually said to be cold.

The pathological changes found *post mortem* are not striking. There may be hæmorrhages in the muscles which have been the subject of the spasms. These are probably due to mechanical causes. Naturally it is in the nervous system that we look for the most important lesions. Here there is ordinarily a general redness of the grey matter, and the most striking feature is the occurrence of irregular patches of slight congestion which are not limited particularly to grey or white matter, or to any tract of the latter. These patches are usually best marked in the grey matter of the medulla and pons. Microscopically there is little of a definite nature to be found. There is congestion, and there may be minute hæmorrhages in the areas noted by the naked eye. The ganglion cells may show appearances which have been regarded as degenerative in nature, and similar changes have been described in the white matter. The only marked feature is thus a vascular disturbance in the central nervous system, with a possible tendency to degeneration in its specialised cell. Both of these conditions are probably due to the action of the toxins of the bacillus. In the case of the

cellular degenerations the cells have been observed to return to the normal under the curative influence of the antitoxins (*vide infra*). In the other organs of the body there are no constant changes.

We have said that the general distribution of pathogenic bacteria throughout the body is probably a relative phenomenon, and that bacteria usually found locally may occur generally, and *vice versa*. With regard to the tetanus bacillus it is, however, probably the case that very rarely, if ever, are the organisms found anywhere except in the local lesion.

(b) *The Artificially-produced Disease.* — The disease can be communicated to animals by any of the usual methods of inoculation, but does not arise in animals fed with bacilli, whether these contain spores or not. Kitasato found that pure cultures, injected subcutaneously or intravenously, caused death in mice, rats, guinea-pigs, and rabbits. In mice, symptoms appear in a day, and death occurs in two or three days, after inoculation with a loopful of a bouillon culture. The other animals mentioned require larger doses, and death does not occur so rapidly. Usually in animals injected subcutaneously the spasms begin in the limb nearest the point of inoculation. In intravenous inoculation the spasms begin in the extensor muscles of the trunk, as is the case in the natural disease in man. After death there is found slight hyperæmia, without pus formation, at the seat of inoculation. The bacilli diminish in number, and may be absent at the time of death. The organs generally show little change.

Kitasato states that in his earlier experiments the quantity of culture medium injected along with the bacilli already contained enough of the poisonous bodies formed by the bacilli to cause death. The symptoms came on sooner than by the improved method mentioned below, and were, therefore, due to the toxins already present. In his subsequent work, therefore, he employed splinters of wood soaked in cultures in which spores were present, and subsequently subjected for one hour to a temperature of 80° C. The latter treatment not only killed all the bacilli, but, as we shall see, was sufficient to destroy the activity of the toxins. When such splinters are introduced subcutaneously, death results by the development of the spores which they carry. In this way he completed the proof that

the bacilli by themselves can form toxins in the body and produce the disease. Further, if a small quantity of garden earth be placed under the skin of a mouse, or better that of a white rat, death from tetanus takes place in a great many cases. [Sometimes, however, in such circumstances death occurs without tetanic symptoms, and is not due to the tetanus bacillus but to the bacillus of malignant œdema, which also is of common occurrence in the soil (*vide infra*).] By such experiments, supplemented by the culture experiments mentioned, the natural habitats of the *B. tetani*, as given above, have become known.

The Toxins of the Tetanus Bacillus.—The tetanus bacillus being thus accepted as the cause of the disease, we have to consider how it produces its pathogenic effects.

Almost contemporaneously with the work on diphtheria was the attempt made with regard to tetanus to explain the general symptoms by supposing that the bacillus could excrete soluble poisons. The earlier results in which certain bases, tetanin and tetanotoxin, were said to have been isolated, have only a historic interest, as they were obtained by faulty methods. In 1890 Brieger and Fraenkel announced that they had isolated a *toxalbumin* from tetanus cultures, and this body was independently discovered by Faber in the same year. Brieger and Fraenkel's body consisted practically of an alcoholic precipitate from filtered culture in bouillon, and was undoubtedly toxic. Within recent years such attempts to isolate tetanus toxins in a pure condition have practically been abandoned, and attention has been turned to the investigation of the physiological effects either of the crude toxin present in filtered bouillon cultures, or of the precipitate produced from the same by ammonium sulphate (cf. p. 176).

The toxic properties of bacterium-free filtrates of pure cultures of the *B. tetani* were investigated in 1891 by Kitasato. This observer found that when the filtrate, in certain doses, was injected subcutaneously or intravenously into mice, tetanic spasms developed, first in muscles contiguous to the site of inoculation and later all over the body. Death resulted. He found that guinea-pigs were more susceptible than mice, and rabbits less so. In order that a strongly toxic bouillon be produced, it must originally have been either neutral or slightly alkaline. Kitasato further found that the toxin was easily injured by heat. Exposure for a few minutes at 65° C. destroyed it. It was also destroyed by twenty minutes' exposure at 60° C., and by one and a half hours' at 55° C. Drying had no effect. It was, however, destroyed by various chemicals such as pyro-

gallol and also by sunlight. Behring has more recently pointed out that after the filtration of cultures containing toxin, the latter may very rapidly lose its power, and in a few days may only possess $\frac{1}{100}$ th of its original toxicity. This he attributes to such factors as temperature and light, and especially to the action of oxygen. The effect of these agents on the crude toxin is undoubtedly to cause a degeneration of the true toxin into a series of toxoids similar to those produced in the case of diphtheria toxin, and it is also true here that the toxoids while losing their toxicity may still retain their power of producing immunity against the potent toxin. Further, altogether apart from the occurrence side by side in the crude toxin of strong and weak poisons, it has been shown that such crude toxin contains toxic substances of probably quite a different nature. Ehrlich has shown that besides the predominant spasm-producing toxin (called by him tetanospasmin), there exists in crude toxin a poison capable of producing the solution of certain red blood corpuscles. This hæmolytic agent he calls tetanolysin. It does not occur in all samples of crude tetanus toxin, nor is it found when a bouillon culture of the bacillus is filtered through porcelain. To obtain it the fresh culture must be treated by ammonium sulphate, as described in the method of obtaining concentrated toxins (p. 176). This substance also has the power of originating an antitoxin so that certain antitetanic sera can protect red blood corpuscles against its action. Madsen, studying the interactions of this antitetanolysin with the tetanolysin, has shown that the latter may appear in the form of an active poison, and of bodies corresponding to toxoids, and he has confirmed Ehrlich's views on the possession by true toxins of haptophorous and toxophorous groups. That there are close resemblances in nature between the tetanus and diphtheria toxins is further shown by the fact that the action of an acid on tetanus toxin is to cause an apparent disappearance of toxicity, but if before a certain time has elapsed the acid be neutralised by alkali, then a degree of the toxicity returns.

Various attempts have been made to find out the nature of the tetanus poisons. Sidney Martin derived from the organs of persons dead of tetanus two classes of bodies. One of these consisted of a purified alcoholic precipitate (formed chiefly of albumoses). To these he attributes a fever-producing action.

The other bodies were those soluble in alcohol and also in ether. They were non-proteid, and to them he attributed the excitation of the muscular spasms in tetanus. Uschinsky, moreover, has found that the bacillus can produce its toxin when growing in a fluid containing no proteid matter. The toxin may thus be formed independently of the breaking up of the proteids on which the bacillus may be living, though it no doubt has a digestive action on these. Brieger also now apparently thinks that the toxicity of the toxalbumins originally described by him is due to the presence of a non-proteid body.

It is thought by some that a *diastase* is concerned in the toxic action of the tetanus bacillus. Like a ferment, the toxin is destroyed, as we have seen, by comparatively low temperatures, but, as has already been pointed out (Chap. VI.), it may simply be an unstable chemical compound, for albuminous bodies not diastatic in nature may be changed at similar temperatures. The liquefaction (*i.e.* probable peptonisation) of gelatin cultures advances *pari passu* with the development of toxins, and filtered bacterium-free cultures will still liquefy gelatin. It is probable, however, that there is developed, in addition, a peptic ferment which will, of course, also pass through the filter. For if equal portions of the filtered culture be left in contact with equal portions of gelatin for various lengths of time, there is no increase of toxicity in those kept longest. There is thus no fresh development of toxin during the advancing liquefaction of the gelatin. Thus peptic digestion and toxic formation are apparently due to different vital processes on the part of the tetanus bacillus.

An argument in favour of a ferment being concerned in the toxin production is derived from the occurrence of a definite incubation period between the introduction of the toxin into an animal's body and the appearance of symptoms. The incubation period varies according to the species of animal employed, and the path of infection. In the guinea-pig it is from thirteen to eighteen hours, in the horse five days, and the incubation is shorter when the poison is introduced into a vein than when injected subcutaneously. The interpretation put on the occurrence of this period of incubation by the upholders of the ferment theory has been that a time is required for the supposed diastase to elaborate from the tissues albumoses, which are the immediately toxic agents.

Whatever the nature of the toxin is, it is undoubtedly one of the most powerful poisons known. Even with his probably impure toxalbumin Brieger found that the fatal dose for a mouse was .0005 of a milligramme. If the susceptibility of man be the same as that of a mouse, the fatal dose for an average adult would be .23 of a milligramme or about $\frac{7}{20000}$ ths of a grain.

With regard to the *action* of the toxin it has been shown to have no effect on the sensory or motor endings of the nerves. It acts solely as an exciter of the reflex excitability of the motor cells in the spinal cord. The motor cells in the pons and medulla are also affected, and to a much greater degree than those in the cerebral cortex. When injected subcutaneously the toxin probably to a certain extent is absorbed into the sheaths of the nerves, and thence finds its way to that part of the spinal cord from which these nerves spring. This explains the fact that in an animal often the tetanic spasms appear first in the muscles of the part in which the inoculation has taken place. It is doubtful whether such absorption takes place in tetanus arising naturally in man. In artificial injection of toxin part finds its way into the blood stream, and if infected animals be killed during the incubation period there is often evidence of toxin in the blood and solid organs. Rarely, however, during this period, and probably never after symptoms have begun, is there free toxin in the central nervous system. In the guinea-pig there is little doubt that tetanus toxin has an affinity solely for the nervous system. In other animals, such as the rabbit, an affinity may exist in other organs, and the fixation of the poison in such situations may give rise to no recognisable symptoms. In such an animal as the alligator, it is possible that while some of its organs have an affinity for tetanus toxin its nervous system has none. These facts are of great scientific interest, and a possible explanation of them will be discussed in the chapter on Immunity. If tetanus toxin be introduced into the stomach or intestine, it is not absorbed. It to a large extent passes through the intestine unchanged. Evidence that any destruction takes place is wanting.

Toxin in the Circulating Blood. — A research of far-reaching importance upon the amount of tetanus toxin circulating in the blood of horses infected with the disease has just been completed by Bolton and Fisch of St. Louis. It was undertaken as a result of an inquiry into a number of fatal cases of tetanus.

nus developing in diphtheria patients who were being treated with antitoxin. Evidence was brought forth which showed that a horse supplying the antitoxic serum had died of tetanus shortly after the bleeding which furnished the fatal serum, but at the time of the bleeding no symptoms of tetanus had been noticeable. Samples of this serum proved to contain enough tetanus toxin in 0.1 c.c. to kill a guinea-pig in a few days.

With these facts before them, Bolton and Fisch carried out a study upon five horses, three of which were inoculated artificially with *B. tetani*, and two in which tetanus had developed accidentally. Summarized, their results show that:—

1. Tetanus toxin may appear in the blood of infected horses four to five days before symptoms of tetanus are manifested, and sufficient to kill human beings in doses of 10–100 c.c. of such a serum.
2. Within a day or two of the death of an infected horse, having some or no symptoms of tetanus, the toxin reaches a maximum and then rapidly declines, so that shortly before death no toxin can be demonstrated.
3. Shortly before death circulating toxin is replaced by antitoxin.
4. It is quite a difficult matter to induce tetanus in the horse by artificially inoculating it with tetanus-bearing earth.

In the light of the above results, which are decidedly impressive, it is now imperative, for the preservation of the public, that *all* diphtheria antitoxic serum shall be tested for tetanus toxin before being marketed, whether horses furnishing the serum appeared to be in health or not.

There is one question which must arise in connection with tetanus, namely: Granted that the *B. tetani* is so widely present in the soil, how is it that the disease is not more common than it is, for wounds must constantly be contaminated with such soil? Experiments by Vaillard throw light on this point. We have seen that unless suitable precautions are adopted, in experimental tetanus in animals death results not from inoculation but from an intoxication with toxin previously existent in the fluid in which the bacilli have been growing. According to Vaillard, if spores rendered toxin-free by being kept for a sufficient time at 80° C. are injected into an animal, death does not take place. It was found, however, that such spores can be rendered pathogenic by injecting along with them such chemicals as lactic acid, by injuring the point of inoculation so as to cause effusion of blood, by fracturing an adjacent bone, by introducing a mechanical irritant such as soil or a splinter of wood (as in Kitasato's experiments), or by the simultaneous injection of other bacteria such as the *staphylococcus pyogenes aureus*. These facts, especially the last, throw great light on the disease as it occurs naturally, for tetanus results especially from wounds

which have been accidentally subjected to conditions such as those enumerated. Kitasato now holds that in the natural infection in man, along with tetanus spores, the presence of foreign material or of other bacteria is necessary. Spores alone or tetanus bacilli without spores die in the tissues, and tetanus does not result.

Summary. — In view of all the facts available we must thus look on tetanus as caused by the *B. tetani*. The bacillus gains entrance to the body through wounds or abrasions, and, multiplying locally, produces poisons which diffuse into the tissues and have an elective action as stimulators, especially of the spinal cord. The chemical composition of these poisons is not yet fully known. The enormous potency of such poisons explains how, even in a fatal case, extreme smallness of the wound and difficulty in isolating the bacillus do not detract from the theory that the latter is the cause of the disease.

Immunity against Tetanus. — Antitetanic Serum. — The artificial immunisation of animals against tetanus has received much attention. The most complete study of the question is found in the work of Behring and Kitasato in Germany, and of Tizzoni and Cattani in Italy. The former observers found that such an immunity could be conferred by the injection of very small and progressively increasing doses of the tetanus toxin. The degree of immunity attained, however, was not high. More successful was the method of accompanying the early injections of such toxin with the subcutaneous introduction of small doses of iodine terchloride. Tizzoni and Cattani have also used the method of administering progressively increasing doses of living cultures attenuated in various ways, *e.g.* by heat. By any of these methods susceptible animals can rapidly acquire great immunity, not only against many times the fatal dose of tetanic toxin, but also against injections of the living bacilli. The degree of immunisation acquired by an animal remains in existence for several months. Not only so, but when a high degree of immunity has been produced by prolonged treatment, it is found that the serum of immune animals usually possesses the capacity, when injected into animals susceptible to the disease, of protecting them against a subsequent infection with a fatal dose of tetanus bacilli or toxin. Further, if injected subsequently to such infection, the serum can in certain cases prevent

a fatal result, even when symptoms have begun to appear. The degree of success attained depends, however, on the shortness of the time which has elapsed between the infection with the bacilli or toxin and the injection of the serum. The longer the interval which is allowed to elapse, not only the greater must be the dose of the serum but the less likely is cure to occur. In animals where symptoms have fully manifested themselves only a small proportion of cases can be saved. As in other cases, there is no evidence that the antitetanic serum has any detrimental effect on the bacilli. It only neutralises the effects of the toxin. The standardisation of the antitetanic serum is of the highest importance. Behring recommends that for protecting animals a serum should be obtained of which one gramme will protect 1,000,000 grammes' weight of mice against the minimum fatal dose of the bacillus or toxin. A mouse weighing twenty grammes would thus require .00002 gramme of such a serum to protect it against the minimum lethal dose. In the injection of such a serum subsequent to infection, if symptoms have begun to appear, 1000 times this dose would be necessary; a few hours later 10,000 times, and so on.

As the result of his experiments, Behring aimed at obtaining a curative effect in the natural disease occurring in man. For this purpose, as for his later laboratory experiments, he obtained serum by the immunisation of such large animals as the horse, the sheep, and the goat. The principles of the process were the same as in his earlier work, namely, the injection of toxin, accompanied at first with the injection of iodine terchloride. It was found that the greater the degree of the natural susceptibility of an animal to tetanus, the easier it was to obtain a serum of a high antitetanic potency. The horse was, therefore, the most suitable animal. If now we take for granted that the relative susceptibility of man and the mouse towards tetanus are nearly equal, a man weighing 100 kilogram. would require .1 grm. of the serum mentioned above to protect him from inoculation with the minimum lethal dose of bacilli or toxin. If symptoms had begun to appear, 100 c.c. at once would be necessary, and as the injection of such a quantity might be inconvenient, Behring recommended that for man a more powerful serum should be obtained, viz., a serum of which one gramme would

protect 100,000,000 grammes' weight of mice.¹ The potency is maintained for several months if precautions are taken to avoid putrefaction, exposure to bright light, etc. To this end .5 per cent carbolic acid is usually added, and the serum is kept in the dark. In a case of tetanus in man, 100 c.c. of such a serum should be injected within twenty-four hours in five doses, each at a different part of the body, and this followed up by further injections if no improvement takes place. It is stated that better results have been obtained when the fluid serum has been injected intravenously, and that large amounts can be safely employed. Of this method we have had no experience. The serum has also been introduced intracerebrally, very slow injection into the brain substance being practised, but no better results have been obtained than by the subcutaneous method.

Many cases of human tetanus have been thus treated, but with only a small measure of success. The improvement in the death-rate has not been nearly so marked as that which has occurred in diphtheria, under similar circumstances. As in the case of diphtheria, however, the results would probably be better if more attention were paid to the dosage of the serum. The great difficulty is that, as a matter of fact, we have not the opportunity of recognising the presence of the tetanus bacilli till they have begun to manifest their gravest effects. In diphtheria we have a well-marked clinical feature which draws attention to the probable presence of the bacilli—a presence which can be readily proved—and the curative agent can thus be early applied. In tetanus the wound in which the bacilli exist may be, as we have seen, of the most trifling character, and even when a well-marked wound exists, the search for the bacilli may be a matter of difficulty. Still it might be well, when practicable, that every ragged, unhealthy-looking wound, especially when contaminated with soil, should, as a matter of routine, be examined bacteriologically. In such cases, undoubtedly, from time to time cases of tetanus would be detected early, and their treatment could be undertaken with more hope of success than at present. However, in the existing state of

¹ The antitetanic serum sent out by the Pasteur Institute in Paris has a strength of 1-1,000,000,000. Of this it is recommended that 50 to 100 c.c. should be injected in one or two doses.

matters, whenever the first symptoms of tetanus appear, large doses, such as those above indicated, of a serum whose strength is known, should be at once administered. In giving a prognosis as to the probable result, the two clinical observations on which, according to Behring, chief reliance ought to be placed, are the presence or absence of interference with respiration and the rapidity with which the groups of muscles usually affected are attacked. If dyspnoea or irregularity in respiration comes on soon, and if group after group of muscles is quickly involved, then the outlook is extremely grave. In addition to these points the duration of the incubation period is of high importance in forming a prognosis. The shorter the time between the infliction of a wound and the appearance of symptoms the graver is the outlook.

The theory as to the nature of antitoxic action will be discussed later in the chapter on Immunity.

Methods of Examination in a Case of Tetanus. — The routine bacteriological procedure in a case presenting the clinical features of tetanus ought to be as follows: —

(a) *Microscopic.* — Though tetanus is not a disease in which the discovery of the bacilli is easy, still microscopic examination should be undertaken in every case. From every wound or abrasion from which sufficient discharge can be obtained, film preparations ought to be made, and stained with any of the ordinary combinations, *e.g.* carbol-fuchsin diluted with five parts of water. Drumstick-shaped spore-bearing bacilli are to be looked for. The presence of such, having characters corresponding to those of the tetanus bacilli, though not absolutely conclusive proof of identification, is yet sufficient for all practical purposes. If only bacilli without spores, resembling the tetanus bacilli, are seen, then the identification can only be provisional.

The microscopic examination of wounds contaminated by soil, etc., may, as we have said, in some cases lead to the anticipation that tetanus will probably result.

(b) *Cultivation.* — The methods to be employed in isolating the tetanus bacilli have already been described (p. 379). It may be added, however, that if the characteristic forms are not seen on microscopic examination of the material from the wound, they may often be found by inoculating a deep tube

of one of the glucose media with such material, and incubating for forty-eight hours at 37° C. At the end of this period, spore-bearing tetanus bacilli may be detected microscopically, though of course mixed with other organisms.

(c) *Inoculation.* — Mice and guinea-pigs are the most suitable animals. Inoculation with the material from a wound should be made subcutaneously. A loopful of the discharge introduced at the root of the tail in a mouse will soon give rise to the characteristic symptoms, if tetanus bacilli are present.

MALIGNANT ŒDEMA (*Septicémie de Pasteur*).

The organism now usually known as the bacillus of malignant œdema is the same as that first discovered by Pasteur and named *vibrion septique*. He described its characters, distinguishing it from the anthrax bacillus which it somewhat resembles morphologically, and also the lesions produced by it. He found that it grew only in anaerobic conditions, but was able to cultivate it merely in an impure state. It was more fully studied by Koch, who called it the bacillus of malignant œdema, and pointed out that the disease produced by it is not really of the nature of a septicæmia, as immediately after death the blood is practically free from the bacilli.

“Malignant œdema” in the human subject is usually described as a spreading inflammatory œdema attended with emphysema, and ultimately followed by gangrene of the skin and subjacent parts. In many cases of this nature the bacillus of malignant œdema is present, associated with other organisms which aid its spread, whilst in others it may be absent. One of us has, however, observed a case in which the bacillus was present in pure condition. Here there occurred intense œdema with swelling and induration of the tissues, and the formation of vesicles on the skin. Those changes were attended with a reddish discoloration, afterwards becoming livid. Emphysema was not recognisable until the limb was incised, when it was detected, though in small degree. Further, the tissues had a peculiar heavy but not putrid odour. The bacillus, which was obtained in pure culture, was present in enormous numbers in the affected tissues, attended by cellular necrosis, serious exudation, and at places much leucocytic emigration. The picture,

in short, corresponded with that seen on inoculating a guinea-pig with a pure culture. The term "malignant œdema" should be limited in its application to cases in which the bacillus in question is present. In most of these there is a mixed infection; in some this bacillus may be present alone.

This bacillus has a very widespread distribution in nature, being present in garden soil, dung, and various putrefying animal fluids; and it is by contamination of lacerated wounds by such substances that the disease is usually set up in the human subject. Malignant œdema can be readily produced by inoculating susceptible animals, such as guinea-pigs, with garden soil. The bacillus is also often present in the intestine of man and animals, and has been described as being present in some gangrenous conditions originating in connection with the intestine in the human subject.

Bacillus œdematis maligni.—*Microscopical Characters.*—

The bacillus of malignant œdema is a comparatively large or-

ganism, being slightly less than $1\ \mu$ in thickness, that is, thinner than the anthrax bacillus. It occurs in the form of single rods $3\ \mu$ to $10\ \mu$ in length, but both in the tissues and in cultures in fluids it frequently grows out into long filaments, which may be uniform throughout or segmented at irregular inter-

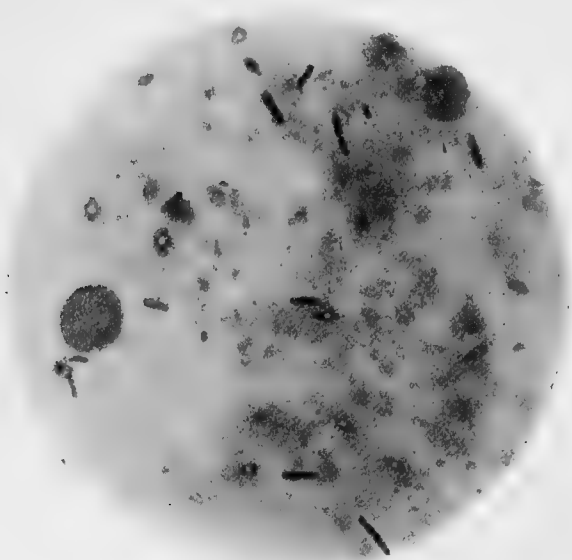

FIG. 132.—Film preparation from the affected tissues in a case of malignant œdema in the human subject, showing the spore-bearing bacilli. Gentian-violet. $\times 1000$.

vals. In cultures on solid media it chiefly occurs in the form of shorter rods with somewhat rounded ends. The rods are motile,

possessing several laterally placed flagella, but in a given specimen, as a rule, only a few bacilli show active movement. Under suitable conditions they form spores which are usually near the centre of the rods and have an oval shape, their thickness somewhat exceeding that of the bacillus (Figs. 132, 133). The bacillus can be readily stained by any of the basic aniline stains, but loses the colour in Gram's method, in this way differing from the anthrax bacillus.

Characters of Cultures. —

This organism grows readily at ordinary temperature, but only under *anaerobic* conditions. In a puncture culture in a deep tube of glucose gelatin, the growth appears as a whitish line giving off minute short processes, the growth, of course, not reaching the surface of the medium. Soon liquefaction occurs, and a long fluid funnel is formed, with turbid contents and flocculent masses of growth at the bottom. At the same time bubbles of gas are given off, which may split up the gelatin. The colonies in gelatin plates under anaerobic conditions appear first as small whitish points which under the microscope show a radiating appearance at the periphery, resembling the colonies of the bacillus subtilis. Soon, however, liquefaction occurs around the colonies, and spheres with turbid contents result; gas is developed around the colonies.

In deep tubes of glucose agar at 37° C., growth is extremely rapid. Along the line of puncture, growth appears as a somewhat broad white line with short lateral projections here and there (Fig. 134, B). Here also gas may be formed, but this is most marked in a shake-culture, in which the medium becomes cracked in various directions, and may be pushed upwards so high as to displace the cotton-wool plug. The cultures possess a peculiar heavy, though not putrid, odour. In litmus milk a feeble acidity is produced with an occasional flocculent precipitation of casein at the end of forty-eight hours; this is soon



FIG. 133. — Bacillus of malignant oedema, showing spores. From a culture in glucose agar, incubated for three days at 37° C. Stained with weak carbol-fuchsin. $\times 1000$.

followed by a peptonising process which advances so that the whole of the medium becomes converted into a muddy-coloured whey that gives off a heavy putrid odour.

Spore formation occurs above 20° C., and is usually well seen within forty-eight hours at 37° C. The spores have the usual high powers of resistance, and may be kept for months in the dried condition without being killed.

Experimental Inoculation. — A considerable number of animals—the guinea-pig, rabbit, sheep, and goat, for example—are susceptible to inoculation with this organism. The ox is said to be quite immune to experimental inoculation, though it can, under certain conditions, contract the disease by natural channels. The

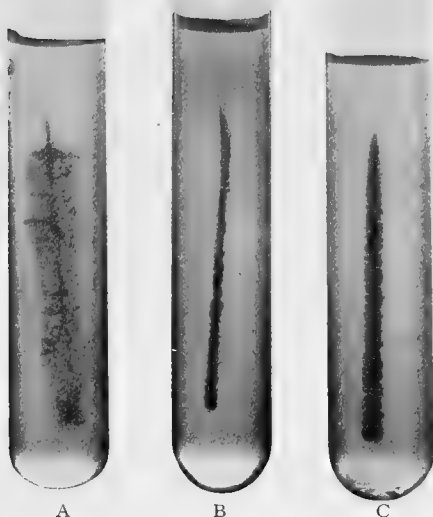

FIG. 134. — Stab-cultures in agar, five days' growth at 37° C. Natural size.

- A. Tetanus bacillus. B. Bacillus of malignant œdema.
C. Bacillus of quarter-evil (Rauschbrand).

guinea-pig is the animal most convenient for experimental inoculation. When the disease is set up in the guinea-pig by subcutaneous inoculation with garden soil, death usually occurs in about twenty-four to forty-eight hours. There is an intense inflammatory œdema around the site of inoculation, which extends over the wall of the abdomen and thorax. The skin and subcutaneous tissue are infiltrated with a reddish-brown fluid and softened; they contain bubbles of gas and are at places gangrenous. The superficial muscles are also involved. These parts have a very putrid odour. The internal organs are congested, the spleen soft but not much enlarged. In such conditions the bacillus of malignant œdema, both in short and long forms, will be found in the affected tissues along with various other organisms. Spores may be present, espe-

cially when the examination is made some time after the death of the animal. If the animal is examined immediately after death, a few of the bacilli may be present in the peritoneum and pleuræ, usually in the form of long motile filaments, but they are almost invariably absent from the blood. A short time after death, however, they spread directly into the blood and various organs, and may then be found in considerable numbers.

Subcutaneous inoculation with pure cultures of the bacillus of malignant œdema produces chiefly a spreading bloody œdema, the muscles being softened and partly necrosed; but there is little formation of gas, and the putrid odour is almost absent.

When the bacilli are injected into mice, however, they enter and multiply in the blood stream, and they are found in considerable numbers in the various organs, so that a condition not unlike that of anthrax is found. The spleen also is much swollen.

The virulence of the bacillus of malignant œdema varies considerably in different cases, and it always becomes diminished in cultures grown for some time. To produce a fatal disease, a relatively large number of the organisms is necessary, and these must be introduced deeply into the tissues, inoculation by scarification being followed by no result. A smaller dose produces a fatal result when injected along with various other organisms (bacillus prodigiosus, etc.).

Immunity. — Malignant œdema was one of the first diseases against which immunity was produced by injection of toxins. The filtered cultures of the bacillus in sufficient doses produce death with the same symptoms as those caused by the living organisms, but a relatively large quantity is necessary. Chamberland and Roux (1887) found that if guinea-pigs were injected with several non-fatal doses of cultures sterilised by heat or freed from the bacilli by filtration, immunity against the living organism could be developed in a comparatively short time. They found that the filtered serum of animals dead of the disease is more highly toxic, and also gives immunity when injected in small doses. These experiments have been confirmed by Sanfelice.

Methods of Diagnosis. — In a case of supposed malignant œdema, the fluid from the affected tissues ought first to be

examined microscopically to ascertain the characters of the organisms present. Though it is not possible to identify absolutely the bacillus of malignant oedema without cultivating it, the presence of spore-bearing bacilli with the characters described above is highly suspicious (Fig. 132). In such a case the fluid containing the bacilli should be first exposed to a temperature of 80° C. for half an hour, and then a deep glucose agar tube should be inoculated. In this way the spore-free organisms are killed off. Pure cultures may be thus obtained, or this procedure may require to be followed by the roll-tube method under anaerobic conditions. An inoculation experiment, if available, may also be made on a guinea-pig.

BACILLUS BOTULINUS.

The term "meat-poisoning" embraces a number of conditions produced by different agents, and the relation of the bacillus of Gaertner to one class of case has already been discussed. Another group was shown by Van Ermengem in 1896 to be caused by an anaerobic bacillus to which he gave the name *bacillus botulinus*. He cultivated the organism from a sample of ham, the ingestion of which in the raw condition had produced a number of cases of poisoning, some of them followed by fatal result. The symptoms in these cases closely corresponded with those occurring in the so-called "sausage-poisoning" met with from time to time in Germany and other countries where sausages and ham are eaten in an imperfectly cooked condition. Such cases form a fairly well-defined group, the symptoms in which are chiefly referable to an action on the medulla, and, as will be detailed below, similar symptoms have been experimentally produced by means of the bacillus mentioned or its toxins. The chief symptoms of this variety of botulismus, as detailed by Van Ermengem, are disordered secretion in the mouth and nose, more or less marked ophthalmoplegia, externa and interna (dilated pupil, ptosis, etc.), dysphagia, and sometimes aphagia with aphonia, marked constipation and retention of urine, and in fatal cases interference with the cardiac and respiratory centres. Along with these there is practically no fever and no interference with the intellectual faculties. The symptoms commence at earliest twelve to twenty-four hours after inges-

tion of the poison. From the ham in question, which was not decomposed in the ordinary sense, Van Ermengem obtained numerous colonies of this bacillus, the leading characters of which are given below. It may be added that Römer obtained practically the same results as Van Ermengem in a similar condition, and that the bacillus botulinus has been cultivated by Kemper from the intestine of the pig.

Microscopical and Cultural Characters. — The organism is a bacillus of considerable size, measuring 4 to 9 μ in length and .9 to 1.2 μ in thickness; it has somewhat rounded ends and sometimes is seen in a spindle form. It is often arranged in pairs, sometimes in short threads. Under certain conditions it forms spores which are oval in shape, usually terminal in position, and a little thicker than the bacilli. It is a motile organism and has 4 to 8 lateral flagella of wavy form. It stains readily with the ordinary dyes, and also retains the colour in Gram's method, though care must be employed in decolorising.

The organism can be readily cultivated on the ordinary media, but only under strictly anaerobic conditions. In glucose gelatin a whitish line of growth forms with lateral offshoots, but liquefaction with abundant gas formation soon occurs. In gelatin plates the colonies after four to six days are somewhat characteristic; they appear to the naked eye as small semi-transparent spheres, and these on examination under a low power of the microscope have a yellowish-brown colour and are seen to be composed of granules which show a streaming movement, especially at the periphery. Cultures in glucose agar resemble those of certain other anaerobes; there is abundant development of gas, and the medium is split up in various directions. The cultures have a rancid, though not foul, odour, due chiefly to the development of butyric acid. The optimum temperature is below that of the body, viz., between 20° and 30° C.; at the body temperature growth is slower and less abundant and spore formation does not occur.

Pathogenic Effects. — Like the tetanus bacillus, the bacillus botulinus has little power of flourishing in the tissues, whereas it produces a very powerful toxin. Van Ermengem found that the characteristic symptoms could be produced in certain animals by administering watery extracts of the infected ham or cultures either by the alimentary canal or by subcutaneous

injection. Here also there is a period of incubation of not less than six to twelve hours before the symptoms appear, and when the dose is small a somewhat chronic condition may result in which local paralyses form a striking feature. The characteristic effects can also be produced by means of the filtered toxin by either of the methods mentioned, though in the case of administration by the alimentary canal the dose requires to be larger. Here also, as in the case of the tetanus poison, the potency of the toxin is remarkable, the fatal dose for a guinea-pig of 250 grammes' weight being in some instances .0005 c.c. of the filtered toxin. In cases of poisoning in the human subject the effects would accordingly appear to be produced by absorption of the toxin from the alimentary canal; it is only after or immediately before death that a few bacilli may enter the tissues. Van Ermengem obtained a few colonies from the spleen of a patient who had died from ham-poisoning. The properties of the botulinus toxin have been investigated and have been found to correspond closely, as regards relative instability, conditions of precipitation, etc., with the toxins of diphtheria and tetanus. An antitoxin has also been prepared by Kempner by the usual methods, and has been shown not only to have the neutralising property, but to have considerable therapeutical value when administered some hours after the toxin. The direct combining affinity of the toxin for the central nervous has been demonstrated by Kempner and Schepilewsky by the same methods as Wassermann and Takaki employed in the case of the tetanus toxin. The condition of the nerve cells in experimental poisoning with the botulinus toxin has been investigated independently by Marinesco and by Kempner and Pollack, and these observers agree as to the occurrence of marked degenerative changes, especially in the motor cells in the spinal cord and medulla. Marinesco also observed hypertrophy and proliferation of the neuroglia cells around them.

These observations, therefore, show that in one variety of meat-poisoning the symptoms are produced by the absorption of the toxins of the bacillus botulinus from the alimentary canal, and, as Van Ermengem points out, it is of special importance to note that the meat may be extensively contaminated with this bacillus and may contain relatively large quantities of its toxins

without the ordinary signs of decomposition being present. The production of an extracellular toxin by this organism, with extremely potent action on the nervous system, is a fact of great scientific interest, and has a bearing on the etiology of other obscure nervous affections.

QUARTER-EVIL (GERMAN, RAUSCHBRAND; FRENCH, CHARBON SYMPTOMATIQUE).

The characters of the bacillus need be only briefly described, as, so far as is known, it never infects the human subject. The natural disease, which specially occurs in certain localities, affects chiefly sheep, cattle, and goats. Infection takes place by some wound of the surface, and there spreads in the region around, inflammatory swelling attended by bloody œdema and emphysema of the tissues. The part becomes greatly swollen, and of a dark, almost black, colour. Hence the name *blackleg* by which the disease is sometimes known. The bacillus which produces this condition is present in large numbers in the affected tissues, associated with other organisms, and also occurs in small numbers in the blood of internal organs.

Bacillus anthracis symptomatici. — The bacillus morphologically closely resembles that of malignant œdema. Like the latter, also, it is a strict anaerobe, and its conditions of growth as regards temperature are also similar. It is, however, somewhat thicker, and does not usually form such long filaments. Moreover the spores, which are of oval shape and broader than the bacillus, are almost invariably situated close to one extremity, though not actually terminal (Fig. 135). The characters of the cultures, also, resemble those of the bacillus of malignant œdema, but in a stab-culture in glucose agar there are more numerous and longer lateral offshoots, the growth being also more luxuriant (Fig. 134, C). This bacillus is actively motile, and possesses numerous lateral flagella. It does not retain the stain by Gram's method.

The disease can be readily produced in various animals, *e.g.* guinea-pigs, by inoculation with the affected tissues of diseased animals, and also by means of pure cultures, though an intramuscular injection of a considerable amount of the latter is sometimes necessary. The condition produced in this way closely resembles that in malignant œdema, though there is said to be more formation of gas in the tissues. Rabbits are very immune against this disease, whilst they are comparatively susceptible to malignant œdema. As in the case of tetanus, inocu-



FIG. 135. — Bacillus of quarter-evil, showing spores. From a culture in glucose agar, incubated for three days at 37° C. Stained with weak carbol-fuchsin. $\times 1000$.

lation with living spores which have been deprived of adherent toxin by heat does not produce the disease.

The disease is one against which immunity can be readily produced in various ways, and methods of preventive inoculation have been adopted in the case of animals liable to suffer from it. This subject was specially worked out by Arloing, Cornevin, and Thomas, and later by others. Immunity may be produced by injection with a non-fatal dose of the virus (*i.e.* the œdematous fluid found in the tissues of affected animals and which contains the bacilli), or by injection with larger quantities of the virus attenuated by heat, drying, etc. It can be produced also by the products of the bacilli obtained by filtration of cultures.

BACILLUS AEROGENES CAPSULATUS.

Bacillus aerogenes capsulatus (Welch). — Synonym : — *Bacillus Welchii* (Migula).

Introductory. — This organism was discovered by Welch in 1891 in the blood and tissues of a tuberculous person who died from rupture of an aortic aneurism. The skin over the body was markedly emphysematous, gas was found in the heart and great vessels, in the loose tissues of the abdominal wall, and in the various solid viscera, which presented the picture called by the Germans, "*Schaumorgane*." A full description of the case and of the bacillus was published by Welch and Nuttall the following year. In 1893 E. Fraenkel published a monograph on emphysematous gangrene and therein described an anaerobic bacillus as being the probable cause, naming it *B. phlegmones emphysematosæ*, which, in all its details, morphological and cultural, corresponded to that described previously by Welch and Nuttall, and later acknowledged by Fraenkel as identical. Since then this organism has been observed over and over again by European workers, mainly ignorant of the American work upon it, and given such names as *B. perfringens*, *B. enteritidis sporogenes*, *Granulo-bacillus immobilis*, etc. In America in recent years papers have appeared by Welch and Flexner, Howard, Bloodgood, Fulton and Pratt, and many others, recording the occurrence of *B. aerogenes capsulatus* in the human body under varied conditions. Welch, in 1900, reviewed the whole literature and recorded many hitherto unpublished facts.

Habitat. — The bacillus is widely distributed, being found in the intestinal contents of most mammals, in sewage, in river water, in garden and field earth, in dust, and in milk and many raw foods.

Morphology. — The bacillus resembles somewhat *B. anthracis*, but generally is stouter and more variable in length (Fig. 136), on an average 3-6 μ , but it may be found in pairs so short as to resemble diplococci, or so long as to form filaments, and chains of 4 to 30 units may be met with. The ends of free bacilli are obtusely rounded, whilst those of organisms in a chain are square cut. The bacillus is usually possessed of a capsule, especially when found in body fluids, rarely in artificial media, but at all times the capsule stains with difficulty.

Spores are generally to be found in blood-serum cultures after four days' incubation, and occasionally they have been observed in cultures in all of the common media. It would appear, however, that some races are devoid of the power to form spores. The majority of the spores are oval in form, less frequently round, and may be situated in the cell either centrally,

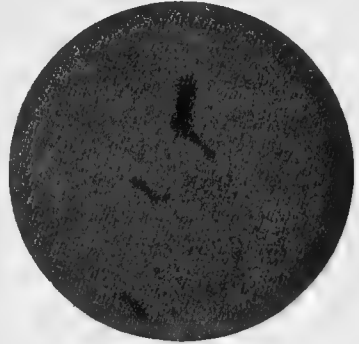

FIG. 136. — *Bacillus aerogenes capsulatus*. — Showing one large, encapsulated form. The others in the field are of the same species, but smaller. (Dr. Charles H. Potter.) $\times 1000$.

and are usually of slightly greater diameter than the bacillus itself. Two have never been found in one cell. They stain readily by any of the ordinary spore-staining methods. They withstand the temperature of boiling water for six minutes, but are killed by eight minutes' boiling. The vegetative cells, however, perish by an exposure of ten minutes in moist heat at 58° C. The bacilli are not possessed of flagella and are non-motile. They stain by Gram's method.

Pathogenesis. — In man, as pointed out by Fraenkel, Welch, Bloodgood, and others, this bacillus is the most frequent cause of emphysematous gangrene. It has been repeatedly found in the inflammatory subcutaneous emphysema following upon injections of salt solution, due to imperfect sterilisation of the instrument or fluid. It has been cultivated from the blood during life in two cases at least — by Gwyn in a case of acute chorea which ended fatally, and by Cole, recently, in the Johns Hopkins Hospital, from the blood of a man whose leg had been crushed in a railroad accident and was at the time of culture

markedly emphysematous; it is notable that in these cases no gas was found in the blood during abstraction of it with the syringe, although closely watched for.

In the lower animals, infections by this bacillus have been rarely met with under natural conditions. Harris, however, has observed local abscesses in the dog and rabbit following upon simple surgical procedures. Under artificial conditions *B. aerogenes capsulatus* is pathogenic for the guinea-pig and pigeon, but practically not for the rabbit and mouse. Experience has shown that the virulence of the bacillus towards guinea-pigs, when injected subcutaneously, varies exceedingly. Certain races are absolutely harmless; some produce local swelling, with or without necrosis and ulceration, whilst others will produce death, accompanied by subcutaneous emphysema and a peculiar digestive-like action upon the subcutaneous tissues and abdominal muscles, so that the intestines can plainly be seen lying in the cavity. There is also much bloody serous fluid along with this necrotic process.

Cultural Characters. — The bacillus is an obligate anaerobe. The surface colonies on *plain-agar* plates appear to the unaided eyes to be well circumscribed, round, flat, grey-white, translucent, smooth, and glossy, with a diameter varying from 1.5 to 4 mm. The deep colonies are seen as small white points, sometimes indistinctly limited. Under the low power of the microscope the surface colonies are found to be not infrequently irregular, with a central mass or nucleus embedded in a surrounding finely granular growth of a light brown-yellow colour, whose periphery is regular and often delicately fringed. The deep colonies are usually of a clear-cut oval or round shape, but occasionally they appear to be surrounded with woolly outgrowths, similar in character to those of *B. tetani*. On *agar* slants the surface growth is thin, grey, translucent, glossy, and veil-like; at times difficult to detect.

In shake-cultures, especially in *glucose agar* or *glucose gelatin*, gas formation is very profuse, so that the medium becomes split up into layers, the uppermost often pressing against the cotton plug. There is an accompanying heavy peculiar odour lacking putrefactive taint. Upon *potato* the growth is usually scant, invisible, or quite negative. Occasionally, however, it is well marked, of a yellow-white colour, semi-lustrous, moist, and show-

ing embedded gas bubbles. It is the rule to find gas bubbles lying in the fluid between the potato and the walls of the tube. The medium never becomes discoloured. *Bouillon* is heavily clouded, and occasionally gas bubbles are seen on top. The precipitated growth is semi-flocculent, white, and diffuses on agitation. In *litmus milk* there occurs the most characteristic reaction. At the end of twenty-four hours the reaction is strongly acid, the casein is found to be coagulated firmly, but at the same time is more or less completely riddled by cavities caused by gas formation (Fig. 137). The resulting whey is usually quite clear; occasionally it may be turbid and yellow. Viscidity is present on rare occasions. Now and again a layer of gas bubbles may cover the surface of the fluid. There is a strong odour of butyric acid present. *Gelatin* may be slowly liquefied by some races of the bacillus, or may merely undergo a softening without any definite liquefying; this latter seems to be more common. Gas formation may occur, due to presence of muscle sugar in the meat extract. On solidified *blood serum* along the line of inoculation is found a rich cream-coloured, elevated, glossy growth, which at the end of a week seems to exercise a feeble peptonising power, denoted by a small furrow forming in the medium upon which the growth rests, but this never goes on to liquefaction.

Lactose, saccharose, and mannite are actively fermented, with accompanying gas formation; so is dextrose-free bouillon and ascitic fluid, and from these facts Welch is of the opinion that the bacillus is capable of forming gas from proteid material alone.

Significance. — Its presence in the tissues during life is to be looked upon as serious in most cases and deserving of prompt attention, surgical or otherwise. *Post mortem*, in the absence of any possible external point of entry, its existence is a matter of no importance, as, like the colon bacillus, it is capable of wan-



FIG. 137. — *B. aerogenes capsulatus*. A 24-hour-old milk culture, showing typical coagulation of the casein. Natural size.

dering into the circulation from the intestine just before, or immediately after, death.

Isolation and Identification. — The suspected material should be transferred in varying quantities to milk and incubated under anaerobic conditions for forty-eight to seventy-two hours, when the typical reaction should be manifest. An incomplete reaction may be brought about by the partial overgrowth of other bacteria, but usually upon sub-culture in the same medium it will obtain a sufficient start to bring about the typical change. To finally obtain the bacillus in purity, and at the same time to have a positive means of identification, Professor Welch has devised a very ingenious method: From $\frac{1}{2}$ –1 c.c. of such a milk culture, or the same quantity of a suspension made from a solid medium, is injected into the ear vein of a rabbit, and to insure a thorough distribution of the organisms three minutes are allowed to pass before the next step is taken, which is the killing of the animal by a sharp blow on the back of the head. The body is now placed in the thermostat for seven or eight hours, or left at room temperature for eighteen or twenty-four hours, and at the end of either of those periods the animal will usually be found to be greatly bloated, due to accumulation of gas in the subcutaneous tissue and in the body cavities. As the gas is highly inflammable a lighted match brought to a puncture in the abdominal wall, or elsewhere, will produce a bright blue flame when in contact with the escaping gas. The organs of the animal will be found to be full of gas and more or less broken down. The organism is then found in enormous numbers everywhere and readily identified by its capsule, absence of motility, staining by Gram, and later, if some serum from the animal is sealed up in a small tube and placed in the thermostat it will be found that many of the bacilli have formed spores. This latter fact was pointed out by E. Klein in his studies on his *B. enteritidis sporogenes* (*B. aerogenes capsulatus*).

CHAPTER XVIII.

CHOLERA.

Introductory. — It is no exaggeration of the facts to say that previously to 1883 practically nothing of value was known regarding the nature of the virus of cholera. In that year Koch was sent to Egypt, where the disease had broken out, in charge of a commission for the purpose of investigating its nature. In the course of his researches he discovered the organism now generally known as the *comma bacillus* or the *cholera spirillum*. Further observations carried out in nearly a hundred cases, chiefly in India, convinced him of the constant presence of this organism in cholera and of its causal relationship to the disease. He also obtained pure cultures of the organism from a large number of cases of cholera, and described their characters. The results of his researches were given at the first Cholera Conference at Berlin in 1884. The general conclusions at which Koch arrived received, in the main, confirmation from the investigations of others, though some criticism arose, especially as regards the uniformity of the characters of the cholera spirillum.

Since Koch's discovery, and especially during the epidemic in Europe in 1892-93, spirilla have been cultivated from cases of cholera in a great many different localities, and though this extensive investigation has revealed the invariable presence in true cholera of organisms resembling more or less closely Koch's spirillum, certain difficulties have arisen. For it has been found that the cultures obtained from different places have shown considerable variations in their characters, and, further, spirilla which closely resemble Koch's cholera^s spirillum have been cultivated from sources other than cases of true cholera. There has therefore been much controversy, on the one hand, as to the signification of these variations — whether they constitute different species, or whether they are to be regarded as indicating

distinct species or merely varieties of the same species—and on the other hand, as to the means of distinguishing the cholera spirillum from other species which resemble it. These questions will be discussed below.

In considering the bacteriology of cholera, it is to be borne in mind that in this disease, in addition to the evidence of great intestinal irritation, accompanied by profuse watery discharge, and often by vomiting, there are also symptoms of general systemic disturbance which cannot be accounted for merely by the withdrawal of water and certain substances from the system. Such symptoms include the profound general prostration, cramps in the muscles, extreme cardiac depression, the cold and clammy condition of the surface, the subnormal temperature, suppression of urine, etc. These taken in their entirety are indications of a general poisoning in which the circulatory and thermo-regulatory mechanisms are specially involved. In some, though rare, cases known as *cholera sicca*, general collapse occurs with remarkable suddenness, and is rapidly followed by a fatal result, whilst there is little or no evacuation from the bowel, though *post mortem* the intestine is distended with fluid contents. As the characteristic organisms in cholera are found only in the intestine, the general disturbances are to be regarded as the result of toxic substances absorbed from the bowel. It is also to be noted that cholera is a disease of which the onset and course are much more rapid than is the case in most infective diseases, such as typhoid and diphtheria; and that recovery also, when it takes place, does so more quickly. The two factors to be correlated to these facts are (*a*) a rapid multiplication of organisms, (*b*) the production of rapidly acting toxins.

The Cholera Spirillum.—*Microscopical Characters.*—The cholera spirilla as found in the intestines in cholera are small organisms measuring about 1.5 to 2 μ in length, and rather less than .5 in thickness. They are distinctly curved in one direction, hence the appearance of a comma (Fig. 138); most occur singly, but some are attached in pairs and curved in opposite directions, so that an S-shape results. Longer forms are rarely seen in the intestine, but in cultures in fluids, as is especially well seen in hanging-drop preparations, they may grow into longer spiral filaments, showing a large number of turns. If film preparations be made from the intestinal contents in typical

cases, it will be found that these organisms are present in enormous numbers in almost pure culture, and that most of the spirilla lie with their long axes in the same direction, so as to give the appearance which Koch compared to a school of fish in a stream.

They possess very active motility, which is most marked in the single forms. When stained by the suitable methods they are seen to be flagellated. Usually a single terminal flagellum is present at one end only (Fig. 139). It is very delicate, and measures four or five times the length of the organism. In

some varieties, however, there may be a flagellum at both ends, or more than one may be present; cultures obtained at different places have shown considerable variations in this respect.



FIG. 138.—Cholera spirilla, from a culture of agar of twenty-four hours' growth. Stained with weak carbol-fuchsin. $\times 1000$.

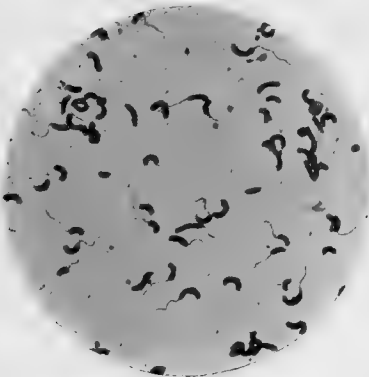

FIG. 139.—Cholera spirilla stained to show the terminal flagella. $\times 1000$.

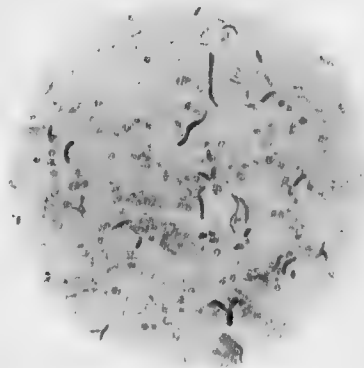

FIG. 140.—Cholera spirilla from an old agar culture, showing irregularities in size and shape, with numerous faintly stained coccoid bodies—involution forms. Stained with fuchsin. $\times 1000$.

Cholera spirilla do not form spores. In old cultures, however, small, rounded, and highly refractile bodies may be found in the organisms, which have been regarded by Hueppe as "arthrospores," but which are in reality merely the result of degenera-

tion, as they have no higher powers of resistance than the spirilla themselves, and cultures containing enormous numbers of such bodies may be found to be quite dead. Along with such appearances in old cultures there is found great change in the size and shape of the organisms (Fig. 140). Some are irregularly twisted filaments, sometimes globose, sometimes clubbed at their extremities, and also showing irregular swellings along their course. Others are short and thick, and may have the appearance of large cocci, often staining faintly. All these changes in appearance are to be classed together as *involution forms*.

Staining. — Cholera spirilla stain readily with the usual basic aniline stains, though Löffler's methylene-blue or weak carbol-fuchsin is specially suitable. They lose the stain in Gram's method.

Distribution within the Body. — The chief fact in this connection is that the spirilla are confined to the intestine, and are not present in the blood or internal organs. This was determined by Koch in his earlier work, and his statement has been amply confirmed. In cases in which there is the characteristic "rice-water" fluid in the intestines, they occur in enormous numbers — almost in pure culture. The lower half of the small intestine is the part most affected. Its surface epithelium becomes shed in great part, and the flakes floating in the fluid consist chiefly of masses of epithelial cells and mucus, amongst which are numerous spirilla. The spirilla also penetrate the follicles of Lieberkühn, and may be seen lying between the basement membrane and the epithelial lining, which becomes loosened by their action. They are, however, rarely found in the connective tissue beneath, and never penetrate deeply. Along with these changes there is congestion of the mucosa, especially around the Peyer's patches and solitary glands, which are somewhat swollen and prominent. In some very acute cases the mucosa may show general acute congestion, with a rosy pink colour, but very little desquamation of epithelium, the intestinal contents being a comparatively clear fluid containing the spirilla in large numbers. In other cases of a more chronic type, the intestine may show more extensive necrosis of the mucosa and a considerable amount of hæmorrhage into its substance, along with formation of false membrane at places. The intestinal contents in such cases are

blood-stained and foul-smelling, there being a great proportion of other organisms present besides the cholera spirilla (Koch).

Cultivation. — (For Methods, see p. 426.)

The cholera spirillum grows readily on all the ordinary media, and with the exception of that on potato, growth takes place at the ordinary room temperature. The most suitable temperature, however, is that of the body, and growth usually stops about 16° C., though in some cases it has been obtained at a lower temperature.

Peptone Gelatin. — On this medium the organism grows well and produces liquefaction. In puncture cultivations at 22° C. a whitish line appears along the needle track, at the upper part of which liquefaction commences, and as evaporation quickly occurs, a small bell-shaped depression forms, which gives the appearance of an air-bubble. On the fourth or fifth day we get the following appearance: There is at the surface the bubble-shaped depression; below this there is a funnel-shaped area of liquefaction, the fluid being only slightly turbid, but showing at its lower end thick masses of growth of a more or less spiral shape (Fig. 141). The liquefied portion gradually tapers off downwards towards the needle track. (This appearance is, however, in some varieties not produced till much later, especially when the gelatin is very stiff, and, in other varieties which liquefy very slowly, may not be met with at all.) At a later stage, liquefaction spreads and may reach the side of the tube.



FIG. 141.—Puncture culture of the cholera spirillum in peptone gelatin—six days' growth. Natural size.

In *gelatin plates* the colonies are somewhat characteristic. They appear as minute whitish points, visible in twenty-four to forty-eight hours, which, under a low power of the microscope, do not present a smooth circular outline, but one which is irregularly granular or furrowed; as they become larger their surface has an appearance which has been compared to fragments of broken glass. Later, liquefaction occurs, and the colony sinks into the small cup formed, the plate then showing small sharply marked rings around the colonies (Fig. 142).

Under the microscope the outer margin of the cup is circular and sharply marked. Within the cup the liquefied portion forms a ring which has a more or less granular appearance, whilst the

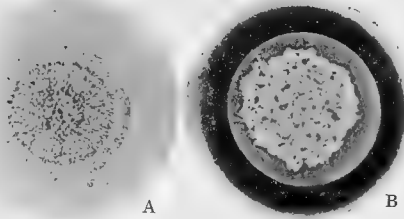

FIG. 142.—Colonies of the cholera spirillum in a gelatin plate; three days' growth. A shows the granular surface, liquefaction just commencing; in B, liquefaction is well marked.

mass of growth in the centre is irregular and often broken up at its margins. The growth of the colonies in gelatin plates constitutes one of the most important means of distinguishing the cholera spirillum from other organisms.

On the surface of the *agar* media a thin semi-transparent layer forms, which presents no special characters. On solidified *blood serum* the growth has at first the same appearance, but afterwards liquefaction of the medium occurs. On agar plates the superficial colonies under a low power are circular discs of brownish-yellow colour, and more transparent than those of most other organisms. On *potato* at the ordinary temperature, growth does not take place, but when it is incubated at a temperature of from 30° to 37° C., a moist layer appears, which assumes a dirty brown colour somewhat like that of the glanders bacillus; the appearance, however, varies somewhat in different varieties, and also on different sorts of potatoes.

In *bouillon* with alkaline reaction the organism grows very readily, there occurring in twelve hours at 37° C. a general turbidity, while the surface shows a thin pellicle composed of spirilla in a very actively motile condition. Growth takes place under the same conditions equally rapidly in peptone solution (1 per cent with .5 per cent sodium chloride added).

In *milk* also the organism grows well and produces no coagulation nor any change in its appearance, at least for several days.

On all the media the growth of the cholera spirillum is a relatively rapid one, and especially is this the case in the peptone solution named and in bouillon, a circumstance of importance in relation to its separation in cases of cholera (*vide* p. 426).

Cholera-red Reaction.—This is one of the most important tests in the diagnosis of the cholera organism. It is always

given by a true cholera spirillum, and though the reaction is not peculiar to it, the number of organisms which give the reaction under the conditions mentioned are comparatively few. The test is made by adding one or two drops of pure sulphuric acid to a culture in peptone bouillon or in peptone solution (1 per cent) which has been incubated for twenty-four hours at 37° C.; in the case of the cholera spirillum a reddish-pink colour is produced. This is due to the fact that both indol and a nitrite are formed by the spirillum in the medium. The addition of sulphuric acid causes a nitroso-indol body to be produced from these, and this gives the red colour. Here, as in testing for the production of indol by other bacteria, it is found that not every specimen of peptone is suitable, and it is advisable to select a peptone which gives the characteristic reaction with a known cholera organism, and to use it for further tests. It is also essential that the sulphuric acid should be pure, for if traces of nitrites are present the reaction might be given by an organism which had not the power of forming nitrites.

The cholera organism is one which grows much more rapidly in the presence of oxygen than in anaerobic conditions. Koch, in his earlier work, believed that no growth took place in the absence of oxygen, and it has been recently stated that this is the case in *absolutely* anaerobic conditions. Growth, however, takes place in the ordinary anaerobic conditions, usually employed in the culture of anaerobic organisms, such as those of tetanus and malignant œdema, though it occurs more slowly than in the presence of oxygen. In the intestines the oxygen supply, though small in amount, is yet sufficient for the growth of the spirilla.

Powers of Resistance. — In their resistance against moist heat cholera spirilla correspond with most spore-free organisms, and are killed in five minutes by a temperature of 65° C., and much more rapidly at higher temperatures. They have comparatively high powers of resistance against great cold, and have been found alive after being exposed for several hours to the temperature of -10° C. They are, however, killed by being kept in ice for a few days. Against the ordinary antiseptics they have comparatively low powers of resistance, and Pfuhl found that the addition of lime, in the proportion of 1 per cent, to water containing the cholera organisms, was sufficient to kill them in the course of an hour.

As regards the powers of resistance in ordinary conditions, the following facts may be stated. In cholera stools kept at the ordinary room temperature, the cholera organisms are rapidly outgrown by putrefactive bacteria, but in some cases they have been found alive even after two or three months. In most experiments, however, attempts to cultivate them even after a much shorter time have failed. The general conclusion may be drawn from the work of various observers that the spirilla do not multiply freely in ordinary sewage water, although they may remain alive for a considerable period of time. In distilled water they remain alive for several weeks at least, but do not multiply, nor does any considerable growth take place without the presence of a pretty large proportion of organic matter. On moist linen, as Koch showed, they can flourish very rapidly. When the cholera organisms are grown along with other organisms in fluids at a warm temperature, it is found that at first they may multiply more rapidly than the others, but that after a certain time they are outgrown by some of the organisms present, gradually diminish in number, and ultimately disappear. It must not, however, be inferred from such experiments that a similar result will necessarily follow in nature, as any particular saprophytic organism requires a special habitat — that is, certain suitable conditions for its growth in competition with other organisms. Though we can state generally that the conditions favourable for the growth of the cholera spirillum are, a warm temperature, moisture, a good supply of oxygen, and a considerable proportion of organic material, we do not know the exact circumstances under which it can flourish for an indefinite period of time as a saprophyte. The fact that the area in which cholera is an endemic disease is so restricted tends to show that the conditions for a prolonged growth of the spirillum outside the body are not usually supplied. Yet, on the other hand, there is no doubt that in ordinary conditions it can live a sufficient time outside the body and multiply to a sufficient extent, to explain all the facts known with regard to the persistence and spread of cholera epidemics.

Numerous experiments show that the cholera organisms are, as a rule, rapidly killed by drying, usually in two or three minutes when the drying has been thorough, and it is inferred from this that they cannot be carried in the living condition for any great

distance through the air, a conclusion which is well supported by observations on the spread of the disease. Cholera is practically always transmitted by means of water or food contaminated by the organism, and there is no doubt that contamination of the water supply by choleraic discharges is the chief means by which areas of population are rapidly infected. It has been shown that if flies are fed on material containing cholera organisms, the organisms may be found alive within their bodies twenty-four hours afterwards. And further, Haffkine found that sterilised milk might become contaminated with cholera organisms, if kept in open jars to which flies had free access, in a locality infected by cholera. It is quite possible that infection may be carried by this agency in some cases.

Experimental Inoculation.—In considering the effects of inoculation with the cholera organism, we are met with the difficulty that none of the lower animals, so far as is known, suffer from the disease under natural conditions. Even in places where cholera is endemic, no corresponding affection has been observed in any animals. And further, before the discovery of the cholera organism, various efforts had been made to induce the disease in animals by feeding them with cholera dejecta, but without success. It is therefore not surprising that the earlier experiments on animals by feeding them with pure cultures were attended with negative results. As the organisms are confined to the alimentary tract in the natural disease, attempts to induce their multiplication within the intestine of animals by artificially arranging favouring conditions, have occupied a prominent place in the experimental work. We shall give a short account of such experiments.

Nikati and Rietsch were the first to inject the organisms directly into the duodenum of dogs and rabbits, and they succeeded in producing, in a considerable proportion of the animals, a choleraic condition of the intestine; in their earlier experiments the common bile duct was ligatured, but the later were performed without this operation. These experiments were confirmed by other observers, including Koch. Thinking that probably the spirillum, when introduced by the mouth, is destroyed by the action of the hydrochloric acid of the gastric secretion, Koch first neutralised this acidity by administering to guinea-pigs 5 c.c. of a 5 per cent solution of carbonate of soda, and some time afterwards introduced a pure culture into the stomach by means of a tube. Of nineteen animals treated in this way, only one died with choleraic

changes in the small intestine. This animal had aborted a short time previously, and as its abdominal walls were very relaxed, Koch considered that the intestinal peristalsis had been interfered with, and thus opportunity had been afforded to the organisms of gaining a foothold and multiplying in the intestine. He accordingly tried the effect of artificially interfering with the intestinal peristalsis by injecting tincture of opium into the peritoneum (1 c.c. per 200 grm. weight), in addition to neutralising as before with the carbonate of sodium solution. The result was remarkable, as thirty out of thirty-five animals treated died with the same changes as in the single animal in the previous series of experiments. The animals infected by this method show signs of general prostration, their posterior extremities being especially weakened; the abdomen becomes tumid, respiration slow, heart's action weak, and the surface cold. Death occurs after a few hours. *Post mortem* the small intestine is distended, its mucous membrane congested, and it contains a colourless fluid with small flocculi and the cholera organisms in practically pure cultures. These experiments, which have been repeatedly confirmed, therefore demonstrated that the cholera organisms could, under certain conditions, set up in animals a condition in some respects resembling cholera. Koch, however, found that when the spirilla of Finkler and Prior, of Deneke, and of Miller (*vide infra*) were employed by the same method, a certain, though much smaller, proportion of the animals died from an intestinal infection. Though the changes in these cases were not so characteristic, they were sufficient to prevent the results obtained with the cholera organism from being used as a demonstration of the specific relation of the latter to the disease.

Within later years some additional facts of high interest have been established with regard to choleraic infection of animals. For example, Sabolotny found that in the marmot an intestinal infection readily takes place by simple feeding with the organism, there resulting the usual intestinal changes, sometimes with hæmorrhagic peritonitis, the organisms, however, being present also in the blood. It was found by Issaëff and Kolle that young rabbits could be infected by merely neutralising the gastric secretion with sodium carbonate, the use of opium being unnecessary; but of special interest is the fact, discovered by Metchnikoff, that in the case of young rabbits shortly after birth a large proportion die of choleraic infection when the organisms are simply introduced along with the milk, as may be done by infecting the teats of the mother. Further, from these animals thus infected the disease may be transmitted to others by a natural mode of infection. In this affection of young rabbits many of the symptoms of cholera are present — great prostration, markedly subnormal temperature, sometimes anuria, and occasionally slight cramps before death. Most frequently there is diarrhœa, though sometimes this may be absent, the group of phenomena sometimes corresponding, according to Metchnikoff, with *cholera sicca*. The organisms occur in large numbers in the intestine, and in some cases a few may be found in the blood, and especially in the gall-bladder. Many of these experiments were performed with the vibrio of Massowah, which is now admitted not to be a true cholera organism, others with a cholera vibrio obtained from the water of the Seine.

It will be seen from the above account that the evidence obtained from experiments on intestinal infection of animals, though by no means sufficient to establish the specific relationship of the cholera organism, is on the whole favourable to this view, especially when it is borne in mind that animals do not in natural conditions suffer from the disease.

Experiments performed by direct inoculation also supply interesting facts. *Intraperitoneal* injection in guinea-pigs is followed by general symptoms of illness, the most prominent being distention of the abdomen, subnormal temperature, and, ultimately, profound collapse. There is peritoneal effusion, which may be comparatively clear, or may be somewhat turbid and contain flakes of lymph, according to the stage at which death takes place. If the dose is large, organisms are found in considerable numbers in the blood and also in the small intestine, but with smaller doses they are practically confined to the peritoneum. Kolle found that when the minimum lethal dose was used in guinea-pigs, the peritoneum might be free from organisms at the time of death, the fatal result having taken place from an intoxication (cf. diphtheria, p. 365). These and other experiments show that though the organisms undergo a certain amount of multiplication when introduced by the channels mentioned, still the tendency to invade the tissues is not a marked one. On the other hand, the symptoms of general intoxication are always pronounced. Hence arise questions as to the nature and mode of action of toxic bodies produced by the cholera organism.

Toxins. — Though there is no doubt that there are formed by Koch's spirillum toxic bodies which produce many of the symptoms of cholera, there is at present very little satisfactory knowledge regarding their chemical nature. The following summary may be given.

It has been shown, especially by R. Pfeiffer,¹ that toxic phenomena can be produced by injection of the *dead spirilla* into animals. A certain quantity of a young culture on agar, killed by exposure to the vapour of chloroform, when injected intraperitoneally into a guinea-pig, may cause death in from

¹ Pfeiffer obtained his *earlier* results with a vibrio from Massowah, which is now known (as mentioned above) not to be a true cholera organism. The fact shows that the effects described are not specific to the latter.

eight to twelve hours. There is extreme collapse, sometimes clonic spasms occur, and the temperature may fall below 30° C. before death. Pfeiffer considers that the toxic substances are contained in the bodies of the organisms, that is, they are intracellular, and that they are only set free by the disintegration of the latter. This opinion is grounded chiefly on the fact that when bouillon cultures were filtered, he found that the filtrate possessed very feeble toxic properties. The dead cultures administered by the mouth produce no effect unless the intestinal epithelium is injured, in which case poisoning may result. He considers that the desquamation of the epithelium is an essential factor in the production of the phenomena of the disease in the human subject. Pfeiffer found that the toxic bodies were to a great extent destroyed at 60° C., but even after heating at 100° C. a small proportion of toxin remained, which had the same physiological action.

On the other hand, other observers (Petri, Ransom, Klein, and others) have obtained toxic bodies from *filtered cultures*. Metchnikoff, E. Roux, and Taurelli-Salimbeni have demonstrated the formation of such diffusible toxic bodies in fluid media in the following manner. Small collodion sacs were prepared, each containing 2 to 4 c.c. of bouillon. One sac was inoculated with a living virulent culture of the cholera vibrio; to the second, two entire cultures on agar of the same organism were added, the cultures being first killed by chloroform. Each sac was then closed and placed with aseptic precautions in the peritoneum of a guinea-pig. The animal which received the sac containing the living vibrios soon showed symptoms of choleraic poisoning, and died in a few days, whilst the animal which received the sac containing large quantities of dead organisms showed only transitory symptoms of illness. These observers therefore concluded that toxic substances are formed by the living organisms, which quickly diffuse into the medium (and in the experiments, through the wall of the sac). By greatly increasing the virulence of the organism, then growing it in bouillon and filtering the cultures on the third and fourth day, they obtained a fluid which was highly toxic to guinea-pigs (the fatal dose usually being $\frac{1}{5}$ c.c. per 100 gm. weight). If the dose of the toxin is very large, death follows in an hour or even less. The symptoms closely resemble those obtained by Pfeiffer,

the rapid fall of temperature being a striking feature. They found that the toxicity of the filtrate was not altered by boiling. It is somewhat difficult to reconcile the results of Pfeiffer and Metchnikoff as regards the action of heat, and there is evidence that the toxic substances present in the bodies of the spirilla differ from those present in filtered cultures. A considerable number of observers, however, agree in stating that, at least some toxins obtained from cholera cultures are not destroyed at 100° C.

A great many observers have attempted to obtain toxins in a chemically pure condition, but so far without results which can be regarded as conclusive. Hueppe and Wood found that the most active toxins were produced by growing the cholera organism in albumin in anaerobic conditions, and considered that this corresponded to the mode of their production in cholera. Scholl confirmed Hueppe's results, and obtained from cultures under such conditions a peptone which possessed highly toxic properties, and which he called cholera toxo-peptone. These results, however, have been adversely criticised by various observers. Wesbrook obtained different substances according to the media on which the cholera organisms were grown, and yet these produced very much the same effects, chiefly collapse, subnormal temperature, cramps, dyspnoea, etc. Such toxic bodies were even obtained from cultures in asparaginate of soda solution, which did not contain any proteid substance. He therefore came to the conclusion that the so-called toxalbumins, etc., are really mixtures of albumins and true toxins, the chemical nature of the latter not having been yet determined. Wesbrook also obtained the toxic bodies in small quantity from the pleural exudate of guinea-pigs killed by the vibrio. Bosc also found that the blood, and to a less extent the urine, of patients who had died in the algid stage, produce toxic phenomena and death, when injected intravenously in rabbits. In this case also, nothing is known with regard to the chemical nature of the toxic bodies.

Experiments on the Human Subject. — Experiments have also been performed in the case of the human subject, both intentionally and accidentally. In the course of Koch's earlier work, one of the workers in his laboratory shortly after leaving was seized with severe choleraic symptoms. The stools were found to contain cholera spirilla in enormous numbers. Recovery, however, took place. In this case there was no other possible source of infection than the cultures with which the man had been working, as no cholera was present in Germany at the time. Within recent years a considerable number of experiments have been performed on the human subject, which certainly show that in some cases more or less severe choleraic symptoms may follow

ingestion of pure cultures, whilst in others no effects may result. The former was the case, for example, with Emmerich and Pettenkofer, who made experiments on themselves, the former especially becoming seriously ill. In the case of both, diarrhoea was well marked, and numerous cholera spirilla were present in the stools, though toxic symptoms were proportionately little pronounced. Metchnikoff also, by experiments on himself and others, obtained results which convinced him of the specific relation of the cholera spirillum to the disease. Lastly, we may mention the case of Dr. Orgel in Hamburg, who contracted the disease in the course of experiments with the cholera and other spirilla, and died in spite of treatment. It is believed that in sucking up some peritoneal fluid containing cholera spirilla, a little entered his mouth and thus infection was produced. This took place in September 1894 at a time when there was no cholera in Germany. On the other hand, in many cases the experimental ingestion of cholera spirilla by the human subject has given negative results. Still, as the result of observation of what takes place in a cholera epidemic, it is the general opinion of authorities that only a certain proportion of people are susceptible to cholera, and the facts mentioned above have, in our opinion, great weight in establishing the relation of the organism to the disease.

Immunity. — As this subject is discussed later, only a few facts will be here stated, chiefly for the purpose of making clear what follows with regard to the means of distinguishing the cholera spirillum from other organisms. The guinea-pig or any other animal may be easily immunised against the cholera organism by repeated injections (conveniently made into the peritoneum) of non-fatal doses of the spirilla. It is better to commence the process with non-fatal doses of cultures killed by the vapour of chloroform or by heat, the doses being gradually increased, and afterwards to proceed with increasing doses of the living organism. In this way a high degree of immunity against the organism is developed, and further, the blood serum of an animal thus immunised (anti-cholera serum) has markedly protective power when injected, even in a small quantity, into a guinea-pig along with five or ten times the fatal dose of the living organism; it has also the property of agglutinating the cholera organism. These properties,

being within certain limits specific, constitute an additional aid in the diagnosis of an organism supposed to be the cholera spirillum.

A curious fact, however, is, that immunity produced by the above method is only exerted against the living organisms, and does not protect against the toxins — that is, it is due to certain substances which act as germicides (indirectly), but which are not antitoxic. Further, it does not protect the guinea-pig from the intestinal infection by Koch's method (Pfeiffer and Wassermann, Sobernheim, Klein), nor does the anti-cholera serum protect young rabbits against the choleraic affection produced by ingestion of the cholera vibrios (Metchnikoff). The inference from these latter results appears to be, that when the vibrios are introduced into the tissues, they are killed by certain substances in the serum, but in the intestine they are in a sense outside of the tissues, and can there multiply and produce toxins. Metchnikoff has prepared a true antitoxic cholera serum by injections of repeated and gradually increased doses of the toxin, and has found that this antitoxic serum has a distinct effect against the choleraic affection of rabbits.

Anti-cholera Inoculation. — Haffkine's method for inoculation against cholera exemplifies the above principles. It depends upon (a) attenuation of the virus — that is, the cholera organism, and (b) exaltation of the virus. The virulence of the organism is diminished by passing a current of sterile air over the surface of the cultures, or by various other methods. The virulence is exalted by the method of *passage* — that is, by growing the organism in the peritoneum in a series of guinea-pigs. By the latter method the virulence after a time is increased twenty-fold — that is, the fatal dose has been reduced to a twentieth of the original. Cultures treated in this way constitute the *virus exalté*. Subcutaneous injection of the *virus exalté* produces a local necrosis, and may be followed by the death of the animal, but if the animal be treated first with the attenuated virus, the subsequent injection of the *virus exalté* produces only a local œdema. After inoculation first by attenuated and afterwards by exalted virus, the guinea-pig has acquired a high degree of immunity, and Haffkine believed that this immunity was effective in the case of every method of inoculation, that is, by the mouth as well as by injection into the tissues. After trying his method on the human subject and finding it free from risk, he extended it in practice on a large scale in India in 1894, and these experiments are still going on. So far the results are, on the whole, distinctly encouraging. In the human subject two or sometimes three in-

oculations are made with attenuated virus before the *virus exalté* is used. Wassermann and Pfeiffer, and also Klein, have found, however, that guinea-pigs immunised by Haffkine's method are not immunised against intestinal infection when the animal is treated by Koch's method (that is, by paralysing the intestines with opium, *vide* p. 416). Notwithstanding this fact Haffkine's method may still have a beneficial effect, though it may not be preventive in all cases.

Means of distinguishing the Cholera Organism. — According to Koch the most important points in the diagnosis of cholera are:—

(*a*) Microscopical characters of the dejecta. (*b*) Appearance of the colonies in gelatin plates. (*c*) Their appearance on agar plates. (*d*) The growth in peptone solution. (*e*) The cholera-red reaction. (*f*) The effect of intraperitoneal inoculation of guinea-pigs with pure cultures.

There can be no doubt that in the great majority of cases these points taken collectively are sufficient in identifying the cholera organism. In addition, however, the various properties of an anti-cholera serum may be employed; of these the most easily applied is the agglutinative reaction. The following is an account of Pfeiffer's reaction, which was the first to be introduced.

Pfeiffer's Reaction. — A loopful (2 mgrm.) of recent agar culture of the organism to be tested is added to 1 c.c. of ordinary bouillon containing .001 c.c. of anti-cholera serum. The mixture is then injected into the peritoneal cavity of a young guinea-pig (about 200 grm. in weight), and the peritoneal fluid of this animal (conveniently obtained by means of capillary glass tubes inserted into the peritoneum) is examined microscopically after a few minutes. If the spirilla injected have been cholera spirilla, it will be found that they become motionless, swell up into globules, and ultimately break down and disappear — *positive result*. If they are found active and motile, then the possibility of their being true cholera spirilla may be excluded — *negative result*. In the former case (positive result) there is, however, still the possibility that the organism is devoid of pathogenic properties and has been destroyed by the normal peritoneal fluid. A control experiment should accordingly be made with .001 c.c. of normal serum in place of the anti-cholera serum. If no alteration of the organism occurs with its use, then it is to be concluded that the organism in question has been demonstrated by the specific reaction to be the cholera spirillum (see Chapter XX.).

Properties of the Serum of Cholera Patients and Convalescents. — Lazarus was the first to show that the serum of

patients who had suffered from cholera possessed the power of protecting guinea-pigs, when injected in very minute quantity along with a fatal dose of the cholera organism. These experiments were confirmed by Klemperer, Issaëff, and Pfeiffer, and the last mentioned found that the serum of such patients gave the characteristic reaction if injected with the spirilla into the peritoneal cavity of a guinea-pig. Further, so far as experiment has gone, this action is not exerted against any other organism—that is, it is specific towards the cholera spirillum. This action of the serum may be present eight or ten days after the attack of the disease, but is most marked four weeks after; it then gradually becomes weaker and disappears in two or three months (Pfeiffer and Issaëff).

Specific *agglutinative* properties have, however, been detected in the serum of cholera patients at a much earlier date, in some cases even on the first day of the disease, though usually a day or two later. The dilutions used were 1-15 to 1-120, and these had no appreciable effect on organisms other than the cholera spirillum (Achard and Bensande). Needless to say, such facts supply strong additional evidence of the relation of Koch's spirillum to cholera.

General Summary.—We may briefly summarise as follows the facts in favour of Koch's spirillum being the cause of cholera. *First*, there is the constant presence of spirilla in true cases of cholera, which on the whole conform closely with Koch's description, though variations undoubtedly occur. Moreover, the facts known with regard to their conditions of growth, etc., are in conformity with the origin and spread of cholera epidemics. *Secondly*, the experiments on animals with Koch's spirillum or its toxins give as definite results as one can reasonably look for in view of the fact that animals do not suffer naturally from the disease. *Thirdly*, the experiments on the human subject and the results of accidental infection by means of pure cultures are also strongly in favour of this view. *Fourthly*, the agglutinative and protective properties of the serum of cholera patients and convalescents constitute another point in its favour. *Fifthly*, bacteriological methods, which proceed on the assumption that Koch's spirillum is the cause of the disease, have been of the greatest value in the diagnosis of the disease. And *lastly*, the results of Haffkine's method of preventive inoculation in the

human subject, which are on the whole favourable, also supply additional evidence. If all these facts are taken together, we consider the conclusion must be arrived at that the growth of Koch's spirillum in the intestine is the immediate cause of the disease. This does not exclude the probability of an important part being played by conditions of weather and locality, though such are very imperfectly understood. Pettenkofer, for example, recognised two main factors in the causation of epidemics, which he designated x and y , and considered that these two must be present together in order that cholera may spread. The x is the direct cause of the disease—an organism which he admitted to be Koch's spirillum; the y includes climatic and local conditions, *e.g.*, state of ground-water, etc.

Difficulty does not arise, however, so much with regard to the causal relationship of Koch's spirillum to cholera as in connection with various organisms which have been cultivated from other sources, and which more or less closely resemble it.

Other Spirilla resembling the Cholera Organism.—These have been chiefly obtained either from water contaminated by sewage or from the intestinal discharge in cases with choleraic symptoms. Some of them differ so widely in their cultural and other characters (some, for example, are phosphorescent) that no one would hesitate to classify them as distinct species. Others, however, closely resemble the cholera organism.

The *vibrio berolinensis*, cultivated by Neisser from Berlin sewage water, differs from the cholera organism only in the appearance of its colonies in gelatin plates, its weak pathogenic action, and its giving a negative result with Pfeiffer's test. It, however, gives the cholera-red reaction. The *vibrio Danubicus*, cultivated by Heider from canal water, also differs in the appearance of its colonies in plates, and also reacts negatively to Pfeiffer's test; in most respects it closely resembles the cholera organism. Another spirillum (*v. Ivanoff*) was cultivated by Ivanoff from the stools of a typhoid patient after these had been diluted with water. This organism differed somewhat in the appearance of its colonies and in its great tendency to grow out in the form of long threads, but Pfeiffer found that it reacted to his test in the same way as the cholera organism, and he considered that it was really a variety of the cholera organism. No spirilla could be found microscopically in the stools in this case, and Pfeiffer is of the opinion that the organism gained entrance accidentally. These examples will show how differences of opinion, even amongst experts, might arise as to whether a certain spirillum were really the cholera organism or a distinct species resembling it.

A few examples may also be given of organisms cultivated from cases in which cholera-like symptoms were present.

The *vibrio of Massowah* was cultivated by Pasquale from a case during a small epidemic of cholera. This organism so closely resembles Koch's spirillum that it was accepted by several authorities as the true cholera organism, and, as already stated, Metchnikoff produced by it cholera symptoms in the human subject, and also the cholera-like disease in young rabbits. It possesses four flagella, has a high degree of virulence, producing septicæmia both in guinea-pigs and pigeons, and its colonies in plates differ somewhat from the cholera organism. Moreover, it reacts negatively to Pfeiffer's test. Another organism, the *v. Gindhā*, was cultivated by Pasquale from a well, and was at first accepted by Pfeiffer as the cholera organism, but afterwards rejected, chiefly because it failed to give the specific immunity reaction. It also differs somewhat from the cholera organism in its pathogenic effects, and it fails to give the cholera-red reaction or gives it very faintly.

Pestana and Bettencourt also cultivated a species of spirillum from a number of cases during an epidemic in Lisbon—an epidemic in which there were symptoms of gastro-enteritis, although only in a few instances did the disease resemble cholera. They also cultivated the same organism from the drinking water. It differs from the cholera organism in the appearance of its colonies and of puncture cultures in gelatin. It has very feeble pathogenic effects, and gives a very faint, or no, cholera-red reaction. To Pfeiffer's test it also reacts negatively. Another spirillum (*v. Romanus*) was obtained by Celli and Santori from twelve out of forty-four cases where there were the symptoms of mild cholera. This organism does not give the cholera-red reaction, nor is it pathogenic for animals. They look upon it as a "transitory variety" of the cholera organism, though sufficient evidence for this view is not adduced.

We have mentioned these examples in order to show some of the difficulties which exist in connection with this subject. It is important to note that, on the one hand, spirilla which have been judged to be of different species from the cholera organism have been cultivated from cases in which cholera-like symptoms were present, and, on the other hand, in cases of apparently true cholera considerable variations in the characters of the cholera organisms have been found. Such variations have especially been recorded by Surgeon-major Cunningham in India. It is therefore quite an open question whether some of the organisms in the former case may not be cholera spirilla which have undergone variations as a result of the conditions of their growth. That such variations may occur we have a considerable amount of evidence. The great bulk of evidence, however, goes to show that Asiatic cholera always spreads as an epidemic from places in India where the disease is endemic,

and that its direct cause is Koch's spirillum. It is sufficient to bear in mind that choleraic symptoms may be produced by other causes, and that in some of such cases spirilla which have some resemblance to Koch's organism may be present in the intestinal discharges, though rarely in large numbers.

Methods of Diagnosis. — In the first place, the stools ought to be examined microscopically. Dried film preparations should be made and stained by any ordinary stains, though carbol-fuchsin diluted four times with water is specially to be recommended. Hanging-drop preparations, with or without the addition of a weak, watery solution of gentian-violet or other stain, should also be made, by which method the motility of the organism can be readily seen. By microscopic examination the presence of spirilla will be ascertained, and an idea as to their number obtained. In some cases the cholera spirilla are so numerous in the stools that a picture is presented which is obtained in no other condition, and a microscopic examination may be sufficient for practical purposes. According to Koch, a diagnosis was made in 50 per cent of the cases during the Hamburg epidemic by microscopic examination alone. In the case of the first appearance of a cholera-like disease, however, all the other tests should be applied before a definite diagnosis of cholera is made.

If the organisms are very numerous, gelatin or agar plates may be made at once and pure cultures obtained.

Schottelius' Enriching Method. — If the spirilla occur in comparatively small numbers, the best method is to inoculate peptone solution (1 per cent) and incubate for eight to twelve hours. At the end of that time the spirilla will be found on microscopic examination in enormous numbers at the surface, and thereafter plate cultures can readily be made. If the spirilla are very few in number, or if a suspected water is to be examined for cholera organisms, the peptone solution which has been inoculated should be examined at short intervals till the spirilla are found microscopically. A second flask of peptone solution should then be inoculated, and possibly again a third from the second. By this method, properly carried out, a culture may be obtained which, though impure, contains a large proportion of the spirilla, and then plate cultures may be made.

When a spirillum has been obtained in pure condition by these methods, the appearance of the colonies in plates should

be specially noted, the test for the cholera-red reaction should be applied, and in many cases it is advisable to test the effects of intraperitoneal injection of a portion of a recent agar culture in a guinea-pig, the amount sufficient to cause death being also ascertained. The agglutinating or sedimenting properties of the serum of the patient should be tested against a known cholera organism, and against the spirillum cultivated from the case. In the same way the action of the serum of an immunised guinea-pig may be tested both as regards agglutinating and protective properties.

A number of other spirilla have been cultivated, which are of interest on account of their points of resemblance to the cholera organism, though probably they produce no pathological conditions in the human subject.

Metchnikoff's Spirillum (vibrio Metchnikovi).—This organism was obtained by Gamaléia from an epidemic disease of fowls in Odessa, and is of special interest on account of its close resemblance to the cholera organism. In the natural disease, which especially affects young fowls, the animals suffer from diarrhœa, pass into a sort of stupor, sitting with their feathers ruffled, and usually die within forty-eight hours. The intestines contain a greyish-yellow fluid, sometimes slightly blood-stained, in which the spirilla are found. A few of these spirilla may also be found in the blood in the younger fowls, though generally absent from the blood in the older.

Morphologically the organism is practically identical with Koch's spirillum (Fig. 143). It is actively motile, and has the same staining reactions.

Its growth in peptone gelatin also closely resembles that of the cholera organism, though it produces liquefaction more rapidly (Fig. 144, A). In gelatin plates the young colonies are, however, smoother and more circular. After liquefaction occurs, some of the colonies are almost identical in appearance with those of the cholera organism, whilst others show more uniformly turbid contents. In puncture cultures the growth takes place more rapidly, but in appearance closely resembles that of the cholera organism a few days older. Its growth in peptone solution, too, is closely similar, and it also gives the cholera-red reaction.

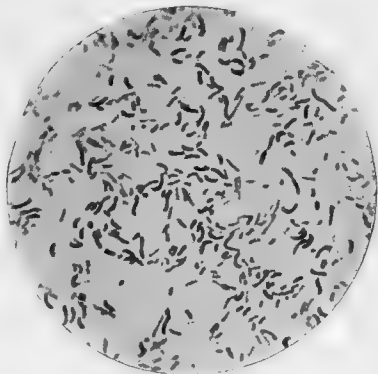

FIG. 143.—Metchnikoff's spirillum, both in curved and straight forms; from an agar culture of twenty-four hours' growth.

Stained with weak carbol-fuchsin. $\times 1000$.

This organism can, however, be readily distinguished from the cholera organism by the effects of inoculation on animals, especially on pigeons and

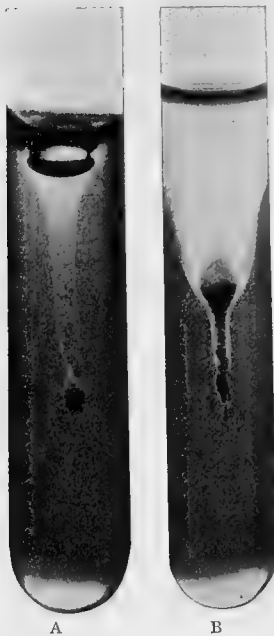

FIG. 144. — Puncture cultures in peptone gelatin.

A. Metchnikoff's spirillum. Five days' growth.

B. Finkler and Prior's spirillum. Four days' growth. Natural size.

guinea-pigs. Subcutaneous inoculation of small quantities of pure culture in pigeons is followed by septicæmia which produces a fatal result usually within twenty-four hours. Inoculation with the same quantity of cholera organism produces practically no result; even with large quantities death is rarely produced. The vibrio Metchnikovi produces somewhat similar effects in the guinea-pig to those in the pigeon, subcutaneous inoculation being followed by extensive hæmorrhagic œdema, and a rapidly fatal septicæmia. Young fowls can be infected by feeding with virulent cultures. We have evidence from the work of Gamaléia that the toxins of this organism have somewhat the same action as those of the cholera organism.

The organism is therefore one which very closely resembles the cholera organism, the results on inoculating the pigeon offering the most ready means of distinction. It gives a negative reaction to Pfeiffer's test; that is, the properties of an anti-cholera serum are not exerted against it. It may also be mentioned that an organism which is apparently the same as the vibrio Metchnikovi was cultivated by Pfuhl from water, and named *V. Nordhafen*.

Spirillum Schuykiliensis. — A spirillum similar in its cultural characters and pathogenic properties to *Sp. Metchnikovi* has been isolated from the waters of the Schuylkill river at Philadelphia, by Abbott, and termed by him spirillum Schuykiliensis.

Finkler and Prior's Spirillum. — These observers, shortly after Koch's discovery of the cholera organism, separated a spirillum, in a case of *cholera nostras*, from the stools after they had been allowed to decompose for several days. There is, however, no evidence that the spirillum has any causal relationship to this or any other disease in the human subject. Morphologically it closely resembles Koch's spirillum, and cannot be distinguished from it by its microscopical characters, although, on the whole, it tends to be rather thicker in the centre and more pointed at the ends (Fig. 145). In cultures, however, it presents marked differences. In puncture cultures on gelatin it grows much more quickly, and liquefaction is generally visible within twenty-four hours. The liquefaction spreads rapidly, and usually in forty-eight hours it has produced a funnel-shaped tube with turbid contents, denser below (Fig. 144, B). In plate-cultures the growth of the colonies is proportionately rapid. Before they have produced liquefaction around them, they appear, unlike those of the cholera organism, as minute spheres with smooth margins.

When liquefaction occurs, they appear as little spheres with turbid contents, which rapidly increase in size; ultimately general liquefaction occurs. On potatoes this organism grows well at the ordinary temperature, and in two or three days has formed a slimy layer of greyish-yellow colour, which rapidly spreads over the potato. On all the media the growth has a distinctly foetid odour. A growth in peptone solution fails to give the cholera-red reaction at the end of twenty-four hours, though later a faint reaction may appear. As stated above, Koch succeeded in producing, by this organism, an intestinal affection in guinea-pigs after neutralising the stomach contents and paralyzing the intestine with opium. This occurs in a small proportion of the animals experimented on, and the contents of the intestine, unlike what was found in the case of the cholera organism, were turbid in appearance, and had a markedly foetid odour.

When tested by intraperitoneal injection, its effects are somewhat of the same nature as those of the cholera organism, but its virulence is of a much lower order.

An organism cultivated by Miller ("Miller's spirillum") from the cavity of a decayed tooth in a human subject is almost certainly the same organism as Finkler and Prior's spirillum.

Deneke's Spirillum.— This organism was obtained from old cheese, and is also known as the *spirillum tyrogenum*. It closely resembles Koch's spirillum in microscopic appearances, though it is rather thinner and smaller. Its growth in gelatin is also somewhat similar, but liquefaction proceeds more rapidly, and the bell-shaped depression on the surface is larger and shallower, whilst the growth has a more distinctly yellowish tint. The colonies in plates also show points of resemblance, though the youngest colonies are rather smoother and more regular on the surface, and liquefaction occurs more rapidly than in the case of the cholera organism. The colonies have, on naked-eye examination, a distinctly yellowish colour. The organism does not give the cholera-red reaction, and on potato it forms a thin yellowish layer when incubated above 30° C. When tested by intraperitoneal injection and by other methods it is found to possess very feeble, or almost no, pathogenic properties. Koch found that this organism, when administered through the stomach in the same way as the cholera organism, produced a fatal result in three cases out of fifteen. Deneke's spirillum is usually regarded as a comparatively harmless saprophyte.

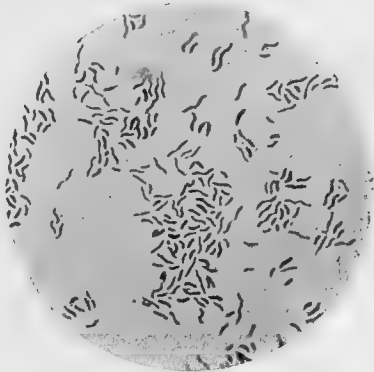

FIG. 145.— Finkler and Prior's spirillum; from an agar culture of twenty-four hours' growth.

Stained with carbol-fuchsin. $\times 1000$.

CHAPTER XIX.

INFLUENZA, PLAGUE, RELAPSING FEVER, MALTA FEVER, YELLOW FEVER.

INFLUENZA.

THE first account of the organism now known as the influenza bacillus was published simultaneously by Pfeiffer, Kitasato, and Canon, in January, 1892. The two first-mentioned observers found it in the bronchial sputum, and obtained pure cultures, and Canon observed it in the blood in a few cases of the disease. It is, however, to Pfeiffer's work that we owe most of our

knowledge regarding its characters and action. His results have been amply confirmed by those of others in various epidemics of the disease, and this organism is now generally accepted as the cause of the disease, although the absolute proof, which would be supplied by the production of the disease by pure cultures, is still wanting.

Microscopical Characters.—

FIG. 146.—Influenza bacilli from a culture on blood agar.

Stained with carbol-fuchsin. $\times 1000$.

The influenza bacilli as seen in the sputum are very minute rods not exceeding 1.5μ in length and $.3 \mu$ in thickness. They are straight, with rounded ends, and sometimes stain more deeply at the extremities (Fig. 146). The bacilli occur singly or form clumps by their aggregation, but do not grow into chains. They show no capsule. They take up the basic aniline stains somewhat feebly, and are best stained by a weak solution (1 in 10) of carbol-fuchsin applied

for 5 to 10 minutes. They lose the stain in Gram's method. They are non-motile, and do not form spores.

In many cases of the disease, especially in the early stages of the more acute, influenza bacilli are present in large numbers and may be easily found. On the other hand, it is often difficult or impossible to find them, even when the symptoms are severe; this may be due to the restriction of the organisms to some part not readily accessible, or it may be that they actually die out in great part, while the effects of their toxins persist. It has also been observed in the most recent epidemic, in which the disease has been less widespread and on the whole less severe, that the period during which the bacilli have been readily demonstrable in the secretions has been on the average shorter than in the previous epidemics.

Cultivation. — The best medium for the growth of the influenza bacillus is blood agar (see p. 42), which was introduced by Pfeiffer for this purpose. He obtained growths of the bacilli on agar which had been smeared with influenza sputum, but he failed to get any *sub*-cultures on the agar media or on serum. The growth in the first cultures he considered to be probably due to the presence of certain organic substances in the sputum, and accordingly he tried the expedient of smearing the agar with drops of blood before making the inoculations. In this way he completely succeeded in attaining his object. The blood of the lower animals is suitable, as well as human blood. The colonies of the influenza bacilli on blood agar, incubated at 37° C., appear within twenty-four hours, in the form of minute circular dots almost completely transparent. When numerous, the colonies are scarcely visible to the naked eye, but when sparsely arranged they may reach the size of a small pin's head. This size is generally reached on the second day. The bacilli die out somewhat quickly in cultures, and in order to keep them alive, sub-cultures should be made every four or five days. By this method the cultures may be maintained for an indefinite period. They also grow well on agar smeared with a solution of hæmoglobin; growth on the ordinary agar media is slight and somewhat uncertain. A very small amount of growth takes place in bouillon, but it is more marked when a little fresh blood is added. The growth forms a thin whitish deposit at the bottom of the flask. The limits of growth are from 25° to 42° C.,

the optimum temperature being that of the body. The influenza bacillus is a strictly aerobic organism.

The powers of resistance of this organism are of a low order. Pfeiffer found that dried cultures kept at the ordinary temperature were usually dead in twenty hours, and that if sputum were kept in a dry condition for two days, all the influenza bacilli were dead, or rather cultures could be no longer obtained. Their duration of life in ordinary water is also short, the bacilli usually being dead within two days. From these experiments Pfeiffer concludes that outside the body in ordinary conditions they cannot multiply, and can remain alive only for a short time. The mode of infection in the disease he accordingly considers to be chiefly by means of mucus, etc.

Distribution in the Body. — The bacilli are found chiefly in the respiratory passages in influenza. They may be present in large numbers in the nasal secretion, generally mixed with a considerable number of other organisms, but it is in the small masses of greenish-yellow sputum from the bronchi that they occur in largest numbers, and in many cases almost in a state of purity. They occur in clumps which may contain as many as 100 bacilli, and in the early stages of the disease are chiefly lying free. As the disease advances, they may be found in considerable numbers within the leucocytes, and towards the end of the disease a large proportion have this position. It is a matter of considerable importance, however, that they may persist for weeks after symptoms of the disease have disappeared, and may still be detected in the sputum. Especially is this the case when there is any chronic pulmonary disease. They also occur in large numbers in the capillary bronchitis and catarrhal pneumonia of influenza, as Pfeiffer showed by means of sections of the affected parts. In these sections he found the bacilli lying amongst the leucocytes which filled the minute bronchi, and also penetrating between the epithelial cells and into the superficial parts of the mucous membrane. Their presence sets up a marked leucocytic emigration in the peribronchial tissue, the leucocytes passing in large numbers into the lumen of the tubes and sometimes taking up the bacilli. Other organisms also, especially Fraenkel's pneumococcus, may be concerned in the pneumonic conditions following influenza.

In some cases influenza occurs in tubercular subjects, or is

followed by tubercular affection, in which cases both influenza and tubercle bacilli may be found in the sputum. In such a condition the prognosis is very grave. Regarding the presence of influenza bacilli in the other pulmonary complications following influenza, much information is still required. Occasionally in the foci of suppurative softening in the lung the influenza bacilli have been found in a practically pure condition. In cases of empyema the organisms present would appear to be chiefly streptococci and pneumococci; whilst in the gangrenous conditions, which sometimes occur, a great variety of organisms has been found.

As above stated, Canon described the bacilli as occurring in the blood during life, and Pfeiffer, on examining Canon's preparations, admits that the bacilli shown resembled the influenza bacilli. His own observations on a large series of cases convinced him that the organism was very rarely present in the blood, that in fact its occurrence there must be looked upon as exceptional. The conclusions of other observers have, on the whole, confirmed this statement. The organism has been regularly found in enormous numbers in the sputum in influenza, but only occasionally and in small numbers in the blood. It is probable that the chief symptoms in the disease are due to toxins absorbed from the respiratory tract (*vide infra*).

We cannot yet speak definitely with regard to the relation of the bacillus in other complications in influenza. Pfeiffer found it in inflammation of the middle ear, but in a case of meningitis following influenza, Fraenkel's diplococcus was present. In a few cases of meningitis, however, the influenza bacillus has been found, sometimes alone, sometimes along with pyogenic cocci (Pfuhl and Walter, Cornil and Durante); Pfuhl considers that in these the path of infection is usually a direct one through the roof of the nasal cavity. This observer also found *post mortem*, in a rapidly fatal case with profound general symptoms, influenza bacilli in various organs, both within and outside of the vessels. In a few cases also the bacilli have been found in the brain and its membranes, with little tissue change in the parts around.

Experimental Inoculation. — There is no satisfactory evidence that any of the lower animals suffer from influenza in natural conditions, and accordingly we cannot look for very definite results from experimental inoculation. Pfeiffer, by injecting

living cultures of the organism into the lungs of monkeys, in three cases produced a condition of fever of a remittent type. Somewhat similar results were obtained in one animal by smearing the uninjured mucous membrane of the nose with a pure culture. The fever appeared about twenty-four hours after the injection, and lasted for from three to five days. In another case in which large quantities of the bacilli were injected into the trachea, marked prostration and high temperature occurred, death following in twenty-four hours. There was, however, little evidence that the bacilli had undergone multiplication, the symptoms being apparently produced by their toxins. In the case of rabbits, intravenous injection of living cultures produces dyspnoea, muscular weakness, and slight rise of temperature, but the bacilli rapidly disappear in the body, and exactly similar symptoms are produced by injection of cultures killed by the vapour of chloroform. Pfeiffer, therefore, came to the conclusion that the influenza bacilli contain toxic substances which can produce in animals some of the substances of the disease, but that animals are not liable to *infection*, the bacilli not having power of multiplying to any extent in their tissues.

Cantani in a recent work succeeded in producing infection to some extent in rabbits, by injecting the bacilli directly into the anterior portion of the brain. In these experiments the organisms spread to the ventricles, and then through the spinal cord by means of the central canal, afterwards infecting the substance of the cord. An acute encephalitis was thus produced, and sometimes a purulent condition in the lateral ventricles. The bacilli, were, however, never found in the blood or in other organs. The symptoms produced were great dyspnoea, cardiac weakness, and also a paralytic condition which appeared first in the posterior limbs, and then spread to the rest of the body. The temperature was at first elevated, but before death fell below normal. Similar symptoms were also produced by injection of dead cultures, though in this case the dose required to be five or six times larger. Cantani therefore concludes that the brain substance is the most suitable nidus for their growth, but agrees with Pfeiffer in believing that the chief symptoms are produced by toxins resident in the bodies of the bacilli. He made control experiments by injecting other organisms, and also by injecting inert substances into the cerebral tissue.

The evidence, accordingly, that the influenza bacillus is the cause of the disease rests chiefly on the well-established fact that it is always present in the secretions of the respiratory tract in true cases of influenza, and that it is an organism which has not been found in any other condition. Moreover, it is an organism which is practically restricted by its conditions of growth to the animal body. A certain amount of confirmatory evidence has been supplied by the results of experiment.

Methods of Examination. — (*a*) *Microscopic.* — A portion of the greenish-yellow purulent material which often occurs in little round masses in the sputum should be selected, and film preparations should be made in the usual way. Films are best stained by Ziehl-Neelsen carbol-fuchsin diluted with ten parts of water, the films being stained for ten minutes at least. In sections of the tissues, such as the lungs, the bacilli are best brought out, according to Pfeiffer, by staining with the same solution as above for half an hour. The sections are then placed in alcohol containing a few drops of acetic acid, in which they are dehydrated and slightly decolorised at the same time. They should be allowed to remain till they have a moderately light colour, the time varying according to their appearance. They are then washed in pure alcohol, cleared in xylol, and afterwards mounted in balsam.

(*b*) *Cultures.* — A suitable portion of the greenish-yellow material having been selected from the sputum, it should be washed well in several changes of sterilised water. A portion should then be taken on a platinum needle, and successive strokes made on the surface of blood-agar tubes. The tubes should then be incubated at 37° C., when the transparent colonies of the influenza bacillus will appear, usually within twenty-four hours. These should give a negative result on inoculation on ordinary agar media.

PLAGUE.¹

The bacillus of oriental plague or bubonic pest was discovered independently by Kitasato and Yersin during the epidemic at Hong Kong in 1894. The results of their investigations, which were published almost at the same time, agree in most of the

¹ In revising this subject we have made extensive use of the *Report of the Indian Plague Commission, 1901.*

important points. They cultivated the same organism from a

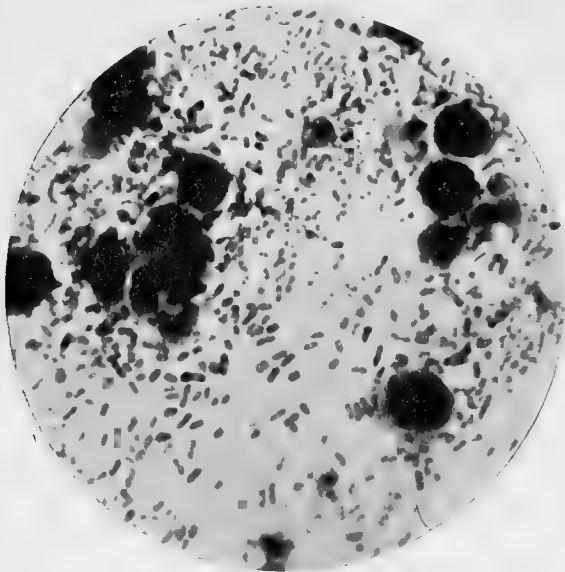

FIG. 147.—Film preparation from a plague bubo showing enormous numbers of bacilli, most of which show well-marked bipolar staining.

Stained with weak gentian-violet. $\times 1000$.

large number of cases of plague, and reproduced the disease in susceptible animals by inoculation of pure cultures. It is to be noted that during an epidemic of plague, sometimes even preceding it, a high mortality has been observed among certain animals, especially rats and mice, and that from the bodies of these animals

was obtained by Kitasato and also by Yersin.

Bacillus of Plague. — *Microscopical Characters.* — As seen in the affected glands or buboes in this disease, the bacilli are small oval rods, somewhat shorter than the typhoid bacillus, and about the same thickness (Fig. 148), though considerable variations in size occur. They have rounded ends, and in stained preparations a portion in the middle of the bacillus is often left uncovered, giving the so-called “polar staining.” In films from the



FIG. 148.—Bacillus of plague from a young culture on agar.

Stained with weak carbol-fuchsin. $\times 1000$.

from the bodies of these animals

tissues they are found scattered amongst the cells, for the most part lying singly, though pairs are also seen. On the other hand, in cultures in fluids, *e.g.* bouillon, they grow chiefly in chains, sometimes of considerable length, the form known as a streptobacillus resulting (Fig. 149). In young agar cultures the bacilli show greater variation in size, and polar staining is less marked than in the tissues: sometimes forms of considerable length are present. After a time involution forms appear, especially when the surface of the agar is dry; but the formation of these is much more rapid and more



FIG. 149.—Bacillus of plague in chains, showing polar staining. From a young culture in bouillon.

Stained with thionin-blue. $\times 1000$.

marked when 2–5 per cent of sodium chloride is added to the medium, constituting the so-called “salt agar” (Hankin and Leumann). On this medium, especially with the higher per-

centage, the involution forms assume a great size and a striking variety of shapes, large globular, oval, or pyriform bodies resulting (Fig. 150); with about 2 per cent sodium chloride, after twenty-four hours' incubation, the most striking feature is a general enlargement of all the bacilli. Sometimes in the tissues they are seen to be surrounded by an unstained capsule, though this appearance is by no means common. They do not form spores. Gordon, who has found that they possess flagella which,

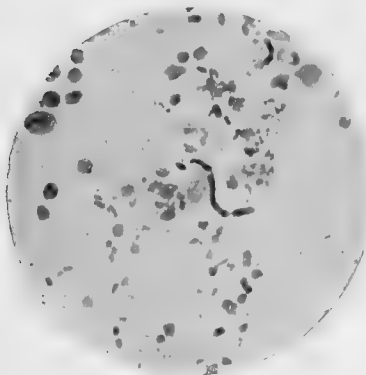

FIG. 150.—Culture of the bacillus of plague on 4 per cent salt agar, showing involution forms of great variety of size and shape.

Stained with carbol-thionin-blue. $\times 1000$.

however, stain with difficulty, states that they are motile. Most observers, however, and with these we agree, have failed to

find evidence of true motility. They stain readily with the basic aniline stains, but are decolorised by Gram's method.

Cultivation. — From the affected glands, etc., the bacillus can readily be cultivated on the ordinary media. It grows best at the temperature of the body, though growth occurs as low as 18° C. On *agar* and on *blood serum* the colonies are circular discs of somewhat transparent appearance and smooth, shining surface. When examined with a lens, their borders appear slightly wavy. In stroke-cultures on *agar* there forms a continuous line of growth with the same appearance, showing partly separated colonies at its margins. When *agar* cultures are kept at the room temperature, some of the colonies show a more luxuriant growth with more opaque appearance than the rest of the growth, the appearance in fact being often such as to suggest the presence of impurities in the cultures. In stab-cultures in peptone *gelatin*, growth takes place along the needle track as a white line, composed of small spherical colonies. On the surface of the *gelatin* a thin, semi-transparent layer may be formed, which is usually restricted to the region of puncture, though sometimes it may spread to the wall of the tube; sometimes, however, there is practically no surface growth. There is no liquefaction of the medium. In *gelatin* plates the superficial colonies develop first and form slightly raised semi-transparent discs with somewhat crenated margins; the deeper colonies are smaller and of spherical shape with smooth outline. In *bouillon* the growth usually forms a slightly granular or powdery deposit at the foot and sides of the flask, somewhat resembling that of a streptococcus. If oil or melted butter is added to the *bouillon* so that drops float on the surface, then a striking mode of growth may result, to which the term "stalactite" has been applied. This consists in the growth starting from the under surface of the fat globules and extending downwards in the form of pendulous, string-like masses. These masses are exceedingly delicate, and readily break off on the slightest shaking of the flask; accordingly during their formation the culture must be kept absolutely at rest. This manner of growth constitutes an important but not absolutely specific character of the organism; unfortunately it is not supplied by all races of the organism, and varies from time to time with the same race. The organism flourishes best in an abundant supply of

oxygen; in strictly anaerobic conditions almost no growth takes place.

The organism in its powers of resistance corresponds with other spore-free bacilli, and is readily killed by heat, an exposure for an hour at 58° C. being fatal. On the other hand, it has remarkable powers of resistance against cold; it has been exposed to a temperature several degrees below freezing-point without being killed. Experiments on the effects of drying have given somewhat diverse results, but as a rule the organism has been found to be dead after being dried for from six to eight days, though sometimes it has survived the process for a longer period; exposure to direct sunlight for three or four hours kills it. When cultivated outside the body the organism often loses its virulence, but some races remain virulent in culture for a long period of time.

Anatomical Changes and Distribution of Bacilli. — The disease occurs in several forms, the *bubonic* and the *pulmonary* being the best

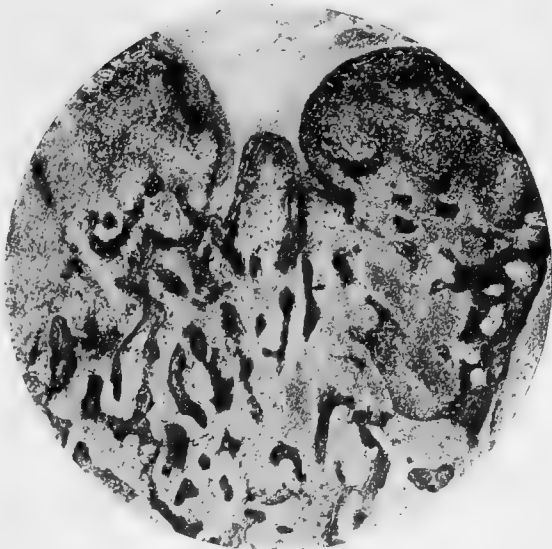

FIG. 151.—Section of a human lymphatic gland in plague, showing the injection of the lymph paths and sinuses with masses of plague bacilli—seen as black areas.

Stained with carbol-thionin-blue. $\times 50$.

recognised; to these may be added the *septicæmic*. The most striking feature in the *bubonic* form is the affection of the lymphatic glands, which undergo intense inflammatory swelling, attended with hæmorrhage, and generally ending in a greater or less degree of necrotic softening if the patient lives long enough. The connective tissue around the glands is similarly affected. The bubo is thus usually formed by a col-

lection of enlarged glands fused by the inflammatory swelling. True suppuration is rare. Usually one group of glands is affected first, constituting the primary bubo—in the great majority the inguinal or the axillary glands—and afterwards other groups may become involved, though to a much less extent. Along with these changes there is great swelling of the spleen, and often intense cloudy swelling of the cells of the kidneys, liver, and other organs. There may also occur secondary areas of hæmorrhage and the necrosis, chiefly in the lungs, liver, and spleen. The bacilli occur in enormous numbers in the swollen glands, being often so numerous that a film preparation made from a scraping almost resembles a pure culture (Fig. 147). In sections of the glands in the earlier stages the bacilli are found to form dense masses in the lymph paths and sinuses (Fig. 151), often forming an injection of them; they may also be seen growing as a fine reticulum between the cells of the lymphoid tissue. At a later period, when disorganisation of the gland has occurred, they become irregularly mixed with the cellular elements. Later still they gradually disappear, and when necrosis is well advanced it may be impossible to find any—a point of importance in connection with diagnosis. In the spleen they may be very numerous or they may be scanty, according to the amount of blood infection which has occurred; in the secondary lesions mentioned they are often abundant. In the *pulmonary* form the lesion is the well-recognised “plague pneumonia.” This is of broncho-pneumonic type, though large areas may be formed by confluence of the consolidated patches, and the inflammatory process is attended usually by much hæmorrhage; the bronchial glands show inflammatory swelling. Clinically there is usually a fairly abundant frothy sputum often tinted with blood, and in it the bacilli may be found in large numbers. Sometimes, however, cough and expectoration may be absent. The disease in this form is said to be invariably fatal. In the *septicæmic* form proper there is no primary bubo discoverable, though there is almost always general enlargement of lymphatic glands; here also the disease is of specially grave character. A bubonic case may, however, terminate with septicæmia; in fact all intermediate forms occur. An *intestinal* form with extensive affection of the mesenteric glands has been described, but it is exceedingly rare—so much so that many

observers with extensive experience have doubted its occurrence. In the various forms of the disease the bacilli occur also in the blood, in which they may be found during life by microscopic examination, chiefly, however, just before death in very severe and rapidly fatal cases. In most cases, however, they cannot be detected in the blood by this means, though in some of these they may be obtained by means of cultures.

The above types of the disease are usually classified together under the heading *pestis major*, but there also occur mild forms to which the term *pestis minor* is applied. In these latter there may be a moderate degree of swelling of a group of glands, attended with some pyrexia and general malaise, or there may be little more than slight discomfort. Between such and the graver types, cases of all degrees of severity are met with.

Experimental Inoculation. — Mice, guinea-pigs, rats, and rabbits are susceptible to inoculation, the two former being on the whole most suitable for experimental purposes. After subcutaneous injection there occurs a local inflammatory œdema, which is followed by inflammatory swelling of the corresponding lymphatic glands, and thereafter by a general infection. The lesions in the lymphatic glands correspond in their main characters with those in the human subject, although usually at the time of death they have not reached a stage so advanced. By this method of inoculation mice usually die in 1–3 days, guinea-pigs and rats in 2–5 days, and rabbits in 4–7 days.

Post mortem the chief changes, in addition to the glandular enlargement, being congestion of internal organs, sometimes with hæmorrhages, and enlargement of the spleen; the bacilli are numerous in the lymphatic glands and usually in the spleen (Fig. 152), and also, though in somewhat less degree, throughout the blood. Infection can also be produced by smearing the

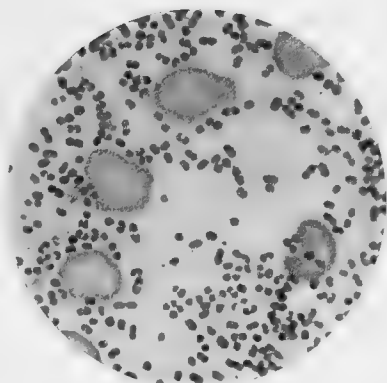

FIG. 152.— Film preparation of spleen of rat after inoculation with bacillus of plague, showing numerous bacilli, most of which are somewhat plump.

Stained with carbol-thionin-blue. $\times 1000$.

material on the conjunctiva or mucous membrane of the nose, and this method of inoculation has been successfully applied in cases where the plague bacilli are present along with other virulent organisms, *e.g.* in sputum along with pneumococci. Rats and mice can also be infected by feeding either with pure cultures or with pieces of organs from cases of the disease, though in this case infection probably takes place through the mucous membrane of the mouth and adjacent parts, and only to a limited extent, if at all, by the alimentary canal. Monkeys also are highly susceptible to infection, and it has been shown in the case of these animals that, when inoculation is made on the skin surface, for example, by means of a spine charged with the bacillus, the glands in relation to the part may show the characteristic lesion and a fatal result may follow without there being any noticeable lesion at the primary seat. This fact throws important light on infection by the skin in the human subject. The disease may also extensively affect monkeys by natural means during an epidemic.

Paths and Mode of Infection. — It is now well established that in the great majority of cases plague bacilli enter the system by the skin surface through small wounds, cracks, abrasions, etc., and that there is usually no reaction at the site of entrance. This last fact is in accordance with what has been stated above with regard to experiments on monkeys. The path of infection is shown by the primary buboes, which are usually in the glands through which the skin is drained, those in the groin being the commonest site. Absolute proof of infection by the skin is supplied by several cases in which the disease has been acquired at *post-mortem* examinations, the lesions of the skin surface being in the majority of these of trifling nature; in only two was there local reaction at the site of inoculation. In most of these cases the period of incubation has been from two to three days; under natural conditions of infection the Indian Commission places the average period within five days. In a small proportion of cases infection takes place through the mucous membrane of the nose and mouth, and exceptionally of other parts; it is still considered doubtful whether the alimentary canal is a path of infection. In primary plague pneumonia, from a consideration of the anatomical changes and the clinical facts, the disease may be said to be produced by the direct pas-

sage of the bacilli into the respiratory passages. Nevertheless there must be certain factors, still imperfectly understood, which determine the incidence of this form; as in some epidemics of the highest virulence plague pneumonia has been practically absent, though opportunities for infection by inhalation must have been present. On the other hand, a case of plague pneumonia is of great infectivity in producing other cases of plague pneumonia.

With regard to the mode of infection it may be stated, in the first place, that if we except plague pneumonia and those rare conditions in which true plague eruptions are present, direct infection from patient to patient is relatively uncommon. This is in accordance with the fact that in bubonic plague the bacilli are not discharged from the unbroken surface of the body, and are only present in the secretions in severe cases. In the great majority contagion is of indirect character, through the medium of soiled clothes, fomites — in fact, contaminated articles generally; thus rooms and houses come to be “sources of infection.” In addition to cases of the disease in the human subject, the affection in animals, especially in rats, plays an important part in the spread of epidemics. The disease in these animals has, in fact, been the means of rapidly distributing infection over wide areas of a town or district. This has been abundantly proved in the case of Bombay, where observations have shown that the migration of plague-infected rats to quarters comparatively free from the disease has been followed by extensive outbreaks in these places. On the other hand, there is no doubt that plague in a very widespread and virulent form may occur without the agency of these animals.

The view that fleas and other insects play a part in the spread of plague has obtained pretty wide acceptance, but recent examination has proved that most of the data on which this is based are of unsatisfactory nature. Yersin found the plague bacillus in the dead bodies of these insects, and Simond brought forward the results of experiments which appeared to show that the fleas infecting a plague-stricken rat left the animal when it died, and might produce plague in a healthy animal. Experiments performed by others have, however, given negative results, and the finding of the Indian Commission is that suctorial insects are practically of no importance as transmitters of infection.

From the facts stated with regard to the powers of comparatively rapid multiplication of the bacillus, its wide dissemination by affected rats, human excreta, etc., it may be understood how extensively the soil and dwellings may become infected, and how difficult it may be to arrest the ravages of the disease. How important a part such infection of a *locality* plays is strikingly shown by the rapid fall in the number of cases when the people go into tents.

Toxins, Immunity, etc. — As is the case with most organisms which extensively invade the tissues, the toxins in plague cultures are chiefly contained in the bodies of the bacteria. Injection of dead cultures in animals produces distinctly toxic effects; *post-mortem*, hæmorrhage in the mucous membrane of the stomach, areas of necrosis in the liver and at the site of inoculation, may be present. The toxic substances are comparatively resistant to heat, being unaffected by an exposure to 65° C. for an hour. By the injection of dead cultures in suitable doses a certain degree of immunity against the living virulent bacilli is obtained, and, as first shown by Yersin, Calmette, and Borrel, the serum of such immunised animals confers a degree of protection on smaller animals, such as mice. On these facts the principles of preventive inoculation and serum treatment, presently to be described, depend. It may also be mentioned that the filtrate of a plague culture possesses a very slight toxic action, and the Indian Plague Commission found that such a filtrate has practically no effect in the direction of conferring immunity.

1. *Preventive Inoculation — Haffkine's Method.* — To prepare the preventive fluid, cultures are made in flasks of bouillon with drops of oil on the surface (in India Haffkine employed a medium prepared by digesting goats' flesh with hydrochloric acid at 140° C. and afterwards neutralising with caustic soda). In such cultures stalactite growths (*vide supra*) form, and the flasks are shaken every few days so as to break up the stalactites and induce fresh crops. The flasks are kept at a temperature of about 25° C., and growth is allowed to proceed for about six weeks. At the end of this time sterilisation is effected by exposing the contents of the flasks to 65° C. for an hour; thereafter carbolic acid is added in the proportion of .5 per cent. The contents are well shaken to diffuse thoroughly the sediment in the fluid and are then distributed in small sterilised bottles for

use. The preventive fluid thus contains both the dead bodies of the bacilli and any toxins which may be in solution. It is administered by subcutaneous injection, the dose, which varies according to the "strength," being on an average about 7.5 c.c. Usually only one injection is made, sometimes two*, though the latter procedure does not appear to have any advantage. The method has been systematically tested by inoculating a certain proportion of the inhabitants of districts exposed to infection, leaving others uninoculated, and then observing the proportion of cases of disease and the mortality amongst the two classes. The results of inoculation, as attested by the Indian Commission, have been distinctly satisfactory. For although absolute protection is not afforded by inoculation, both the proportion of cases of plague and the percentage mortality amongst these cases have been considerably smaller in the inoculated as compared with the uninoculated. Protection is not established till some days after inoculation, and probably lasts for a considerable number of weeks. The Commission recommend, however, the employment of a better method of standardisation (this being roughly effected according to the amount of suspended matter present), and also more efficient methods for ensuring the freedom of the fluid from contaminating organisms — improvements which will no doubt be carried out.

2. *Anti-plague Sera.* — Of these two have been used as therapeutic agents, viz., that of Yersin and that of Lustig. Yersin's serum is prepared by injections of increasing doses of plague bacilli into the horse. In the early stages of immunisation dead bacilli are injected subcutaneously, thereafter into the veins, and, finally, living bacilli are injected intravenously. After a suitable time blood is drawn off and the serum is preserved in the usual way. Of this serum 10–20 c.c. are used, and injections are usually repeated on subsequent days. Lustig's serum is prepared by injecting a horse with repeated and increasing doses of a substance derived from the bodies of plague bacilli, probably in great part nucleo-proteid. Masses of growth are obtained from the surface of agar cultures, and are broken up and dissolved in a 1 per cent solution of caustic potash. The solution is then made slightly acid by hydrochloric acid, when a bulky precipitate forms; this is collected on a filter and dried. For use a weighed amount is dissolved in a weak solution of carbonate

of soda and then injected. The serum is obtained from the animal in the usual way. Extensive observations with both of these sera show that neither of them can be considered a powerful remedy in cases of plague, though in certain instances distinctly favourable results have been recorded. The Indian Commission, however, came to the conclusion "that, on the whole, a certain amount of advantage accrued to the patients both in case of those injected with Yersin's serum and of those injected with Lustig's serum." It may also be mentioned that the Commission found, as the results of experiments, that Yersin's serum modified favourably the course of the disease in animals, whereas Lustig's serum had no such effect.

3. *Serum Diagnosis.* — Specific agglutinins may appear in the blood of patients suffering from plague, as also they do in the case of animals immunised against the plague bacillus. It is to be noted, however, that in clinical cases the reaction is not invariably present, the potency of the serum is not of high order, and the carrying out of the test is complicated by the natural tendency of the bacilli to cohere in clumps. For the last reason the macroscopic (sedimentation) method is to be preferred to the microscopic (p. 109). A suspension of plague bacilli is made by breaking up a young agar culture in .75 per cent sodium chloride solution; the larger flocculi of growth are allowed to settle, and the fine, supernatant emulsion is employed in the usual way. According to the results of the German Plague Commission, and the observations of Cairns made during the Glasgow epidemic, it may be said that the reaction is best obtained with dilutions of the serum of from 1 : 10 to 1 : 50. Cairns found that the date of its appearance is about a week after the onset of illness, and that it usually increases till about the end of the sixth week, thereafter fading off. It is most marked in severe cases, characterised by an early and favourable crisis, less marked in severe cases ultimately proving fatal, whilst in very mild cases it is feeble or may be absent. The method, if carefully applied, may be of service under certain conditions; but it will be seen that its use as a means of diagnosis is somewhat restricted. The serum reaction has also been employed to distinguish the plague bacillus from other organisms morphologically resembling it.

Methods of Diagnosis. — Where a bubo is present a little of the juice may be obtained by plunging a sterile hypodermic

needle into the swelling. The fluid is then to be examined microscopically, and cultures on agar or blood serum should be made by the successive stroke method. The cultural and morphological characters are then to be investigated, the most important being the involution forms on salt agar and the stalactite growth in bouillon, though the latter may not always be obtained with the plague bacillus; the pathogenic properties should also be studied, the guinea-pig being on the whole most suitable for subcutaneous inoculation. In many cases a diagnosis may be made by microscopic examination alone, as in no other known condition than plague do bacilli with the morphological characters of the plague bacillus occur in the lymphatic glands. An examination of the blood will only give positive results in severe cases. And in every instance, on the occurrence of the first suspected case, every care to exclude possibility of doubt should be used before a positive opinion is given.

In a case of suspected plague pneumonia, in addition to microscopic examination of the sputum, the above cultural methods along with animal inoculation with the sputum should be carried out; subcutaneous injection in the guinea-pig and smearing the nasal mucous membrane of the rat may be recommended. Here a positive diagnosis should not be attempted by microscopic examination alone, especially in a plague-free district, as bacilli morphologically resembling the plague organism may occur in the sputum in other conditions.

RELAPSING FEVER.

At a comparatively early date, namely in 1873, when practically nothing was known with regard to the production of disease by bacteria, a highly characteristic organism was discovered in the blood of patients suffering from relapsing fever. This discovery was made by Obermeier, and the organism is usually known as the *spirillum* or *spirochæte Obermeieri*, or the *spirillum of relapsing fever*. He described its microscopical characters, and found that its presence in the blood had a definite relation to the time of the fever, as the organism rapidly disappeared about the time of the crisis, and reappeared when a relapse occurred. He failed to find such an organism in any other disease. His observations were fully confirmed, and his views as to its causal relationship to the disease were generally accepted. Later, the

disease was produced in the human subject by inoculations with blood containing the organisms, and a similar condition has been produced in apes.

Characters of the Spirillum. — The organisms as seen in the blood during the fever are delicate spiral filaments which have a length of from two to six times the diameter of a red blood corpuscle. They are, however, exceedingly thin, their thickness being much less than that of the cholera spirillum. They show several regular sharp curves or windings, of number varying according to the length of the spirilla, and their extremities are finely pointed (Fig. 153). They are actively motile, and may

be seen moving quickly across the microscopic field with a peculiar movement which is partly twisting and partly undulatory, and disturbing the blood corpuscles in their course.

They stain with watery solutions of the basic aniline dyes, though somewhat faintly, and are best coloured in film preparations of Löffler's or Kühne's methylene-blue solutions. When thus stained they usually have a uniform appearance throughout, or may be

slightly granular at places, but they show no division into short segments. They lose the stain in Gram's method.

In blood outside the body the organisms have a considerable degree of vitality, and when kept in sealed tubes have been found alive and active after many days. They are readily killed at a temperature of 60° C., but may be exposed to 0° C. without being killed. There is no evidence that they form spores.

Relations to the Disease. — In relapsing fever, after a period of incubation, there occurs a rapid rise of temperature which lasts for about five to seven days. At the end of this time a crisis occurs, the temperature falling quickly to normal. In the course of about other seven days a sharp rise of temperature again takes place, but on this occasion the fever lasts a shorter time, again suddenly disappearing. A second or even third relapse

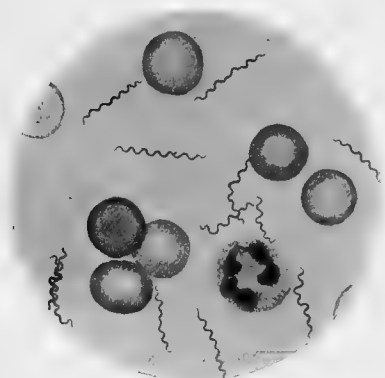

FIG. 153.—Spirilla of relapsing fever in human blood. Film preparation. (After Koch.) \times about 1000.

may occur after a similar interval. The spirilla begin to appear in the blood shortly before the onset of the pyrexia, and during the rise of temperature rapidly increase in number. They are very numerous during the fever, a large number being often present in every field of the microscope when the blood is examined at this stage. They begin to disappear shortly before the crisis; after the crisis they are entirely absent from the circulating blood. A similar relation between the presence of the spirilla in the blood and the fever is found in the case of the relapses; whilst between these they are entirely absent. Münch in 1876 produced the disease in the human subject by injecting blood containing the spirilla, and this experiment has been several times repeated with the same result; after a period of incubation the spirilla begin to appear in the circulating blood, and their appearance is soon followed by the occurrence of pyrexia.

Numerous attempts to cultivate this organism outside the body have all been attended with failure, and it has been abundantly shown that it does not grow on any of the media ordinarily in use. Koch found that on blood serum the filaments of the spirilla increased somewhat in length, and formed a sort of felted mass, but that no multiplication took place. Additional proof, however, that the organism is the cause of the disease has been afforded by experiments on monkeys, and facts of considerable interest have been thus established. Carter, in 1879, was the first to show that the disease could be readily produced in these animals, and his experiments were confirmed by Koch. In such experiments the blood taken from patients and containing the spirilla was injected subcutaneously. In the disease thus produced there is an incubation period which usually lasts about three days. At the end of that time the spirilla rapidly appear in the blood, and shortly afterwards the temperature quickly rises. The period of pyrexia usually lasts for two or three days, and is followed by a marked crisis. As a rule there is no relapse, but occasionally one of short duration occurs. The presence of spirilla in the blood has the same relation to the pyrexial period as in the human subject.

For a long time the place and mode of destruction of the spirilla were quite unknown; but valuable light was thrown on these points by Metchnikoff, who produced the disease in mon-

keys and killed them at various stages of the fever. He found that during the fever the spirilla were practically never taken up by the leucocytes in the circulating blood, but that at the time of the crisis on disappearing from the blood, they accumulated in the spleen and were ingested in large numbers by the microphages or polymorpho-nuclear leucocytes. Within these they rapidly underwent degeneration, and disappeared. Metchnikoff also found that after the spirilla had disappeared from the blood, the disease could be produced in another animal by inoculations with spleen pulp, in which the spirilla were contained within the leucocytes, thus showing that they were living and active in the spleen. It is to be noted in this connection that swelling of the spleen is a very marked feature in relapsing fever. These observations have been entirely confirmed by Soudakewitch, who also showed that the destruction of the spirilla in the spleen of a monkey (*Cercocebus fuliginosus*) was an extremely rapid one, as they were all destroyed ten hours after their disappearance from the blood. He also produced the disease in two monkeys from which the spleen had been previously removed, the animals having been allowed to recover completely from the operation. In these cases the spirilla did not disappear from the blood at the usual time, but rather increased in number, and a fatal result followed on the eighth and ninth days respectively. *Post mortem* he found the spirilla in enormous numbers throughout the blood-vessels, and in the portal vein they almost equalled the red blood corpuscles in number. These experiments would appear to establish the important function of the spleen in the destruction of the organisms; they do not show, however, why the organisms disappear from the blood at a particular time and accumulate in the spleen.

Views of a different character have been advanced by Lamb. According to this observer, while in the monkey (*Macacus radiatus*) a relapse rarely occurs, this animal about a month after recovery is susceptible to fresh inoculation. During the two or three weeks following an attack of the fever it, however, manifests a degree of immunity to infection. If in such an animal the spleen be excised, it still does not suffer from the disease after fresh inoculation. The immunity Lamb attributes to the presence of bactericidal bodies in the serum. The proof of this advanced is that *in vitro* the serum brings the movements of the

spirilla to an end, clumps them, and causes their disintegration ; and further, that when the spirilla and the immune serum were injected in one case into a fresh monkey no disease developed. In opposition to Soudakewitch, Lamb found that with a monkey from which the spleen had been removed and inoculation practised death did not occur. Here it is to be noted, however, that the animals used by Soudakewitch and by Lamb were of different species.

In the case of the human subject it has been found that a second attack of the disease can follow the first after a comparatively short period of time, and it is often said that one attack does not confer immunity. It is probably rather the case that the immunity conferred is of very short duration. The course of events in the disease might be explained by supposing that immunity of short duration is produced during the first period of pyrexia, but that it does not last until all the spirilla have been destroyed, some still surviving in internal organs. With the disappearance of the immunity the organisms reappear in the blood, the relapse being, however, of shorter duration and less severe than the first attack. This is repeated till the immunity lasts long enough to allow all the organisms to be killed. Lamb's observations suggest the probability that this immunity after the crisis may be evidenced by bactericidal powers in the serum, and according to the recent work of Sawtschenko and Melkich, there are developed during the disease both an immune body and an agglutinin (*vide* chapter on Immunity). The former, in association with the alexine of the blood serum, brings about a bactericidal effect, whilst by itself it also constitutes the means whereby a positive chemiotaxis is exerted on the leucocytes. It is further to be noted that relapsing fever is unique amongst bacterial diseases affecting the human subject, in respect of the enormous numbers of organisms which can be observed in the circulating blood during life.

MALTA FEVER.

SYNONYMS:—MEDITERRANEAN FEVER. ROCK FEVER OF GIBRALTAR.
NEAPOLITAN FEVER, ETC.

This disease is of common occurrence along the shores of the Mediterranean and in its islands. By means of the agglutinating

test Wright and Smith have shown that it occurs also in some parts of India, and it has also been observed in the United States and Porto Rico (W. I.). There can be little doubt that its distribution will be found to be much wider than was formerly supposed. Although from its symptomatology and pathological anatomy it had been recognised as a distinct affection, and was known under various names, its precise etiology was unknown till the publication of the researches of Surgeon-Major Bruce in 1887. From the spleen of patients dead of the disease he cultivated a characteristic organism, now known as the *micrococcus melitensis*, and by means of inoculation experiments established its causal relationship to the disease. His results have been confirmed by other observers, and additional confirmatory evidence has been supplied by means of serum diagnosis, as will be described below. Bacteriological methods have therefore been the means of differentiating the disease, and also of affording a more exact basis for diagnosis.

The duration of the disease is usually long—often two or three months, though shorter and much longer periods are met with. Its course is very variable, the fever being of the continued type with irregular remissions. In addition to the usual symptoms of pyrexia there occur profuse perspirations, pains, and sometimes swellings in the joints, occasionally orchitis, whilst constipation is usually a marked feature. The mortality is low—about 2 per cent (Bruce).

In fatal cases the most striking *post-mortem* change is in the spleen. This organ is enlarged, often weighing slightly over a pound, and in a condition of acute congestion; the pulp is soft and may be diffuent, and the Malpighian bodies are swollen and indistinct. In the other organs the chief change is cloudy swelling; in the kidneys there may be in addition glomerular nephritis. The lymphoid tissue of the intestines shows none of the changes characteristic of typhoid fever.

Micrococcus melitensis.—This is a small, rounded or slightly oval organism about $.5 \mu$ in diameter, which is specially abundant in the spleen. It usually occurs singly or in pairs, but in cultures short chains are also met with (Fig. 154). (Durham has shown that in old cultures kept at the room temperature bacillary forms appear, and we have noticed indications of such in comparatively young cultures; the usual form is, however, that of a coccus.)

It stains fairly readily with the ordinary basic aniline stains, but loses the stain in Gram's method. It is generally said to be a non-motile organism. Gordon, however, is of a contrary opinion, and has recently demonstrated that it possesses from one to four flagella, which, however, are difficult to stain. In the spleen of a patient dead of the disease it occurs irregularly scattered through the congested pulp. It may also be found in small numbers *post mortem* in the capillaries of various organs, but examination of the blood during life gives negative results. It can, however, be obtained by puncture of the spleen during life.



FIG. 154. — *Micrococcus melitensis*, from a two days' culture on agar at 37° C. Stained with fuchsin. $\times 1000$.

Cultivation.—This can usually readily be effected by making stroke-cultures on *agar* tubes from the spleen pulp and incubating at 37° C. The colonies, which are usually not visible before the third day, appear as small round discs, slightly raised and of somewhat transparent appearance. The maximum size—2–3 mm. in diameter—is reached about the ninth day; at this period by reflected light they appear pearly white, while by transmitted light they have a yellowish tint in the centre, bluish white at the periphery. A stroke-culture shows a layer of growth of similar appearance with somewhat serrated margins. Old cultures assume a buff tint. The optimum temperature is 37° C., but growth still occurs down to about 20° C. On *gelatin* at summer temperature growth is extremely slow—after two or three weeks, in a puncture culture, there is a delicate line of growth along the needle track and a small flat expansion of growth on the surface. There is no liquefaction of the medium.

In *bouillon* there occurs a general turbidity with flocculent deposit at the bottom; on the surface there is no formation of a pellicle. On *potatoes* no visible growth takes place even at the body temperature, though the organism multiplies to a certain extent.

Relations to the Disease.—There is in the first place ample evidence, from examination of the spleen, both *post mortem* and during life, that this organism is always present in the disease. The experiments of Bruce and Hughes show that by inoculation with even comparatively small doses of pure cultures the disease can be produced in monkeys. In these experiments seven animals in all were used, in every case with a positive result. Four died at varying periods of time, after showing well-marked fever, closely resembling in character that occurring in the human subject, and the micrococcus was obtained from the organs *post mortem*. The other three animals recovered after suffering from illness with corresponding pyrexia—in two cases extending over two months. The disease has also been produced in the human subject by accidental inoculation with a pure culture of the micrococcus, Birt and Lamb citing three cases, and Strong and Musgrave one case.

Rabbits, guinea-pigs, and mice are insusceptible to inoculation by the ordinary method. Durham, by using the intracerebral method of inoculation, has, however, succeeded in raising the virulence so that the organism is capable of producing in guinea-pigs on intraperitoneal injection illness with sometimes a fatal result many weeks afterwards. An interesting point brought out by these experiments is that in the case of animals which survive the micrococcus may be cultivated from the urine several months after inoculation.

Agglutinative Action of Serum.—The blood serum of patients suffering from Malta fever possesses the power of agglutinating the micrococcus *melitensis* in a manner analogous to what has been described in the case of typhoid fever. This action is manifested throughout the disease, and also for a considerable time after recovery. Wright and Smith found it well marked a year afterwards. They found that the greatest dilution which gives distinct agglutinative effects varies in different cases from 1 : 10 to 1 : 1000. As regards relation to prognosis, the observations of Birt and Lamb and of Bassett-Smith have given results analogous to those obtained in typhoid (p. 343).

Methods of Diagnosis.—During life the best means of diagnosis is supplied by the agglutinative test just described (for technique, *vide* p. 109).

Cultures are most easily obtained from the spleen either

during life or *post mortem*. Inoculate a number of agar tubes by successive strokes and incubate at 37° C. Film preparations should also be made from the spleen pulp and stained with carbol-thionin-blue or diluted carbol-fuchsin (1 : 10).

YELLOW FEVER.

Yellow fever is an infectious disease which is endemic in the West Indies, in Brazil, in Sierra Leone, and the adjacent parts of West Africa, though it is probable that it was from the first-named region that the others were originally infected. From time to time serious outbreaks occur, during which neighbouring countries also suffer, and the disease may be carried to other parts of the world. In this way epidemics have occurred in the United States, in Spain, and even in England, infection usually being carried by cases occurring among the crews of ships. In the parts where it is endemic, though usually a few cases may occur from time to time, there is some evidence that occasionally the disease may remain in abeyance for many years and then originate *de nova*. There is, therefore, reason to suspect that the infective agent can exist for considerable periods outside the human body. It is possible, however, that continuity may be maintained by the occurrence of a mild type of the disease which may be grouped with the "bilious fevers" prevalent in yellow-fever regions. This would explain the degree of immunity which is shown during a serious epidemic by the older immigrants.

Great variations are observed in the clinical types under which the disease presents itself. Usually after from two to six days' incubation a sudden onset in the form of a rigour occurs. The temperature rises to 104°–105° F. The person is livid, with outstanding bloodshot eyes. There are present great prostration, pain in the back, and vomiting, at first of mucus, later of bile. The urine is diminished and contains albumin. About the fifth day an apparent improvement takes place, and this may lead on to recovery. Frequently, however, the remission, which may last from a few hours to two days, is followed by an aggravation of all the symptoms. The temperature rises, jaundice is observed, hæmorrhages occur from all the mucous surfaces, causing, in the case of the stomach, the "black vomit"

—one of the clinical signs of the disease in its worst form. Anuria, coma, and cardiac collapse usher in a fatal issue. The mortality varies in different epidemics from about 35 to 99 per cent of those attacked. Both white and black races are susceptible, but those who have resided long in a country are less susceptible than new immigrants. An attack of the disease usually confers complete immunity against subsequent infection.

Post mortem the stomach is found in a state of acute gastritis, and contains much altered blood derived from hæmorrhages which have occurred in the mucous and submucous coats. The intestine may be normal, but is often congested and may be ulcerated; the mesenteric glands are enlarged. The liver is in a state of fatty degeneration of greater or less degree, but often resembling the condition found in phosphorus poisoning. The kidneys are in a state of intense glomerulo-nephritis, with fatty degeneration of the epithelium. There is congestion of the meninges, especially in the lumbar region, and hæmorrhages may occur. The other organs do not show much change, though small hæmorrhages under the skin and into all the tissues of the body are not infrequent. In the blood a feature is the excess of urea present, amounting, it may be, to nearly 4 per cent.

The Etiology of Yellow Fever. — Two chief views are here held. (1) That the disease is caused by a bacterium belonging to the *B. coli* group and called the *B. icteroides*. (2) That the causal agent is of such small size as to be microscopically invisible, and that for the transmission of the

disease from man to man a mosquito acting as an intermediate host is necessary. This latter view, which chronologically is second, now holds the more important position.

1. *Bacillus icteroides*. — A very full research into the bacteriology of yellow fever was that of Sternberg (1890), the result of which was that of various organisms isolated one which he named "bacillus x" appeared possibly to

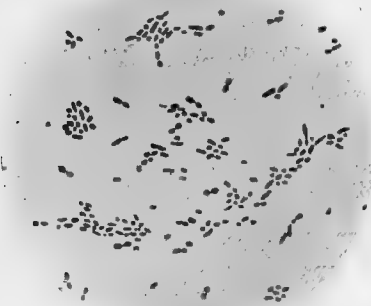

FIG. 155. — *Bacillus icteroides*, from a young culture on agar (Sanarelli). $\times 1000$.

have some causal relationship to the disease. Sanarelli, in 1897, obtained cultures of an organism which he named bacillus icteroides, and which he considers to be the cause of yellow fever. It is not identical with the "bacillus x," the latter being a variety of *B. coli*.

This organism has rounded ends, is 2-4 μ long, about .5 μ broad, often occurring in pairs (Fig. 155), staining by the ordinary stains but decolorising by Gram's method. It is motile and possesses four to eight flagella. It grows on all the usual media; on gelatin plates after twenty-four hours the colonies are minute points somewhat transparent to the naked eye, and under a low power have a finely granular appearance. After six or seven days there appears somewhere in the colony a focus of more active growth, forming an opaque centre, from which granular striæ radiate to the periphery. The gelatin is not liquefied. The most characteristic growth is that on sloped agar. After twenty-four hours at 37° C. there is a grey iridescent and somewhat transparent growth. On being transferred to a temperature of 20° C. to 28° C. this becomes in twelve hours surrounded by a halo of white, opaque, pearly growth of higher level than the central part. In a few days the growth at the lower temperature becomes liquid in character and runs slowly down the medium as a drop of melted paraffin would do (Fig. 156). Growth also takes place in bouillon and blood serum. On potatoes there is a fine transparent pellicle which does not alter its colour with age. Litmus milk is rendered faintly acid, the cream-ring turning gradually blue, and after a lapse of several days the acid reaction of the medium gives place slowly to an alkaline change; no coagulation occurs. The bacillus ferments glucose, but not lactose or saccharose. It occasionally gives a feeble indol reaction.

Sanarelli investigated twelve cases of yellow fever and found the *B. icteroides* present in relatively small numbers in six. It appeared chiefly in the capillaries of the liver and kidneys, rarely in other parts of the body. It was never found in the gastro-intestinal tract.

Inoculation experiments did not give characteristic results, but Sanarelli states that sterile bouillon cultures, when injected subcutaneously or intravenously in man, give rise to all the symptoms of yellow fever.

According to Sanarelli's view the bacillus is to be looked on as settling chiefly in the liver and kidneys and there producing very powerful toxins whose chief effects are on the cells of these organs and on the small blood-vessels of the body, thus causing the rupture of vessel walls which frequently results, and opening up a path for infection by other organisms which may produce secondary infections. Sanarelli states that the serum of yellow-fever patients clumps the *B. icteroides* in a dilution of 1:40. The reaction is said to appear on the second day.

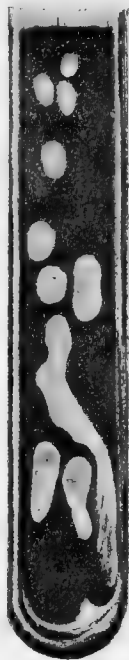

FIG. 156. — Culture of *Bacillus icteroides* on agar, showing the characteristic appearance when incubated at the two temperatures mentioned (Sanarelli). Natural size.

The results of Sanarelli were certainly striking, but they have not been confirmed by recent observations. Of the investigators immediately following Sanarelli, some stated that they found the *B. icteroides* in a certain proportion of cases, whilst others obtained negative results.

Reed and Carroll regard this organism as identical with the bacillus of hog cholera; and culturally, it parallels the growth characteristics of *B. enteritidis* (Gaertner).

2. *The Mosquito Theory.* — The most extensive and carefully planned inquiry into the etiology of yellow fever has been that of the United States Army Commission (1900-1), and the result of their labours has been the bringing forward of an entirely new order of facts. In the first place, they failed to find the *B. icteroides* in the blood of patients suffering from the disease; in twenty-four cases blood was withdrawn from a vein and cultures made on various media with negative result. Yet they found that a small quantity of such blood (.5-2 c.c.), when injected into a healthy subject, was sufficient to produce the disease. Furthermore, in three instances they found that the blood serum of a yellow-fever patient, diluted and passed through a Berkefeld filter, still retained its pathogenic properties, but it was found that if the pure or diluted serum, either filtered or unfiltered, were heated for ten minutes at 55° C. and injected in quantities of 1.5 c.c., it was perfectly innocuous.

From this result, and from the negative result of microscopic examination, they surmised that the virus was not one of the ordinary bacteria and was probably ultra-microscopic in nature.¹ The next important conclusion arrived at was that the disease is not communicable by direct contact with those suffering from the disease, with their fomites, etc. In a specially constructed house seven men were exposed to the most intimate contact with the fomites of yellow-fever patients for a period of twenty days each, the soiled garments worn by the patients being in some instances actually slept in by these men; the result was that not one of those thus exposed contracted the disease. By far the most important result of this investigation, however, is the establishment of the part played by mosquitoes in the transmission of the disease. Of twelve non-immune persons who

¹ In several diseases the existence of such causal factors is suspected. The other examples are foot-and-mouth disease, South African horse-sickness, and the contagious pleuro-pneumonia of cattle.

voluntarily allowed themselves to be bitten with mosquitoes which had previously fed on the blood of yellow-fever patients, ten took the disease, the period of incubation being from three to six days. Two of the men who were thus infected had been previously exposed to contact with fomites without result. The species of mosquito found capable of carrying the infection in this way is the *Stegomyia fasciata*. It was found that a period of about twelve days must elapse after the insect bites a patient suffering from yellow fever before it becomes infective to another subject, and, on the other hand, that it retains the power of infection for nearly sixty days later. These results have been confirmed by Guitéras, whose investigation was carried out along similar lines; of seventeen individuals bitten by the infected stegomyia, eight took yellow fever and of these three died.

As yet nothing has been determined by these workers regarding the nature of the virus, but the results already obtained have supplied the basis for preventive measures against the disease, these being directed towards the destruction of mosquitoes and the protection of those suffering from yellow fever, and also the healthy, against the bites of these insects. Already a striking degree of success has been obtained in Havana. Such measures came into force in February, 1901, and in ninety days the town was free of yellow fever and for fifty-four days later no new cases occurred. And although subsequently the disease was reintroduced into the town, no difficulty was experienced in stamping it out by the same measures. It would be unsafe, as yet, to generalise from this particular instance, but there is a good prospect that at least a measure of similar success will be attained in other places.

CHAPTER XX.

IMMUNITY.

Introductory. — By immunity is meant non-susceptibility to a given disease or to a given organism, either under natural conditions or under conditions experimentally produced. The term is also used in relation to the toxins of an organism. Immunity may be possessed by an animal naturally, and is then usually called *natural* immunity, or it may be *acquired* by an animal either by passing through an attack of the disease or by artificial means of inoculation. It has been shown that certain diseases affect the lower animals but never occur in the human subject, *e.g.* swine plague; and, on the other hand, diseases such as typhoid fever and cholera do not under natural conditions affect any of the lower animals, so far as is known. That is to say, man and the lower animals respectively enjoy immunity against certain diseases, when exposed to infection under ordinary conditions. From this fact, however, it does not follow that when the organisms of the respective diseases are introduced into the body by artificial methods of inoculation, pathological effects will not follow. We have seen above, for example, that the organisms of cholera and typhoid may artificially be made to infect guinea-pigs, though they do not do so naturally. Immunity may thus be of very varying degrees, and accordingly the use of the term has a correspondingly relative significance. Such a thing as absolute immunity is scarcely known, just as we have seen in the case with absolute susceptibility. This is not only true of infection by bacteria, but of toxins also; — when the resistance of an animal to these is of high degree, the resistance may be overcome by a very large dose of the toxic agent. For example, the common fowl may be able to resist as much as 20 c.c. of powerful tetanus toxin, but on this amount being exceeded may be affected by tetanic spasms (Klemperer). On the other hand, in cases where the natural powers of resistance

are very high, these can be still further exalted by artificial means, that is, the natural immunity may be artificially intensified.

Acquired Immunity in the Human Subject. — The following facts are supplied by a study of the natural diseases which affect the human subject. First, in the case of certain diseases, one attack protects against another for many years, sometimes practically for a lifetime, *e.g.* smallpox, typhoid, scarlet fever, etc. Secondly, in the case of other diseases, *e.g.* erysipelas, diphtheria, influenza, and pneumonia, a patient may suffer from several attacks. In the case of the diseases of the second group, however, experimental research has shown that in many of them a certain degree of immunity does follow; and, though we cannot definitely state it as a universal law, it must be considered highly probable that the passing through an attack of an acute disease produced by an organism, confers immunity for a longer or shorter period. The immunity is not, however, to be regarded as the result of the disease *per se*, but of the bacterial products introduced into the system; as will be shown below, by suitable gradation of the doses of such products, or by the use of weakened toxins, a high degree of immunity may be attained without the occurrence of any symptoms whatever.

The facts known regarding vaccination and smallpox exemplify another principle. We may take it as practically proved that vaccinia is variola or smallpox in the cow, and that when vaccination is performed, the patient is inoculated with a modified variola (*vide* Smallpox, in Appendix). Vaccination produces certain pathogenic effects which are of trifling degree as compared with those of smallpox, and we find that the degree of protection is less complete and lasts a shorter time than that produced by the natural disease. Again, inoculation with lymph from a smallpox pustule produces a form of smallpox less severe than the natural disease but a much more severe condition than that produced by vaccination, and it is found that the degree of protection or immunity resulting occupies an intermediate position. The corresponding general conclusion from experiments is that the more virulent the organism injected, provided that the animal recovers satisfactorily, the higher is the degree of immunity acquired by it against that organism. Thus in developing immunity of the highest degree the most virulent organisms

are ultimately employed. A corresponding principle, with certain restrictions (*vide* p. 471), obtains in the case of toxins.

Immunity and Recovery from Disease.— Recovery from an acute infective disease shows that in natural conditions the virus may be exhausted after a time, the period of time varying in different diseases. How this is accomplished we do not yet fully know, but it has been found in the case of diphtheria, typhoid, cholera, pneumonia, etc., that in the course of the disease certain substances (called by German writers *Antikörper*) appear in the blood, which are antagonistic either to the toxin or to the vital activity of the organism. In such cases a process of immunisation would appear to be going on during the progress of the disease, and when this immunisation has reached a certain height, the disease naturally comes to an end. It cannot, however, be said as yet that such antagonistic substances are developed in all cases; and it is by no means the case that the degree of immunity (active) is always proportional to the amount of these substances in the blood.

ARTIFICIAL IMMUNITY.

Varieties.— A number of facts regarding immunity have been given in the description of the pathogenic organisms in previous chapters. We shall here give a general systematic description of the methods, and discuss the principles involved. According to the means by which it is produced, immunity may be said to be of two kinds, to which the terms *active* and *passive* are generally applied, or we may speak of immunity *directly*, or *indirectly produced*. We shall first give an account of the established facts, and afterwards discuss some of the theories which have been brought forward in explanation of these facts.

Active immunity is obtained by (*a*) injections of the organisms either in an attenuated condition or in sub-lethal doses, or (*b*) by sub-lethal doses of their products, *i.e.* of their "toxins," the word being used in the widest sense. By repeated injections at suitable intervals the dose of organisms or of the products can be gradually increased; or, what practically amounts to the same, an organism of greater virulence or a toxin of greater strength may be used. A proportionate degree of resistance or immunity can thus be developed, which degree in course of time

may reach a very high level. Such a method can be *preventive*, but it can never be curative, as the immunity must be developed before the onset of the disease. Immunity of this kind is comparatively slowly produced and lasts a considerable time, the duration varying in different cases.

Passive immunity depends upon the fact that if an animal be immunised to a very high degree by the previous method, its serum may have distinctly antagonistic or neutralising effects when injected into another animal along with the organisms, or with their products, as the case may be. Here the serum of the highly immunised animal may confer immunity on another animal, if introduced at the same time as infection occurs or even a short time afterwards; the method can, therefore, be employed as a *curative agent*. The serum is also preventive, *i.e.* protects an animal from subsequent infection, but the immunity thus conferred lasts a comparatively short time. These facts form the basis of serum therapeutics. When such a serum has the power of neutralising a toxin it is called *antitoxic*; when, with little or no antitoxic power, it protects against the living bacterium in a virulent condition, it is called *antimicrobic* or *antibacterial* (*vide infra*).

In the accompanying table a sketch of the chief methods by which an immunity may be artificially produced is given. It has been arranged for purposes of convenience and to aid subsequent description, and it is not to be inferred that all the different methods imply essentially different principles. There is still some doubt as regards the relation of A 2, for example, to A 1 and A 3. It will presently be seen that in the production of immunity it is to be noted that the method to be chosen usually depends on the individual organism against which immunity is to be conferred. Thus the injection of diphtheria bacilli will immunise both against subsequent infection by bacilli and against the injection of diphtheria toxin, and immunisation by diphtheria toxin will have a similar effect.

ARTIFICIAL IMMUNITY.

- A. Active Immunity—*i.e.* produced in an animal by an injection, or by a series of injections, of non-lethal doses of an organism or its toxins.

1. *By injection of the living organisms.*

(a) Attenuated in various ways. Examples:—

(1) By growing in the presence of oxygen, or in a current of air.

(2) By passing through the tissues of one species of animal (becomes attenuated for another species).

(3) By growing at abnormal temperatures, etc.

(4) By growing in the presence of weak antiseptics, or by injecting the latter along with the organism, etc.

(b) In a virulent condition, in non-lethal doses.

2. *By injection of the dead organisms.*3. *By injection of filtered bacterial cultures, i.e. toxins; or of chemical substances derived from these.*

These methods may also be combined in various ways.

B. *Passive Immunity* — *i.e.* produced in one animal by injection of the serum of another animal highly immunised by the methods of A.1. *By antitoxic serum, i.e.* the serum of an animal highly immunised against a particular toxin.2. *By antibacterial serum, i.e.* the serum of an animal highly immunised against a particular bacterium in the living and virulent condition.A. *Active Immunity.*

1. **By Living Cultures.** — (a) *Attenuated.* — In the earlier work on immunity in the case of anthrax, chicken cholera, swine plague, etc., the methods consisted in the employment of cultures of the living organisms, the virulence of which was so diminished that on inoculation they did not produce a fatal disease, but yet had effects sufficient for protection. The principle is therefore the same as that of vaccination, and the attenuated cultures are often spoken of as *vaccines*. The virulence of an organism may be diminished in various ways, of which the following examples may be given.

(1) In the first place, practically every organism, when cultivated for some time outside the body, loses its virulence, and in the case of some this is very marked indeed, *e.g.* the pneumococcus. Pasteur found in the case of chicken cholera, that

when cultures were kept for a long time in ordinary conditions, they gradually lost their virulence, and that when sub-cultures were made, the diminished virulence persisted. Such attenuated cultures could be used for protective inoculation. He considered the loss of virulence to be due to the action of the oxygen of the air, as he found that in tubes sealed in the absence of oxygen the virulence was not lost. Haffkine attenuated cultures of the cholera spirillum by growing them in a current of air (p. 421).

(2) The virulence of an organism for a particular animal may be lessened by passing the organism through the body of another animal. Duguid and Burdon Sanderson found that the virulence of the anthrax bacillus for bovine animals was lessened by being passed through guinea-pigs, the disease produced in the ox by inoculation from the guinea-pig being a non-fatal one. This discovery was confirmed by Greenfield, who found that the bacilli cultivated from guinea-pigs preserved their property in cultures, and could therefore be used for protective inoculation of cattle. A similar principle was applied in the case of swine plague by Pasteur, who found that if the organism producing this disease was inoculated from rabbit to rabbit, its virulence was increased for rabbits but was diminished for pigs. Organisms which had been passed through a series of rabbits produced in the pig illness, but not death, and protection for at least a year resulted. The method of vaccination against smallpox depends upon the same principle.

(3) Many organisms become diminished in virulence when grown at an abnormally high temperature. The method of Pasteur, already described (p. 315), for producing immunity in sheep against anthrax bacilli, depends upon this fact. A virulent organism may also be attenuated by being exposed to an elevated temperature which is insufficient to kill it. Toussaint at an early date obtained protective inoculation against anthrax by means of cultures which had been exposed for a certain time to a temperature of 55° C., though it is possible that in some cases the bacilli were really killed, and immunity resulted from the chemical substances in the bacilli or produced by them.

(4) Still another method may be mentioned, namely, the attenuation of the virulence by growing the organism in the presence of weak antiseptics. Chamberland and Roux, for example, succeeded in attenuating the anthrax bacillus by grow-

ing it in a medium containing carbolic acid in the proportion of 1 : 600. The virulence may also sometimes be attenuated by injecting certain chemical substances along with the bacteria into the body. Iodine terchloride was found by Behring to modify in this way the virulence of the diphtheria bacillus.

These examples will serve to show the principles underlying attenuation of the virulence of an organism. There are, however, still other methods, most of which consist in growing the organism in conditions somewhat unfavourable to its growth, *e.g.* under compressed air, etc.

(*b*) *By living Virulent Cultures in Non-lethal Doses.* — Immunity may also be produced by employing virulent cultures in small, that is non-lethal, doses. In subsequent inoculations the doses may be increased in amount. For example, immunity may thus be obtained in rabbits against the bacillus pyocyaneus. Such a method, however, has had a limited application in the case of virulent organisms, as it has been found more convenient to commence the process by attenuated cultures.

Exaltation of the Virulence. — The converse process to attenuation, *i.e.* the exaltation of the virulence, is obtained chiefly by the method of cultivating the organism from animal to animal — the method of *passage* discovered by Pasteur (first, we believe, in the case of an organism obtained from the saliva in hydrophobia, though having no causal relationship to that disease). This is most conveniently done by intraperitoneal injections, as there is less risk of contamination. The organisms in the peritoneal fluid may be used for the subsequent injection, or a culture may be made between each inoculation. The virulence of a great number of organisms can be increased in this way, the animals most frequently used being rabbits and guinea-pigs. This method can be applied to the organisms of typhoid, cholera, pneumonia, to streptococci, and staphylococci, and in fact to those organisms generally which invade the tissues.

The virulence of an organism, especially when in a relatively attenuated condition, can also be raised by injecting along with it a quantity of a culture of another organism either in the living or dead condition. A few examples may be mentioned. An attenuated diphtheria culture may have its virulence raised by being injected into an animal along with the streptococcus pyogenes; an attenuated culture of the bacillus of malignant

oedema by being injected with the bacillus prodigiosus; an attenuated streptococcus by being injected with the bacillus coli, etc. A culture of the typhoid bacillus may be increased in virulence, as already stated, by being injected along with a dead culture of the bacillus coli. In such cases the accompanying injection enables the attenuated organism to gain a foothold in the tissues, and it may be stated as a general rule that the virulence of an organism for a particular animal is raised by its growing in the tissues of that animal.

Combination of Methods. — The above methods may be combined in various ways. By repeated injections of cultures at first attenuated and afterwards more virulent, and by increasing the doses, a high degree of immunity may be obtained. This is well exemplified in the case of Haffkine's method of anti-cholera inoculation (p. 421).

2. Immunity by Dead Cultures of Bacteria. — In some cases a high degree of immunity against infection by a given microbe may be developed by repeated and gradually increasing doses of the dead cultures, the cultures being killed sometimes by heat, sometimes by exposure to the vapour of chloroform. Some consider that in this method only the intracellular toxic substances of the organism are introduced when the cultures have been taken from the surface of a solid medium, such as agar, but as the surface is moist, some of the extracellular products must be present also. The cultures when dead produce, of course, less effect than when living, and this method may be conveniently used in the initial stages of active immunisation, to be afterwards followed by injections of the living cultures. The method is extensively used for experimental purposes, and is that adopted in anti-plague and anti-typhoid inoculations.

3. Immunity by the Separated Bacterial Products or Toxins. — The organisms in a virulent condition are grown in a fluid medium for a certain time, and the fluid is then filtered through a Chamberland or other porcelain filter. The filtrate contains the toxins, and it may be used unaltered, or may be reduced in bulk by evaporation, or may be evaporated to dryness. The process of immunisation by the toxin is started by small, non-lethal doses of the strong toxin, or by larger doses of toxin the power of which has been weakened by various methods (*vide infra*). Afterwards the doses are gradually increased. Im-

munity produced in this way is effective not only against the toxin, but also against large doses of the virulent organism in a living condition. This method was carried out with a great degree of success in the case of diphtheria, tetanus, malignant œdema, etc. It appears capable of very general application, though, in the case of many organisms, it is difficult to get a very active toxin from the filtered cultures. It has also been applied in the case of snake poisons by Calmette and Fraser, and a high degree of immunity has been produced.

Immunity may also be obtained by means of certain chemical substances separated from filtered bacterial cultures, though these substances are generally in a more or less impure condition. Hankin was the first to obtain this result by means of an albumose separated from anthrax cultures.

Though, as already stated, none of these methods can be used directly as curative agents, seeing that they imply previous treatment before exposure to infection, yet they supply the means of developing a very high degree of immunity, which is the first stage in the production of an active curative serum.

The following may be mentioned as some of the most important examples of the practical application of the principles of active immunity, *i.e.* of protective inoculation: (1) Inoculation of sheep and oxen against anthrax (Pasteur) (p. 315); (2) Jennerian vaccination against smallpox (p. 501); (3) Anti-cholera inoculation (Haffkine) (p. 421); (4) Anti-plague inoculation (Haffkine) (p. 444); (5) Anti-typhoid inoculation (Wright and Semple) (p. 346); (6) Pasteur's method of inoculation against hydrophobia, which involves essentially the same principles.

Active Immunity by Feeding.— Ehrlich found that mice could be gradually immunised against ricin and abrin by feeding them with increasing quantities of these substances (*vide* p. 177). In the course of some weeks' treatment in this way the resulting immunity was of so high a degree that the animals could tolerate 400 times the dose originally fatal by subcutaneous inoculation. Fraser also found in the case of snake poison that rabbits could be immunised, by feeding with the poisons, against several times the lethal dose of venom injected into the tissues.

By feeding animals with dead cultures of bacteria or with their separated toxins, a certain degree of immunity may in certain cases be gradually developed. But this method is so

much less certain in results, and so much more tedious than the others, that it has obtained no practical applications.

Active immunity of high degree developed by the methods described may be regarded as *specific*, that is, is exerted only toward the organism or toxin by means of which it has been produced. A certain degree of immunity, or rather of increased general resistance of parts of the body (for example the peritoneum), can, however, be produced by the injection of various substances — bouillon, blood serum, solution of nuclein, etc. (Issaëff). Also increased resistance to one organism can be thus produced by injections of another organism. Immunity of this kind, however, never reaches a high degree.

B. *Passive Immunity.*

Action of the Serum of highly Immunised Animals. — 1. The serum of an animal A, treated by repeated and gradually increased doses of the toxin of a particular microbe, may protect an animal B against a certain amount of the same toxin when injected along with the latter, or a short time before it. As would be expected, it has less effect when injected some time afterwards, but even then within certain limits it has a degree of curative or palliative power. Seeing that the serum of animal A appears to neutralise the toxin, the term *antitoxic* has been applied to it.

2. The serum of an animal A, highly immunised against a microbe by repeated and gradually increasing doses of the living organism, protects an animal B against an infection by the living organism when injected under conditions similar to the above. This serum is therefore *antimicrobial*, or antibacterial, or preventive against invasion by a particular organism. When spoken of in relation to the bacterium by means of which it has been prepared, a serum is usually called *homologous*; in relation to any other bacterium, *heterologous*.

In a considerable number of instances, an antimicrobial serum has been found to possess little effect against the toxin — that is, to possess little or no antitoxic power. This fact, if taken alone, would leave it still doubtful whether the difference between the two kinds of sera were one of quality or one merely of quantity. It has, however, been shown in many cases that an antimicrobial serum has a distinct action on the vital activity of the

corresponding bacterium, and may even produce alteration in its structure. It is manifest that such a serum differs fundamentally in its point of attack, so to speak, from an antitoxic serum. And it is to be noted that the 'nature of the serum corresponds in a wonderful way with the requirements of the organism, that is, is antitoxic in such diseases as diphtheria and tetanus where toxic action is at its maximum, and bactericidal where the rapid multiplication of the bacteria in the tissues is the outstanding feature. It must not be supposed, however, that a serum must be purely antitoxic or purely antibacterial according to the method by which it is prepared. For example, an antitoxic serum can be obtained by injecting living diphtheria bacilli into the tissues of an animal, the antitoxic property being in all probability developed by means of toxins formed by the bacilli within the body. Having given this explanation, we shall consider the two kinds of serum separately.

Antitoxic Serum. — The best examples are the antitoxic sera of diphtheria and tetanus, though similar principles and methods are involved in the preparation of the sera protective against ricin and abrin, and against snake poison. We shall here speak of diphtheria and tetanus. The steps in the process of preparation may be said to be the following: First, the preparation of a powerful toxin. Second, the estimation of the power of the toxin. Third, the development of antitoxin in the blood of a suitable animal by gradually increasing doses of the toxin. Fourth, the estimation from time to time of the antitoxic power of the serum of the animal thus treated.

1. *Preparation of the Toxin.* — The mode of preparation and the conditions affecting the development of diphtheria toxin have already been described (p. 366). In the case of tetanus the growth takes place in glucose bouillon under an atmosphere of hydrogen (*vide* p. 63). In either case the culture is filtered through a Chamberland filter when the maximum degree of toxicity has been reached. The term "toxin" is usually applied for convenience to the filtered (*i.e.* bacterium-free) culture.

2. *Estimation of the Toxin.* — The power of the toxin is estimated by the subcutaneous injection of varying amounts in a number of guinea-pigs, and the minimum dose which will produce death is thus obtained. This, of course, varies in proportion to the weight of the animal, and is expressed accordingly. In the

case of diphtheria, in Ehrlich's standard, the minimum lethal dose — known as M.L.D. — is the smallest amount which will certainly cause death in a guinea-pig of 250 grms. within four days. Behring uses the term "normal diphtheria toxin of simple strength" (DTN¹), as indicating a toxin of which .01 c.c. is the minimum lethal dose under these conditions. A toxin of which the minimum lethal dose is .02 will be of half normal strength (DTN⁵); and so on. The testing of a toxin directly is a tedious process, and in actual practice, where many toxins have to be dealt with, it is found more convenient to test them by finding how much will be neutralised by a certain amount of a standard antitoxic serum, viz., an "immunity unit" (p. 472).

3. *Development of Antitoxin.* — The earlier experiments on tetanus and diphtheria were performed on the small animals, such as guinea-pigs, but afterwards the sheep and the goat were used, and finally horses. In the case of the small animals it was found advisable to use in the first stages of the process either a weak toxin or a powerful toxin modified by certain methods. Such methods are the addition to the toxin of tetrachloride of iodine (Behring and Kitasato), the addition of Gram's iodine solution in the proportion of one to three (Roux and Vaillard), and the plan, adopted by Vaillard in the case of tetanus, of using a series of toxins weakened to varying degrees by being exposed to different temperatures, viz., 60°, 55°, and 50° C. The toxin is at first injected into the subcutaneous tissues, the dose being gradually increased according to the results of the toxin injected. As pointed out by Behring, immunisation proceeds best when each injection produces a reaction in the form of localised inflammatory swelling; in other words, the dose should be as large as possible, so long as general injurious effects are not produced. Later, when large doses of toxin injected subcutaneously are well borne, the toxin is injected directly into the jugular vein of the animal. Ultimately 300 c.c., or more, of active diphtheria toxin thus injected may be borne by a horse, such a degree of resistance being developed after the treatment has been carried out for two or three months. In all cases of immunising the general health of the animal ought not to suffer. If the process is pushed too rapidly the antitoxic power of the serum may diminish instead of increasing, and a condition of marasmus may set in and may even lead to

the death of the animal. (In immunisation of small animals an indication of their general condition may be obtained by weighing them from time to time.)

4. *Estimating the Antitoxic Power of, or "standardising," the Serum.*—This is done by testing the effect of various quantities of the serum of the immunised animal against a certain amount of toxin. Various standards have been used, of which the two chief are that of Ehrlich and that of Roux. Ehrlich has adopted as the *immunity unit* the amount of antitoxic serum which will neutralise 100 times the minimum lethal dose of toxin, serum and toxin being mixed together, diluted up to 4 c.c. and injected subcutaneously. A "normal" antitoxic serum is one of which 1 c.c. contains an immunity unit. Owing to the difficulty of estimating the occurrence of local infiltration at the site of injection, the prevention of the death of the animal within four days is used as the sole indication of neutralisation,—death later or loss of weight and local infiltration being neglected. As a standard in testing, Ehrlich employs quantities of serum of known antitoxic power in a dry condition, preserved in a vacuum in a cool place, and in the absence of light. A thoroughly dry condition is ensured by having the glass bulb containing the dried serum connected with another bulb containing anhydrous phosphoric acid. Thus 1 c.c. of a serum of which .02 c.c. will protect from 100 times the lethal dose, will possess 50 immunity units, and 20 c.c. of this serum 1000 immunity units. Sera have been prepared of which 1 c.c. has the value of 800 units or even more.

Roux adopts a standard which represents the animal weight in grammes protected by 1 c.c. of serum against the dose of virulent bacilli lethal to a control guinea-pig in thirty hours, the serum being injected twelve hours previously. Thus, if .01 c.c. of a serum will protect a guinea-pig of 500 grms. against the lethal dose, 1 c.c. (1 grm.) will protect 50,000 grms. of guinea-pig, and the value of the serum will be 50,000.

During the process of development of antitoxin a small quantity of the blood of the animal is withdrawn from time to time, and the antitoxic power tested in the manner described above. After a sufficiently high degree of antitoxic power has been reached the animal is bled under aseptic precautions, and the serum is allowed to separate in the usual manner. It is then ready for use, but some weak antiseptic, such as .5 per cent

carbolic acid, is usually added to prevent its decomposing. Other antitoxic sera are prepared in a corresponding manner. Some further facts about antitetanic serum are given on page 389.

Use of Antitoxic Sera.—In all cases the antitoxic serum ought to be injected as early in the disease as possible, and in large doses. In the case of diphtheria 1500 immunity units of antitoxic serum was the amount first recommended for the treatment of a bad case, but the advisability of using larger doses has gradually become more and more evident. Sidney Martin recommends that as much as 4000 units should be administered at once, and that if necessary this quantity should be repeated. A strong serum prepared by Behring contains 3000 units in 5–6 c.c., but even stronger serum may be obtained. Even very large doses of antitoxic serum are without any harmful effects beyond the occasional production of urticarial and erythematous rashes. Where large quantities of serum require to be administered, as is always the case with antitetanic serum, injections must be made at different parts of the body; preferably not more than 20 c.c. should be injected at one place. The immunity conferred by injection of antitoxic serum lasts a comparatively short time, usually a few weeks at longest.

Sera of Animals immunised against Vegetable and Animal Poisons.—It was found by Ehrlich in the case of the vegetable toxins, ricin and abrin, and also by Calmette and Fraser in the case of the snake poisons, that the serum of animals immunised against these respective substances had a protective effect when injected along with them into other animals. Ehrlich found, for example, that the serum of a mouse which had been highly immunised against ricin by feeding as described above, could protect another mouse against forty times the fatal dose of that substance. He considered that in the case of the two poisons, antagonistic substances — “anti-ricin” and “anti-abrin” — were developed in the blood of the highly immunised animals. A corresponding antagonistic body, to which Fraser has given the name “antivenin,” appears in the blood of animals in the process of immunisation against snake poison.

These investigations are specially instructive, as these vegetable and animal poisons, both as regards their local action and the general toxic phenomena produced by them, present, as we have seen, an analogy to various toxins of bacteria.

Nature of Antitoxic Action. — We have to consider here two points, viz., (a) the relation of antitoxin to toxin, and (b) the source of the antitoxin. With regard to the former subject there has been much diversity of opinion. Some observers consider that the antagonism between toxin and antitoxin depends upon a chemical union between the two substances, whilst others consider that it is of a physiological nature, the antitoxin acting through the medium of the cells of the organism. The bulk of evidence recently brought forward is, however, strongly in favour of the view that the two bodies unite *in vitro* to form a compound inert towards the living tissues, there being in the toxin molecule an atom-group which has a specific affinity for the antitoxin molecule or part of it. We shall consider the facts in favour of this view, and in doing so we must also take into account the anti-sera of the vegetable toxins, of snake poisons, etc.

When toxin and antitoxin are brought together *in vitro* it can be proved that their behaviour towards each other resembles what is observed in a simple chemical union. It is of course to be kept in view that the only test of the neutralisation of the toxin by the antitoxin is that when the resultant mixture is injected into a susceptible animal no symptoms occur. As in chemical union, a definite period of time elapses before the neutralisation of the toxin is complete. Other points of resemblance to simple chemical union are found in the facts that neutralisation takes place more rapidly in strong solutions than in weak, and that it is hastened by warmth and delayed by cold. It has been found that if these factors be taken into account and a standard toxin of definite strength be employed, a toxin can be titrated against an antitoxin with corresponding accuracy to what obtains in the case of an acid and an alkali. C. J. Martin and Cherry and also Brodie have shown that in the case of diphtheria toxin and in that of an Australian snake poison the toxin molecules will pass through a colloid membrane (p. 174), whilst those of the corresponding antitoxin will not. Now if a mixture of equivalent parts of toxin and antitoxin is freshly prepared and at once filtered, a certain amount of toxin will pass through, but the longer such mixtures are allowed to stand before filtration the less toxin passes, till a time is reached when no toxin is found in the filtrate. Further, if the portion of fluid which at this stage has not passed through the filter be injected

into an animal, no symptoms take place. This shows that after a time neutralisation is complete. These facts are practically conclusive in favour of toxin neutralisation depending upon a chemical union, and such a view would also throw light on the otherwise somewhat puzzling fact that while, *e.g.* by lapse of time, the toxicity of a toxin may become diminished, it may still require the same proportion of antitoxin to neutralise it as it did before. On the chemical theory this, according to Ehrlich, is due to the disintegration of the toxophorous atom-group of the toxin molecule (*vide* pp. 179, 478), while the combining (haptophorous) group still remains unaltered. Quite analogous cases could be cited from pure chemistry.

The evidence usually brought forward against the chemical union of toxin and antitoxin rests chiefly on certain observations of Buchner and of Calmette, and to these a reference must be made. Buchner, in a series of experiments, came to the conclusion that it was possible to make a mixture of tetanus toxin and antitoxin which was neutral to the mouse, but which could produce a fatal result in guinea-pigs. It is to be noted, however, that the mixture used in his experiments was not quite neutral to mice, and this circumstance, along with the fact that the guinea-pig, weight for weight, is more susceptible to this toxin than the mouse, may explain the result. In any case these experiments as they stand cannot be considered to constitute a real objection. Calmette found that the antitoxin to snake venom was more easily destroyed by heat than the toxin, and stated that when a neutral mixture of the two was heated at a temperature sufficient to destroy free antivenin, the toxic properties in part returned. Hence he concluded that the two bodies existed in an uncombined condition in the mixture. Martin and Cherry, however, on repeating these experiments, found that the above result was not obtained if sufficient time for complete combination was allowed; but if this precaution was not taken, then the presence of the free toxin was revealed when the antitoxin was destroyed by heat. Even, however, if Calmette's results were quite correct, they cannot be considered to constitute a proof that chemical union does not occur: they would only prove that the toxin has not been destroyed. If two complicated chemical compounds of unequal stability are in loose chemical union, it is quite conceivable that the less stable may be destroyed (*e.g.* by heat) whilst the more stable escapes.

The next question to be considered is the *source* of antitoxin. The following three possibilities present themselves: (*a*) antitoxin may be formed from the toxin, *i.e.* may be a "modified toxin"; (*b*) antitoxin may be the result of an increased formation of molecules normally present in the tissues; (*c*) antitoxin may be an entirely new product of the cells of the body. It can now be stated that antitoxin is not a modified toxin. It has been shown,

for example, that the amount of antitoxin produced by an animal may be many times greater than the equivalent of toxin injected ; and further, that when an animal is bled the total amount of antitoxin in the blood may some time afterwards be greater than it was immediately after the bleeding, even although no additional toxin is introduced. This latter circumstance shows antitoxin is *formed* by the cells of the body. If antitoxin is a product of the cells of the body, we are almost compelled, on theoretical grounds, to conclude that it is not a newly manufactured substance, but a normal constituent of the living cells which is produced in increased quantity. We have, however, direct evidence of the presence of antitoxin under normal conditions, — the presence of such being shown by its uniting with toxin and rendering it inert. Normal horse serum, to mention an example, may have a varying amount of antitoxic action to the diphtheria poison, ox-bile has a similar action to snake poison, whilst in the case of other anti-substances — such as agglutinins, bacteriolysins, hæmolysins, etc. — whose production is governed by the same laws, numerous examples might be given. It is, however, rather to the protoplasm of living cells than to the serum that we must look for evidence of antitoxins. In the first place, we have evidence that in the living body bacterial toxins enter into combination with, or, as it is often expressed, are fixed by the tissues — presumably by means of certain combining affinities. This has been shown by the experiments of Dönitz and of Heymans with tetanus toxin. We have, however, no evidence as to where the toxin is fixed in such cases beyond that supplied by the occurrence of symptoms. Another line of research which has been followed is to bring emulsions of various organs into contact with a given toxin and observe whether any of the toxicity is removed. This was first carried out by Wassermann and Takaki, who investigated the action of emulsions of the central nervous system of the susceptible guinea-pig on tetanus toxin. They found in this way that the nervous system contained bodies which had a neutralising effect on the toxin. For example, it was shown that 1 c.c. of emulsion of brain and spinal cord was capable of protecting a mouse against ten times the fatal dose of toxin. These observations have been confirmed, though their significance has been variously interpreted. It would, however, be out of place to discuss at length the opposing views, and we

accordingly simply state the facts ascertained. We may note, however, that it is not a serious objection that in certain animals other tissues than that of the central nervous system can combine with tetanus toxin — this might take place with or without resulting symptoms; the important fact is that in the nervous system certain molecules have an affinity for the toxin.

It will be seen from what has been stated with regard to the relation of toxin and antitoxin, that the fixation of toxin by the tissues leads up theoretically to the possible production of antitoxin. In other words, the substance which, when forming part of the cells, fixes the toxin and thus serves as the means of poisoning, may act as an antitoxin when free in the blood. This will be discussed below in connection with Ehrlich's theory of passive immunity.

We may conclude this portion of the subject by saying that (1) *it is practically proved that antitoxin acts as such by combining with toxin*, and (2) *antitoxin is probably represented by molecules normally present in the cells or (more rarely) in the fluids of the body*.

Within recent years a large number of anti-substances have been obtained against substances other than toxins. As examples we may mention *precipitins*, which are produced by the injection of the serum of another animal, and which produce an opacity when added to that serum; various *anti-ferments*, e.g. anti-rennet, anti-coagulins, also anti-complements (*vide* p. 482). All these act in a manner corresponding to antitoxins; for instance, the addition of anti-rennet to milk prevents the latter being curdled by rennet. Their production is apparently governed by the same laws.

Of the *chemical nature of antitoxins* we know little. From their experiments C. J. Martin and Cherry deduce that while toxins are probably of the nature of albumoses, the antitoxins probably have a molecule of greater size, and may be allied to the globulins. Hiss and Atkinson have also come to the conclusion that antitoxin belongs to the globulins. They found that the precipitate with magnesium sulphate from anti-diphtheria serum contained practically all the antitoxin, and that any substance obtained which had an antitoxic value gave all the reactions of a globulin. They also found that the percentage amount of globulin precipitated from the serum of the horse

increased after it was treated in the usual way for the production of antitoxin. Such a supposed difference in the sizes of the molecules might explain the fact, observed by Fraser and also by C. J. Martin, that antitoxin is much more slowly absorbed when introduced subcutaneously than is the case with toxin.

Antitoxin, when present in the serum, leaves the body by the various secretions, and in these it has been found, though in much less concentration than in the blood. It is present in the milk, and a certain degree of immunity can be conferred on animals by feeding them with such milk, as has been shown by Ehrlich, Klemperer, and others. Klemperer also found traces of antitoxin in the yolk of eggs of hens whose serum contained antitoxin. Bulloch also found in the case of hæmolytic sera (*vide infra*) that the anti-substance ("immune-body") is transmitted from the mother to the offspring.

The Evidence for Ehrlich's Theory of the Constitution of Toxins.— This was found in the course of investigations on diphtheria toxin, and so far applies only to the extracellular toxins. Ehrlich found that, taking an antitoxin standardised against one toxin, it did not follow that it would neutralise exactly the same number of M.L.D. of other toxins. Thus an amount which would neutralise 100 M.L.D. of one, might neutralise only 20 of another and perhaps 130 of a third. The second fundamental observation was as follows: If a mixture of toxin and antitoxin behaved like a mixture of say hydrochloric acid and sodium hydrate, then the addition to a neutral mixture of 1 M.L.D. would, if the mixture were injected into a guinea-pig, cause death. In none of the toxins investigated was this the case; sometimes as many as 28 M.L.D. had to be thus added before death occurred. A third fact observed was that in the case of one toxin when freshly filtered the M.L.D. was found to be .003 c.c.; nine months later it was .009 c.c., but it was found that after the lapse of this period one antitoxin unit neutralised exactly the same amount of toxin as at first. In other words, one antitoxin unit when the toxin was fresh neutralised 100.2 M.L.D., and nine months later only 33.4 M.L.D., and care had been taken that the antitoxin itself had not changed. The theory to account for these facts is that the ultimate toxin molecule contains two unsatisfied affinities, one of which can combine with antitoxin, the other having a toxic action; the former Ehrlich calls the "haptophorous" group, the latter the "toxophorous" (*vide p. 179*). Further, each of these groups can, under the action of light, oxidation, etc., lose a certain amount of combining power, the toxophorous being more easily weakened than the haptophorous (these weakened toxins Ehrlich calls "toxoids" or "toxones"). Now, the above facts can be explained if crude diphtheria toxin contains both of these substances, *i.e.* true toxin with powerful haptophorous and toxophorous affinities, and toxoid with slightly weakened haptophorous group and greatly weakened toxophorous group. Take the second fundamental observation alluded to.

In the original neutral mixture of crude toxin and antitoxin, both toxin and toxoid were present. Any fresh crude toxin added contains both toxin and toxoid. Some of the fresh toxin turns out some of the toxoid, and thus being put out of action there is not enough poisonous material to cause death if only one M.L.D. has been added to the neutral mixture. What remains when the rearrangement of molecules has taken place is not toxin *plus* toxoid, but toxoid *plus* toxoid.

Antibacterial Serum. — The stages in the preparation of antibacterial sera correspond to those in the case of antitoxic sera, but living, or, in the early stages, dead cultures, are used instead of toxin separated by filtration, and in order to obtain a serum of high antibacterial power a very virulent culture in large doses must be ultimately tolerated by the animal. For this purpose a fairly virulent culture is obtained fresh from a case of the particular disease, and its virulence may be further increased by the method of *passage*. This method of obtaining a high degree of immunity against the microbe is specially applicable in the case of those organisms which invade the tissues and multiply to a great extent within the body, and of which the toxic effects, though always existent, are proportionately small in relation to the number of organisms present. The method has been applied in the case of the typhoid and cholera organisms, the bacillus of bubonic plague, the bacillus coli communis, the pneumococcus, streptococcus (Marmorek), and many others. In fact, it seems capable of very general application.

The important result obtained by such experiments is, that if an animal be highly immunised by the method mentioned, the development of the immunity is accompanied by the appearance in the blood of *protective* substances, which can be transferred to another animal. The law enunciated by Behring regarding immunity against toxins thus holds good in the case of the living organisms, as was first shown by Pfeiffer. The latter found, for example, that in the case of the cholera organism, so high a degree of immunity could be produced in the guinea-pig, that .002 c.c. of its serum would protect another guinea-pig against ten times the lethal dose of the organisms, when injected along with them. Here again is presented the remarkable potency of the antagonising substances in the serum, which in this case lead to the destruction of the corresponding microbe.

The *antistreptococcic serum* of Marmorek may be briefly

described, as it has come into extensive practical use. This observer found that he could intensify the virulence of a streptococcus by growing it alternately in the peritoneal cavity of a guinea-pig and in a mixture of human blood serum and bouillon (*vide* p. 46). The virulence became so enormously increased by this method, that when only one or two organisms were introduced into the tissues of a rabbit a rapidly fatal septicæmia was produced. Streptococci of this high degree of virulence were used first by subcutaneous, afterwards by intravenous, injection, to develop a high degree of resistance in the horse. Injections were continued over a considerable period of time, and the protective power of the serum was tested by mixing it with a certain dose of the virulent organisms, and then injecting into a rabbit. The serum of a horse highly immunised in this way constitutes the antistreptococcic serum which has been extensively used with success in many cases of streptococcic invasion in the human subject.¹ Marmorek, however, found that this serum had little antitoxic power, that is, could only protect from a comparatively small dose of toxin obtained by filtration of cultures.

Anti-typhoid, anti-cholera,² anti-pneumococcic, anti-plague, and other sera are all prepared in an analogous manner.

Properties of Antibacterial Serum. — Within recent years it has been shown that an antibacterial serum, in addition to being protective, may sometimes also present important objective reactions against the corresponding organism, and these are of high importance, as they afford valuable aid in the study of the nature of the preventive power. Of such actions the two chief are the *lysogenic* and the *agglutinative*.

Lysogenic Action. — Pfeiffer found that if certain organisms, *e.g.* the cholera spirillum, were injected into the peritoneal cavity of a guinea-pig highly immunised against these organisms they lost their motility almost immediately, gradually became granular and swollen up in places into droplets, and then disappeared in the fluid, all these changes sometimes occurring within half an hour — lysogenic action. Further, he found that the same

¹ Results in general are now considered not to be as satisfactory as was at first supposed from the earlier reports of the use of this serum.

² A true *antitoxic* cholera serum has been prepared by Metchnikoff, E. Roux, and Taurelli-Salimbeni.

phenomenon was witnessed if a minute quantity of the anti-serum was added to a certain quantity of the organisms, and the mixture injected into the peritoneal cavity of another animal. In both cases the organisms die an extracellular death, and their destruction is brought about by the medium of a specific substance in the anti-serum. Pfeiffer found that the serum of convalescent cholera patients gave the same reaction as that of immunised animals. He obtained the same reaction also in the case of the typhoid bacillus and other organisms. From his observations he concluded that the reaction was specific, and could be used as a means of distinguishing organisms which resemble one another. He also found that an anti-serum heated to 70° C. for an hour produced the reaction when injected with the corresponding organisms into the peritoneum of a fresh animal. He considered that the specific substance in the serum existed chiefly in an inert and somewhat stable form, and that it became actively bactericidal by the aid of living cells, probably those of the peritoneal endothelium. Metchnikoff, however, showed that lysogenesis occurred when the bacteria were simply placed in some fresh peritoneal fluid to which the anti-serum had been added outside the body, and Bordet showed that the serum of a fresh animal could be substituted for peritoneal fluid with the same result. The latter observer also found that in some cases the anti-serum alone, if used quite fresh, could produce *in vitro* the destruction of the bacteria. In these cases, accordingly, the action of the endothelial cells was excluded. Bordet found that in every case in which Pfeiffer's reaction took place within the body of an animal, a similar lysogenic reaction could be observed by his method outside the body.

His method was the following: (*a*) An emulsion of the living organisms (for example, of the cholera vibrio) was made by adding a young culture to about 5 c.c. of bouillon; (*b*) two drops of this emulsion were taken, and mixed with a small drop of anti-cholera serum; (*c*) a drop of this mixture was taken, and there was added to it a drop of equal size of fresh serum from a normal guinea-pig. A hanging-drop preparation was made, and a change similar to that described by Pfeiffer was observed within one to two hours if the preparation was kept at the temperature of the body.

The outcome of the research with regard to lysogenic action may be said to be the following. In order to produce the occurrence of the phenomena, two substances are necessary. One is

specially developed during the process of immunisation, and gives the anti-serum its special character; it is usually known as the immune-body (Ehrlich) or *substance sensibilisatrice* (Bordet). It is comparatively resistant to heat, and can usually be subjected to 65° C. for an hour without being destroyed. It is apparently the protective substance, as an anti-serum does not lose its protective power when heated to the temperature mentioned. It, however, cannot produce bacteriolysis alone, but requires for this another substance present in normal serum. This latter is more labile, being readily destroyed at 65° C., and even by half an hour at 55° C.; it is known by various names—addiment or complement (Ehrlich), alexine or cytase (French writers). We shall speak of the two substances just described as “immune-body” and “complement” respectively. The laws of lysogenesis are, however, not peculiar to the case of solution of bacteria by the fluids of the body, but, as has been shown within the last few years, hold also in the case of other organised substances, red corpuscles, leucocytes, etc., when these are introduced into the tissues of an animal as in a process of immunisation. Of such sera the hæmolytic have been most fully studied, and have been the means of throwing much light on the process of lysogenesis, and thus on one part of the subject of immunity. A short account of their properties may now be given.

Hæmolytic and other Sera.—It has been known for some time that in some instances the blood serum of one animal has, in certain degree, the power of dissolving the red corpuscles of another animal of different species; in other instances, however, this property cannot be detected. Bordet showed that if one animal were treated with repeated injections of the corpuscles of another, the serum of the former acquired a marked hæmolytic property towards the corpuscles of the latter, the property being demonstrated when the serum is added to the corpuscles. A mixture of five parts of defibrinated blood, which of course contains the corpuscles, and ninety-five parts of .75 per cent chloride of sodium solution is used, and to this varying quantities of the hæmolytic serum are added and allowed to stand for some time at a warm temperature, usually for one hour at 37° C. Bordet also found that the hæmolytic property disappeared when the hæmolytic serum was heated at 55° C., but was regained on the subsequent addition of

some serum from a fresh (*i.e.* non-treated) animal. These observations have been fully confirmed, and it may be stated that in each case the hæmolytic property is "practically specific," *i.e.* is exerted only towards the corpuscles used in the injections; moreover, by the injection of corpuscles from more than one species of animal, a serum with multiple hæmolytic properties may be obtained. Ehrlich and Morgenroth analysed the phenomena in question, and showed that the specially developed and heat-resisting substance, "immune-body," entered into combination with the red corpuscles at a comparatively low temperature. This was shown by adding the heated serum to the red corpuscles in salt solution (of course no hæmolysis occurs), and after some time centrifugalising the mixture. On separating the corpuscles it was found that the hæmoglobin was set free on the addition of some serum from a fresh animal; it was also found that the immune-body was absent from the clear fluid. In other words, the red corpuscles fix or become combined with the immune-body. In a corresponding manner they came to the conclusion that the immune-body combined with the complement (in normal serum), though the combination was less firm and only occurred at a higher temperature—best about 37° C. They therefore consider that the immune-body acts as a sort of connecting link between the red corpuscle and the complement. Bordet, on the other hand, holds that the immune-body acts merely as a sensitising agent—hence the term *substance sensibilisatrice*—and allows the ferment-like complement to act. Regarding the important fact that in the case of each anti-serum of this group a special immune-body is developed, and that the laws of hæmolysis are identical with those of bacteriolysis, practically all are agreed. It is a disputed point whether there are several distinct complements in a normal serum with different relations to different immune-bodies, for which Ehrlich and his co-workers have brought forward a large amount of evidence, or whether, as Bordet holds, there is a single complement, which may, however, show slight variations in behaviour towards different immune bodies. Workers of the French school also hold that complement does not exist in the free condition in the blood, but is liberated from the leucocytes when the blood is shed; though this cannot be held as proved, there is evidence that the amount of free complement in-

creases after the blood is shed and some time later gradually diminishes.

In addition to hæmolytic sera, anti-sera have been obtained by the injection of leucocytes, spermatozoa, ciliated epithelium, liver cells, nervous tissue, etc. The laws governing the production and properties of these are identical, that is, each serum exhibits a specific property towards the body used in its production — *i.e.* dissolves leucocytes, immobilises spermatozoa, etc. It may also be mentioned that each anti-serum usually exhibits toxic properties towards the animal whose cells have been used in the injections, *e.g.* a hæmolytic serum may produce a fatal result, with signs of extensive blood destruction, hæmoglobinuria, etc., *i.e.* it is hæmotoxic for the particular animal; a serum prepared by injection of liver cells has been found to produce on injection necrotic changes in the liver in the species of animal whose liver cells were used. These are mentioned as examples of a very large group of specific activities.

With regard to the sites of origin of immune-bodies our information is still very deficient. Pfeiffer and Marx brought forward evidence in the case of typhoid, and Wassermann in the case of cholera, that the immune-bodies are chiefly formed in the spleen, lymphatic glands, and bone-marrow. According to certain workers of the French school, the chief source of sera acting on cells such as red blood corpuscles is the large mononucleated leucocytes, whilst sera acting on bacteria are chiefly derived from the polymorpho-nuclear leucocytes. The active bodies in the former are by these observers sometimes spoken of as "*macrocytases*," those of the latter as "*microcytases*." Another view is that immune-bodies are chiefly formed by the large mononucleated leucocytes, whilst complements are products of the polymorpho-nuclears. That these cells are concerned in the production of antagonistic and protective substances is almost certain, though another possible source of wide extent, *viz.*, the endothelium of the vascular system, has been largely overlooked. As yet, definite statements cannot be made on this point.

Agglutination. — Charrin and Roger in 1889 observed that when the bacillus *pyocyaneus* was grown in the serum of an animal immunised against this organism, the growth formed a deposit at the foot of the vessel; whereas a growth in normal

serum produced a uniform turbidity. Gruber and Durham, in investigating Pfeiffer's reaction, discovered an analogous phenomenon. They found that when a small quantity of the serum of an animal highly immunised against a particular motile organism (cholera vibrio, typhoid bacillus, etc.) is added to an emulsion of the organisms, the latter lose their motility and become agglutinated into clumps. In a small test-tube a reaction in this way occurs which is visible to the naked eye, a sort of precipitate forming which consists of masses of the bacteria. Non-motile organisms also may be agglutinated by the corresponding serum, as may also red corpuscles by a hæmolytic serum. As a rule, the higher the degree of immunity the smaller is the amount of serum necessary to produce agglutination. The phenomenon depends upon the presence of definite bodies in the serum called *agglutinins*. In each case these can only clump a certain amount of bacteria, and are used up in the process, apparently by a combination with the bacteria, probably attended with a physical change in the envelopes of the latter, and this Gruber and Durham consider forms the essential part of Pfeiffer's reaction.

The observations just described have led to the discovery of the method of serum diagnosis of disease, which has been applied especially to typhoid fever, as already detailed (*vide* p. 340). It had been already found that the serum of convalescents from typhoid fever could protect animals to a certain extent against typhoid fever, and, in view of the facts experimentally established, it appeared a natural proceeding to inquire whether such serum possessed an agglutinative action and at what stage of the disease it appeared. The result, obtained independently by Grünbaum and Widal, but first published by the latter, was to show that the serum possessed this specific action long before the cure of the disease, in fact shortly after infection had taken place. It is probable that it depends upon a process of immunisation developing from an early stage of the disease. Agglutination is also observed in the case of cholera, Malta fever, bacillary dysentery, glanders, plague, infection by Gaertner's bacillus, *B. coli*, etc.

The physical changes on which agglutination depends cannot as yet be said to be fully understood. As stated above, Gruber and Durham considered that the agglutinin produced a change

in the envelope of the bacterium, causing it to swell up and become viscous, and there are certain facts in favour of this view. On the other hand, this is probably not the full explanation, as it has been shown by Nicolle and by Kruse that if an old bacterial culture be filtered through porcelain, the addition of some of the corresponding serum produces some change in it, so that even minute inorganic particles become aggregated into clumps. The phenomenon would thus appear to be the result of the interaction of the agglutinin and some substance in the bacterial cell (which substance evidently leads to the development of the agglutinin in the living body); and, as Duclaux states, is closely allied to a process of coagulation. Of greater importance, however, is the relationship of agglutination to immunity. Gruber and Durham considered that agglutination was the essential part of Pfeiffer's reaction or lysogenesis, the change produced in the bacteria allowing the bactericidal action naturally possessed by the serum to come into play. Others, again, consider that the two are independent of one another. The fact that the agglutinative power appears early in an infective disease is often pointed to as proof of such a view. This line of reasoning is not, however, by itself conclusive, as we must suppose that the reaction, or series of reactions, leading to immunity begins at an early period and gradually increases until cure results. It is also to be noted that agglutinins accord with protective substances as regards resistance to heat (*i.e.* a serum heated to 55° C. loses its bactericidal or lysogenic power while the agglutinative and protective properties remain, *vide* p. 482). On the other hand, a serum may be highly protective without being agglutinative, and when the two properties are present together they do not always run in the same proportion. It is doubtful, however, whether a serum ever possesses a *high* degree of agglutination without having some protective power. On the whole it seems safe to say that agglutinins and immune-bodies, though not necessarily identical, are the products of corresponding reactive processes, and their formation is governed by corresponding laws. The bacterial cell, containing as it does various complicated organic constituents, may cause the formation of more than one anti-substance, and each of these has a combining affinity for part of the bacterial body. Agglutination is most probably to be regarded as a phenomenon prejudicial to the corresponding

bacterium, and thus in nature to be allied with the process of immunisation.

Besides those stated above, other phenomena have been observed in the interaction of anti-sera and the corresponding bacteria. For example, it has been shown that when certain bacteria — *e.g.* the typhoid bacillus, *B. coli*, and *B. proteus* — are grown in bouillon containing a small proportion of the homologous serum, their morphological characters may be altered, growth taking place in the form of threads or chains which are not observed in ordinary conditions. In other instances a serum may inhibit some of the vital functions of the corresponding bacterium.

Summary with regard to Anti-sera. — In a former chapter it has been shown that in the production of disease by bacteria there are two main factors concerned, *viz.*, the multiplication of the living organisms in the tissues and the production by them of toxins. The facts which have been stated above show that in the blood serum of highly immunised animals there are present substances of remarkable potency which may act against either of these two factors. In the first place, a serum may protect against the separated toxin, or, in other words, may be *antitoxic*. In the second place, a serum may lead to the destruction of the organisms; the term *antibacterial* is, therefore, conveniently applied to such a serum. In many instances an antibacterial serum has little or no effect against the toxins. The action of both varieties of anti-sera is, within certain limits, specific, being exerted only against the particular organism or toxin which has been used in its preparation, having a definite value which can be ascertained by experiment. It does not follow from what has been said that a serum may not act in both of the ways described. A given serum might, for example, be powerfully antibacterial and feebly antitoxic at the same time.

It is specially to be noted that anti-sera are not peculiar to the case of bacteria and their toxins, but constitute a large group, the characteristic features of which, in general terms, are, that they are produced by the injection of complicated organic substances, either in solution or as formed elements. This group may be conveniently divided into two great classes. In one of these the characteristic effect is apparently due to one substance acting alone, whilst in the other this effect requires for its com-

pletion substances normally present in the serum (complements). Antitoxic sera belong to the first group, antibacterial sera to the second. In all, however, the substance specifically developed appears to have a combining affinity for the substance introduced into the body — toxin, albumin, bacterium, animal cell, etc., as the case may be.

Therapeutic Effects of Anti-sera. — As will have been gathered, the chief human diseases treated by anti-sera are diphtheria, tetanus, streptococcus infection, pneumonia, plague, and snake bite. Of the results of such treatment most is known in the case of diphtheria. Here a very great diminution in the mortality has resulted. The diphtheria antitoxin came into general use about October, 1894, and the statistics published by Behring towards the end of 1895 indicate results which have since been confirmed. In the Berlin Hospitals the average mortality for the years 1891–93 was 36.1 per cent, in 1894 it was 21.1 per cent, and in January–July, 1895, 14.9 per cent. The objection that in some epidemics a very mild type of disease prevails is met by the fact that similar diminutions of mortality have occurred all over the world. Loddo collected the results of 7000 cases in Europe, America, Australia, and Japan, in which the mortality was 20 per cent as compared with a former mortality in the same hospitals of 44 per cent. It has also been observed that if during an epidemic the supply of serum fails, the mortality at once rises; and in two instances recorded it was doubled. It must here be remembered that from the spread of bacteriological knowledge the diagnosis of diphtheria is now much more accurate than formerly. Another effect of the antitoxic treatment has been that when tracheotomy is necessary the percentage of recoveries is now much higher, being 73 per cent instead of 27 per cent in a group of cases collected by the American Pediatric Society. In the London fever hospitals since 1894 the recoveries after tracheotomy have been 56.4 as compared with 32.1 per cent previous to the introduction of antitoxin. One of the most striking results obtained in the same hospitals is a reduction of the death-rate in post-scarlatinal diphtheria from 50 per cent to between 4 per cent and 5 per cent. As the disease here occurs while the patient is under observation the treatment is nearly always begun on the first day. It is a matter of prime importance that the treatment should be commenced whenever the disease is

recognised. Behring showed that in cases treated on the first and second days of the disease the mortality was only 7.3 per cent, and this has been generally confirmed, whilst after the fifth day it was of little service to apply the treatment. In order to obtain such results it cannot be too strongly insisted on that attention should be given to the dosage. When bad results are obtained it may be strongly suspected that this precaution has not been observed. In the treatment of acute tetanus by the antitoxin the improvement in results has not been marked, but some chronic cases have been benefited. In the case of Yersin's anti-plague serum, though benefit has appeared to follow its use, experience with its effects has been too limited to enable a judgment to be formed. The same may be said to be true of the antistreptococcic and antipneumonic sera, and also of anti-venin, though in the case of the first mentioned numerous cases of apparently successful result have been recorded.

As has been shown above, antibacterial sera require for their complete action a sufficiency of complements, and as these diminish in amount when a serum is kept, the unsatisfactory results with this class of sera may be due to a deficiency of complement. Or it may be as Ehrlich has suggested, that the complement naturally existing in human serum does not suit the immune-body in the anti-serum. There is no doubt, however, that this question of complements is one of importance, and will, in all probability, be cleared up in the further development of research on this subject.

Theories as to Acquired Immunity.

The advances made within recent years in our knowledge regarding artificial immunity and the methods by which it may be produced have demonstrated the insufficiency of various theories which had been propounded. Only a short reference need be made to these. The *theory of exhaustion*, with which Pasteur's name is associated, supposed that in the body of the living animal there are substances necessary for the existence of a particular organism, which become used up during the sojourn of that organism in the tissues; this pabulum being exhausted, the organisms die out. Such a supposition is, of course, quite disproved by the facts of passive immunity. According to the *theory of retention*, the bacteria within the body were considered

to produce substances which are inimical to their growth, so that they die out, just as they do in a test-tube culture before the medium is really exhausted. Such a theory only survives now in the view that antitoxins are modified toxins, the evidence against which has already been discussed (p. 475). There then came the *humoral theory* and the *theory of phagocytosis*, but neither of these is tenable in its pure form, and the distinction between them need not be maintained. For on the one hand, any substance with specific property in the serum must be the product of cellular activity, and on the other hand, the facts with regard to passive immunity go far beyond the ingestive and digestive properties of phagocytes, though these cells may be in part the source of important bodies in the serum. At the present time interest centres around two theories, viz., Ehrlich's side-chain theory and Metchnikoff's phagocytic theory as further developed. These will now be discussed, and it may be noted that the ground covered by each is not coextensive. For the former deals chiefly with the production of anti-substances and its biological significance, the latter deals with the defensive properties of cells, either directly by their phagocytic activity or indirectly by substances produced by them after the manner of digestive ferments. It will be seen, however, that each has a normal process as its basis, viz., that of nutrition.

1. **Ehrlich's Side-chain Theory.** — This may be said to be an application of his views regarding the nourishment of protoplasm. A molecule of protoplasm (in the general sense) may be regarded as composed of a central atom-group (*Leistungskern*) with a large number of side-chains (*Seitenketten*), *i.e.* atom groups with combining affinity for food-stuffs. It is by means of these latter that the living molecule is increased in the process of nutrition; and hence the name *receptors* given by Ehrlich is on the whole preferable. These receptors are of two chief kinds: the first has a single unsatisfied combining group and fixes molecules of simpler constitution — receptor of the first order; the second has two such groups, one for the food molecule and another which fixes a ferment in the fluid medium around — receptor of the second order or *amboceptor*. These latter receptors come into action in the case of larger food molecules which require to be broken up by ferment action for the purposes of the cell economy. In considering the application of this idea to the

facts of passive immunity, it must be kept in view that all the substances for which anti-substances have been obtained are, like proteids, of unknown but undoubtedly of very complex chemical constitution, and that in apparently every case the anti-substance enters into combination with its corresponding substance. The dual constitution of toxins and kindred substances, as already described (p. 477), is also of importance in this connection. Now when toxins are introduced into the system they are fixed, like food-stuffs, by their haptophorous groups to the receptors of the cell protoplasm. If they are in sufficiently large amount the toxophorous part of the toxin molecule produces that disturbance of the protoplasm which is shown by symptoms of poisoning. If, however, they are in smaller dose, as in the early stages of immunisation, fixation to the protoplasm occurs in the same way; and as the combination of receptors with toxin is supposed to be of firm nature, the receptors are lost for the purposes of the cell, and the combination R.-T. (receptor + toxin) is shed off into the blood. The receptors thus lost become replaced by new ones, and when additional toxin molecules are introduced, these new receptors are used up in the same manner as before. As a result of this repeated loss the regeneration of the receptors becomes an over-regeneration, and the receptors formed in excess appear in the free condition in the blood stream and then constitute antitoxin molecules. So that these receptors which, when forming part of the cell protoplasm, anchor the toxin to the cell, and thus are essential to the occurrence of toxic phenomena, in the free condition unite with the toxin and thus the toxin can no longer combine with the cells and exert a pathogenic action. *Antitoxin molecules are thus free receptors of the first order.* A corresponding explanation applies to the origin of antibacterial and like sera. The molecules of bacterial bodies, of stromata of red corpuscles, etc., act as unsuitable food-stuffs to the cells and use up the receptors which combine with them. These molecules are chemically of larger size than the toxin molecules, and the corresponding receptors are those which can also fix a ferment. *The immune bodies of antibacterial, hæmolytic, and other like sera are thus free receptors of the second order.* Ehrlich does not state what cells are specially concerned in the production of anti-substances, but from what has been stated it is manifest that any cell which fixes a toxin molecule, for example, is potentially

a source of antitoxin. Cells, to whose disturbance, resulting from the fixation of toxin, characteristic symptoms of poisoning are due, will thus be sources of antitoxin, *e.g.* cells of the nervous system in the case of tetanus, though the cells not so seriously affected by toxin fixation may act in the same way.

When we come to consider how far Ehrlich's theory is in harmony with known facts, we find that there is much in its favour. In the first place, it explains the difference between active and passive immunity, *e.g.* difference in duration, etc.; in the former the cells have acquired the habit of discharging anti-substances, in the latter the anti-substances are simply present as the result of direct transference. It is also in harmony with the action of antitoxins, etc., as detailed above, and especially it affords an explanation of the multiplicity of anti-substances. For, if we take the case of antitoxins, we see that this depends upon the combining affinity of the toxin for certain of the cells of the body, and this again is referred back to the complicated constitution of living protoplasm. Furthermore, the biological principle involved is no new one, being simply that of over-regeneration after loss.

It is to be noted, however, that it does not explain active immunity apart from the presence of anti-substances in the serum. For example, an animal may be able to withstand a much larger amount of toxin than could be neutralised by the total amount of antitoxin in its serum. It is difficult to see what condition of the receptors of the cells would explain such a fact, and the question arises whether there may not be really an increased resistance of the cells to the toxoporous affinities. Further, when the serum of an animal contains a large amount of antitoxin, how does the toxin reach the cells in order to influence them as we know it does? This is difficult to understand unless the toxin has a greater affinity for the receptors in the cells than for the free receptors (antitoxin) in the serum. A supersensitiveness of the nerve cells of an animal to tetanus toxin, sometimes observed even when there is a large amount of antitoxin in the serum, has been often brought forward as an objection. But this also may perhaps be explained by there having occurred a partial damage of the cell protoplasm by the toxoporous action in the process of immunisation — an explanation which, of course, demands that in some way the freshly

introduced toxin may reach the cells in spite of the antitoxin in the blood. Further investigation alone will settle these and various other disputed points. At present we may say, however, that Ehrlich's theory is the only one which even attempts to explain the cardinal facts of this aspect of immunity.

2. **The Theory of Phagocytosis.**— This theory, brought forward by Metchnikoff to explain the facts of natural and acquired immunity, has been of enormous influence in stimulating research on the subject. Looking at the subject from the standpoint of the comparative anatomist, he saw that it was a very general property possessed by certain cells throughout the animal kingdom, that they should take up foreign bodies into their interior and in many cases digest and destroy them. On extending his observations to what occurred in disease, he came to the conclusion that the successful resistance of an animal against bacteria depended on the activity of certain cells called phagocytes. In the human subject he distinguished two chief varieties, namely (*a*) the microphages, which are the "polymorpho-nuclear," finely granular leucocytes of the blood, and (*b*) the macrophages, which include the larger hyaline leucocytes, endothelial cells, connective tissue corpuscles, and, in short, any of the larger cells which have the power of ingesting bacteria. Insusceptibility to a given disease is indicated by a rapid activity on the part of the phagocytes, different varieties being concerned in different cases, — an activity which may rapidly destroy the bacteria and prevent even local damage. If the organisms are introduced into the tissues of a moderately susceptible animal, there occurs an inflammatory reaction with local leucocytosis, which results in the intracellular destruction of the invading organisms. Phagocytosis is regarded by Metchnikoff as the essence of inflammation. He also showed that the bacteria may be in a living and active state when they are ingested by leucocytes. On the other hand, he found that in a susceptible animal phagocytosis did not occur or was only imperfect. He also showed that when a naturally susceptible animal was immunised, the process was accompanied by the appearance of an active phagocytosis. The ingestion of bacteria by phagocytes is undoubtedly a phenomenon of the greatest importance in the defence of the organism. It is known that amœbæ and allied organisms have digestive properties which

are specially active towards bacteria, and from what can be directly observed, as well as indirectly inferred, there can be no doubt that such a faculty is also possessed by the phagocytes of the body. Thus bacteria within these cells are in a position favourable to their destruction. It is manifest that chemiotaxis, which regulates the ingestion of bacteria, is a highly important factor. An animal whose leucocytes are attracted by the bacteria will be in a more favourable position than one in which this attraction does not obtain. In the process of immunisation of a susceptible animal we see a negative or neutral chemiotaxis becoming replaced by positive chemiotaxis. This is explained by Metchnikoff as due to an education or stimulation of the phagocytes. It is, however, difficult to see how they can be stimulated to move in a particular direction, viz., towards the bacteria, and it seems more likely that in the fluids of the immune animal the bacteria undergo some change by which they can exert a positive chemiotaxis. This is rendered the more likely by an experiment by Denys, in which he showed that in a hanging-drop preparation the rabbit's leucocytes behave indifferently towards pneumococci, whereas on the addition of some antipneumococcic serum they moved towards the pneumococci and ingested them. That the addition of the corresponding immune body can change the chemiotactic phenomena in this way can be readily shown in the case of red corpuscles.

The digestive ferments of phagocytes or *cytases* are, according to Metchnikoff, retained within the cells under normal conditions, but are set free when these cells are injured, for example, when the blood is shed. They then become free in the serum by the breaking up of the cells—the process known as phagolysis—and they then constitute the alexines, or complements of Ehrlich. Of these, as has already been said, he thinks there are probably two kinds—one called *macrocytase*, contained in the macrophages, which is specially active towards the formed elements of the animal body, protozoa, etc.; and the other, *microcytase*, contained within the polymorpho-nuclear leucocytes, which has a special digestive action on bacteria. It is the microcytase which gives blood serum its bactericidal properties.

When the properties of antibacterial sera, as above described, are considered in relation to phagocytosis, Metchnikoff gives

the following explanation. He admits that the immune-body is fixed by the bacteria (or red corpuscles, as the case may be), though he does not state that a chemical combination takes place; hence he calls it a fixative (*fixateur*). The immune-bodies are to be regarded as auxiliary ferments (*ferments adjuvants*) which aid the action of the alexine. Unlike the latter, however, they are formed in excess during immunisation and set free in the serum. He compares their action to that of enterokynase, a ferment which is produced in the intestine and aids the action of trypsin. Thus, when the bacteria have fixed the immune-body their digestion is facilitated either within the phagocytes, or outside of them when the alexine has been set free by phagolysis. He, however, maintains that extracellular digestion or lysogenesis does not take place without the occurrence of phagolysis. The source of immune-bodies is, in all probability, also the leucocytes, as they are specially abundant in organs rich in these cells—spleen, lymphatic glands, etc.; here again the mononuclear leucocytes are probably the source of the immune-bodies concerned in hæmolysis, the polymorphonuclear leucocytes the source of those concerned in bacteriolysis. Although the immune-bodies are usually set free in the serum, this is not always the case; sometimes they are contained in the cells, and this probably occurs when there is a high degree of active immunity against bacteria without the serum having an antibacterial action. In this way the facts of immunity can be explained so far as these concern the destruction of bacteria.

Metchnikoff's work has less direct bearing on the production of antitoxins. He admits the fixation of the toxin by the antitoxin to form a neutral compound, and he apparently considers that leucocytes may also be concerned in the production of antitoxins. Apart, however, from antitoxin formation, he considers the acquired resistance of the cells themselves of high importance in toxin immunity.

When we consider Metchnikoff's theory as thus extended to cover recently established facts, it must be admitted that it affords a rational explanation of a considerable part of the subject, provided that the changes in the chemiotactic phenomena during immunisation are fully elucidated. It, however, does not afford an explanation of the multiplicity and specificity of antitoxins as Ehrlich's does; on the other hand, it is

more concerned with the cells of the body as destroyers or digesters of bacteria. As regards the subject of antibacterial sera, the results of these two workers may be said to be in harmony in some of the fundamental conceptions. And it is of interest to note that Metchnikoff, starting with the phenomena of intracellular digestion, has arrived at the giving off of specific ferments by phagocytes; whilst Ehrlich, from his first investigations on the constitution of toxins, has arrived at an explanation of antitoxins and immune-bodies also with a theory of cell-nutrition as its basis. Within the last few years marked progress has thus been made towards the establishment of the fundamental laws of immunity.

NATURAL IMMUNITY.

We have placed the consideration of this subject after that of acquired immunity, as the latter supplies facts which indicate in what direction an explanation of the former may be looked for. There may be said to be two main facts with regard to natural immunity. The first is, that there is a large number of bacteria — the so-called non-pathogenic organisms — which are practically incapable, unless perhaps in very large doses, of producing pathogenic effects in any animal; when these are introduced into the body, they rapidly die out. This fact accordingly shows that the animal tissues generally have a remarkable power of destroying living bacteria. The second fact is, that there are other bacteria which are very virulent to some species of animals, whilst they are almost harmless to other species; the anthrax bacillus may be taken as an example. Now it is manifest that natural immunity against such an organism might be due to a special power possessed by an animal of destroying the organisms when introduced into its tissues. It might also, however, be due to an insusceptibility to, or power of neutralising, the toxins of the organism. For the study of the various diseases shows that the toxins (in the widest sense) are the weapons by which morbid changes are produced, and that toxin-formation is a property common to all pathogenic bacteria. There is, moreover, no such thing known as a bacterium multiplying in the living tissues without producing local or general changes, though, theoretically, there might be. We may infer from this that if the toxins are completely neutralised or ren-

dered powerless in the case of any animal, that animal will be immune against the particular organism. This is also borne out by the fact that immunity against a particular organism can be artificially obtained by injections of the toxins of that organism. As a matter of fact, however, natural immunity is in most cases one against *infection*, *i.e.* consists in a power possessed by the animal body of destroying the living bacteria when introduced into its tissues: such a power may exist though the animal is still susceptible to the separated toxins. We shall now look at these two factors separately.

1. *Variations in Natural Bactericidal Powers.*—The fundamental fact here is that a given bacterium may be rapidly destroyed in one animal, whereas in another it may rapidly multiply and produce morbid effects. The special powers of destroying organisms in natural immunity have been ascribed to (a) phagocytosis, and (b) the action of the serum.

(a) The chief factors with regard to phagocytosis have been given above. The bacteria in a naturally immune animal, for example, the anthrax bacillus in the tissues of the white rat, are undoubtedly taken up in large numbers and destroyed by the phagocytes, whereas in a susceptible animal this only occurs to a small extent; and Metchnikoff has shown that they are taken up in a living condition, and are still virulent when tested in a susceptible animal. The presence or absence of positive chemiotaxis is here also of great importance. The question, however, is whether these differences in chemiotaxis are not themselves capable of explanation. If they are, then the phagocytosis *per se* is rather the evidence of the presence of immunity than its real essence. An observation of Ehrlich's on hæmolytic sera is somewhat suggestive in this connection. The sera of some animals possess naturally, as above stated, a hæmolytic action on the blood corpuscles of others, and in the cases studied Ehrlich found that this was not due to complement (alexine) alone, but to complement aided by an intermediate body (*Zwischenkörper*), which behaves in an analogous way to the immune-body of an anti-serum. As already pointed out, bactericidal action closely corresponds with hæmolytic action, and it is quite possible that in a naturally immune animal some intermediate substance may be present which combines with the bacteria and thus produces some change which is evidenced

by their exerting a positive chemiotaxis on the leucocytes. Variations in phagocytic activity no doubt are found to correspond more or less closely with the degree of immunity present.

(b) When it had been shown that normal serum possessed bactericidal powers against different organisms, the question naturally arose as to whether this bactericidal power varied in different animals in proportion to the natural immunity enjoyed by them. The earlier experiments of Behring appeared to give grounds for the belief that this was the case. He found, for example, that the serum of the white rat, which has a remarkable immunity to anthrax, had greater bactericidal powers than that of other animals investigated. He found also that the serum of guinea-pigs immunised against the vibrio Metchnikovi had a bactericidal action, whereas in that of susceptible animals no such action was found. Further investigation, however, has shown that these are not examples of a general law, and that this bactericidal action of the serum does not vary *pari passu* with the degree of immunity. The bactericidal action of the serum was specially studied by Nuttall, and later by Buchner and Hankin, who believe that the serum owes its power to certain substances in it derived from the spleen, lymphatic glands, thymus, and other tissues rich in leucocytes. To these substances Buchner gave the name of *alexines*; as already explained, they correspond with Metchnikoff's *cystases* and Ehrlich's complements. These substances are somewhat unstable compounds, and are destroyed by the action of light, and also by a temperature of 60° C. They can be precipitated by alcohol and by ammonium sulphate, and correspond in their general behaviour with enzymes or unorganised ferments. Regarding the existence in the serum of bactericidal substances which are very easily destroyed by heat there can be no doubt, but their properties can only be studied outside the body, and it must not be assumed that the serum in such conditions has always the same property as in the living body. In some cases, for example, the bactericidal power of the serum *in vitro* has been found to be considerable, while the animal has no immunity. In such a case Metchnikoff says that there occurs in the living body no liberation of alexines by the phagocytes, and hence no bactericidal action such as occurs when the blood is shed. Variations in bactericidal power of the serum as tested

in vitro, therefore, do not explain the presence or absence of natural immunity against a living bacterium.

2. *Variations in Natural Susceptibility to Toxins.*—We must here start with the fundamental fact, incapable of explanation, that toxicity is a relative thing, or in other words, that different animals have different degrees of resistance or non-susceptibility to toxic bodies. In every case a certain dose must be reached before effects can be observed, and up to that point the animal has resistance. This natural resistance is found to present very remarkable degrees of variation in different animals. The great resistance of the common fowl to the toxin of the tetanus bacillus may be here mentioned; the high resistance of the pigeon to morphia is a striking example in the case of vegetable poisons. This variation in resistance to toxins applies also to those which produce local effects, as well as to those which cause symptoms of general poisoning. Instances of this are furnished, for example, by the vegetable poisons ricin and abrin, by the snake poisons, and by bacterial toxins such as that of diphtheria. We must take this natural resistance for granted, though it is possible that ere long it will be explained.

According to Ehrlich's view of the constitution of toxins, it might be due to the want of combining affinity between the tissue cells and the haptophorous group of the toxin; or, on the other hand, supposing this affinity to exist, it might be due to an innate non-susceptibility to the action of the toxophorous group. Certain investigations have been made in order to determine the combining affinity of the nervous system of the fowl with tetanus toxin, as compared with that obtaining in a susceptible animal, but the results have been somewhat contradictory. Accordingly, a general statement on this point cannot at present be made.

At present, therefore, the facts of natural immunity cannot be fully explained. In some cases the insusceptibility to toxic substances may explain the degrees of immunity possessed by different animals, whilst in others immunity is due to special bactericidal powers possessed by them. What these bactericidal powers really are cannot be explained on any single theory. A vital activity of the tissues and fluids is, no doubt, brought about by the presence of the bacteria, and this cannot

be fully imitated in experiments outside the body. The facts given above with regard to the action of antibacterial serum, show how complicated a matter the bactericidal process may be. Further, in natural immunity a direct killing of the organisms by the fluids of the serum is not necessary. It may be sufficient that their growth is prevented, so that they ultimately die out or are taken up by the phagocytes.

APPENDIX A.

SMALLPOX AND VACCINATION.

SMALLPOX is a disease to which much study has been devoted, owing, on the one hand, to the havoc which it formerly wrought among the nations of Europe—a havoc which at the present day it is difficult to realise,—and on the other hand, to the controversies which have arisen in connection with the active immunisation against it introduced by Jenner. Though there is little doubt that a *contagium vivum* is concerned in its occurrence, the etiological relationship of any particular organism to smallpox has still to be proved; and with regard to Jennerian vaccination, it is only the advance of bacteriological knowledge which is now enabling us to understand the principles which underlie the treatment, and which is furnishing methods whereby, in the near future, the vexed questions concerned will probably be satisfactorily settled. We cannot here do more than touch on some of the results of investigation with regard to the disease.

Jennerian Vaccination.—Up to Jenner's time the only means adopted to mitigate the disease had been by inoculation (by scarification) of virus taken from a smallpox pustule, especially from a mild case. By this means it was shown that in the great majority of cases a mild form of the disease was originated. It had previously been known that one attack of the disease protected against future infection, and that the mild attack produced by inoculation also had this effect. This inoculation method had long been practised in various parts of the world, and had considerable popularity all over Europe during the eighteenth century. Its disadvantage was that the resulting disease, though mild, was still infectious, and thus might be the starting-point of a virulent form among unprotected persons. Jenner's discovery was published when inoculation was still considerably practised. It was founded on the popular belief that those who had contracted cowpox from an affected animal were insusceptible to subsequent infection from smallpox. In the horse there occurs a disease known as horsepox, especially tending to arise in wet cold springs, which consists in an inflammatory condition about the hocks, giving rise to ulceration. Jenner believed that the matter from these ulcers, when transferred by the hands of men who

dressed the sores to the teats of cows subsequently milked by them, gave rise to cowpox in the latter. This disease was thus identical with horsepox, in epidemics of which it had its origin. Jenner was, however, probably in error in confounding horsepox with another disease of horses, namely, "grease." Cowpox manifests itself as a papular eruption on the teats; the papules become pustules; their contents dry up to form scabs, or more or less deep ulcers are formed at their sites. From such a lesion the hands of the milkers may become infected through abrasions, and a similar local eruption occurs, with general symptoms in the form of slight fever, malaise, and loss of appetite. It is this illness, which, according to Jenner, gives rise to immunity from smallpox infection. He showed experimentally that persons who had suffered from such attacks did not react to inoculation with smallpox, and further, that persons to whom he communicated cowpox artificially, were similarly immune. The results of Jenner's observations and experiments were published in 1798 under the title *An Inquiry into the Causes and Effects of the Variola Vaccinæ*. Though from the first Jennerian vaccination had many opponents, it gradually gained the confidence of the unprejudiced, and became extensively practised all over the world, as it is at the present day.

The evidence in favour of vaccination is very strong. There is no doubt that inoculation with lymph properly taken from a case of cowpox can be maintained with very little variation in strength for a long time by passage from calf to calf, and such calves are now the usual source of the lymph used for human vaccination. When lymph derived from them is used for the latter purpose, immunity against smallpox is conferred on the vaccinated individual. It has been objected that some of the lymph which has been used has been derived from calves inoculated, not with cowpox, but with human smallpox. It is possible that this may have occurred in some of the strains of lymph in use shortly after the publication of Jenner's discovery, but there is no doubt that most of the strains at present in use have been derived originally from cowpox. The most striking evidence in favour of vaccination is derived from its effects among the staffs of smallpox hospitals, for here, in numerous instances, it is only the unvaccinated individuals who have contracted the disease. While vaccination is undoubtedly efficacious in protecting against smallpox, Jenner was wrong in supposing that a vaccination in infancy afforded protection for more than a certain number of years thereafter. It has been noted in smallpox epidemics which have occurred since the introduction of vaccination, that whereas young unprotected subjects readily contract the disease, those vaccinated as infants escape more or less till after the thirteenth to the fifteenth years. It has become, therefore, more and more evident that revaccination is

necessary if immunity is to continue; and where this is done in any population, smallpox becomes a rare disease, as has happened in the German army, where the mortality is practically nil. The whole question of the efficacy of vaccination was investigated in Great Britain in 1896 by a Royal Commission, whose general conclusions were as follows. Vaccination diminishes the liability to attack by smallpox, and when the latter does occur, the disease is milder and less fatal. Protection against attack is greatest during nine or ten years after vaccination. It is still efficacious for a further period of five years, and possibly never wholly ceases. The power of vaccination to modify attack outlasts its power wholly to ward it off. Revaccination restores protection, but this operation must be from time to time repeated. Vaccination is beneficial according to the thoroughness with which it is performed.

The Relationship of Smallpox (*Variola*) to Cowpox (*Vaccinia*).—

This is the question regarding which, since the introduction of vaccination, the greatest controversy has taken place; a subsidiary point has been the inter-relationships within the group of animal diseases which includes cowpox, horsepox, sheep-pox, and cattle-plague. With reference to smallpox and cowpox the problem has been, Are they identical or not? There is no doubt that cowpox can be communicated to man, in whom it produces the eruption limited to the point of inoculation, and the slight general symptoms which vaccination with calf lymph has made familiar. Apparently against the view that cowpox is a modified smallpox are the facts that it never reproduces in man a general eruption, and that the local eruption is only infectious when matter from it is introduced into an abrasion. The loss of infectiveness by transmission through the body of a relatively insusceptible animal is a condition of which we have already seen many instances in other diseases, and the uniformity of the type of the affection resulting from vaccination with calf lymph finds a parallel in such a disease as hydrophobia, where, after passage through a series of monkeys, a virus of attenuated but constant virulence can be obtained. We have seen that there are good grounds for believing that the virus of calf lymph confers immunity against human smallpox. In considering the relationships of cowpox and smallpox, this is an important though subsidiary point; for at present it is questionable whether there are any well-authenticated instances of one disease having the capacity of conferring immunity against another. The most difficult question in this connection is what happens when inoculations of smallpox matter are made on cattle. Chauveau denies that in such circumstances cowpox is obtained. He, however, only experimented on adult cows. The transformation has been accomplished by many observers, including, in Britain, Simpson, Klein, Hime, and Copeman. The general result of these experi-

ments has been that if a series of calves is inoculated with variolous matter, in the first there may not be much local reaction, though redness and swelling appear at the point of inoculation, and some general symptoms manifest themselves. On squeezing some of the lymph from such reaction as occurs, and using it to continue the passages through other calves, after a very few transfers a local reaction indistinguishable from that caused by cowpox lymph generally takes place, and the animals are now found to be immune against the latter. Not only so, but on using for human vaccination the lymph from such variolated calves, results indistinguishable from those produced by vaccine lymph are obtained, and the transitory illness which follows, unlike that produced in man by inoculation with smallpox lymph, is no longer infectious. In fact many of the strains of lymph in use in Germany at present have been derived thus from the variolation of calves. The criticism of these experiments which has been offered, namely, that since many of them were performed in vaccine establishments, the calves were probably at the same time infected with vaccine, is not of great weight, as in all the recent cases at least, very elaborate precautions have been adopted against such a contingency. And at any rate it would be rather extraordinary that this accident should happen to occur in every case. We can, therefore, say that at present there is the very strongest ground for holding not only that vaccinia confers immunity against variola, but that variola confers immunity against vaccinia. The *experimentum crucis* for establishing the identity of the two diseases would of course be the isolation of the same micro-organism from both, and the obtaining of all the results just detailed by means of pure cultures or the products of such. In the absence of this evidence we are at present justified in considering that there is strong reason for believing that vaccinia and variola are the same disease, and that the differences between them result from the relative susceptibilities of the two species of animals in which they naturally occur.

With regard to the relation of cowpox to horsepox, it is extremely probable that they are the same disease. Some epidemics of the former have originated from the horse, but in other cases such a source has not been traced. Cattle-plague, from the clinical standpoint, and also from that of pathological anatomy, resembles very closely human smallpox. Though each of the two diseases is extremely infectious to its appropriate animal, there is no record of cattle-plague giving rise to smallpox in man or *vice versa*. When matter from a cattle-plague pustule is inoculated in man, a pustule resembling a vaccine pustule occurs, and further, the individual is asserted to be now immune to vaccination; but vaccination of cattle with cowpox lymph offers no protection against cattle-plague, though some have looked on the latter as merely a malig-

nant cowpox. Sheep-pox also has many clinical and pathological analogies with human smallpox, and facts as to its relation to cowpox vaccination similar to those observed in cattle-plague have been reported. Smallpox, cowpox, cattle-plague, horsepox, and sheep-pox, in short, constitute an interesting group of analogous diseases, of the true relationships of which to one another we are, however, still ignorant.

Micro-organisms associated with Smallpox. — Burdon Sanderson was among the first to show that in vaccine lymph there were certain bodies which he recognised as bacteria. Since then numerous observations have been made as to the occurrence of such in matter derived from variolous and vaccine pustules. In especially the later stages of the latter, many of the pyogenic organisms are always present, *e.g.* *staphylococcus aureus* and *staphylococcus cereus flavus*, and many of the ordinary skin saprophytes also are often present, but no organism has ever been isolated which on transference to animals has been shown to have any specific relationship to the disease. Klein, and also, independently, Copeman, have observed an organism in lymph taken from a vaccine pustule in a calf on the fifth and sixth days, in human vaccine lymph on the eighth day, and in lymph from a smallpox pustule on the fourth day. To demonstrate the bacilli, cover-glass films are dried and placed for five minutes in acetic acid (1 in 2), washed in distilled water, dried, and placed in alcoholic gentian-violet for from twenty-four to forty-eight hours, after which they are washed in water and mounted. Copeman and Kent also found the bacilli in sections of vaccine pustules stained by Löffler's methylene-blue, or by Gram's method. The organisms are .4 to .8 μ in length, and one-third to a half of this in thickness. They are generally thinner and stain better at the ends than at the middle. They occur in groups of from three to ten in both the lymph and the tissues. In the centre of their protoplasm there is often a clear globule, which is looked on as a spore. They have hitherto resisted the ordinary isolation methods, a fact which is rather in favour of their non-saprophytic nature. By inoculating fresh eggs with the crusts of smallpox pustules Copeman has, however, obtained a growth of a bacillus resembling that found by him in the tissues. Though sub-cultures on ordinary media have been obtained, the pathogenic effects of these have not been fully investigated, and thus the identity of this bacillus with that seen in the tissues is not proved. The facts that the latter is one hitherto not recognised microscopically, that it exists in the pustules, the contents of which are probably the means by which the disease naturally spreads, that it resists artificial cultivation, that the possession by it of spores explains some of the characteristics of vaccine lymph (resistance to drying, etc.), are, however, of interest from the point of view of the possible etiological relationship of the bacillus to the disease.

Protozoa as Causative Agents.— Van der Loeff and L. Pfeiffer early drew attention to the presence of small amœboid bodies in the blood and epithelial cells of the skin and mucous membranes of persons affected with smallpox, which they believed to be the cause of the disease, and considered them as protozoa. Later, Guarnieri, in a series of studies upon rabbits which he had inoculated in the cornea with active vaccine lymph, described bodies occurring in the lesions similar to those of Van der Loeff and Pfeiffer. He further showed that when using naturally inactive lymph, or filtered vaccine lymph, no bodies were produced in the corneal cells, but they again appeared if the material held back by the filter were inoculated.

Ruffer and Plimmer describe as occurring in clear vacuoles in the cells of the rete Malpighii at the edge of the pustule, in paraffin sections of vaccine and smallpox pustules carefully hardened in alcohol, and stained by the Ehrlich-Biondi mixture, small round bodies about four times the size of a staphylococcus pyogenes, coloured red by the acid fuchsin, sometimes with a central part stained by the methyl-green. These appear to multiply by simple division, and in the living condition exhibit amœboid movement. Similar bodies have been described by Reed in the blood of smallpox patients and of vaccinated children and of calves.

In an exhaustive research von Wasielewski, upon a larger scale repeating Guarnieri's work, largely confirms the latter's observations. He utilised both human and calf vaccine lymphs, and in one series, using bacteria-free calf lymph, he was able to reproduce the peculiar bodies in the cornea of a rabbit with the forty-eighth transfer, passing from one rabbit to another throughout the series. He found similar bodies in the epithelial cells in a case of smallpox, too. His conclusions are that these bodies are neither cell-inclusions of leucocytic origin, nor degeneration products of the epithelial cells themselves, but, with Guarnieri, believes that in all probability they are the causative factors of the disease.

Another observer, Gorini, lays great stress upon the presence of coccus-like bodies free and in the cells of vaccine vesicles and in the lymph, which occur singly, in pairs, and in tetrads. He thinks that possibly their nature is bacterial, and that, being absent in inactive lymph and in the cells of ordinary inflammatory origin, they possibly may be the cause of the phenomena of vaccination. Gorini believes that the bodies described by Guarnieri and von Wasielewski (*cytorcytes vaccine*) are simply the products of cell degeneration.

In the presence of such interesting but divergent findings, it is plain that more precise research of a confirmatory nature is required before any of these bodies can be accepted as being the cause of smallpox or vaccination.

The Nature of Vaccination.—As we are ignorant of the cause of smallpox, we can only conjecture what the nature of vaccination is. From what we know of other like processes, however, we have some ground

for believing that it consists in an active immunisation by means of an attenuated form of the causal organism. As to how immunity is maintained after vaccination, we do not know much. Some, including Bécclère, Chambon, and Ménard (who jointly investigated the subject), maintain that in the blood of vaccinated animals substances exist which, when transferred to other animals, can confer a certain degree of passive immunity against vaccination, and which have also a degree of curative action in animals already vaccinated. Beumer and Peiper, on the other hand, could not find evidence of the existence of such bodies. If they do exist, we cannot as yet say whether they are antitoxic or antimicrobial.

APPENDIX B.

HYDROPHOBIA.

SYNONYMS:—RABIES. FRENCH, LA RAGE. GERMAN, LYSSA,
DIE HUNDSWUTH, DIE TOLLWUTH.

Introductory.—Hydrophobia is an infectious disease which in nature occurs epidemically chiefly among the carnivora, especially in the dog and the wolf. Infection is carried by the bite of a rabid animal or by a wound or abrasion being licked by such. The disease can be transferred to other species, and when once started can be spread from individual to individual by the same paths of infection. Thus it occurs epidemically from time to time in cattle, sheep, horses, and deer, and can be communicated to man; but in modern times at least, infection practically never takes place from man to man, though such an occurrence is quite possible.

In Western Europe the disease is most frequently observed in the dog; but in Eastern Europe, especially in Russia, epidemics among wolves constitute a serious danger both to other animals and to man. All the manifestations of the disease point to a serious affection of the nervous system; but inasmuch as symptoms of excitement or of depression may predominate, it is customary to describe clinically two varieties of rabies, (1) rabies proper, or furious rabies (*la rage vraie, la rage furieuse: die rasende Wuth*); and (2) dumb madness or paralytic rabies (*la rage mue: die stille Wuth*). The disease, however, is essentially the same in both cases. In the dog the furious form is the more common. After a period of incubation of from three to six weeks, the first symptom noticed is a change in the animal's aspect; it becomes restless, it snaps at anything which it touches, and tears up and swallows unwonted objects; it has a peculiar high-toned bark. Spasms of the throat muscles come on, especially in swallowing, and there is abundant secretion of saliva; its supposed special fear of water is, however, a myth,—it fears to swallow at all. Gradually convulsions, paralysis, and coma come on; and death supervenes. In the paralytic form, the early symptoms are the same, but paralysis appears sooner. The lower jaw of the animal drops, from implication of the elevator muscles, all the muscles

of the body become more or less weakened, and death ensues without any very marked irritative symptoms.

In man the incubation period after infection varies from fifteen days to seven or eight months, or even longer, but is usually about forty days. When symptoms of rabies are about to appear, certain prodromata, such as pains in the wound and along the nerves of the limb in which the wound has been received, may be observed. To this succeeds a stage of nervous irritability, during which all the reflexes are augmented—the victim starting at the slightest sound, for example. There are spasms, especially of the muscles of deglutition and respiration, and cortical excitement evidenced by delirium may occur. On this follows a period in which all the reflexes are diminished, weakness and paralysis are observed, convulsions occur, and finally coma and death supervene. The duration of the acute illness is usually from four to eight days, and death invariably results. The existence of paralytic rabies in man has been denied by some, but it undoubtedly occurs. This is usually manifested by paralysis of the limb in which the infection has been received, and of the neighbouring parts; but while in such cases this is often the first symptom observed, during the whole of the illness the occurrence of widespread and progressive paralysis is the outstanding feature.

The Pathology of Hydrophobia.—In hydrophobia, as in tetanus, to which it bears more than a superficial resemblance, the appearances presented in the nervous system, to which all the symptoms are naturally referred, are comparatively unimportant. On naked-eye examination, congestions, and, it may be, minute hæmorrhages in the central nervous system, are the only features noticeable. Microscopically, leucocytic exudation into the perivascular lymphatic spaces in the nerve centres has been observed, and in the cells of the anterior cornua of the grey matter in the spinal cord, and also in the nuclei of the cranial nerves, various degenerations have been described. In the white matter, especially in the posterior columns, swelling of the axis cylinders and breaking up of the myeline sheaths have been noted, and similar changes occur also in the spinal nerves, especially of the part of the body through which infection has come. In the nervous system also some have seen minute bodies which they have considered to be cocci, but that they are really such there is no evidence. Nelis and van Gehuchten have drawn attention to early and well-marked changes occurring in the peripheral, cerebral, and sympathetic ganglia, especially in the intervertebral ganglia and in the plexiform ganglia of the pneumogastric nerve, consisting in the invasion and ultimate destruction of the nerve-cell protoplasm by newly formed cells derived from the capsular membrane. The lesions are most perceptible upon the death of the animal, although they can be made out if the animal be killed

after symptoms of the disease are strongly developed. The work of these observers has been confirmed in America by Ravenel and McCarthy, but Spiller has noted similar changes in man in a case of Landry's paralysis and does not think the lesion specific of rabies. Nevertheless, given a case of "street-rabies," the diagnosis can be made with certainty much earlier than by the inoculation method. The changes in the other parts of the body are unimportant.

Experimental pathology confirms the view that the nervous system is the centre of the disease by finding in it a special concentration of what, from want of a more exact term, we must call the hydrophobic virus. Earlier inoculation experiments made by subcutaneous injection of material from various parts of animals dead of rabies had not given uniform results, as, whatever was the source of the material, the disease was not invariably produced. Pasteur's first contribution to the subject was to show that the most certain method of infection was by inserting the infective matter beneath the *dura mater*. He found that in the case of any animal or man dead of the disease, injection by this method of emulsions of any part of the central nervous system, of the cerebro-spinal fluid, or of the saliva, invariably give rise to rabies, and also that the natural period of incubation was shortened. Further, the identity of the furious and paralytic forms was proved, as sometimes the one, sometimes the other, was produced, whatever form had been present in the original case. Inoculation into the anterior chamber of the eye is nearly as efficacious as subdural infection. Infection with the blood of rabid animals does not reproduce the disease. There is evidence, however, that the poison also exists in such glands as the pancreas and mamma. Subcutaneous infection with part of the nervous system of an animal dead of rabies usually gives rise to the disease.

In consequence of the introduction of such reliable inoculation methods, further information has been acquired regarding the spread and distribution of the virus in the body. Gaining entrance by the infected wound, it early manifests its affinity for the nervous tissues. It reaches the central nervous system chiefly by spreading up the peripheral nerves. This can be shown by inoculating an animal subcutaneously in one of its limbs, with virulent material. If now the animal be killed before symptoms have manifested themselves, rabies can be produced by subdural inoculation from the nerves of the limb which was infected. Further, rabies can often be produced from such a case by subdural infection with the part of the spinal cord into which these nerves pass, while the other parts of the animal's nervous system do not give rise to the disease. This explains how the initial symptoms of the disease (pains along nerves, paralysis, etc.) so often appear in the infected part of the body, and it probably also explains the fact that bites in such richly

nervous parts as the face and head are much more likely to be followed by hydrophobia than bites in other parts of the body. Again, injection into a peripheral nerve, such as the sciatic, is almost as certain a method of infection as injection into the subdural space, and gives rise to the same type of symptoms as injection into the corresponding limb. Intravenous injection of the virus, on the other hand, differs from the other modes of infection in that it more frequently gives rise to paralytic rabies. This fact Pasteur explained by supposing that the whole of the nervous system in such a case becomes simultaneously affected. The virus seems to have an elective affinity for the salivary glands, as well as for the nervous system. Roux and Nocard found that the saliva of the dog became virulent three days before the first appearance of symptoms of the disease.

The Virus of Hydrophobia. — While a source of infection undoubtedly occurs in all cases of hydrophobia, and can usually be traced, all attempts to determine the actual morbid cause have been unsatisfactory. In this connection various organisms have been described as being associated with the disease. Thus Memmo has isolated an organism which resembles a yeast, but which he places amongst the blastomycetes, and with which he states he has produced both types of rabies in rabbits and dogs. Bruschetti also, by using media containing brain substance, has grown a bacillus having some resemblances to the members of the diphtheria group, and with which he claims to have produced paralytic rabies in rabbits. In the case of the work of neither of these observers has there been confirmation from independent sources, and in neither case is there evidence of the crucial test having been applied, namely, that of immunising animals against the ordinary hydrophobic virus by means of pure cultures of the alleged causal organism. With regard to other possible causal agents, Grigorjew thinks such may be found in a protozoon which he has constantly observed after inoculation in the cornea. There is no doubt that between rabies and the bacterial diseases we have studied there are at every point analogies, the most striking being the protective inoculation methods which constitute the great work of Pasteur, and everything points to a micro-organism being the cause. Judging from our knowledge of similar diseases we would strongly suspect that it is actually present in a living condition in the central nervous system, the saliva, etc., which yield what we have called the hydrophobic virus, for by no mere toxin could the disease be transmitted through a series of animals, as we shall presently see can be done. The resistance of the virus to external agents varies. Thus a nervous system containing it is virulent till destroyed by putrefaction; it can resist the prolonged application of a temperature of from -10° to -20° C., but, on the other hand, it is rendered non-virulent by one hour's

exposure at 50° C. Again, its potency probably varies in nature according to the source. Thus, while the death-rate among persons bitten by mad dogs is about 16 per cent, the corresponding death-rate after the bites of wolves is 80 per cent. Here, however, it must be kept in view that, as the wolf is naturally the more savage animal, the number and extent of the bites, *i.e.* the number of channels of entrance of the virus into the body, and the total dose, are greater than in the case of persons bitten by dogs. As we shall see, alterations in the potency of the virus can certainly be effected by artificial means.

The Prophylactic Treatment of Hydrophobia.—Until the publication of Pasteur's researches in 1885, the only means adopted to prevent the development of hydrophobia in a person bitten by a rabid animal, had consisted in the cauterisation of the wound. Such a procedure was undoubtedly not without effect. It has been shown that cauterisation within five minutes of the infliction of a rabic wound prevents the disease from developing, and that if done within half an hour, it saves a proportion of the cases. After this time, cauterisation only lengthens the period of incubation; but, as we shall see presently, this is an extremely important effect.

The work of Pasteur has, however, revolutionised the whole treatment of wounds inflicted by hydrophobic animals. Pasteur started with the idea that, since the period of incubation in the case of animals infected subdurally from the nervous systems of mad dogs is constant in the dog, the virus has been from time immemorial of constant strength. Such a virus, of what might be called natural strength, is usually referred to in his works as the virus of *la rage des rues*, in the writings of German authors as the virus of *die Strasswuth*. Pasteur found on inoculating a monkey subdurally with such a virus, and then inoculating a second monkey from the first, and so on with a series of monkeys, that it gradually lost its virulence, as evidenced by lengthened periods of incubation on subdural inoculation of dogs, until it wholly lost the power of producing rabies in dogs, when introduced subcutaneously. When this point had been attained, its virulence was not diminished by further passage through the monkey. On the other hand, if the virus of *la rage des rues* were similarly passed through a series of rabbits or guinea-pigs, its virulence was increased till a constant strength (the *virus fixé*) was attained. Pasteur had thus at command three varieties of virus—that of natural strength, that which had been attenuated, and that which had been exalted. He further found that, commencing with the subcutaneous injection of a weak virus and following this up with the injection of the stronger varieties, he could ultimately, in a very short time, immunise dogs against subdural infection with a virus which, under ordinary conditions, would certainly have caused a fatal result. He also

elucidated the fact that the exalted virus contained in the spinal cords of rabbits such as those referred to could be attenuated so as no longer to produce rabies in dogs by subcutaneous injection. This was done by drying the cords in air over caustic potash (to absorb the moisture), the diminution of virulence being proportional to the length of time during which the cords were kept. Accordingly, by taking a series of such spinal cords kept for various periods of time, he was supplied with a series of vaccines of different strengths. Pasteur at once applied himself to find whether the comparatively long period of incubation in man could not be taken advantage of to "vaccinate" him against the disease before its gravest manifestation took place. The following is the record of the first case thus treated. The technique was to rub up in a little sterile bouillon a small piece of the cord used, and inject it under the skin by means of a hypodermic syringe. The first injection was made with a very attenuated virus, *i.e.* a cord fourteen days old. In subsequent injections the strength of the virus was gradually increased, as shown in the table:—

July 7, 1885,	9 A.M.,	cord of June 23,	<i>i.e.</i> 14 days old.
" 7 "	6 P.M.	" 25 "	12 "
" 8 "	9 A.M.	" 27 "	11 "
" 8 "	6 P.M.	" 29 "	9 "
" 9 "	11 A.M.,	cord of July 1	" 8 "
" 10 "	" "	" 3 "	7 "
" 11 "	" "	" 5 "	6 "
" 12 "	" "	" 7 "	5 "
" 13 "	" "	" 9 "	4 "
" 14 "	" "	" 11 "	3 "
" 15 "	" "	" 13 "	2 "
" 16 "	" "	" 15 "	1 day old.

The patient never manifested the slightest symptom of hydrophobia. Other similarly favourable results followed; and this prophylactic treatment of the disease quickly gained the confidence of the scientific world, which it still maintains. (The principle is, of course, the same as in artificially developing a high degree of active immunity against a bacterial infection.)

The only modification which the method has undergone has been in the treatment of serious cases, such as multiple bites from wolves, extensive bites about the head, especially in children, cases which come under treatment at a late period of the incubation stage, and cases where the wounds have not cicatrised. In such cases the stages of the treatment are condensed. Thus on the first day, say at 11 A.M. and 4 P.M. and 9 P.M., cords of 12, 10, and 8 days respectively are used; on the second day, cords of 6, 4, and 2 days; on the third day, a cord of 1 day; on the fourth day, cords of 8, 6, and 4 days; on the fifth, cords of 3 and 2 days; on the sixth, cords of 1 day; and so on for ten days. In each case the average dose is about 2 c.c. of the emulsion.

The success of the treatment has been very marked. The statistics of the cases treated in Paris are published quarterly in the *Annales de l'Institut Pasteur*, and general summaries of the results of each year are also prepared. As we have said, the ordinary mortality formerly was 16 per cent of all persons bitten. During the ten years 1886-95, 17,337 cases were treated, with a mortality of .48 per cent. It has been alleged that many people are treated who have been bitten by dogs that were not mad. This, however, is not more true of the cases treated by Pasteur's method than it was of those on which the ordinary mortality of 16 per cent was based, and care is taken in making up the statistics to divide the cases into three classes. Class A includes only persons bitten by dogs proved to have had rabies, by inoculation in healthy animals of parts of the central nervous system of the diseased animal. Class B includes those bitten by dogs that a competent veterinary surgeon has pronounced to be mad. Class C includes all other cases. During 1895, 122 cases belonging to Class A were treated, with no deaths; 949 belonging to Class B, with two deaths; and 449 belonging to Class C, with no deaths. Besides the Institute in Paris, similar institutions exist in other parts of France, in Italy, and especially in Russia, as well as in other parts of the world; and in these similar success has been experienced. It may be now taken as established, that a very grave responsibility rests on those concerned, if a person bitten by a mad animal is not subjected to the Pasteur treatment.

Antirabic Serum. — In the early part of the nineteenth century an Italian physician, Valli, showed that immunity against rabies could be conferred by administering through the stomach progressively increasing doses of hydrophobic virus. Following up this observation, Tizzoni and Centanni have attenuated rabic virus by submitting it to peptic digestion, and have immunised animals by injecting gradually increasing strengths of such virus. This method is usually referred to as the Italian method of immunisation. The latter workers showed from this that the serum of animals thus immunised could give rise to passive immunity in other animals; and further, that if injected into animals from seven to fourteen days after infection with the virus, it prevented the latter from producing its fatal effects, even when symptoms had begun to manifest themselves. They further succeeded in producing in the sheep and the dog an immunity equal to from 1-25,000 to 1-50,000 (*vide* p. 472), and they recommended the use, in severe cases, of the serum of such animals in addition to the treatment of the patient by the Pasteur method. We do not, of course, know whether the serum contains antitoxic or antimicrobial bodies.

Methods. (*a*) *Diagnosis.* — When a person is bitten by an animal suspected to be rabid, the latter must under no circumstances be killed. Much more can be learned by watching it while alive than by *post-mortem* examination. In the latter case only such things as the occurrence of broken teeth, marked congestion of the fauces, or the presence of unwonted material in the stomach throw any light on the condition. By examination of the spinal ganglia (*vide supra*), an early and pro-

visional diagnosis may be readily made which will be confirmed or dismissed by the results of the slower but more certain inoculation method. On the other hand, in the living animal the development of the characteristic symptoms can be watched, and death will occur in not more than five days. If the suspected animal has been killed, then a small piece of its medulla or cord must be taken, with all aseptic precautions, rubbed up in a little sterile .75 per cent sodium chloride solution, and injected by means of a syringe beneath the dura mater of a rabbit, the latter having been trephined over the cerebrum by means of the small trephine which is made for the purpose. Symptoms usually occur in from twelve to twenty-three days and death in fifteen to twenty-five days. When such inoculation has to be practised it is evident that the diagnosis is delayed. When the material for inoculation has to be sent any distance this is best effected by packing the head of the animal in ice. The virulence of organs is not lost, however, if they are simply placed in sterile water or glycerin in well-stoppered bottles.

(b) *Treatment.* — Every wound inflicted by a rabid animal ought to be cauterised with the actual cautery as soon as possible. By such treatment the incubation period will at any rate be lengthened, and therefore there will be better opportunity for the Pasteur inoculation method being efficacious. The person ought then to be sent to the nearest Pasteur Institute for treatment. It is of great importance that in such a case the nervous system of the animal should also be sent, in order that the diagnosis may be certainly verified.

APPENDIX C.

MALARIAL FEVER.

It has now been conclusively proved that the cause of malarial fever is a protozoon of which there are several species. The parasite was formerly known as the *hæmatozoon* or *plasmodium malarie*, although the use of the latter term is incorrect; the term *hæmamœba* is, however, now generally employed. The parasite was first observed by Laveran in 1880, and his discovery received confirmation from the independent researches of Marchiafava and Celli, and later from the researches of many others in various parts of the world. Golgi supplied valuable additional information, especially in relation to the sporulation of the organism and the varieties in different types of malarial fever. In this country valuable work on the subject was done by Manson, and to him specially belongs the credit of regarding the exflagellation of the organism as a preparation for an extra-corporeal phase of existence. By induction he arrived at the belief that the cycle of existence outside the human body probably took place in the mosquito. It was specially in order to discover, if possible, the parasite in the mosquito, that Ross commenced his long series of observations, which were ultimately crowned with success. After patient and persistent search, he found rounded pigmented bodies in the wall of the stomach of a dapple-winged mosquito (a species of *Anopheles*) which had been fed on the blood of a malarial patient. The pigment in these bodies was exactly similar to that in the malarial parasite, and he excluded the possibility of their representing anything else than a stage in the life cycle of the organism. He confirmed this discovery and obtained corresponding results in the case of the proteosoma infection of birds, where the parasite is closely related to that of malaria. In birds affected with this organism, he was able to trace all stages of its development, from the time it entered the stomach along with the blood, till the time when it settled in a special form in the salivary glands of the insect. Ross's results were published in 1898. Exactly corresponding stages were afterwards found in the case of the different species of the human parasite, by Grassi, Bignami, and Bastianelli; and these and other Italian observers also supplied important information regarding the transmission

of the disease by infected mosquitoes. Abundant additional observations, with confirmatory results, were supplied by Koch, Daniels, Christophers, Stephens, and others. Wherever malaria has been studied the result has been the same. Lastly, we may mention the striking experiment carried out by Manson by means of mosquitoes fed on the blood of patients in Italy suffering from mild tertian fever. The insects, after being thus fed, were taken to London and allowed to bite the human subject, Manson's son, Dr. P. Thurburn Manson, offering himself for the purpose. The result was that infection occurred; the parasites appeared in the blood, and were associated with an attack of tertian fever. Ross's discovery has not only been a means of elucidating the mode of infection, but, as will be shown below, has also supplied the means of successfully combating the disease.

From the zoological point of view the mosquito is regarded as the definitive host of the parasite, the human subject as the intermediate host. But in describing the life history, it will be convenient to consider, first, the cycle in the human body, and, secondly, that in the mosquito.

The Cycle in the Human Subject.—With regard to this cycle, it may be stated that the parasite is conveyed by the bite of the mosquito in the form of a small filamentous blast or exotospore, which gives rise to the small amœboid organism or amœbula seen in the human blood. There is then a regularly repeated asexual cycle of the parasite in the blood, which cycle determines the type of the fever, *e.g.* the cycle of the tertian parasite is completed in forty-eight hours, although a double infection with this parasite may produce a quotidian type. During this cycle there is a growth of the amœbulæ within the red corpuscles up to their complete development and sporulation. The onset of the febrile attack corresponds with the stage of sporulation and the setting free of the spores, or youngest forms, *i.e.* with the production of a fresh brood of parasites. These spores soon become attached to, and penetrate into the interior of, the red corpuscles, becoming intra-corpuscular amœbulæ; the cycle is thus completed. The parasites are most numerous in the blood during the development of the pyrexia, and, further, they are also much more abundant in the internal organs than in the peripheral blood; in the malignant type, for example, the process of sporulation is practically confined to the former.

In addition to these forms, which are part of the ordinary cycle, there are derived from the amœbulæ other forms, which are called *gametes*, or sexual cells. These gametes remain unaltered during successive attacks of pyrexia, and undergo no further change until the blood is removed from the human body. In the simple tertian and quartan fevers (*vide infra*) the gametes closely resemble in structure

the fully developed amœbulæ before sporulation, whereas in the malignant type they have a characteristic crescent-like or sausage-shaped form; hence they are often spoken of as "crescentic bodies."

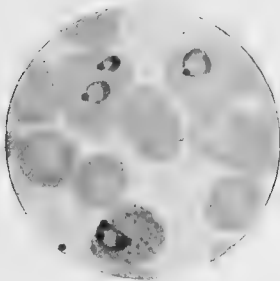

FIG. 157.

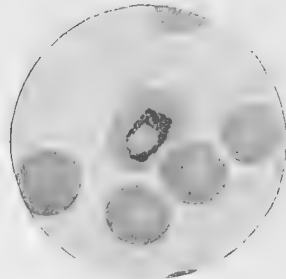

FIG. 158.

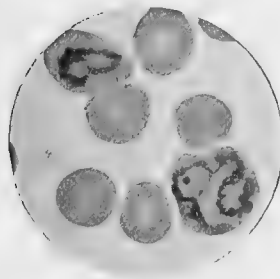

FIG. 159.

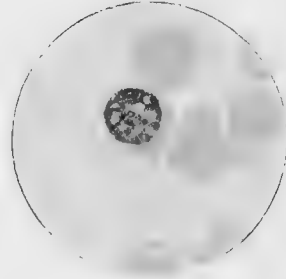

FIG. 160.

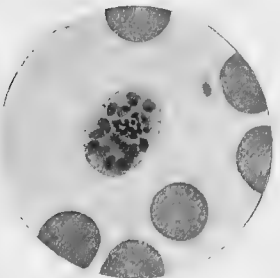

FIG. 161.

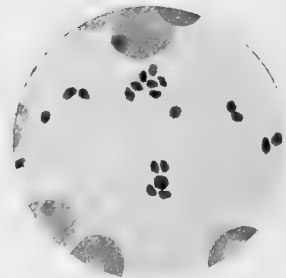

FIG. 162.

FIGS. 157-162. — Various phases of the benign tertian parasite.

Fig. 157. Several young ring-shaped amœbulæ within the red corpuscles, one of the latter enlarged and showing a dotted appearance. Fig. 158. A larger amœbula containing pigment granules. Fig. 159. Two large amœbulæ, exemplifying the great variation in form. Fig. 160. Large amœbulæ assuming the spherical form and showing isolated fragments of chromatin — preparatory to sporulation. Fig. 161. Sporocyte, which has produced eighteen spores, each of which contains a small collection of chromatin. Fig. 162. A number of spores which have just been set free in the plasma. $\times 1000$.

The various forms of the parasite seen in the human blood may now be described more in detail.

1. *The Spores or Enhæmospores* (Lankester) are the youngest and smallest forms resulting from the segmentation of the adult amœbula or sporocyte. They are of round or oval shape and of small size usually

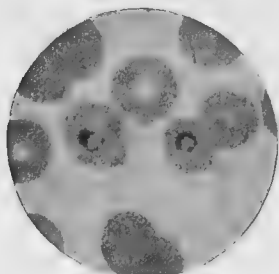

FIG. 163.



FIG. 164.

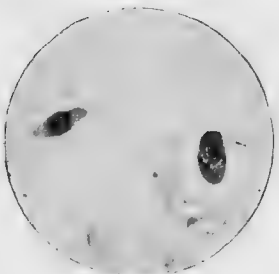

FIG. 165.

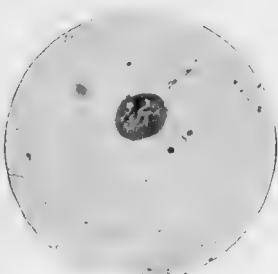

FIG. 166.

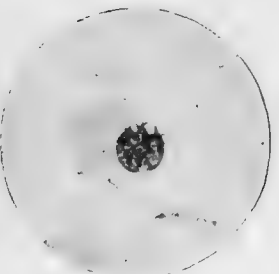

FIG. 167.

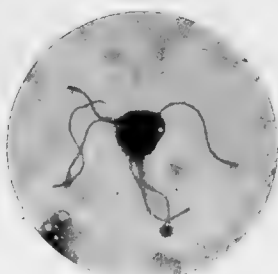

FIG. 168.

FIGS. 163-168. — Exemplifying phases of the malignant parasite.

Fig. 163. Two small ring-shaped amœbulæ within the red corpuscles. Fig. 164. A "crescent" or gamete showing the envelope of the red corpuscles; also an amœbula. Figs. 165-168 illustrate the changes in form undergone by the crescents outside the body. In the interior of the spherical form in Fig. 167 evidence of the flagella can be seen. Fig. 168. A male gamete which has undergone exflagellation, showing the thread-like microgametocytes or spermatozoa attached at the periphery. $\times 1000$. (The figures in this plate are from preparations kindly lent by Dr. Manson.)

not exceeding 2μ in diameter; the size, however, varies somewhat in the different types of fever. A nucleus and peripheral protoplasm can

be distinguished (Figs. 161, 162). The former appears as a small rounded body which usually remains unstained, but contains a minute mass of chromatin which stains a deep red with the Romanowsky method; the peripheral protoplasm is coloured fairly deeply with methylene-blue. The spores show little or no amœboid movement; at first free in the plasma, they soon attack the red corpuscles, where they become the intra-corpuscular amœbulæ. If the blood, say in a mild tertian case, be examined in the early stages of pyrexia, one often finds at the same time sporulating forms, free spores, and the young amœbulæ within the red corpuscles.

2. *Intra-corpuscular Bodies or Amœbulæ.*—These include the parasites which have attacked the red corpuscles; they are at first situated on the surface of the latter, but afterwards penetrate their substance. They usually occur singly in the red corpuscles, but sometimes two or more may be present together. The youngest or smallest forms appear as minute colourless specks, of about the same size as the spores. As seen in fresh blood, they exhibit more or less active amœboid movement, showing marked variations in shape. The amount and character of the amœboid movement varies somewhat in different types of fever. As they increase in size, pigment appears in their interior as minute dark-brown or black specks, and gradually becomes more abundant (Figs. 158, 159). The pigment may be scattered through their substance, or concentrated at one or more points, and often shows vibratory or oscillating movements. This pigment is no doubt elaborated from the hæmoglobin of the red corpuscles, the parasite growing at the expense of the latter. The red corpuscles thus invaded may remain unaltered in appearance (quartan fever), may become swollen and pale (tertian fever), or somewhat shrivelled and of darker tint (malignant fever). In stained specimens a nucleus may be seen in the parasite as a pale spot containing chromatin which may be arranged as a single concentrated mass or as several separated granules, the chromatin being coloured a deep red by the Romanowsky method. The protoplasm of the parasite, which is coloured of varying depth of tint with methylene-blue, shows great variation in configuration (Fig. 159). The young parasites not unfrequently present a "ring-form," a portion of the red corpuscle being thus enclosed by the parasite. These ring-forms are met with in all the varieties of the parasite, but they are especially common in the case of the malignant parasite, where they are of smaller size and of more symmetrical form than in the others, representing a quiescent stage (Fig. 163); the pigment is usually collected in a small clump at one side.

Within the red corpuscles the parasites gradually increase in size till the full adult form is reached (Fig. 160). In the latter stage the para-

site loses its amœboid movement more or less completely, has a somewhat rounded form, and contains a considerable amount of pigment. In the malignant form it only occupies a fraction of the red corpuscle. The adult parasites may then undergo sporulation, but not all of them do so; some become degenerated and ultimately break down.

3. *Sporocytes or Sporulation Forms.*—In the largest amœbulæ before sporulation the nuclear chromatin becomes scattered throughout the parasite. During sporulation the pigment becomes collected as a more or less central mass, and the protoplasm segments into a number of spores, each of which contains a small mass of chromatin (Fig. 161). The spores are of rounded or oval shape, as above described, and are set free by the rupture of the envelope of the red corpuscle. The pigment also becomes free and may be taken up by leucocytes. The number and arrangement of the spores within the sporocyte varies in the different types. In the quartan there are 6–12, and the segmentation is in a radiate manner, giving rise to the characteristic daisy-head appearance; in the tertian they number 15–20, and have a somewhat rosette-like arrangement (Fig. 161); in the malignant there are usually 6–12 spores of small size and somewhat irregularly arranged.

Gametes.—As stated above, these are sexual cells which are formed from certain of the amœbulæ, and which undergo no further development in the human subject. In the mild tertian and quartan fevers they resemble somewhat the largest amœbulæ, the female cells being rather more granular in appearance than the male. In the malignant fevers the gametes have the special crescentic form mentioned above. They measure 8–9 μ in length, and occasionally a fine curved line is seen joining the extremities on the concave aspect, which represents the envelope of the red corpuscle (Fig. 164). They are colourless and transparent, and are enclosed by a distinct membrane; in the central part there is a collection of pigment and granules of chromatin. It is stated that the male crescents can be distinguished from the female by their appearance. In the former the pigment is less dark and more scattered than in the latter, and there are several granules of chromatin; in the latter the pigment is dark and concentrated, often in a small ring, and there are one or two masses of chromatin in the centre of the crescent. According to the Italian observers the early forms of the crescents are somewhat fusiform in shape and are produced in the bone-marrow. The fully developed crescents do not appear in the blood till several days after the onset of the fever, and they may be found a considerable time after the disappearance of the pyrexial attacks. They are also little, if at all, influenced by the administration of quinine.

The Cycle in the Mosquito.—As already explained, this starts from the gametes. After the blood is shed, or after it is swallowed by the mos-

quito, two important phenomena occur, viz., (*a*) the exflagellation of the male gamete, and (*b*) the impregnation of the female. If the blood from a case of malignant infection be examined in a moist chamber, preferably on a warm stage, under the microscope, both male and female gametes may be seen to become oval and afterwards rounded in shape (Figs. 165-167). Thereafter, in the case of the male cell, a vibratile or dancing movement of the pigment granules can be seen in the interior, and soon several flagella-like structures shoot out from the periphery (Fig. 168). They are of considerable length but of great fineness, and often show a somewhat bulbous extremity. By the Romanowsky method they have been found to contain a delicate core of chromatin, which is covered by protoplasm. They represent the male cells proper, that is, they are sperm-cells or spermatozoa; they are also known as microgametocytes. They become detached from the sphere and move away in the surrounding fluid. One of them may enter a female gamete and thus a process of true impregnation occurs. It is also stated that the female cell before fertilisation gives off two polar bodies. This was first observed by MacCallum in the case of halteridium, and he found that the female cell afterwards acquired the power of independent movement or became a "travelling vermicule." He also observed the impregnation of the malignant parasite. The fertilised female cell is now generally spoken of as a *zygote*.

It has been established that the phenomena just described occur within the stomach of the mosquito, and that the fertilised cell or zygote penetrates the stomach wall and settles between the muscle fibres; on the second day after the mosquito has ingested the infected blood small rounded cells about 6-8 μ in diameter and containing clumps of pigment may be found in this position. (It was in fact the character of the pigment which led Ross to believe that he had before him a stage in the development of the malarial parasite.) A distinct membrane called a *sporocyst* forms around the zygote, and on subsequent days a great increase in size takes place, and the cysts come to project from the surface of the stomach into the body cavity. The zygote divides into a number of cells called *blastophores* or *spore-mother-cells*, and on the surface of each there are formed a large number of filiform spores which have a radiate arrangement; these were called by Ross "germinal rods," but are now usually known as *zygotoblasts* or *exotospores* (in contradistinction to the enhæmospores of the human cycle). The full development within the sporocyst occupies, in the case of proteosoma, about seven days, in the case of the malarial parasites a little longer. When fully developed the cyst measures about 60 μ in diameter, and appears packed with zygoblasts. It then bursts, and the latter are set free in the body

cavity. A large number settle within the large veneno-salivary gland of the insect, and are thus in a position to be injected along with its secretion into the human subject. Daniels found that in the case of the malignant parasite an interval of twelve days at least intervened between the time of feeding the mosquito and the appearance of the filiform spores in the gland.

It will thus be seen that in the human subject the parasite passes through an indefinite number of regularly recurring asexual cycles, with the giving off of collateral sexual cells, and that in the mosquito there is one cycle which may be said to start with the impregnation of the female gametocyte — a cycle, moreover, in which the parasite reaches the most advanced stage of its development.

Varieties of the Malarial Parasite. — The view propounded by Laveran was that there is only one species of malarial parasite, which is polymorphous, and presents slight differences in structural character in the different types of fever. It may, however, now be accepted as proved that there are at least three distinct species which infect the human subject. This is shown by their distinct morphological characters, by differences in the length of their cycle of development, and also, to a certain extent, by their pathogenic effects. Practically all are agreed as to a division into two groups, one of which embraces the parasites of the milder fevers, — “winter-spring” fevers of Italian writers, — there being here two distinct species, for the quartan and tertian types respectively; whilst the other includes the parasites of the severer forms — “æstivo-autumnal” fevers, malignant or pernicious fevers of the tropics, or irregularly remittent fevers. There is still doubt as to whether there are more than one species in this latter group. Formerly, Italian writers distinguished (1) a quotidian, (2) a non-pigmented quotidian, and (3) a malignant tertian parasite, though the morphological differences described were slight. Further observations have, however, thrown doubt on this distinction, and the evidence rather goes to show that there is a single species, which probably has a cycle of forty-eight hours, though variations may occur; multiple infection is moreover common, and thus a quotidian or irregular type may occur. Manson, for example, considers that if there exists a true quotidian fever it must be of the rarest occurrence. Although the question cannot be considered as finally settled, we shall accordingly speak of three species of human parasites. The zoological position may be shown by the following scheme, generally followed by English writers, the terminology being chiefly that of Grassi and Feletti: —

Family: HÆMAMŒBIDÆ (Wasielewski)

Genus I. *Hæmamœba*. The mature gametes resemble in form the sporocytes before they have differentiated into spores.

Species 1. *Hæmamœba danilewskyi* or *halteridium*.

Parasite of pigeons, crows, etc.

Species 2. *Hæmamœba relicta* or *proteosoma*.

Parasite of sparrows, larks, etc.

Species 3. *Hæmamœba malaricæ*.

Parasite of quartan fever of man.

Species 4. *Hæmamœba vivax*.

Parasite of tertian fever of man.

Genus II. *Hæmomenas*. The gametes have a special crescentic form.

Species: *Hæmomenas præcox*.

Parasite of malignant or æstivo-autumnal fever of man.

In addition there are other species belonging to the same family of blood parasites, which infect frogs, lizards, bats, etc., especially in malarial regions.

We shall now give the chief distinctive characters of the three human parasites.

1. *Parasite of Quartan Fever*.—The cycle of development in man is seventy-two hours, and produces pyrexia every third day; double or triple infection may, however, occur. In fresh specimens of blood the outline is more distinct than that of the tertian parasite, and amœboid movement is less marked. Only the smaller forms show movement, and this is not of active character. The infected red corpuscles do not become altered in size or appearance, and the pigment within the parasite is in the form of coarse granules, of dark brown or almost black colour. The fully developed sporocyte has a "daisy-head" appearance, dividing by regular radial segmentation into six to twelve spores, which, on becoming free, are rounded in form.

2. *The Parasite of Mild Tertian Fever*.—The cycle of development is completed in forty-eight hours, though a quotidian type of fever may be produced by double infection. The amœbulæ have a less refractile margin than in the quartan type, and are thus less easily distinguished in the fresh blood; the amœboid movements are, however, much more active, while longer and more slender processes are given off. The infected corpuscles become swollen and pale, and may show deeply stained points by the Romanowsky method—"Schüffner's dots." The pigment within the parasite is fine and of yellowish-brown tint. The mature sporocyte is rather larger than in the quartan, has a rosette appearance, and gives rise to fifteen to twenty spores, which have a somewhat oval shape.

In both the quartan and tertian fevers all the stages of development can be readily observed in the peripheral blood.

3. *The Parasite of Malignant or Æstivo-autumnal Fever, or Tropical Malaria.*—The cycle in the human subject probably occupies forty-eight hours, though this cannot be definitely stated to be always the case (*vide supra*). The amœbulæ in the red corpuscles are of small size, and their amœboid movements are very active; they often, however, pass into the quiescent ring form (Fig. 163). The pigment granules, even in the larger forms, are few in number and very fine; the infected red corpuscles have a tendency to shrivel and assume a deeper or coppery tint. The fully developed sporocyte occupies less than half the red corpuscle, and gives rise to usually from six to twelve spores, somewhat irregularly arranged and of minute size. Sporulation takes place almost exclusively in the internal organs, spleen, etc., so that, as a rule, no sporocytes can be found in the blood taken in the usual way. The proportion of red corpuscles infected by the amœbulæ is also much larger in the internal organs. The gametes have the crescentic form, as already described.

Cases of infection with the malignant parasite sometimes assume a pernicious character, and then the number of organisms in the interior of the body may be enormous. In certain fatal cases with coma the cerebral capillaries appear to be almost filled with them, many being in process of sporulation, and in so-called algid cases, characterised by great collapse, a similar condition has been found in the capillaries of the omentum and intestines. The process of blood destruction present in all malarial fevers, reaches its maximum in the malignant class, and the brown or black pigment elaborated by the parasites—in part after being taken up by leucocytes, chiefly of the mononuclear class—becomes deposited in various organs, spleen, liver, brain, etc., especially in the endothelium of vessels and the perivascular lymphatics. In the severer forms also brownish-yellow pigment is apparently derived from liberated hæmoglobin, and accumulates in various parts, especially in the liver cells; most of this latter gives the reaction of an iron salt.

General Considerations.—The developments of the malarial parasites in the mosquito and infection of the human subject through the bites of this insect have, by the work of Ross and others, as detailed above, become established scientific facts. These facts, moreover, point to certain definite methods of prevention of infection, and these methods have to a certain extent already been practically tested. The extensive observations recently carried out go to show that all the mosquitoes which act as hosts of the parasite belong to the genus *anopheles*; of these there are a large number of species, and in at least eight or nine the parasite has been found. The breeding places of these insects are chiefly in stagnant pools and other collections of standing water, and

accordingly the removal, where practicable, by drainage of such collections in the vicinity of centres of population, and the killing of the larvæ by petroleum sprinkled on the water, have constituted one of the most important measures. This has been carried out recently at Freetown by Logan Taylor, under the superintendence of Ross, and the result has been to show that a marked lowering of the number of cases may be effected at comparatively small cost. Another measure is the protection against mosquito bites by netting, it being fortunately the habit of the anopheles to rarely become active before sundown. The experiments of Sambon and Low in the Campagna have proved that individuals using these means of protection may live in a highly malarial district without becoming infected. The administration of quinine to those in highly malarial regions, in order to *prevent* infection, has also been recommended and carried out. In the tropics the natives in large proportion suffer from malarial infection, and one would accordingly expect that infection of the mosquitoes in the neighbourhood of native settlements will be common. This has been found to be actually the case, and it has accordingly been suggested that the dwellings of whites should as far as possible be at some distance from the native centres of population.

So far none of the lower animals have been found to act as intermediate hosts to the parasite of human malaria, but the possibility of such being the case cannot be as yet definitely excluded. On the death of infected mosquitoes the exospores or sporozoites will become set free, and therefore theoretically there is a possibility that they may enter the human subject by inhalation or by some other means. We have no facts, however, to show that this really occurs, and the evidence already obtained establishes the bites of mosquitoes as the most important if not the only mode of infection.

It may also be mentioned as a scientific fact of some interest, though not bearing on the natural modes of infection, that the disease can also be communicated from one person to another by injecting the blood containing the parasites. Several experiments of this kind have been performed (usually about $\frac{1}{2}$ to 1 c.c. of blood has been used), and the result is more certain in intravenous than in subcutaneous injection. In such cases there is an incubation period, usually of from seven to fourteen days, after which the fever occurs. The bulk of evidence goes to show that the same type of fever is reproduced as was present in the patient from whom the blood was taken.

Methods of Examination. — The parasites may be studied by examining the blood in the fresh condition, or by permanent preparations. In the former case, a slide and cover-glass having been thoroughly cleaned, a small drop of blood from the finger or lobe of the ear is caught by the cover-glass, and allowed to spread out between it and the slide.

It ought to be of such a size that only a thin layer is formed. A ring of vaseline is placed round the edge of the cover-glass to prevent evaporation. For satisfactory examination an immersion lens is to be preferred. The amoeboid movements are visible at the ordinary room temperature, though they are more active on a warm stage. With an Abbé condenser a small aperture of the diaphragm should be used.

Permanent preparations are best made by means of dried films. A small drop of blood is allowed to spread itself out between two cover-glasses, which are separated by sliding the one on the other. The films are then allowed to dry. A very good method is that of Manson, who catches the drop of blood on a piece of gutta-percha tissue (a piece of cigarette-paper also does well), and then makes a film on a clean slide by drying the blood over the surface. The dried films are then fixed by one of the methods already given (p. 90), or by placing in absolute alcohol for five minutes (Manson). The films thus prepared and fixed may be stained for two or three minutes in a saturated watery solution of methylene-blue or in carbol-thionin-blue (p. 101); the solutions must be carefully filtered (especially the latter), and the films must be washed well after staining. They are then dried and mounted in balsam. In the case of thionin-blue, sharper results are obtained by dehydrating in alcohol and clearing in xylol before mounting. A double stain may be obtained by staining first with .5 per cent solution of "alcohol-soluble" eosin in methylated spirit for two minutes, then washing in water and drying; thereafter the blue stain is used as above; the blood corpuscles are stained red, the parasites and nuclei of the leucocytes blue.

The structure of the parasites is specially well brought out by the following method of Rd. Muir. The films are fixed in saturated solution of corrosive sublimate for a few seconds, and are then washed well in running water. They are then stained with hæmalum for ten minutes, washed well, and again stained for about the same time in a saturated watery solution of methylene-blue; they are then washed in water, dehydrated, cleared in xylol, and mounted in balsam. Here also eosin may first be used as a contrast stain; but the method as just given is specially good for picking out the parasites in the blood. The chromatin of the parasites is coloured a violet-blue, the protoplasm a pure blue.

Romanowsky Method.—For studying details in the structure, this method has been extensively applied. It depends on the principle that when "ripened" methylene-blue is mixed with eosin a new compound is formed which has a special affinity for the chromatin of the malarial parasite, staining it a bright red. It is to be noted, however, that the method only succeeds with certain kinds of methylene-blue and eosin. There are various modes of making and applying the stain: we give two recommended by Leishman.

Solutions: A. Medicinal methylene-blue (Grübler) in 1 per cent watery solution, with .5 per cent sodium carbonate added. The solution is heated for about twelve hours at 65° C., and then kept for about a week at warm room temperature.

B. Eosin "extra B.A." (Grübler) in 1:1000 watery solution.

First Method.—Dilute some of A and B, each with 25 vols. of water. Then mix equal parts (say 2 c.c.) of the diluted stains. Stain films (fixed in alcohol and ether or in alcohol) for half an hour or longer. When the staining is sufficient the nuclei of the leucocytes, when examined under the microscope, should have a ruby-red colour. Then decolorise slightly, by washing in alcohol for two or three seconds, or in water for about half an hour. Then allow to dry and mount in balsam.

Second Method.—Equal parts of A and B (say 500 c.c. of each) are mixed, allowed to stand for 6–12 hours, the mixture being thoroughly stirred from time to time. The mixture is then filtered, and the deposit which is got on the filter is dried and powdered. A .15 per cent solution of this is made in methyl alcohol (Merck, "for analysis"). This alcoholic solution fixes and stains at the same time. Place 3–4 drops on the film for half a minute, then add 6–8 drops of distilled water, mix with the stain, and allow to remain for five minutes longer. (This intensifies the staining, especially the red tint.) Then wash in water, allow to dry, and mount in balsam, or simply examine in water.

In the Romanowsky method, the chromatin of the parasites ought to be brilliant red, the protoplasm blue.

It is to be noted that with practically all the methods of staining, better results are obtained when the blood films have been recently made than when they have been kept for some time.

APPENDIX D.

AMŒBIC DYSENTERY.

In a previous chapter it has been pointed out that the term "dysentery" has been applied to a number of conditions of different etiology and the relations of bacteria as causal agents have been discussed (*vide* p. 349). We shall here consider that variety of tropical¹ dysentery which is believed to be due to an amœba, and hence often known as *amœbic dysentery*.

Amongst the early researches on the relation of organisms to dysentery probably the most important are those of Löscher, who noted the presence and described the characters of amœbæ in the stools of a person suffering from the disease, and considered that they were probably the causal agents. Further observations on a more extended scale were made by Kartulis with confirmatory results, this observer finding the same organisms also in liver abscesses associated with dysentery. The subject was, however, complicated by the fact that the same or closely similar organisms had been previously found in the intestine in normal conditions and in other diseases than dysentery (by Cunningham and Lewis and others), and additional research confirmed these results. Two questions thus arose. In the first place, Is there an amœba peculiar to dysentery (*amœba dysentericæ*) and distinguishable from the amœbæ present in other conditions? In the second place, Is this organism the cause of the disease? Both of these questions may now be said to be practically answered in the affirmative. Further, Councilman and Lafleur, working in Baltimore, have found that this variety of dysentery can be distinguished from other forms, not only by the presence of amœba, but also by its pathological anatomy. The intestinal lesions, to which reference is made below, are of a grave character, mortality is relatively high, and recovery, when it occurs, is protracted on account of the extensive tissue changes. The results of these observers have been confirmed by those obtained in Egypt by Kruse and Pasquale, who have also supplied important facts regarding the pathogenic effects of

¹ The term *tropical* is misleading, as amœbic dysentery is known to develop independently in temperate regions, cases being not infrequent in Baltimore, Philadelphia, and New York, in the United States, and cases have also been reported in Germany.

the amœbæ when inoculated into animals. The following description is chiefly taken from the monographs of the four writers last mentioned.

Characters of the Amœba.—The amœbæ, as seen in the stools of a case of amœbic dysentery, are rounded or somewhat irregular protoplasmic masses, usually measuring about 25 to 35 μ in diameter, though both larger and smaller forms are met with.

When the parasite is at rest it has a more or less rounded shape; the protoplasm is finely granular and of refractile appearance, and is without differentiation into layers. The organism may show sluggish amœbic movements at the ordinary temperature, but these become much more active when a warm stage is used. When they occur, the amœba shows differentiation into a central granular endoplasm and an outer hyaline layer or ectoplasm which is very thin and well marked off from the former. The blunt processes which are protruded in amœbic



FIG. 169.—Amœbæ of dysentery.

a and *b*, amœbæ as seen in the fresh stools, showing blunt amœboid processes of ectoplasm. The endoplasm of *a* shows a nucleus, three red corpuscles, and numerous vacuoles; that of *b*, numerous red corpuscles and a few vacuoles.

c, an amœba as seen in a fixed film preparation, showing a small rounded nucleus (Kruse and Pasquale). $\times 600$.

movement are composed of the ectoplasm (Fig. 169, *a*, *b*). By the amœbic movements slow locomotion may be produced. The amœbæ often show vacuoles in their substance, and may contain numerous red corpuscles (which appear to undergo digestion), also bacteria, etc. There is a single nucleus which lies in the central part of the organism and usually measures about 6 to 8 μ in diameter. It is round or oval and contains a nucleolus. In the living condition the nucleus is invisible or is faintly seen, but becomes very evident on the addition of acetic acid, etc. The amœbæ break down pretty rapidly outside the body, and examination of the dysenteric stools twenty-four hours after being passed usually fails to detect any of them. It is only on one or two rare occasions that the process of division of the amœbæ has been observed and described.

By some there have also been described encysted forms. These are of smaller size, about 10 to 15 μ , with a well-marked capsule, sometimes showing a double contour and a central protoplasm in which a nucleus may or may not be visible. It is still doubtful, however, whether these

structures really constitute a stage in the development of the organism, as direct transformation from the one form into the other has not been observed.

Distribution of the Amœbæ.—As already stated, they are usually found in large numbers in the contents of the large intestine in tropical amœbic dysentery. They also, however, penetrate into the tissues, where they appear to exert a well-marked action. In this disease the lesions are chiefly in the large intestine, especially in the rectum and at the flexures, though they may also be present in the lower part of the ileum. At first there are seen local swellings on the mucous surface, chiefly due to a sort of inflammatory gelatinous œdema with little leucocytic infiltration; soon, however, the mucous membrane becomes partially ulcerated, more or less extensive necrosis of the subjacent tissues occurs, and thus gangrenous sloughs result. The ulcers thus come to have irregular and overhanging margins, and the excavation below is often of wider extent than the aperture in the mucous membrane. The amœbæ are found in the mucous membrane when ulcers are being formed, but their most characteristic site is beyond the ulcerated area, where they may be seen penetrating deeply into the submucous, and even into the muscular coats. In these positions they may be unattended by any other organisms, and the tissues around them show œdematous swelling and more or less necrotic change without much accompanying cellular reaction; beyond a certain amount of swelling and proliferation of the connective-tissue cells. This action of the amœbæ on the tissues explains the character of the ulcers as just described. These lesions are considered by Councilman and Lafleur to be characteristic of amœbic dysentery.

As a complication of this form of dysentery liver abscesses are of comparatively common occurrence. They are usually single and of large size, sometimes there are more than one, and occasionally numerous small ones may be present. The contents are usually a thick pinkish fluid of somewhat slimy consistence and are largely constituted by necrosed and liquefied tissue with admixture of blood in varying amount. Microscopic examination shows chiefly necrosed and granular cells and débris resulting from their disintegration, whereas ordinary pus corpuscles are scanty or may be practically absent. In such abscesses associated with dysentery the amœbæ are usually to be found, and not infrequently are the only organisms present, no cultures of bacteria being obtainable by the ordinary methods (Fig. 170). They are most numerous at the spreading margin, and this probably explains a fact pointed out by Manson, that examination of the contents first removed may give a negative result, while they may be detected in the discharge a day or two later. The action here on the tissues is of an analogous nature, namely,

a necrosis with softening and partial liquefaction, attended by little or no suppurative change. The amœbæ have also been found in the sputum when a liver abscess has ruptured into the lung, as not very infrequently happens.

Relations to the Disease. — It may be stated in the first place that satisfactory cultures of these amœbæ outside the body have not been obtained. Kartulis announced that he had cultivated the organism on

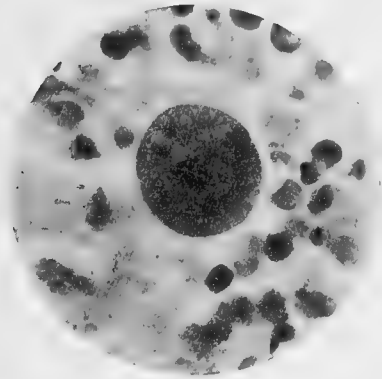

FIG. 170. — Section of wall of liver abscess, showing an amœba of spherical form with vacuolated protoplasm. From a case published by Surgeon-major D. G. Marshall. $\times 1000$.

straw infusion, but it is now recognised that his results are erroneous, the amœbæ observed by him being probably derived from the infusion itself. In fact, everything seems to show that the amœbæ in their usual form rapidly disintegrate outside the body, and it is still unknown in what form they survive and lead to the propagation of the disease. The points of distinction between the amœba of dysentery and the ordinary amœba coli, so far as the morphology is concerned, are that the latter is on the whole of smaller size, its protoplasm is more finely granular, and it does not appear to

take up red corpuscles, etc., as is the case with the former. The distinction, however, can only be definitely drawn by means of experiment. Injections of certain quantities of dysenteric stools containing the amœbæ into various animals *per rectum* have been carried out by different observers, especially by Kruse and Pasquale. In cats, in the majority of cases, a hæmorrhagic enteritis is produced, amœbæ being present in the stools and also invading the mucous membrane of the intestine in the ulcerated areas which are sometimes formed. The deep infiltration of the submucous coat by the amœbæ, which is so characteristic a feature in the human disease, does not occur in these animals. Not infrequently death follows. Kruse and Pasquale obtained corresponding results when the material from a liver abscess, containing amœbæ without any other organisms, was injected. In the absence of cultures of amœbæ outside the body, this result must be taken as strong evidence that the disease produced in cats is really caused by the amœbæ. Similar injections with material containing amœbæ derived from other sources are unattended by any pathogenic effects of similar nature. Feeding the animals with material containing the amœbæ is much more uncertain in its effect. Quincke and Roos obtained no effects when the amœbæ were

administered, but they obtained a fatal result in two out of four cases when the cyst-like forms were given. From this fact they infer that the latter are probably a cystic stage of the former, and that the former are destroyed in the gastric contents. This practically constitutes the only important evidence that a cystic stage of the organism has really been observed. These observers found that the cyst-like bodies were still present even after the material had been kept for two or three weeks.

From the above facts, all of which have received ample confirmation with the exception of the statements regarding the cyst-like forms, there can be little or no doubt that the amœbæ described are the causes of the form of dysentery with which they are associated. We are still ignorant, however, as to their life history outside the body, and the modes by which infection is produced. Further, in any case where they act as the primary agent, secondary inflammatory changes in the intestine may be produced by the action of various bacteria. It is also of importance to note that the serum of patients suffering from amœbic dysentery gives no agglutinating reaction with Shiga's bacillus of dysentery (*vide* p. 349).

Methods of Examination. — The fæces in a case of suspected dysentery ought to be examined microscopically as soon as possible after being passed, as the amœbæ disappear rapidly, especially when the reaction becomes acid. A drop is placed on a slide without the addition of any reagent, a cover-glass is placed over it but not pressed down, and the preparation is examined in the ordinary way or on a hot stage, preferably by the latter method, as the movements of the amœbæ become more active and it is difficult to recognise them when they are at rest. Hanging-drop preparations may also be made by the methods described. Dried films are not suitable, as in the preparation of these the amœbæ become broken down; but films may be fixed with corrosive sublimate or other fixative (*vide* p. 90). In sections of tissue the amœbæ may be stained by methylene-blue, by safranin, by hæmatoxylin and eosin, etc. Benda's method of staining with safranin and light-green is also a very suitable one. Sections are stained for several hours in a saturated solution of safranin in aniline-oil water (p. 101), they are then washed in water and decolorised in a $\frac{1}{2}$ per cent solution of light green in alcohol till most of the safranin is discharged, the nuclei, however, remaining deeply stained. In this method the nuclei of the amœbæ are coloured red (like those of the tissue cells), the protoplasm being of a purplish tint.

BIBLIOGRAPHY.

GENERAL TEXT-BOOKS. — In English the student may consult the following: "Micro-organisms and Disease," E. Klein, 3rd ed. London, 1896. "Bacteriology and Infective Diseases," Edgar M. Crookshank, London, 1898. "A Manual of Bacteriology," George M. Sternberg, New York, 1st ed. 1893, 2nd ed. 1896 (this book contains a full bibliography). "Text-book upon the Pathogenic Bacteria," Joseph M'Farland, Philadelphia, 1900. "Practical Bacteriology," A. A. Kanthack and J. H. Drysdale, London, 1895. "Bacteria and their Products," G. S. Woodhead, London, 1891. The articles on bacteriological subjects in Clifford Allbutt's "System of Medicine," London, are of the highest excellence, and have full bibliographies appended. For the hygienic aspects of bacteriology see "System of Hygiene," Stevenson and Murphy, London, 1892-94. Atlas and Principles of Bacteriology, by Lehmann and Neumann (trans. by G. H. Weaver), Philadelphia, 1901.

For non-pathogenic bacteria occurring in connection with pathological work consult Heim, *op. cit. infra*. For fungi see De Bary, "Comparative Morphology and Biology of the Fungi, Mycetozoa and Bacteria," trans. by Garnsey and Balfour, Oxford, 1887; Sachs, "Text-book of Botany," trans. by Garnsey and Balfour, Oxford, 1887, ii.

In German: "Die Mikroorganismen," by Dr. C. Flüge, 3rd ed. Leipzig, 1896. (The first edition of this book, published in 1886, was a monograph by Flüge. The third is practically a new work edited by Flüge and written by Frosch, Gotschlich, Kolle, Kruse, and R. Pfeiffer. It contains a very full treatment of the subject and has a complete list of references.) "Lehrbuch der pathologischen Mykologie," by Baumgarten, Braunschweig, 1890. "Grundriss der Bakterienkunde," C. Fraenkel, Berlin, 1890. "Die Methoden der Bakterien-Forschung," F. Hueppe, Wiesbaden, 1891. "Naturwissenschaftliche Einführung in die Bakteriologie," F. Hueppe, Wiesbaden, 1896. "Einführung in das Studium der Bakteriologie," C. Günther, Leipzig, 1893 (4th ed. 1895). "Lehrbuch der bakteriologischen Untersuchung und Diagnostik," L. Heim, Stuttgart, 1894. "System der Bakterien" by Migula, Jena, 1900.

In French: Roger, "Les maladies infectieuses," Paris, 1902. For students, two extremely useful books are "Précis de microbie," by Thoinot and Masselin, 3rd ed. Paris, 1896, and "Précis de bactériologie clinique," Wurtz, Paris, 1895.

PERIODICALS. — For references to current work see *Centralbl. f. Bakteriolog. u. Parasitenk.*, Jena. This publication commenced in 1887. Two volumes are issued yearly. In 1895 it was divided into two parts. Abtheilung I. deals with *Medizinisch-hygienische Bakteriologie und thierische Parasitenkunde.*

The volumes of this part are numbered consecutively with those of the former series, the first issued thus being vol. xvii. Commencing in 1902 with volume xxxi., each volume of Abtheilung I. was further divided into two parts, one consisting of *Originale* the other of *Referate*. Abtheilung II. deals with *Allgemeine landwirtschaftlich-technologische Bakteriologie, Gärungs-physiologie und Pflanzenpathologie*. The first volume is entitled *Zweite Abtheilung, Bd. I*. It contains original articles, *Referate*, etc.

The most complete account of the work of the year is found in the *Jahresh. ü. d. Fortschr. . . . d. path. Mikroorganismen*, conducted by Baumgarten, and published in Braunschweig. This publication commenced in 1887. Its disadvantage is that the volume for any year does not usually appear till two years later.

Bacteriology is also dealt with in the *Index Medicus* and *Bibliographia Medica*. For valuable lists of papers by particular authors see Royal Society Catalogue of Scientific Papers; and Index Catalogue, Library of Surg.-Gen. U. S. Army, Series II, Washington.

The chief bacteriological periodicals are the *Journ. Path. and Bacteriol.*, Edinburgh and London, edited by Sims Woodhead; the *Ztschr. f. Hyg. u. Infectiouskrankh.*, Leipzig, edited by Koch and Flügge, and the *Ann. de l'Inst. Pasteur*, Paris, edited by Duclaux; *Journ. Exper. Med.*, Baltimore, edited by Welch; *Journ. Hyg.*, Cambridge, edited by Nuttall; *Journ. Med. Research*, Boston, edited by H. C. Ernst.

Valuable papers also from time to time appear in the *Lancet*, *Brit. Med. Journ.*, *Bull. Johns Hopkins Hosp.*, *Reports of the Johns Hopkins Hosp.*, *Univ. Pennsylv. Med. Bull.*, *Deutsche med. Wchnschr.*, *Berl. klin. Wchnschr.*, *Semaine méd.*, *Arch. f. Hyg.*, *Arch. f. exper. Path. u. Pharmakol.* Besides these periodicals the student may have to consult the *Reports of the Med. Off. of the Local Government Board*, which contain the reports of the medical officers, also the *Proc. Roy. Soc. London*, the *Compt. rend. Acad. d. sc.*, Paris, the *Compt. rend. Soc. de biol.*, Paris, and the *Arb. u. d. k. Gsndtsamte*. (the first two volumes of the last were denominated *Mittheilungen*).

CHAPTER I.—GENERAL MORPHOLOGY AND BIOLOGY.

Consult here especially Flügge, "Die Mikroorganismen." De Bary, "Bacteria," translated by Garnsey and Bayley Balfour, Oxford, 1887. Zopf, "Zur Morphologie der Spaltpflanzen," Leipzig, 1882; "Beitr. z. Physiologie und Morphologie niederer Organismen," 5th ed., Leipzig, 1895. Cohn, *Beitr. z. Biol. d. Pflanz.*, Bresl. (1876), ii. v. Nägeli, "Die niederen Pilze," Munich, 1877; "Untersuchungen über niedere Pilze," Munich, 1882. Migula, "System der Bakterien," Jena, 1900. Duclaux, "Traité de microbiologie," Paris, 1898-99. For general morphological relations see Marshall Ward, art. "Schizomycetes," *Encyc. Brit.*, 9th ed., xxi. 398; xxvi. 51. Engler u. Prantl, "Die natürlichen Pflanzenfamilien," Lieferung 129.—"Schizophyta" (by W. Migula). STRUCTURE OF BACTERIAL CELL.—Bütschli, "Über den Bau der Bakterien," Leipzig, 1890; "Weitere Ausführungen über den Bau der Cyanophyceen und Bakterien," Leipzig, 1896. Fischer, *op. cit.* in text. Buchner, Longard u. Riedlin, *Centralbl.*

f. Bakteriolog. u. Parasitenk., ii. 1. Ernst, *Ztschr. f. Hyg.*, v. 428; Babes, *ibid.*, v. 173. Neisser, *ibid.*, iv. 165. Nakanishi, *Centralbl. f. Bakt. u. Parasitenk.*, Abt. I., Bd. xxx., Nos. 4, 5, and 6. MOTILITY. — Klein, Bütschli, Fischer, Cohn, *loc. cit.* Löffler, *Centralbl. f. Bakteriolog. u. Parasitenk.*, vi. 209; vii. 625. PIGMENTS. — Zopf, *loc. cit.*; Galeotti, Ref. in *Centralbl. f. Bakteriolog. u. Parasitenk.*, xiv. 696. Babes, *Ztschr. f. Hyg.*, xx. 3. SPORULATION. — Prazmowski, *Biol. Centralbl.*, viii. 301. A. Koch, *Botan. Ztg.*, (1888) Nos. 18–22. Buchner, *Sitzungsb. d. math.-phys. Cl. d. k. bayer. Akad. d. Wissensch. zu München*, 7th Feb. 1880. R. Koch, *Mitth. a. d. k. Gsndhtsamte.*, i. 65. CHEMICAL STRUCTURE OF BACTERIA. — Nencki, *Ber. d. deutsch. Chem. Gesellsch.*, (1884) xvii. 2605. Cramer, *Arch. f. Hyg.*, xvi. 154. Buchner, *Berl. klin. Wchnschr.*, (1890) 673, 1084; *vide* Flügge, *op. cit.* CLASSIFICATION OF BACTERIA. — For general review see Marshall Ward, *Ann. of Botany*, vi. 103; Migula, *loc. cit. supra.* Lachner-Sandoval, *Ueber Strahlenpilze [Inaug. Dissert.]*, Strassburg, 1898. FOOD OF BACTERIA. — Nägeli, Cohn, *op. cit.* Pasteur, “Études sur la bière,” 1876. Hueppe, *Mitth. a. d. k. Gsndhtsamte.*, ii. 309. RELATIONS TO OXYGEN. — Pasteur, *Compt. rend. Acad. d. sc.*, lii. 344, 1142; Kitasato u. Weyl, *Ztschr. f. Hyg.*, viii. 41, 404; ix. 97. TEMPERATURE. — *Vide* Flügge, *op. cit.*; for thermophilic bacteria, Rabinowitsch, *Ztschr. f. Hyg.*, xx. 154; Macfadyen and Blaxall, *Journ. Path. and Bacteriol.*, iii. 87. ACTION OF BACTERIAL FERMENTS. — Salkowski, *Ztschr. f. Biol.*, N.F. vii. 92; Pasteur et Joubert, *Compt. rend. Acad. d. sc.*, lxxxiii. 5; Sheridan Lea, *Journ. Physiol.*, vi. 136; Beijerinck, *Centralbl. f. Bakteriolog. u. Parasitenk.*, Abth. II. i. 221; E. Fischer, *Ber. d. deutsch. chem. Gesellsch.*, xxviii. 1430; Liborius, *Ztschr. f. Hyg.*, i. 115; see also Pasteur, “Royal Society Catalogue of Scientific Papers.” VARIABILITY. — Cohn, Nägeli, Flügge, *op. cit.* Winogradski, “Beitr. z. Morph. u. Physiol. d. Bakt.,” Leipzig, 1888; Ray Lankester, *Quart. Journ. Micr. Sc.*, N.S. (1873) xiii. 408; (1876) xvi. 27, 278. NITRIFYING ORGANISMS. — Winogradski, *Ann. de l’Inst. Pasteur*, iv. 213, 257, 760; v. 92, 577. Mazé, *ibid.*, xi. 44; xii. 1, 263.

CHAPTER II. — METHODS OF CULTIVATION OF BACTERIA.

FOR GENERAL PRINCIPLES. — Pasteur, *Compt. rend. Acad. d. sc.*, l. 303; li. 348, 675; *Ann. de chem.*, lxiii. 5; Tyndall, “Floating Matter of the Air in Relation to Putrefaction and Infection,” London, 1881; H. C. Bastian, “The Beginnings of Life,” London, 1872. METHODS OF STERILISATION. — R. Koch, Gaffky, and Löffler, *Mitth. a. d. k. Gsndhtsamte.*, i. 322; Koch u. Wolffhügel, *ibid.*, i. 301. CULTURE MEDIA. — See text-books, especially Kanthack and Drysdale; Pasteur, “Études sur la bière,” Paris, 1876; R. Koch, *Mitth. a. d. k. Gsndhtsamte.*, i. 1; Roux et Nocard, *Ann. de l’Inst. Pasteur*, i. 1; Roux, *ibid.*, ii. 28; Durham, *Jour. Exper. Med.*, 1901, v. 353; Marmorek, *Ann. de l’Inst. Pasteur*, ix. 593; Hiss, *Science*, (1902) Mar. 7. Kitasato u. Weyl, *op. cit. supra*; P. and Mrs. Percy Frankland, “Micro-organisms in water,” London, 1894. Fuller, *Rep. Amer. Pub. Health Ass.*, xx. 381. Theobald Smith, *Centralbl. f. Bakteriolog. u. Parasitenk.*, vii. 502; xiv. 864. Durham, *Brit. Med. Journ.*, 1898, i. 1387. “Report of American Committee on Bacteriological Methods,” Concord, 1898. Park, *Centralbl. f. Bakt. u.*

Parasitenk., Abt. I. Bd. xxix. 445. Wright, *Journ. Boston Soc. Med. Sc.*, (1900) iv. 119. Hill, *Journ. Med. Research*, (1902) n. s. II. 202. Harris, *Johns Hopkins Hosp. Bull.*, (1902) No. 134, 112. Hill, *Journ. Boston Soc. Med. Sc.*, (1899) Jan. Th. Smith, *Wilder Quart. Cent. Book*, (1893) 187. Novy, *Laboratory Work in Bacteriology*, 2nd ed., 1899.

CHAPTER III. — MICROSCOPIC METHODS, ETC.

Consult text-books, especially Klein, Kanthack and Drysdale, Huppe, Günther, Heim, Thoinot et Masselin; also Bolles Lee, "The Microtomist's Vademecum," 5th ed., London, 1900 (this is the most complete treatise on the subject). Rawitz, *op. cit.* in text; Koch, *Mitth. u. d. k. Gsndhtsamte.*, i. 1; Ehrlich, *Ztschr. f. klin. Med.*, i. 553; ii. 710. Gram, *Fortschr. d. Med.* (1884) ii. No. 6; Nicholle, *Ann. de l'Inst. Pasteur*, ix. 666; Kühne, "Praktische Anleitung zum mikroskopischen Nachweis der Bakterien im tierischen Gewebe," Leipzig, 1888; Van Ermengem, *ref. Centralbl. f. Bakteriol. u. Parasitenk.*, xv. 969; Kendall, *Journ. App. Microscopy*, v. No. 6, 1836. Richard Muir, *Journ. Path. and Bacteriol.*, v. 374; Mann, "Physiological Histology," Oxford, 1902.

AGGLUTINATION. — Delépine, *Brit. Med. Journ.*, (1897) ii. 529, 967. Widal et Sicard, *Ann. de l'Inst. Pasteur*, xi. 353. Wright, *Brit. Med. Journ.*, (1897) i. 139; (1898) i. 355.

CHAPTER IV. — BACTERIA OF AIR, SOIL, WATER. ANTISEPTICS.

AIR, SOIL, AND WATER. — Petri, *Ztsch. f. Hyg.*, iii. 1; vi. 233. Sedgwick and Tucker, *Proc. Soc., Arts Mass. Inst. Tech.*, (1887-8) 51, (Boston). Tucker, *Twentieth Annl. Rept. State Bd. Health of Mass.*, (1888) 161. Flügge, *Ztsch. f. Hyg.*, xxv., 179. Sticher, *ibid.*, xxx., 163. Weyl, "Handbuch der Hygiene," Jena, 1896, *et seq.* Houston, *Rep. Med. Off. Local Gov. Bd.*, xxvii. (1897-98) 251; xxviii. (1898-99) 413, 439, 467; xxix. (1899-1900) 458, 489. Stone, *Amer. Med.*, (1902) Jan. 25, 154. MacConkey, *Thomp. Yates Lab. Repts.*, (1900) III. i. 41; *ibid.*, (1901) III. ii. 151. MacConkey and Hill, *ibid.*, (1901) IV. i. 151. Grünbaum and Hume, *Brit. Med. Journ.*, (1902) June 14, 1473. Sidney Martin, *ibid.*, xxvi. (1896-97) 231; xxvii. (1897-98) 308; xxviii. (1898-99) 382. Horrocks, "Bacteriological Examination of Water," London, 1901. Percy and G. C. Frankland, "Micro-organisms in Water," London, 1894. Dibdin, "Purification of Sewage and Water," London, 1897. *Ann. Rep. Bd. Health, Mass.*, Boston, 1890, *et seq.*

ANTISEPTICS. — R. Koch, *Mitth. u. d. k. Gsndhtsamte.*, i. 234. Behring, *Ztsch. f. Hyg.*, ix. 395. Ritchie, *Trans. Path. Soc.*, London, l. 256. Rideal, "Disinfection and Disinfectants," London, 1898.

CHAPTER V. — FUNGI: NON-PATHOGENIC AND PATHOGENIC.

FOR NON-PATHOGENIC bacteria usually occurring in man consult Heim, *op. cit.* For fungi see De Bary, "Comparative Morphology and Biology of the Fungi, Mycetoza and Bacteria," trans. by Garnsey and Balfour, Oxford, 1887;

Sachs, "Text-book of Botany," trans. by Garnsey and Balfour, Oxford, 1887, ii. PATHOGENIC FUNGI. — Rolleston in *Allbutt's Syst. of Med.*, 1899. Pearson and Ravenel, *Univ. Med. Mag.*, (Philadelphia) 1900, Aug. Busse, *Centralbl. f. Bakt. u. Parasitenk.*, (1894) xvi. 175. Virchow, *Archiv*, (1895) cxl. 23; *ibid.*, (1896) cxliv. 360. "Die Hefen als Krankheitserreger," Berlin, 1897 (Hirschwald). Buschke, *Volkmann's Samml. Klin. Vorträge*, (1898) No. 218. *Verhand. d. Deutsch. Dermat. Gesellsch.*, VI. Congr., (1899) 181. Gilchrist, *Johns Hopkins Hosp. Repts.*, (1896) i. 269. Gilchrist and Stokes, *Journ. Exper. Med.*, (1898) iii. 53. Schenck, *Johns Hopkins Hosp. Bull.*, (1898) ix. 286. Ophüls and Moffitt, *Philadel. Med. Journ.*, (1900) June 30. Montgomery, *Brit. Journ. Dermat.*, xii. No. 144. Ricketts, *Journ. Med. Research*, (1901) vi. No. 3. Hektoen, *Journ. Exper. Med.*, (1899) iv. 261. Hektoen and Perkins, *ibid.*, (1900) V. i. 77.

CHAPTER VI. — RELATIONS OF BACTERIA TO DISEASE, ETC.

As the observations on which this chapter is based are scattered through the rest of the book, the references to them will be found under the different diseases.

CHAPTER VII. — INFLAMMATORY AND SUPPURATIVE CONDITIONS.

Ogston, *Brit. Med. Journ.*, (1881) i. 369. Rosenbach, "Mikroorganismen bei den Wundinfektionskrankheiten des Menschen," Wiesbaden, 1884. Passet, *Fortschr. d. Med.*, (1885) Nos. 2 and 3. Welch, *Trans. Congr. Amer. Phys. and Surg.*, (1891) ii.; *Maryland Med. Journ.*, (1891) Nov. 14. W. Watson Cheyne, "Suppuration and Septic Diseases," Edinburgh, 1889. Grawitz, *Virchow's Archiv*, cxvi. 116; *Deutsche med. Wchnschr.*, (1889) No. 23. Steinhaus, *Ztschr. f. Hyg.*, v. 518 (micrococcus tetragenus); "Die Aetiologie der acuten Eiterung," Leipzig, 1889. Christmas-Dirckinck-Holmfeld, "Recherches expérimentales sur la suppuration," Paris, 1888. Muir, *Journ. Path. and Bacteriol.*, vii. 161; *Trans. Path. Soc. London*, 1902. Garré, *Fortschr. d. Med.*, (1885) No. 6. Marmorek, *Ann. de l'Inst. Pasteur*, ix. 593. Petruschky, *Ztschr. f. Hyg.*, xvii. 59; xviii. 413; xxiii. 142; (with Koch, xxiii. 477). Lübbert, "Biologische Spaltpilzuntersuchung," Würzburg, 1886. Krause, *Fortschr. d. Med.*, (1884) Nos. 7 and 8. Ribbert, *Fortschr. d. Med.*, (1886) No. 1. Widal et Besançon, *Ann. de l'Inst. Pasteur*, ix. 104. V. Lingsheim, *Ztschr. f. Hyg.*, x. 331; xii. 308. Behring, *Centralbl. f. Bakteriologie u. Parasitenk.*, xii. 192. Thoinet et Masselin, *Rev. de méd.*, (1894) 449. Orth u. Wyssokowitsch, *Centralbl. f. d. med. Wissensch.* (1885) 577. Netter, *Arch. de physiol. norm. et path.*, (1886) 106. Weichselbaum, *Wien. med. Wchnschr.*, (1885) No. 41; (1888) Nos. 28-32; *Centralbl. f. Bakteriologie u. Parasitenk.*, ii. 209; *Beitr. z. path. Anat. u. z. allg. Path.*, iv. 127. Becker, *Deutsche med. Wchnschr.*, (1883) No. 46. Lannelongue et Achard, *Ann. de l'Inst. Pasteur*, v. 209. Fehleisen, "Die Aetiologie des Erysipels," Berlin, 1883. Welch, *Am. Journ. Med. Sc.*, 1891, 439. Lemoine, *Ann. de l'Inst. Pasteur*, ix. 877. Kurth, *Arch. a. d. k. Gsundtsamte.*, vii. 389. Knorr, *Ztschr. f. Hyg.*, xiii. 427. Bulloch, *Lancet*, (1896) i. 982, 1216. Bordet, *Ann. de*

l'Inst. Pasteur, xi. 177. Booker (streptococcus enteritis), *Johns Hopkins Hosp. Rep.*, vi. 159. Hirsch, *Centralbl. f. Bakteriolog. u. Parasitenk.*, xxii. 369. Libman, *ibid.*, xxii. 376. Gilchrist, *Contrib. to the Sc. of Med.*, dedicated by his pupils to William H. Welch, Baltimore, (1900) 409. MacCallum and Hastings, *Journ. Exper. Med.*, (1899) iv. 521. Harris and Longcope, *Centralbl. f. Bakt. u. Parasitenk.*, Abt. i. Bd. xxx. No. 9.

Meningitis.—Weichselbaum, *Fortschr. d. Med.*, (1887) v. 573, 620. Jaeger, *Ztschr. f. Hyg.*, xix. 351. Councilman, Mallory, and Wright, "Epidemic Cerebro-spinal Meningitis," *Rep. Bd. Health Mass.*, Boston, 1898 (full references). Gwyn, *Johns Hopkins Hosp. Bull.*, (1899) 109.

Conjunctivitis.—Morax, *Ann. de l'Inst. Pasteur*, (1896) x. 337. Eyre, *Journ. Path. and Bacteriol.*, vi. 1. Müller, *Wien. med. Wchnschr.*, 1897. Axenfeld, "Ergebnisse der Allgem. Pathol. u. Path. Anat." (Lubarsch u. Ostertag) 1901 (full references).

Acute Rheumatism.—Triboulet et Coyon, *Bull. Soc. méd. d. hôp. de Paris*, (1898) 93. Westphal, Wassermann u. Malkoff, *Berl. klin. Wchnschr.*, (1899) 638. Poynton and Paine, *Lancet*, (1900) ii. 861, 932 (full references). Achalme, *Archiv. de Méd. Expér.*, (1898) xi. 370; *Gaz. Méd. de Paris*, (1901) Apr. 6. Thiroloix, *Sem. méd.*, (1896) 376, 420, 945. Bettencourt, *Archiv. de Méd.*, ii. 298. Hewlett (read before Chelsea Clin. Soc.), 1901. Gwyn, *Johns Hopkins Hosp. Bull.*, (1900) xi. 185. Foulerton and Rist, *Lancet*, (1901) 553. Poynton and Paine, *Lancet*, (1901) May 4, July 13, Aug. 24; *Centralbl. f. Bakt. u. Parasitenk.*, Abt. i. Bd. xxxi. 502. Singer, *Wien (Braunmüller)*, 1898; *Wiener Klin. Woch.*, (1901) No. 20, 482. Meyer, *Deutsch. med. Woch.*, (1901) Feb. 7. Menzer, *ibid.*, (1901) Feb. 14. Allaria, *Riv. crit. di clin. Med.*, (1901) Nov. 23; (ref. *Brit. Med. Journ.*, 1902, Jan. 11).

CHAPTER VIII.—INFLAMMATORY AND SUPPURATIVE CONDITIONS, CONTINUED: ACUTE PNEUMONIAS.

Sternberg, *Natnl. Board of Health Rept.*, Washington, (1881) 74, 75. Pasteur, *Bull. de l'Acad. de Méd.*, (1881) Jan. 18 and 25, Feb. 1 and 8, Mar. 22 and 29. Friedländer, *Fortschr. d. Med.*, i. No. 22; ii. 287; *Virchow's Archiv*, lxxxvii. 319. A. Fraenkel, *Ztschr. f. klin. Med.* (1886) 401. Salvioli u. Zäslein, *Centralbl. f. d. med. Wissensch.*, (1883) 721. Ziehl, *ibid.*, (1883) 433; (1884) 97. Klein, *ibid.*, (1884) 529. Jürgensen, *Berl. klin. Wchnschr.*, (1884) 270. Seibert, *ibid.*, (1884) 272, 292. Senger, *Arch. f. exper. Path. u. Pharmakol.*, (1886) 389. Weichselbaum, *Wien. med. Wchnschr.*, xxxvi. 1301, 1339, 1367; *Monatschr. f. Ohrenh.*, (1888) Nos. 8 and 9; *Centralbl. f. Bakteriolog. u. Parasitenk.*, v. 33. Prochaska, *Centralbl. f. inner. Med.*, Bd. xxi. No. 46; *Deutsch. Arch. f. kl. Med.*, Bd. lxx. Cole, *Johns Hopkins Hosp. Bull.*, (1902) Nos. 135, 136. Gamaléia, *Ann. de l'Inst. Pasteur*, ii. 440. Guarnieri, *Atti d. r. Accad. med. di Roma*, (1888) ser. ii. iv. Kruse u. Pansini, *Ztschr. f. Hyg.*, xi. 279. E. Fraenkel u. Reiche, *Ztschr. f. klin. Med.*, xxv. 230. Sanarelli, *Centralbl. f. Bakteriolog. u. Parasitenk.*, x. 817. Lannelongue, *Gaz. d. hôp.*, (1891) 379. Netter, *Bull. et mém. Soc. méd. d. hôp. de Paris*, (1889); *Compt. rend. Acad. d. sc.*, (1890); *Compt. rend.*

Soc. de biol., lxxxvii. 34. G. u. F. Klemperer, *Berl. klin. Wchnschr.*, (1891) 893, 869. Foà u. Bordoni-Uffreduzzi, *Deutsche med. Wchnschr.*, (1886) No. 33. Emmerich, *München. med. Wchnschr.*, (1891) No. 32. Issaëff, *Ann. de l'Inst. Pasteur*, vii. 260. Grimbert, *Ann. de l'Inst. Pasteur*, xi. 840. Washbourn, *Brit. Med. Journ.*, (1897) i. 510; (1897) ii. 1849. Eyre and Washbourn, *Journ. Path. and Bacteriol.*, iv. 394; v. 13. See also *Brit. Med. Journ.*, (1901) ii. 760.

CHAPTER IX. — GONORRHOEA, SOFT SORE, SYPHILIS.

GONORRHOEA. — Neisser, *Centralbl. f. d. med. Wissensch.*, (1879) 497; *Deutsche med. Wchnschr.*, (1882) 279; (1894) 335. Bumm, "Der Mikroorganismus der gonorrhöischen Schleimhautrekrankungen," Wiesbaden, 1885, 2nd ed. 1887; *München. med. Wchnschr.*, (1886) No. 27; (1891) Nos. 50 and 51; *Centralbl. f. Gynäk.*, (1891) No. 22; *Wien. med. Presse*, (1891) No. 24. Bockhart, *Monatsh. f. prakt. Dermat.*, (1886) v. No. 4; (1887) vi. 19. Steinschneider, *Berl. klin. Wchnschr.*, (1890) No. 24; (1893) No. 29; *Verhandl. d. deutsch. dermat. Gesellsch. I. Congress*, Wien, 1889, 159. Wertheim, *Wien. klin. Wchnschr.*, (1890) 25; *Deutsche med. Wchnschr.*, (1891) No. 50; *Arch. f. Gynaek.*, xli. Heft 1; *Centralbl. f. Gynäk.*, (1891) No. 24; (1892) No. 20; *Wien. klin. Wchnschr.*, (1894) 441. Gerhardt, *Charité-Ann.*, (1889) 241. Leyden, *Ztschr. f. klin. Med.* xxi. 607; *Deutsche med. Wchnschr.*, (1893) 909. Bordoni-Uffreduzzi, *ibid.*, (1894) 484. Councilman, *Am. Journ. Med. Sc.*, cvi. 277. Finger, Ghon, u. Schlagenhauer, *Arch. f. Dermat. u. Syph.*, xxviii. 3, 276. Lang, *ibid.*, (1892) 1007; *Wien. med. Wchnschr.*, (1891) No. 7; "Der Venerische Katarrh, dessen Pathologie und Therapie," Wiesbaden, 1893. Klein, *Monatsh. f. Geburtsh. u. Gynaek.*, (1895) 33. Michaelis, *Ztschr. f. klin. Med.* xxix. 556. Heiman, *New York Med. Rec.*, (1895) 769, (1896) Dec. 19. Foulerton, *Trans. Brit. Inst. Preven. Med.*, i. 40. Frank, *Med. News*, (1895) Oct. 19. Meija, *Thèse de Paris*, (ref. *Centralbl. f. all. Path. u. path. Anat.*, 1897, Bd. xii. 83). Cushing, *Johns Hopkins Hosp. Bull.*, (1899) No. 98, 75. Hunner and Harris, *ibid.*, (1902) No. 135, 121. De Christmas, *Ann. de l'Inst. Pasteur*, xi. 609. Nicolaysen, *Centralbl. f. Bakteriolog. u. Parasitenk.*, xxii. 305. Rendu, *Berl. klin. Wchnschr.* (1898) 431. Wassermann, *Ztschr. f. Hyg.*, xxvii. 298; *München. med. Wchnschr.*, 1901, No. 8. Lenhart, *Berl. klin. Wchnschr.*, 1897, 1138. Thayer and Lazear, *Journ. Exper. Med.*, iv. 81. Wilson, *New York Univ. Bull. Med. Sc.*, (1901) i. No. 3. Harris and Johnston, *Johns Hopkins Hosp. Bull.*, (1902) No. 139, 236. König, *Berl. klin. Wchnschr.*, 1901, No. 47. De Christmas, *Ann. de l'Inst. Pasteur*, (1900) xiv. 331. Raskai, *Deutsche med. Wchnschr.*, 1901, No. 1. Jundell, *Centralbl. f. Bakteriolog. u. Parasitenk.*, xxix. 224. Colombini, *ibid.*, xxiv. 955.

SOFT SORE. — Ducrey, *Monatsh. f. prakt. Dermat.*, ix. 221. Krefling, *Arch. f. Dermat. u. Syph.*, (1892) 263. Jullien, *Journ. d. mal. cutan. et syph.*, (1892) 330. Unna, *Monatsh. f. prakt. Dermat.*, (1892) 475; (1895) 61. Quinquand, *Semaine méd.*, (1892) 278. Petersen, *Centralbl. f. Bakteriolog. u. Parasitenk.*, xiii. 743; *Arch. f. Dermat. u. Syph.*, (1894) 419. Audrey, *Monatsh. f. prakt. Dermat.*, (1895) 267. Colombini, *Centralbl. f. Bakteriolog.*

u. Parasitenk., xxv. 254. Besançon, Griffon, et le Sourd, *Annal. de dermat. et syph.*, 1901.

SYPHILIS. — Lustgarten, *Wien. med. Wchnschr.*, (1884) No. 47. Doutrelepont u. Schütz, *Deutsche med. Wchnschr.*, (1885) No. 19. Gottstein, *Fortschr. d. Med.*, (1885) No. 16. De Michele and Radice, *Gior. internaz. di sc. Med.*, (1892) 535. Sabouraud, *Ann. de l'Inst. Pasteur*, vi. 184. Golasz, *Journ. d. mal. cutan. et syph.*, (1894) 170. Markuse, *Vrtljchr. f. Dermat. u. Syph.*, (1883) No. 3. van Niessen, *Centralbl. f. Bakteriolog. u. Parasitenk.*, xxiii. 49. Joseph u. Piorkowski, *Berl. klin. Woch.*, (1902) No. 13, 282.

CHAPTER X. — TUBERCULOSIS.

Klencke, "Untersuchungen und Erfahrungen im Gebiet der Anatomie, etc.," Leipzig, 1843. Villemin, "De la virulence et de la spécificité de la tuberculose," Paris, 1868. Cohnheim u. Fraenkel, "Experimentelle Untersuchungen über der Übertragbarkeit der Tuberculose auf Thiere." Cohnheim, "Die Tuberculose vom Standpunkt der Infectionslehre," 1879. Various Authors, "Discussion sur la tuberculose," *Bull. Acad. de méd.*, (1867) xxxii., xxxiii. Armani, "Novimento med.-chir." Naples, 1872. Baumgarten, "Lehrb. d. path. Myk.," 1890. Straus, "La tuberculose et son bacille," Paris, 1895. Koch, *Berl. klin. Wchnschr.*, (1882) 221; *Mitth. u. d. k. Gsndhtsamte*, 1884; *Deutsche med. Wchnschr.*, (1890) No. 46 a; (1891) Nos. 3 and 43; (1897) No. 14. Bulloch, *Lancet*, (1901), ii. 243. Nocard, "The Animal Tuberculosés," (trans.) London, 1895. Cornet, *Ztschr. f. Hyg.*, v. 191. Nocard et Roux, *Ann. de l'Inst. Pasteur*, i. 19. Pawlowsky, *ibid.*, ii. 303. Sander, *Arch. f. Hyg.*, xvi. 238. Coppens Jones, *Centralbl. f. Bakteriolog. u. Parasitenk.*, xvii. 1. Prudden and Hodenpyl, *New York Med. Rec.* (1891) 636. Vissman, *Virchow's Archiv*, cxxix. 163. Straus et Gamaléia, *Arch. de méd. expér. et d'anat. path.*, iii. No. 4. Courmont, *Semaine méd.*, (1893) 53; *Revue de méd.*, (1891) No. 10. Héricourt et Richet, *Bull. méd.*, (1892) 741, 966. Williams, *Lancet*, (1883) i. 312. Pawlowsky, *Ann. de l'Inst. Pasteur*, vi. 116. Smith, *Th. Journ. Exper. Med.*, (1899) iv. 217. Maffucci, "Sull azione tossica dei prodotti del bacillo della tuberculosi"; *Centralbl. f. allg. Path. u. path. Anat.*, i. 404. Kruse, *Beitr. z. path. Anat. u. z. allg. Path.*, xii. 221. Bollinger, *München. med. Wchnschr.*, (1889) No. 37; *Verhandl. d. Gesellsch. deutsch. Naturf. u. Aertze*, (1890) ii. 187. Hofmann, *Wien. med. Wchnschr.*, (1894) No. 38. Straus et Würtz, *Cong. p. l'étude de la tuberculose*, Paris, July, 1888. Gilbert et Roger, *Mém. Soc. de biol.*, (1891). Diem, *Monatsh. f. prakt. Thierh.*, iii. 481. Weyl, *Deutsche med. Wchnschr.*, (1891) 256. Buchner, *Centralbl. f. Bakteriolog. u. Parasitenk.*, xi. 488. Courmont et Dor, *Province méd.*, (1890) No. 50. Tizzoni u. Centanni, *Centralbl. f. Bakteriolog. u. Parasitenk.*, xi. 82. Ribbert, *Deutsche med. Wchnschr.*, (1892) 353. Virchow, *ibid.*, (1891) 131. Hunter, *Brit. Med. Journ.*, (1891) July 25. Kühne, *Ztschr. f. Biol.*, xxix. 1; xxx. 221. Krehl, *Arch. f. exper. Path. u. Pharmakol.*, xxxv. 222. Krehl u. Matthes, *ibid.*, xxxvi. 437. Bang, "La lutte contre la tuberculose en Danemark," Geneva, 1895. Maragliano, "Le sérum antituberculeux et son anti-toxin," Paris, 1896; *Berl. klin. Wchnschr.*, (1896) 409, 437, 773. Nocard,

Ann. de l'Inst. Pasteur, xii. 561. Stockman, *Brit. Med. Journ.*, (1898) ii. 601. Maragliano, *ref. Brit. Med. Journ., Épitome*, (1896) i. 63. Baumgarten u. Walz, *Centralbl. f. Bakteriolog. u. Parasitenk.*, xxiii. 587. Smith, T., *Journ. Exper. Med.*, iii. 451. Koch, *Brit. Med. Journ.*, (1901) ii. 189; *Trans. Internat. Congr. of Tuberc.*, London, 1901. Repp, *Amer. Med.*, (1901) Oct. 26, Nov. 2. Delépine, *Brit. Med. Journ.*, (1901) ii. 1224. Bataillon, Dubard, et Terre (fish tuberculosis), *Compt. rend. Soc. de biol.*, 1897, 446. Dubard, *Rev. de la tubercul.*, 1898, 13, 129. Ravenel, *Med. Bull. Univ. Pennsylvania*, May, 1892.

Other acid-fast bacilli.—Moeller, *Deutsche med. Wchnschr.*, 1898, 376. *Centralbl. f. Bakteriolog. u. Parasitenk.*, xxv. 369; *ibid.*, xxx. 513; *Deutsch. med. Woch.*, (1902) June 26, 466. Petri, *Arb. a. d. k. Gsndtsamte.*, 1898, 1; *Hyg. Rundsch.*, (1897) vii. 811. Rabinowitsch, *Deutsche med. Wchnschr.*, 1897, No. 26; 1900, No. 16; *Lancet*, (1901) Sept. 28, 838; *Ztschr. f. Hyg.*, xxvi. 90. Korn, *Arch. f. Hyg.*, xxxvi. 57; *Centralbl. f. Bakteriolog. u. Parasitenk.*, xxvii. 481. Schulze, *Ztschr. f. Hyg.*, xxxi. 153. M. Tobler, *ibid.*, xxxvi. 120. Lubarsch, *ibid.*, xxxi. 187. Hölscher, *Centralbl. f. Bakteriolog. u. Parasitenk.*, xxix. 425. Potet, “Étude sur les bacilles dites ‘acidophiles,’” Paris, 1902. Arloing et Courmont, *Compt. rend. Acad. des Sc.*, (1898) Aug. 8, Sept. 19. Beck u. Rabinowitsch, *Deutsch. med. Woch.*, (1900) No. 25, 400, (1901) No. 10, 145. R. Koch, *ibid.*, (1901) No. 48, 829.

CHAPTER XI.—LEPROSY.

Hansen, *Norsk. Mag. f. Lægevidensk.*, 1874; *Virchow's Archiv*, lxxix. 32; xc. 542; ciii. 388; *Virchow's Festschr.*, (1892) iii. See papers by Neisser and Cornil and Suchard in “Microparasites in Disease” (*New Sydenham Soc.*, 1886). Hansen and Looft, “Leprosy,” Bristol, 1895. Doutrelepont u. Wolters, *Arch. f. Dermat. u. Syph.*, (1892) 55. Thoma, *Sitzungsb. d. Dorpater Naturforsch.*, 1889. Unna, *Dermat. Stud.*, Hamburg, (1887) iv. Bordoni-Uffreduzzi, *Ztschr. f. Hyg.*, iii. 178; *Berl. klin. Wchnschr.*, (1885) No. 11. Arning u. Nonne, *Virchow's Archiv*, cxxxiv. 319. Gairdner, *Brit. Med. Journ.*, (1887) i. 1269. Hutchinson, *Arch. Surg.*, (1889) i. V. Török, “Summary of Discussion on Leprosy at the 1st Internat. Congr. for Dermatol. and Syph.,” v.; *Monatsh. f. prakt. Dermat.*, ix. 238. Profeta, *Gior. internaz. d. sc. med.*, 1889. See *Journal of the Leprosy Investigation Committee*, 1890-91. Philippson, *Virchow's Archiv*, cxxxii. 529. Danielssen, *Monatsh. f. prakt. Dermat.*, (1891) 85, 142. Wesener, *Centralbl. f. Bakteriolog. u. Parasitenk.*, ii. 450; *München. med. Wchnschr.*, (1887) No. 18. Uhlenhuth u. Westphal, *Centralbl. f. Bakteriolog. u. Parasitenk.*, xxix. 233.

CHAPTER XII.—GLANDERS—RHINOSCLEROMA.

Löffler u. Schütz, *Deutsche med. Wchnschr.*, (1882) No. 52. Löffler, *Mitth. a. d. k. Gsndtsamte.*, i. 134. Weichselbaum, *Wien. med. Wchnschr.*, (1885) Nos. 21-24. Preusse, *Berl. thierärztl. Wchnschr.*, (1889) Nos. 3, 5, 11; *ibid.*, (1894) Nos. 39, 51. Gamaléia, *Ann. de l'Inst. Pasteur*, iv. 103. A. Babes, *Arch. de méd. expér. et d'anat. path.*, (1892) 450. Straus, *Compt.*

rend. Acad. d. sc., cviii., 530. M'Fadyean and Woodhead, *Rep. National Vet. Assoc.*, 1888. Baumgarten, *Centralbl. f. Bakteriolog. u. Parasitenk.*, iii. 397. Silveira, *Semaine méd.*, (1891) No. 31. Bonome, *Deutsche med. Wchnschr.*, (1894) 703, 725, 744. Kalning, *Arch. f. Veterinärwissenschaft*, (St. Petersburg) i. Apr., May. Foth, *Centralbl. f. Bakteriolog. u. Parasitenk.*, xvi. 508, 550. M'Fadyean, *Journ. Comp. Path. and Therap.*, 1892, 1893, 1894. Leclaiche et Montané, *Ann. de l'Inst. Pasteur*, vii. 481. Leo, *Ztschr. f. Hyg.*, vii. 505. Marx, *Centralbl. f. Bakteriolog. u. Parasitenk.*, xxv. 275. Mayer, *ibid.*, xviii. 673. Frothingham, *Journ. Med. Research*, (1901) n s. i. No. 2, 331.

RHINOSCLEROMA. — Frisch, *Wien. med. Wchnschr.*, (1882) No. 32. Cornil et Alvarez, *Arch. de physiolog. norm. et path.*, 1895, 3rd series, vi. 11. Paltauf u. Eiselsberg, *Fortschr. d. Med.*, (1886) Nos. 19, 20. Wolko-witsch, *Centralbl. f. d. med. Wissensch.*, 1886. Dittrich, *Ztschr. f. Heilk.*, viii. 251. Babes, *Centralbl. f. Bakteriolog. u. Parasitenk.*, ii. 617. Pawlowski, *ibid.*, ix., 742; "Sur l'étiologie et la pathologie du rhinosclérome," Berlin, 1891. Paltauf, *Wien. med. Wchnschr.*, (1891) Nos. 52, 53; (1892) Nos. 1, 2. Wilde, *Semaine méd.*, (1896) 336.

CHAPTER XIII. — ACTINOMYCOSIS, ETC.

Bollinger, *Centralbl. f. d. med. Wissensch.*, 1877. J. Israel, *Virchow's Archiv*, lxxiv. 15; lxxviii. 421. Ponfick, *Breslau. aertzl. Ztschr.*, 1879; "Die Aktinomykose des Menschen," 1882. O. Israel, *Virchow's Archiv*, xcvi. 175. Chiari, *Prag. med. Wchnschr.*, 1884. Langhans, *Cor.-Bl. f. schweiz. Aerzte*, xviii. (1888). Lüning u. Hanau, *ibid.*, xix. (1889). Shattock, *Trans. Path. Soc. London*, 1885. Acland, *ibid.*, 1886. Delépine, *ibid.*, 1889. Harley, *Med.-Chir. Trans.*, London, 1886. Crookshank, *ibid.*, 1889; "Manual of Bacteriology," London, 1896. Ransome, *Med.-Chir. Trans.*, London, 1891. M'Fadyean, *Journ. Comp. Path. and Therap.*, 1889. Boström, *Beitr. z. path. Anat. u. z. allg. Path.*, 1890. Wolff u. Israel, *Virchow's Archiv*, cxxvi. 11. Illich, "Beiträge zur Klinik der Aktinomykose," Wien, 1892. Grainger Stewart and Muir, *Edin. Hos. Rep.*, 1893. Leith, *ibid.*, 1894. Gasperini, *Centralbl. f. Bakteriolog. u. Parasitenk.*, xv. 684. Hummel, *Beitr. z. klin. Chir.*, xiii. No. 3. Pawlowsky et Maksutoff, *Ann. de l'Inst. Pasteur*, vii. 544.

Allied *Streptothrices*. — Nocard, *Ann. de l'Inst. Pasteur*, ii. 1888, 293. Eppinger, *Beitr. z. path. Anat. u. z. allg. Path.*, ix. 287, "Ergebnisse der Allgem. Path." (Lubarsch u. Ostertag), iii. 328. Buchholz, *Ztschr. f. Hyg.*, xxiv, 470. Berestnew, *ibid.*, xxix. 94. Flexner, *Journ. Exper. Med.*, iii. 435. Dean, *Trans. Path. Soc. London*, 1900, 26. Birt and Leishman, *Journ. of Hyg.*, ii. 120. Mertens, *Centralbl. f. Bakteriolog. u. Parasitenk.*, xxix. 649. Foulerton, *Trans. Path. Soc. London*, 1902, 56.

MADURA DISEASE. — Carter, "On Mycetoma or the Fungus Disease of India," London. Bassini, Ref. in *Centralbl. f. Bakteriolog. u. Parasitenk.*, iv. 652. Lewis and Cunningham, 11th *Ann. Rep. San. Com. India*. Köbner, *Fortschr. d. Med.*, (1886) No. 17. Kanthack, *Journ. Path. and Bacteriol.*, i. 140. Boyce and Surveyor, *Proc. Roy. Soc. London*, 1893. Vandyke Carter,

Trans. Path. Soc. London, 1886. Vincent, *Ann. de l'Inst. Pasteur*, viii. 129. Wright, J. H., *Journ. Exper. Med.*, iii. 421.

CHAPTER XIV.—ANTHRAX.

Bollinger in Ziemssen's "Cyclopædia of Medicine." Greenfield, "Malignant Pustule" in Quain's "Dictionary of Medicine," London, 1894. Pollender, *Vrtlschr. f. gerichtl. Med.*, viii.; Davaine, *Compt. rend. Acad. d. sc.*, lvii. 220, 351, 386; lix. 393. Koch, Cohn's *Beitr. z. Biol. d. Pflanz.*, ii. Heft 2 (1876). *Mitth. a. d. k. Gsndhtsamte.*, i. 49. Pasteur, *Compt. rend. Acad. d. sc.*, xci. 86, 455, 531, 697; xcii. 209. Buchner, *Virchow's Archiv*, xci. Chamberland, *Ann. de l'Inst. Pasteur*, viii. 161. Chauveau, *Compt. rend. Acad. d. sc.*, xci. 33, 648, 880; xcvi. 553. Czaplewski, *Beitr. z. path. Anat. u. z. allg. Path.*, vii. 47. Gamaléia, *Ann. de l'Inst. Pasteur*, ii. 517. Marshall Ward, *Proc. Roy. Soc. London*, Feb. 1893. Petruschky, *Beitr. z. path. Anat. u. z. allg. Path.*, iii. 357. Weyl, *Ztschr. f. Hyg.*, xi. 381. Behring, *ibid.*, vi. 117; vii. 171. Osborne, *Arch. f. Hyg.*, xi. 51. Roux, *Ann. de l'Inst. Pasteur*, iv. 25. Hankin, *Brit. Med. Journ.*, (1889) ii. 810; (1890) ii. 65. Hankin et Westbrook, *Ann. de l'Inst. Pasteur*, vi. 633. Sidney Martin, *Rep. Med. Off. Loc. Govt. Board*, (1890-91) 255. Marmier, *Ann. de l'Inst. Pasteur*, ix. 533. Rd. Muir, *Journ. Path. and Bacteriol.*, v. 374.

CHAPTER XV.—TYPHOID FEVER, ETC.

Eberth, *Virchow's Archiv*, lxxxi. 58; lxxxiii. 486. Koch, *Mitth. a. d. k. Gsndhtsamte.*, i. 46. Gaffky, *ibid.*, ii. 80. Klebs, *Arch. f. exper. Path. u. Pharmakol.*, xii. 231; xiii. 381. Escherich, *Fortschr. d. Med.*, (1885) Nos. 16, 17. Emmerich, *Arch. f. Hyg.*, iii. 291. Rodet et Roux, *Arch. de méd. expér. et d'anat. path.*, iv. 317. Weisser, *Ztschr. f. Hyg.*, i. 315. Klein, "Micro-organisms and Disease," London, 1896; *Rep. Med. Off. Loc. Govt. Board*, (1892-93) 345; (1893-94) 457; (1894-95) 399, 407, 411. Babes, *Ztschr. f. Hyg.*, ix. 323. Vincent, *Compt. rend. Soc. de biol.*, sér. ix. ii. 62. Birch-Hirschfeld, *Arch. f. Hyg.*, vii. 341. Buchner, *Centralbl. f. Bakteriolog. u. Parasitenk.*, iv. 353. Pfuhl, *ibid.*, iv. 769. Petruschky, *ibid.*, vi. 660. Durham, *Journ. Exper. Med.*, (1901) v. 353. Hunter, *Lancet*, (1901) i. 613. Kitasato, *Ztschr. f. Hyg.*, vii. 515. Chantemesse et Widal, *Bull. méd.*, (1891) No. 82; *Ann. de l'Inst. Pasteur*, vi. 755; vii. 141. Péré, *Ann. de l'Inst. Pasteur*, vi. 512. Neisser, *Ztschr. f. klin. Med.*, xxiii. 93. Nicholle, *Ann. de l'Inst. Pasteur*, viii. 853. Quincke u. Stühlen, *Berl. klin. Wchnschr.*, (1894) 351. A. Fraenkel, *Centralbl. f. klin. Med.* (1886) No. 10. E. Fraenkel u. Simmonds, *ibid.*, (1886) No. 39. Achalme, *Semaine méd.*, (1890) No. 27. Grawitz, *Charité-Ann.*, xvii. 228. Beumer u. Peiper, *Centralbl. f. klin. Med.*, (1887) No. 4; *Ztschr. f. Hyg.*, i. 489; ii. 110, 382. Sirotnin, *ibid.*, i. 465. R. Pfeiffer u. Kolle, *Ztschr. f. Hyg.*, xxi. 203. R. Pfeiffer, *Deutsche med. Wchnschr.*, (1894) 898. Sanarelli, *Ann. de l'Inst. Pasteur*, vi. 721; viii. 193, 353. Brieger u. Fraenkel, *Berl. klin. Wchnschr.*, (1890) 241, 268. Brieger, Kitasato, u. Wassermann, *Ztschr. f. Hyg.*, xii. 137. Widal, *Semaine méd.*, (1896) 295, 303. Achard, *ibid.*, 295, 303. Grünbaum, *Lancet*, Sept. 1896.

Delépine, *Brit. Med. Journ.*, (1897) i. 529, 967; *Lancet*, Dec. 1896. Remlinger et Schneider, *Ann. de l'Inst. Pasteur*, xi. 55, 829. Widal et Sicard, *ibid.*, xi. 353. Peckham, *Journ. Exper. Med.*, ii. 549. Richardson, *ibid.*, iii. 349. Nichols, *Journ. Exper. Med.*, (1899) iv. 189. Karlinski, *Prager med. Woch.*, (1890) xv. 437 and 452. Richardson, *Journ. Exper. Med.*, (1898) iii. 349; *Philadel. Med. Journ.*, (1900) Mar. 3. Gwyn, *ibid.* Neufeld, *Zeit. f. Hyg. u. Infektskr.*, xxx. No. 3, 449. Curschmann, *Münch. med. Woch.*, (1899) Nov. 28. Wright and Semple, *Brit. Med. Journ.*, (1897) i. 256. Wright and Lamb, *Lancet*, (1899) ii. 1727. Wright, *ibid.*, (1900) i. 150; ii. 1556; *ibid.*, (1901) i. 609, 858, 1272, 1532; ii. 715, 1107; *ibid.*, (1902) ii. 651; *Brit. Med. Journ.*, (1900) ii. 113; *ibid.*, (1901) i. 645, 771. Wright and Leishman, *ibid.*, (1900) i. 622. See also discussion at the *Clin. Soc. London, Brit. Med. Journ.*, (1901) ii. 1342. Sidney Martin, *ibid.*, (1898) i. 1569, 1644; ii. 11, 73. Bokenham, *Trans. Path. Soc. London*, (1898) xlix. 373. Christophers, *Brit. Med. Journ.*, (1898) i. 71. Remy, *Ann. de l'Inst. Pasteur*, xiv. 555, 705. Elsner, *Centralbl. f. Bakt. u. Parasitenk.*, Abt. i., (1895) 590; *Zeit. f. Hyg. u. Infektskr.*, Bd. xxi. 25. Capaldi, *ibid.*, Bd. xxiii. 452, 475. Hiss, *Journ. Exper. Med.*, (1897) ii. 677; *Journ. Med. Research*, (1902) June, 148. Piorkowski, *Berl. kl. Woch.*, (1899) No. 7. Drigalski u. Conradi, *Zeit. f. Hyg. u. Infektskr.*, (1902) Heft 2, 283. Wyatt Johnston, *ibid.*, (1897) i. 231; *Lancet*, (1897) ii. 1746. Durham, *Lancet*, (1898) i. 154; *ibid.*, ii. 446. Lorrain Smith and Tennant, *Brit. Med. Journ.*, (1899) i. 193. Gordon, *Journ. Path. and Bacteriol.*, iv. 438. Widal et Nobécourt, *La Semaine méd.*, (1897) 285. Gwyn, *Johns Hopkins Hosp. Bull.*, (1898) ix. 54. Schottmüller, *Deut. med. Woch.*, (1900) No. 32, 511; *Zeit. f. Hyg. u. Infektskr.*, (1901) xxxvi. 368. Johnston, *Amer. Journ. med. Sc.*, (1902) Aug. Longcope, *ibid.* Hewlett, *ibid.* Buxton, *Journ. med. Research*, (1902) June, 201. (Bacillus enteritidis, Gaertner), refs. vide Baumgarten's *Jahresbericht*, iv. 249; vii. 297; xii. 508. (Psittacosis), *ibid.*, xii. 496. Chiari u. Kraus, *Zeit. f. Heilkunde*, (1897) Heft 5 and 6, 471. Flexner and Harris, *Johns Hopkins Hosp. Bull.*, (1897) No. 81. Lartigau, *New York Med. Journ.*, (1899) Jan. 29; *Johns Hopkins Hosp. Bull.*, (1899) April. Ophiüs, *New York Med. Journ.*, (1900) May 12. Opie and Bassett, *Johns Hopkins Hosp. Bull.*, (1901) July, 198. (Bacillus enteritidis sporogenes), Klein, *Rep. Med. Off. Local Govt. Board*, xxv. 171; xxvii. 210.

BACILLARY DYSENTERY.—Shiga, *Centralbl. f. Bakteriolog. u. Parasitenk.*, xxiii. 599; xxiv. 817, 870, 913; *Deutsch. med. Woch.*, (1901) Nos. 43, 44, 45. Kruse, *Deutsche med. Wchnschr.*, (1900) 637. Flexner, *Bull. Johns Hopkins Hosp.*, (1900) xi. 39, 231; *Brit. Med. Journ.*, (1900) ii. 917; *Philadel. Med. Journ.*, (1900) vi. 414; *Univ. Penn. Med. Bull.*, (1901) No. 6, 190. Strong and Musgrave, *Journ. Amer. Med. Assoc.*, (1900) xxxv. 498. Vedder and Duval, *Journ. Exper. Med.*, (1902) vi. 181. Duval and Bassett, *Amer. Med.*, (1902) iv. No. 11, 417. Spronck, *Nederl. Tijdschft. v. Geneesknde.*, (1902) ii. No. 18. Ogata, *Centralbl. f. Bakteriolog. u. Parasitenk.*, xi. 264.

CHAPTER XVI.—DIPHTHERIA.

Klebs, *Verhandl. d. Cong. f. innere Med.*, (1883) ii. Löffler, *Mitth. a. d. k. Gsndhsamte.*, (1884) 421. Roux et Yersin, *Ann. de l'Inst. Pasteur*, ii.

629; iii. 273; iv. 385. Brieger u. Fraenkel, *Berl. klin. Wchnschr.*, (1890) 241, 268. Spronck, *Centralbl. f. allg. Path. u. path. Anat.*, i. No. 25; iii. No. 1. Welch and Abbott, *John Hopkins Hosp. Bull.*, 1891. Councilman, Mallory, and Pearce, *Journ. Boston Soc. Med. Sc.*, (1900) Dec. Behring u. Wernicke, *Ztschr. f. Hyg.*, xii. 10. Löffler, *Centralbl. f. Bakteriolog. u. Parasitenk.*, ii. 105. v. Hofmann, *Wien. med. Wchnschr.*, (1888) Nos. 3 and 4. Wesbrook, Wilson, and McDaniel, *Trans. Assoc. Amer. Phys.*, (1900) xv. 198. Hill, *Journ. Med. Research*, (1902) ii. N.S. 115; *Ann. Rep. Boston Board of Health*, 1901. Cobbett and Phillips, *Journ. Path. and Bacteriol.*, iv. 193. Peters, *ibid.*, iv. 181. Wright, *Boston Med. and S. Journ.*, (1894) 329, 357. Kanthack and Stephens, *Journ. Path. and Bacteriol.*, iv. 45. Klein, *Brit. Med. Journ.*, (1894) ii. 1393; (1895) i. 100. *Rep. Med. Off. Loc. Govt. Board*, (1890-91) 219; (1891-92) 125. Abbott, *Journ. Path. and Bact.*, (1893) Oct. Guinochet, *Compt. rend. Soc. de biol.*, (1892) 480. Roux et Martin, *Ann. de l'Inst. Pasteur*, viii. 609. Cartwright Wood, *Lancet*, (1896) i. 980, 1076; ii. 1145. Sidney Martin, "Goulstonian Lectures," *Brit. Med. Journ.*, (1892) i. 641, 696, 755; *Rep. Med. Off. Loc. Govt. Board*, (1891-92) 147; (1892-93) 427. Escherich, *Wien. med. Wchnschr.*, (1893) Nos. 47-50; *Wien. klin. Wchnschr.*, (1893) Nos. 7-10; (1894) No. 22; *Berl. klin. Wchnschr.*, (1893) Nos. 21, 22, 23. Behring, "Die Geschichte der Diphtherie," Leipzig, 1893; "Abhandlungen z. ätiol. Therap. v. anst. Krankh.," Leipzig, 1893; "Bekämpfung der Infectionskrankheiten," Leipzig, 1894. Ehrlich u. Wassermann, *Ztschr. f. Hyg.*, xviii. 239. Ehrlich u. Kossel, *ibid.*, xvii. 486. Ehrlich, Kossel, u. Wassermann, *Deutsche med. Wchnschr.*, (1894) 353. Funck, *Ztschr. f. Hyg.*, xvii. 401. Prochaska, *Ztschr. f. Hyg.*, xxiv. 373. Madsen, *ibid.*, xxiv. 425. Richmond and Salter, *Guy's Hosp. Repts.*, vol. 53, p. 55. Lesieur, *Journ. Physiolog. et Path. Général*, (1901) iii. 961, 1000. Neisser, *Ztschr. f. Hyg.*, xxiv. 443. L. Martin, *Ann. de l'Inst. Pasteur*, xii. 26. Salomonsen et Madsen, *ibid.*, xii. 763. Woodhead, *Brit. Med. Journ.*, (1898) ii. 893; *Rep. Metrop. Asyl. Bd.*, London, 1901. Métin, *Ann. de l'Inst. Pasteur*, xii. 596. Madsen, *ibid.*, xiii. 568, 801. Dean and Todd, *Journ. of Hyg.*, ii. 194. Cobbett, *ibid.*, i. 485.

CHAPTER XVII. — TETANUS, ETC.

Nicolaier, "Beiträge zur Aetiologie des Wundstarrkrampfes," Inaug. Diss. Göttingen, 1885. Rosenbach, *Arch. f. klin. Chir.*, xxxiv. 306. Carle and Rattone, *Gior. d. r. Accad. di med. di Torino*, 1884. Kitasato, *Ztschr. f. Hyg.*, vii. 225; x. 267; xii. 256. Kitasato u. Weyl, *ibid.*, viii. 41, 404. Vaillard, *Ann. de l'Inst. Pasteur*, vi. 224, 676. Vaillard et Rouget, *ibid.*, vi. 385. Behring, "Abhandlungen z. ätiol. Therap. v. anst. Krankh.," Leipzig, 1893; *Ztschr. f. Hyg.*, xii. 1, 45; "Blutserumtherapie," Leipzig, 1892; "Das Tetanusheiserum," Leipzig, 1892. Brieger u. Fraenkel, *Berl. klin. Wchnschr.*, (1890) 241, 268. Sidney Martin, *Rep. Med. Off. Loc. Govt. Board*, (1893-94) 497; (1894-95) 505. Uschinsky, *Centralbl. f. Bakteriolog. u. Parasitenk.*, xiv. 316. Bolton and Fisch, *Trans. Assoc. Amer. Phys.*, (1902) xvii. 462. Tizzoni u. Cattani, *Arch. f. exper. Path. u. Pharmacol.*, xxvii. 432; *Centralbl. f. Bakteriolog. u. Parasitenk.*, ix. 189, 685; x.

33, 576 (Ref.): xi. 325; *Berl. klin. Wchnschr.*, (1894) 732. Madsen, *Ztschr. f. Hyg.*, xxxii. 214. Ritchie, *Journ. of Hyg.*, i. 125. Danysz, *Ann. de l'Inst. Pasteur*, xiii. 155.

MALIGNANT ŒDEMA. — Pasteur, *Bull. Acad. de méd.*, 1881, 1887. Koch, *Mitth. a. d. k. Gsndhtsamte.*, i. 54. Kitt, *Jahresb. d. k. Centr.-Thierarznei-Schule in München*, 1883-84. W. R. Hesse, *Deutsche med. Wchnschr.*, (1885) No. 14. Chauveau et Arloing, *Arch. vét.*, (1884) 366, 817. Liborius, *Ztschr. f. Hyg.*, i. 115. Roux et Chamberland, *Ann. de l'Inst. Pasteur*, i. 562. Charrin et Roger, *Compt. rend. Soc. de biol.*, (1877), sér. VIII. iv. 408. Kerry u. S. Fraenkel, *Ztschr. f. Hyg.*, xii. 204. Sanfelice, *ibid.*, xiv. 339. Leclainche et Vèlle, *Ann. de l'Inst. Pasteur*, xiv. 202, 590.

BACILLUS BOTULINUS. — V. Ermengem, *Centralbl. f. Bakteriöl. u. Parasitenk.*, xix. 443; *Ztschr. f. Hyg.*, xxvi. 1. Kempner, *ibid.*, xxvi. 481. Kempner u. Schepilewsky, *ibid.*, xxvii. 213. Kempner u. Pollack, *Deutsche med. Wchnschr.*, 1897, No. 32. Brieger u. Kempner, *ibid.*, 1897, No. 33. Marinresco, *Compt. rend. Soc. de Biol.*, 1896, No. 31. Schneidemühl, *Centralbl. f. Bakteriöl. u. Parasitenk.*, xxiv. 577, 619. Römer, *ibid.*, xxvii. 857.

QUARTER-EVIL. — See Nocard et Leclainche, "Les maladies microbiennes des animaux," Paris (1896). Arloing, Cornevin, et Thomas, "Le charbon symptomatique du bœuf," Paris (1887). Nocard et Roux, *Ann. de l'Inst. Pasteur*, i. 256. Roux, *ibid.*, ii. 49. See also *Journ. Comp. Path. and Therap.*, iii. 253, 346; viii. 166, 233.

BACILLUS AEROGENES CAPSULATUS. — Welch and Nuttall, *Bull. Johns Hopkins Hosp.*, 1892, 81. Welch and Flexner, *Journ. Exper. Med.*, i. 5. E. Fraenkel, *Centralbl. f. Bakteriöl. u. Parasitenk.*, xiii. 13. E. Fraenkel, *Ueber Gasphlegmonen*, (Hamburg u. Leipzig, 1893). Dunham, *Bull. Johns Hopkins Hosp.*, 1897, No. 73, 68. Norris, *Am. Journ. Med. Sc.*, cxvii. 172. Howard, *Contrib. to the Sc. of Med.*, dedicated by his pupils to William H. Welch, Baltimore, (1900) 461. Bloodgood, *Progress. Med.*, (1899) iv. 158. Fulton and Pratt, *Boston Med. and Surg. Journ.*, (1900) 599. Welch, *Johns Hopkins Hosp. Bull.*, (1900) xi. 185; *Centralbl. f. Bakt. u. Parasitenk.*, Abt. i., (1901) Bd. xxix. 442. Gwyn, *Johns Hopkins Hosp. Bull.*, (1899) x. 134. Cole, *ibid.*, (1902) xiii. 234.

CHAPTER XVIII. — CHOLERA.

Koch, *Rept. of 1st Cholera Conference*, 1884 (v. "Microparasites in Disease," *New Sydenham Soc.*, 1886). Nikati et Rietsch, *Compt. rend. Acad. d. sc.*, xcix. 928, 1145. Bosk, *Ann. de l'inst. Pasteur*, ix. 507. Pettenkofer, *München., med. Wchnschr.*, (1892) No. 46; (1894) No. 10. Sawtschenko, *Centralbl. f. Bakteriöl. u. Parasitenk.*, xii. 893. Pfeiffer, *Ztschr. f. Hyg.*, xi. 393. Kolle, *ibid.*, xvi. 329. Issaëff u. Kolle, *ibid.*, xviii. 17. Wassermann, *ibid.*, xiv. 35. Sobernheim, *ibid.*, xiv. 485. Metchnikoff, *Ann. de l'Inst. Pasteur*, vii. 403, 562; viii. 257, 529. Fraenkel u. Sobernheim, *Hyg. Rundschau*, iv. 97. Dunbar, *Arb. a. d. k. Gsndhtsamte.*, ix. 379. Pfeiffer u. Wassermann, *Ztschr. f. Hyg.*, xiv. 46. Westbrook, *Ann. de l'Inst. Pasteur*, viii. 318. Scholl, *Berl. klin. Wchnschr.*, (1890) No. 41. Grüber u. Wiener, *Arch. f. Hyg.*, xv. 241. Cunningham, *Scient. mem. med. off. India*, 1890 and

1894. Hueppe, *Deutsche med. Wchnschr.*, (1889) No. 33. Klemperer, *ibid.*, (1894) 435; *Berl. klin. Wchnschr.*, (1892) 969. Lazarus, *ibid.*, (1892) 1071. Reincke, *Deutsche med. Wchnschr.*, (1894) 795. Koch, *Ztschr. f. Hyg.*, xiv. 319. Voges, *Centralbl. f. Bakteriolog. u. Parasitenk.*, xv. 453. Pastana u. Bettencourt, *Centralbl. f. Bakteriolog. u. Parasitenk.*, xvi. 401. Dieudonné, *ibid.*, xiv, 323. Celli u. Santori, *ibid.*, xv. 289. Neisser, *ibid.*, xiv., 666. Sanarelli, *Ann. de l'Inst. Pasteur*, vii. 693. Ivanoff, *Ztschr. f. Hyg.*, xv. 485. Issaëff, *ibid.*, xvi. 286. Pfuhl, *ibid.*, x. 510. Rumpel, *Deutsche med. Wchnschr.*, (1893), 160. Klein., *Rep. Med. Off. Loc. Govt. Board*, 1893; "Micro-organisms and Disease," London, 1896. Haffkine, *Brit. Med. Journ.*, (1895) ii. 1541. *Indian Med. Gaz.*, 1895, No. 1; "Anti-cholera Inoculation," *Rep. San. Com. India*, Calcutta, 1895. Pfeiffer in Flügge, "Die Mikroorganismen," 3rd ed., 1896; Gamaléia, *Ann. de l'Inst. Pasteur*, ii. 482, 552. Abbott, *Journ. Exper. Med.*, (1896) i. 419. Achard et Bensande, *Semaine méd.*, (1897) 151. Rumpf, "Die Cholera Asiatica und Nostras," Jena, 1898.

CHAPTER XIX. — INFLUENZA, ETC.

INFLUENZA. — Pfeiffer, Kitasato, u. Canon, *Deutsche med. Wchnschr.*, xviii. 28, and *Brit. Med. Journ.*, (1892) i. 128. Babes, *Deutsche med. Wchnschr.*, xviii. 113. Pfeiffer u. Beck, *ibid.*, (1892) 465. Pfuhl, *Centralbl. f. Bakteriolog. u. Parasitenk.*, xi. 397. Klein, *Rep. Med. Off. Loc. Govt. Board*, (1893) 85. Pfeiffer, *Ztschr. f. Hyg.*, xiii. 357. Huber, *Ztschr. f. Hyg.*, xv. 454. Kruse, *Deutsche med. Wchnschr.*, (1894) 513. Pelicke, *Berl. klin. Wchnschr.*, (1894) 524. Pfuhl u. Walter, *Deutsche med. Wchnschr.*, (1896) 82, 105. Cantani, *Ztschr. f. Hyg.*, xxiii. 265. Pfuhl, *Ztschr. f. Hyg.*, xxvi. 112. Wassermann, *Deutsche med. Wchnschr.*, 1900, No. 28. Clemens, *München. med. Wchnschr.*, 1900, No. 27.

PLAGUE. — Kitasato, *Lancet*, (1894) ii. 428. Yersin, *Ann. de l'Inst. Pasteur*, viii. 662. Lowson, *Lancet*, (1895) ii. 199. Yersin, Calmette, et Borrel, *Ann. de l'Inst. Pasteur*, ix. 589. Aoyama, *Centralbl. f. Bakteriolog. u. Parasitenk.*, xix. 481. Zettnow, *Ztschr. f. Hyg.*, xxi. 164. Yersin, *Ann. de l'Inst. Pasteur*, xi. 81. Gordon, *Lancet*, (1899) i. 688. Wilson, *Journ. Med. Research*, (1901) i., n. s., i. 53. Haffkine, *Brit. Med. Journ.*, (1897) i. 424. Wyssokowitz et Zabolotny, *Ann. de l'Inst. Pasteur*, xi. 663. Ogata, *Centralbl. f. Bakteriolog. u. Parasitenk.*, xxi. 769. Childe, *Brit. Med. Journ.*, (1898) ii. 858. See also *Brit. Med. Journ.* and *Lancet*, 1897-99. Lustig u. Galeotti, *Deutsche med. Wchnschr.*, 1897, No. 15. Markl, *Centralbl. f. Bakteriolog. u. Parasitenk.*, xxiv. 641, 728; xxix. 810. Cairns, *Lancet*, (1901) i. 1746. Montenegro, "Bubonic Plague," London, 1900. Netter, "La peste et son bacille," Paris, 1900. Mitth. der Deutschen Pest-Kommission, *Deutsche med. Wchnschr.*, 1897, Nos. 17, 19, 31, 32. Report of the Indian Plague Commission (1898-99), London, 1900-01. Also numerous papers in the *Lancet* and *Brit. Med. Journ.*, 1897-1901. Regarding Glasgow epidemic see *ibid.*, 1900, ii. Barker, *Am. Journ. Med. Sc.*, (1901) Oct. Flexner, *ibid.* Novy, *ibid.*

RELAPSING FEVER. — Obermeier, *Centralbl. f. d. med. Wissensch.*, (1873) 145; and *Berl. klin. Wchnschr.*, (1873) No. 35. Münch, *Centralbl. f. d. med. Wissensch.*, 1876. Koch, *Deutsche med. Wchnschr.*, (1879) 327. Moczut-

kowsky, *Deutsches Arch. f. klin. Med.*, xxiv. 192. Vandyke Carter, *Med.-Chir. Trans.*, London, (1880) 78. Lubinoff, *Virchow's Archiv*, xcvi. 160. Metchnikoff, *ibid.*, cix. 176. Soudakewitch, *Ann. de l'Inst. Pasteur*, v. 545. Lamb, *Scient. mem. med. off. India*, 1901, pt. xii. 77. Sawtschenko et Melkich, *Ann. de l'Inst. Pasteur*, xv. 497.

MALTA FEVER.—Bruce, *Practitioner*, xxxix. 160; xl. 241; *Ann. de l'Inst. Pasteur*, vii. 291. Bruce, Hughes, and Westcott, *Brit. Med. Journ.*, (1887) ii. 58. Hughes, *Ann. de l'Inst. Pasteur*, vii. 628; *Lancet*, (1892) ii. 1265. Wright and Semple, *Brit. Med. Journ.*, (1897) i. 1214. Wright and Smith, *ibid.*, (1897) i. 911; *Lancet*, (1897) i. 656. Welch, *ibid.*, (1897) i. 1512. Gordon, *ibid.*, (1899) i. 688. Durham, *Journ. Path. and Bacteriol.*, v. 377. Bruce in Davidson's "Hygiene and Diseases of Warm Climates," Edinburgh and London, 1893. Birt and Lamb, *Lancet*, 1899, ii. 701. Brunner, *Wiener klin. Wchnschr.*, 1900, No. 7. Cox, *Philadel. Med. Journ.*, (1899) Sept. 9, 491. Musser and Sailer, *Philadel. Med. Journ.*, (1898) Dec. 31, 1408. Strong and Musgrave, *ibid.*, (1900) Nov. 24. Curry, *Journ. Med. Research*, (1901) i., n. s., i. 241.

YELLOW FEVER.—Sternberg, *Rep. Am. Pub. Health Ass.*, xv. 170. Sanarelli, *Ann. de l'Inst. Pasteur*, xi. 433, 673, 753; xii. 348. Davidson, art. in Clifford Allbutt's "System of Medicine," vol. ii., London, 1897. Sternberg, *Centralbl. f. Bakteriol. u. Parasitenk.*, xxii. 145; xxiii. 769. Sanarelli, *ibid.*, xxii. 668. Archinard, Woodson, *ibid.*, xxv. 393, (and Archinard ref.). Archinard and Woodson, *New York Med. Journ.*, (1899) Jan. 28. Mendoza (ref.), *Centralbl. f. Bakteriol. u. Parasitenk.*, xxv. 390. Wasdin and Geddings, *Report of Treasury Dept.*, Washington, 1899. Reed, *Journ. of Hyg.*, ii. 101 (with full references). Reed and Carroll, *Journ. Exper. Med.*, (1900) v. 215; *Am. Med.*, (1902) Feb. 22, 301. Durham, *Thompson-Yates Laboratory Rep.*, (1902) iv. pt. ii. 485.

CHAPTER XX.—IMMUNITY.

For early inoculation methods (e.g. against anthrax, chicken cholera, etc.), see "Microparasites in Disease," *New Syd. Soc.*, 1886. Duguid and Sanderson, *Journ. Roy. Agric. Soc.*, (1880) 267. Greenfield, *ibid.*, (1880) 273; *Proc. Roy. Soc. London*, June, 1880. Toussaint, *Compt. rend. Acad. d. sc.*, xci. 135. Haffkine, *Brit. Med. Journ.*, (1891) ii. 1278. Klein, *ibid.*, (1893) i. 632, 639, 651. Klemperer, *Arch. f. exper. Path. u. Pharmakol.*, xxxi. 356. Buchner, *München. med. Wchnschr.*, (1893) 449, 480. Ehrlich, *Deutsche med. Wchnschr.*, (1891) 976, 1218. R. Pfeiffer, *Ztschr. f. Hyg.*, xviii. 1; xx. 198. Pfeiffer u. Kolle, *ibid.*, xxi. 203. Bordet, *Ann. de l'Inst. Pasteur*, ix. 462; xi. 106. Metchnikoff, *Virchow's Archiv*, xcvi. 177; xcvi. 502; cvii. 209; cix. 176; *Ann. de l'Inst. Pasteur*, iii. 289; iv. 65; iv. 193; iv. 493; v. 465; vi. 289; vii. 402; vii. 562; viii. 257; viii. 529; ix. 433. Calmette, *Ann. de l'Inst. Pasteur*, viii. 275; xi. 95. Fraser, *Proc. Roy. Soc. Edin.*, xx. 448. Marmorek, *Ann. de l'Inst. Pasteur*, ix. 593. Metchnikoff, Roux, et Taurelli-Salimbeni, *ibid.*, x. 257. Charrin et Roger, *Compt. rend. Soc. de biol.*, (1887) 667. Gruber u. Durham, *München. med. Wchnschr.*, (1896) March. Durham, *Journ. Path. and Bacteriol.*, iv. 13. Cartwright Wood,

Lancet, (1896) i. 980; ii. 1145. Sidney Martin, "Serum Treatment of Diphtheria," *Lancet*, (1896) ii. 1059. Ransome, "On Immunity to Disease," London, 1896. Burdon Sanderson, "Croonian Lectures," *Brit. Med. Journ.*, (1891) ii. 983, 1033, 1083, 1135. Discussion on Immunity, Path. Soc. London, *Brit. Med. Journ.*, (1892) i. 373. Fodor, *Deutsche med. Wchnschr.*, (1887) No. 34. Hueppe, *Berl. klin. Wchnschr.*, (1892) No. 17. Nicholle, *Ann. de l'Inst. Pasteur*, xii. 161. Salomonsen et Madsen, *ibid.*, xi. 315; xii. 763. Roux et Borrell, *ibid.*, xii. 225. Salimbeni, *ibid.*, xi. 277. Wassermann u. Takaki, *Berl. klin. Wchnschr.*, (1898) xxxv. 4. Blumenthal, *Deutsche med. Wchnschr.*, xxiv. 185. Ransom, *ibid.*, xxiv. 117. Meade Bolton, *Journ. Exper. Med.*, i. 543. Fraser, T. R., *Brit. Med. Journ.*, (1895) i. 1309; ii. 415, 416; (1896) i. 957; (1896) ii. 910; (1897) ii. 125. 595. Calmette, *Ann. de l'Inst. Pasteur*, vi. 160, 604; viii. 275; ix. 225; x. 675; xi. 214; xii. 343. C. J. Martin, *Journ. Physiol.*, xx. 364; *Proc. Roy. Soc. London*, lxiv. 88. C. J. Martin and Cherry, *ibid.*, lxiii. 420. Gautier, "Les Toxines microbiennes et animales," Paris, 1896. Wassermann, *Berl. klin. Wchnschr.*, (1898) 1209. Pfeiffer u. Marx, *Ztschr. f. Hyg.*, xxvii. 272. Bordet, *Ann. de l'Inst. Pasteur*, xii. 688. Ehrlich, *Deutsche med. Wchnschr.*, (1898) xxiv. 597. "Die Wertbemessung des Diphtherieheilserums," Jena, 1897; Croonian Lecture, *Proc. Roy. Soc. London*, lxvi. 424; *Deutsche med. Wchnschr.*, xxvii. (1901) 866, 888, 913; Nothnagel's "Specielle Pathologie und Therapie," Bd. viii. Schlussbetrachtungen. Ehrlich u. Morgenroth, *Berl. klin. Wchnschr.*, (1899) xxxvi. 6, 481; (1900) xxxvii. 453, 681; (1901) xxxviii. 251, 569, 598. Weigert, in Lubarsch u. Ostertag, "Ergebnisse der Allgemeinen Pathologie," (1897) iv. Jahrg., (Wiesbaden, 1899). Morgenroth, *Centralbl. f. Bakteriolog. u. Parasitenk.*, xxvi. 349. Bulloch, *Trans. Jenner Inst.*, 2nd ser. p. 46. Dönitz, *Deutsche med. Wchnschr.*, (1897) xxiii. 428. Bordet, *Ann. de l'Inst. Pasteur*, xii. 688; xiii. 225, 273; xiv. 257; xv. 303. Metchnikoff, *ibid.*, xiii. 737; xiv. 369; xv. 865. Gengou, *ibid.*, xv. 232. Sawtschenko, *ibid.*, xvi. 106. Ritchie, *Journ. of Hyg.*, ii. 215, 251, 452 (with full references). Metchnikoff, "L'immunité dans les maladies infectieuses," Paris, 1901. Neisser u. Wechsberg, *München. med. Wchnschr.*, 1901, No. 18. Von Dungern, *ibid.*, (1899) 1288; (1900) 677, 963.

APPENDIX A.—SMALLPOX.

Jenner, "An Inquiry into the Causes and Effects of the Variola Vaccinæ," London, 1798. Creighton, art. "Vaccination" in *Encyc. Brit.*, 9th ed. Crookshank, "Bacteriology and Infective Diseases." McVail, "Vaccination Vindicated." Chauveau, Viennois et Mairet, "Vaccine et variole, nouvelle étude expérimentale sur la question de l'identité de ces deux affections," Paris, 1865. Klein, *Rep. Med. Off. Loc. Govt. Board*, (1892-93) 391; (1893-94) 493. Copeman, *Brit. Med. Journ.*, (1894) ii. 631; *Journ. Path. and Bacteriol.*, ii. 407; art. in Clifford Allbutt's "System of Medicine," vol. ii. L. Pfeiffer, "Die Protozoen als Krankheitserreger," Jena, 1891. Ruffer, *Brit. Med. Journ.*, (1894) June 30. Béclère, Chambon, et Ménard, *Ann. de l'Inst. Pasteur*, x. 1; xii. 837. Copeman, "Vaccination," London, 1899. Van der Leff, ref. in *Zeit. f. Hyg. u. Infektskr.*, (1901) xxxviii. L. Pfeiffer,

ibid., (1887) iii. 214. Guarnieri, *Arch. per le sc. med.* (1892), xvi.; *Clinic. Modern.*, (1897) iii. Wasielewski, *Zeit. f. Hyg. u. Infektskr.*, (1901) xxxviii. 212. Gorini, *Centralbl. f. Bakt. u. Parasitenk.*, Abt. i. (1902), Bd. xxxii. 111, 213.

APPENDIX B. — HYDROPHOBIA.

Pasteur, *Compt. rend. Acad. d. sc.*, xcii. 1259; xcv. 1187; xcvi. 457. 1229; ci. 765; cii. 459, 835; ciii. 777. Schaffer, *Ann. de l'Inst. Pasteur.* iii. 644. Fleming, *Trans. 7th Internat. Cong. Hyg. and Demog.*, iii. 16. Helman, *Ann. de l'Inst. Pasteur*, ii. 274; iii. 15. Babes et Lepp, *ibid.*, iii. 384. Nocard et Roux, *ibid.*, ii. 341. Roux, *ibid.*, i. 87; ii. 479. Bruschet-tini, *Centralbl. f. Bakteriolog. u. Parasitenk.*, xx. 214; xxi. 203. Memmo, *ibid.*, xx. 209; xxi. 657. Frantzius, *ibid.*, xxiii. 782; xxiv. 971. Van Gehuchten, *Journ. de Neurol.*, (1900) v. 369, 389. Van Gehuchten et Nelis, *Névraze*, (1900) i. 79, 114. Ravenel and McCarthy, *Univ. Med. Mag.*, (Philadelphia) 1901, Jan. Spiller, *ibid.*

APPENDIX C. — MALARIAL FEVER.

Laveran, *Bull. Acad. de méd.*, (1880) sér. II. ix. 1346; "Traité des fièvres palustres," Paris, 1884; "Du paludisme et de son hématozoaire," Paris, 1891. Marchiafava u. Celli, *Fortschr. d. Med.*, 1883 and 1885; also in *Virchow's Festschrift*. Golgi, *Arch. per le sc. med.*, 1886 and 1889; *Fortschr. d. Med.*, (1889) No. 3; *Ztschr. f. Hyg.*, x. 136; *Deutsche med. Wchnschr.*, (1892) 663, 685, 707, 729; Sternberg, *New York Med. Rec.*, xxix. No. 18. James, *ibid.*, xxxiii. No. 10. Councilman, *Fortschr. de Med.*, (1888), Nos. 12, 13. Osler, *Trans. Path. Soc. Philadelphia*, xii. xiii. Grassi and Feletti, *Riforma med.*, (1890) ii. No. 50. Canalis, *Fortschr. d. Med.*, (1890), Nos. 8, 9. Danilewsky, *Ann. de l'Inst. Pasteur*, xi. 758. "Parasites of Malarial Fevers," *New. Syd. Soc.*, 1894 (Monographs by Marchiafava and Bignami, and by Mannaberg, with Bibliography). Manson, *Brit. Med. Journ.*, (1894) i. 1252. 1307; *Lancet*, (1895) ii. 302; *Brit. Med. Journ.* (1898), ii. 849. Koch, *Berl. klin. Wchnschr.*, (1899) 69. Ross, *Indian Med. Gaz.*, xxxiii. 14, 133, 401, 448. Nuttall, *Centralbl. f. Bakteriolog. u. Parasitenk.*, xxv. 877, 903; xxvi. 140; xxvii. 193, 218, 260, 328 (with full literature). Manson, *Lancet*, (1900) i. 1417; (1900) ii. 151. Gray, *Brit. Med. Journ.*, (1902) i. 1121. Leishman, *ibid.*, (1901) i. 635; ii. 757. Daniel, *ibid.*, (1901) i. 193. Celli, *ibid.*, (1901) i. 1030. Nuttall and Shipley, *Journ. of Hyg.*, i. 45, 269, 451 (with literature). Ross, *Nature*, lxi. 522; "Mosquito Brigades and how to organise them," London, 1902. Celli, "Malaria," trans. by Eyre, London, 1900. Lankester, *Brit. Med. Journ.*, (1902) i. 652.

APPENDIX D. — DYSENTERY.

Lösch, *Virchow's Archiv*, lxxv. 196. Cunningham, *Quart. Journ. Micr. Sc.*, N.S. xxi. 234. Kartulis, *Virchow's Archiv*, cv. 118; *Centralbl. f. Bakteriolog. u. Parasitenk.*, ii. 745; ix. 365. Koch, *Arb. a. d. k. Gsndtsamte.*, iii. 65. Councilman and Lafleur, *Johns Hopkins Hosp. Rep.*, (1891) ii. 395.

Maggiara, *Centralbl. f. Bakteriol. u. Parasitenk.*, xi. 173. Ogata, *ibid.*, xi. 264. Schuberg, *ibid.*, xiii. 598, 701. Quincke u. Roos, *Berl. klin. Wchnschr.*, (1893) 1089. Kruse u. Pasquale, *Ztschr. f. Hyg.*, xvi. i. Ciechanowski u. Nowak, *Centralbl. f. Bakteriol. u. Parasitenk.*, xxiii. 445. Howard and Hoover, *Am. Journ. Med. Sc.*, (1897) cxiv. 150, 263.

INDEX.

	PAGE		PAGE
Abrin,	177	Albumoses in diphtheria,	368
“ immunity against,	468, 473	“ in tetanus,	386
Abscesses, bacteria in,	181	“ in tubercle,	262
“ in dysentery,	531	Alexines,	482, 498
Absolute alcohol, fixing by,	92	Alkaline blood-serum,	45
Acid-fast bacilli,	241, 254, 256	Allied streptothrices, bibliography,	543
“ “ bibliography,	542	Amboceptors,	490
“ “ characters of,	255	Amœbic dysentery,	529
“ “ stain for,	104	Amœbulæ of malaria,	520
Acids, formation in ordinary media,	327	Anaerobes,	19
Acquired immunity in man,	461	“ cultures of,	59
“ “ theories of,	489	“ separation of,	60
Actinomyces,	16	“ toxins of,	63
“ characters of,	287	Anaerobic plate-cultures, Novy's and Bulloch's apparatus for,	60, 61
“ cultivation of,	294	Anæsthetic leprosy,	267, 269
“ inoculation with,	296	Aniline oil, dehydrating by,	96
“ varieties of,	295	“ “ water,	101
Actinomycosis,	287	“ stains, list of,	97
“ bibliography,	543	Animals, autopsies on,	120
“ diagnosis of,	296	“ inoculation of,	58, 117
“ lesions in,	291, 292	“ tuberculosis in,	237
“ origin of,	293	Anthraxis, bacillus,	301
Active immunity,	462, 464	Anthrax,	300
Aerobes,	19	“ bacillus of,	301
“ culture of,	49	“ “ biology of,	304
“ separation of,	53	“ “ cultivation of,	302, 317
Aerogenes capsulatus, bacillus, 186, 402, 547		“ “ inoculation with, 309, 318	
Æstivo-autumnal fevers,	525	“ “ toxins of,	312
Agar media,	38, 40	“ bibliography,	544
“ “ separation by,	57	“ diagnosis of,	317
Agglutination,	484	“ disposal of animals dead of,	315
“ B. dysentericæ,	352	“ history,	300
“ B. mallei,	283	“ immunising of animals,	315
“ B. typhosus, etc.,	330	“ in animals,	306
“ bibliography,	537	“ in man,	309
“ cholera vibrio,	423	“ protective inoculation,	315
“ glanders bacilli,	283	“ spread of,	314
“ M. melitensis,	454	Anti-abrin,	473
“ methods,	109	Anti-anthrax serum,	316
“ plague bacillus,	446	Antibacterial sera,	463, 469, 479
“ relapsing fever,	451	Anticharbonneux serum,	316
“ serum,	109, 344, 454, 480	Anti-cholera vaccination,	420
“ theories regarding,	485	Anti-diphtheritic serum,	471
“ tubercle bacillus,	266	Antikörper,	462
“ yellow fever bacillus,	457	Anti-plague sera,	445
Air, bacteria in,	123	“ inoculation,	445
“ “ bibliography,	537	Antipneumococcic serum,	220
Albumose of anthrax, immunity by,	313	Antirabic serum,	514
Albumoses,	174		

	PAGE		PAGE
Anti-ricin,	473	Bacillus of Müller,	201
Antiseptics,	140	“ mycoides in soil,	130
“ actions of,	141	“ Neapolitanus,	319
“ bibliography,	537	“ ozœnæ,	286
“ testing of,	140	“ of paracolon,	331
Antisera (summary),	487	“ of plague, <i>see that title</i> .	
“ therapeutic action of,	488	“ pneumoniæ,	207
Antistreptococcic serum,	479	“ pseudo-diphthericus,	370
Antitetic serum,	389	“ psittacosis,	331
“ preparation of,	470	“ pyocyaneus,	186
Antitoxins, action, nature of,	474	“ agglutination of,	484
“ bodies in normal tissues,	476	“ occurrence of,	194
“ chemical nature of,	477	“ pyogenes fœtidus,	182
“ origin of,	475	“ of quarter-evil,	401
“ sera, use of,	488	“ of rhinoscleroma,	284
“ serum,	463, 469, 470	“ of smegma,	234, 256
“ cholera,	421	“ of soft sore,	231
“ standardisation of,	472	“ species,	14
“ side-chain theory,	490	“ subtilis,	58
Antitubercular serum,	264	“ syphilis,	233
Antityphoid serum,	347	“ of tetanus, <i>see that title</i> ,	
Appendicitis,	194	“ of Timothy grass,	255
Arnold steam steriliser,	30	“ of tubercle, <i>see that title</i> .	
Arthrospores, question of occurrence		“ of typhoid fever, <i>see that title</i> .	
of,	8, 409	“ xerosis,	373
Artificial immunity, varieties of,	462	“ of Welch,	402, 406
Ascomycetæ: oidium lactis,	149	Bacteria, action of,	23, 161
Aspergillus niger, form of fungi,	150	“ aerobic (<i>see Aerobes</i>),	19
Attenuation of virulence,	464	“ air, <i>see that title</i> .	
Autoclave,	31	“ anaerobic (<i>see Anaerobes</i>),	19
Autopsies on animals,	120	“ biology of,	17
Avian tuberculosis,	238, 252	“ capsulated,	4
		“ chemical action of,	23, 162
Bacilli, <i>see Acid-fast</i> .		“ composition of,	10
Bacillus acidi lactici,	22	“ classification of,	I, II
“ acnes,	188	“ cocci, forms of,	12
“ aerogenes capsulatus,	186, 402	“ counting of colonies,	71
“ anthracis,	401	“ cultivation of,	27
“ botulinus,	398, 547	“ culture media, <i>see that title</i> .	
“ coli communis, lesions caused		“ death of,	140
by,	186, 192	“ disease, relation of bacteria	
“ characters of,	325	to,	157
“ comparison with B. typho-		“ effects of action;	164
sus,	326	“ ferments, <i>see that title</i> .	
“ detecting in water,	136	“ food supply of,	17
“ in soil,	131	“ gaseous environment,	19
“ pathogenicity of,	338	“ growth,	17, 115
“ diphtheriæ,	357	“ higher, <i>see that title</i> .	
“ diplo-bacillus of conjunctivitis,	202	“ indol, formation,	80, 328
“ dysenteriæ,	350, 354	“ inflammation, caused by,	182
“ enteriditis (Gaertner),	331	“ light, effect of,	20
“ enteriditis sporogenes,	354	“ lower, <i>see that title</i> .	
“ in soil,	131	“ metabolism, disturbances by	
“ of glands,	275, 277	bacteria,	164, 169
“ icteroides,	456	“ microscopic examination	
“ of influenza, <i>see that title</i> .		of,	87, 115
“ of Koch-Weeks,	201	“ moisture for,	18
“ lactis aerogenes,	186	“ morphological relations of,	2
“ of leprosy,	269	“ motility of,	8, 21
“ of malignant œdema,	394	“ movements of,	21

	PAGE		PAGE
Bacteria, multiplication of,	4	Bread paste,	49
“ nature, effects in,	22, 25	Brieger and Boer,	174, 368
“ nitrifying,	25	“ Fraenkel,	172, 384
“ parasitic,	23	Bruce, on Malta fever,	452
“ pathogenic, action of,	157	Buboes,	228, 233
“ “ effects of,	164	Bubonic pest,	435
“ reproduction,	4	Buchner on alexines,	498
“ saprophytic,	23, 157	“ antitoxin,	475
“ separation of,	53	Bullock's apparatus for anaerobic culture,	61
“ signs of infection,	171	Bütschli on bacterial structure,	10
“ soil, examination for bac- teria,	128	Butter bacillus,	256
“ species of,	11	Calmette,	444, 468, 473, 475
“ spore formation in (<i>see also</i> Spores),	5, 58	Canon on influenza,	430, 433
“ staining methods, <i>see that title.</i>		Cantani on influenza,	434
“ structure of,	3	Capsules, staining of,	106
“ sulphur-containing,	10	Carbol-fuchsin,	102
“ suppuration, <i>see that title.</i>		“ -gentian-violet,	102
“ temperature of growth of,	19	“ -methylene-blue,	101
“ thermal death-point test,	70	“ thionin-blue,	101
“ tissue changes,	164	Carbolic acid as antiseptic,	146
“ toxins, <i>see that title.</i>		Carter on relapsing fever,	449
“ variability among,	25	Cattle plague,	504
“ virulence of,	158, 466	Celloidin sacs,	66
“ water, bacteria in,	133	Cerebro-spinal fluid, examination by lumbar puncture,	73
“ <i>see also names of diseases.</i>		Chamberland and Roux, attenuation of B. anthracis,	465
Bacterial ferments,	24, 78	Chamberland's filter,	74
“ pigments,	10	Charbon symptomatique,	401
“ protoplasm, structure of,	9	Chemical action of bacteria,	23, 162
“ treatment of sewage,	138	“ composition of bacteria,	10
Bactericidal powers of serum,	497	Chemiotaxis,	21, 181, 494, 498
“ substances,	481	Chlorine as antiseptic,	143
Bacteriological diagnosis,	112	Cholera,	407
“ examination of dis- charges,	114	“ bibliography,	547
Basic aniline stains,	97	“ immunity against,	420
Beerwort, culture media,	49	“ methods of diagnosis of,	426
“ gelatin,	41	“ preventive inoculation against,	421
Beggiatoa,	16	“ -red reaction,	412
Behring on immunity,	390, 498	“ sicca,	408
Bettencourt's spirillum,	425	Cholera spirillum,	407
Bibliography,	534	“ “ characters of,	408
Biology of bacteria,	17	“ “ distribution of,	410
“ “ bibliography,	535	“ “ inoculation with,	415, 420
Bismarck-brown,	97	“ “ methods of distinguishing,	422
Blackleg,	401	“ “ relations to powers of resist- ance of,	413
Blastomycetic dermatitis,	152	“ “ disease,	423
Blastophores (malaria),	522	“ “ spirilla resembling,	424
Blood-agar,	42	“ “ toxins of,	417
Blood, examination of,	72, 90	Cladothrices in soil,	130
“ in malarial fever,	516	Cladothrix,	16
“ in relapsing fever,	447	“ asteroides,	295
“ serum, as medium,	43, 45	Classification of bacteria,	I, II
“ toxin in the circulating blood,	387		
Bone-marrow in leucocytosis,	165		
Bordet's phenomenon,	481		
Botulism, bacillus of,	398		
Bouillon (<i>see also</i> Culture media),	35		
Bovine tuberculosis,	250		

	PAGE		PAGE
Clearing of sections,	96	Cultures, filtration of,	74
Clubs in actinomycetes,	290	" from organs,	113, 121
Cocci, characters of,	12	" fungi, <i>see that title</i> .	
Collodion sacs,	66	" hanging block,	70
Colonies, counting of,	71	" hanging-drop, aerobic,	68
Comma bacillus, (<i>see also</i> Cholera spirillum)	407	" " anaerobic,	69
Commission on tuberculosis,	260	" incubation of,	82
" vaccination,	503	" microscopic examination of,	87
Complement,	482	" permanent preservation of,	85
Conjunctivitis,	201	" plate-cultures, <i>see that title</i> .	
" bibliography,	539	" pure,	49
Copeman on smallpox,	505	" "shake,"	78
Cornet's forceps,	89	" sterilisation, <i>see that title</i> .	
Corrosive sublimate, as antiseptic,	144	" storing,	82
" " fixing by,	92	" tubes,	49
" films of blood, etc.,	90	" typhoid bacillus,	320 <i>et seq.</i>
Councilman and Lafleur on dysentery,	531	Curdling of milk by <i>B. coli</i> ,	327
Counting of colonies,	71	Cutting of sections,	93
Cover-glasses, cleaning of,	89	Cystitis,	194, 228
Cowpox, relation to smallpox,	503	Cytases,	482, 494
Crescentic bodies in malaria,	518	Cytolytic sera,	484
Cultivation, of bacteria,	27	Danubicus vibrio,	424
" bibliography,	536	Death of bacteria,	140
Culture media, preparation of:		" -point test, thermal,	70
" agar,	38	De Bary, definition of species,	25
" " alkaline blood serum,	45	De Christmas, gonococcus toxin,	227
" " beerwort, <i>see that title</i> .		Decolourising agents,	99
" " blood agar,	42	Deep cultures,	62
" " " serum,	43, 45	Dehydration of sections,	96
" " bouillon,	35	Delépine,	111
" " bread paste,	49	Deneke's spirillum,	429
" " Capaldi's medium,	329	Diagnosis, bacteriological,	112
" " Elsner's medium,	48	Diphtheria,	356
" " glucose agar,	40	" diagnosis of,	374
" " " broth,	38	" immunity against,	470
" " " gelatin,	41	" origin and spread of,	373
" " glycerin agar,	40	" paralytic in,	357
" " " broth,	38	" results of treatment,	488
" " Hiss's serum media,	46	Diphtheria bacillus, action of,	373
" " litmus,	41	" " association with other organ- isms,	360
" " Löffler's serum medium,	45	" " bibliography,	545
" " Marmorek's serum media,	45	" " characters of,	357
" " meat infusion,	34	" " distribution of,	358
" " milk,	48	" " history,	356
" " peptone broth,	35	" " inoculation with,	364
" " " gelatin,	40	" " isolation of,	375
" " " solution,	43	" " powers of resist- ance of,	363
" " potatoes,	46	" " staining,	363
" " Proskauer's medium,	329	" " toxins of,	173, 366
" " reaction,	36	" " variations in virulence of,	369
" " serum agar,	42	Diplo-bacillus of conjunctivitis,	202
" " use of,	49	Diplococcus,	14
Cultures, anaerobes,	59	" endocarditis encap- sulatus,	197
" collodion sacs,	66		
" destruction of,	85		

	PAGE		PAGE
Diplococcus, intracellularis		Fixation of tissues,	92, 95
meningitidis,	188	Flagella, nature of,	8
pneumoniæ,	207	staining of,	107
Disease, relation of bacteria to,	157	tetanus bacillus,	378
Drying of sera, etc., in vacuo,	81	typhoid bacillus,	322
Ducrey's bacillus,	231, 232, 233	Flagellated organisms in malaria,	522
Durham's fermentation tubes,	79	Flügge,	15
Dysentery, amœbic,	529	Food supply of bacteria,	17
" bacillary,	349	Forceps for cover-glasses,	89
" bibliography,	551	Formol alcohol, fixing by,	92
" characters of amœba of,	529	Formalin as antiseptic,	145
Dysentery, methods of examination		Foth's dry mallein,	283
in,	533	Fraenkel's pneumococcus, <i>see</i> Pneumococcus.	
Eberth's bacillus,	319	Frankland,	135
Ehrlich on ricin and abrin,	468, 473	Fraser, T. R.,	468, 473
" on toxins,	178, 385, 478	Freezing microtome, section-cutting,	93
" side-chain theory of anti-toxin formation,	490	Friedländer's pneumobacillus, <i>see</i> Pneumobacillus.	
Elsner's medium,	48	Frisch on rhinoscleroma,	285
Embedding in paraffin,	93	Fuchsin, carbol-,	102
Emmerich's bacillus,	319	Fungi,	
Empyema,	214, 433	" ascomycetæ,	149
Endocarditis, <i>see</i> Ulcerative endocarditis.		" bibliography,	537
Enhæmospores (malaria),	519	" blastomycetic dermatitis,	152
Enriching method, Schottelius',	426	" cultural characters,	154
Enteric fever,	319	" examination,	155
Enteritis, dysenteric,	532	" isolation,	156
Ermengem on botulism,	398	" morphology,	153
" stain for flagella,	109	" mucorinæ,	149
Erysipelas,	199	" pathogenic properties,	155
Escherich's bacillus,	319	" perisporiaceæ, <i>see that title</i> .	
Esmarch's roll-tubes,	60	" reproduction,	148
Exaltation of virulence,	466	" torulæ, etc.,	152
Examination of water,	133	Gamaliæa,	427, 428
Exhaust-pump,	75	Gametes (malaria),	517, 521
Exhaustion, theory of,	489	Gangrenous emphysema,	393, 396
Exotropes (malaria),	522	" pneumonia,	433
Extracellular toxins,	173	Gas production by B. coli,	328
False membrane,	193, 357	Gaseous environment of bacteria,	19
Farcy,	276	Gas-regulator,	83
Feeding, immunity by,	468	Geissler's exhaust-pump,	75
Fermentation by pneumo-bacillus,	213	Gelatin media,	40
" by bacillus coli,	326	" " separation by,	53
" methods of observing,	78	" phenolated,	330
" tubes,	79	" shake cultures,	78
Ferments formed by bacteria, 24, 78, 176, 495		Gelatinized porcelain filter,	174
" in diphtheria,	368	Gentian-violet,	101, 102
" in tetanus,	386	Germicides, <i>see</i> Antiseptics.	
Fever,	169	Geryk pump,	82
Film preparations, dry,	88, 107	Gibraltar, rock fever of,	451
" " wet,	91	Gindha spirillum,	425
" " staining of,	98	Glanders bacillus,	275, 277
Filter, porcelain, gelatinized,	174	" " action on tissues,	281
Filtration of cultures,	74	" " agglutination,	283
Finkler and Prior's spirillum,	416, 428	" " cultivation,	278
Fish, tuberculosis in,	254	" " inoculation,	280
Fixateurs,	495	" " powers of resistance,	279

	PAGE		PAGE
Glanders bacillus, staining,	278	Hill's modification of Smith's fermentation tube,	79
Glanders, bibliography,	542	Hiss's serum media,	46
“ diagnosis of,	283, 284	Hofmann's bacillus,	371
“ in horses,	276	Horsepox,	504
“ in man,	276	Houston on bacteriology of soil,	129
“ lesions in,	280	Hueppe,	7, 15
“ spread, mode of,	282	Humoral theory,	490
Glucose media,	38, 40, 41	Hydrogen, supply of,	59
“ broth and agar,	38, 40	Hydrophobia,	508
“ potato as culture medium,	47, 243	“ bibliography,	551
Gabbett's methylene-blue solution,	105	“ diagnosis of,	514
Golgi on malaria,	516	“ pathology,	509
Gonidia,	16	“ prophylactic treatment of,	512
Gonococcus, characters of,	223	“ virus of,	511
“ cultivation,	224	Hypodermic syringes,	119
“ distribution,	227	Immune-bodies,	482
“ examination,	230	“ origin of,	484
“ inoculation with,	226	Immunity,	460
“ joint affections, etc.,	229	“ acquired, theories of,	461, 489
“ plate-cultures,	226	“ active,	462, 464
“ relations to disease,	226	“ artificial,	462
“ staining,	224	“ bibliography,	549
“ toxins of,	227	“ feeding,	468
Gonorrhœa,	223, 540	“ methods,	463
Gonorrhœal conjunctivitis,	229	“ natural,	496
“ endocarditis,	230	“ passive,	463, 469
“ peritonitis,	229	“ toxins,	467
“ septicæmia,	230	“ unit of,	472
Gram's method,	102	“ <i>see also names of diseases.</i>	
“ modifications of,	103	Impression preparations,	114
Grass bacilli,	255	Incubation of cultures,	82, 83, 84
Greenfield on Anthrax,	311, 465	Indol, formation of,	80, 328
Growth of bacteria,	17, 115	Infection, conditions modifying,	158
Gruber and Durham's phenomenon,	485	“ nature of,	158
Grübler's stains,	97	Inflammation, bibliography,	538
Gulland (methods),	95	Inflammatory conditions due to bacteria,	182
Hæmameba danilewski,	524	Influenza,	430
“ malariae,	524	“ bacillus, cultivation of,	431
“ præcox,	524	“ “ distribution,	432
“ relicta,	524	“ “ examination,	435
“ vivax,	524	“ “ inoculation,	433
Hæmatozoon malariae,	516	“ “ powers of resistance,	432
Hæmolytic sera,	482	“ bibliography,	548
Haffkine on anti-cholera inoculation,	468	“ “ lesions in,	432
Haffkine's inoculation method against plague,	444	“ “ sputum in,	431-433
Hanging-block cultures,	70	Inoculation, methods of,	118
Hanging-drop cultures,	68	“ of animals,	117
“ examination of,	87	“ “ separation by,	58
Hankin,	313	“ protective,	468 <i>et seq.</i>
Hansen, leprosy bacilli,	269	“ syringes for,	118, 119
Hardening of tissues,	92	Intestinal changes in cholera,	408
Harris's collodion sacs,	67	“ “ amœbic dysentery,	529
Hearson's incubator,	84	“ “ bacterial dysentery,	352, 354
Heat, sterilisation by,	28		
Hesse's tube,	123		
Higher bacteria,	1, 15		
“ reproduction,	5		

	PAGE		PAGE
Malta fever, bibliography,	549	Moisture necessary to growth of bac-	
“ “ methods of diagnosis,	454	teria,	18
Mann's method of fixing sections,	95	Mordants,	99
Manson on malaria,	516, 517, 527	Morphology,	I
Maragliano's anti-tubercular serum,	264	“ bibliography,	535
Marchiafava and Celli on malaria,	516	Mosquitoes in malaria,	516, 517, 521
Marmorek on streptococci,	191	“ rôle in yellow fever,	458
“ anti-streptococcic serum,	479	Motility,	8, 21
“ serum media,	45	Mucorinæ,	149
Martin, C. J. (toxins),	174	Muencke's filter,	77
“ (antitoxins),	474	Muir's staining method,	106, 527
Martin, Sidney, on albumoses, etc.,	174	Müller's bacillus,	201
“ “ (anthrax),	312	Mycetoma,	297
“ “ (diphtheria),	356, 368	Mycoderma, fungi,	152
“ “ (tetanus),	385	Myelocytes, neutrophile,	165
Massowah vibrio,	416, 425	Nascent oxygen as antiseptic,	144
Measuring bacteria,	116	Natural immunity,	496
Meat infusion,	34	Nature, effects of bacteria in,	22, 25
Meat-poisoning by bacillus botulinus,	398	Neapolitan fever,	451
“ “ by Gaertner's bacil-		Neelsen's stain for tubercle,	104
lus,	331	Neisser's gonococcus,	223
Mediterranean fever,	451	Nencki,	11
Melitensis, micrococcus,	452	Neutral-red, use of,	42, 137
Meningitis, bibliography,	539	“ “ with B. typhosus,	329
“ epidemic cerebrospinal,	188, 200	Neutrophile leucocytes,	165
“ in influenza,	433	“ myelocytes,	165
“ pneumococci in,	214	Nicolaier, tetanus bacillus,	376
Mercury perchloride as antiseptic,	144	Nicolle's modification of Gram's	
Mesenteric glands in typhoid fever,	332	method,	103
Metabolism, disturbances of, by bac-		Nikati and Rietsch (cholera),	415
teria,	164, 169	Nitrifying bacteria,	25
Metachromatic granules,	9	Nitroso-indol body,	81
Metchnikoff on cholera in rabbits,	416	Nordhafen vibrio,	428
“ “ Pfeiffer's phenom-		Obermeier's spirillum,	447
enon,	481	Œdema, malignant, <i>see</i> Malignant	
“ “ phagocytosis theory,	493	œdema.	
“ “ relapsing fever,	449	Ogata's dysentery bacillus,	354
“ “ spirillum,	427	Ogston,	182
Methylene-blue,	97, 100, 101	Oidium lactis,	149
Methyl-violet,	97	Oil, aniline, for dehydrating, etc.,	96
Micrococci of suppuration,	182	“ immersion lens,	87
Micrococcus,	14	Organisms lower than bacteria,	2, 458
“ melitensis,	452	Oriental plague,	435
“ of gonorrhœa,	223	Osteomyelitis,	199
“ pyogenes tenuis,	182	Otitis,	214
“ tetragenus,	187	Oxygen, nascent, as antiseptic,	144
“ “ lesions		Ozœna bacillus,	286
caused by,	194	Paracolon bacillus,	331
“ ureæ,	24	Paraffin embedding,	93
Microcytase,	484	“ sections,	
Microphages,	493	“ “ cutting,	94
Microscope, use of,	87	“ “ preparation for	
Microscopic methods, bibliography,	537	staining,	95
Microtomes,	93	Park's method of anaerobic culture,	64
Migula,	14, 15	Passage,	466
Mikulicz, cells of,	285	Passive immunity,	463, 469
Milk as culture medium,	48	Pasteur on exaltation of virulence	
“ curdling by B. coli,	327	of bacteria,	466
Moeller's grass bacilli,	255		
Moeller's stain for spores,	106		

	PAGE		PAGE
Pasteur on hydrophobia,	512	Plate-cultures, agar,	57
" on vaccination against an-		" " anthrax,	302
thrax,	315	" " gelatin,	53
" septicæmie de,	393	" " gonococcus,	226
Pathogenic bacteria,	158	Platinum needles,	51
Penicillium glaucum,	151	Pneumobacillus (Friedländer's),	207, 209
Peptone broth or bouillon,	35	" cultivation,	212
" gelatin,	40	" effects,	218
" solution,	43	" examination,	209, 222
Perchloride of mercury as antiseptic,	144	Pneumococcus (Fraenkel's),	207, 208
Periostitis, acute suppurative,	199	" cultivation,	210
Perisporiaceæ,		" examination,	207, 222
" aspergillus niger,	150	" immunity against,	219
" penicillium glaucum,	151	" in endocarditis,	197
Peritonitis,	191, 229	" inoculation,	215
Perlsucht,	238	" lesions caused by,	213
Pestana spirillum,	425	" toxins of,	219
Pestis major,	441	Pneumonia, bacteria in,	207
" minor,	441	" bibliography,	539
Petri's acid-fast bacillus,	256	" gangrenous,	213, 433
" dishes,	54	" history,	206
" sand-filter for examining air,	125	" in influenza,	432
Petruschky's litmus-whey,	41	" methods of examination,	221
Pettenkofer on cholera,	420, 424	" septic,	206
Pfeffer,	21	" staining films,	208
Pfeiffer on anti-serum,	481	" varieties of,	205
" cholera,	417, 422	Pneumoniæ, bacillus,	207
" influenza,	430	" diplococcus,	207
" protozoa in smallpox,	506	" streptococcus,	207
" typhoid,	340	Polar granules,	9
Pfeiffer's phenomenon,	422, 481	Potassium permanganate as antiseptic,	146
Phagocytes,	165	Potatoes as culture material,	46, 279
Phagocytosis theory,	490, 493, 494	Poynton and Payne on acute rheu-	
Phenol-phthaleine as indicator,	36	matism,	203
Phenomenon of Bordet,	481	Preparations, impression,	114
" " Gruber and Durham,	485	Prophylactic treatment of hydropho-	
" " Pfeiffer,	417, 481	bia,	512
Pigments, bacterial,	11	Protective inoculation,	467
Piorkowski, syphilis bacilli,	235	Proteosoma,	516, 524
Pipettes,	113	Protozoa described in hydrophobia,	511
Pitfield's flagella stain,	108	" " smallpox,	506
Plague, bacillus of,	435	Protozoon malarizæ,	516
" " anatomical changes		Pseudo-diphtheria bacillus,	370
and distribution,	439	" -tuberculosis streptothricea,	295
" " characters,	436	Psittacosis bacillus,	331
" " cultivation,	438	Ptomaines,	172
" " involution forms,	437	Puerperal septicæmia,	193
" " stalactite growths		Pus, examination of,	90, 204
of,	438	Pustule, malignant,	310
" " bibliography,	548	Pyæmia,	193
" Haffkine's inoculation against,	444	" nature of,	181
" immunity against,	444	Quartan fever,	524
" infection in,	442	Quarter-evil, bacillus of,	401
" preventive inoculation		" bibliography,	547
against,	444	Quotidian fever,	523
" serum diagnosis,	446	Rabies, <i>see</i> Hydrophobia.	
" toxins,	444	Rabinowitsch's acid-fast bacillus,	256
" varieties of,	439	Rauschbrand bacillus,	401
Plasmodium malarizæ,	516		
Plasmolysis,	9		

	PAGE		PAGE
Ray-fungus (actinomyces),	287	Septicæmie de Pasteur,	393
Reaction of media, standardising of,	36	Septic pneumonia,	206
Receptors,	490	Sera, hæmolytic,	482
Recovery from disease,	462	Serum, agar,	42
Red stains,	97	“ agglutinative action of,	109, 344, 454, 484
Reichert's gas regulator,	83	“ antibacterial,	463, 469, 479
Relapsing fever, agglutination of spirillum,	451	“ anticharbonneux,	316
“ “ bactericidal serum in,	451	“ anticholera,	420
“ “ bibliography,	489	“ antidiphtheritic,	470
“ “ spirillum of, etc.,	447	“ anti-plague, <i>see that title.</i>	
Retention, theory of,	489	“ antipneumococcic,	219
Rheumatism, acute,	202	“ antirabic,	514
“ bibliography,	539	“ antistreptococcic,	479
Rhinoscleroma, bacillus of,	285	“ antitetic,	389
“ bibliography,	543	“ antitoxins, <i>see that title.</i>	
Ricin,	177	“ antitubercular,	264
“ immunity against,	468, 473	“ antityphoid,	347
Rietsch and Nikat, cholera,	415	“ bactericidal action of,	498
Rivers, bacteria in,	135	“ blood,	43, 45
Robin,	177	“ diagnosis,	485
Rock fever,	451	“ “ methods,	109
Roll-tubes, Esmarch's,	56	“ “ of typhoid,	340
Romanowsky, staining method,	527	“ inspissator,	44
Romanus spirillum,	425	“ lysogenic action of,	480
Rosenbach (bacteria in suppuration),	182	“ “ towards blood corpuscles,	482
Ross on malaria,	522	“ media,	45
Roux on antitoxic sera,	472	“ sedimenting properties,	109
“ “ diphtheria,	172, 356, 364-371	Sewage, bacterial treatment of,	138
Saccharomyces,	152	“ contamination of water by,	137
Safranin,	97	Shake cultures,	78
Salt-agar as medium for <i>B. pestis</i> ,	437	Sheep-pox,	505
Sanarelli, typhoid fever,	335	Shiga's bacillus,	350
“ yellow fever,	457	Side-chain theory, Ehrlich's,	490
Sanderson, Burdon,	465, 505	Singer, acute rheumatism,	203
Saprophytes,	23, 157	Slides for hanging-drops,	68
Sarcina,	13, 14	Sloped cultures, aerobic,	50
Sausage poisoning by bacillus botulinus,	398	“ “ anaerobic,	66
Scarification,	118	Smallpox,	501
Schizomycetes,	3	“ bacilli in,	505
Schizophycæ,	3	“ bibliography,	550
Schizophyta,	3	“ micro-organisms associated with,	505
Schottelius' enriching method,	426	“ protozoa as causative agents,	506
Schuykiliensis spirillum,	428	“ relation to cowpox,	503
Scorpion poison,	178	Smegma bacillus,	234, 256
Section-cutting,	93	Smith, T.—detecting <i>B. coli</i> in water,	136
“ fixation methods,	92, 95	Smith's fermentation tube, Hill's modification,	79
Sections, dehydration of,	96	Smith's, Lorrain, serum medium,	45
Sedgwick-Tucker method for examining air,	125	Snake poisons,	178, 468, 473-475
Sedimentation methods,	109	“ “ immunity against,	468
“ test for typhoid,	341	Soft sore,	231
Seitenketten,	490	“ “ bibliography,	540
Separation of aerobes,	53	Soil, examination of, for bacteria,	128
“ “ anaerobes,	60	Soudakewitch on relapsing fever,	450
Septicæmia, nature of,	181	Spinal cord, lesions by pyogenic organisms,	192
“ puerperal,	193		
“ sputum,	207		

	PAGE		PAGE
Spirilla, characters of,	15	Staphylococcus, cereus flavus,	182, 184
“ like cholera spirillum,	424	“ epidermidis albus,	184
Spirillum Metchnikovi,	427	“ pyogenes albus,	182, 184
“ of Deneke,	429	“ aureus,	207
“ of Finkler and Prior,	416, 428	“ “ characters	
“ of Miller,	429	“ of,	182
“ relapsing fever, inoculation		“ “ inoculation	
with, etc.,	447	“ with,	189
“ Schottelius' enriching		“ “ citreus,	184
method,	426	Steam steriliser,	30, 31
“ Schuykiliensis,	428	Stegomyia fasciata,	459
see also Cholera spirillum and Vibrio.		Sterilisation by heat,	28
Spirochæta,	15	“ at low temperatures,	32
Spleen, typhoid bacilli in,	333, 348	“ by steam at high press-	
Splenic fever,	300	ure,	31
Spore formation, arthrosporous,	7	Sternberg's bulb for thermal death-	
“ “ B. anthracis,	304	point test,	70
“ “ B. tetani,	378, 381	Stewart's forceps,	89
“ “ endogenous,	5	Stone,—detecting B. coli in water,	136
“ “ malaria,	519	Storing of cultures,	82
Spores, staining of,	106	Streptococci in diphtheria,	360
Sporocyst (malaria),	522	“ in false membrane,	193
Sporocytes, in malaria,	521	“ lesions caused by,	193
Sporeulation of malarial parasite,	521	“ varieties of,	191
Sputum, amœbæ in,	532	Streptococcus,	12
“ influenza,	431, 433	“ brevis,	191
“ in plague,	447	“ conglomeratus,	186, 192
“ in pneumonia,	208	“ erysipelatis,	191
“ phthisical,	243, 248, 259	Streptococcus longus,	191
“ septicæmia,	207	“ pneumoniæ,	207
Staining methods,	96	“ pyogenes, characters of,	184
“ capsules, Welch's method,	106	“ “ inoculation	
“ diphtheria bacillus,	363	“ with,	190
“ films,	98	“ “ in soil,	131
“ flagella,	107	Streptothrices, allied to actinomyces,	295
“ formulæ of stain combina-		“ bibliography,	543
tions,	100	Streptothrix,	16
“ Gabbett's methylene-blue		“ actinomyces,	288
solution,	105	“ maduræ,	298
“ glanders bacillus,	278	Structure of bacteria,	3
“ gonococcus,	224	Subcultures,	51
“ leprosy bacilli,	105, 270	Subcutaneous injection,	118
“ malarial parasite, see that		Sugar, fermentation,	78, 326
title.		Sulphurous acid as antiseptic,	146
“ Muir's method,	106, 527	Suppuration, bacteria of,	182
“ paraffin sections, prepara-		“ bibliography,	538
tion for staining,	95	“ gonococci in,	228
“ pneumonia films,	208	“ methods of examination	
“ principles,	96	of,	204
“ spores,	106	“ nature of,	180
“ tubercle bacilli,	104	“ origin of,	195
“ Ziehl-Neelsen,	104	“ pneumococci in,	214
Stains, basic aniline,	97	“ typhoid bacillus in,	334
Stalactite growths, plague bacillus,	438	Symptoms caused by bacteria,	171
Standard of immunity,	472	Syphilis, bacillus of,	233
Standardising reaction of media,	36	“ bibliography,	541
“ serum,	472	Syringes for inoculation,	118, 119
Staphylococci, lesions caused by,	193	Tabes mesenterica,	259
Staphylococcus,	13	Temperature, growth of bacteria,	19
“ cereus albus,	182, 184		

	PAGE		PAGE
Tertian fever,	524	Tubercle bacillus, cultivation of,	241
Test-tubes for cultures,	49	“ “ dead, action of,	258
Tetanolysin,	385	“ “ distribution of,	246
Tetanospasmin,	385	“ “ immunity against,	264
Tetanus,	376	“ “ in sputum, etc.,	243, 248, 259
“ anti-serum of,	389 <i>et seq.</i>	“ “ inoculation with,	249
“ “ intracerebral injection of,	391	“ “ Koch's discovery, 236, 237	
“ bibliography,	546	“ “ powers of resistance	
“ immunity against,	389	“ “ of,	243
“ methods of examination,	392	“ “ stains for,	104
“ treatment of,	391, 489	“ “ toxins of,	262
Tetanus bacillus,	377	“ giant-cells,	244, 245
“ “ characters,	377	“ methods of examination of,	264
“ “ inoculation with,	383	Tubercles, structure of,	244
“ “ isolation of,	379	Tubercular leprosy,	267, 268
“ “ pathogenic effects,	381	Tuberculin, diagnosis of tuberculosis	
“ “ spores of,	379, 381	“ by,	262
“ “ toxins of,	173, 384	“ Koch's,	260
Tetrads,	13	“ “O" and "R,"	263
Theory of exhaustion,	489	Tuberculosis,	236
“ of phagocytosis,	490, 493	“ avian,	238, 252
“ of retention,	489	“ bibliography,	541
“ humeral,	490	“ bovine,	250
Thermal death-point test,	70	“ diagnosis by tuberculin, 262	
Thionin-blue,	97, 101	“ history,	236
Thiothrix,	16	“ in animals,	237
Timothy grass bacillus,	255	“ in fish,	254
Tissues, action of bacteria on,	164	“ modes of infection,	259, 260
“ examination of bacteria in,	91	“ precautions in diagnosis	
“ fixation of,	92	“ of,	257
Tizzoni and Cattani on tetanus,	389	“ symptoms,	246
Torulæ,	152	“ varieties,	250
Toxalbumins,	172	Tubes, cultures in,	51
Toxic action, theory of,	178	Typhoid bacillus,	319, 320
Toxicity, estimation of,	470	“ “ comparison with B.	
Toxins, antitoxins, <i>see that title.</i>		“ coli,	326
“ circulating blood, toxin in,	387	“ “ cultures,	321, 322, 326
“ concentrated, method of obtaining,	176	“ “ examination for,	347
“ constitution of,	478	“ “ history,	319
“ early work on,	171	“ “ immunity against,	337
“ effects of,	168	“ “ inoculation with,	334
“ Ehrlich's theory,	178, 478, 490	“ “ relationship to fever, 339	
“ immunisation by,	467	“ “ serum diagnosis,	340
“ intra- and extra-cellular,	173	“ “ suppurations in,	334
“ nature of,	174	“ “ toxins of,	336
“ non-proteid,	175	“ “ vaccination against, 346	
“ production of,	162	“ fever,	319
“ susceptibility to,	499	“ “ bibliography,	544
“ vegetable,	177	“ “ pathological changes in,	332
“ <i>see also names of diseases, Anthrax, etc.</i>		Ulcerative endocarditis,	197
Toxoids,	179, 478	“ “ experimental, 198	
Toxones,	179, 478	“ “ gonococci in, 230	
Tropical malaria,	525	Unit of immunity,	472
Tubercle bacillus,	236	Urine, examination of,	74
“ “ action,	244, 258	“ staining of bacteria in,	90
“ “ avian,	238, 252	“ tubercle bacilli in,	248, 265
“ “ characters,	238	“ typhoid bacilli in,	348

	PAGE		PAGE
Ushinsky, medium,	368	Water, bibliography,	537
" nature of toxins,	174	" contamination of, by sewage,	137
Vaccination, Jennerian,	501	" examination of,	133
" nature of,	506	" typhoid bacilli in,	349
" <i>see also diseases</i> , Typhoid, <i>etc.</i>		Weichselbaum on pneumonia,	207
Vacuo, drying substances in,	81	Weigert's method of dehydration,	96
Vaillard on tetanus,	388	" modification of Gram's method,	103
Van der Loeff, protozoa in smallpox,	506	Welch's gas-bacillus,	402
Van Ermengem, <i>see</i> Ermengem.		" staining method,	106
Van Niessen, syphilitic lesions,	235	Wertheim's medium,	224, 225, 226
Variola,	503	Widal on serum diagnosis,	485
Vegetable poisons, toxins,	177, 468, 473	Winogradski,	25
Venins,	178	Winter-spring fevers,	523
Vibrio,	15	Woodhead on tuberculosis,	259, 260
" berolinensis,	424	Woody tongue,	293
" of cholera,	407	Woolsorter's disease,	311
" Danubicus,	424	Wright's method of anaerobic culture,	64
" Deneke's,	429	Xerosis bacillus,	373
" Finkler and Prior's,	416, 428	Xylol,	96
" Gindha,	425	Yeast, form of fungi,	152
" Ivanoff,	424	Yellow fever,	455
" Massowah,	416, 425	" " bacteria in,	456
" Metchnikovi,	427	" " bibliography,	549
" Nordhafen,	428	" " etiology of,	456
" Pestana and Bettencourt,	425	" " mosquitoes in relation to,	458
" Romanus,	425	Yersin, anti-plague serum,	445
" <i>see also</i> Spirillum.		" diphtheria,	172, 356, 364-371
Vibrion septique,	393	" plague,	435
Virulence, attenuation of,	464	Ziehl-Neelsen stain,	104
" exaltation of,	466	Zoogloea,	4
" of bacteria,	158	Zygote (malaria),	522
Wasielewski, smallpox,	506	Zygotoblasts (malaria),	522
Water, bacteria in,	133		

Experimental Morphology

BY

CHARLES BENEDICT DAVENPORT, Ph.D.

Instructor in Zoölogy in Harvard University

PART I. — Effects of Chemical and Physical Agents upon the Protoplasm

Cloth 8vo \$2.60, net

PART II. — Effects of Chemical and Physical Agents upon Growth

Cloth 8vo \$2.00, net

“The material which is discussed has been well digested and is well arranged, and the style is on the whole clear and concise. The book is a readable one, and the descriptions and criticisms of the methods employed in experimentation, and the bibliographical lists at the conclusion of each chapter, contribute materially to the value the book possesses for both the morphologist and the physiologist.” — *Science*.

“In this second instalment of his valuable treatise, Dr. Davenport considers the effects of chemical and physical agents on growth. Plants lend themselves so readily to observations respecting growth that they have received from Dr. Davenport a degree of attention in this work which compels the student of plant physiology to accept his aid. On the whole, the editorial work has been wonderfully well done, and the errors are so few that they need not be mentioned here; they do not appear likely to mislead seriously any students who make use of the vast amount of material which has been gathered patiently, and for the most part has been well arranged.” — *American Journal of Science*.

THE MACMILLAN COMPANY

66 FIFTH AVENUE, NEW YORK

CHICAGO

BOSTON

SAN FRANCISCO

ATLANTA

A Manual of Determinative Bacteriology

BY

FREDERICK D. CHESTER

*Bacteriologist of the Delaware College Agricultural Experiment Station, and
Director of the Laboratory of the State Board of Health of Delaware;
Member of the Society of American Bacteriologists; of the
Society for the Promotion of Agricultural Science;
and of the American Public Health Association*

Cloth 8vo \$2.60, net

“We believe that it will be, as the author hopes, a convenient guide for the student with cultures to identify, and as such will prove a valuable adjunct to the elaborate manuals of this microscopic science.”

— *New York Post.*

“The student of botany, the hygienist, and the physician are the richer by the publication of this important work.” — *Medical News.*

“It is preëminently as a laboratory guide in the identification of the various forms of bacteria unknown to the student that the work is to be commended, and as such it is indispensable. — *Medical Record.*

“Will no doubt find a place among the reference books of most bacteriological laboratories.” — *Plant World.*

“The book can be recommended confidently to the laboratory workers in general.” — *Journal of the American Medical Association.*

THE MACMILLAN COMPANY

66 FIFTH AVENUE, NEW YORK

CHICAGO

BOSTON

SAN FRANCISCO

ATLANTA

