

Flower Library

QR  
46  
E53  
1908

CORNELL UNIVERSITY.

THE

**Roswell P. Flower Library**

THE GIFT OF

ROSWELL P. FLOWER

FOR THE USE OF

THE N. Y. STATE VETERINARY COLLEGE

1897

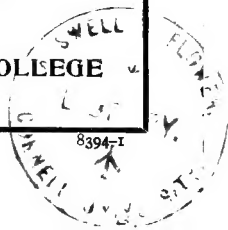

Cornell University Library

QR 46.E53 1908

Clinical bacteriology and haematology fo



3 1924 000 246 292

vet



Cornell University  
Library

The original of this book is in  
the Cornell University Library.

There are no known copyright restrictions in  
the United States on the use of the text.

<http://www.archive.org/details/cu31924000246292>

CLINICAL BACTERIOLOGY AND HÆMATOLOGY  
FOR  
PRACTITIONERS



# CLINICAL BACTERIOLOGY AND HÆMATOLOGY

FOR

PRACTITIONERS

BY

W. D'ESTE EMERY, M.D., B.Sc. LOND.

CLINICAL PATHOLOGIST TO KING'S COLLEGE HOSPITAL AND PATHOLOGIST TO THE CHILDREN'S  
HOSPITAL, PADDINGTON GREEN; FORMERLY ASSISTANT BACTERIOLOGIST TO THE ROYAL  
COLLEGES OF PHYSICIANS AND SURGEONS, AND SOMETIME LECTURER ON PATHOLOGY  
AND BACTERIOLOGY IN THE UNIVERSITY OF BIRMINGHAM

THIRD EDITION

PHILADELPHIA

P. BLAKISTON'S SON & CO., 1012, WALNUT ST.

1908

D

21/12/09

LIBRARY  
UNIVERSITY OF  
CAMBRIDGE

No. 3393  
PRINTED IN ENGLAND

QR  
46  
E53  
1908

~~I  
EX3  
1908~~



## PREFACE TO THIRD EDITION

IN making such alterations as seemed called for in the preparation of this edition, an attempt has been made to avoid as far as possible any further expansion. It has been thought, however, that a brief account of the methods of preparing bacterial vaccines should be inserted: not that the practitioner should necessarily make them for himself, but so that he may have a general idea of the process. Of the other changes made, the main are an account of making cultures of the blood by the use of an all-glass exploring syringe, fuller details concerning lumbar puncture, the diagnostic value of this operation in uræmia, and the use of a Dewar's flask as an incubator.

Some of the coloured plates have been redrawn, and Figs. 31, 34, and 45 (for which I have to thank Mr. R. Gompertz) added. My thanks are also due to Dr. H. B. Day for Figs. 16, 17, and 26, and to Messrs. Down Bros. for Fig. 30.

W. D'ESTE EMERY.

*June*, 1908.



## PREFACE TO SECOND EDITION

THE success of the first edition of this book, and in particular the numerous proofs I have received that it has been of value to those for whom it was intended—that is, to practitioners who are without training in pathology, and who want a simple guide to refer to—has encouraged me to add to it somewhat, though without altering its general scope.

The additions to the bacteriological portion are mostly concerned with the examination of materials from special parts of the body—mouth, conjunctiva, etc.—which were insufficiently dealt with in the first edition, and are treated on simple lines; in most cases the diagnosis by microscopical methods, and in particular by the application of Gram's stain, is given.

The hæmatological portion is almost all new, and is written in response to numerous requests for a practical guide to blood examinations, especially their application to the diagnosis of disease. I have attempted to deal with the subject on the same lines as the bacteriological portion—that is, to explain the conditions under which a certain examination is indicated, the method employed (in full detail), the deductions to be drawn from the results obtained, and the cautions necessary in interpreting them. It is in respect of these interpretations of blood-counts that I think such a guide as this is most urgently required, as I find there is a lamentable ignorance of the conditions under which blood-counts are required and the methods of drawing deductions from them. The result is that these examinations are often made unnecessarily or omitted when they should be made, that the diagnosis is not helped, and the clinical pathology is not appreciated as it ought to be. The great stumbling-block has been

that the blood-count has been thought to give the diagnosis directly, without requiring any mental exertion on the part of the physician or surgeon. It does so in some cases, but in most it is to be regarded as an additional fact to be considered in making a diagnosis—in many cases the chief and most important fact, but one that must always be considered in conjunction with those obtained by ordinary clinical methods. The results of a blood examination are similar to those of any other physical examination; they are easy to obtain, but often very difficult to interpret, and, just as in the diagnosis of the diseases of the chest or the nervous system, it requires much experience to make use of signs which a student can elucidate. And, as in the case of the other physical signs, the blood-findings are sometimes equivocal. It is about as reasonable to discredit them on that account as to discredit percussion of the chest because dulness does not always indicate pneumonia. In spite of these difficulties the examination of the blood is one that is more likely, in many cases, to give a clue to what is actually taking place than is any other. As Cabot puts it, "The blood is the only tissue which we can easily examine during the life of the patient. Its relations to all other tissues are such that it is typical of them all in a way that no other tissue is, acting on all and being acted on by all." Here I have attempted to give an elementary guide to some of the more important and simple changes, and for further reference the practitioners are recommended to consult one of the largest works on the subject, such as those of Da Costa, Ewing, or Cabot, all of which are admirable and full of valuable information.

I have to thank Dr. Whitfield for the loan of the very admirable photographs on Plates IV. and VI., and for revising the sections on ringworm, etc., and Professor Schaudinn for the figures of the spirochæte of syphilis shown on Plate V.

W. D'ESTE EMERY.

*March, 1906.*

## PREFACE

No practitioner who wishes to do his best for his patients and to promote his own interests can afford to neglect any means of clinical investigation which may help him to arrive at a correct diagnosis, and offer hints as to prognosis and treatment. Pre-eminent among the more recent methods of investigation are those which are applied by the bacteriologist, and it is no exaggeration to say that in many of the infective diseases a diagnosis which is made without a bacterioscopic examination is either mere guesswork or can only be made so late that the patient has suffered unnecessarily in health and the practitioner in prestige. In many cases, however, the investigation requires a considerable amount of technical skill and access to a well-equipped laboratory. The former may, perhaps, be possessed by the rising generation (for bacteriology is now an integral part of the medical curriculum), but it would be unfair to expect every medical man to add the latter to his already expensive equipage. But in many cases the diagnosis can be arrived at by very simple means—a few slides, cover-glasses, and stains, a good microscope (which ought to be considered as essential as a stethoscope), and a very moderate amount of technical skill, will often enable the practitioner to arrive at a correct diagnosis in a very short time. This little book is intended, in the first instance, to show exactly when this may be done, and to provide clear, succinct, and full descriptions of simple methods which may be employed. The descriptions of the operations which the practitioner can carry out for himself are mostly written in the imperative mood, and are intended to be referred to constantly and carried out, step by step, during the process. They represent the instructions which would be given by a teacher when

watching a beginner making a simple bacteriological examination for the first time.

It cannot be too strongly urged that the practitioner should make the examination for himself whenever it is possible for him to do so, and if not, to call in the services of an expert pathologist. The report which is sent from a public laboratory may often be of very considerable value, but it must be remembered that the bacteriologist can only supply facts, and the inferences which may be drawn from those facts will largely depend upon a knowledge of the patient's clinical history and the method in which the material was obtained. The bacteriologist is too often in the position of a detective who has to unravel a mystery from observations made by other people, and has no opportunity of making investigations for himself. A bacteriological examination which is made by one person and interpreted by another, or which is made on material which has passed through more hands than one, loses much of its value, and an investigation made on the spot may be more valuable than one made by a bacteriologist of far greater experience at a distance.

The methods which are described in this little book are not in all cases the ideal ones, and in some cases they are somewhat different from those which are generally used, but they are simple and efficient. Of course, the simple examinations which are described here would frequently be supplemented by more complicated cultural ones by a trained bacteriologist. The methods described here have been taught in the post-graduate classes which were initiated some two years ago in the University of Birmingham. These have already been attended by about a hundred practitioners, who have found these methods of great assistance to them in their everyday practice. They have been selected so as to provide examples of some of the more important operations in constant use in the bacteriological laboratory. The author takes this opportunity of expressing his cordial thanks to Professor Leith for his kind suggestions as to the general scope of the book.

No apology will be made for the numerous repetitions which will be found in this book. They are essential to its scope, which is to give clear accounts of the processes with as little reference to

other chapters as possible. In the majority of cases each section is complete in itself.

These instructions are followed by information as to the interpretation of the results which may be obtained, and this information applies equally whether the medical man has made the examination for himself or has obtained it ready-made from a public laboratory. It, too, commonly happens that practitioners feel themselves aggrieved because they get a negative report (as to the presence or absence of Widal's reaction) on blood taken during the first few days of an illness which turns out to be typhoid fever, or are inclined to discredit bacteriological examinations because diphtheria bacilli are found in throats which exhibit no membrane and clear up in a few days without serious symptoms.

In the second place, there are a few cases in which the investigation had better be made in a public laboratory. In these the questions of what to send and how to send it are fully explained. This is a most important point. A bacteriologist is not a magician who is able to weave a spell if he has a small portion of his victim's anatomy to work upon, and the materials *must* be taken in the proper way if his results are not to be useless or even misleading. This is well seen in the examination of the blood for bacteria. In many cases the blood is drawn in such a manner that it must necessarily be contaminated from the skin during the operation, and is transmitted in vaccine tubes which were almost certainly not sterile before being filled. Under such circumstances the bacteriologist will probably report the presence of streptococci or staphylococci, and the practitioner who does not understand the fallacies of the examination may be led to make a diagnosis which will be disastrous to his own reputation, and may be injurious to the patient.

Lastly, it need scarcely be said that this is not intended to be a substitute for any one of the numerous excellent works on the science of bacteriology which are current at the present time. The practitioner is strongly recommended to supplement the very meagre details concerning the life-history and pathogenic action of the bacteria which are dealt with here by a study of one of these text-books. Muir and Ritchie's admirable "Manual of Bacteriology," Crookshank's "Bacteriology and Infective

Diseases," Hewlett's "Bacteriology," Klein's "Micro-organisms and Disease," McFarland's "Text-book upon the Pathogenic Bacteria," or Curtis's "Essentials of Practical Bacteriology," are all suitable for this purpose, and a perusal of any one of them will be both pleasurable and profitable to every medical man.

Several illustrations have been borrowed from sources mentioned in the text, and for the loan of these the author wishes to express his best thanks to the respective authors and publishers. His best thanks are also due to Messrs. Baird and Tatlock, Swift and Son, Zeiss, Leitz, Hawksley, and Hearson, for kindly providing illustrations of apparatus made by them.



# CONTENTS

## PART I BACTERIOLOGY

### SECTION I APPARATUS AND PROCESSES

	PAGE
THE BACTERIOLOGICAL MICROSCOPE	I
STERILIZATION OF APPARATUS, ETC.	5
PREPARATION OF CULTURE MEDIA	9
INOCULATION OF CULTURE MEDIA	16
INCUBATION OF CULTURES	18
METHOD OF EXAMINING CULTURES	22
GRAM'S METHOD OF STAINING -	24
EXAMINATION OF FILMS—USE OF MICROSCOPE	27
STAINS - -	28
CLEANING SLIDES AND COVER-GLASSES	31
PIPETTES	32

### SECTION II DIAGNOSIS OF CERTAIN DISEASES

DIPHTHERIA	37
TETANUS	45
THE PNEUMOCOCCUS, PNEUMONIA, ETC.	49
INFLUENZA	52
ANTHRAX -	54
TUBERCLE	59
LEPROSY	65
ACTINOMYCOSIS, OR STREPTOTHRICOSIS	65

	PAGE
GLANDERS	68
TYPHOID FEVER	69
GONORRHOEA	84
SYPHILIS	89
CHOLERA	91
PLAGUE	93
SOFT SORE	94
RINGWORM	95
OTHER SKIN DISEASES -	100

## SECTION III

## COLLECTION AND EXAMINATION OF CERTAIN MORBID MATERIALS

THE COLLECTION AND EXAMINATION OF PUS -	102
THE BACTERIOLOGICAL EXAMINATION OF THE MOUTH AND FAUCES	105
THE BACTERIOLOGICAL EXAMINATION OF THE NOSE AND ACCESSORY CAVITIES	110
THE CONJUNCTIVA	111
THE SPUTUM	113
THE GASTRIC CONTENTS AND VOMIT	115
THE URINE	118
THE COLLECTION OF FLUIDS FROM SEROUS CAVITIES	121
THE PLEURA	123
FLUIDS FROM JOINTS - -	126
LUMBAR PUNCTURE	128
THE BACTERIOLOGICAL EXAMINATION OF THE BLOOD -	138
EXAMINATION FOR BACTERIA IN FILMS	141
MALARIA - -	142
EXAMINATION BY CULTURAL METHODS	143
ESTIMATION OF THE OPSONIC POWER OF THE BLOOD -	148
COLLECTION OF MATERIAL AT POST-MORTEM EXAMINATIONS	158
SECTION-CUTTING	159
FIXING MATERIAL FOR CUTTING	161
SECTION-CUTTING BY THE FREEZING METHOD -	163
STAINING AND MOUNTING FROZEN SECTIONS - -	165

	PAGE
THE PARAFFIN PROCESS	166
DEHYDRATION	166
CLARIFICATION	167
INFILTRATION WITH PARAFFIN	167
CASTING THE BLOCKS	167
CUTTING THE SECTIONS	168
STAINING AND MOUNTING PARAFFIN SECTIONS	170

## PART II

## HÆMATOLOGY

ESTIMATION OF THE AMOUNT OF HÆMOGLOBIN	175
CLINICAL APPLICATIONS	179
ESTIMATION OF THE RED CORPUSCLES	181
ESTIMATION OF THE NUMBER OF LEUCOCYTES	193
THE INVESTIGATION OF THE MORPHOLOGY OF THE LEUCOCYTES AND RED CORPUSCLES	198
FIXATION OF BLOOD-FILMS	202
STAINING BLOOD-FILMS FOR THE INVESTIGATION OF THEIR CELLS	203
DIFFERENTIAL LEUCOCYTE COUNT	206
DIAGNOSTIC APPLICATIONS OF THE BLOOD COUNT AS A WHOLE	216

## PART III

## CYTO-DIAGNOSIS

CYTO-DIAGNOSIS	233
APPENDIX	245
INDEX	247

## DESCRIPTION OF PLATE I.

- FIG. 1.—Diphtheria bacilli (long form) from a young culture on blood-serum. Löffler's blue.  $\times 1000$ .
- FIG. 2.—Diphtheria bacilli (short form) and Hoffmann's bacillus. From young cultures on blood-serum. Löffler's blue.  $\times 1000$ .
- FIG. 3.—Pneumococci in sputum from a case of pneumonia. Stained with dilute carbol fuchsin and thoroughly washed.  $\times 1000$ .
- FIG. 4.—Anthrax bacilli. The lower portion of the field shows bamboo-like chains and spores, and is taken from cultures. Methylene blue.  $\times 1000$ . The portion showing spores is stained with carbol fuchsin, decolorized by brief immersion in methylated spirit, and counterstained in methylene blue.
- FIG. 5.—Pus showing streptococci. Stained by Gram's method, counterstained with eosin.  $\times 1000$ .
- FIG. 6.—Pus showing gonococci and staphylococci. Stained by Gram's method and counterstained with dilute carbol fuchsin.  $\times 1000$ .

PLATE I

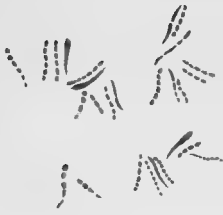

*Fig 1*



*Fig 2*

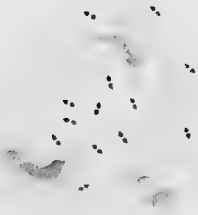

*Fig 3*

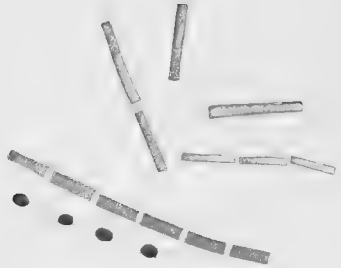

*Fig 4*



*Fig 5*

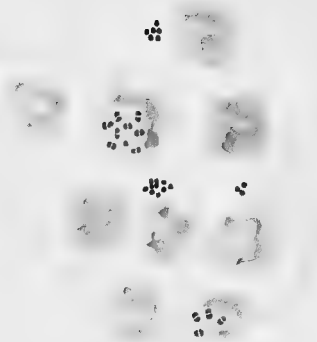

*Fig 6*





## DESCRIPTION OF PLATE II.

- FIG. 1.—Tetanus bacilli from a culture. Stained with dilute carbol fuchsin.  $\times 1000$ .
- FIG. 2.—Tubercle bacilli in sputum. Stained with carbol fuchsin and decolorized in dilute sulphuric acid; counter-stained with methylene blue.  $\times 1000$ .
- FIG. 3.—Influenza bacilli in sputum. Some are contained within a leucocyte. Löffler's blue.  $\times 1000$ .
- FIG. 4.—Plague bacilli from a culture. A short chain and some coccoid (involution) forms are shown. Löffler's blue.  $\times 1200$ .
- FIG. 5.—Vibrio of Asiatic cholera. Dilute carbol fuchsin.  $\times 1000$ .
- FIG. 6.—Small colony of actinomyces, as it appears in pus. No clubs are visible. Gram's method.  $\times 600$ .



PLATE II

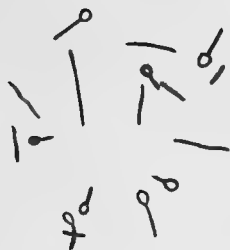

*Fig 1*

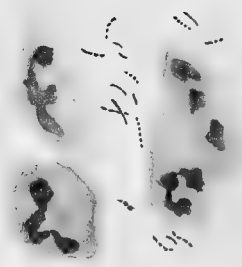

*Fig 2*



*Fig 3*



*Fig 4*



*Fig 5*

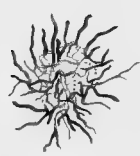

*Fig 6*





### DESCRIPTION OF PLATE III.

FIG. 1.—*Diplococcus meningitidis* in film, from cerebro-spinal fluid obtained by lumbar puncture in a case of cerebro-spinal fever.

FIG. 2.—Gonorrhœal pus, showing numerous polynuclear leucocytes, one of which contains gonococci; a part of a squamous cell also shown.

FIG. 3.—Pneumobacillus in pus from a case of conjunctivitis.

FIG. 4.—Pneumococci in sputum from a case of pneumonia.

FIG. 5.—*Micrococcus catarrhalis* in sputum from a case of bronchitis.

FIG. 6.—Staphylococci in old and degenerated pus.

This plate is to illustrate the main morphological differences between the chief pathogenic diplococci and organisms resembling them. All the films were stained by Gram and counterstained by carbol fuchsin. In Figs. 1, 2, 3, and 5 the organisms were coloured pink; in 4 and 6 they were violet. The figures are all drawn to the same scale.

PLATE III.

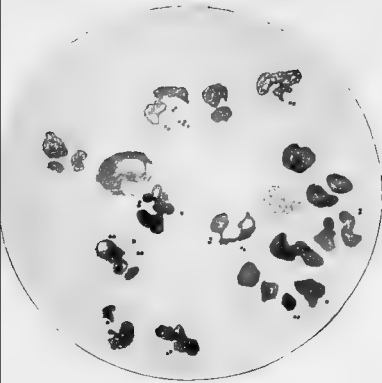

FIG. 1.

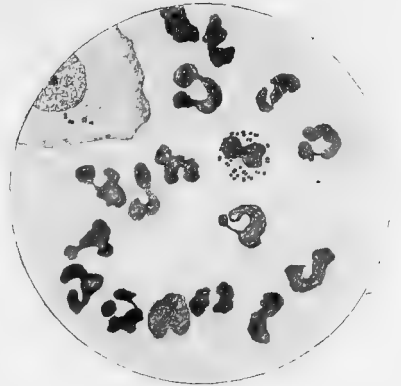

FIG. 2.

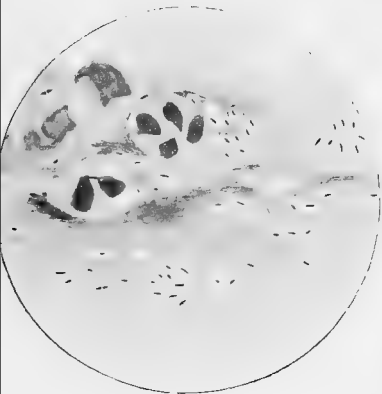

FIG. 3.

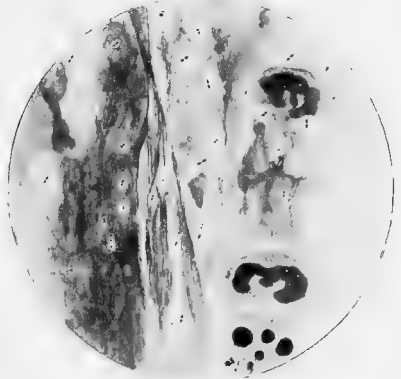
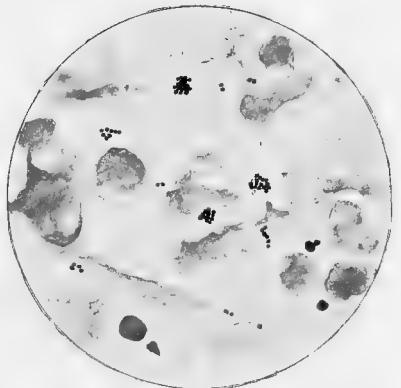

FIG. 4.







## DESCRIPTION OF PLATE IV.

- FIG. 1.—Streptothrix (actinomycosis) in pus. Many of the filaments are in short lengths, resembling bacilli. From a case of actinomycosis of the pleura. (Gram.)
- FIG. 2.—Film from the tonsillar exudate in Vincent's angina (carbol fuchsin), showing bacilli and spirilla.
- FIG. 3.—Morax-Axenfeld bacillus in pus from conjunctivitis (carbol thionin).
- FIG. 4.—*Microsporon furfur* in epidermic scale. Stained by method given on p. 96.
- FIG. 5.—Boas-Oppler bacillus, from the vomit in carcinoma ventriculi. (Gram.)
- FIG. 6.—Bottle bacillus (see p. 101). (Gram.)

(Photographs by Dr. A. Whitfield.)



PLATE IV

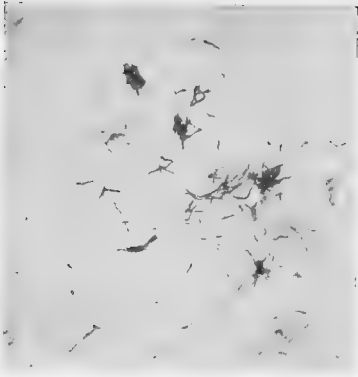

FIG. 1

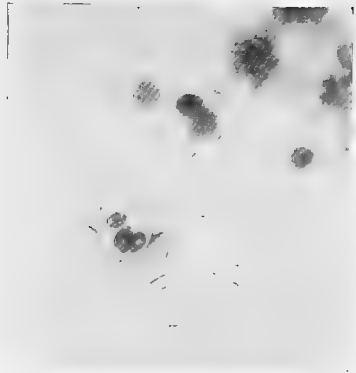

FIG. 2.

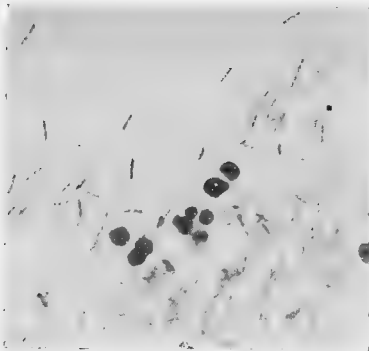

FIG. 3.

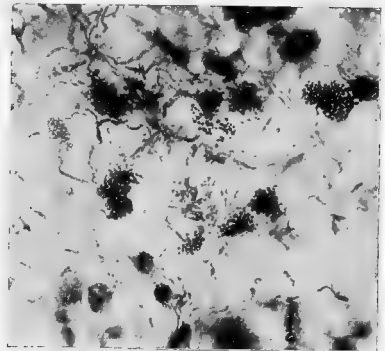

FIG. 4

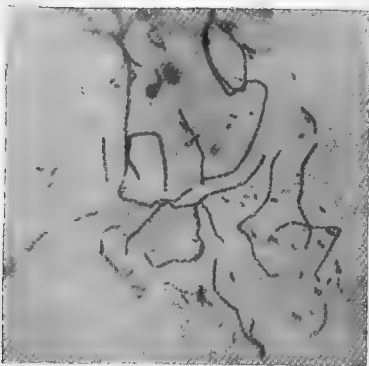

FIG. 5

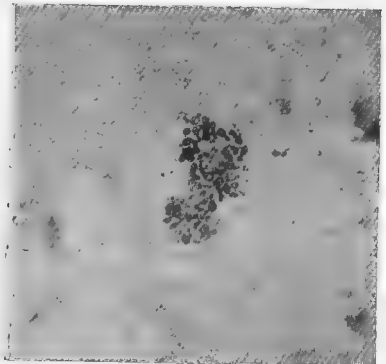

FIG. 6





#### DESCRIPTION OF PLATE V.

FIG. 1 shows *Spirochæta pallida* (in the centre) and *Spirochæta refringens* (to the left), under very high magnification.

FIG. 2 shows the same organisms under a  $\frac{1}{12}$ -inch oil-immersion.

(Lent by Professor Schaudinn.)

PLATE V.

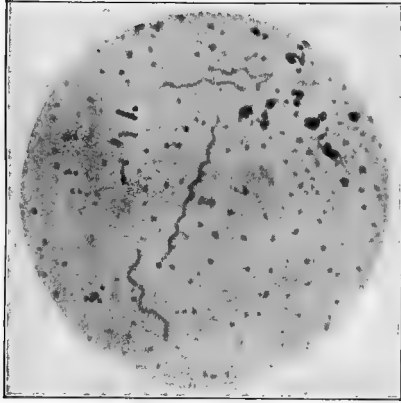

FIG. 1.

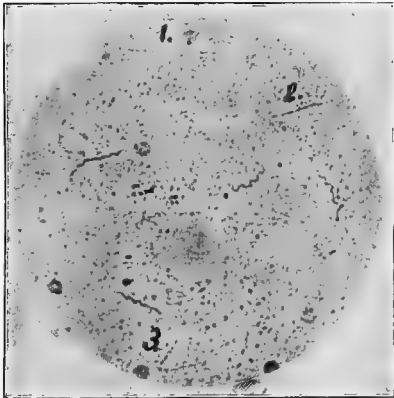

FIG. 2.





## DESCRIPTION OF PLATE VI.

FIG. 1.—*Megalosporon ectothrix* from beard region. Hair-root (below) showing some invasion. Root-sheath (above) with abundant mycelium.

FIG. 2.—*Megalosporon endothrix* in hair. Notice the intact cuticle. (Magnified less than Fig. 1.)

FIG. 3.—*Megalosporon endothrix* in nail.

FIG. 4.—*Microsporon Audouini* in hair. Spores outside hair partially removed to show mycelial elements within the hair.

FIG. 5.—*Favus* in hair.

Preparations all stained by the method given on p. 96.

(Prepared and photographed by Dr. Whitfield.)



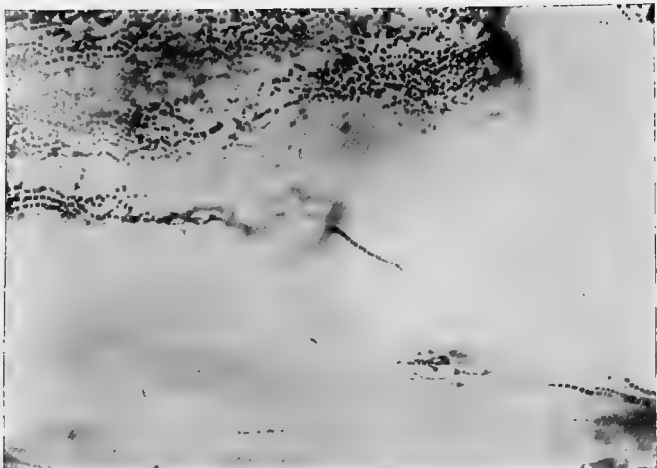

FIG. 1.



FIG. 2.

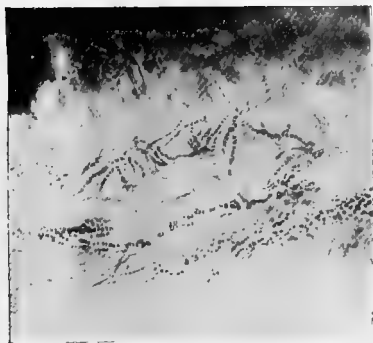

FIG. 3.



FIG. 4.







## DESCRIPTION OF PLATE VII.

FIGS. 1, 2.—Lymphocytes.

FIG. 3.—Lymphocyte practically devoid of protoplasm.

FIG. 4.—Large lymphocyte.

FIGS. 5, 6.—Large hyaline cells.

FIG. 7.—Polynuclear leucocytes.

FIG. 8.—Eosinophile leucocyte.

FIG. 9.—Mast cells (these are from normal blood).

FIGS. 10, 11.—Myelocytes.

FIG. 12.—Eosinophile myelocyte.

FIG. 13.—Large mast cell from a case of spleno-medullary leucocythæmia.

Stained by Jenner and drawn to scale, but relatively slightly larger than the corpuscles on Plate VIII.

PLATE VII



*Fig 1*



*Fig 2*



*Fig 3*

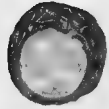

*Fig 4*



*Fig 5*



*Fig 6*



*Fig 7*



*Fig 8*

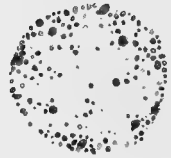

*Fig 9*



*Fig 10*

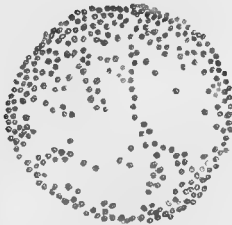

*Fig 12*



*Fig 13*

*Fig 11*





## DESCRIPTION OF PLATE VIII.

FIG. 1.—A normal red corpuscle.

FIG. 2.—Red corpuscle showing granular basophilia.

FIG. 3.—A red corpuscle showing polychromatophilia.

FIG. 4.—Microcyte.

FIG. 5.—Megalocyte.

FIG. 6.—Poikilocytes.

FIG. 7.—Normoblast.

FIG. 8.—Normoblast with dividing nucleus from a case of Von Jaksch's anæmia.

FIG. 9.—Normoblast with vesicular nucleus and polychromatophilic stroma, from foetal blood.

FIGS. 10, 11, 12.—Megaloblasts, the last showing polychromatophil degeneration.

Specimens stained by Jenner and drawn to scale, appearing about twice the size as when seen under a  $\frac{1}{12}$ -inch lens and IV. eyepiece (Leitz).



PLATE VIII



*Fig 1*



*Fig 2*



*Fig 3*



*Fig 4*

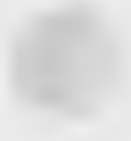

*Fig 5*



*Fig 6*



*Fig 7*



*Fig 8*



*Fig 9*

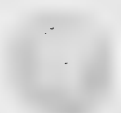

*Fig 10*



*Fig 11*



*Fig 12*

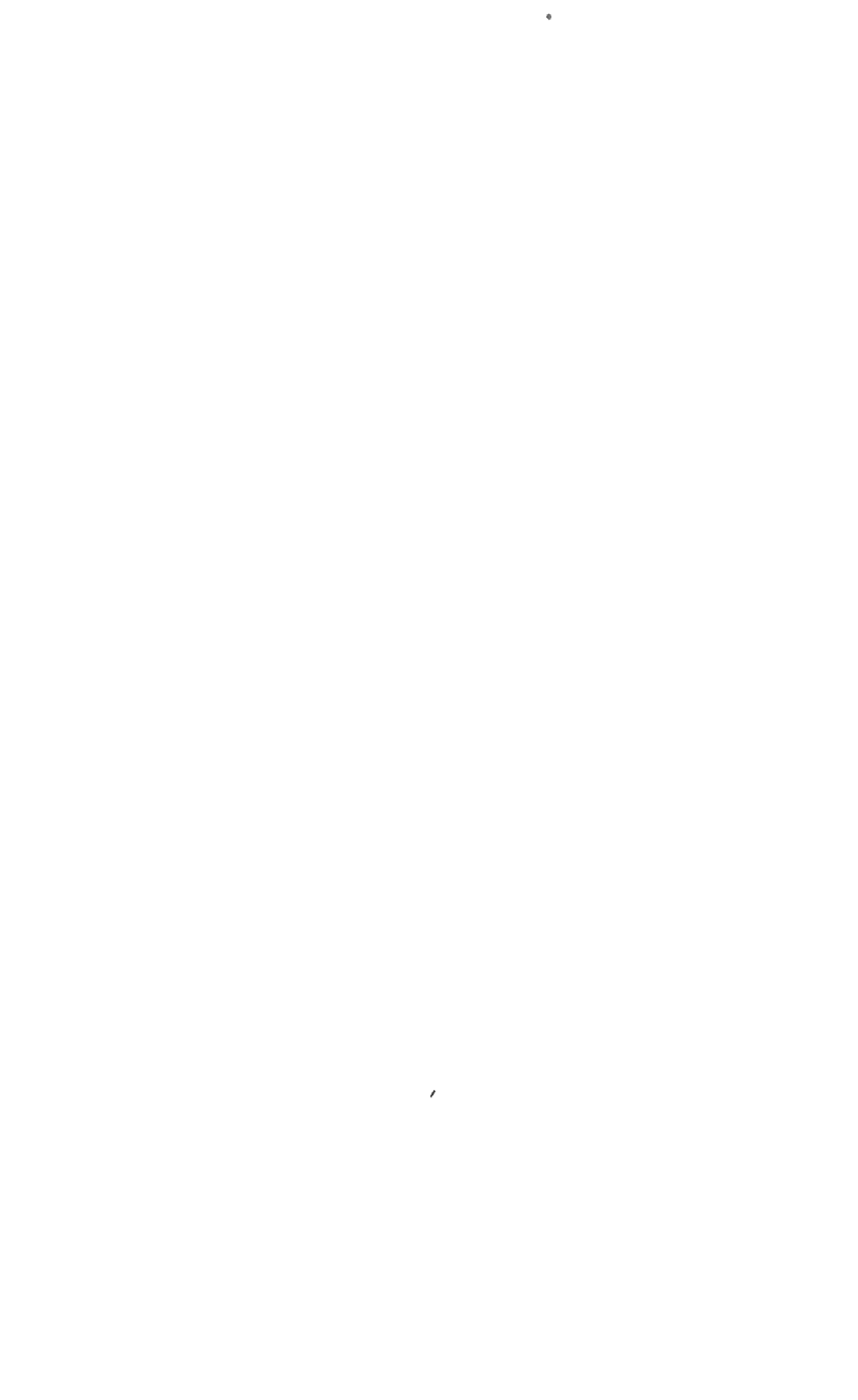



## DESCRIPTION OF PLATE IX.

FIG. 1.—Tuberculous pleurisy. Wet preparation stained with methylene blue, showing lymphocytes and red corpuscles. (The nucleoli are not usually so clearly shown, and are not seen in dried films without special staining.)

FIG. 2.—Pus from knee affected with gonococcal arthritis (early in the disease). The figure will serve to show the appearances in an early case of septic pleurisy or empyema. Polynuclear cells predominate, but there are a few lymphocytes. The large cells are endothelial, and have ingested some polynuclear leucocytes which show fragmentation of the nucleus. Film dried, fixed with perchloride of mercury, and stained with carbol thionin.

FIG. 3.—Pus from an old pneumococcic empyema. The cells are polynuclears, but are highly degenerated, and stain very feebly. Stained as in Fig. 2. (All magnified 1000 diameters.)

PLATE IX.

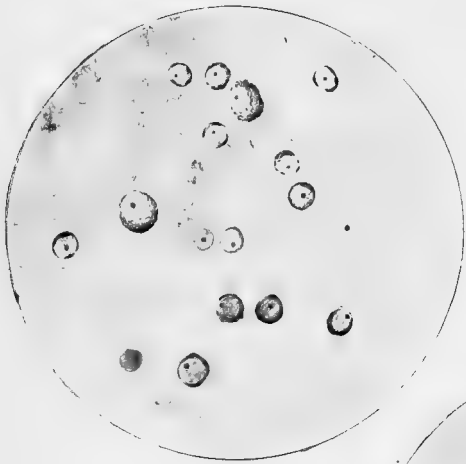

FIG. 1.

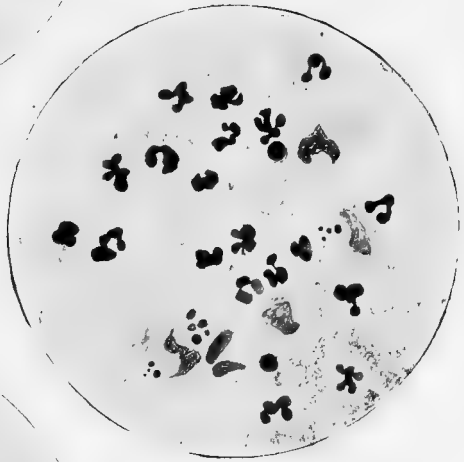

FIG. 2.

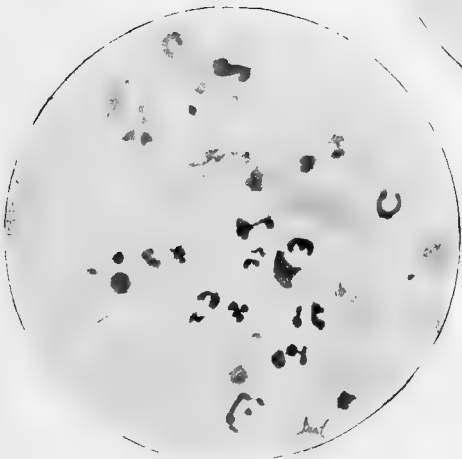

FIG. 3.





## DESCRIPTION OF PLATE X.

- FIG. 1.—Primary pleurisy, probably due to true rheumatism. Wet preparation stained with methylene blue. The large cells are “active” endothelial cells, many of which are crowded with large refractile granules. Notice the different degrees with which these cells have taken the stain. There are also some polynuclears, lymphocytes, and red blood-corpuscles.
- FIG. 2.—From a case of passive pleural effusion due to cardiac disease. (The appearances in that due to renal disease are identical.) Flat “passive” endothelial cells often grouped into large plates, some much larger than those shown. A few lymphocytes and red blood-corpuscles (the latter possibly from the puncture). Film stained with carbol thionin.
- FIG. 3.—Cells from a case of ascites due to malignant disease of the ovary. Huge endothelial cells, showing large clear vacuoles. There are numerous red corpuscles, one of which has been ingested by an endothelial cell. Carbol thionin (On same scale as Plate IX.)



PLATE X.

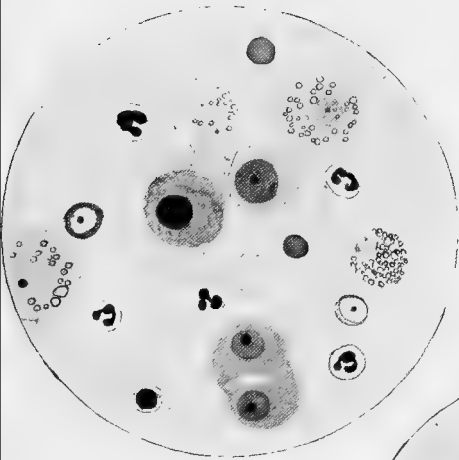

FIG. 1.

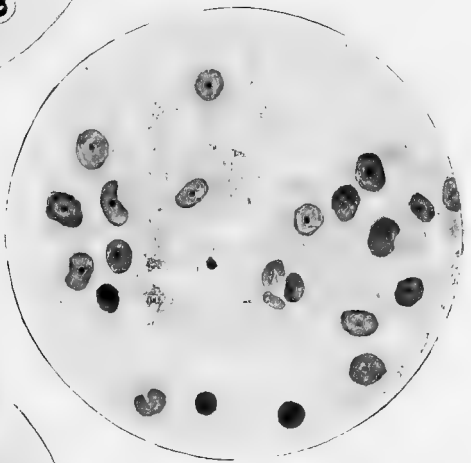

FIG. 2.

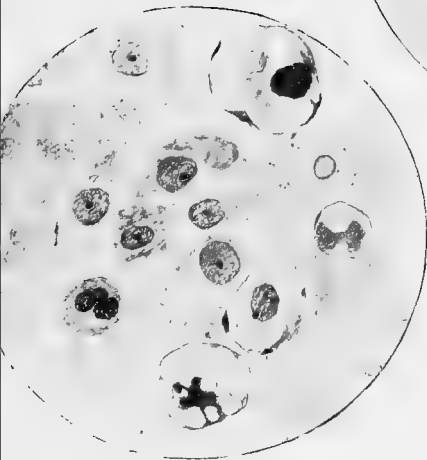
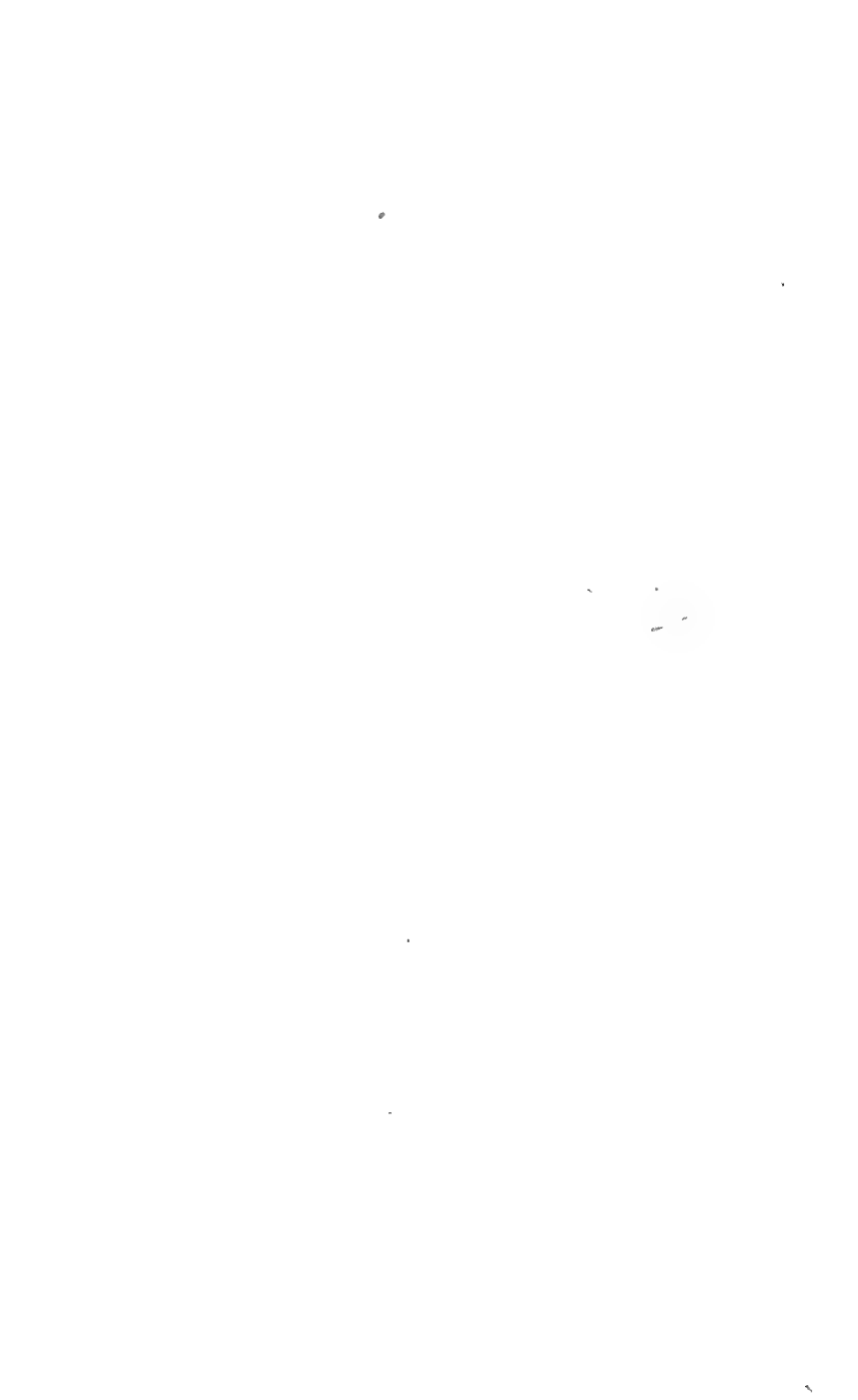

FIG. 3.



# CLINICAL BACTERIOLOGY AND HÆMATOLOGY

## PART I

### BACTERIOLOGY

#### SECTION I

#### APPARATUS AND PROCESSES

##### THE BACTERIOLOGICAL MICROSCOPE

THE essentials which a microscope must possess in order to render it available for bacteriological work are :

1. A *firm and rigid* stand and stage.
2. A firm, accurate, and delicate fine adjustment.

A microscope which possesses these may be made available for bacteriological work by the addition of the necessary parts, but one that is deficient in these respects is useless.

3. A convex and a flat mirror.
4. An Abbé's condenser and iris diaphragm.
5. Three lenses, a low power ( $\frac{1}{2}$  inch or, better,  $\frac{2}{3}$  inch), a high power ( $\frac{1}{8}$  inch or thereabouts), and a  $\frac{1}{12}$ -inch oil immersion.

If the practitioner already possesses a microscope made by a reliable firm, and in good condition, this should be sent to a maker (not necessarily the maker of the microscope in question) or to a bacteriologist for an opinion as to whether or no it is sufficiently firm, and has a fine adjustment good enough, to justify the addition of the other parts. If this is the case it should be fitted with an Abbé's condenser and an iris diaphragm; the cost should not exceed 30s. or £2. But it is useless to have this alteration made unless the stand is sufficiently steady to carry an oil-immersion

lens; and in most cases it is useless to think of having an inefficient fine adjustment altered for bacteriological use.

There are now many microscopes which are sold at a comparatively small price, and which will answer every purpose. Of these, Leitz's II*b*. stand, with the lenses above mentioned, a triple nose-piece (which is so great an advantage that it might almost be called an essential), and two eye-pieces, costs about £13, and may



FIG. 1.—BACTERIOLOGICAL MICROSCOPE.

be highly commended. The stand is very firm and strong, the fine adjustment delicate, and the lenses altogether admirable. The only objection to this microscope is that it is rather heavy; this is an advantage for laboratory work, but it is a disadvantage for a medical man, who may have to examine blood, etc., at the patient's bedside. Swift and Son manufacture a microscope of much the same type at about the same price; it has all the good points of the Leitz microscope and is somewhat lighter. The same firm

also supplies a portable instrument, the cost of which (without lenses) is £5. This is very ingeniously made, and will carry an oil-immersion lens quite well; it is perhaps the most suitable stand for a practitioner who may have to do work at a distance, for it packs into a very small compass and is not heavy. The same firm also make a microscope designed by Dr. Briscoe, which is even more portable, has a mechanical stage, and packs into a box in which all the requisites for blood-counts are carried. It is especially adapted for blood-work at the bedside.

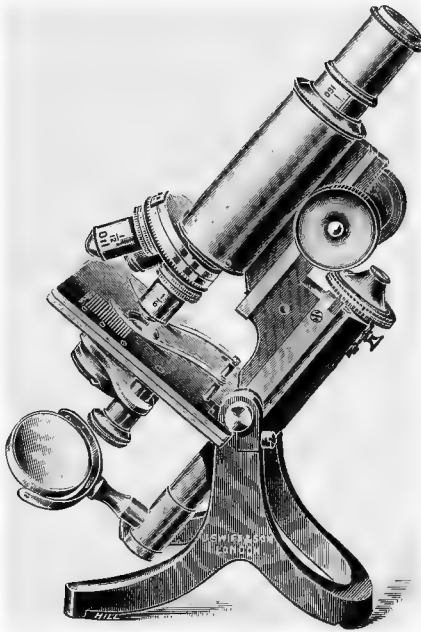

FIG. 2.—BACTERIOLOGICAL MICROSCOPE.

The cost of a  $\frac{1}{12}$ -inch oil-immersion lens is, roughly speaking, £5. Beck and Watson supply good lenses at £4.

The cost of the other lenses may be put down at 30s. or less apiece. Leitz's No. 3 (about  $\frac{2}{3}$  inch) costs 15s., and his No. 6 (about  $\frac{1}{8}$  inch) costs 30s.; these are both extremely well adapted for bacteriological work.

With regard to eye-pieces, it is an advantage to have two, a No. 2 and a No. 4. Higher powers may be used, but it must be remembered that any increased gain in magnification brought

about by the eye-piece is attended by a loss of definition. The same applies to the increased magnification obtained by pulling out the draw-tube.

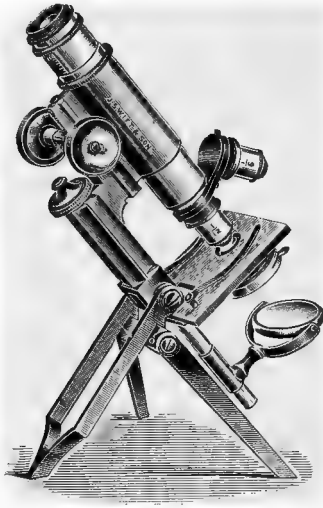

FIG. 3.—PORTABLE MICROSCOPE (SWIFT).

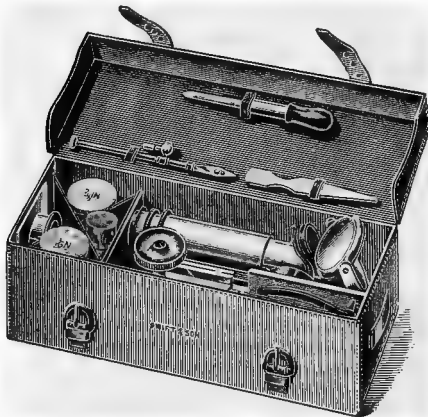

FIG. 4.—PORTABLE MICROSCOPE (SWIFT).

The total cost of a microscope may be put down at £15, and for this sum a thoroughly efficient instrument can be obtained, while one that will answer every purpose may be bought for

decidedly less. The cost of adapting a good stand will be about £6 10s. or £7 (30s. or £2 for the substage arrangement and £5 for the lens), or less if a cheaper oil-immersion lens is obtained.

A mechanical stage is a very great advantage in hæmatological work, since it enables a preparation to be moved regularly backward and forward and up and down, so that all parts of its surface may be examined systematically. A simple form is all that is required, the verniers being quite unnecessary for most purposes. It can be fitted to most stands. Leitz's can be specially recommended.

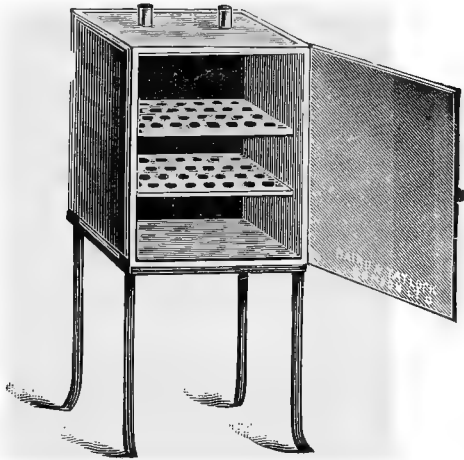

FIG. 5.—HOT-AIR STERILIZER: SIMPLE FORM.

It need scarcely be said that there are many admirable microscopes other than those mentioned above, which have simply been selected as favourable and low-priced instruments of English and Continental manufacture. Amongst others, the microscopes made by Beck, Ross, and Watson are all good, and reasonable in price.

### STERILIZATION OF APPARATUS, ETC.

*Requisites.*—1. A thermometer graduated to 200° C.

2. A hot-air sterilizer; *or* a cubical biscuit tin, the soldering of which has been replaced by brazing—this must be mounted upon a tripod stand; *or* a kitchen oven, preferably a gas oven.

3. A steam sterilizer ; or a large kitchen steamer—this should be deep enough to contain a litre flask holding a funnel.

4. A large Bunsen burner or spirit-lamp.

Bacteria and their spores are ubiquitous, and it is necessary to sterilize all vessels and other apparatus and all culture media before use. The methods which are adopted all depend upon the action of heat; chemical antiseptics are rarely used in the bacteriological laboratory for the sterilization of apparatus, for it would be difficult to remove them completely, and the traces which might remain would prevent the development of those germs which we

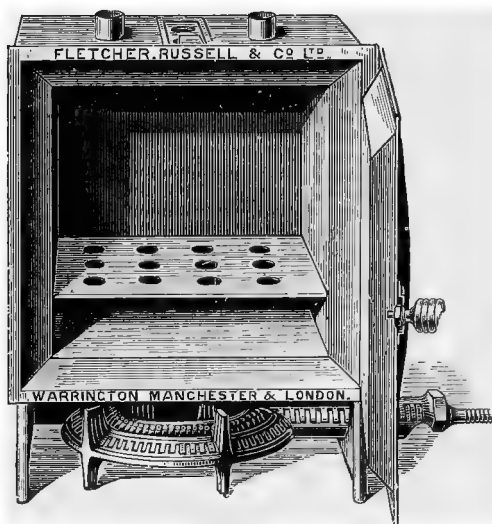

FIG. 6.—HOT-AIR STERILIZER.

wished to cultivate. Two chief methods are in use, sterilization by *dry heat* and by *steam*; we exclude sterilization by steam under pressure, as this requires special and expensive apparatus, and is never absolutely necessary, though often convenient.

DRY HEAT is used to sterilize all glass vessels (flasks, Petri dishes, test-tubes, pipettes, etc.), cotton-wool, and metal instruments. The heat must be continued for at least half an hour, and must not fall below  $150^{\circ}$  C. as indicated by the thermometer. Another method, which is less reliable than the use of the thermometer, but which may be resorted to in an emergency, is to wrap the apparatus loosely in cotton-wool, and to proceed with the



heating (allowing the temperature to rise *gradually*) until the outer part of the wool is slightly singed over the whole of the exposed surface.

The special sterilizer which is used in the bacteriological laboratory consists of a copper or iron oven with double walls and perforated metal shelves. There is a hole in the top, which is fitted with a perforated cork, through which the thermometer passes. The oven is mounted on a stand, and heated by means of a large Bunsen or Fletcher's burner.

An efficient sterilizer may be made out of a cubical biscuit box, but it will not stand much usage unless the joints are brazed instead of being soldered: this can be done by any tinsmith. It is much better to have the bottom of the box replaced by a sheet of copper, and a sterilizer made in this way will answer every purpose and be fairly durable. A circular hole is cut through the centre of the lid and fitted with a cork bored so as to admit the thermometer. A false bottom or a shelf an inch or so from the bottom will keep the articles which are being sterilized from the heated surface; the false bottom may be made from a sheet of tin 2 inches longer in two of the sides than the bottom of the box. The extremities of the shorter sides are to be turned down for a length of an inch, and several holes cut in the plate.

Lastly, the kitchen oven may be pressed into service if no other sterilizer is at hand in an emergency. The apparatus to be sterilized is to be placed on a layer of cotton-wool on one of the shelves, and the temperature is observed by means of the thermometer, which should be thrust through the little window which permits of the regulation of the temperature; or the heat may be continued until the cotton-wool is singed over the whole of the exposed surface. This method is very convenient for practitioners sending materials to a laboratory for bacteriological examination.

A gas oven is even more convenient, as the temperature can be regulated to a nicety.

All glass apparatus must be thoroughly cleansed and dried before sterilization. The remaining steps differ somewhat in the different cases.

*Flasks* are plugged lightly with cotton-wool before being placed in the sterilizer. *Bottles* may be sterilized in the same way; they may also be sterilized by boiling. *Test-tubes* are treated in

the same way as flasks. *Petri dishes* are wrapped round with tissue-paper or filter-paper before being sterilized.

Before removing glass apparatus from the sterilizer remember to let the temperature fall gradually, or the vessels may crack.

If a sterilized test-tube be required in a hurry (as often happens), plug a clean tube with cotton-wool, and hold it with forceps, one blade being inside and one outside the open end. Then heat every part of the tube thoroughly in the flame, taking care the heat is great enough to scorch the plug.

*Cotton-wool* is sterilized by being spread out in thin layers on the shelves of the apparatus, and the heat is continued until the outside is singed.

*Metal instruments* (knives, scissors, etc.) may be sterilized in the same way and at the same time. They should be wrapped loosely in cotton-wool, and should not be removed from their wrapping until the moment at which they are to be used.

STEAM is chiefly used for the sterilization of culture media before use, and for the destruction of cultures when they are done with. The latter purpose, however, is accomplished more speedily and safely by the addition of a few drops of commercial formalin to each tube, or the tubes may be filled with 1 in 20 carbolic, which, however, cannot be relied on to kill spores.

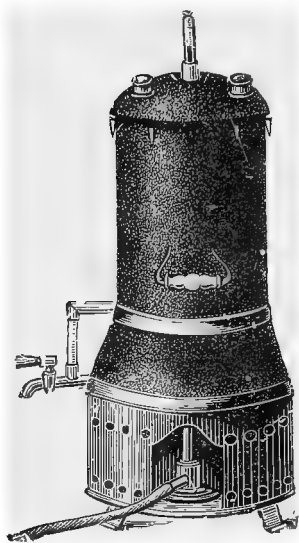

FIG. 7.—STEAM STERILIZER.

The proper steam sterilizer consists of a metal cylinder with a perforated diaphragm 6 or 8 inches from the bottom. It is enclosed in a thick layer of felt or other non-conductor of heat, and is provided with a lid. The space between the bottom and the diaphragm is partly filled with water, which is boiled by means of a Bunsen flame or Fletcher's burner, the apparatus to be sterilized being placed in the chamber above so as to be exposed to the steam.

An ordinary steamer (such as is used for cooking potatoes or fish) will answer every purpose. In procuring such a steamer

for bacteriological use it is best to choose one that will accommodate a litre flask holding a funnel, as it is often a great convenience in the filtration of fluids which become solid on cooling to carry out the process in an atmosphere of steam.

Exact details of the way it is used will be given subsequently.

## PREPARATION OF CULTURE MEDIA

Bacteria are grown in the same way as other plants. A gardener who wishes to grow a plot of a particular plant will first prepare a soil suitable for the growth of that plant, and free it as far as possible of all seeds, roots, etc. He will then sow it with the seeds of the plant in question, and do what he can to expose them to a suitable temperature. An exactly similar process is adopted when we wish to cultivate the smallest of all plants. The soil which we prepare is called the culture medium, and differs in the case of different bacteria; the process of freeing this soil from bacteria and their spores is called sterilization, and we insure a suitable temperature by means of an incubator, the heat of which is kept constant.

The culture media which are used for special purposes are almost innumerable, but in the daily routine of the laboratory and for diagnostic purposes, broth, gelatin, agar-agar, and blood-serum, are all that are really necessary in the vast majority of cases. These media may all be bought from any firm of manufacturing chemists, or from any bacteriological laboratory; and their purchase saves a great deal of work, and is to be recommended for those who only wish to use them occasionally. They are sold in test-tubes, which are kept sterile by being plugged fairly firmly with cotton-wool; this substance prevents the passage of bacteria as long as it is kept dry. The tubes are best stored in jars provided with tightly fitting lids, and it is an advantage to place a shallow layer of a solution of perchloride of mercury (or other *non-volatile* antiseptic) in the bottom of each jar to prevent the medium from drying up. It is scarcely necessary to add that not the smallest trace of the lotion should be allowed to come into contact with the cotton-wool plug of the tubes. Or the medium may be kept from drying up by covering the tubes with indiarubber caps sold for the purpose.

BROTH is very easily made, and, as it is the foundation of many other media, the practitioner is strongly advised to prepare it for himself.

*Requisites.*—1. Liebig's Extract of Meat.

2. Peptone.

3. Common salt.

4. A dilute solution of sodium carbonate—about 1 per cent., but the exact strength does not matter.

5. A large flask, a stirring-rod, and a large glass funnel.

6. Test-tubes and cotton-wool plugs. The exact size of the tubes is unimportant, but 6 inches by  $\frac{3}{4}$  inch is convenient. The plugs are best prepared from wool which has been previously sterilized by dry heat, and should be fairly firm. The tube, with the plug *in situ*, must be sterilized by dry heat ready for use.

7. Litmus-paper.

*Method.*—Take 1 litre of tap-water in the flask, and add 5 grammes of Liebig's Extract, 10 grammes of peptone, and 5 grammes of common salt, and boil until all are dissolved. Test the reaction by withdrawing a drop of the fluid on the stirring-rod and applying it to a piece of litmus-paper. You will probably find that it is slightly acid. Now add some of the solution of soda, drop by drop, testing after each addition, until the reaction of the fluid is slightly alkaline.\* Boil the fluid for half an hour, to coagulate any albumin which may be present.

Next filter the broth into a sterile flask, passing it through a double thickness of white filter or blotting paper, and plug the flask firmly with sterilized cotton-wool.

If the broth is to be used for the manufacture of gelatin or agar, it is next sterilized in the flask; while if it is to be used as it is as a culture medium, it is decanted into tubes and then sterilized.

In decanting media into tubes be very careful not to get the plug wet, and not to let any of the medium get on to the upper part of the tube; otherwise the plug will stick to the tube, and there will be some danger of bacteria from the air "growing through" the fluid contained in the interstices of the plug and contaminating the culture. Ordinary non-absorbent (brown) wool

\* If during the neutralizing process too much alkali is added, then it is necessary to reacidify with dilute hydrochloric acid and reneutralize. The sodium chloride formed makes no *practical* difference in the medium.

is better than the white absorbent wool, as it is less easily wetted.

The broth (and other culture medium after being melted) may be poured into the tubes in the following way : A sterilized funnel is united by a short length of indiarubber tubing to a piece of glass tubing drawn out to a point ; the rubber tube is clipped by a spring clip or a pair of pressure forceps. The funnel is now mounted on a retort-stand, filled with the medium, and covered over with a piece of glass. The cotton-wool plug is removed from a test-tube, and the latter placed so that the glass tube attached to the funnel reaches nearly to the bottom. The clip is released, and the requisite quantity of broth (enough to fill the tube to the depth of  $1\frac{1}{2}$  or 2 inches) is allowed to run in ; the clip is then reapplied and the tube removed and plugged. This process is repeated until enough tubes have been filled.

The tubes and the broth which remains over (after having been poured back into the flask and the latter plugged with cotton-wool) are now sterilized. The vessels are placed in the steam sterilizer and exposed to steam for half an hour on *three successive days* ; this process is called intermittent sterilization, and its rationale is very simple. The first steaming destroys all developed bacteria, and would sterilize the fluid entirely if no spores were present. In the interval between the first and second sterilization most of the spores which may be present will develop into mature bacteria, and these will be killed by the second steaming. The third sterilization is to kill off any bacteria which may not have developed from spores in the first interval. A very similar process is adopted by the gardener in freeing soil from weeds ; the application of chemical weed-destroyers or a thorough hoeing will destroy developed plants, but will not injure seeds which may be contained in the soil, and these processes are repeated, intervals being allowed to permit the development of the plants, until they reach the stage in which they are vulnerable.

To recapitulate : Mix the ingredients, and heat until they are dissolved, render slightly alkaline, boil half an hour, filter. Then place in sterilized flask or into test-tubes, and sterilize in the steam sterilizer for half an hour on three successive days.

NUTRIENT GELATIN is broth which has been solidified by the addition of from 10 to 15 per cent. of gelatin ; the former amount is used in the winter, the latter in the summer. For general purposes  $12\frac{1}{2}$  per cent. may be used in all cases.

The special advantages of gelatin as a culture medium are two-fold. In the first place, a great many organisms grow in or on it in a characteristic way, so that a bacteriologist may be able to identify the organism by inspection of the culture. This arises partly from the fact that some bacteria produce a ferment which digests gelatin just as pepsin does; these bacteria "liquefy" the gelatin, and the distinction between the bacteria which have and those which have not this property is very important for purposes of diagnosis. Further, some bacteria liquefy rapidly and others slowly, and this is another important point in the identification of a germ.

In the second place, the gelatin medium may be melted at a temperature (about 25° C.) at which bacteria are not killed. This fact is made use of in the isolation of bacteria from a fluid which contains several species by the process known as "plating." Suppose, for instance, that we find by microscopic examination that a specimen of pus contains two different species of bacteria (perhaps a bacillus and a coccus), and we wish to obtain the two organisms in pure culture so that we can ascertain their nature and properties. We take a tube of gelatin and melt it by placing it in warm water, and then inoculate the medium with a minute quantity of the pus. We then shake it so as to distribute the organisms throughout the melted fluid, and then pour the latter into a flat dish (Petri's plate), so that the gelatin flows out into a thin film and then sets. If our dilution has been properly made, we shall have separated each organism from its neighbours, and each separate germ will grow up into a "colony," which will soon be visible to the naked eye. In all probability we shall be able to see that these colonies are of two kinds: one may liquefy and the other not, one may be coloured and the other colourless, one may be round and the other angular, etc. Samples of each sort of colony are then transplanted to fresh culture-tubes, and again incubated. An example of this process is given on p. 58.

A slight modification of this process enables us to make an estimate of the number of living bacteria which is present in a given fluid. To do this we have to follow out the above process, adding a *definite* measured quantity of the fluid to the culture-tube of liquefied gelatin. The number of colonies which develop is counted, and this gives us the number of bacteria in the sample of fluid. For example, if  $\frac{1}{10}$  c.c. diffused throughout a tube of

melted gelatin and poured out into a thin film produced twenty colonies, it follows that 1 c.c. of the fluid contained 200 bacteria. This is a brief description of the essentials of the method adopted in the quantitative examination of water and other fluids.

*Requisites for the Manufacture of Gelatin.*—1. Broth.

2. Gelatin. (Coignet's gold label gelatin is best, but any good brand will do.)

3. Dilute solution of sodium carbonate.

4. Litmus-papers.

5. Flasks, stirring-rod, funnel, and plugged test-tubes as for broth.

*Method.*—Measure the broth and add to it  $12\frac{1}{2}$  grammes of gelatin for each 100 c.c.; allow to soak for an hour or more, and then heat until the gelatin is dissolved. Continue the heat, and render the medium faintly alkaline, just as was done in the preparation of broth. Now filter through a moistened filter-paper. To avoid the setting of the gelatin during the filtration, it is best to use a double-jacketed funnel containing hot water, but if this is not at hand the whole apparatus (flask and funnel) may be placed in the steam sterilizer (the lid being kept off to avoid the drops of condensed water which might otherwise fall into the funnel) or in a *warm* (but not hot) oven, and left at a temperature of about  $40^{\circ}$  C., until the process is complete.

The gelatin which is made by the above process is sufficiently clear for most purposes. A more slightly medium may be made by clarification of the above by white of egg. To the medium (after neutralization, but before filtration) add the white of one egg for each 250 or 300 c.c. of fluid, and shake thoroughly. Now boil in the steamer for half an hour, and filter as before.

Test-tubes are filled with gelatin just in the same way as with broth, and the process must be carried out quickly to avoid solidification of the medium. Some of the test-tubes are allowed to cool in the vertical position, others lying in a sloping position, so that the upper surface of the gelatin forms an ellipse some 3 inches long. The former tubes are inoculated by driving a straight platinum needle charged with the material containing the bacteria into the gelatin in the axis of the tube; cultures made in this way are called "stab cultures." The gelatin "slopes" are inoculated by drawing the charged needle along the surface of the medium, care being taken not to plough it up; cultures made in this way are called "stroke cultures."

AGAR, or AGAR-AGAR, is the name given to the dried strips of a Japanese seaweed. It forms a jelly which differs from that containing gelatin in that it melts at a higher temperature; nutrient agar, as used in the laboratory, melts just below the boiling-point of water and sets at about  $40^{\circ}$  C. This is an advantage in the cultivation of most pathogenic bacteria, for these grow (as a rule) best at or near the temperature of the body, the temperature to which they are exposed under natural circumstances; and at this temperature gelatin would melt. Agar is somewhat difficult to prepare unless the practitioner has an autoclave, and may be bought with advantage. But the following method is not very difficult, and, as agar is perhaps the most generally useful of all media, should be learnt.

*Requisites.*—1. Broth.

2. Agar-agar. This should be cut up into very small pieces with a pair of scissors, or may be bought in powder.

3. Solution of acetic acid (glacial acetic acid, 2 to 4 c.c.; water, 500 c.c.).

4. A large beaker.

5. Other apparatus and materials as for gelatin.

*Method.*—Weigh out 2 grammes of agar for each 100 c.c. of broth to be used, and soak it in the dilute acetic acid for a quarter of an hour. Now strain off the acid and wash the agar in water until a small piece does not redden blue litmus-paper when pressed upon it. Place the broth in a glass beaker and add the agar. Now place the beaker upon a piece of wire gauze on a tripod stand, and apply a *small* Bunsen flame or spirit-lamp; this must be placed so that the flame impinges on a point not far from the side of the beaker. As the fluid is heated it will rise, and a continual circulation will take place, so that the fragments will not stick to the bottom and cause it to crack. When all is dissolved, the hot liquid must be carefully neutralized. It is then allowed to cool to about  $50^{\circ}$  C., and the white of an egg added for each 500 c.c. of fluid and mixed in thoroughly by being stirred with a glass rod. The whole is then placed in the steamer for an hour, at the end of which time the albumin should be completely coagulated. The beaker and its contents are then allowed to cool gradually, so that the coagulum (retaining all solid particles) may settle to the bottom before coagulation is complete. Perhaps the best method of accomplishing this is to place it in the oven (taking care that the temperature does not exceed  $100^{\circ}$  C.) after



the fire has been raked out at night. In the morning the mass will be found to have solidified, and there will be a coagulum at the bottom. The beaker is then inverted and the mass "turned out" just as a cook turns out a jelly, and the sediment is cut off with a sharp knife. This avoids filtration, which is very troublesome.

An alternative method is to filter the melted jelly through moistened filter-paper. It is necessary to keep flask and funnel in a steamer (the water of which is kept boiling vigorously) during the whole process, or the jelly will solidify in the outflow tube of the funnel. Or it may be filtered through a double thickness of ordinary surgical lint (non-medicated). It runs through this very quickly, and the funnel need not be kept hot. The resulting medium is not absolutely clear, but sufficiently so for most purposes.

The agar is again melted and placed in test-tubes; these are sterilized on three successive days and allowed to set in a sloping position. For certain purposes glucose, glycerin, etc., are added to the agar. The addition should be made to the melted medium just before it is poured into the tubes.

SOLIDIFIED BLOOD-SERUM is very difficult to prepare, and is best purchased ready for use from a good laboratory. It is used chiefly in the diagnosis of diphtheria by the examination of "swabs" from the throat.

POTATO tubes are in occasional use, and are easy to prepare. The process is as follows: Take large and sound potatoes and scrub them thoroughly with a nail-brush under the tap. Peel them deeply enough to remove the eyes completely. Then cut them into cylinders a little less than  $\frac{3}{4}$  inch in diameter (if you are using  $\frac{3}{4}$ -inch test-tubes) and as long as possible; this is best done by means of a cork-borer, but they may be shaped by means of a knife if this is not at hand. Then cut each cylinder in half by a cut running obliquely from end to end; the shape of each half should be exactly like that of the medium in a sloped gelatin tube. Place the halves in a large vessel of tap-water and allow them to soak all night; it is a good plan to use running water if possible.

After this has been done place each half (base downwards) in a test-tube, having previously inserted a small mass of absorbent cotton-wool and enough water to saturate it. Plug the mouth of the tube with cotton-wool and sterilize on three successive days.

## INOCULATION OF CULTURE MEDIA

The method in which this is done varies greatly according to the end in view, and variations of the process now to be described will be mentioned under their appropriate headings. We will suppose that we have to examine a specimen of pus, and wish to make a stroke culture on agar and a stab culture in gelatin. The following must be at hand :

1. The pus.
2. A sloped agar tube and a stab gelatin tube.
3. A Bunsen burner or a spirit-lamp with a tall flame.
4. A pair of dissecting forceps.
5. Platinum needles. Each needle consists of a piece of platinum wire about 3 inches long mounted in the axis of a glass

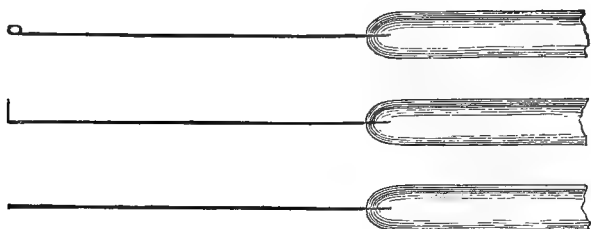

FIG. 8.—PLATINUM NEEDLES.

rod about 6 or 8 inches in length. The wire should be just thick enough not to bend too easily. They are easily prepared. The rod is selected, and the length of platinum wire is held in an ordinary pair of forceps. The end of the glass rod is held in the flame until quite soft; the end of the wire is then heated to redness, and pushed into the rod to the depth of about  $\frac{1}{4}$  inch, taking care that it is kept in the axis. The whole is allowed to cool, and is ready for use.

For some purposes we use needles which terminate in a small loop, so that they will retain a drop of fluid. These are prepared in the same way as the straight needles, the free end of the wire being subsequently twisted round a French nail or other suitable object.

The method is as follows :

1. Hold the culture-tube you are going to inoculate first between the index and middle fingers of the left hand, pointing the mouth

of the tube slightly downwards (so that no dust shall drop into it) and to the right. Tubes of solid media should always be held in this position during inoculation; tubes of liquid media are held in a similar way, but of course their mouths must point upwards.

2. Put the projecting portion of the cotton-wool plug of the test-tube into the flame so as to singe it; this is to destroy any germs which may have been deposited upon it from the atmosphere.

3. Sterilize the points of the forceps by passing them slowly through the flame, and then use them to remove the plug. Place this between the ring and little fingers of the left hand, and put the forceps down.

4. Take the platinum needle in the right hand, heat the whole of the wire to redness, and pass the lower 3 or 4 inches of

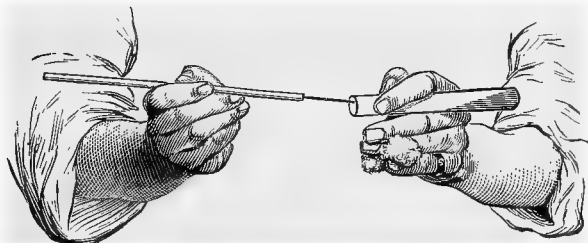

FIG. 9.

the glass rod slowly through the flame. Remember that every portion of the needle which goes inside the tube must be sterilized in this way. Allow the needle to cool; you should have found out how long this will take by a previous experiment.

5. Dip the tip of the needle into the pus; pass it into the tube until it reaches nearly to the bottom of the tube (now uppermost), and allow it to rest upon the sloping surface of the medium; now withdraw it gently, allowing the tip of the wire to trail gently along the whole length of the sloped surface. Do not touch the medium with the glass shoulder of the needle.

6. Sterilize the needle as before. This step must never be forgotten.

7. Take the cotton-wool plug in the forceps, put it in the flame, and singe all parts of its surface. Then plug the tube while the wool is still burning. Label it.

To make a stab culture take the other gelatin tube and proceed as before until you get to step 5. When you have passed the

needle into the tube drive it steadily into the medium, taking care not to deviate from the axis of the tube. Finish the process as before.

All this may seem involved. As a matter of fact it is very simple, and need not take more than a minute to perform. But every step must be carried out, and the whole process must be learnt so thoroughly that it is performed automatically whenever a culture is made.

### INCUBATION OF CULTURES

The limits between which bacteria can *live* are very wide; some *grow* best at one temperature, others at another, the limits for the great majority of organisms being about 16° C. and 40° C. In practice two temperatures are all that is used for ordinary work. The lower, or so-called "room temperature," is about 20° C. (68° F.), and is of most use for those bacteria which grow naturally outside the body—*i.e.*, as saprophytes. The higher, or body temperature, is about 37° C. (98.6 F.), and is the best temperature for the majority of germs which live within the body—*i.e.*, the parasites. It is obvious that gelatin cannot be incubated at this high temperature, as it melts at 25° C. or thereabouts; but all other media are available.

The term "room temperature" must not mislead the practitioner, for the temperature of many rooms is not constant at or near 20° C. for periods sufficiently long to permit of its use for incubating bacteria. In the laboratory we use an incubator, the temperature of which is regulated by means of an automatic regulator, and remains constant for long periods whatever be the external temperature. It is hardly necessary for the practitioner to purchase one of these. Careful search in the house will usually reveal some cupboard or corner in which the temperature will remain sufficiently near 20° C. for a sufficiently long period; it is more important that it should not rise above 22° C. than that it should not fall below 18° C., as the former temperature may melt the gelatin, while the latter will only delay the growth of the colonies. It will probably be necessary to find one such place in the hot weather (*e.g.*, the cellar) and another one in the winter (*e.g.*, a cupboard not far from the hot-water pipes).

It is necessary that cultures which are being incubated should

be kept *in the dark*, as light is inimical to the development of nearly all bacteria.

Incubation at the body temperature presents more difficulty. An incubator is almost essential when much work has to be done, and of these Hearson's is by far the best. The smallest size costs about £6 10s., and is a thoroughly reliable and durable affair. Cheaper instruments are also procurable: the "Edinburgh" incubator (Alex. Fraser, 22, Teviot Place, Edinburgh) costs about

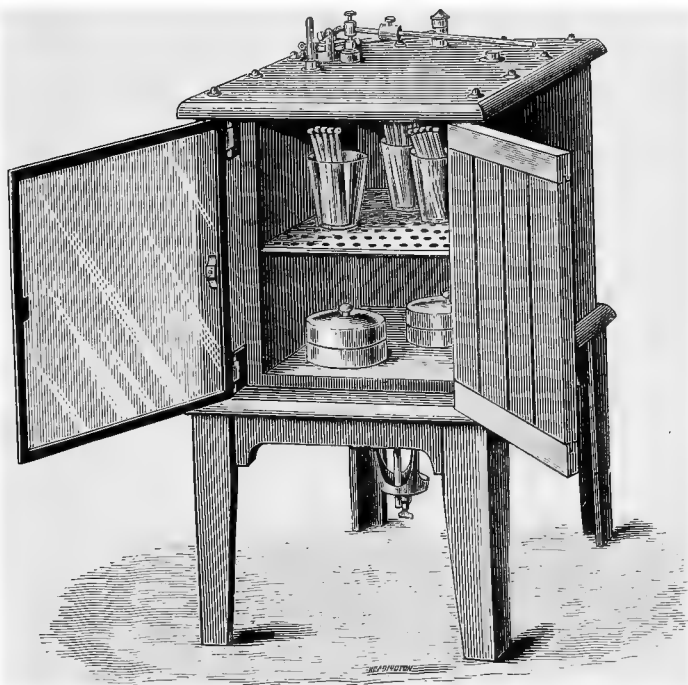

FIG. 10.—INCUBATOR.

£4 10s. complete. Foreign incubators can be obtained at an even lower price, but are not very durable.

Much can be done without the use of so expensive an apparatus if the practitioner can find a room in which the temperature keeps approximately constant throughout the twenty-four hours. A tin biscuit box (or any other metal box) is covered with cotton-wool on the top and sides, the bottom being left bare, and mounted on a tripod stand. It is heated by means of an ordinary night-light

(two may be necessary if the weather is cold) shielded from draughts by means of a wide lamp-chimney or a tin cylinder made out of an ordinary canister. The temperature is observed by means of a thermometer projecting through a hole in the lid, and the night-light raised or lowered until the temperature reaches the desired figure. The whole apparatus should be placed on a

metal tray containing a small quantity of water, and put in the middle of the floor, and away from any inflammable materials. This will be found to answer admirably, and can easily be fitted up in an emergency.

It would be better to use a tin box specially made for the purpose, and having a door at the side and a perforated false bottom, so that the culture-tubes do not rest directly on the metal exposed to the flame. This latter had best be made of copper.

Dr. Bottomley, of Boscombe, informs me that he has used the simple apparatus shown in Fig. 11 for five years, and finds it answers admirably in the diagnosis of diphtheria, etc.

It is an ordinary square vaseline tin, into the round opening of which is put a cylindrical coffee tin. The outer tin is filled with water, and a thermometer is put into a hole through its lid. The culture-tubes are placed in the inner tin, and the apparatus is heated by a paraffin lamp.

If the practitioner is fortunate enough to possess a conservatory which is kept at a temperature approximating to that of the body, this will serve admirably. The culture-tubes must be kept in a box which will exclude light.

In the absence of this a cupboard near the kitchen fire or the hot-water cistern may be found that will answer the purpose; a thermometer should be placed in it, and examined from time to time throughout the day, and if the temperature does not fall below  $30^{\circ}$  nor rise above  $40^{\circ}$ , it will serve at a pinch, though a temperature which is more constant near  $37^{\circ}$  is desirable. It has to be remembered that we are not now speaking of the incubation of cultures for purposes of research; we are dealing with methods of cultivation which are necessary for diagnostic purposes, and for these it is usually sufficient if the temperature remains nearly constant at the proper point for some eighteen hours.

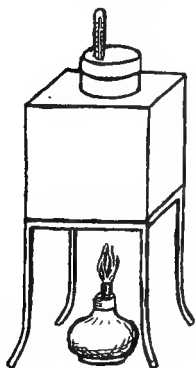

FIG. 11.

Another method I have recently adopted is to use a "Thermos" flask, or, what comes to the same thing, a Dewar's liquid air flask. This is nearly filled with water at a temperature of about  $40^{\circ}$  C. and the culture-tube inserted. If a Thermos is used the cap is then applied, if a Dewar's flask a few drops of oil are placed on the surface of the water (to prevent evaporation, which greatly hastens the process of cooling). The water and culture-tube cool very gradually, and most pathogenic organisms will give an excellent growth before this happens. The Dewar's flask should have a capacity of 600 c.c. and an internal diameter at the neck of 1 inch or so. It can be supported on a jam-pot with a layer of cotton-wool round the neck. I find it cools at the rate of about half or two-thirds of a degree per hour.

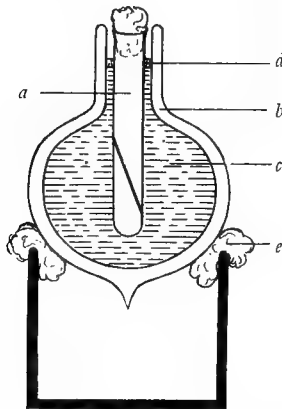

FIG. 12.—DEWAR'S FLASK ADAPTED FOR USE AS INCUBATOR.

*a*, Culture tube; *b*, vacuum; *c*, water; *d*, layer of oil; *e*, cotton-wool round mouth of jar for support.

The author once succeeded in making a diagnosis in a case of supposed diphtheria by the following method: The tube of medium was inoculated from the throat, and placed in a jam-pot which was partly filled with water at  $37^{\circ}$  C.; a thermometer was also inserted, and the whole placed near the fire. It was watched from time to time, and moved near the fire if the temperature showed signs of falling, and *vice versa*, until the proper position was found. Next morning there was an excellent growth, and the diagnosis was made with certainty.

Lastly, the author has heard of a practitioner who was in the

habit of incubating cultures at the body temperature by carrying them in an inner pocket during the day, and taking them to bed with him at night!\*

## METHOD OF EXAMINING CULTURES

*Requisites.*—1. Clean slides and cover-glasses. (These must be the thinnest in ordinary use—*i.e.*, No. 1.)

2. A platinum needle (straight or loop).

3. A Bunsen burner or a spirit-lamp with a tall flame.

4. The stain to be employed (see p. 28).

5. Canada balsam dissolved in xylol. This should be bought ready for use.

6. A pair of dissecting forceps.

7. Strips of white blotting or filter paper.

*Process.*—1. Sterilize the needle, and place a *small* drop of water (preferably distilled) in the centre of a clean slide.

2. Take the culture-tube in the left hand between the index and middle fingers with its mouth directed to the right and (in the case of a culture on a solid medium) slightly downward.

3. Burn the surface of the plug in the flame. Remove the plug with the forceps (previously sterilized by being passed slowly through the flame), and place it between the ring and little fingers of the left hand. Lay the forceps down.

In cases where you are examining the culture for diagnostic purposes only, and do not care if it becomes contaminated during the process, it is unnecessary to take these precautions. The cotton-wool plug may then be removed with the fingers and laid down on the table. As a matter of fact, very few cultures do become contaminated, even if no precautions are taken.

4. Sterilize the needle in the flame and allow it to cool.

5. Now introduce the needle into the tube, and take up a *small* portion of the growth, taking care not to scrape up the surface of the medium as you do so. Most beginners fall into the mistake of taking up far too much of the growth, and preparing a film which is spread so thickly that the individual bacteria cannot be distinguished.

6. Take the plug up in the forceps, burn its surface in the flame, re-plug the tube and lay it down.

\* Since the above was written an incubator to be used in this way has been invented.



7. Stir the droplet of water which has been deposited on the slide with the tip of the needle, so that the bacteria which it carries are mixed with the water. Now spread out the emulsion thus produced so as to form a patch about  $\frac{1}{2}$  inch in diameter. If it does not spread out uniformly it is a sign that the slide is not clean.

8. Sterilize your needle.

9. Allow the film to dry spontaneously. If you have spread it out sufficiently this will take a very short time.

10. Fix the film by passing the slide slowly through the flame once or twice. This coagulates the albumin present, and the bacteria are now fixed down so firmly that they will not be removed by subsequent washing. The exact amount of heat which should be used cannot be stated, as it varies according to the thickness of the slide, etc., and can only be determined by practice. It may be estimated roughly by pressing the finger upon the upper surface of the slide close to the film, but not touching it. The slide should be just uncomfortably warm to the finger, but not hot enough to burn it.

11. Filter a few drops of the stain on to the surface of the film, and allow it to act for the requisite time. Exact details will be given in each case.

12. Next wash the slide under the tap, blot it with clean white filter-paper, taking care to avoid rubbing, and warm it gently over the flame until *absolutely* dry.

13. Place a drop of balsam on the film, and apply a clean dry cover-glass.

The preparation is now ready for examination.

This also is a process which sounds more complicated than it really is. The steps are readily learnt, and the whole process (excluding the time spent

in staining, which may be long or short) does not take more than two or three minutes.

Most bacteriologists make their films on cover-glasses and not on slides. The steps are just the same, except that the cover-glasses, being much thinner, naturally require much less heating to fix the film; they are passed *rapidly* through the flame three times. It is a great advantage to use Cornet's forceps in working

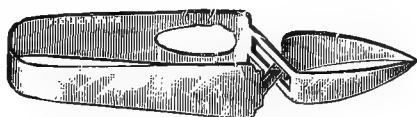

FIG. 13.—CORNET'S FORCEPS.

with cover-glasses. These forceps are self-retaining, and hold the cover-glass in a horizontal position, so that stains can be poured upon them whilst the forceps are resting on the table. In using them put the cover-glass between the jaws of the forceps, which must clip them a little distance from the corners, otherwise the stain will run into the forceps. Make a point of placing them on the table with the keyhole upwards, so that you will always know on which side of the cover-glass the film has been spread. But the staining can be carried out equally well in a watch-glass, and the cover-glass may be held in dissecting forceps.

It is far easier and more satisfactory in every way to make the films on the slides. Beginners will find that they will break large numbers of cover-glasses (which must be thin), drop more on the floor, and will be in constant doubt as to which is the film side. With slides these difficulties do not occur, and the use of forceps is quite unnecessary.

It is not absolutely necessary to use cover-glasses in the preparation of these bacterial films unless they are to be kept for future reference, and except in such cases I have discarded them for years. To examine the unmounted film it is only necessary to dry it thoroughly, and to put the immersion oil (see p. 27) directly on to the stained area. This method is especially useful in searching for the tubercle bacillus, for no one wants to keep films of tuberculous sputum after the diagnosis has been made, and if the necessity did arise a drop of balsam can be placed on the film (without removing the oil) and the cover-glass applied. The one advantage of covering the films at once is that it permits of the use of the low powers, and as this should always be done by beginners, the covering of the preparations has been recommended throughout.

## GRAM'S METHOD OF STAINING

The method of staining described above is available for all organisms, and therein consists its advantage. But other things than bacteria are stained: pus cells, fragments of tissue, débris, etc., will all be coloured, and may obscure, or even be mistaken for, bacteria. Gram's method possesses the enormous advantage that by its use the bacteria are coloured, while other structures (with the exception of particles of keratin and dividing nuclei)

are not. Hence in a film stained in such a way the bacteria are very distinct.

Gram's method possesses another advantage. It is a *selective stain*. Some bacteria retain the stain, whilst others do not, and this fact is of great value in diagnosis. The diphtheria bacillus, for instance, stains when treated in the way we shall describe, and if an organism which presents the character of that bacillus does not stain by the process it must be of some other species. We shall append a table of the most important pathogenic bacteria which stain and which do not stain in this way.

*Requisites.*—1. Aniline gentian violet, or carbol gentian violet (see p. 30).

2. Gram's iodine solution (see p. 30).

3. Absolute alcohol or methylated spirit.

*Process.*—1. Spread, dry, and fix the film in the way described above. Stain for two or three minutes in the aniline gentian violet or carbol gentian violet.

2. Rinse in water to remove excess of stain and flood with the iodine solution, and allow the latter to act for a minute.

3. Wash off the iodine solution with alcohol, and continue the application of the latter until no more colour comes away. It is best to pour a little alcohol on the slide and rock the latter from side to side for a minute or so, then to pour off the alcohol and add a fresh supply, and continue this until the alcohol comes off colourless.\*

The Gram staining proper is then finished, but if the organisms present do not stain by the method the result will be that everything is decolorized, and microscopic examination will reveal nothing. This, of course, might prove that the organism did not stain by Gram, but it might also be due to some error in technique, by which no organisms were put on the slide to begin with or got washed off at a subsequent stage. To exclude this possibility proceed to counterstain with some stain very different in colour from the gentian violet: dilute carbol fuchsin is best. Stain in this for a quarter of a minute—*not more*, for the stain is a very powerful one, and if allowed to act too long may displace the

\* Some books contain the absurd statement that the decolorization is to be carried out until the film is a pale blue or violet colour. No such rule can be given. If there is nothing that retains Gram the film will be colourless when finished; if it is a thick smear of an organism retaining the stain it may be a very deep violet.

stain from a Gram-staining organism: wash for a minute or so under the tap, dry, and mount. Organisms which retain Gram's stain will be violet, almost black, organisms which do not will be red. Pus, blood, etc., if present, will also be red. This counter-staining by means of a good contrast stain is really almost a necessary sequel to Gram's method, and in practical diagnostic work the two almost always go together.

Dry and mount as before.

The following important bacteria STAIN by Gram's method :

Staphylococci.

Streptococci.

Pneumococci.

Sarcinæ.

The skin coccus (*M. epidermidis*).

The bacillus of anthrax.

„ diphtheria.

„ tetanus.

„ tuberculosis.

„ leprosy.

„ Boas-Oppler.

The various species of actinomycosis fungus or streptothrix.

The fungi of ringworm, favus, etc.

Yeasts.

The following important pathogenic bacteria DO NOT STAIN by Gram's method :

The gonococcus.

*Diplococcus intracellularis meningitidis* (Weichselbaum).

*Micrococcus catarrhalis*.

The pneumo-bacillus.

The *Bacillus coli communis*.

The bacillus of glanders.

„ typhoid fever.

„ influenza.

„ plague.

„ soft sore.

The *Bacillus fusiformis*.

The vibrio of Asiatic cholera.

The spirilla or spirochætes of relapsing fever, syphilis, and Vincent's angina, and all other parasitic protozoa.

## EXAMINATION OF FILMS—USE OF MICROSCOPE

Daylight is the best illuminant for microscopic work, and the light reflected from a white cloud opposite the sun is best of all. Direct sunlight is useless, but the light obtained from a ground-glass window on which the sun is shining is very good.

For work at night the light from an incandescent gas-burner at a distance of 2 or 3 feet is excellent, but an ordinary paraffin lamp will answer quite well.

Having arranged for a suitable source of light, turn the flat mirror uppermost, and move it about until a beam of light is thrown on to the condenser. Remember :

In examining *stained* specimens use a *large* diaphragm.

In examining *unstained* objects use a *small* diaphragm.

You are now about to examine a stained specimen. Place the slide on the stage, putting the stained film in the centre of the aperture, and turn on the low power. Look down the eye-piece, and move the mirror about until the field is brilliantly illuminated. Focus the microscope (using the coarse adjustment) until the image is clearly defined. Now move the slide about until there is a deeply-stained area in the centre of the field. This area will not necessarily be the best for examination with a higher power, but it will serve to catch the eye when focussing the lenses which focus at a short distance from the object.

Now turn on the high power (the  $\frac{1}{8}$  inch). Remember that the "working distance" of all lenses is necessarily less than their focal distance, and that a  $\frac{1}{8}$ -inch lens focusses at a distance from the object which is decidedly less than  $\frac{1}{8}$  inch ; so also with the other powers. Lower the lens until it almost touches the object, and screw up the substage condenser as high as it will go. Look down the microscope and focus slightly upwards, using the coarse adjustment, until you catch a glimpse of colour ; then focus very slowly until the object is sharply defined.

After a little practice you will be able to focus downwards on to the film, keeping a sharp look-out for the first appearance of colour, but for beginners the foregoing method is easier and safer.

Study the object with the high power, and move it about until you find an area where the bacteria are neither too thickly nor

too thinly spread, and are well stained. Make out as much of their appearance as you are able to do with this power. Very much can be done; tubercle bacilli, gonococci, and many other bacteria, may be recognised with this power, and the peculiar arrangement of diphtheria bacilli can be seen.

Apply the clips to keep the slide in place.

Now raise the tube of the microscope for a short distance, using the coarse adjustment, and place a small drop of cedar oil on the centre of the cover-glass. Lower the tube (using the coarse adjustment) until the nozzle of the lens touches the drop of oil; then put your head on a level with the stage, and continue to focus downwards, going very carefully, until the lens *almost* touches the cover-glass. Next look down the microscope, and focus upwards, using the fine adjustment, until you begin to see colour; then go more slowly until the film is well defined.

Beginners are strongly urged to adopt this method of focussing an oil-immersion lens until they have acquired a considerable amount of practice. It takes a little time, but this is well repaid by the absence of all danger or injury to lens and cover-glass. After a time you may lower the lens until it touches the oil, and then look down the microscope and continue to lower it with the fine adjustment.

After use, wipe the front of the immersion lens with a soft silk handkerchief kept specially for the purpose, and put the microscope back into its case. If oil or balsam should get dried on the lens, wipe it with a handkerchief just moistened with xylol or pure turpentine, and then wipe quickly with a dry handkerchief. Never dip the point of a lens into xylol or alcohol. Never remove the front combination of an oil-immersion lens for cleaning or any other purpose.

## STAINS

The following stains are all that is really necessary for the vast majority of purposes: methylene blue, *basic* fuchsin, gentian violet, thionin, and water-soluble eosin. Bismarck brown may also be obtained. Ten grammes of each will last the practitioner for a long time, and this amount costs from 7d. to 1s. They should be of Grübler's make, and can be obtained from Messrs. Baker, Holborn; Baird and Tatlock, Hatton Garden; J. J. Griffin, Kingsway, W.C.; A. Fraser, Teviot Place, Edinburgh; and from

Messrs. Southall or Philip Harris, Birmingham. Other firms will also supply stains, but Grüber's should always be specified.

They are conveniently kept in a saturated solution of absolute alcohol. The following formulæ are the most useful :

1. *A Saturated Watery Solution of Methylene Blue.*—This does not keep very well, and a fresh amount should be prepared after a month. It is mostly used for staining blood-films, and for staining wet specimens of cells from the pleura, pericardium, etc.; borax methylene blue will serve every purpose in bacteriological work. Instead of this I now employ acid methylene blue (No. 9).

2. *Löffler's methylene blue* is prepared by adding 30 c.c. of a saturated solution of methylene blue (alcoholic) to 100 c.c. of a 1 in 10,000 solution of caustic potash.

The potash solution is prepared thus: Take 1 c.c. of a 10 per cent. solution of caustic potash and make up to 100 c.c. with water; shake thoroughly and pour away 90 c.c.; make up to 100 c.c. with water, and again shake. A sufficiently close approximation is made by adding 1 minim of the 10 per cent. solution to 2 ounces of water.

This stain keeps fairly well.

3. *Manson's borax methylene blue*, which I now use in place of Löffler's blue and find much preferable. A stock solution (which keeps well) is prepared by dissolving 2 grammes of methylene blue and 5 grammes of borax in 100 c.c. of water. It is to be diluted with five to ten times its volume of water for use. It may be used whenever Löffler's blue is recommended. In English measures it is methylene blue, grs. xxx.; borax, grs. lxxv.; aq., ℥iij. ss.

4. *Carbol fuchsin* is made by adding a saturated alcoholic solution of fuchsin to carbolic acid lotion (1 in 20) until the fluid has lost its transparency, or 1 part of the saturated solution to 9 of the carbolic acid. This keeps well.

The following is another formula :

Fuchsin, 1 gramme, or grs. xv.  
 1 in 20 carbolic, 100 c.c., or ℥iij. ss.  
 Glycerin, 50 c.c., or ℥xiv.

5. The above stain diluted with four or five times its volume of water. Label "Dilute Carbol Fuchsin." It is usually prepared by diluting a little strong carbol fuchsin when required.

6. *Aniline gentian violet*, which is prepared as follows :

First prepare aniline oil water by shaking water (preferably distilled) with more aniline oil than it will dissolve ; a milky emulsion will result, and this must be allowed to settle for a short time. Then filter it through a double thickness of filter-paper which has been previously moistened with water.

To 9 parts of the solution thus obtained add 1 part of saturated solution of gentian violet in alcohol.

This solution keeps badly, and it is necessary that it should be freshly prepared, as very important inferences are drawn from results obtained with it. The following keeps better, and answers every purpose.

*Carbolic Gentian Violet* (a substitute for aniline gentian violet).—Add 1 part of saturated alcoholic solution of gentian violet to 9 parts of a 1 in 20 carbolic lotion.

7. *Carbol thionin* is made by adding 1 gramme of thionin to 100 c.c. of a 1 in 40 solution of carbolic acid.

This stain keeps fairly well, but it must always be filtered immediately before use, as crystals which may have a most delusive resemblance to long slender bacilli are frequently deposited in it. A similar formation of crystals also occurs if the stain be allowed to dry on the slide.

In cold weather the thionin may crystallize nearly completely out, and the fluid stain very badly. If kept in a warm place for a few hours it will recover its properties, the sediment being redissolved.

8. *Eosin* is used in a 4 or 5 per cent. watery solution. This keeps well. Red ink (slightly diluted) will answer most purposes.

9. *Acid methylene blue* is prepared by mixing 2 parts of borax methylene blue (*vide supra*), 1 part of glacial acetic acid, and 7 parts of water. It is only used for staining cells, casts, etc., in wet preparations, and has the advantage of dissolving the red blood-corpuscles, which when numerous often obstruct the view of the more important elements. It keeps well.

Stains should be filtered before use. Where much work is to be done, it is convenient to keep them in bottles which are closed with a perforated cork through which a small glass funnel is placed. A filter-paper is kept permanently in this funnel, and the stain is filtered directly on to the slide or cover-glass.

*Gram's iodine solution* may be mentioned here, though it is not a stain. It consists of a solution of iodine, 1 part ; iodide of potassium, 2 parts ; water, 300 parts. It keeps indefinitely.



## CLEANING SLIDES AND COVER-GLASSES

Slides and cover-glasses must be absolutely clean when used in the bacteriological laboratory; it is especially necessary that they should be free from the slightest trace of grease, for this will prevent fluid from spreading out into a thin and uniform film.

Slides are best cleansed by dropping them one at a time into strong nitric or sulphuric acid, and allowing them to soak for an hour or more. They are then washed in running water for another hour, soaked in strong ammonia for an hour, and kept in alcohol. As methylated spirit is not so good for this purpose, the use of alcohol is rather expensive; but it is not absolutely necessary, and the slides may be stored in a solution of ammonia (about 1 in 10) until required. When about to be used, they are to be wiped dry with an old linen handkerchief kept specially for the purpose. This handkerchief should be as old as possible, and should have been washed until it has begun to fall to pieces.

Another and more rapid method is to place the slides in a thin glass or earthenware vessel and moisten them with methylated spirit, and then to cover them completely with strong commercial nitric acid, placing the vessel in the open air. In a little while the acid will become very hot and emit copious fumes. When the ebullition has ceased, any fat which may be present will have melted, and will form a pellicle on the surface, whilst other organic materials will have been destroyed. The acid is then to be poured off, taking care to remove the pellicle of grease with it, and a stream of water allowed to fall into the vessel until the acid has been washed away. The slides (and the method is a good one for cover-glasses also) may then be placed in absolute alcohol or methylated spirit, and only require drying to be ready for use.

Another method which I have recently used and found excellent is to boil them in a 5 per cent. solution of lysol; they may be allowed to remain in this fluid until required, and are then polished with a handkerchief—and it may be pointed out that thorough friction is a *sine qua non* whatever method of cleaning be adopted. Slides and cover-glasses after use may be soaked in the lysol solution, a pot of which should be kept at hand for the purpose; they will be sterilized and partially cleaned in a few hours.

When no properly-cleaned slides are at hand, the following method may be adopted, though it is not so good: Dip the end

of a clean handkerchief in strong spirit (absolute or rectified) and wipe the slide with it, using a considerable amount of friction. Now dry it with the special handkerchief mentioned above, heat it thoroughly in a smokeless flame, and allow to cool completely. Spread the film on the surface which was exposed directly to the flame.

Cover-glasses are cleaned in the method advised for slides, and should be stored in strong alcohol smelling strongly of ammonia. They are wiped with the special handkerchief immediately before use.

When cover-glasses are to be used for covering films spread upon slides (as is generally the case if the method recommended in this book is adopted) it is quite sufficient to wipe them carefully with a clean handkerchief moistened with spirit, and then to dry them.

After slides or cover-glasses have been cleaned, the utmost care must be taken that they do not come in contact with the skin, or a thin film of grease will be deposited upon them.

## PIPETTES

Glass pipettes for the collection of pathological fluid for bacteriological examination are very frequently required. They are readily made from a piece of quill glass tubing, and a few should always be kept in stock against emergencies.

One form consists of a bulb about  $\frac{1}{2}$  inch long, each end of which is drawn out into a narrow tube at least 6 inches long, tapering gradually to the extremities (Fig. 14, *a*). To make such a pipette, take a piece of glass tubing about 6 inches long and a  $\frac{1}{4}$  inch wide, and heat it in a luminous gas flame at a point  $\frac{1}{2}$  inch or so from the centre. Continue the heat until the glass is thoroughly softened over at least  $\frac{1}{2}$  inch of its length, turning the tube round all the time; then remove it from the flame and draw the two ends apart with a steady, uniform pull, so that the heated portion draws out into a capillary tube several inches in length. Repeat the process at a point about  $\frac{1}{2}$  inch from the tapering end of the larger portion of the tube; heat the bulb, and then seal off both ends of the capillary portion before the bulb cools.

The pipettes are necessarily sterile, having been drawn out of partially melted glass, and they will remain sterile indefinitely.

Of course, the exterior of the glass will become contaminated, and it should be passed through the flame before use.

The ends of the tube being sealed up while the bulb contains heated air, it follows that the bulb will contain a partial vacuum on cooling. This fact is made use of in the collection of specimens. Suppose, for instance, we wish to take some blood from a heart at a post-mortem examination for investigation at a distance. A point on the surface of the heart is first seared with a hot iron to destroy any germs which might be present, and the end of the pipette (still sealed) is thrust through into one of the cavities. It is then broken off by dexterous pressure against the heart wall, and the pipette will fill slowly with the blood. Another

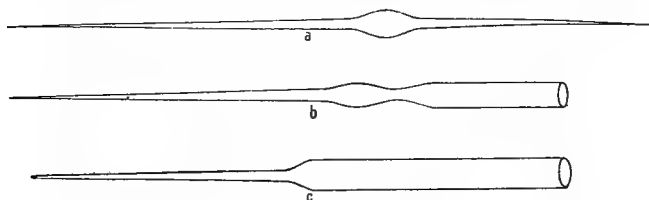

FIG. 14.—PIPETTES.

method is to break off the tip of the pipette and to warm the bulb before making the puncture. The fluid will rise as the bulb cools; or both ends may be broken up and the fluid drawn into the bulb by gentle suction.

Under any circumstances both ends of the pipette must be sealed up in a flame (the flame of a wax match will answer at a pinch), and the tube labelled.

Another variety of pipette which was much used for the collection of blood for the purpose of testing the serum reaction for typhoid fever, is drawn out to a point at one end only, the other being left wide and separated from the bulb by a constriction (Fig. 14, *b*). The open end should be loosely plugged with cotton-wool, and serves as a mouthpiece. The manufacture of these pipettes presents a little difficulty, but a small amount of practice will enable the practitioner to turn out a perfectly serviceable one on occasion.

Wright's blood capsules (Fig. 15) are the best contrivances for collecting blood when the serum has to be examined, and have quite replaced the pipettes described above. They can be pre-

pared easily after a little practice, or may be bought from R. B. Turner, 11, Foster Lane, E.C., at a moderate price.



FIG. 15. (About  $\frac{2}{3}$  full size.)

A Wright's blood capsule consists of a piece of glass tubing which is drawn out straight to a narrow point at one end, whilst the other, also drawn out to a point, is curved round parallel with the main tube in the shape of a **U** (Fig. 15). To use it, proceed as follows: Prick the patient's ear, or, if you prefer it, the finger (after the application of a wide indiarubber band), and squeeze out a large drop of blood. Place the tip of the curved end of the pipette in this drop, holding the pipette with the straight end pointing upward (Fig. 16), and you will find that the blood will run rapidly into the curved tube by capillary attraction; continue to squeeze out more blood and to suck it up until you have collected as much as you want. It should be quite easy to get the pipette half full. Then gently warm the tapering portion of the straight end of the pipette in a spirit-lamp or match-flame, and afterwards seal the tip (Fig. 17). As the air

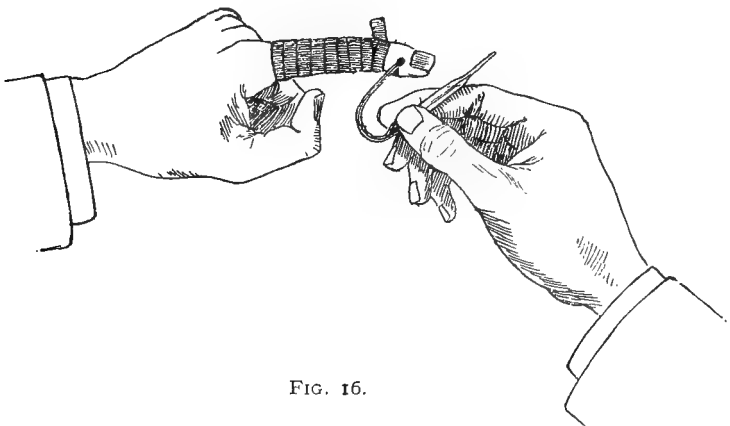

FIG. 16.

which is now imprisoned in the upper part of the pipette contracts it will suck the blood from the curved limb into the body of the pipette, which can be inverted and the blood shaken into the tip, but take care *not* to do this *until the glass is cold*, as the serum loses some of its properties when heated. If you are not going to

examine the serum for some time seal the other end to prevent evaporation.

When the blood has coagulated it will begin to contract away from the sides of the tube, the serum being forced out of the clot. When this process is complete there will be a central dark-

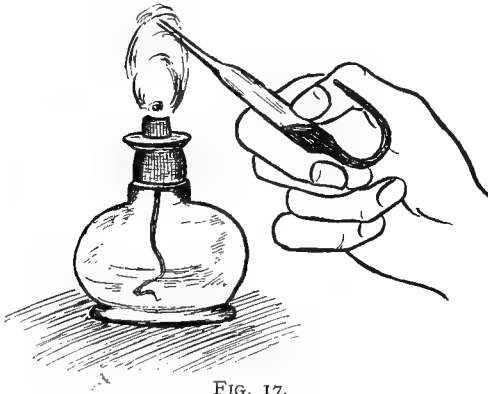

FIG. 17.

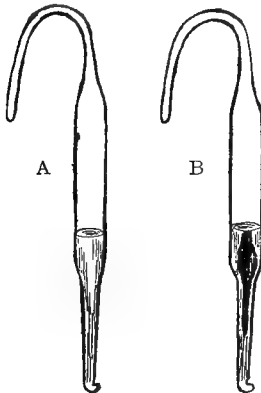

FIG. 18.

A, Before coagulation ; B, after, showing clot suspended in clear serum.

coloured clot suspended in clear serum. The tube can now be notched with a file and broken, and the serum removed with a pipette and used for Widal's reaction, the estimation of the opsonic index, etc. If much serum is required, the pipette can be hung by its crook (straight end downward) in the bucket of a

centrifugal machine and centrifugalized. In this way the clot is driven to the bottom and a large crop of serum obtained.

Since some practitioners seem to have difficulty in collecting the quantity of blood desirable for the opsonic and other tests, a few more notes on the process may be added. I personally prefer to obtain the blood from the ear, and proceed as follows: the lobe is well rubbed by means of a piece of lint, until it is markedly hyperæmic, and is then punctured on its lower border with a Hagedorn's needle or platino-iridium hypodermic needle (previously sterilized in the flame). This is done by a short, sharp "jab," and should not be felt as pain at all; I have frequently done it without waking a sleeping child. The needle is then laid down, and if the blood flows out in large drops (as usually happens if the ear has been well rubbed) it is collected without the slightest difficulty, and this is specially likely to be the case if you puncture the ear of the side on which a patient has been lying. If it does not flow readily, take the lobe of the ear between the forefinger and thumb of both hands, and squeeze it gently so that all the blood in the lobe is forced through the puncture, and collect the drop thus formed. When this has been done the lobe of the ear will be full of blood again, and a second drop can be milked out. Repeat this process as often as necessary. There are few patients from whom several pipettes half full cannot be collected from a single slight puncture.

Many pathologists prefer the finger. In that case an excellent needle can be made by softening a small piece of capillary tubing in the flame and separating the two ends rapidly. This will give two tapering tubes, which can be broken off so as to leave a very sharp point, with which the skin at the side of the nail can be punctured almost painlessly. The ligature is then applied as in the figure, and the patient bends his finger forcibly, squeezing out two or three drops of blood. After these have been collected the bandage must be removed and the hand allowed to hang down, so that the finger refills with blood. It is rebandaged and rebent, and more blood obtained. This process should be learnt, since it is the simplest one by which the practitioner can obtain blood from himself, as is often necessary in opsonic work.

## SECTION II

### DIAGNOSIS OF CERTAIN DISEASES

#### DIPHThERIA

DIPHThERIA is a local disease with general symptoms. The local symptoms are due to the local action of the bacillus which causes the disease, while the general symptoms are due to the toxin or poison which they produce, and which is carried in the blood-stream to the brain, heart, and other organs. Now, the local symptoms are comparatively unimportant, and it is to the general symptoms caused by the toxin that diphtheria owes the greater part of its high mortality. Diphtheria antitoxin neutralizes this toxin (much in the same way as an alkali neutralizes an acid), and prevents it from harming the vital structures; but it does *not* repair the harm that the toxin has done. It is obvious, therefore, that we must not make our diagnosis of diphtheria from the general symptoms if the antitoxin treatment is to do any good. The diagnosis is to be made from the local symptoms, and this is what we can rarely do by ordinary clinical methods at a stage sufficiently early to get the full value of the antitoxin treatment.

The practitioner has a choice of two methods. He may inject all patients who suffer from sore throats which present the slightest resemblance to those seen in diphtheria, or he may employ bacteriological methods of diagnosis. The former method may be applicable in an epidemic of diphtheria, but suspicious throats are common and antitoxin expensive. In most cases it is necessary to have recourse to the second method.

Most sanitary authorities have now recognised that it is their duty and privilege to provide for the bacterial investigation of supposed diphtheria free of charge to doctor and patient, and supply outfits to be used for taking the material and transmitting it to the laboratory. When the practitioner lives within easy

reach of the laboratory (so that the swabs may reach it quickly) it is his bounden duty to avail himself of the opportunity thus afforded of getting a free opinion from a specialist.

But the case of a practitioner living at a distance is somewhat different. Suppose the patient is seen on the first day of the illness, an unusual occurrence except in an epidemic. The swab is taken, despatched by post, and reaches the laboratory on the second day. It is inoculated, and the culture is incubated and examined on the third day, the result reaching the practitioner about noon on that day. Now, the mortality of diphtheria which is treated with antitoxin on the first day is very small—certainly less than 5 per cent.—while the mortality in cases in which its use is not commenced until the third day is much higher—probably from 10 to 15 per cent., or even higher. In other words, from five to ten patients out of every hundred lose their lives if the doctor waits for the result of the bacteriological examination. It is therefore highly advisable that every practitioner should provide himself with a bacteriological microscope, and should *at least* examine a film prepared directly from the swab and stained in the manner described below. He should also make cultures or send a swab to the laboratory for examination.

Swabs and outfits are provided by the laboratory where the examination is made, or can be bought from most manufacturing chemists and instrument-makers. A swab consists of a steel or copper (aluminium would be better) wire, the extremity of which is covered drumstick fashion with a tightly-fitting roll of cotton-wool. The other end is pushed through a cork, and the whole is contained in a stout glass tube. It is sterilized before use. These swabs may be readily made at home. A test-tube is fitted with a good cork through which is passed a stout steel knitting-needle. This should be long enough to pass nearly to the bottom of the tube when the cork is in place, and the end which is to be outside the tube should be cut off short. The other must be roughened by a few strokes of a file. A small piece of cotton-wool (unmedicated) is then held between the thumb and finger of the left hand, transfixed with the roughened end of the wire, and twisted round it. The swab is now placed loosely in the tube and sterilized by dry heat (see *ante*, p. 7). It is allowed to cool in the sterilizer, and the cork is pushed home into the tube as soon as it is cold enough to handle. These swabs will keep indefinitely, and a stock of them should always be kept at hand, as they are



very handy for other purposes. After use the cotton-wool should be burnt off in a Bunsen burner or spirit-lamp, and another piece applied and the whole resterilized.

If a practitioner should see a supposed case of diphtheria when he is unprovided with a swab he can readily extemporize one which will answer sufficiently well out of some cotton-wool (non-medicated), a wooden skewer or pen-holder, and a glass phial. The wool is wrapped round the tip of the skewer, and (after the swab has been taken) the latter is placed in the phial in such a position that the cotton-wool does not touch the glass; the place between the skewer and the neck of the bottle is plugged with cotton-wool. It is not *absolutely necessary* to sterilize the swab, although it is a very great advantage to do so if time permits.

The method of *taking the swab* is of great importance, and must be carried out in full detail. It is necessary that the patient should not have had an antiseptic gargle or application for *at least* two hours previously. It is also advisable to allow him to drink some beef-tea or boiled water (*not milk*, for this may contain certain bacilli which closely resemble those of diphtheria) immediately before the process. This will serve to cleanse the parts.

*Requisites.*—1. A good light.

2. The swab in its tube.

3. A tongue depressor. The form which is hinged so as to bend at a right angle is most convenient.

4. A vessel containing antiseptic lotion or boiling water.

*Method.*—1. Place the patient so as to face the light. If a small child, he should be held on his nurse's lap, with a blanket wrapped round his chest so as to restrain his arms.

2. Loosen the cork in the tube so that the swab may be withdrawn with one hand, and place it at a convenient spot on your right side.

3. Get the patient to open his mouth, insert the tongue depressor (held in the left hand), and get a clear view of the area chiefly affected. Do not proceed with the process (if it can be avoided) until you have done this.

4. Take the cork between the finger and thumb of the right hand and pass the swab into the patient's mouth, taking great care not to touch his lips, tongue, or palate. Press it firmly against the area which you wish to examine, and rotate it between the finger and thumb so as to remove some of the secretion, and, if possible, some of the membrane. Withdraw the swab, again

taking care not to touch any part of the mouth, and replace it in the tube.

5. Withdraw the tongue depressor, and place it in the anti-septic lotion or boiling water.

6. Push the cork home into the tube.

*Method of examining the Swab.*—This may be carried out by means of stained films, prepared directly from the swabs, or by means of cultures. The former method is less useful than the latter, but we shall consider it first, as it can be performed by anyone who possesses a microscope carrying a  $\frac{1}{12}$ -inch oil-immersion lens, and often gives valuable information. Moreover, it does not take long, and but little delay is caused.

*Requisites.*—1. Clean slides and cover-glasses.

2. Stains.—Löffler's blue or carbol thionin, and aniline gentian violet.

3. Gram's iodine solution and alcohol—methylated spirit will do.

4. Strips of white filter or blotting paper.

5. Balsam.

*Method.*—Prepare a film in the following way: Rub the swab on the middle of a clean slide, so as to spread some of the secretion into a thin layer on the surface. Allow it to dry, and fix it by passing it slowly through the flame, until the upper surface is just too hot to prevent your pressing your finger upon it in comfort. Allow it to cool.

Now filter a few drops of Löffler's blue or carbol thionin on to the film, and allow it to act for two minutes. Wash under the tap.

Dry by pressing carefully with strips of blotting-paper, and then in the flame. Place a drop of balsam upon the film, and apply a cover-glass.

Prepare a second film, and stain by Gram's method (p. 24), counterstaining by dilute carbol fuchsin.

The films are now examined microscopically (see p. 27). We shall defer the description of the points upon which a diagnosis is to be based until we deal with the examination of cultures.

#### CULTURAL METHODS.

The diphtheria bacillus grows best at or near the body temperature (about  $37^{\circ}$  C.), and flourishes on almost all culture media. But agar is scarcely ever used in growing it for diagnostic

purposes; this medium serves well for the cultivation of a great many organisms, some of which are almost always present in the mouth, so that cultures made upon it are usually very impure. We use a medium which permits the development of the diphtheria bacillus, and inhibits that of most other organisms. The best is solidified blood-serum.

The method in which the medium is inoculated is as follows: The tube of culture medium, and the tube containing the swab, are held side by side between the index and middle fingers of the left hand, the mouths of the tubes pointing to the right and slightly downwards. The plug of the culture-tube is then singed, removed by means of a pair of forceps, and placed between the ring and little fingers of the left hand. The cork and wire of the swab-tube are now withdrawn, and the cotton-wool plug is inserted into the culture-tube, and passed onwards until it reaches the sloped surface of the medium. It is then rubbed gently on the latter, and twisted round and round so that every part of the swab may come into contact with the medium. If there is a piece of membrane special care should be taken to see that it is rubbed on the surface, for it is here that we are most likely to find the bacilli. The swab is now withdrawn and replaced in the tube, and the cotton-wool plug of the culture-tube singed and replaced.

The tube thus inoculated must now be incubated for about eighteen hours at a temperature not exceeding  $37^{\circ}$  C., and is then ready for examination.

Hewlett has suggested a useful method which may be carried out without any special apparatus, the white of a hard-boiled egg being used as the culture medium. Take a fresh egg and boil it for ten minutes or more, and allow it to cool. Now take a narrow-mouthed wineglass (or a wide-mouthed bottle, which is better), and rinse it out with perchloride of mercury lotion. Sterilize a knife by passing it slowly through the flame, and cut off the top of the egg, care being taken not to cut into the yolk. Invert the egg into the wineglass (which must be narrow enough to prevent the egg from dropping down into it), taking care that none of the lotion touches the cut surface. This is the culture medium, and it is sterilized ready for inoculation. At a pinch it may be incubated in a warm corner near the fire, near the hot-water cistern, or other warm place.

## EXAMINATION OF THE CULTURES.

1. *Naked-eye*.—Each living diphtheria bacillus which has been deposited upon the surface of the culture medium and kept at a suitable temperature will develop into a colony of bacilli; and these colonies are fairly distinctive, being different from those which are formed by most other organisms. The expert bacteriologist can often give an accurate guess as to the presence or absence of diphtheria bacilli by mere inspection of the cultures. The colonies formed by diphtheria bacilli on solidified blood-serum are small round *raised* spots; they are variable in size, but rarely exceed that of the head of a medium-sized pin. They are white or grey in colour, and opaque. They do not tend to run together so as to form a uniform film over the surface of the medium, but remain discrete even when closely packed. Some cocci form colonies which closely resemble those of diphtheria, but they rarely become elevated so high above the surface in the same space of time.

2. *Microscopical*.—Prepare films by the method described on p. 22 following out all steps in the fullest detail. Stain one of them (step 11) with Löffler's blue or carbol thionin, allowing the stain to act for two minutes, and the other by Gram's method.

In removing some of the growth to make the film, remember the facts just stated as to the characters of the colonies of the bacillus, and select a colony presenting those characters (especially that of elevation), if one is present. If there is no apparent growth in the tube take "sweeps" of the whole surface. This is conveniently done by means of a platinum loop shaped like a stirrup, the flat bar being drawn along the surface of the medium from bottom to top, just as a rake is drawn along a flower-bed.

Now examine your specimens in the way described on p. 27.

## CHARACTERS OF THE DIPHTHERIA BACILLUS.

The following are the chief points which are considered in deciding whether a given stained slide does or does not show the diphtheria bacillus.

1. The *shape* of the bacillus is very variable, and this is a feature which often affords us great assistance; a specimen in which all the bacilli present resemble each other exactly in shape and size is not from a case of diphtheria. Diphtheria bacilli are

narrow rods; they are either straight or slightly curved in an arc of a large circle or into an *f* shape (Plate I., Figs. 1 and 2). Their ends are usually rounded, but it is not uncommon to find forms with one end or both sharply pointed. Lastly, clubbed forms are to be met with in almost all cultures, though they are most frequent in those which have been incubated for several days; they may be compared to a note of exclamation (!).

2. *Size*.—Two well-marked varieties occur. The long form is about as long as a tubercle bacillus (to compare it with an organism with which the practitioner may readily become acquainted), or somewhat longer; it is decidedly thicker. The short form is only about half as long and thick in proportion.

We do not know anything as to the difference in pathogenicity (if any) of the long and the short varieties of the diphtheria bacillus. They appear to "breed true" for long periods, and cases of diphtheria caused by the one appear to have as high a mortality as those caused by the other.

Hoffmann's bacillus is dealt with subsequently.

3. *Staining Reactions*.—The diphtheria bacillus stains readily with all the stains in common use for bacteriological purposes. It usually (but not invariably) stains *irregularly*, deeply-stained portions alternating with others which remain colourless. This gives rise to a beaded appearance, and forms sometimes occur which can hardly be distinguished from short chains of streptococci. When a powerful stain is applied for a long time this appearance may be lost.

The diphtheria bacillus stains deeply with thionin. This often affords a certain amount of help in the diagnosis, as many other bacilli do not stain nearly so deeply in the same time.

It stains by Gram's method. A beginner should always test his results in this way: If suspicious bacilli do not retain the violet stain they are not those of diphtheria.

4. *Arrangement*.—This is a most characteristic feature, but it is one which is difficult to describe. The old comparison to the strokes which form a Chinese letter is a fairly good one; the bacilli lie in little groups, some lying parallel to one another, and some at various angles with these. The characteristic arrangement is best seen in a specimen made from a pure culture of the short form.

Before coming to a conclusion as to the presence or absence of diphtheria bacilli from an examination of a stained film, make a

very thorough search; if no bacilli are seen, make several more films and examine them. When you see a group of bacilli, examine it carefully, noting each characteristic and comparing it with those described above.

The beginner is strongly recommended to procure a series of slides of diphtheria bacilli from a bacteriological laboratory, and to study them carefully.

Hoffmann's bacillus (Plate I., Fig. 2) is probably a modified form of the true diphtheria bacillus, and is frequently met with in throat cultures. It is about as long as the short form of diphtheria bacillus, but decidedly plumper, and is more uniform in shape and size. These bacilli stain uniformly and deeply. They exhibit the same arrangement, and are often grouped in pairs. Clubbed forms do not occur.

The diphtheria bacilli which occur in *films made direct from the swab* are similar to those seen in cultures, but are often thicker; they may stain uniformly, and clubbed forms are rare. It is unusual to be able to make an absolute diagnosis as to their nature, but it may be done at times. Yet such an examination is often useful. If suspicious bacilli are present you should inject antitoxin forthwith; if no suspicious bacilli are seen it is safe to wait for the result of the cultural examination.

#### INTERPRETATION OF RESULTS.

*The discovery of the diphtheria bacillus in the exudate may mean—*

(a) That the patient is suffering from diphtheria.

(b) That he has suffered from diphtheria and is now convalescent, but is *still infectious*. The bacilli may persist for weeks or months, and while they do so the patient must be isolated and treated with antiseptic gargles.

(c) That he is in danger of acquiring diphtheria if subjected to any influence which lowers his vitality, or which would cause ordinary sore throat in any ordinary person.

(d) It *always* means that the person may communicate diphtheria to a susceptible subject.

The significance of Hoffmann's bacillus is not yet settled. It is frequently found in the throat when the patient is convalescing from an attack of diphtheria, and sometimes in subjects who afterwards develop diphtheria. It also appears to cause epidemics of sore throat which do not present anything remarkable in their

clinical characters. It is safest to regard any patient who presents these bacilli as being infectious. In other words, in the present state of our knowledge it is best not to draw any distinction between Hoffmann's bacillus and the true diphtheria bacillus, as far as infectivity is concerned.\*

*A negative result may mean—*

(a) That the patient is not suffering from diphtheria.

(b) That the swab did not touch the affected area.

We exclude errors in technique and observation.

*A sterile culture may mean—*

(a) That an antiseptic was used too soon before taking the swab.

(b) That the diseased portion of the throat was not touched.

Other parts of the mouth contain numerous bacteria, but many of them do not grow well on blood-serum or ascitic agar.

We again exclude errors arising in the laboratory.

Whenever the culture-tube remains sterile, the examination should be repeated.

## TETANUS

The pathology of tetanus is very much like that of diphtheria. In each disease the specific bacilli are localized at or near the region at which they enter the body, and form a toxin which affects distant organs. In the case of diphtheria, as we have seen, the toxin passes by the blood-stream, but in tetanus it creeps from the region where it is produced up the peripheral nerves to the brain and spinal cord. In each case research has shown that an antitoxin is formed which neutralizes this toxin and prevents it from uniting with the cells of the body, but which has not the power of turning it out from such a combination. In other words, tetanus antitoxin, like that of diphtheria, is preventive, but not curative. But here, unfortunately, the resemblance between the two diseases ceases. The local lesion in diphtheria is obvious, and its presence causes a good deal of inconvenience to the patient;

\* Since the publication of the first edition of this book there has been much controversy on this point, but I have seen nothing which leads me to alter the above opinion, though it is certainly true that laboratory evidence of the relation of the organisms appears lacking. It may be noted that those who deny the relation of Hoffmann's bacillus to diphtheria do so, for the most part, on this failure of laboratory evidence, whilst those who look on Hoffmann's bacillus with suspicion do so mainly on clinical grounds. (For an account of other forms of sore throat, see p. 105.)

he sees a medical man early, and the diagnosis of diphtheria is made before much of the toxin has entered the blood. It is different with tetanus. In this the local symptoms are practically nil; there may be suppuration at the region of inoculation, but this is so common as not to excite suspicion. The result is that the diagnosis is not made until the appearance of the symptoms referable to the nervous system indicates that the period at which antitoxin might have been used with success has gone by.

To illustrate this we will imagine the local lesion of diphtheria to be so slight as to be unnoticed by doctor and patient. The result would be that the disease would only be diagnosed when the severe toxæmic symptoms had manifested themselves, and antitoxin would then be almost or quite useless. If it were not for the discomfort and pain caused by the throat lesion of diphtheria, the antitoxin treatment of the disease would have probably been abandoned as useless.

But tetanus may be diagnosed by means of a bacteriological examination of the local lesion before toxic symptoms have appeared, and in cases where this is done we may safely look for results from tetanus antitoxin which are as good as those obtained from the early use of diphtheria antitoxin; for the experimental evidence in favour of the one is every whit as great as that in favour of the other.

Considerations of time would prohibit the bacteriological examination of the multitude of small wounds which are seen by the majority of medical men. But a wound which clinical experience and bacteriological research as to the occurrence of tetanus bacilli outside the body indicates as being one which is likely to become infected with the bacillus in question should be submitted to a careful and prolonged search for the bacillus. These are deep incised and lacerated wounds, especially those of the hand and foot, and particularly if garden earth or horse-dung has been rubbed into the tissues. Wounds made with splinters, rusty nails, or the wads from firearms, should be examined. Severe lacerated and contused wounds in "run-over" cases, contaminated by the dirt of the road, must also be regarded with suspicion, for tetanus follows superficial wounds almost as frequently as deep ones. Tetanus *may* follow a wound which heals up by first intention, but this is unlikely; suppuration or necrosis of the edges (though not due to the tetanus bacillus itself) is present in the majority of cases.



## EXAMINATION OF PUS FROM SUSPECTED CASES OF TETANUS.

*Requisites.*—1. Slides and cover-glasses.

2. A stiff platinum loop.
3. Bunsen burner or spirit-lamp.
4. Löffler's blue or carbol thionin.
5. Materials for Gram's staining.
6. Balsam.

If cultures are to be taken, add a pipette (see Fig. 14*b*), a deep tube of agar to which 2 per cent. of grape-sugar has been added previous to sterilization, a flask of water, and a thermometer.

*Method.*—Scrape the deeper portions of the wound with the platinum loop, and spread out the secretion thus obtained on the surface of a slide. Prepare several of these slides, and fix the film by heat. Stain some by the simple stain for two minutes and others by Gram's method.

The bacillus of tetanus is about as long as the tubercle bacillus and is very slender. It stains by Gram's method. A very characteristic feature is its method of spore-formation. The spores are spherical bodies which are formed at the *extremities* of the bacilli, giving them the appearance of pins or drumsticks. The spores do not stain by the ordinary stains, and appear as colourless and highly refractile bodies (Plate II., Fig. 1).

The cultures are made in agar to which 2 per cent. of grape sugar is added, and the needle or pipette used in making the inoculation is plunged deep down into the medium. The bacillus of tetanus is an anaërobie—*i.e.*, it grows only in the absence of oxygen. The stabs are made deep in order to inoculate the material far away from the air, and the glucose is added to absorb any oxygen which may be in the medium. To increase our chances of obtaining this bacillus in pure culture, the material to be examined is to be heated to a temperature which will kill all developed bacteria, but which will not be injurious to spores; the tetanus bacillus is the only anaërobic organism with a spherical terminal spore which is at all likely to occur in a wound.

*Method.*—The inoculations are to be made with a pipette. If the pus which comes from the wound can be drawn up into the capillary tube of a glass pipette such as is described on p. 33 the material should be collected in this way. If this is not the case, the wound must be scraped with a sterilized platinum needle or other suitable instrument, and the material thus obtained

mixed with some boiled water (previously cooled) and then sucked up into the pipette; the end of the latter is then to be sealed in the flame, care being taken that the material itself is not heated.

Having filled and sealed the pipette, heat some water in a small flask or large test-tube until it reaches  $80^{\circ}$  C., as measured by the thermometer; insert the sealed end of the pipette in the water, and maintain the temperature for ten minutes. The thermometer is to be kept in the water the whole of the time, and the flame is to be taken away when the temperature rises above  $80^{\circ}$  C., and reapplied when it falls below that point.

At the end of this time the pipette will contain no living object other than spores. Break off its point and insert it gently into the glucose agar, taking care to keep exactly in the axis of the tube, until the tip of the pipette reaches almost to the bottom of the test-tube. Withdraw the pipette gradually, blowing out its contents as you do so. The spores of the tetanus bacillus (if present) will now be inoculated deep down in the medium, far away from the air. To reduce the supply of oxygen still further it is a good plan to melt some paraffin (a hard candle answers perfectly) and pour a layer an inch thick over the surface of the medium; or vaseline which has been heated to the boiling-point of water (to sterilize it) may be used.

The cultures thus made are to be incubated for a few days at the body temperature. After about forty-eight hours the growth begins to appear in the deeper portions of the tube as a series of delicate wavy outgrowths from the central stab. These do not appear in the upper portion of the medium, where the oxygen (which diffuses down from the air, unless the tube has been sealed with paraffin) hinders their growth. If the culture is pure—and this is not likely to be the case, as these wounds are usually very highly contaminated—no gas will be produced by the growth, whereas the bulk of the other organisms which are likely to occur produce gas. A bubble or two in the course of the growth, therefore, indicates that the culture is not pure tetanus bacillus, but that organism may nevertheless be present. If the tube shows such a growth, it should be submitted to a microscopic examination. It is a good plan to break the tube and to split up the cylinder of medium with a knife; films are made from the growth and stained as above. Spores are formed after about thirty-six hours.

The other methods of cultural examination are far more difficult.

#### INTERPRETATION OF RESULTS.

If bacilli having the above characters are found in films, the diagnosis of tetanus must not be considered as being absolutely proven, for there are other bacilli which might be mistaken for those under discussion; but the probability that the patient will develop the disease is so strong that steps should be taken accordingly. The wound should be scraped and thoroughly treated with antiseptics, and antitoxin should be given. If the deeper portion of the glucose-agar stab shows the tree-like growth which has been described and contains slender drum-stick bacilli, the case is strengthened, even although the upper part of the medium is contaminated with other organisms.

The only way in which the bacilli can be recognized with absolute certainty is by means of animal experiments; this is a very certain method, and one that can be carried out in the absence of pure cultures. The material is diluted with some broth and divided into two parts, of which one is injected into an animal just as it is, whilst the other is mixed with antitetanic serum and then injected. In a case of tetanus, the first animal will die with tetanic symptoms, whilst the latter will survive or die of sepsis without tetanus.

#### THE PNEUMOCOCCUS, PNEUMONIA, ETC.

The pneumococcus is a very important organism, and one which plays a prominent part in the production of disease. It may occur in the mouth in a healthy person; hence its recognition in small quantities in the sputum is not of diagnostic value.

The pneumococcus is a very common cause of disease of the respiratory system. It causes:

1. *Acute lobar pneumonia.* Opinions differ as to whether it is the *only* cause of this disease, though it appears most probable that this is the case.

2. *Lobular (broncho-) pneumonia.* This disease may also be caused by streptococci, staphylococci, diphtheria bacilli, influenza bacilli, plague bacilli, tubercle bacilli, and others. The pneumococcus may also occur as a *secondary infection* in lobular pneumonia due to any of these.

3. *Pleurisy*, either the serous, fibrinous, or purulent varieties, and especially in children. It is important to notice that the prognosis of empyema is better when the disease is due *solely* to the pneumococcus than when other organisms (streptococci, staphylococci, tubercle bacilli, etc.) are present, and such cases usually recover without resection of ribs. The bacteriological examination of the pus from a pleural cavity may thus lead to results important as to prognosis and treatment.

4. The pneumococcus may occur as a *secondary infection* in almost any disease of the lung; for instance, in the walls of a phthisical vomica.

The most important primary lesions due to the pneumococcus outside the respiratory system are:

1. *Otitis media* (of which it is a very common cause), empyema of the antrum, and of the frontal and other accessory sinuses of the nose.

2. *Erysipelas*, which is usually due to another organism, the *Streptococcus pyogenes*.

3. *Brawny induration of the skin*, with or without suppuration. This is uncommon, but I have seen several cases.

4. *Suppuration* in any region, especially in infants, in whom it is probably the most common pyogenic organism.

Pneumococci may escape into the blood from any of these lesions, and may appear in that fluid when there is no obvious primary lesion from which it could have gained access. The most common results are:

1. *Septicæmia*.

2. *Ulcerative endocarditis*. Many other bacteria may cause this disease.

3. *Meningitis*. Pneumococcal meningitis may also be due to direct spread from the middle ear.

4. *Arthritis*.

5. *Peritonitis*.

The prognosis in these latter affections is on the whole slightly better if they are due to the pneumococcus than if caused by other organisms, except in the case of meningitis, which is usually fatal in a few days.

In actual practice we have most commonly to search for the pneumococcus in sputum, pus, and blood. In the latter case cultural methods are usually necessary, and we shall defer its consideration for the present.

*Sputum.*—The examination of sputum may be made in order to make a diagnosis as to the presence or absence of pneumonia, in a case in which the physical signs are indeterminate, or to establish the nature of a lobular pneumonia.

The patient must wash out his mouth with water, which should have been boiled and allowed to cool. He must then spit into a clean wide-mouthed bottle, also containing boiled water, and care must be taken that the sputum used for the examination comes directly from the lungs, and is not merely mucus which has collected in the mouth.

The mass of mucus forming a single "spit" is agitated gently in the water to remove contaminations from the bronchial tubes and mouth; the water is poured off and more added, and the process repeated several times. Then the mass of mucus is fished out, placed in a watch-glass, carefully opened with a pair of scissors, and a piece about as big as a pea is removed from the centre of the mass with a platinum loop. It is placed on a clean slide, another slide pressed upon it, and the two are slid apart. The films thus obtained are allowed to dry, and fixed by heat in the usual way.

One is then stained by Gram's method, and counterstained by dilute carbol fuchsin for about a quarter of a minute, washed, dried, and mounted, and the other with undiluted carbol fuchsin.

The pneumococcus is a diplococcus—*i.e.*, the individual cocci are arranged in pairs. Each coccus has usually an oval or lancet shape, the sharp ends of the two germs pointing away from one another (Plate I., Fig. 3, and Plate III., Fig. 4). Abnormal forms (round cocci, short bacilli, etc.) are frequent. The pneumococcus has a *capsule* when it occurs in the living body or in pathological exudates, but not in most cultures. This capsule does not stain readily, and appears in a properly-stained specimen as a clear halo round the two cocci.

Examine your Gram specimen first. The pneumococci (which will be almost black) should be clearly seen, and you should be able to make out their shape and characteristic arrangement in pairs.

The general surface of the film is stained pink, while there is a clear and colourless zone round each pair of cocci. This is the capsule, which is rendered distinct by "negative staining," and these appearances will be better seen in a somewhat thick and deeply-stained film, though if the carbol fuchsin has been allowed to act too long the capsule may be stained a faint pink. There

are special methods of staining which may be used to render the capsule more distinct, but these are usually unnecessary for the diagnosis.

#### INTERPRETATION OF RESULTS.

In cases of lobar pneumonia you will probably find pneumococci in great quantity, and no other bacteria in a specimen of sputum *made in the manner described*. If you find many pneumococci in a case of lobular pneumonia the disease may have been caused by another germ, and the cocci in question may have been nothing more than a secondary infection. A specimen should be stained deeply by carbol fuchsin or methylene blue and searched for bacilli resembling those of influenza, etc., and another should be stained for the tubercle bacillus if the clinical aspect of the case suggests the possibility of a tuberculous origin for the disease.

*Pus* is examined in the same way, and presents similar appearances. Most of the cocci are extracellular, but some are frequently contained in the cells, and may then not retain Gram's stain.

It is not usually necessary to make cultures, as the pneumococcus is readily recognized in pathological material from its morphological appearance and staining reactions alone. Where cultures are required, agar is about as good a medium as can be used, and it must be incubated at the body temperature. The colonies are visible after twenty-four hours as very small transparent circular masses, which are but slightly raised and show but little tendency to increase in size on further incubation. It is a very delicate organism, and one which readily dies out on ordinary media, so that if a culture is to be "kept going" it must be transplanted every two or three days to a fresh tube. This is one of its most characteristic features.

#### INFLUENZA

In the first edition of this book, in treating of influenza, I followed the usual teaching of bacteriologists and regarded the disease as a specific one, and as being caused in all cases by the influenza (or Pfeiffer's) bacillus. Recent observations, both in England and on the Continent, have shown that this view can no longer be upheld, unless we greatly restrict the use of the term "influenza," and use it only for those cases in which the bacillus in question is found. This is quite unjustifiable, for the diseases appear to be identical in clinical history; and in cases in which we should be practically

certain of finding Pfeiffer's bacillus if they occurred a few years back, we now find other organisms, especially the *Micrococcus catarrhalis*. In this uncertain state of bacteriology the results of an examination of the sputum are deprived of much of their value as a means of diagnosis, but the methods will be described, since more information is required, and this information the general practitioner is usually in the best situation to obtain.

*Methods.*—If possible, the sputum should be obtained in a method similar to that recommended in pneumonia, as it greatly facilitates the process and renders the results more trustworthy if the sputum comes directly from the lungs, and is not contaminated with bacteria from the mouth. The nasal secretion may also be examined, and frequently contains the organisms in pure culture and vast numbers; where the nose is affected, better results will be obtained in this way than from the sputum. The mucus may be collected on a diphtheria swab or on a platinum loop, or by means of one of the angled pipettes described on p. 110, though it is often too thick to be sucked up into such a narrow tube.

Films are prepared from the sputum by squeezing a small mass between two slides and sliding them apart. Dry and fix by heat. Two should be prepared. The first should be stained by Gram's method, and counterstained by dilute carbol fuchsin for a quarter of a minute, then washed, dried, and mounted. The other is to be stained more deeply with carbol fuchsin or Löffler's blue—about five minutes with gentle heat in either case. The influenza bacillus stains with difficulty, and may not be seen in the Gram's specimen which is lightly stained with fuchsin. And there is a good reason for not carrying the counterstaining too far in the former case, since if the carbol fuchsin is used for too long a time it may displace the violet stain of an organism which retains Gram.

The influenza bacillus is an extremely minute organism, and one which requires the highest powers of the microscope for its study. It is an extremely minute rod, and it would take from eight to sixteen of these rods to make up the diameter of a red blood-corpuscle. They occur in vast numbers in the sputum or nasal mucus, and are frequently found within the leucocytes, and when in this situation may appear to have a capsule, being contained in vacuoles in the protoplasm (Plate II., Fig. 3). They are often arranged in pairs, in which case they might be mistaken for small but unusually elongated pneumococci, but for the fact that they do not stain by Gram's method.

These features are sufficient to identify them for clinical purposes. Cultures are difficult to obtain, since the organism only grows in presence of hæmoglobin—*e.g.*, on agar tubes streaked with sterile blood (see p. 85). Under these circumstances they form very minute translucent colonies, much like those of the pneumococci, and cultures have a great tendency to die out.

The *M. catarrhalis* (Plate III., Fig. 5), the next most frequent cause of clinical influenza, is a diplococcus which does not stain by Gram, and which has a considerable amount of resemblance to the other two non-Gram-staining diplococci, the gonococcus and the meningococcus. It occurs in vast numbers in the sputum and nasal mucus of influenza, in the nasal mucus of a "common cold," and is a common cause of bronchitis of ordinary type. It is also an occasional cause of sore throat, and is not infrequently met with in the examination of supposed cases of diphtheria. The resemblance to the two other organisms named arises from the fact that it is frequently intracellular. There is not usually any difficulty in distinguishing between the three, owing to the difference in their habitat—the gonococcus affecting the mucous membrane of the urethra or cervix, the meningococcus the meninges, and the *M. catarrhalis* the nose, mouth, and respiratory passages. There are minute morphological differences between the three, and an expert can usually identify them in film preparations from the body, but where there is any question of the nature of the organism present cultures ought to be made. The *M. catarrhalis* is the only one of the three which will grow on gelatin at the room temperature.

## ANTHRAX

Anthrax occurs in man in three forms. The most common is *cutaneous anthrax*, or, as it is sometimes called, malignant pustule. *Pulmonary anthrax*, or wool-sorter's disease, is much rarer, and *intestinal anthrax* rarer still. The practitioner will find the greatest assistance from a bacteriological examination in the cutaneous form of the disease; he may search for the specific bacillus in the sputum in a supposed case of wool-sorter's disease, but he must be careful in his interpretation of his result, as bacilli which might be mistaken by an untrained observer, relying on the morphological appearances alone, sometimes occur in the sputum. The search for bacilli in the fæces in a supposed case of intestinal anthrax must be relegated to an expert.



The true nature of a case which is examined post-mortem can easily be determined bacteriologically; the cut surface of the liver or spleen should be rubbed upon a clean slide, and the films treated *secundum artem*. They will probably show the bacilli in large numbers. Sections may also be cut and stained by Gram's method (see p. 172).

In the later stages of any infection with anthrax the bacilli may be found in the blood. They may be apparent on examination of stained films, or by cultural methods similar to those used in the diagnosis of malignant pustule.

The anthrax bacillus varies considerably in length, but is always a large organism, and may be considerably longer than the diameter of a red blood-corpuscle. It is much thicker than the bacilli which have been dealt with hitherto, and it is invariably straight. The ends of these bacilli are cut sharply at right angles to the sides of the organism, and may be even somewhat concave; this is a most characteristic feature. The anthrax bacillus stains by Gram's method (Plate I., Fig. 4).

In cultures the appearances are somewhat different. Here the bacilli are frequently arranged in long chains which have an appearance which has been compared to that of a bamboo; chains occur in the blood or in the inflammatory exudate, but are usually much shorter than those seen in cultures. But the most important features in cultures of the anthrax bacillus is the development of *spores*, which are oval, highly refractile bodies, and lie in or near the centre of the bacilli, one in each. These spores are possessed of tough capsules, which resist the action of the ordinary stains much in the same way as the tubercle bacillus. Thus it happens that in films of a cultivation of the anthrax bacillus which have been stained with such a dye as weak methylene blue the spores are readily seen as colourless and refractile oval areas in the centre of the bacilli, the latter being stained blue. The spores themselves may be stained by a modification of the process used for the tubercle bacillus. The films are first stained by heated carbol fuchsin, which penetrates slowly through the capsule; they are then decolorized by a *very rapid* immersion in very dilute sulphuric acid (1 per cent.) or in methylated spirit, and examined microscopically. If the red colour has been entirely removed from the bacilli, but is still present in the spores, the films are ready to be counterstained by methylene blue; if not, they must be dipped in the acid or spirit once more and re-examined,

When this process is successful, the spores are stained red, and the bacilli blue (Plate I., Fig. 4).

The presence of spores enables us to isolate the bacilli from most of the organisms with which they are likely to be contaminated, by a very simple process. The spores resist the action of heat just as they resist stains, and for the same reason, and a suitable temperature will kill off all the non-sporing organisms and spare the spores. The latter may then be inoculated at a suitable temperature, and will develop into bacilli. This process, however, is not applicable to the examination of the blood or morbid effusions, as the bacillus of anthrax does not form spores in the living body. In this it differs from the tetanus bacillus, in which the process may be applied direct to the material from the body.

#### INVESTIGATION OF A SUPPOSED CASE OF MALIGNANT PUSTULE.

*Requisites.*—1. Several glass pipettes; if cultures are not required, one will be enough.

2. Clean slides and cover-glasses.

3. Bunsen burner or spirit-lamp.

4. Löffler's methylene blue; also the materials for Gram's staining.

5. Balsam.

6. Tubes of gelatin if cultivations have to be taken.

*Method.*—Break off the extreme tip of one of the glass pipettes and insert into one of the vesicles around the dark papule in the centre of the lesion; it may be necessary to make a puncture with a sterilized needle before this can be done. If the fluid does not rise spontaneously into the pipette, break off the other end and suck gently, watching the column of fluid so that it does not get into your mouth. It is safer to use a pipette with a wide mouthpiece plunged with cotton-wool (Fig. 14), or, best of all, to suck up the fluid by means of an india-rubber nipple.

Having obtained a drop or two of the fluid exudate, blow it out on to the surface of a clean slide and spread it out into a film; prepare as many of these as you can. Allow them to dry, and stain one with Löffler's blue and some by Gram's method.

Examine with the oil-immersion lens. Make a careful search over the films, looking for large cigarette-shaped bacilli, noting whether they are or are not arranged in chains. Examine the Gram specimens, and see whether the bacilli are to be seen in them also.

## INTERPRETATION OF RESULTS.

If the case is really one of malignant pustule, the chances are very greatly in favour of your finding the bacilli in large numbers, and the failure to do so tells strongly against a positive diagnosis.

*Cultural Methods.*—The fluid for examination is taken in exactly the same way as that described above, but the isolation of the organisms will be greatly facilitated if antiseptic methods are employed to prevent contamination with skin bacteria. To this end the surface of the lesion should be washed gently with carbolic or perchloride lotion, and then (very thoroughly) with alcohol or methylated spirit to remove the antiseptic. The surface is then allowed to dry.

If the material is to be transmitted to a pathologist for examina-

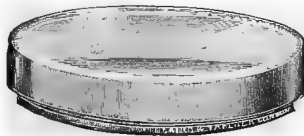

FIG. 19.—PETRI'S DISH.

tion (and this is the wisest course to adopt, as animal inoculations are almost necessary for the absolute identification of the bacillus), the fluid must be carefully sucked up into the bulb, and both ends of the pipette carefully sealed.

If the examination is to be made at home, the best way is to make two inoculations in gelatin. The first should be a stab culture, and may be made with the pipette direct; or the fluid may be blown out into a watch-glass or on to the surface of a slide (in either case sterilized by being heated in the flame and then allowed to cool), and the stab made by dipping the end of a straight platinum needle into the fluid, and then driving it into the gelatin.

The other culture is made with the pipette; this is driven into the gelatin in a tube and the contents blown out. The gelatin is then immersed in *warm* water until it is melted, and poured out into a Petri's dish (Fig. 19) previously sterilized by dry heat and allowed to cool.

Both cultures are incubated at a temperature of about 20° C.

In about two days the gelatin stab-tube will show a very

characteristic appearance if the anthrax bacilli are present in pure culture. The growth takes place in lines which project nearly at right angles to the line of inoculation, and grow more vigorously the nearer they are to the surface. The result is the development of a culture which has a strong resemblance to an inverted fir-tree (Fig. 20). In another day or two the gelatin will begin to show a certain amount of liquefaction, which begins at the surface.



FIG. 20.—STAB CULTURE OF ANTHRAX BACILLUS. (CROOKSHANK.)

The appearances in the plate culture are perhaps not quite so characteristic, but they are manifested in impure cultures. The young colonies of anthrax bacilli have a whorled appearance, which has been com-



FIG. 21.—YOUNG COLONY OF ANTHRAX BACILLUS ( $\times 15$ ). (CROOKSHANK.)

pared to a barrister's wig or to the head of Medusa (Fig. 21). The plate should be placed upon the stage of the microscope, and examined for these colonies with the low power. If one is found, a clean cover-glass should be pressed upon it, lifted up with a needle, so as to bring up the colony with it, fixed by heat, and stained with carbol thionin or methylene blue. The colonies are most characteristic after two days' incubation; at a later period the gelatin is liquefied and spores are formed.

A culture which presents these cultural and morphological appearances may be considered to be one of anthrax with almost absolute certainty, though other tests (notably animal tests) would be applied in a laboratory.

## TUBERCLE

The diagnosis of tuberculosis by bacteriological methods (in the case of most morbid exudates) is within the reach of every practitioner; cultural methods are not used, and the recognition of the bacillus is rapid, easy, and certain.

The bacilli may be sought for in sputum, urine, pus, fæces, or any other morbid material. We will first describe the method of staining which should be adopted, then the characters on which the recognition of the bacillus depends, and, lastly, the methods by which the films are prepared from the various materials.

## STAINING THE TUBERCLE BACILLUS.

*Requisites.*—1. Slides, cover-glasses, forceps, and balsam.

2. A Bunsen burner or spirit-lamp.

3. Dilute sulphuric acid—about 20 per cent.—contained in a wide-mouthed bottle or in a jar. This must be large enough to admit a slide, but not large enough to permit it to fall down to the bottom.

4. Carbol fuchsin.

5. Methylene blue. (Saturated watery solution or Löffler's blue.)

6. A metal (iron or copper) plate. The exact dimensions do not matter, but 8 by 4 by  $\frac{1}{8}$  inches is a convenient size. It should be mounted upon a tripod. This slab is not absolutely necessary, but it is a very great advantage.

*Method.*—We will suppose that the film has been prepared by one of the methods described subsequently, allowed to dry, and fixed by heat.

1. Place the slide upon the metal plate, and heat the latter by the flame. Flood the slide with carbol fuchsin, and let the heat continue until the stain steams, but do not allow it to dry up; let this go on for from three to five minutes. If the stain shows signs of drying up, add a little more; if it begins to boil, slide it along the plate away from the flame, or remove the latter for a short time.

If you have no metal plate, it is possible to hold the slide with a pair of forceps, but in this case the film is most conveniently made on a cover-glass.

Remember not to let the stain dry up.

2. Remove the slide from the plate with the forceps, and wash it under the tap or in a bowl of water.

3. Put it into the bottle containing the dilute acid. After three or four minutes withdraw it and again wash. If much pink colour comes back, re-insert it in the acid for a short time, and again wash. The process must be repeated until the film only shows a slight pink tinge.

4. Now apply the methylene blue for half a minute or so.

5. Wash, dry with blotting-paper, and then by gentle heat. Apply a drop of balsam, and cover.

*Another Method.*—Filter into a test-tube sufficient carbol fuchsin to flood the film, boil it over the Bunsen or spirit-lamp, and pour it on to the film whilst still boiling. Let it act until it is cool, when the bacilli will be found to be stained, and the process of decolorization may be proceeded with.

The times which are given above may be considerably shortened in practice, but I do not advise this until considerable skill is acquired. Bacilli are much more easy to recognize if they are deeply stained; this is the reason for the prolonged staining, which may appear unnecessary to some. The prolonged decolorization is an advantage, since it insures that the tubercle bacilli shall be the only things left stained red; if you leave the preparation in the acid for a short time, you are more likely to get crystals of carbol fuchsin, stain retained in deep scratches of the glass, etc., all of which a beginner may easily mistake for bacilli. The counterstaining with methylene blue may be shortened or omitted altogether, though this is not advisable, as it is then more difficult to focus the film.

#### RECOGNITION OF THE TUBERCLE BACILLUS.

The tubercle bacillus is about half as long as a red blood-corpuscle is wide, or rather longer, and is very slender. It is straight or slightly curved, and is variable both in shape and in size (Plate II., Fig. 2).

We recognize it by means of a staining reaction. Tubercle bacilli contain a considerable amount of fat, and this prevents them from staining readily with ordinary stains. In the process described above we used fuchsin, which is a very powerful stain, and added a mordant (carbolic acid), which increases its penetrative properties. Even with this staining is very slow, so that we heated the specimen.

The fat which prevents the bacilli from staining also prevents

the stain from being removed by such substances as acids and alcohol. In stage 3 of the above process we aim at allowing the acid to act until it has removed the fuchsin from everything except the tubercle bacilli. The methylene blue is a counter-stain, and colours all organisms, pus cells (especially their nuclei), epithelial cells, and shreds of lung-tissue—in fact, everything except the tubercle bacilli. The latter appear as slender red rods, which often show the irregular staining which has been described as occurring in the diphtheria bacillus.

Now, “acid-fast” bacilli are very rare, though they have been found in unexpected situations of late years. Only three such bacilli need be taken into consideration in dealing with human pathology. These are the tubercle bacillus, the leprosy bacillus, and the smegma bacillus. The bacillus of leprosy would rarely lead to mistakes in this country; it is recognized by the fact that it is straighter and more uniform than the tubercle bacillus, and by the fact that it resists decolorization more powerfully than the tubercle bacillus. The smegma bacillus may occur in the urine, and lead to mistakes unless the sample examined was drawn off *per catheter*. It is distinguished by the fact that it is readily decolorized by alcohol (absolute alcohol or methylated spirit), while the tubercle bacillus is not. In staining a film from the urine, we decolorize in spirit for a quarter of an hour after the acid and before the methylene blue—*i.e.*, between stages 3 and 4 in the above description.

In searching for the tubercle bacillus, the  $\frac{1}{8}$ -inch lens will serve, though an oil-immersion lens is an advantage.

#### METHOD OF COLLECTING THE SPUTUM.

This is of some importance, and the method recommended should be carried out in all cases.

Get the patient to wash out his mouth thoroughly with warm water before going to bed. Let him spit into a clean bottle, jar, or tin, and employ only the sputum coughed up before food is taken in the morning.

It is often impossible to get sputum from children, but in them it is often possible to pick masses of sputum out of the vomit and to demonstrate tubercle bacilli therein; and when no such masses are seen, bacilli may occasionally be found if the whole vomit be carbolized in the manner described subsequently and the sedi-

ment examined. In some cases in which there is no vomit it is occasionally justifiable to give an emetic for the purpose of securing sputum and establishing the diagnosis.

#### METHOD OF PREPARATION OF THE FILM.

*Sputum.*—Pour the sputum into a Petri dish or watch-glass, and place the vessel upon a dark surface. Examine it closely, looking out for small yellow particles; these consist of caseous material, and will probably contain tubercle bacilli in large numbers. The advantage of getting the patient to wash out his mouth and using only fasting sputum is obvious, for particles of food may present exactly the same appearance.

Having found such a mass, pick it out by means of a platinum loop or pair of forceps, and transfer it to the middle of a clean slide. Now place another slide on the top of the first, squeeze them together, and then slide them apart. You should get two good uniform films. Allow to dry spontaneously, and fix by heat.

If there are no caseous masses, pick out a mass of the sputum at random and proceed as before.

If no bacilli are found at the first examination, and you still suspect tubercle, proceed as follows: Half fill an ordinary medicine bottle with carbolic lotion (1 in 20), and add a drachm or two of the sputum. Shake thoroughly for a few minutes, and place the bottle where you can give it an occasional shake during the next few hours. Then pour the milky emulsion which results into a conical urine-glass, and allow it to stand for twelve hours or more. Remove some of the deposit which will form with a pipette, and spread it into a thin film on a slide. Dry and fix.

Another method which may be used in difficult cases is to digest the sputum with pepsin and HCl—a pinch of the former and sufficient of the latter to make the fluid faintly acid—in an incubator for a couple of hours, shaking occasionally, and then to boil the digested material to prevent further action. The result may be centrifugalized or allowed to deposit, and the sediment examined.

*Urine* may be centrifugalized or allowed to stand without previous addition, but better results are obtained if carbolic acid (liquefied or in crystals) is added to the urine in amount sufficient to convert it into a 1 in 20 solution. This is allowed to deposit or (better) is centrifugalized. Films are prepared from the deposit.



Remember that they should be left in alcohol for a quarter of an hour or so after staining.

*Pus* is best carbolized in the same way as sputum; if very thin it may be treated like urine. The tubercle bacilli will rarely be found in pus unless it is examined soon after the abscess is opened, but may be detected by inoculation experiments for long periods.

*Clear exudates* are more difficult to examine, and, as they usually contain bacilli in very small numbers only, a negative result should not be given too much weight. (For the best method to employ, see p. 121.) The examination is best made in a bacteriological laboratory, as decisive results can only be obtained by animal experiments. Collect the fluid in a bottle which has previously been boiled in water for half an hour and allowed to cool. Cork it with a cork which has also been boiled. Add no antiseptic, and forward it to the laboratory as soon as possible.

*Milk* may be examined in the same way as urine, films being made from the cream as well as from the deposit. These films are fixed, soaked in ether to remove fat, and again fixed. They are then stained as before, and it is advisable to pass them through alcohol.

The results obtained by this examination are somewhat uncertain, as some of the other acid-fast bacilli found in milk are almost exactly like the tubercle bacillus, and animal experiments are necessary for definite proof.

When *faeces* are to be examined, the best plan is to administer opium in amount sufficient to cause constipation. The surface of the scybalous motions which result are to be scraped off and stained in the usual way.

#### INTERPRETATION OF RESULTS.

The finding of tubercle bacilli in the sputum is conclusive evidence of tuberculosis of the lungs, but no information as to prognosis can be drawn from the numbers which are present; they may occur in great quantities in the sputum from patients who are doing well, and the author has found enormous numbers in the sputum of a person who had presented no symptoms of the disease for eight years, and was apparently cured. But a person in whom the bacilli are present is always in danger of a re-

crudescence of the disease, *and may be a source of infection*. Absence of the bacilli does not disprove the diagnosis of tuberculosis; bacilli do not appear in the sputum until the lung-tissue in which they occur breaks down, and are therefore absent in the early stages of acute tuberculosis.

In some cases of ordinary chronic phthisis bacilli may occur in the sputum in very scanty numbers, and may be missed unless a very careful search is made. Bacilli should not be considered as being absent until well-stained films have been examined for *at least* half an hour, and the examination repeated on several occasions. It is in these cases that the carbolic method of examination is so useful.

The finding of tubercle bacilli in the urine is practically absolute proof of tuberculosis of some part of the urinary tract, probably the kidneys or bladder. Absence of bacilli implies nothing unless the examination has been made very thoroughly and repeated several times at intervals. Then it affords *presumptive* evidence that the urinary passages are free from the disease.

The same is true of the examination of pus. Tubercle bacilli rarely occur in inflammatory exudates except in very small numbers, and can often only be demonstrated by animal experiments. If you examine pus from a chronic abscess and find no organisms of any kind, it is almost certain that the process is a tuberculous one, and the negative evidence obtained by the failure to find tubercle bacilli should not be allowed to carry much weight. The same is true for the clear exudates.

In suspected cases of tuberculosis, in which no infective material is forthcoming, there are two methods which may be used: (1) The estimation of the *opsonic index* (see p. 148), and (2) the use of Koch's old *tuberculin*. This is usually considered to be too dangerous for practical use, but if a small dose only be given ( $\frac{1}{200}$  c.c.), and if it is not employed on cases in which there is a mixed infection, I believe the danger to be practically nil. The tuberculin is sold in 1-c.c. bottles. For use, add the contents of one of these to 200 c.c. (about  $\frac{3}{4}$  vii.) of recently boiled and cooled normal saline solution. Mix well and inject 1 c.c. (m̄ xvii.) of the fluid hypodermically. In a positive case there will be a sharp reaction, the temperature rising to 103° or more, and remaining elevated for a day or so.

Information may also be obtained in some cases by a blood-

count or by cyto-diagnosis (see pp. 227 and 237). Calmette's *ophthalmo-reaction* may also be used, but is by no means devoid of danger.

## LEPROSY

The leprosy bacillus resembles that of tubercle, but it is somewhat straighter and more uniform. It occurs in leprosy lesions in great profusion, and its discovery does not present any difficulty. It has never been cultivated.

In a suspected case of leprosy films should be made from the nasal discharge, for the nasal cavities are very frequently affected. Indeed, it seems highly probable that the primary lesion through which the bacilli gain access to the body is in the nose in most cases. A small portion of one of the leprosy nodules may also be removed, and films made by rubbing the cut surface against a clean slide. If there is an ulcer, films may be made from the secretion from it.

Films should be stained by the method which we have recommended for the tubercle bacillus. If bacilli are present in large quantities, the case is almost certainly one of leprosy, for tubercle bacilli are never found in similar situations except in scanty numbers. If a doubt should arise as to the identity of the bacilli, advantage should be taken of the fact that the leprosy bacillus retains the fuchsin even more firmly than the tubercle bacillus when exposed to the action of an acid. A film from the suspected material should be spread at one end of the slide, and some sputum known to be rich in tubercle bacilli at the other; the whole should be stained by hot carbol fuchsin, and decolorized by being immersed bodily in 25 per cent. sulphuric acid for half an hour. If the tubercle bacilli are decolorized, any bacilli which have retained the red colour are almost certainly those of leprosy. If the tubercle bacilli are not decolorized, a fresh specimen should be prepared and immersed in the acid for a longer period.

## ACTINOMYCOSIS, OR STREPTOTHRICOSIS

Actinomyces is very closely allied to tuberculosis; the lesions appropriate to the two diseases are almost identical in histological appearance, and the granuloma which occurs in actinomyces goes on to fibrosis or to the formation of "cold abscesses" just as a tubercle may do. The formation of fibrous tissue is most

marked in cattle, and in them the disease is more chronic; suppuration is more common in man, and the disease runs a more rapid course.

The pus from an actinomycotic abscess is often viscid, and contains a greater or smaller number of small greenish, yellow, or brownish nodules. They are about as large as the head of a very small pin, and are quite opaque; under the low power of the microscope such a granule has a coarsely granular appearance, and looks something like a raspberry. If nodules presenting these appearances are found in any specimen of pus, whatever be its origin, a careful microscopic examination should be made to determine its nature. This is not difficult.

*Method.*—Place some of the pus which contains these granules on a clean slide, and press another slide upon it so as to crush the granules; dry, fix, and stain by Gram's method. Do not counter-stain.

Tumours removed or incised at an operation, or organs removed at a post-mortem examination, should have their cut surfaces rubbed upon the surface of a slide, and the film thus obtained treated in a similar way; or they may be scraped, and the scrapings spread on a slide. Sections may also be cut, but are not usually necessary for the diagnosis.

#### EXAMINATION OF THE SPECIMENS.

Actinomycosis of cattle is caused by the ray fungus, an organism which derives its name from the star-shaped colonies which it forms whilst growing in the tissues. It consists of two chief parts; the central portion of the colony is formed of a network of narrow filaments, which have a radial arrangement at the periphery (Plate II., Fig. 6). In this part small bodies which have the appearance of cocci may often be seen. The outer zone consists of the clubs which (when present) are so characteristic. These clubs are flask-shaped expansions of the sheath of the radial filaments already mentioned, and are arranged with their narrow extremities pointing inwards. They are not generally present in man, and when present are often badly developed; they are much more common and more perfect in the ox, where the disease is more chronic and pus-formation rare.

The reason for this is, perhaps, partly that man is less resistant against the organism, but probably the chief factor is the difference

in the fungus present. The organism in bovine actinomycosis is the ray fungus, which is described above; but in man there are numerous species of fungus which can bring about infection and cause the disease known clinically as actinomycosis: this disease is therefore not a specific entity, due to a single cause, but a group of allied diseases, just as suppuration is. The organisms in question are all members of the genus *Streptothrix*, and consist of long filaments of mycelium, which differ from the bacteria in showing true branching and in breaking up into "chain spores," resembling chains of cocci. The different species vary very greatly in cultural characters, but there are also marked differences in the appearances met with in films of pus, etc. In what may be regarded as typical cases, the nodules described above, when flattened out and stained by Gram's method, show a central portion consisting of a tangled mass of narrow mycelial threads, some of which may show the degeneration into chain-spores, and look like streptococci, whilst there may or may not be a peripheral portion showing a radial arrangement (Plate II., Fig. 6, which was drawn from a remarkably perfect specimen). These colonies vary greatly in size, but do not usually fill up more than half the field of an oil-immersion lens, so that it is best to search for them in Gram specimens (not counterstained) with a low power, and to turn successively the  $\frac{1}{6}$  and  $\frac{1}{12}$  on to any small violet masses which may be seen. In other cases the fungus will assume the form of threads in masses without any definite arrangement, and in others the threads will be isolated; in either case it will usually be possible to find threads showing true branching or chain spores, and this is sufficient for the diagnosis. In yet others the bulk of the mycelium splits up into short lengths greatly resembling bacilli, and when this happens the diagnosis may be missed unless a careful search happens to reveal an unbroken piece of mycelium (Plate IV., Fig. 1).

Cultures are usually difficult to prepare, and are not much help in the diagnosis.

The importance of making this examination as a routine method in all cases in which the diagnosis is not absolutely clear must be strongly urged on all practitioners, since an accurate diagnosis of actinomycosis may be followed in many cases by a cure by means of large doses of iodide of potassium. Actinomycosis has a habit of turning up when least expected; thus, I have found it accidentally in three cases in the sputum where the true diagnosis

was not suspected; once in an enlarged tonsil; once in an apparently typical case of cancer of the breast, etc.

The films should be carefully examined for the presence of these structures. Clubs are not likely to be found in the pus, and their absence does not tell against the diagnosis; the dense felted network of filaments retaining Gram's stain is what is to be looked for, and its presence is quite sufficient for a diagnosis. Fortunate specimens may show a complete colony, with its irregular network in the centre and the radial arrangement of the fibres on the periphery, or there may be mere fragments of mycelium.

## GLANDERS

Glanders is one of the infective granulomata, and is closely allied to tuberculosis; it differs, however, in running a more rapid course and in the greater tendency which the specific lesions exhibit to undergo suppuration. It is caused by the *B. mallei*, an organism which is nearly as long as the tubercle bacillus, and decidedly thicker. It stains readily with all stains, and is easily decolorized; it loses its stain when treated by Gram's method, and does not form spores.

The bacteriological diagnosis of the disease is not easy, and should be referred to a bacteriologist. A quantity of the discharge from a suspected case should be taken with aseptic precautions, and transmitted as soon as possible in a test-tube or bottle which has been sterilized by dry heat or by boiling. Pus had better be sent in a pipette.

Where abscesses are opened, cultures taken direct from the pus may possibly contain the bacillus in pure culture. In this case it may be identified by the characters of its growth upon potato. The colonies have the colour and appearance of honey at first; they grow very rapidly, coalesce, and the potato is soon covered with a moist-looking film, which afterwards becomes brown, the surface of the medium in the neighbourhood becoming greenish-brown. If cultures from pus grown on potato exhibit these appearances, and contain a short and thick bacillus which does not stain by Gram's method, the case may be diagnosed as being probably one of glanders, even although the culture be not a pure one.

## TYPHOID FEVER

Typhoid fever is caused by a bacillus which is variable in length, though usually short (about half as long as a tubercle bacillus) and thick, its length being only about three times its breadth; very long forms also occur, but in small numbers. It does not form spores, and it does not stain by Gram's method. It is actively motile; when a culture of the organism in a fluid medium is examined under the microscope, the bacilli can be seen darting rapidly about in all directions. The bacillus owes its motility to the possession of a large number of long, wavy flagella, which can only be seen after special and difficult staining processes.

The *B. coli communis*, the most plentiful organism of the intestine in man and animals, bears a very close resemblance to the typhoid bacillus, and can only be distinguished therefrom by the application of several cultural and chemical tests, the performance of which takes a considerable amount of time. This renders it very difficult to diagnose typhoid fever by methods similar to those which are in use for the other diseases mentioned—*i.e.*, by the demonstration of the specific organism. Suppose, for instance, that we were to attempt to determine the nature of a case of diarrhoea by a search for the typhoid bacillus in the stools. For every typhoid bacillus which we should encounter we should find a great many colon bacilli, and we should only be able to distinguish the one from the other by a prolonged and careful examination of pure cultures. It is quite certain that the disease *might* be diagnosed in this way; indeed, it has been done, but the task is an extremely difficult one, and the diagnosis would be delayed for a considerable period.\*

In other regions in which the typhoid bacillus occurs during an attack of typhoid fever the search is usually facilitated by the absence of other organisms, especially by the absence of the *B. coli*. The specific bacillus occurs in the blood, spleen, spots, mesenteric glands, liver, and frequently in the urine.

It may often be demonstrated in the *blood*, and the method is now acquiring some importance from the fact that positive results are found to be very frequent if the examination is made *early* in

\* Modern methods have greatly facilitated the task, but even now it is only used when other methods are unavailable, or for certain special purposes.

the disease—*i.e.*, within the first week. Thus it is available before the Widal reaction appears, and should be used wherever a positive diagnosis is required at a very early date. The blood is drawn direct from a vein by one of the methods described on p. 144, and at least 5 c.c. should be taken, whilst 10 c.c. gives a greater probability of a successful result. The best culture medium to employ is broth to which .5 to 1 per cent. of sodium citrate has been added; this prevents the coagulation of the blood and the consequent entanglement of the bacilli in the clot, which, when it occurs, greatly delays the appearance of the growth. The amount of blood indicated above should be inoculated into 100 c.c. of citrated broth and incubated at 37° C. Growth will probably be seen in twenty-four hours or less. Unfortunately, typhoid bacilli fresh from the body often fail to agglutinate with typhoid serum, and only acquire that property after cultivation for several generations on artificial media: this, the best test, is not always conclusive. But all cases clinically resembling early typhoid which give a culture of motile, non-sporulating, Gram-negative bacilli of the morphological characters described above, should be regarded as early typhoid, and in all probability the appearance of the Widal reaction will soon settle the matter. The other possible diagnoses are extremely unlikely. The further identification of the bacillus is a matter of some difficulty for which expert help should be obtained, or one of the larger manuals of bacteriology consulted.

The mesenteric glands and liver are, of course, not available for the purpose of diagnosis.

The demonstration of the bacilli in the urine is sometimes quite easy, and might be of some diagnostic value. But they do not always occur in this excretion, and the *B. coli* often does so, and it is not easy to distinguish between the two.

The only way in which typhoid fever can be diagnosed with ease and certainty by a demonstration of the specific bacillus is by an examination of material drawn directly from the spleen by means of a hypodermic needle. The organism occurs *constantly* in this situation, and its demonstration is not difficult. The necessary operation, however, is by no means devoid of risk, and is now generally abandoned.

This brings us to the method in which typhoid fever is now usually diagnosed by the bacteriologist—Widal's reaction. This



reaction is a special example of a general law which was discovered by Durham and others, and which is to the effect that the blood-serum of a person who has been through an attack of a bacterial disease will cause the specific-organism of that disease to collect into clumps. For instance, if we take a broth culture of the vibrio of Asiatic cholera (which is turbid and opalescent) and add to it a small quantity of blood-serum from a patient who has recovered from an attack of cholera, we shall find that the culture becomes clear, a sediment collecting at the bottom of the tube; and if we examine this sediment we shall find that it consists of felted masses of the vibrios. This reaction is a general one, and is given in most, if not all, bacterial diseases. But Widal, Grünbaum, and others, working independently about the same time showed that, whereas in many diseases it is a reaction of *immunity* (*i.e.*, does not occur until late in or after the disease), in typhoid fever it is a reaction of *infection*, and occurs so early in the course of the disease that it is of great value in diagnosis.

The test is applied by adding a small quantity of the serum from the patient suspected to be suffering from the disease to a larger amount of a young culture of typhoid bacilli, and watching whether the appearance of the culture undergoes any change: it may be watched under the microscope or by the naked eye, the technique differing in the two cases. The *microscopic method* is rapid and requires a very small amount of blood, and is now generally used. The *macroscopic method* is perhaps somewhat easier for a beginner, but it takes a longer time and requires a large amount of blood-serum.

The technique in either case is readily learnt, and can be carried out with very little difficulty if the materials are at hand. But the test is one which it is seldom advisable for the homoeopath to attempt, as it requires a young culture of typhoid bacilli. We shall, however, describe the process, as some may carry it out during an epidemic, or if they are living where they have not access to a public laboratory. The process has now been greatly facilitated by the demonstration of the fact (by Widal) that the reaction is given with dead cultures of the bacilli. These cultures can be obtained from any bacteriological laboratory and will keep. They are prepared by adding 4 or 5 c.c. of the following fluid to an eighteen-hours-old culture of typhoid bacilli, scraping off the growth, pipetting the emulsion into

sterile test-tube, and heating to 60° C. for half an-hour to ensure sterility :

Normal saline solution (0·8 per cent.)	450 c.c.
Carbolic acid (liquefied)	1·25 c.c.
Glycerin -	50 c.c.

Boil and allow to cool immediately before use.\*

The bacilli gradually separate from an emulsion prepared in this way, but are distributed throughout the fluid by shaking. With a supply of this culture at hand the practitioner can apply the test at home without difficulty.

Collect the blood from the ear, as described on p. 34, taking care to get a Wright's pipette about half full. The test may be applied to a dry drop of blood, but in this case there is no possibility of making an accurate dilution, and unless a fair quantity of serum is at hand it is impossible to perform the test by the macroscopic method.

If a pipette is not at hand, it is easy to manufacture one out of any piece of glass tubing which may be available.

#### METHOD OF PERFORMING WIDAL'S REACTION BY THE MICROSCOPIC METHOD.

*Requisites.*—1. A young culture (not more than eighteen hours old) of typhoid bacilli on agar.

Where dead bacilli are to be used, this is to be replaced by a culture obtained from the laboratory and prepared in the manner described.

2. A small funnel provided with a double thickness of white filter-paper. This is unnecessary if dead cultures are to be used.

3. Three clean watch-glasses.

4. A platinum loop. This should be made of fine wire and have a loop (which must be completely closed) about  $\frac{1}{10}$  inch in diameter.

5. A hollow-ground slide. This is an ordinary slide having a well about  $\frac{1}{2}$  inch in diameter sunk in its centre. If it is not at hand a cell may be built up on an ordinary slide. Take a piece of thin card 1 inch square and cut out a square  $\frac{1}{2}$  inch in diameter from its centre. Fix this perforated square down on to the slide with vaseline or immersion oil.

\* J. H. Borden, *Proc. N. Y. Path. Soc.*, 1904.

6. Thin cover-glasses.

7. The microscope. The test can be carried out quite well with a  $\frac{1}{8}$ -inch lens.

*Process—1. Making the Emulsion.*—Pour a small quantity of tap-water into the culture-tube, or, better, scrape off some of the growth and mix it with some water in a watch-glass. In either case stir it round with the platinum needle for a few minutes, so that the bacilli are evenly distributed throughout the water and form an emulsion.

Next take the hollow-ground slide and paint a ring of immersion oil round the well (Fig. 22, *b*). If you are using a built-up cell,

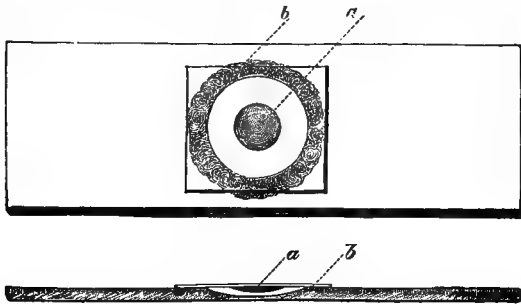

FIG. 22. —HANGING-DROP PREPARATION. (CROOKSHANK.)

paint the top of the card with the oil. In either case vaseline may be used.

Place a drop of the emulsion on a clean dry cover-glass, and invert the hollow-ground slide over it; press it down so that the oil round the well adheres to the cover-glass; now invert the slide, and you will have a *hanging-drop* specimen. The bacilli will be contained in the droplet of water (Fig. 22, *a*) which hangs from the lower surface of the cover-glass: this will not dry it up if the seal made by the oil is perfect.

Place the specimen under the microscope and examine it with the low power, using the fine adjustment and stopping down the diaphragm. Focus until the surface of the cover-glass is distinctly seen, and then move the slide about until the edge of the hanging-drop runs across the centre of the field. Then turn on the  $\frac{1}{8}$ -inch lens and open and shut the diaphragm until the field is faintly illuminated; the exact amount of light required can only be learnt by experience.

Now focus up and down *very carefully*, using the fine adjustment,

until you see a line running across the field and dividing it into a lighter and a slightly darker portion. This is the edge of the drop. Focus a little deeper; you should see numerous small unstained bacilli, and if these are not visible it probably indicates that the illumination is not right. Open and shut the diaphragm, keeping a sharp look-out down the microscope all the time. It may help matters to lower the condenser for a short distance.

Having obtained a clear view of the bacilli, examine them for motility and absence of clumps, and see whether they are present in proper proportion to the amount of fluid.

If the culture is in good condition, the bacilli should be seen darting about in all directions; but if the movement is but sluggish, the reaction may still be obtained. If the specimen is kept for a short time in a warm place or in the incubator, the movements will usually become more rapid. It is hardly necessary to say that when dead cultures are used there will be no movements of translation, though the bacilli may show oscillatory (Brownian) movements.

The specimen must be searched thoroughly for clumps of bacilli, and if these are present the emulsion must be filtered through a double thickness of white filter-paper. This examination for clumps is a most important part of the process, and must be attended to whether dead or living cultures are in use.

Next see that the emulsion is neither too thin nor too thick. No definite rules can be given, but if there are very few bacilli in the field a further supply of growth must be added to the stock of emulsion, and a further specimen examined. If the bacilli are thickly crowded together, the emulsion must be diluted with a little water and re-examined.

When you are satisfied that the emulsion is right, slide off the cover-glass and drop it into some antiseptic lotion; of course, this is unnecessary if dead cultures are used.

2. *Making the Dilution.*—You are now about to dilute a drop of the serum from the patient with a known multiple (in this case thirty times) of its bulk of the emulsion which you have just prepared. To do so you will take advantage of the fact that the platinum loop, if dipped into a fluid and pressed against a surface, so that every part of the loop touches that surface, will deposit a drop of fluid of definite size. You are about to mix one loopful of the serum with twenty-nine loopfuls of the emulsion just prepared and examined.

Blow the blood from the pipette out on to a watch-glass (to do this it will be necessary to break the tip of the pipette), and tilt the latter so that the serum flows away from the coagulum. Now take a loopful of the serum and place it on another watch-glass, taking care to put the loop flat on the surface of the glass; this is done more easily if the wire is slightly bent, or if a flat side is used instead of the watch-glass.

Next heat the platinum loop in the flame; this is to burn off any blood which might remain on it and contaminate the emulsion. Take up a loopful of the emulsion, and place it on the watch-glass by the side of the drop of serum, but not touching it. Repeat this until you have placed twenty-nine drops of emulsion round the

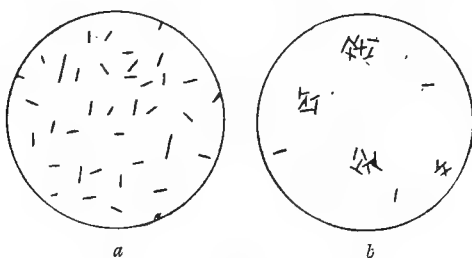

FIG. 23.

*a*, Negative Widal's reaction; *b*, positive Widal's reaction.

serum. Mix the whole together by stirring them thoroughly with the platinum loop, place a droplet of the mixture on a clean cover-glass, making a hanging-drop specimen, and examine as before.

If the blood comes from a case of typhoid fever (with certain restrictions which will be discussed below), the microscopic appearances will be quite different from those seen in the drop of emulsion which was previously examined. The bacilli will no longer swim about rapidly in all directions; they will become paralyzed, and remain quite motionless. Further, they will collect into clumps, each clump consisting of a larger or smaller number of bacilli, arranged in a felted network, resembling that seen in a heap of "spellicans" (Fig. 23, *b*). This is the complete positive reaction; it consists of two parts, clumping and paralysis, and is given *only* (in the dilution used) by the blood of a patient who is suffering or who has suffered from typhoid fever. If this is not the case, the bacilli will continue to move about just as before, and will not collect into clumps.

In the process which has been described above, the blood has been diluted to thirty times its volume, and this is the best dilution to use for diagnostic purposes. But the reaction is given earlier if a lesser dilution (one in ten) is used, though there is then a greater chance of fallacy.

Sometimes the reaction takes place almost as soon as the serum is added. At other times it is delayed, and for these it is necessary to fix a time limit. With a dilution of 1 in 30, one hour is a safe time-limit to adopt, and if the reaction takes place after this the result should be looked upon with great suspicion, and the test reapplied after a day or two.

Exactly similar processes are carried out if dead cultures of typhoid bacilli are used, but here the emulsion should be sent out from the laboratory free from clumps, and containing exactly the right number of bacilli, so as to be ready for immediate use. But the practitioner is urged not to trust to such an emulsion without making a hanging-drop, and examining it just before making the test.

If dead cultures are used, it is advisable to use a rather less degree of dilution than in the above process. A dilution of 1 in 20 will answer perfectly. The time-limit is the same.

#### INTERPRETATION OF RESULTS.

A *positive* result may mean :

1. That the patient is suffering from typhoid fever.
2. That he has suffered from typhoid fever within a certain period before the blood was taken. The hypothetical substance which we believe to be the cause of the reaction (agglutinin) continues to be formed, or remains in the blood, for some time after complete convalescence from typhoid fever; the reaction has been known to persist for seven or eight years, and probably usually does so for about two. This fact must be remembered in interpreting the results obtained from Widal's test. If the patient has suffered from typhoid fever, or from an obscure illness, which might possibly have been typhoid fever, a year or two previously, the positive reaction should be regarded with suspicion.

In such cases the test should be carried out so that the smallest dilution which will cause clumping can be ascertained, and the test repeated in two or three days. If, for instance, we found

that the blood clumps only in a dilution of 1 in 20 on one day, and in a dilution of 1 in 100 three days later, this affords a certain proof that the reaction is due to a present attack of typhoid fever, and is not due to one which took place at a previous date. This investigation should be entrusted to an expert bacteriologist, and plenty of blood sent on each occasion.

A *negative* result may mean :

1. That the patient is not suffering from typhoid fever.
2. That he is suffering from typhoid fever, but the date is too early for the appearance of the reaction. The reaction sometimes occurs on the fifth or sixth day, usually after the tenth day, and in all but a very small number of cases before the end of the second week. If the onset of the disease (as far as it can be fixed) is less than this, the examination should be repeated after two or three days.
3. In a very small number of cases the reaction is delayed still further, and if the patient dies may not occur at all. These cases are usually severe ones, and do not present any difficulty in diagnosis. Sometimes the reaction is delayed well into the convalescence in mild attacks, but this is exceedingly rare.

#### MACROSCOPIC METHOD.

The macroscopic method can be carried out with a young living culture on agar, or with an emulsion of dead bacilli. The technique is not so difficult as in the previous process, and no apparatus is required other than a piece of narrow glass tubing, from which to make pipettes.

*Requisites.*—1. A young culture on agar, and some normal saline solution ; or a dead emulsion of typhoid bacilli.

2. Special glass pipettes. These are to be made from a piece of glass tubing which should not be more than  $\frac{1}{8}$  inch in internal diameter and about 10 inches long. The central 2 inches of this tube are to be heated in a flat gas flame until thoroughly softened, then withdrawn, and then the two ends are to be drawn steadily apart. The softened portion is to be drawn out into a long, narrow portion (rather thicker than a vaccine-tube) about 6 inches long and of nearly uniform diameter. The full diameter of the tube should pass *rapidly* into this narrow portion ; it should not taper gradually (Fig. 14, c). The two pipettes thus obtained are to be broken apart, leaving about 3 inches of the narrow tubing attached to each. The wide end of the tube is to be plugged fairly firmly

with cotton-wool. This serves a double purpose: it prevents any of the fluid from getting into the mouth, and it offers a certain amount of resistance to the escape of the fluid, and thus renders the pipettes more easy to fill.

*Process.*—Prepare an emulsion just as before, making a drachm or so, and filtering it. An emulsion of dead bacilli obtained from a laboratory should be ready for immediate use. Insert the tip of the pipette into the blood-serum (of which there should be several drops), and aspirate it gently into the tube, avoiding air-bubbles; if these gain access, blow out the serum and begin again. It is easier to see what you are doing if you use a piece of indiarubber tubing (such as is used with a hæmocytometer) through which to apply suction.

Having drawn up enough serum to form a column about 2 inches in length in the narrow portion of the tube, lay the pipette on its side, and make a mark with ink or with a grease pencil to show how high the serum reaches. Now suck the column of fluid a little way into the tube, and insert the tip of the pipette into the emulsion; suck the latter up the tube until it reaches to the mark. This will give you the same amount of emulsion as of blood-serum; the two fluids will be separated by a short column of air. Now withdraw the tip for a moment and suck up another small quantity of air; dip it into the emulsion and suck it up to the mark again. This will give you twice the amount of emulsion as of blood-serum, the three portions of fluid being separated by air (Fig. 24). Repeat this process until you have nine times the amount of emulsion as of serum; then suck the fluid still further from the tip of the pipette, and seal the latter in a flame. Probably by this time the fluids will have mixed together; if not, tap the tube gently (holding it upright) until the air-bubbles which you have sucked up make their escape and the fluid forms a continuous column.

Fill another tube to a similar height with emulsion (for a control), and place the two side by side in an upright position for twelve hours.

Now examine the fluid in the pipettes. If the emulsion has been made from a living culture, the control pipette (*i.e.*, that to which no blood has been added) will probably remain turbid; if an emulsion of dead bacilli has been used, it will have become clear, and the bacilli will form a uniform, even layer at the bottom of the pipette.



Compare the control-tube with the pipette to which blood has been added. If the reaction is negative, the appearances will be exactly the same in each ; but if the reaction is positive, the bacilli will fall to the bottom in flocculent granular masses, which are similar whether living or dead bacilli have been used. In the former case there is no difficulty in determining whether the reaction is present or absent, for the fluid will be clear if it is positive, turbid if it is negative (Fig. 25). The dead emulsion presents more difficulties ; you have to compare the granular deposit which occurs in a positive reaction with the more uniform deposit which occurs in the control-tube. If there is any doubt, the best plan is to break off the tip of the pipette and blow out some of the deposit ; examine it under the microscope after applying a cover-glass. In a positive case the bacilli will be seen to be collected into clumps ; in a negative case they will remain discrete.

This process is a modification of that described by Wright (*Brit. Med. Journ.*, p. 355, 1898), to which the reader is referred for fuller details.

It is advisable to use a dilution of 1 in 20 if the macroscopic method is used.

I now use dead cultures almost exclusively in routine work. They are always ready, and they do not vary in sensitiveness as living cultures do. The method I now use is simplicity itself, and is specially suited for general practitioners, since it requires absolutely no manipulative skill and gives absolutely accurate results.

The method is, briefly, as follows : I prepare a number of small



FIG. 24.—SHOWING METHOD OF FILLING PIPETTE.

*a* is the mark on the tube ; *b*, the serum ; *c, c, c*, the columns of emulsion, separated by the air-bubbles, *d, d, d* ; *e* is the cotton-wool plug.

sedimentation-tubes containing a definite bulk of killed typhoid emulsion and sealed at each end; each tube also contains a small amount of mercury. Accompanying each of these tubes there is a short length of capillary tubing (about 1 inch long); this will hold a definite fraction ( $\frac{1}{8}$ ,  $\frac{1}{16}$ ,  $\frac{1}{32}$ , etc., according to requirements) of the amount of emulsion in the sealed tubes. To use them, collect the blood in the ordinary way in a Wright's blood capsule, pipette, etc., and let it coagulate. It is necessary to get clear serum for the test, but it is usually quite easy to do this, even

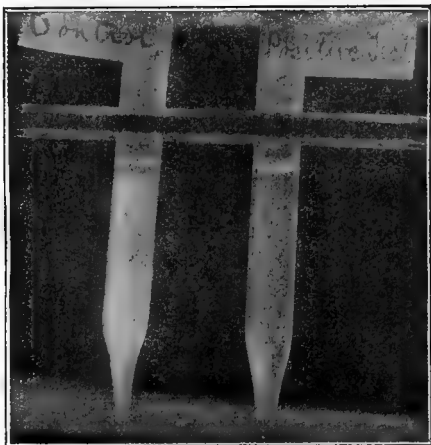

FIG. 25.—POSITIVE AND NEGATIVE WIDAL'S REACTION: MACROSCOPIC METHOD.

The fluid in the left-hand pipette (negative) is still turbid. The right-hand pipette (positive) contains clear fluid, and has a sediment at the bottom. The lower portions of the pipette have been removed.

without a centrifuge. File and break the pipette so that the serum is exposed; then take the capillary tube and touch the surface of the serum, which will ascend the tube and just fill it. File and break off the tip of the sedimentation-tube (at *b*, Fig. 26), drop in the capillary tube full of serum, reseal the tip of the tube, and allow it to cool. When cold, shake it violently for half a minute (when the mercury will act as a stirrer), and put it to stand in a vertical position. The whole process takes about two minutes, and is about as easy as testing for albumin. In positive cases the first indication of a reaction may be seen in about an hour, and it is usually complete in four or five. The fluid first

shows a slight granularity, which becomes more and more marked, minute greyish flocculi separating themselves from the uniformly turbid emulsion. These flocculi gradually get bigger and settle slowly at the bottom of the tube, leaving the supernatant fluid almost clear. The emulsion will settle by itself, but very slowly, and falls as a powdery deposit quite different from the flocculi. An unused sedimentation-tube (shaken immediately before use) is put side by side with the one containing the serum, and used as a control ; the two are inspected from time to time, and if there is

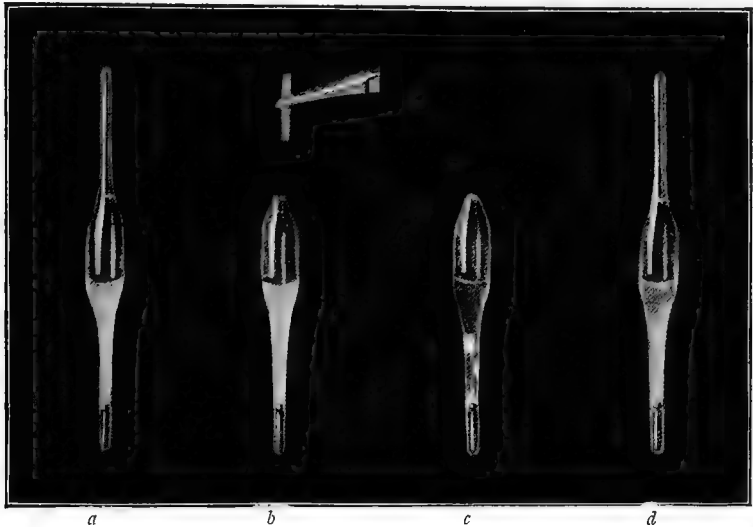

FIG. 26.

- a*, Tube containing emulsion of dead typhoid bacilli and globule of mercury ;  
*b*, showing method of inserting the serum in a short length of capillary tubing ; *c*, a positive reaction ; *d*, the control.

no obvious difference in five or six hours the reaction is absent. The presence of the reaction in a dilution of 1 in 20 is fairly definite proof of infection.

The tubes are a little trouble to prepare, but a stock sufficient to last for months may be made at the same time. Prepare the typhoid emulsion in the method already described (p. 72). Next prepare some tubes of the shape shown on Fig. 26, sterilize them by dry heat, and place a globule of mercury in each. Then prepare a couple of Wright's pipettes out of a

piece of glass tubing about as thick as a lead-pencil and about 4 inches long. This is done by holding the tube between the finger and thumb at each end and softening it thoroughly in a blowpipe or Bunsen flame, rolling it round and round the while. When the central inch or more is quite plastic, the tube is removed from the flame and the two ends drawn slowly apart with a steady, uniform pull, and held apart until the glass is quite set. If this is quite successful, the softened portion should be pulled out into a tube about as wide as a steel knitting-needle, fairly uniform in diameter, and if possible 2 feet long: this will make two pipettes each a foot long. To separate them, melt the central portion in a very small flame (such as that of a wax vesta), and pull them apart rather quickly. If the capillary portion of your tube is much less than 2 feet long it will only serve for one pipette, and the place where it is melted must be close to one end. In either case the result should be a pipette like that in Fig. 36.

The most important part of the pipette is the tip, which is represented, magnified three or four times, below the pipette. It must narrow somewhat suddenly into a *very fine* capillary tube about  $\frac{1}{8}$  inch long, so as to oppose a considerable amount of friction to the movement of a column of fluid in the tube. If the point is a good one, you will have absolute control over the column, and will be able to suck it up to a given point by means of the india-rubber nipple with absolute precision. If the capillary tip is too narrow or too wide, draw it out again until you have one that is entirely satisfactory.

This is now graduated into equal parts in the simple and accurate method invented by Wright. Take a few drops of mercury in a short test-tube, and cover it with a little water. Put a mark with a grease pencil or with pen and ink on the pipette about 1 inch from the tip: this is for the unit. Then take the nipple between the thumb and finger of the right hand, squeeze it, insert the tip in the mercury, and suck up the latter exactly to the mark. Then withdraw the tip from the mercury into the water and suck that up to the mark; the mercury will rise in front of it. When this is done, replunge the tip into the mercury and suck up a second column. Repeat this process until you have filled the tube with alternate layers of mercury and water, each of exactly the same bulk (Fig. 27). When this is done, remove the tube from the fluid and place it flat down on the table, still keeping sufficient pressure on the nipple to retain the fluids

in the same place, so that the junction of the lowest two columns corresponds exactly to the unit mark. Then get a second person to make an ink or grease-pencil mark at the junction of each of the columns. Expel the fluids, and you will have a Wright's pipette graduated into equal parts.

If you cannot suck up enough alternating layers to fill the tube, suck up as many as you can, remove the pipette, and mark it as before. Then relax the pressure so that the whole column is drawn upward, and adjust it until the lowest column just coincides with the uppermost mark you have just made, and the rest of the

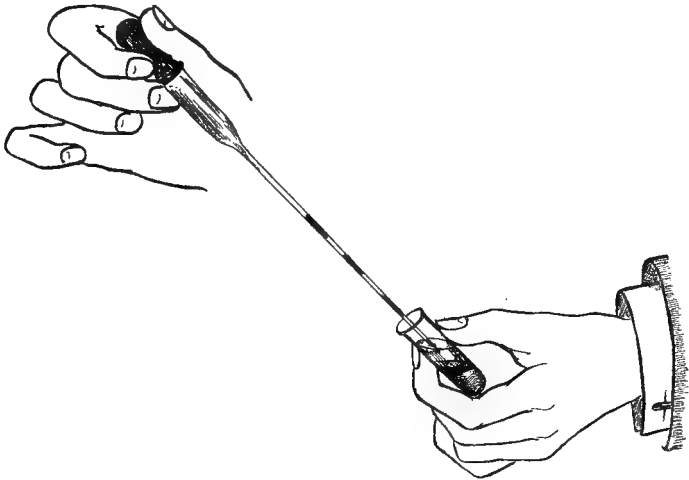

FIG. 27.—SHOWING METHOD OF GRADUATING A WRIGHT'S PIPETTE IN EQUAL PARTS.

column extends into the ungraduated part of the tube; make marks against the intersections as before.

Now proceed to put the emulsion into the sedimenting-tubes with the mercury. If you wish to prepare tubes to give you a dilution of 1 in 20 (and this is the most convenient for general work), put as much as will fill nineteen divisions of the pipette, sucking it up into the pipette by using an indiarubber nipple. If (as is likely) your pipette does not hold 19 units, it will be necessary to take two or more pipettes full—say 10 and 9 units respectively. Then seal the open end of the sedimenting-tube in the flame, and heat the whole to 60° C. for half an hour to insure sterility.

Lastly, cut the pipette up into lengths by notching it with a file

opposite the marks. This will give you a series of short capillary tubes each holding  $\frac{1}{10}$  of the volume of the typhoid emulsion in the pipettes. These are to be used for the serum, as already described.

## GONORRHŒA

Nothing is more certain than the fact that gonorrhœa can only be diagnosed by bacteriological methods; and every practitioner is very strongly urged to practise himself in these methods and to employ them in *all* cases. Leaving out of account the confidence which the certainty of a direct diagnosis inspires, there is always the possibility that legal questions may arise, and a practitioner who made a diagnosis of gonorrhœa without employing the only means by which that disease can be diagnosed would make a poor show in cross-examination. Lastly, a bacteriological examination will often tell us that the disease is merely lying latent and is still infective when apparently cured; but not the reverse, for it is not safe to assume that the disease is cured because no gonococci are found.

The gonococcus chiefly affects mucous surfaces: the urethra in the male, the urethra and cervix uteri in the female, and the conjunctiva in both sexes. These are the regions in which the primary lesion usually occurs, and it may extend by continuity to more distant parts.

In the male it may involve the prostate, the vesiculæ seminales, and the bladder. It is doubtful whether gonorrhœal epididymitis is due to this organism or to another.

In the female the inflammation of the urethra may extend to the bladder. The inflammation of the cervix may extend to the mucosa of the uterus, and thence to the Fallopian tubes (causing pyosalpinx), to the mouths of the tubes (causing local adhesive peritonitis, which probably results in sterility), or to the peritoneum, where it may cause general peritonitis.

The gonococcus may escape into the blood from any of these lesions, and the results of this occurrence are arthritis, ulcerative endocarditis, or meningitis; the two latter are rare.

The search for the gonococcus may have to be made: (1) in urethral pus from either sex; (2) in pus from the cervix uteri; (3) in pus from the conjunctiva; (4) in pus from the meninges, tubes, peritoneum, or other region, whether removed by operative measures or at a post-mortem examination; (5) in the blood; or

(6) in the urine. It is to be noticed that the gonococcus rarely, if ever, attacks the vagina, except in young children, and that in cases of vaginitis the cervical secretion should be examined.

In the vast majority of cases cultural examinations are quite unnecessary. This is fortunate, for the gonococcus does not grow readily on artificial media. It requires for its cultivation the presence of hæmoglobin, and in practice the simplest method (should cultures be required for any purpose) is to smear sterile blood over the surface of an ordinary agar tube and inoculate that with the material to be examined. To prepare these tubes, sterilize the tip of the finger with carbolic lotion, washing off the latter with alcohol or ether; then prick the finger and squeeze two or three drops of blood into the tube. It will run down the medium and mix with the water of condensation at the bottom. Put the tube in the incubator for twenty-four hours to see if it is sterile. This will probably be the case, as the living leucocytes and fresh serum are probably sufficient to kill the few stray bacteria that may have entered. It is then ready for use, and at the time of inoculation smear the blood over the surface of the agar with the loop. The colonies are very small and translucent (like those of the pneumococcus), and readily die out. The organism has well-marked morphological characters, and the deductions drawn from these characters need only be corroborated in cases of generalized infection or of meningitis, in which the results are to be published (as they should be), and must, therefore, be proved beyond doubt. In such cases the services of a bacteriologist should be called in if possible; or the material may be collected in pipettes with the most careful precautions as to asepsis, and forwarded *at once*.

#### METHOD OF MAKING THE FILMS.

The pus is to be spread out into thin films at the time at which it is taken, and this is true whether the practitioner intends to make the examination for himself or is about to send the material to a bacteriologist. Gonorrhœal pus should never be collected on a piece of cotton-wool or enclosed in vaccine tubes.

The films are to be made thus: Take two clean slides and place two or three platinum loopfuls of the pus on the centre of one of them; sterilize the needle and lay it down. Now take the other slide and apply its centre to the pus, and allow it to fall on to

the first slide by its own weight; do not squeeze the slides together. Then slide them apart, keeping each in its own plane until they are entirely separated. This will give you two excellent films. Allow them to dry and fix them in the flame.

The films may also be made on cover-glasses, exactly the same process being adopted, except that it will be necessary to squeeze the two lightly together. The fixation is accomplished by passing the cover-glasses *rapidly* through the flame.

These are the methods by which films are spread in all cases; the way in which the pus should be obtained varies somewhat with the nature of the case.

In the male it is advisable to cleanse the meatus and to reject the first drop of pus, taking the second with a platinum loop and proceeding as before. Antiseptic precautions are entirely unnecessary, as no attempt is to be made to get cultures. If the patient is suffering from phimosis, and there is a purulent discharge, which may be due to gonorrhœa, chancre, soft sore, or to a non-specific balanitis, a similar method is adopted; but here many films should be taken, as a prolonged search may be required. If the patient suffers from a slight discharge in the early morning, the best plan is to give him two clean slides. These are to be smeared across the meatus whilst wet with the discharge, and allowed to dry.

In the female it is necessary to obtain the pus directly from the urethra; it may be expressed by the finger in the vagina. The first drop should be rejected.

If the patient is suffering from cervicitis or endometritis, the pus should be taken direct from the cervix, a speculum being used, and the pus being removed by a platinum loop or probe. It is necessary to emphasize the fact that the material *must* be from these regions if a negative result is to be of any value. The flora of the vagina in all cases of discharge is so extraordinarily abundant that it is almost impossible to recognize the gonococcus with certainty in such material.

It is absolutely necessary that you should spread the films *at once*, even if you are having the examination made at a distance. It is next to useless to send pus dried on linen, cotton-wool, a Volkmann's spoon, or even in a thick layer on a slide. The diagnosis *may* be made from material sent in this way, but the difficulties are much greater, and in some cases the results are less certain.



Preparation of films from conjunctival pus presents no difficulties. The same is true of pus from the tubes or other internal regions, whether it is exposed by operative interference or at a post-mortem examination.

Instructions for the examination of the blood are given subsequently. A considerable number of films should be taken, as the cocci are present in but very small numbers.

The urine may be examined in the female if a local examination is not considered advisable, or in the male to obtain evidences as to whether the disease is cured or not. The morning urine should be examined. It should be mixed with a small quantity of carbolic lotion or other antiseptic and allowed to settle for twenty-four hours; it is much better to use a centrifuge if one is available. In cases where we require evidences as to cure after an attack of gonorrhœa, the urine is examined after gentle massage of the prostate.

#### STAINING OF FILMS.

One film is to be stained by a simple stain such as methylene blue or carbol thionin. The other is to be stained by Gram's method, and then in dilute carbol fuchsin for *half a minute*.

*Examination of Films.*—First take the specimen in which the simple stain has been used, and examine it with the oil-immersion lens. You will see that it shows numberless cells with very irregularly lobed nuclei; these are the pus cells or polymorphonuclear leucocytes. There will also be some flat squamous epithelial cells.

The gonococci will be stained even deeper than the cell nuclei, and will be mostly contained within the pus cells. If you see a cell which contains numerous small blue or violet granules, bring it into the centre of the field and examine it more thoroughly, to see whether the granules have the characters of the organism which we are about to describe.

The gonococcus is a large diplococcus, each component of the pair being shaped like a kidney, the hilum being turned toward that of its fellow. Single forms (which may be rounded) and tetrads are sometimes seen. It does not stain by Gram's method, and this is one of its most important features. Another important point is its arrangement; during the height of an attack of gonorrhœa it is almost entirely intracellular, being contained within the polymorphonuclear leucocytes. Further, several pairs

occur in each cell, and the great majority of cells are entirely devoid of cocci (Plate III., Fig. 2).

If the organism which you find possesses these characteristics, turn to the specimen which has been stained by Gram's method and counterstained by carbol fuchsin (Plate I., Fig. 6). In this all bacteria which retain Gram's stain will be coloured violet, while organisms which do not retain it will be red. You must, therefore, search for groups of diplococci contained within the cells and possessing the above characteristics. They will not be so prominent as in the other specimen, for the cells, nuclei, etc., will be coloured red also, and the contrast is not so great. But if the case is one of gonorrhœa, you will find them after a careful search.

If the films came from a female, you will probably find the appearances masked by numerous other organisms, especially by the *B. vaginae*, a rather large bacillus (somewhat resembling that of anthrax), which stains by Gram and is often present in large numbers, even if the film was taken in the manner mentioned. Yet in a positive case you will probably find the cells packed with non-Gram-staining diplococci having the above characters without much difficulty.

#### INTERPRETATION OF RESULTS.

You are justified in considering a case to be one of gonorrhœa if in films made from the pus—

1. Large kidney-shaped diplococci are present.
  2. These cocci occur within the pus cells, and at least four pairs (Foulerton) in each affected cell.
  3. The vast majority of cells are entirely free from cocci.
  4. The organisms in question do not stain by Gram's method.
- This is an absolutely essential point.

If cocci are present which answer to the above description, except that they are not enclosed within cells, the case may still be one of gonorrhœa. The gonococcus is frequently extracellular during the early stages of an attack of urethritis, and, though to a less extent, during its involution, whilst cases sometimes occur in which a considerable number of the cocci lie free during the whole course of the disease.

In the interpretation of films from a female, the above criteria must be insisted on very stringently. In the extraordinary assortment of bacteria met with, if there is an admixture of the vaginal

secretion, you may often find organisms resembling the gonococcus in some points, but not in all. These yield one of the most troublesome problems that the clinical bacteriologist has to face.

## SYPHILIS

It is now abundantly proved that the *Spirochæta* (or *Treponema*) *pallida* of Schaudinn is the actual cause of syphilis, and the diagnosis of this disease by the recognition of the causative agent is now practicable in some cases. The organism is a spirochæte, in shape resembling a spirillum, but probably of animal nature (*i.e.*, a protozoon). It is very small, or rather very narrow, and stains with great difficulty: it is this fact which has led to its having been overlooked previously. In length it is about equal to the diameter of a red corpuscle, either more or less; it is made up of about eight or ten close-set curves, and it has sharp ends. These facts are very important, for there are numerous spirochætes somewhat similar in appearance, which are frequently found in ulcers of all sorts, in the mouth, etc., and which have no doubt been frequently mistaken for Schaudinn's organism (*Spirochæta pallida*). The main difference is that in the other common spirochætes (one of which, the commonest, is called *S. refringens*, and is closely allied to, or identical with, that of Vincent) the curves are wider. For example, if we found two spirochætes exactly as long as a red corpuscle is wide, and in one there were eight complete curves and in the latter only three or four, the former would probably be *pallida*, the latter *refringens* (Plate V.). The former is also said to look stiffer and to be less easily bent. The staining reactions are different in the two cases, *refringens* being stained, though not deeply, with borax-methylene blue or dilute carbol fuchsin, whilst the latter is not.

*Method.*—The examination may be carried out on scrapings from a supposed chancre, secondary ulcer, condyloma, etc.; on juice obtained from an enlarged lymphatic gland by puncture with a hypodermic needle; on the blood expressed from a secondary rash after puncture of the skin, or, according to some authors, in fluid from a blister raised on or near a lesion of such a rash. It appears to be especially abundant in the pemphigoid rashes of hereditary syphilis. It is very rarely found in gummata or in any tertiary lesion.

Spread the material thus obtained in a *very thin* layer on a

scrupulously clean slide, allow to dry, and fix by gentle heat—*i.e.*, such that it does not get uncomfortably hot to the finger.

Prepare a mixture of 10 c.c. tap-water (or of distilled water + 1 drop of a 1 in 1,000 solution of potassium carbonate), and 10 drops of Giemsa's stain, which must be bought ready prepared. In mixing the two avoid violent agitation; add the stain to the water in a test-tube, stopper the latter with your thumb and invert it slowly once or twice. Do not mix it until you are ready to proceed with the staining.

Take the slide in a perfectly clean pair of forceps, flood it with the stain, and heat until it just begins to steam; remove it from the flame and in fifteen seconds pour off the solution, replace it quickly with fresh and heat again, again removing it when steam rises and allowing the action to go on for fifteen seconds. Do this four times in all, allowing the action to go on for one minute on the last application. Then wash in tap-water or in distilled water with a drop or two of potassium carbonate solution, blot, dry, and mount.

Another method is to place the slide *face downwards* in a Petri dish, supported on two slips of glass. The dish is then filled with a mixture prepared as above, and the staining allowed to go on for twelve to twenty hours in the cold, or three to four hours in the incubator, the dish being covered to prevent evaporation. If the slide is inserted face upwards, it will probably be covered by a fine red precipitate.

The most minute amount of acid is fatal to the process; hence all instruments must be dry and clean, and distilled water (which often contains traces of acids) should be avoided.

Examine the film with the  $\frac{1}{2}$  and your highest eyepiece, taking great care to get a good light, white if possible.

Another method, with which I have been fairly successful, and which is strongly recommended by Herxheimer, consists in fixing as before, and allowing the film to stain for twenty-four hours in a 1 in 1,000 solution of Nile blue in distilled water. The spirochætes are stained a fine blue, and are readily recognizable.

In making the search a good lens and good light are always, and much patience frequently, necessary; the spirochætes may be but one or two on a film, or there may be several on one field of the microscope. Very occasionally they are matted together in a dense mass. Having found a spirochæte, proceed to see if it resembles the *pallida* or the *refringens*; note especially its

length (comparing it with a red blood-corpuscle) and the number of turns of which this distance is made up. If there are about six or eight turns to this distance, it is almost certainly pallida; if there are fewer, it is not. Examine its ends, and see whether they taper off to a point or terminate abruptly.

It is also possible to see the spirochæte unstained, when it is actively motile, but it is not possible to distinguish it from its congeners in this way without much practice. In point of fact practice is an essential in the diagnosis of syphilis by the recognition of the spirochæte, and the practitioner is recommended to identify the organism as often as he can in undoubted cases before attempting its recognition in doubtful ones for diagnostic purposes.

## CHOLERA

The diagnosis of cholera can only be made on clinical grounds alone during an epidemic, as other diseases present almost identical symptoms and course. The importance of making a correct diagnosis arises less from the interests of the patient than from those of the general public; if the case is one of true Asiatic cholera, the sanitary authorities must be notified and the fullest precautions taken to prevent the spread of the disease. In all suspicious cases a quantity of the rice-water stools (in a bottle sterilized by boiling or by dry heat and *securely packed*) should be forwarded at once to a public laboratory. Meanwhile the diagnosis may be established with a fair amount of certainty by the following simple tests:

1. Take a platinum loopful of the dejecta and spread it in a thin film on a clean slide; dry, fix, and stain with carbol fuchsin for three minutes; wash, dry, and mount.
2. Prepare another film and stain by Gram's method.

### EXAMINATION OF THE FILMS.

The spirillum of Asiatic cholera is about half as long as a tubercle bacillus, or rather longer, and much thicker. It is slightly curved: hence the name of the "comma bacillus." It looks very like a caraway seed (Plate II., Fig. 5).

In the carbol fuchsin specimen vast numbers of these curved rods will be seen; probably few other organisms, if any, will be present if the case is one of true cholera. Two or more rods may often be found joined together with their concavities turned

in opposite directions, giving the whole the appearance of a very elongated spiral. In the stools (but not usually in cultures) the individual rods have frequently a parallel arrangement, presenting the appearance of " shoals of fish swimming up stream."

If you see these appearances examine the Gram specimen. Very few organisms will be visible, as the cholera vibrio does not retain the stain when treated in this way.

If vibrios having the above characters are present, proceed as follows:

Take two or three small flasks (preferably sterilized by heat), and add to each 100 c.c. of water, 1 gramme of peptone, and  $\frac{1}{2}$  gramme of common salt; boil thoroughly, and allow to cool. This forms a culture medium in which the cholera vibrio will grow very rapidly, and other organisms far more slowly.

Inoculate each flask with a loopful or two of dejecta, plug each with cotton-wool, and incubate for eight to twelve hours at  $37^{\circ}$  C. If cholera vibrios are present the cultures will conform to the following tests:

(a) There will be a film on the surface. This will be more marked after a few hours longer.

(b) This scum will present the microscopic appearances described above, except that the vibrios are usually somewhat straighter than those which occur in the stools, and the " fish-in-stream " arrangement is not marked. They will not stain by Gram's method.

(c) The addition of a small quantity of pure strong sulphuric acid will give a pink or crimson tint. This is the " cholera-red " reaction, and is caused by the action of sulphuric acid on indol in the presence of a minute quantity of a nitrite; many other organisms (*e.g.*, the *B. coli*) produce this colour *after* the addition of a nitrite, very few without it. The cholera vibrio produces nitrites as well as indol.

#### INTERPRETATION OF RESULTS.

In a case in which the above phenomena are observed, the inference that the patient is suffering from true Asiatic cholera is so strong that the authorities should be notified and the fullest precautions taken.

A case in which they are absent is almost certainly not one of true cholera.

## PLAGUE

The bacteriological diagnosis of plague should be made by an expert; not because it is difficult, but because so much hinges upon it—at least, in this country. A brief account of the method by which a practitioner who was unable to obtain expert help might proceed may not be out of place.

The plague bacillus is a short and rather thick rod which occurs in vast numbers in the bubo, in the blood, and in the internal organs. It does not stain by Gram's method, and when stained by other processes it often exhibits a characteristic *polar staining*, the ends of the bacillus being coloured deeply, whilst the intervening portion remains colourless (Plate II., Fig. 4). It might be mistaken for a diplococcus; it could not be mistaken for the pneumococcus (to which it has some resemblance), as that organism stains by Gram. Degenerate forms which resemble cocci, etc., often occur in cultures, but are seldom met with in the body during life.

The diagnosis may be made by an examination of fluid aspirated from the bubo or of the blood. In bubonic cases the former method should always be adopted, as the bacilli are present therein in vast numbers, and generally in pure culture; the amount of fluid which has to be removed is very small, even if cultures have to be taken.

When this is not the case two films should be made in the way already described, fixed and stained, the one by dilute carbol fuchsin or Löffler's blue, and the other by Gram's method. If the bacilli are present, they will appear as short oval rods which may or may not exhibit the polar staining; if the specimen has been stained for the proper length of time (about two minutes), most of them will do so, but in any case it will most likely be present in a few. The Gram specimen will not show these rods; there may be a few pus cocci present as a secondary infection.

The blood is examined by any of the methods to be described subsequently, and a very careful search made, as the numbers of the bacilli may be comparatively scanty.

If a careful examination of stained films made from a bubo does not show the organisms having the above characters, it is probably safe to say that the case is not one of plague.

## SOFT SORE

A very strong case has been made out in favour of the view that the bacillus described by Unna and by Ducrey is actually the cause of soft sore, though the proof does not rest upon the solid ground demanded by Koch. The bacillus has never been cultivated outside the body, and the chief proof of its pathogenicity rests upon the fact of its invariable presence in true soft sores. It is hardly correct to say that it is invariably absent from other sores, unless, indeed, we extend somewhat our conception of what a soft sore really is; for the author has found bacilli which were indistinguishable from these in sores which were exactly like those which follow herpes preputialis, though more severe than is generally the case. But it is quite possible that future research will show that the bacillus varies greatly in virulence, and that it is only under certain circumstances that it produces typical soft sores. At present all we can say about the diagnostic value of the organism is that its presence in the secretion from an ulcer affords strong evidence that the case is really one of chancroid, and that its absence almost certainly nullifies such a diagnosis. It is scarcely necessary to say that syphilis and soft sore (or gonorrhœa and soft sore) may be inoculated at the same time, and the lesions appropriate to both diseases may be present simultaneously.

The bacillus in question is a short straight rod, less than a quarter the length of the tubercle bacillus, and not much longer than the bacillus of influenza. It is rather thick in proportion to its length, its length being only about three times its breadth, and it has rounded ends, which often stain more deeply than the centre of the bacillus. It does not stain by Gram's method; it stains, indeed, with some difficulty, and powerful stains (such as dilute carbol fuchsin or Löffler's blue) should be used. It is best demonstrated in films made from the deeper parts of a typical soft sore, for the superficial parts contain bacteria of all sorts, and the recognition of Unna's bacillus is not easy unless it is obtained in large numbers.

The bacteriological examination for this bacillus has most often to be made in cases of urethral sore, or of a sore concealed beneath a phimosis. The method of obtaining the specimen is the same in both cases. A fairly stiff platinum loop is inserted



beneath the prepuce, or into the urethra, and moved gently about until the most tender spot is found. This should be scraped as forcibly as the patient will allow, and the loop withdrawn, care being taken that the mass of secretion is not wiped off in so doing. Several films should then be made, the secretion being rubbed up on the slide with a drop of water. They should be stained with either of the stains mentioned above for five minutes or more: it is an advantage to warm them gently. They are then rinsed in water, dried and mounted, and examined thoroughly with an oil-immersion lens.

When buboes occur in the course of soft sore, the pus they contain should be examined for this organism as soon as they are opened; the interest in this is chiefly scientific, for opinions are divided as to whether they are caused by this germ or by pyogenic bacteria. In three cases examined by the author it was found (in very scanty numbers) on one occasion, staphylococci on another, and no bacteria of any sort in the third.

## RINGWORM

An examination of the hair and scales from the skin is of very great value to the dermatologist. It settles conclusively the question whether a patient is or is not suffering from ringworm, and often gives important information as to prognosis, and may enable us to say whether the disease has probably been derived from a human source, or has been contracted from one of the lower animals.

Where the mere diagnosis of ringworm is in question, an examination of the hair or scales after soaking in liquor potassæ is often sufficient. The materials are placed in a drop of the solution on a slide, and covered with a cover-glass; after a quarter of an hour or so the specimen is carefully examined under the microscope, using a  $\frac{1}{8}$ -inch lens and a small diaphragm. The spores appear as spherical or oval, highly refractile bodies, which can hardly be mistaken for anything but fat globules. This possible source of fallacy may be removed by soaking the hair in ether before applying the liquor potassæ.

This is a rapid and simple method, but it does not enable us to diagnose the nature of the fungus with certainty, except in very typical cases, and when spores are scanty they are readily overlooked. It is a very great advantage to employ some method of

staining. These are by no means difficult, though they are somewhat tedious. Two processes, both modifications of Gram's method, will be given. They are not difficult to apply, but are very slow.

#### METHOD OF STAINING HAIRS, SCALES, ETC.

*Requisites.*—1. Aniline gentian violet, carbol gentian violet, or carbol fuchsin.

2. Gram's iodine solution.

3. Aniline oil, to which a little strong hydrochloric acid has been added, two or three drops to a quarter of a test-tube full of the oil. Prepare when required, and shake.

4. Aniline oil.

5. Xylol. This is not necessary unless the specimens are to be kept permanently.

6. Blotting-paper.

7. Slides, cover-glasses, and balsam.

*Process.*—Take a broken hair or stump from the edge of the suspected area, and cut off all the free portion, except a piece about  $\frac{1}{4}$  inch long. The root and the part of the shaft next to it are all that are to be examined. Several of these hairs can be stained at the same time.

Stain in a watch-glass full of stain, or on a slide, for a quarter of an hour, or longer—the longer the better; it is an advantage to warm the stain gently, and it will penetrate better if the hairs have been previously washed in ether, though this is not absolutely necessary.

Remove the hairs from the stain, and place them on a slide; if already on a slide, pour off the stain. Dry them with blotting-paper, and pour on the iodine solution; allow it to act for five or ten minutes. It is an advantage to blot the specimen after a minute or two, and apply a fresh lot of the solution. Blot thoroughly.

Now decolorize in the solution of hydrochlorate of aniline in aniline oil. This should be poured off and replaced occasionally, and the specimen examined under a low power of the microscope. When the decolorization appears to be complete (it may take many hours), pour off the solution and replace it by aniline oil; allow this to act for an hour or more, renewing it occasionally.

If the specimen is not to be kept permanently it may now be mounted in balsam and examined at once. If it is to be kept the

aniline oil must be washed out by several applications of xylol. Mount in balsam.

Adamson's method gives good results, but is somewhat more tedious.

*Requisites.*—1. Liquor potassæ.

2. Dilute alcohol—about 15 per cent.

3. Aniline gentian violet or its substitutes.

4. Gram's iodine solution.

5. Aniline oil.

6. Xylol.

7. Blotting-paper.

8. Slides, cover-glasses, and balsam.

*Process.*—Prepare the fragments of hair as before, rejecting the free portions. Place them on a slide, add a drop or two of liquor potassæ, and apply a cover-glass. Allow the liquor to act for a quarter of an hour or twenty minutes.

Now place a large drop of dilute spirit at one edge of the cover-glass, and a piece of blotting-paper at the opposite edge; this will suck up the potash, and the spirit will run in and replace it. After a few minutes lift over the cover-glass, and wash the hairs gently in more spirit. This will harden them. Dry. If epithelial scales are being examined, they may be fixed to the slide or cover-glass by heat in the usual way.

Stain in aniline gentian violet for half an hour or less.

Pour off the stain, blot gently, and pour on Gram's iodine solution. Allow this to act for five minutes. Blot again.

Decolorize with aniline oil, pouring it off and applying a fresh lot from time to time. The process may take an hour or more, and the specimen should be left under the microscope and examined occasionally.

When the decolorization is complete (*i.e.*, when the colour is seen to be present in the fungus only), blot gently, and wash thoroughly with xylol. Mount in balsam.

The specimens are to be examined under a  $\frac{1}{8}$ -inch objective. A higher power is unnecessary.

There are certainly three, and possibly more, species of ring-worm which occur in England, and the fungus of favus is closely allied, and is demonstrated by the same process.

The *Microsporon Audouini* is the most common species of ring-worm fungus in this country, being responsible for about 80 or 90 per cent. of all cases. It is the small-spored fungus, and

it may be distinguished by the fact that its spores are arranged in an irregular mosaic, and not in chains. Its mycelium, which consists of long threads, lies in the interior of the hair, whilst the spores form a thick mass outside (Fig. 28, and Plate VI., Fig. 4). This sheath of spores projects a short distance above the surface, and may often be seen with the naked eye. The outside of the hair is destroyed, and the surface of the hair eroded; the former feature serves to differentiate it from all other varieties of ringworm, and from favus.

This fungus usually attacks the scalp in children, and in them it dies out spontaneously about the age of sixteen, whilst other



FIG. 28.—MICROSPORON AUDOUINI.\*

varieties of ringworm often do not. It is very rare in adults, and it rarely attacks other regions than the head. It is thought by some to be always caught from a human case of the disease, but there are reasons for thinking that it may be derived by infection from the horse or cat.

The most important clinical fact about the *M. Audouini* is that ringworm caused by it is extremely intractable, and may run a prolonged course in spite of the most skilful treatment.

The *Trichophyton* (or *Megalosporon*) *endothrix* attacks the interior of the hairs, and forms long chains; it always involves the hair just inside the cuticle, being in reality an endo-ectothrix. Its spores are somewhat larger than those of the preceding species, but the difference is not great; the organism is most easily recognised by the chain-like arrangement of its spores, and by the fact that

\* Fig. 28 is from Curtis's "Essentials of Bacteriology" (Longmans).

they lie within the hair, the cuticle of which usually remains intact (Plate VI., Fig. 2).

This fungus is a rare cause (in this country) of ringworm of the scalp, and the disease caused by it appears to be somewhat easier to cure than that due to the microsporon, though opinions on this point are divided. It also attacks other regions of the body, causing tinea circinata, or eczema marginatum.

It always appears to be derived from a human case, and never by infection from animals.

The *T. ectothrix* (like the microsporon) forms a sheath round the outside of the hair, to which it is closely applied, like the bark to a tree, but, unlike the small-spored variety, does not destroy the cuticle. The spores are about as large as in the preceding species, and are arranged in chains; this fact, together with the position of the fungus with regard to the hair, will enable a diagnosis to be made (Plate VI., Fig. 1).

This fungus is a rare cause of ringworm of the scalp, and the disease it causes is readily cured. It also causes ringworm of the body and of the beard region, which the endothrix does not attack. According to Sabouraud (to whose work on these organisms we owe most of our knowledge on the subject), kerion is always caused by this organism, but this is not generally accepted. It appears, however, to be a fact that suppurative lesions (folliculitis, kerion, etc.) are *usually* caused by this fungus.

This species is often derived from one of the lower animals, especially from the horse, cat, and dog.

Favus is caused by a closely allied organism, the *Achorion Schönleini*. This may be demonstrated by either of the processes already described. It affects the skin in two ways: by the formation of the characteristic scutula and by the ringworm-like invasion of the hair. The scutulum is composed of vertical mycelial filaments, which branch, and which appear to be composed of short rods. There are often oval spores at the free ends of these branches, and, according to Sabouraud, branching into *three* occurs (trichotomous branching), and is very characteristic, though difficult to see. The radiation of several filaments from one point, and the fact that these appear to be made up of short lengths, gives rise to an appearance which has been compared to that of the metatarsal bones, and the term "favic tarsus" has been applied.

When favus affects the hair (Plate VI., Fig. 5), the cuticle

remains intact, and the inner portion of the hair is packed with long waving filaments, whilst the outside (under the cuticle) is covered with short "elements"—the exact nature of which is doubtful—of every shape and size.

The identification of the variety of organism which is present is not usually difficult. The first point to be looked to is the arrangement of the spores. If these form an irregular mosaic, the microsporon is present; if they form filaments somewhat resembling those of a streptococcus, the organism is a trichophyton. Then look to see whether the cuticle is intact, and whether the fungus invades the interior of the hair. This can usually be determined by focussing up and down until you see an "optical section" of the hair in question. It is important not to be deluded by the fact that the fungus which lies on the outside of the hair will appear to be inside it if a surface view only is taken.

#### RINGWORM OF THE NAILS.

The nails may be affected by either of the trichophytions or by favus. The diagnosis of the presence of ringworm may usually be made by the examination of pieces of the nails after soaking in liuqor potassæ, but a prolonged examination of many pieces must be made before their absence is assumed. The diagnosis of the variety present can only be made by cultures, and is not of clinical importance (Plate VI., Fig. 3).

#### OTHER SKIN DISEASES

In seborrhœic affections the *bottle bacillus* of Unna is constantly present, and as it does not occur at all frequently in other diseases, if at all, it is a useful test between seborrhœic dermatitis and psoriasis, especially on the scalp. It is a moderately large organism which consists of an oval, spore-like body attached to a short neck or handle. The former stains faintly, especially in the middle, where it seems to have a clear vacuole, whilst the handle stains deeply. It is very easily recognised after it has once been seen; it is perhaps the only bacterium which can be positively identified by microscopic means *alone*. It stains by Gram.

To search for it, take a scale or two from the affected region and grind it in a drop of water between two slides until reduced to a

pulp. Allow some of this pulp to dry on one of the slides, fix, stain by Gram's method, and do not counterstain. If the film is very greasy, so that the stain does not wet it, warm the slide gently and allow a few drops of ether to flow over the film, fix again, and proceed as before. Examine the preparation under a  $\frac{1}{12}$ -inch. The presence of the bottle bacillus is almost conclusive evidence in favour of seborrhœa, as against psoriasis, syphilis, etc.

The figure (Plate IV., Fig. 6) I owe to the kindness of Dr. Whitfield. It is from an impure culture, the only one that has ever been obtained.

TINEA VERSICOLOR.—There is usually no difficulty in the diagnosis of this disease by ordinary clinical methods. Where there is any doubt, one of the scales may be removed and examined in liquor potassæ, or by any of the methods described for ringworm. The fungus—*M. furfur*—is readily detected under a  $\frac{1}{8}$ -inch. It consists of rather wide mycelial threads, branching and interlacing, with masses of refractile spore, looking like bunches of grapes (Plate IV., Fig. 4).

## SECTION III

### COLLECTION AND EXAMINATION OF CERTAIN MORBID MATERIALS

#### THE COLLECTION AND EXAMINATION OF PUS

WHEN a simple microscopical examination has to be made, the collection of pus presents no difficulties, as the few bacteria which may gain access from the skin or the air will not lead to error. The case is otherwise where cultural examinations have to be made, or where the material has to be taken to a laboratory. Here the material should be collected in a pipette. This is to be at hand when the abscess is opened; both ends are to be broken off and passed through the flame two or three times. The pipette should then be held by an assistant, or put with the end which is to be inserted into the pus projecting over the side of the table, so as not to come into contact with any object.

When the abscess has been opened, a considerable quantity of pus should be allowed to flow out, and the sterilized pipette is then to be passed through the incision (care being taken to avoid contact with its sides) and the pus carefully sucked up into the bulb. The fluid thus obtained may be used to inoculate cultures there and then, or both ends of the pipette may be sealed in the flame.

#### THE EXAMINATION OF PUS.

The organisms which may cause pus are extremely numerous, the most important being streptococci, staphylococci, the pneumococcus and the gonococcus, the bacilli of typhoid fever, tuberculosis, and glanders, the *B. coli communis*, the *B. pyocyaneus* (the organism which produces blue pus), and the fungus of actinomycosis. In the majority of cases the organism which is present in a given sample of pus can be determined by a microscopic examination of films prepared in the usual way and stained by a



simple stain, such as carbol thionin. A specimen should also be stained by Gram's method and the results compared.

When cultural examinations are required, the best plan is to make stroke cultivations on agar in the manner described on p. 16, and incubate them for twenty-four hours at the temperature of the body. The appearances of the colonies will be similar to those described as occurring in cultures made from the blood, to which the reader is referred. It is to be noted, however, that the gonococcus will not grow under such circumstances unless the surface of the medium has previously been coated with blood.

Another method is to make gelatin plates. This is a very simple matter if the materials are at hand.

*Requisites.*—1. Two or three tubes of gelatin.

2. Two or three sterilized Petri dishes.

3. A platinum needle—a loop will be best.

*Process.*—Inoculate a gelatin tube in the manner described on p. 16, and then melt it by immersion in warm (not hot) water.

Distribute the pus throughout the melted gelatin by rolling the tube between the hands, and by tilting it from side to side. Do not shake, and do not let the melted gelatin touch the cotton-wool plug.

Take a loopful of the gelatin and transfer it to a second culture-tube. Melt the gelatin in this and mix as before. Proceed to inoculate a third tube from the second one if you think it probable that the pus is very rich in organisms.

Now take the first tube and singe the projecting part of the wool plug, and heat the mouth of the tube in order to destroy any germs which may be upon it; allow it to cool.

Place the Petri dish on the table in front of you, and raise the lid sufficiently to allow you to insert the end of the test-tube; do this, and tilt the latter so that the melted gelatin flows into the dish. Immediately replace the lid, and tilt and roll the dish until the gelatin forms an even film over its whole lower surface. Place it on a flat table to set. Repeat the process with the other tubes. Incubate at about 20° C. for two or three days. Examine the dishes, placing them on the stage of the microscope and using the low power. Each organism will have grown into a small colony, which will resemble those which are described in the section on the blood. There will be slight differences, but not enough to lead to error if the examination of the colonies is supplemented by an inspection of stained films.

The pneumococcus, gonococcus, the fungus of actinomyces, and

the tubercle bacillus, will not grow on these plates; the streptococcus and the bacillus of glanders will grow feebly, if at all.

In a day or two longer the plates will, in some cases, be found to have undergone a decided change. If liquefying organisms are present the colonies will soon become depressed below the general surface of the medium, and will be surrounded by haloes which consist of liquefied gelatin. This will happen with the staphylococci and the *B. pyocyaneus*; not with the streptococci, the typhoid bacillus, nor with the *B. coli*.

The bacillus of blue pus can readily be distinguished from the staphylococci by its morphological appearance (it is a slender rod), and by the fact that the gelatin round the colony is coloured blue or bluish-green, the growth itself being nearly white.

#### INTERPRETATION OF RESULTS.

. The chief practical value of the bacteriological examination of pus is derived from the fact that if specific vaccine treatment (on Wright's system) is to be used, the vaccine must be prepared from the organism which is causing the disease. If a patient is suffering from a staphylococcic lesion, it is not much use inoculating him for pneumococci, or *vice versa*. I have seen and obtained such excellent results in some cases by treatment of this nature that very little doubt remains in my mind that the method is one which will be widely used in the future. Except for this the results obtained by a study of the bacteria in pus are more of scientific interest than of practical importance. It is the situation of the collection of pus rather than the bacteria causing it which influences treatment and prognosis. A list of the more important results which are produced by the chief pyogenic bacteria may be of interest.

*Staphylococci* are the chief producers of localized suppuration in the skin—such, for instance, as that which occurs in boils, carbuncles, impetigo, folliculitis, etc. They may cause abscesses in *any* part of the body, and may also give rise to general infections, ulcerative endocarditis, etc., though this is rare.

It is in the localized skin affections of staphylococcic origin especially that good results are obtainable by specific vaccination, and a cure may often be obtained in cases which are very intractable by other methods.

*Streptococci* usually cause spreading inflammation of the type of erysipelas or cellulitis. They are common causes of osteomyelitis

and suppurative and septicæmic or pyæmic processes connected with the puerperium.

In general infections which are due to streptococci the use of antistreptococcic serum is indicated, and may offer the only hope for the patient.

The *pneumococcus* often produces suppuration in connection with the respiratory system, especially empyema. It also causes many cases of suppurative otitis media and meningitis.

The *bacillus of typhoid fever* sometimes causes abscesses in connection with the bones after (sometimes long after) typhoid fever. It has been found in other suppurative conditions, *e.g.*, empyema.

The *tubercle bacillus* gives rise to "cold abscesses," usually in connection with bone. The suppuration which occurs in the walls of phthisical vomicæ is due to other bacteria, chiefly streptococci and staphylococci. The pus in true tuberculous abscesses is thin and watery, like milk and water, and often contains small caseous masses. The cells are usually mostly lymphocytes. In most cases it is perfectly easy to find tubercle bacilli in this pus if it is examined when the abscess is first opened, whereas afterwards none may be found after a very long and painstaking search.

The *bacillus of glanders* only causes suppuration in the specific lesions of the disease when these run an acute course.

The *B. coli communis* is the chief cause of suppuration occurring in connection with the abdominal viscera, especially of peritonitis due to perforation of the intestine and appendicitis. It frequently attacks the urinary passages, causing cystitis, etc.

The *B. pyocyaneus* causes blue pus, usually in connection with the skin or subcutaneous tissues.

The *fungus of actinomycosis* has been dealt with already.

## THE BACTERIOLOGICAL EXAMINATION OF THE MOUTH AND FAUCES

The method of examination of the morbid products of the mouth and fauces in diphtheria has been explained in full, and the methods which are used in other conditions are similar in nature.

The more important of these allied conditions are :

Simple angina and follicular tonsillitis.

Vincent's angina.

Scarlatinal angina.

Thrush.

Syphilitic angina.

*Methods.*—An examination of a film stained by a simple stain, and of a second prepared by Gram's method, is usually all that is necessary, but it is advisable to be prepared to make cultures subsequently if thought requisite. If the patient is seen at some distance from the laboratory, the material is best collected on a sterilized swab such as is used for diphtheria in the method described on p. 38, taking great care to rub it on the affected area. When this is brought to the laboratory, two smears are to be made on slides which have just been sterilized by being heated in the flame, and which have been allowed to cool. As soon as the films have been prepared the swab is to be returned to its sterile tube and kept in readiness for the preparation of cultures, should they be required. It is better to take a second swab, and to keep it until the films have been examined.

When the patient can be brought to the laboratory it is more convenient to collect the material with a platinum loop. A good loopful of the material is removed, laid on a clean slide, and two films prepared by pressing a second slide firmly on the first and sliding them apart. If there is any difference between the two, the thicker is used for staining by Gram's method. This is fixed in the flame in the usual way, stained by aniline gentian violet (3 minutes), rinsed, fixed in Gram's iodine solution, decolorized in methylated spirit or absolute alcohol until no more colour comes out, stained in dilute (1 in 5 or 1 in 10) carbol fuchsin for a quarter of a minute, washed, and dried. The other film is best stained by carbol thionin, but Löffler's blue answers very well.

The examination of the films is made at once, and will show whether a cultural examination is necessary, and if so, what medium should be used. Thus, if Gram-staining bacilli are present, diphtheria is suspected, and cultures should be made on blood-serum.

SIMPLE ANGINA and FOLLICULAR TONSILLITIS may be due to streptococci, staphylococci, pneumococci, or the *Micrococcus catarrhalis*. These are readily detected in the smears, the first as longer or shorter chains of cocci, the second as cocci which are isolated or in small groups and often contained in the leucocytes, the third as pairs of cocci with a more or less marked lanceolate shape and a capsule: all these stain by Gram. The *M. catarrhalis* (Plate III., Fig. 5) is recognisable by its shape (kidney-shaped, or a sphere with a segment cut off), by its being larger in size than the staphylococcus, by its being frequently intracellular, and by

its not staining by Gram's method. Here a warning already given must be repeated: it is not safe to conclude that an organism does not stain by Gram because the intracellular bacteria are decolorized, and extracellular ones should be sought for, and will usually be found.

If no organisms but the above cocci are found after a very careful search, the conclusion is that the case is probably either simple angina, follicular tonsillitis, ulcerative tonsillitis, or scarlet fever. But it must be remembered that, although a good large area of film has been searched, in reality but a very small volume of secretion has come under observation—probably less than a cubic millimetre—and that diphtheria bacilli *may* be present; it is therefore advisable to make a culture on blood-serum before giving a definite diagnosis.

No conclusions as to the cause of the angina or as to its prognosis can be given from the discovery of the causal organism. The presence of a streptococcus renders it more likely that the disease is scarlet fever, but certainly does not prove it. Nor does the examination give much help as to treatment. If the disease is due to a streptococcus and the symptoms are severe, antistreptococcic serum may be given, the local treatment being continued as usual.

VINCENT'S ANGINA is a very interesting form of sore throat recently described by Professor Vincent, of Paris, and is especially important since (1) it closely resembles diphtheria, and the two may be readily confounded, and it also may easily be confused with a syphilitic lesion; and (2) it is readily cured by appropriate treatment—friction twice daily with a tampon soaked in tincture of iodine. It has attracted very little attention in this country, yet it does not seem to be rare; I have now seen many cases. One was of great severity, and was associated with the formation of an abscess in the tonsil, and subsequently of another in the soft palate.

Vincent describes two forms:

1. An ulcero-membranous variety, which commences with fever and general malaise, and with redness of a tonsil or of a pillar of the fauces. In a day or two a grey or yellowish false membrane appears on the injected area; it is soft and but slightly adherent, and when removed the mucous membrane is found to be ulcerated. As the disease proceeds the membrane increases in thickness, and a deep ulcer is formed. The breath is fœtid and the tongue

furred, salivation occurs, and deglutition is painful. The sub-maxillary glands may be enlarged. In most cases the patient recovers in a week or fortnight, but the affection may become chronic and last a month or more.

More severe forms occur in which the soft palate, uvula, tongue, etc., are invaded, and ulceration also occurs. In some cases there is a scarlatiniform rash, which might lead to the diagnosis of scarlet fever.

2. The diphtheroid form is rarer, occurring only in 2 per cent. of Vincent's cases. The onset is accompanied by a little fever, some difficulty in swallowing, and fœtor of the breath. Locally, the mucous membrane is inflamed and injected, and a whitish membrane is formed; it is thin at first, but becomes thicker, and when removed leaves an ulcerating or bleeding surface, but the ulceration is less than in the other form. The disease runs a shorter course, recovery occurring in four to eight days. This is the form which so closely resembles diphtheria, and which, I have no doubt, has often been mistaken for it, even after a superficial bacteriological examination of the membrane.

The diagnosis is made from films prepared from the swabs, stained by Gram's method and counterstained by carbol fuchsin. In the more common form (the ulcero-membranous) two very interesting organisms will be found—a *bacillus* and a *spirillum* (Plate IV., Fig. 2).\* In the diphtheroid form the bacillus is present, but not the spirillum; in either form of the disease the characteristic organism or organisms may be associated with streptococci, staphylococci, etc., and these secondary infections may give rise to grave complications.

The *B. fusiformis*, which occurs in both forms of the disease, may be found, in small numbers, as a normal inhabitant of the mouth, and occurs in myriads in the disease. It varies in size, but is on the whole a large bacillus, about as long as the diameter of a red blood-corpuscle, or even longer. Typically it has both ends pointed, giving it the shape of a greatly elongated spindle, but other forms always occur, and may even constitute the majority of the bacilli present. It often contains two or three clear vacuoles, which may not be noticed if the staining is too deep. Both the bacillus and the spirillum are usually actively motile, and it is a good plan to check the results of the examina-

\* It is possible that these are different stages of the same organism, a protozoon.

tion of the stained films by mounting a fresh wet specimen between slide and cover-glass, and examining it under the oil-immersion lens.

The *B. fusiformis* plays a very important part in many inflammatory and ulcerative conditions in and about the mouth and adjacent cavities, the teeth, etc. For instance, in association with the same spirillum it is present in the pus of pyorrhœa alveolaris. The lesions it causes are all associated with a fœtid odour, and the cultures (which are very difficult to obtain) have a similar smell.

The spirillum occurs only in the ulcero-membranous form, and is present in vast numbers, usually even more plentifully than the bacillus; a well-prepared specimen is one of the most striking and characteristic objects to be seen in the whole range of bacteriology. It is much longer than the bacillus, very thin, and either wavy and irregular in outline or thrown into definite corkscrew curves. These are better seen in a wet specimen, though here the active motility of the organism often makes it impossible to make out its exact shape. It usually stains badly, and I have missed it in specimens rapidly stained with weak stains: dilute carbol fuchsin stains it very well in a quarter of a minute. In one or two specimens I found the spirilla broken up into chains of very minute granules, so that they resembled long chains of very minute streptococci. In each case it was late in the disease, so that they may have been degeneration forms.

The spirillum differs from that of syphilis in that it is much larger and is easily stained by ordinary dyes, and the two could hardly be mistaken. It is to be noted, however, that the *B. fusiformis* is not uncommon in syphilitic lesions.

SCARLATINAL ANGINA cannot be diagnosed with certainty from other forms of sore throat by bacteriological methods. It is usually due to a streptococcus which occurs in very long chains and is somewhat characteristic, but which cannot be differentiated from other forms of streptococci by simple means.

THRUSH is usually easily recognisable, but when this is not the case a Gram-stained specimen of the membrane will immediately settle the diagnosis. The specific organism, the *Oidium albicans* or *Saccharomyces albicans*, is a mould which appears in the form of large and thick branching mycelial filaments which stain deeply by Gram's method, and which are interspersed with large round or oval spores, which also stain readily and deeply. The organism

can be readily differentiated from the *bacterial* filaments which may occur in the mouth (leptothrix, etc.) by its relatively enormous size. When cultivated for a day or two on ordinary media mycelium formation does not take place, or only to a very limited extent, and the oval or spherical spores are often mistaken for yeasts.

SYPHILITIC ANGINA may be recognised by the identification of the *Spirillum pallida*, but some caution is necessary, since non-pathogenic spirilla are frequently present in the healthy mouth. The films stained by Giemsa's stain must be very carefully compared with others stained by simple dyes (thionin or methylene blue), to make sure that the organism found is not coloured by ordinary means.

### THE BACTERIOLOGICAL EXAMINATION OF THE NOSE AND ACCESSORY CAVITIES

In health the nasal mucous membrane is sterile except for that portion in close proximity to the orifices; the vibrissæ are especially contaminated with air-borne organisms, and contact with them must be avoided if cultures are being taken.

*Methods.*—In most cases a simple microscopical examination of the mucus, muco-pus, or pus from the nose is sufficient, and the material may be taken from the patient's pocket-handkerchief immediately after he has blown his nose. Where cultures are required the methods are more difficult, and the material must be collected as near as possible to the region where it is secreted; this is especially the case in the examination of the pus from cases of empyema of the antrum, frontal sinus, etc. I have found the most convenient instrument is a long capillary pipette of rather wide calibre, and bent to an angle of about 135 degrees, at a point some 4 inches from its tip, which must be carefully rounded in the flame, so as not to injure the mucous membrane. It is provided with an indiarubber nipple, and is readily prepared from one of the straight pipettes described on p. 151, by heating it gently in a spirit-lamp, at a point about 4 inches from the tip, until the glass is just softened, and then allowing the distal end to fall until the proper angle is reached. The pipette may be sterilized by passing it rapidly through the flame, taking care not to melt it.

To use it, seat yourself opposite to the patient, insert a nasal speculum sterilized in carbolic acid or in the flame, and examine the nose in the ordinary way by means of a beam of light



directed up the nose from a laryngoscope mirror. Insert the tip of the pipette, taking great care not to touch the vibrissæ or the mucous membrane near the orifice, and pass it upward until it comes in contact with the pus. Then squeeze the nipple and allow it to expand again, slightly moving the tip of the pipette about in the pus, and taking care not to bring it in contact with the mucous membrane. In most cases you will be able to suck up a few drops of pus; sometimes it is very thick and turbid, and will not enter the pipette, and in this case you must use a platinum loop, which is not nearly so efficacious or so easy to use. But in

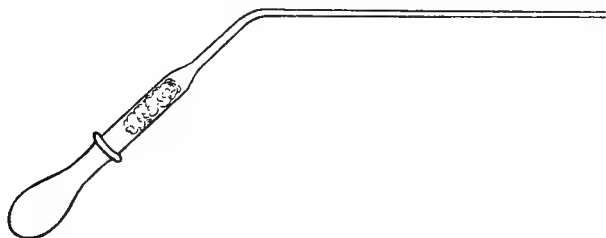

FIG. 29.—ANGLED PIPETTE FOR COLLECTING PUS FROM THE NOSE.

most cases the angled pipette will be found available after a very little practice.

The organisms most frequently found in inflammation of the general surface of the mucous membrane of the nose are the diphtheria bacillus, the influenza bacillus, the *M. catarrhalis*, and, less commonly, the pneumococcus. These do not call for further mention. In early cases of leprosy the bacilli may be found in the nose, apparently before they are present elsewhere in the body, and the diagnosis may be made from their recognition.

In suppuration of the antrum and other sinuses the bacteriology is very variable. In disease of the antrum due to carious teeth the *B. fusiformis*, mixed with numerous other organisms, may be found. In other cases the commonest bacteria are pneumococci, streptococci, staphylococci, and the *M. catarrhalis*, usually unmixed in each case; the subject, however, has not yet been sufficiently investigated.

### THE CONJUNCTIVA

The method of examination is very simple. A little pus is taken with a platinum loop and films prepared. One of these is stained with carbol thionin or Löffler's blue, and the other by Gram followed by dilute carbol fuchsin.

The most common causes of conjunctivitis are the gonococcus, the pneumococcus, the Koch-Weeks bacillus, and the bacillus of Morax and Axenfeld. In addition to these, certain other bacteria must be briefly mentioned.

The method for the recognition of the *gonococcus* need not be further described (see p. 84), nor is it necessary to point out the danger of this form of conjunctivitis, nor the fact that prompt measures must be taken if the eye is to be saved.

Other organisms somewhat resembling the gonococcus sometimes occur in the conjunctiva, but I have never seen or heard of a case in which they were absolutely identical in appearance and distribution, and present in numbers sufficient to lead to errors in diagnosis.

The *pneumococcus* is not a common cause of conjunctivitis, and when it occurs the prognosis with regard to the involvement of the cornea is not serious.

The *bacillus of Koch and Weeks* is extremely minute, and has a close resemblance to the influenza bacillus. It is very thin in proportion to its length, does not stain by Gram, and is frequently intracellular, the cells then containing large numbers of bacilli, though it may be necessary to search over a considerable area of film before an affected cell is seen. It is advisable to search for the organisms in a thionin or Löffler's blue specimen, as it will probably be more distinct than in the Gram specimen counterstained with carbol thionin.

If the two occurred in the same region, it would probably be indistinguishable from the influenza bacillus; they differ, however, in cultural characters.

It causes the common self-limited variety of acute or chronic conjunctivitis. There is no danger that the cornea may become infected; the disease is very contagious.

The *bacillus of Morax and Axenfeld* (Plate IV., Fig. 3) causes the dry conjunctivitis which occurs especially along the edges of the eyelids and at the angles of the eye, and which does not tend to cure in the absence of appropriate treatment. The secretion is usually very scanty, and not purulent; it is best collected from the caruncle, and it may be necessary to use a capillary pipette for the purpose.

It is readily recognised as a rather large, broad bacillus, with the sides parallel and the angles slightly rounded, and two bacilli are often seen with their ends approximated together. It is most

frequently extracellular, but some bacilli are frequently seen within the cells. Gram's stain is not retained. It grows readily on blood-serum, which is rapidly liquefied.

Of the rarer causes of conjunctivitis, the staphylococcus, streptococcus, and pneumobacillus may be mentioned. The latter may be recognised by the presence of a capsule surrounding a bacillus which greatly resembles an elongated pneumococcus, which does not retain Gram (Plate III., Fig. 3).

*Diphtheria* affects the conjunctiva, and its clinical recognition is not usually difficult. But the bacteriological diagnosis (without the use of animal inoculations) is complicated by the fact that an organism—the xerosis bacillus—which closely resembles the diphtheria bacillus may occur in the conjunctiva either in health or in disease. It does not appear that the two can be differentiated with certainty by morphological appearances, staining reactions (the xerosis bacillus often shows polar granules), or even by cultural tests.

In *tuberculosis* of the conjunctiva it is usually necessary to excise a piece of the lesion, and cut sections, but bacilli have been detected occasionally in scrapings.

## THE SPUTUM

The chief applications of bacteriology to the examination of the sputum have been mentioned already, but it seems advisable to add a few general words on the subject.

The selection of the material is of prime importance, since it is obviously useless to expect an examination of the secretion of the mouth and fauces to yield information as to the state of the lungs. Where the sputum is copious the danger of this error is not great; in advanced phthisis the contents of a sputum-cup taken at random will usually show signs of tubercle bacilli. Where the sputum is but scanty the possibility is great, and in this case the patient should be supplied with a clean (and, if possible, sterile) sputum-cup, to be used only for collecting the material for examination, and he must be instructed to use it only after a paroxysm of coughing, and when he distinctly feels the sputum come up from the chest. If the patient is not sufficiently intelligent, the task of collecting the sputum may be entrusted to a nurse, to whom the importance of securing material directly from the lungs has been explained.

Where it is necessary to work with material which has been collected without any precaution, the microscopical nature of the cells may afford a clue as to its origin. Mucus or muco-pus derived from the *mouth*, *pharynx*, etc., is characterized by containing *squamous cells*; these are of large size, flattened, have a comparatively small nucleus, and are often collected into groups of three or four, with a distinct tessellated arrangement. They contain granules (of keratin or an allied substance) which stain deeply by Gram's method; they are also the last substances (other than acid-fast bacilli) to be decolorized by the acid in the Ziehl-Neelsen process, and when the decolorization has not been carried out quite completely, may remain stained in the form of pinkish plaques. The sputum which comes from the *bronchi* may be characterized by the presence of columnar cells, which are occasionally found to be ciliated, but in most cases this sign fails, and the sputum consists of mucus enclosing polynuclear leucocytes and no characteristic cells of any kind. The same is true of the sputum from the lungs: there is frequently nothing to distinguish it from that of other regions, and this is especially the case when it is derived from a cavity which is lined with pyogenic membrane. But sometimes the sputum contains very characteristic alveolar epithelial cells. These are derived from the lining of the alveoli, the cells of which lose their flattened shape and become spherical in many pathological conditions. They are large round or oval cells, much larger than the polynuclear leucocytes, and have clear protoplasm and a round or oval nucleus, which is often placed eccentrically. They are actively phagocytic, and their contents give an important clue to the nature of the pathological process at work in the lungs, since they are derived directly from the alveoli. In *pneumonia* they may be seen to contain pneumococci, and this is especially the case after the crisis; in *congestion*, and especially passive congestion, of the lung they are packed with red corpuscles, often in various stages of destruction, or with granules or crystals of altered blood-pigment. In diseases due to dust the cells contain fragments of the dust in question, but it must be remembered that particles of coal-dust are often found in them in normal conditions in city dwellers.

In asthma the characteristic Curschmann's spirals may be seen, and the cells will be found to consist almost entirely of eosinophile leucocytes.

## THE GASTRIC CONTENTS AND VOMIT

The bacteriological examination of the stomach contents is not of much importance except in one case—*i.e.*, in the differential diagnosis of carcinoma ventriculi and simple dilatation of the stomach. For this purpose it is usually sufficient to examine the vomit, or, if vomiting does not occur, the gastric contents removed by a stomach-tube. It is quite unnecessary to give a test meal, though this is advisable if a chemical examination is to be made; this should be done in all doubtful cases, but since the methods requisite are outside the scope of this work, only a couple of simple tests will be given.

The examination is carried out quite simply by the wet method. Two or three drops of the vomit (avoiding undigested food or mucus, since the latter is likely to be derived from the mouth or pharynx) are placed on a slide, and either examined just as they are, or a drop of watery methylene blue, gentian violet, or other stain, is added and stirred well in, and the mixture covered with a cover-glass. If there is an excess of fluid (so that the cover-glass is floated up), it may be sucked up by means of a piece of blotting-paper; and if an oil-immersion lens is to be used, it will be advantageous to seal the cover-glass down by means of melted paraffin applied by a hot iron, so as to prevent it from being lifted up by the suction of the oil between the lens and cover-glass. If no positive results are found in the first specimen examined, two or three more should be made, as the characteristic organisms are often not distributed uniformly throughout the vomit. Subsequently it may be necessary to prepare dried films to determine whether the organisms stain by Gram.

In carcinoma of the stomach the characteristic features are (1) the presence of the Boas-Oppler bacillus, (2) the usual absence of sarcinæ, and (3) the absence of hydrochloric and presence of lactic acid. In addition there may be blood, pus, and fragments of tumour; the latter are very rare and difficult to diagnose with certainty.

The *Boas-Oppler bacillus*, or *B. geniculatus*, is very characteristic of carcinoma of the stomach, though it does not occur in every case. It is very rare in other conditions; I have seen it once in a case of simple chronic gastritis, but here it was present in numbers which were very scanty as compared with the profusion

in which it occurs in malignant disease, and it would have been overlooked on a casual examination. It is a bacillus of large size, and has a tendency to grow into long threads, which are readily visible under a  $\frac{1}{8}$ -inch lens (Plate IV., Fig. 5). In a wet specimen these threads usually seem continuous, but on examining a dried and stained specimen, they may be seen to be composed of bacillary segments, much like the chains of the anthrax bacillus. In a wet unstained specimen these threads are very easily recognised, as they are highly refractile and may have a slow, crawling motion, or may be non-motile: most usually the latter. Another characteristic feature is the presence of an obtuse angle in some portion of the length of many of the threads, whence the name *B. geniculatus* is derived. The organism does not form spores. It stains by Gram, and I have noted in several cases the presence of a phenomenon which is very rare amongst bacilli, that of longitudinal fission in a small number of the chains, which thus come to form double rows of bacilli in close lateral approximation. That this is not a mere effect of staining is shown by the fact that occasionally the two bacilli at one end of this double thread will turn away from one another, so that it looks as if there were true branching at the extremity of the filament. If this turns out to be the case in all specimens, it will be a most important means of identifying the organism.\*

Cultures may readily be obtained on media rather highly acidified with lactic acid, but are not requisite for the identification of the bacillus.

In addition to the Boas-Oppler bacillus, the vomit may contain a few yeasts, distinguished by their large size, oval or spherical shape, and by the way in which they reproduce themselves by budding; there may also be a few bacteria of other sorts. But in many cases the bacilli are present in a state of almost absolute purity, and in large numbers, so that they form tangled masses.

In nearly all cases in which the bacillus is found the vomit contains no hydrochloric acid, or only a trace. To test for it filter some of the vomit and place a drop or two of the filtrate on a white porcelain tile; place a drop of a 0.5 per cent. alcoholic solution of dimethyl-amido-azo-benzol close to it and let the two gradually mix. If physiologically active HCl is present, even in very small amount, a transient pink colour will be produced. The

\* Note to Third Edition. It is not, though I have since seen it two or three times.

commonly recommended phloroglucin and vanillin test does not demonstrate the presence of HCl in combination with proteids, and since this is usually the form in which it occurs in the stomach contents the failure to obtain the phloroglucin and vanillin reaction is not of the slightest importance in diagnosis. The use of the latter test is, I think, one of the chief reasons for the common idea that the absence of HCl is of very little value in the diagnosis of malignant disease. Using the dimethyl-amido-azo-benzol test, I have rarely found it fail, and in the only case I remember in which the acid was found present in considerable amount the growth was found at operation to be spreading outwards, and hardly to involve the mucous membrane at all. But these tests were mostly made on the fluid obtained after a test meal, and not on vomits.

Lactic acid usually occurs in the absence of free hydrochloric in cancer of the stomach, but its presence is in itself a fact of little value, since it occurs in other conditions. To test for it in a vomit it is necessary to extract the acid by thoroughly shaking up some of the fluid with ether, pipetting off the latter, and then allowing it to evaporate. The acid is contained in a state of comparative purity in the residue, which is then dissolved in water and tested in the following way; To half a test-tubeful of 1 in 40 carbolic add one or two drops of liq. ferri perchlor. A fine amethyst colour will result, and will be changed to a bright canary-yellow on the addition of the solution of the ethereal extract, if the latter contains lactic acid. It is *not* sufficient to apply this test to the filtrate of a vomit direct, although this is permissible in the case of the fluid removed from the stomach after a test meal.

The vomit in cases of simple dilatation of the stomach usually contains a variety of bacteria, yeasts, etc., but the most characteristic organisms are the sarcinæ, a group of cocci which have very definite microscopical characters. They have the property of dividing by three successive divisions in the three planes of space (at right angles), and the eight resulting cocci do not completely separate from one another. The result is the formation of a group of eight cocci which form one mass, having the shape of a bale of soft material tied round by three tightly drawn cords at right angles to one another. Successive divisions take place parallel to these, and a very complex colony results. The sarcinæ, as a rule, are decidedly larger than ordinary cocci, though not as

large as yeasts; the different cocci of each group usually vary in size amongst themselves, the younger forms being the larger. Most of them stain by Gram, but this test is hardly necessary, as they may be readily recognised in unstained wet preparations.

They occur in profusion (often mixed with yeasts) in many cases of simple dilatation of the stomach, though not in all. They occur in other conditions, but are very rarely found in cases of carcinoma, and this is the only importance attaching to them.

## THE URINE

The more important investigations in which the urine has to be examined have been mentioned already. See p. 62 (tubercle bacilli) and p. 87 (gonococci).

*Methods.*—Where the examination is to be microscopical and not cultural it is not usually necessary to use a catheter specimen.

The urine is to be passed directly into a sterilized vessel (or at least a clean and dry one), the first portion being passed into another vessel and rejected.

The examination should commence by the inspection of a hanging-drop preparation, first under the  $\frac{1}{8}$ , then under the  $\frac{1}{12}$ . This will enable you to recognise the presence of motile bacilli, streptococci, other cocci, etc.; pus, blood, epithelial cells, etc., and crystals.

In most cases it is not absolutely necessary to centrifugalize the urine, since the bacteria are commonly present in large numbers, but it is an advantage when this can be done. It is not advisable to allow the urine to deposit spontaneously, as there are many chances of accidental contamination, and many common bacteria grow with great rapidity in urine.

Then pass on to film preparations, preferably from the centrifugized deposit. Prepare films in the ordinary way and stain by Gram, counterstaining by dilute carbol fuchsin. This will enable you to study the organisms more closely, and to see whether they retain Gram or not: most of them do. The staphylococcus (which appears in the urine mostly as diplococci) and the *M. ureæ* do so, and the gonococcus and the gonococcus-like diplococcus which causes cystitis are decolorized.

Where cultures are required, a catheter specimen must be used.



The catheter must be boiled, and the urinary meatus sterilized. The first portion of the urine is to be rejected, and a small quantity of the last part collected in a sterile test-tube, and the plug immediately replaced. A small quantity only is required.

**CYSTITIS, PYELITIS, ETC.**—These may be due to many organisms, either pure or mixed, and there is but little practical interest in their recognition, except in cases in which the vaccination treatment is to be tried. There is, unfortunately, no method of distinguishing between cystitis and pyelitis by the examination of the urine. The chief bacteria causing suppuration in the urinary passages are :

*B. Coli.*—This is perhaps the commonest form, and in cystitis or pyelitis due to it the urine remains acid unless other organisms gain access.

The organism can usually be identified with a fair amount of certainty by an examination of an unstained hanging-drop preparation, when numerous short bacilli will be seen in active movement, and the fluid will be found to contain pus cells. Follow this examination by making a film of the urine, staining by Gram and counterstaining by dilute carbol fuchsin, when the bacilli will be seen stained red. These appearances in an acid urine raise strong presumptive evidence of *B. coli*, but are not conclusive, as the typhoid bacillus is almost identical. Where cocci or other organisms are present, the urine may be alkaline in spite of the presence of *B. coli*.

*Proteus Vulgaris.*—This is one of the common organisms of suppuration, and produces cystitis with an alkaline urine. It often occurs in conjunction with *B. coli*, and the urine is alkaline in this case also, the proteus being more powerful as a producer of alkali (by the ammoniacal decomposition of urea) than the *B. coli* is of acid.

It closely resembles *B. coli* in appearance, and is motile; the chief points of difference are that it is more irregular in size and forms longer threads, and that some of the bacilli often fail to decolorize by Gram. In cases where the two organisms are present it is impossible to distinguish the one from the other, either in a hanging-drop or in stained films.

If it is necessary to know whether *B. coli* or *B. typhosus* is present along with *Proteus vulgaris* in an ammoniacal urine, the only method is to plate out some of the urine on gelatin

(see p. 103), making several plates with different dilutions; as a rule, a minute trace of the urine is all that is necessary. Typhoid and coli form small, semi-translucent, greyish colonies which do not tend to spread very much, whilst proteus forms small grey colonies which form radiating branches and which liquefy the gelatin, forming a saucer-like excavation with a little white mass of growth in the centre.

*Streptococci* occur occasionally as independent causes of pyelitis or cystitis, and in these cases I believe the prognosis to be somewhat worse than in the other forms.

*Staphylococci* usually occur as a secondary infection of other forms of cystitis. The *M. ureæ* is a frequent cause of ammoniacal decomposition of the urine, and is often mistaken for a staphylococcus; the two are indistinguishable under the microscope, but staphylococci liquefy gelatin rapidly and *M. ureæ* does so slowly. Their separation is of no clinical importance in these cases.

The *M. ureæ* appears to be identical with the common skin-coccus, which is the most common and characteristic organism of the epidermis. It is a coccus which very frequently occurs as a contamination in cultures, and, as a consequence, has been accused of causing an abundance of diseases, including cancer.

*Gonococci*.—When these are found in the urine it is necessary to consider whether they come from the bladder or urethra. To do so it usually suffices to see whether they occur in all parts of the urine, and not simply in the first portions, which wash the pus from the urethra.

A caution is necessary in the diagnosis of gonorrhœal cystitis, as some cases of inflammation of the bladder (with acid urine) are due to an organism closely resembling the gonococcus, but a little larger and more variable in size: I believe it to be *M. catarrhalis*. In cases where gonorrhœal cystitis is suspected make a culture on ordinary agar or on blood-serum. The diplococcus in question grows readily, the gonococcus does not.

*Typhoid Bacilli*.—These are rare causes of cystitis, but are commonly found in the urine during and after an attack of typhoid fever. When they produce cystitis the urine remains acid.

They cannot be distinguished from *B. coli* except by rather complicated cultural tests or, less certainly, by means of the agglutination reaction. In cases where they are suspected the

urine must be plated out on gelatin, and several small greyish, semi-transparent, non-liquefying colonies picked out with a straight platinum wire and each transplanted to a fresh agar tube. After twelve to eighteen hours' incubation there should be a delicate greyish growth, with a slight tendency to spread from the line of inoculation. This is to be tested by performing Widal's reaction with it, using the blood from a patient who is suffering or has suffered from typhoid fever, and whose blood is known to give a Widal's reaction in a high dilution—say, 1 in 200. If the blood clumps the cultures you have obtained from the urine when used in the same dilution, the organism is almost certainly the typhoid bacillus.

The importance of this examination is that the typhoid bacillus may be excreted in the urine for years after an attack of typhoid fever, causing no symptoms, but remaining a very potent cause of infection. Since this is a source of such danger to others it is advisable to make use of the services of an expert (who will use better methods than that described) in the examination of a suspected case. The escape of the bacilli may usually be stopped by the administration of urotropin.

BACTERIURIA, or BACILLURIA, is a term which should be restricted to the escape of bacteria in the urine without the presence of pus and without clinical evidence of cystitis, pyelitis, etc. The organisms may be very variable; *B. coli* is perhaps the most common.

The disease may be diagnosed when a urine which contains numerous bacteria is found on several occasions to be free from pus.

## THE COLLECTION OF FLUIDS FROM SEROUS CAVITIES

A bacteriological examination of the inflammatory exudates which collect in the various cavities of the body often yields important information as to the nature of the morbid process, suggests treatment, and influences our views as to the prognosis of the condition. This is especially the case with the fluids which collect in the pleura, the membranes of the brain and cord, and the joints. In some cases all the needful information may be obtained by the examination of stained films, cultures being unnecessary; and in these cases no antiseptic or aseptic precautions

(other than those which are dictated by the interests of the patient) are necessary. But in the greater proportion of cases this is not enough, and cultures must be obtained. To this end it is *absolutely essential* that the most scrupulous precautions should be taken against contamination of the fluid by the organisms which are constantly present in the air and in the skin, or the results will be worthless. The precautions taken must be as complete as those which are used before an operation upon a joint. Indeed, a fresh precaution has to be taken, for whereas the presence in the skin of a small quantity of an antiseptic would not be detrimental to a surgical operation, it might, by getting into the fluid, nullify a bacteriological examination. Hence the skin must be aseptic, and free from any antiseptic chemical.

The technique, as far as aseptic precautions are concerned, is as follows: The skin at the region to be punctured is first thoroughly cleaned with soap, hot water, and (if the patient can stand it) a nail-brush. Then layer after layer of some reliable antiseptic lotion is painted on, each layer being allowed to soak in before the next is applied. The most suitable lotions for the purpose are perchloride of mercury (1 in 1,000), biniodide of mercury (1 in 500 of methylated spirit), or carbolic acid (1 in 20).

After being allowed to act for at least ten minutes, the skin is to be thoroughly cleansed with methylated spirit; this should be rubbed in with a piece of cotton-wool, and should be poured copiously over the area. The operation may now proceed.

Where possible it is preferable to apply a dressing of lint soaked in one of the above lotions (which need be of only half the strength) for a few hours.

The puncture may be made by using some sort of exploring syringe, or a hollow needle without any means for aspiration. The former is used for the removal of fluid from the pleura or synovial cavity, the latter in performing lumbar puncture. But it is necessary that the whole of the instrument used should be rendered sterile by heat; chemical antiseptics are as a rule inadmissible. In the case of a hollow needle no difficulty occurs; some hypodermic syringes, however, will not stand boiling, and these are useless for the purpose, as the apparatus which is to be used must be boiled for at least five minutes.

We shall now deal with the most important cavities of the

body, describing the methods to be employed in the investigation of the inflammatory exudates which they may contain, and the inferences which may be drawn from the results of the examination.

## THE PLEURA

There is but little to be said about the method to be employed in the collection of fluid from the pleural cavities. The most careful antiseptic precautions are to be taken, and the region to be punctured should be decided by consideration of the physical signs.

The examination of the fluid thus obtained may be either microscopical, cultural, or by injections into animals. If the latter are required (and inoculation should be performed in all cases where a tuberculous origin is suspected) a considerable quantity of the fluid—an ounce or more—should be enclosed in a bottle which has been sterilized by boiling, and forwarded at once. A drachm or more of 10 per cent. sodium citrate solution (boiled) should be added to prevent coagulation.

Where the diagnosis is to be made by cultural methods, and the cultures are not to be made on the spot, the fluid is best stored or sent to a laboratory in pipettes. These are to be filled from the syringe direct; the needle is to be removed, and the end of the pipette (sterilized by being passed through the flame) is passed into the fluid, and filled by gentle suction at the other end. Each end is then sealed in a flame, care being taken not to heat the fluid. Two or three such tubes should be sent.

*Clear* fluid from the chest rarely shows any micro-organisms on microscopical examination. Cultures are usually sterile; where streptococci or pneumococci are found the inflammation is likely to pass on into suppuration. The great majority of these cases of "simple" acute pleurisy are really due to the tubercle bacillus, but their true nature is difficult to determine except by inoculation experiments. A cytological examination of the fluid should be made, and in tuberculous cases the cells present will usually be found to be lymphocytes, with an occasional admixture of blood-corpuscles (see p. 237). If the fluid does not clot spontaneously, it may be very thoroughly centrifugalized, and films prepared from the deposit and stained for tubercle bacilli in the ordinary way; but they are not always found even in true cases of tuberculous pleurisy. Where the fluid coagulates spontaneously, the best plan is to allow the clot to retract until it has shrunk to a small

volume, to remove it from the rest of the fluid, allowing all that will to drain away, and then to digest the fibrinous mass in an artificial digestion mixture (pepsin and 0·2 per cent. HCl) until completely dissolved. The resulting fluid is now centrifugalized or allowed to stand for a day or so (in which case some thymol should be added to prevent excessive growth of bacteria), and films prepared from the deposit, which will contain the tubercle bacilli. The advantage of this method is that all the bacilli in four or five ounces of pleuritic fluid may be entangled in the clot, and concentrated into a comparatively small bulk. The tubercle bacilli resist peptic digestion for a long time, but other organisms do not, and the method is not available for them.

PURULENT pleurisies (empyemata) may be caused by many organisms, the most common being the pneumococcus, streptococci, staphylococci, and the tubercle bacillus.

The *pneumococcus* is readily demonstrated by a microscopical examination, the method to be employed being the same as that previously described.

The pus in these cases is thick and creamy, and of a greenish colour; after it has stood for some time a thin layer of a greenish fluid appears upon the surface.

When an empyema is due to the pneumococcus *alone*, no other organisms being present, the prognosis is distinctly better than in cases in which other organisms are present, and the patient often recovers after simple aspiration. This is especially the case in children, in whom empyema is due to this organism in a very large number of cases, certainly over 90 per cent.

If cultures are made in pneumococcic cases, it may be noted that occasionally very few of the organisms appear to grow into colonies, as far as can be judged by a comparison between the numbers of cocci present in the films and of colonies on the tubes. This indicates that the majority of cocci are dead, and this makes the prognosis better. The prognosis is also good in cases in which very few cocci are present, and in those in which the cocci that are present are largely contained in the leucocytes; in this case they may lose their power of retaining Gram's stain.

The *streptococcus* is also readily demonstrated by a simple microscopical examination; it grows readily on agar, forming small round colonies, which do not tend to coalesce and are more opaque in the centre than at the periphery.

The pus is not generally very thick, and has a yellow colour

It separates into two layers, the upper transparent layer being much more abundant than is the case with pneumococcic pus.

This form of empyema is rare in children, but is perhaps, on the whole, the commonest one in adults. The prognosis is much worse than in the pneumococcic cases, and thorough drainage and resection of the ribs is essential.

*Staphylococcic* empyemata, according to Netter, are very rare; the single case in which he found the staphylococcus alone was secondary to ulcerative endocarditis. He also states that when this organism is found in the pus tubercle bacilli are often present as well. The prognosis of these cases, therefore, appears to be bad.

The *tubercle bacillus* is responsible for a comparatively small number of cases, and the results of operative interference are not gratifying. The prognosis is worse than in any other form of the disease.

The pus is usually white in colour, and thin and watery. It may contain small masses of white caseous material. The leucocytes which it contains are nearly all lymphocytes, unless a secondary infection with pus organisms has taken place.

The diagnosis may be made from a careful microscopical examination, but to this end *it must be careful*, as the bacilli are present in but scanty numbers.

If *no* organisms are found after a thorough microscopical examination, the inference is that the case is tuberculous. If a cultural examination is also negative the inference becomes almost a certainty.

The empyemata arising from rupture of the œsophagus, stomach, intestine, etc., into the pleura, in those due to an external wound with free contamination of the membrane and its contents, and in those due to the rupture of very foul tuberculous vomicae, contain vast numbers of organisms of all kinds—bacilli, cocci, etc.—mixed together. These fluids usually smell badly, and are of very evil omen.

Lastly, in a few cases other organisms, such as the typhoid bacillus, may be found.

Having these facts in view, the practitioner is recommended to proceed to examine cases of purulent pleurisy in the following manner: The pus is to be withdrawn with a hypodermic needle or exploring syringe, and a few drops deposited *at once* on the surface of a culture-tube of agar, spread well over the surface with a platinum loop, and incubated at the temperature of the body.

The microscopical examination is made in the manner described for pus, a simple stain and also Gram's stain, with dilute carbol fuchsin as a counterstain, being used. The presence of streptococci, staphylococci, and pneumococci will be revealed; bacilli may be present, and in this case it should not be forgotten that the *tubercle bacillus* stains by Gram's method. If no organisms are found in these films, or if there are organisms which resemble the tubercle bacillus in general appearance, another specimen should be submitted to *prolonged* staining in hot carbol fuchsin and decolorization in dilute sulphuric acid, and thoroughly searched for the tubercle bacillus. If the result is negative, several other films should be searched.

The cultures are to be examined after twenty-four hours' incubation. The pneumococcus will produce tiny colourless colonies on the surface of the agar; the streptococcus forms similar small colourless colonies, but these are distinctly more opaque in the centre; staphylococci form opaque white or yellowish colonies which, after longer incubation, spread out, coalesce, and cover the surface of the agar with an even film like a streak of paint; and the tubercle bacillus does not develop. Films should be made from the cultures, stained and examined. The cultural examination is of great value, but much can be made out by the examination of stained films made directly from the pus.

### FLUIDS FROM JOINTS

The technique of the process of withdrawing these fluids is exactly the same as in the case of pleurisy; the needle will naturally be inserted at a point where there is definite evidence of the presence of fluid, and where it lies near the surface.

The bacteriological examination is conducted on exactly similar lines. A few drops of the fluid should be allowed to flow on to the surface of a sloped tube of agar, and the culture obtained after twenty-four hours' incubation examined in the manner already described. Films should also be made directly from the fluid, and some stained by Gram's method and others by a simple stain such as carbol thionin.

A great number of organisms may be present: the streptococci, staphylococci, the pneumococcus, gonococcus, and tubercle bacillus, are the most important. The coccus which has been described by several observers as the cause of acute rheumatism cannot be considered as of diagnostic importance at present; the same remark



applies to the bacillus which is possibly the cause of rheumatoid arthritis.

*Streptococci* are readily distinguished on microscopical examination, and may be present even if the fluid is perfectly clear. When they are present in a joint which is not the seat of a perforating wound, they indicate a general infection with the streptococcus, ulcerative endocarditis, etc., and the prognosis is most grave. The author was enabled to diagnose a case of streptococcic septicæmia a few hours after the onset of symptoms by finding numerous chains in a single drop of clear fluid aspirated from the knee-joint. The clinical aspect was at that time very similar to that of severe rheumatism, and the case had been so diagnosed.

In such cases the use of antistreptococcic serum offers some hope to the patient, and should be tried.

*Staphylococci* are generally found in cases of arthritis due to perforating wounds, or in the course of a general infection. They may also occur along with the gonococcus in cases of gonorrhœal arthritis.

The *pneumococcus* occurs in general infection from a primary focus in the lung, middle ear, etc., or in the course of ulcerative endocarditis, and may also occur as a primary infection—at least, in cases in which no other lesion is found. The prognosis appears on the whole to be fairly good in these cases of suppurative arthritis of pneumococcic origin, and complete recovery with a fully movable joint may occur.

The *gonococcus* occurs in some cases of gonorrhœal arthritis; it may be present in pure culture, or it may be mixed with other organisms, especially the pus cocci. In other cases of gonorrhœal arthritis no bacteria are found, either microscopically or on cultural examination, and in these the bacteria have probably died out before the fluid was withdrawn or are localized deep down in the tissues.

The *tubercle bacillus* may be found in cases of tuberculous synovitis, but it is more probable that the most careful search will be unsuccessful. If bacilli having the general appearance of this organism are found in the Gram specimen, the carbol fuchsin method of staining should be applied to a fresh film.

Fluid from a joint may be sterile in cases of tubercular synovitis, gonorrhœal arthritis, synovitis due to an aseptic injury, rheumatism, gout, or in rheumatoid arthritis, etc.

## LUMBAR PUNCTURE

Fluid may be removed from the spinal meninges for a bacteriological or other examination by means of Quincke's lumbar puncture. The information furnished by this means is often of very great value; in fact, Osler says that "during the past ten years no single measure of greater value in diagnosis has been introduced." The process is simple, easy, and entirely devoid of danger, and can be carried out without an anæsthetic. I have now performed this operation over three hundred times, and have only seen bad after-effects (in all cases temporary) in three or four cases, in all of which eucaïne had been used as a local anæsthetic. I have therefore abandoned the use of this drug, and now employ only ethyl chloride locally. On the other hand, a very large amount of benefit is often derived from it, and it must be regarded as the most useful therapeutic agent at our disposal in the treatment of meningitis, especially chronic forms; one case at least of tuberculous meningitis has been cured by repeated punctures. It acts, of course, by relieving the high intracerebral tension and by removing some of the toxin-containing cerebro-spinal fluid. In basic meningitis I have seen several cases in which the patient's life was saved by it: the urgent pressure symptoms were relieved on several occasions, the relief lasting a few days, and he was thus enabled to tide over the attack, uninterrupted and complete recovery resulting. In a case in which I performed the operation recently a single puncture was followed by immediate relief, though the symptoms were most grave, and there has been at present (after a month) no recrudescence. Great temporary relief may also be given in the severe headache of uræmia and chlorosis.

It should never be done on a "walking" patient, since if too much fluid is drawn off headache or vomiting are said to result; these soon pass off if the patient rests in bed.

*Requisites.*—1. A suitable needle. In children the spinal meninges will be reached at a depth of 3 to 4 centimetres (roughly 1 to 1½ inches), whilst in adults the depth may be twice as great. The needle should not be less than 2½ inches long for an infant and 4 inches for an adult, and should be sharp and strong. An antitoxin needle will usually serve very well. A syringe is unnecessary, and the fluid should never be sucked out of the

spine, or injury to the nerve-roots may result. The needle should always have a sharp and stiff wire inside it when the puncture is made, otherwise it may become blocked by a shred of fibrous tissues picked up during its passage through the parietes, and time may be lost in sterilizing a wire with which to clear it. Another use for the wire arises from the fact that when the intracerebral pressure is low the needle may push the membrane in front of it, instead of perforating it: when this is the case a short sharp push with the wire will probably puncture the membrane, and the point of the needle will slip in. A piece of steel wire is best.

Since cultures may have to be taken, it is advisable to have some sort of a handle which may be sterilized with the needle and avoid any necessity for a very elaborate sterilization of the hands. I use a pair of artery forceps, one blade of which is passed inside the barrel and the other outside, and the instrument clipped on.

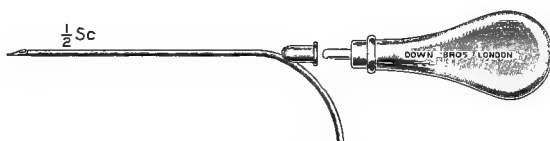

FIG. 30.—AUTHOR'S NEEDLE FOR LUMBAR PUNCTURE.

The two are sterilized together and the forceps used as a handle, and not removed until the puncture has been made. Where a sterilizer large enough to take the two instruments fixed together is not at hand the needle may be placed point downward in a test-tube half full of water, and the forceps inserted as far as it will go by its side. The tube is boiled for ten minutes and the needle removed by clipping it with the forceps, as above. The handle will not be sterilized, but that does not matter.

I have devised a curved needle with a handle fitting into a socket (Fig. 30), which also answers well. It has the advantage that it can be put in a wide tube plugged with cotton-wool, sterilized by dry heat, and taken to the bedside ready for immediate use.

2. Materials for disinfection of the patient's skin and (if cultures are to be taken) the hands of the operator. Hot water, soap, alcohol, ether, perchloride lotion (1 in 1,000).

3. Apparatus for boiling the needle in a dilute solution of washing soda.\*

4. Spray for local anæsthesia. If this is used the hard plaque of skin adds considerably to the difficulty of the operation. If, however, the region be frozen twice, and allowed to thaw after each freezing, the skin will be found to have resumed its normal texture and to be very fairly anæsthetic.

5. Two or three test-tubes sterilized by dry heat and plugged with dry cotton-wool.

6. If cultures are to be taken, the tubes of medium should be inoculated at the time of the operation if possible. The medium required will depend to a great extent upon the nature of the organism which is expected. If there are no indications upon this point, the most suitable is solidified blood-serum, but in default of this ordinary agar will answer well. If the case is thought to be one of cerebro-spinal fever, the most suitable medium for the cultivation of the specific organism (*Weichselbaum's Diplococcus intracellularis*) is alkaline 5 per cent. glycerin-agar, and a couple of tubes of this should be at hand, as well as blood-serum or ordinary agar.

*Process*—I. *Preliminary*.—As in removal of fluids for bacteriological examination from other parts of the body, it is better if the skin can be sterilized some hours before the operation, and a pad soaked in an antiseptic fluid kept on the area until the last moment. This is usually impracticable, and the process will be described as if it were performed at a single visit.

Put the needle to boil in a weak solution of washing-soda, and proceed to the disinfection of the patient's back. When the needle has boiled for five minutes, remove the vessel from the flame and allow it to cool without removing the needle.

Place the patient on his left side, and find the processes of the second, third, and fourth lumbar vertebræ. A line drawn between the upper points of the iliac crests usually cuts the spine at the upper edge of the spinous process of the fourth lumbar vertebra. Scrub the skin in this vicinity with soap and hot water; wash the region with alcohol and then with ether, and allow it to dry; paint on several layers of perchloride lotion, allowing each to soak in before the next is applied; cover the region with a piece of lint

\* If possible the needle should be sterilized by dry heat previous to the operation, and kept in a tube plugged at both ends with cotton-wool, as in the method recommended for the collection of blood for bacteriological examination.

soaked with lotion, and proceed to disinfect your hands. Lastly, pour some alcohol on to the skin of the patient's back to wash off the excess of the antiseptic.

2. *Operation—Position.*—Get the patient (still lying on his left side) to draw up his knees so as to flex his back somewhat, and to turn partly over on to his face.

Identify the processes of the third and fourth lumbar vertebræ, and mark the centre of the space between them by means of the index-finger or thumb of the left hand. If local anæsthesia is to be employed freeze the skin round a point about  $\frac{1}{8}$  inch to the right of the middle line, opposite the spot marked by your

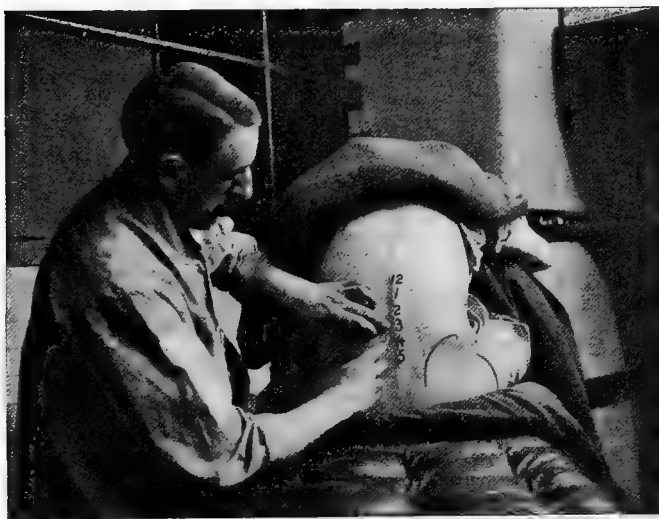

FIG. 31.—OPERATION OF LUMBAR PUNCTURE WITH PATIENT IN SITTING POSITION.

left finger or thumb. Take the needle in the right hand, holding it like a pen, and enter it at a point level with the centre of the interspace, and 1 centimetre (a little less than  $\frac{1}{8}$  inch) to the right of the middle line. Direct it *forwards, slightly upwards, and slightly inwards*, and press it in with a steady and uniform pressure; this must be applied accurately in the axis of the needle, or the latter may bend and take a wrong direction.

If the needle strikes against bone withdraw it almost completely, and push it on again after changing its direction slightly. If bone is again encountered it may be advisable to try again in the interspace between the second and third processes.

If the patient is able to do so without harm, it is much easier to perform the operation with him sitting in a chair leaning over the back or on the edge of the bed with his head nearly between his knees, so that the spine is bent into a convex curve; by this means the spinous processes are rendered more prominent and the spaces between the laminae are made wider (see Fig. 31). The operation is thus made much more easy, and the method is usually preferable in cases of tabes or general paralysis, where the fluid is collected for a cytological examination only, and the patient is in good general health. But the method with the patient on his side should also be learnt.

3. *Collection of Fluid and Inoculation of Media.*—The first few drops of fluid which escape may be stained with blood; in this case they should be rejected. Allow a few drops of the fluid to flow *directly* on to the surface of the medium without touching the glass. Collect also some of the fluid (1 to 2 drachms) in the sterilized empty tube. If no fluid flows through the needle, it is *presumptive* evidence against the presence of acute meningitis. A “dry tap” may, however, occur from plugging of the needle with fibrin, or from its point coming in contact with a nerve root (Osler), and in some cases of meningitis the purulent exudation is too thick to flow through the needle. In one case in which no fluid could be obtained by repeated punctures the venous sinuses of the brain were found to be thrombosed: a frequent cause in meningitis is the closure of the foramina in the roof of the fourth ventricle.

The force of the flow should be noted. In health it flows out slowly, whilst in meningitis it runs faster, and may even spurt out a foot or more; the same thing may happen if there is a cerebral tumour, uræmia, or other cause of increased pressure.

4. *Examination of the Fluid.*—(a) *Naked-Eye.*—When meningitis is present the fluid is always more or less turbid, and some observers hold that the turbidity is greater in proportion to the severity of the case. Osler has pointed out that the fluid may be alternately turbid and clear, being clear during the remissions and turbid during the exacerbations of the disease. Blood-stained fluid may occur in meningitis or from hæmorrhage into the cerebral or spinal meninges apart from inflammation.\* The presence of clear fluid affords strong evidence of the absence of meningitis, but in tuberculous meningitis the amount of turbidity

\* See also p. 242.

may be very slight. It should be estimated by comparing the fluid with some distilled water in a clean test-tube of the same size in the two cases.

(b) *Microscopical*.—Prepare films of the exudate in the manner recommended on p. 135 if the fluid is thin and watery; if it is thick and purulent, treat it like ordinary pus. Stain by any of the methods recommended for the examination of the blood (Jenner's stain being most convenient), and examine.\*

The presence of leucocytes (except in very small numbers) indicates meningitis. If the bulk of the leucocytes are lymphocytes (indicated by their small size, large, circular, deeply staining nuclei, and absence of granules) the presumption is that the case is one of tuberculous meningitis. In acute meningitis due to other bacteria the chief cell is the polynuclear leucocyte; this may be recognised by its larger size, its twisted (apparently multiple) nucleus, and, if the staining method has been appropriate, by the presence in its protoplasm of minute granules which stain with eosin. The fluid may also contain red blood-corpuscles and shreds of fibrin.

(c) *Chemical*.—Cerebro-spinal fluid removed from a person who is not suffering from meningitis contains a very minute amount of albumin, while when the meninges are inflamed the quantity is greatly increased. The method of testing these small amounts of albumin quantitatively is hardly within the reach of practitioners; if a considerable amount of fluid has been obtained, a small quantity should be tested by heat and acetic acid, and the amount of opacity noted. This should be very slight, not more than what would be called a "faint haze" in urinary work.

Another test which has almost escaped notice, but which I regard as one of the most important, is that for the presence of sugar. For this (as for the testing for albumin) the clear supernatant fluid left after centrifugalization should be used. In health, sugar is present in considerable amount (about 0.06 per cent.), and Fehling's solution is vigorously reduced; in meningitis, sugar is either reduced to a trace or, much more frequently, completely absent. I have only found this test fail once in about a hundred cases (even in this one the diagnosis was never made absolutely certain), and regard it as the most certain single sign of meningitis.†

\* The cytology of the cerebro-spinal fluid is dealt with more fully under the heading of Cyto-diagnosis.

† Since writing the above I have met with several cases of tuberculous meningitis in which sugar was present. The reduction of the Fehling is, however, but slight, and the oxide may not appear for several minutes.

[There are also characteristic chemical changes in uræmia, to which I have paid a good deal of attention of late. In health the cerebro-spinal fluid contains about 0.035 to 0.04 per cent. of urea, 0.7 per cent. of chlorides, and has a freezing-point of  $-0.56^{\circ}$  C., or thereabouts. In renal disease in which the kidneys are acting well these figures are but slightly disturbed, but in uræmia there is abundant evidence of retention of soluble substances. The urea increases greatly—the maximum I have seen being 0.4 per cent.—the chlorides may rise to 1 per cent., and the freezing-point is depressed. I believe this to be the simplest test of the functional capacity of the kidney, the chemical examinations being easy in a substance of such simple constitution as the cerebro-spinal fluid. It is occasionally of value in patients found unconscious. In one such case I was able to exclude uræmia definitely, though the urine contained albumin and casts: it turned out to be a case of poisoning. In uræmia there is often the additional advantage of its affording a relief to some of the symptoms. Further details are outside the scope of this work.]

(d) *Bacteriological*.—The chief organisms which cause acute meningitis are given in the following table, which is modified from one given by Osler:

**Primary** (*i.e.*, not dependent on an obvious lesion elsewhere in the body).

1. Cerebro-spinal fever—

(a) Sporadic } Weichselbaum's diplococcus, or meningococcus.  
(b) Epidemic }

2. Pneumococcic—

(a) Pneumococcic infection of meninges *alone*, not dependent on disease of distant parts of the body.  
(b) Pneumococcic infection of meninges occurring as part of a general septicæmia without obvious primary lesion. } Pneumococcus.

**Secondary.**

A. To direct extension from local disease of the cranium, middle ear, fossæ, spinal column, etc.

Pneumococcus.

Staphylococci.

Streptococci, etc.

B. To septicæmic infection due to disease in a distant part of the body.

(a) Pneumococcic—

Secondary to pneumonia, endocarditis, etc.

Pneumococcus.



- (b) Pyogenic—  
 Secondary to abscesses, etc., and occurring as a part of a general infection.  
 Staphylococci.  
 Streptococci, etc.
- (c) Gonorrhœal—  
 Secondary to gonorrhœa.  
 Gonococcus (rare).
- (d) Tuberculous—  
 Secondary to tuberculosis of other regions.  
 Tubercle bacillus.
- (e) Miscellaneous—  
 Secondary to typhoid fever.  
 Typhoid bacillus (rare).  
 Secondary to influenza.  
 Influenza bacillus (rare).  
 Secondary to anthrax, etc.  
 Anthrax bacillus, etc. (rare).

Of these, the organisms which are most likely to occur are :

The tubercle bacillus }  
 Meningococcus } accounting for about 90 per cent. of cases.  
 The pneumococcus.

Streptococci and staphylococci in secondary cases due to spread from ear, etc.

And this shows roughly the order of frequency.

*Preparation of Films.*—If the fluid is thick and purulent, films should be prepared, dried, and fixed in the ordinary way. If the fluid is thin and watery, it should be centrifugalized or allowed to stand for some hours. A certain amount of coagulation will take place, and the sediment which collects will contain the bulk of micro-organisms. The clear fluid should be poured off and used for testing chemically, and the sediment used for the preparation of films, of which several will be required. The subsequent examination will depend to some extent upon the nature of the organism which is probably present; for general purposes stain one or more films with Löffler's methylene blue (two minutes), wash, dry, mount, and examine.

Streptococci and staphylococci will be readily recognised by their morphological characters. If diplococci are present they may be pneumococci, Weichselbaum's diplococci, or gonococci. Stain a film by Gram's method and counterstain in dilute carbol fuchsin in the method described for the gonococcus. Pneumococci will retain the violet stain, while Weichselbaum's organism and gonococci will be coloured red.

Weichselbaum's *Diplococcus meningitidis intracellularis* is now generally considered to be the specific cause of cerebro-spinal fever. It is a diplococcus which varies very considerably in size, but is usually rather smaller than the gonococcus. The opposed surfaces of two cocci making up the pair are usually somewhat flattened, but this is not so marked as in the latter organism. It is often contained within the polynuclear leucocytes, but is not grouped in large numbers in a single cell—others being free—as is usually the case with the gonococcus (see Plate III., where the two organisms are contrasted). The two also differ in their cultural characters and in their pathogenicity to animals. If any question should arise as to which of the two is present in the meningeal exudation in a case in which no cultures have been taken, other evidence of gonorrhœal infection should be sought for.

Still's diplococcus of posterior basic meningitis cannot be distinguished from the *D. meningitidis* by its morphological characters alone, and many bacteriologists think the two organisms are in reality identical. The truth seems to be that the organism which we call the meningococcus is a very variable one, some forms being much more easily cultivated than others, and also differing in a few other minute points. Yet these forms appear to occur indiscriminately in true epidemic cerebro-spinal meningitis and in posterior basic meningitis, and these diseases are quite indistinguishable on pathological grounds.

*The Rarer Causes of Meningitis.*—The bacilli of typhoid fever, anthrax, influenza, etc., may also be recognised in the methylene blue specimen, and should be identified (if possible) by a careful study of their morphological appearances and reaction to Gram's stain.

If no organisms are found in the methylene blue specimens after a careful search, and if the characters of the fluid are such as indicate that meningitis is present, the presumption is that the case is one of tuberculous meningitis. Films should be stained in the method already described and carefully searched; the bacilli are present in very scanty numbers, and many films may have to be examined before one is found.\*

\* Lenharz adds a shred of clean cotton-wool to the fluid. This sinks slowly to the bottom, and is withdrawn after some hours, spread on a slide, dried, and stained for tubercle bacilli. The author has had no experience of this method, but Mr. Leedham-Green informs him that it is of considerable value. (See also p. 138).

*Cultural Examination.*—The tubes which have been inoculated by allowing the fluid to drop directly on to the surface of the medium are to be incubated for twenty-four hours at the body temperature. Streptococci, staphylococci, pneumococci, and the rarer organisms, will probably have developed by this time, and will have formed colonies such as have been previously described. Weichselbaum's diplococcus forms (on blood-serum) "round, whitish, shining, viscid-looking colonies, with smooth, sharply defined outlines which attain a diameter of 1 to 1½ millimetres in twenty-four hours." The colonies on agar are similar, but slightly larger, and the growth may become confluent.

If no colonies appear on blood-serum or agar at the end of forty-eight hours, the case is probably due to the tubercle bacillus or the gonococcus. In some cases of cerebro-spinal fever the diplococci in the exudate are all dead, and cultures remain sterile.

#### INTERPRETATION OF RESULTS.

The discovery of Weichselbaum's diplococcus indicates that the case is one of cerebro-spinal fever. The chief importance in making the diagnosis (apart from the fact that it may throw light upon the occurrence of several cases of meningitis within a short space of time by proving the existence of an epidemic) arises from the fact that the prognosis is decidedly better than in other forms of meningitis. Roughly speaking, about 40 per cent. of cases recover, though frequently with mental or other defects. It is in these cases that repeated lumbar puncture is of therapeutic value; it should be done whenever pressure symptoms are urgent. In these cases also great benefit can be obtained from vaccine treatment. The vaccine should be prepared from the patient's own culture, and its use carefully controlled by frequent examinations of the opsonic index. The method is, of course, useless in very rapid cases, but very good results are obtainable in the more chronic ones. In some the immediate benefit resulting from each injection is most marked.

Meningitis due to the pneumococcus may arise from dissemination from pneumonia or other pneumonic lesion, by spreading from the middle ear, etc., or may be primary. The examination of the exudate throws no light upon this point, and the cause of the infection must be sought for on ordinary clinical lines.

Tuberculous meningitis is proved by the presence of tubercle bacilli in the fluid, and is indicated by sterile cultures, absence of

bacteria from the stained films, and predominance of lymphocytes. In these cases the fluid often undergoes a very slight coagulation, delicate cobweb-like threads being observable after some hours. This is in itself strong evidence of tubercle, and if the delicate coagulum can be withdrawn, dried on a slide, and stained by Ziehl-Neelsen's method, there is a fair chance of finding bacilli entangled with it. This is not very easy to do, the best method being to fish it out with a very fine piece of capillary tubing no thicker than a pin. It is easy enough to pick it out with a platinum needle, but almost impossible to get it off the latter on to the slide.

The other varieties of meningitis do not call for special mention.

The chief value of lumbar puncture to the *surgeon* is that it enables him to diagnose a concomitant meningitis (indicating the uselessness of an operation) in cases of lateral sinus thrombosis and cerebral abscess. The fluid usually becomes bloody within twenty-four hours of a fracture of the base of the skull or laceration of the brain. This may assist in the diagnosis of obscure injuries, or of the cause of a case of unconsciousness in which no history can be obtained.

Hæmorrhage into the meninges is indicated by the withdrawal of blood-stained fluid, but it must be remembered that the first few drops may contain a small quantity of blood which has entered the needle during its passage through the tissues, while the rest is clear. Blood-stained fluid may occur in meningitis, and should be submitted to a full examination for leucocytes and bacteria.

## THE BACTERIOLOGICAL EXAMINATION OF THE BLOOD

The bacteriological examination of the blood is not so important as might be thought, as it is only in a very few diseases that pathogenic bacteria are present in the circulation in such quantities as to render the search for them in the minute amounts which are withdrawn for examination at all promising. The method is becoming of more importance daily, since promising results have been obtained in the treatment of septicæmic diseases by means of specific vaccines, which, to get the full advantage of the process, should be obtained from cultures of the patient's own bacteria.

The chief organisms which have been found in the blood are :

1 and 2. *Streptococci and Staphylococci*.—These are found in cases of septicæmia, pyæmia, ulcerative endocarditis, etc.; they always indicate an extremely bad prognosis. The chief importance which attaches to the discovery of these organisms is that it absolutely settles the diagnosis (always provided that there are no errors in technique), and that it indicates whether the use of antistreptococcic serum is advisable or not; it is useless in cases of septicæmia, etc., which are not due to streptococci.

A word of warning is necessary in the interpretation of results which indicate that staphylococci are present in the blood. These



FIG. 32.—SPIRILLUM OF RELAPSING FEVER.

organisms are constantly present in the skin, and may be found in film preparations or in cultures, unless rigid antiseptic precautions are taken. Streptococci may also occur as contaminations of cultures, but rarely occur in film specimens.

3. *Anthrax Bacilli*.—These may be detected with ease and certainty, but they are never found in the blood until it is too late to save the patient.

4. *Tubercle Bacilli*.—These are only present in very scanty numbers, and are very difficult to detect. The diagnosis of miliary tuberculosis is to be made by other methods, chiefly by that of exclusion.

5. The *pneumococcus* is found in severe cases of pneumonia (probably it might be found in most cases if a sufficiently large quantity of blood were examined) and in septicæmia and ulcerative

endocarditis when due to this organism. When found in the blood by ordinary methods it always indicates a bad prognosis, and suggests the use of antipneumococcic serum. The identification of the organism is easy and certain if present in quantities sufficient for it to be found in films.

6. *Typhoid bacilli*. (See p. 69.)

7. The *bacillus of glanders* may be found in acute cases of that disease, but its isolation and identification are matters for an expert.

8. The *influenza bacillus* is present in some or, according to some authorities, all cases of influenza. It may be searched for in films, but no importance should be attached to a negative result.

9. *The bacillus of plague*.—This organism is often present in the blood in relatively large numbers, and the disease can usually be diagnosed after a careful search through a number of suitably stained films. But the investigation of a drop of fluid drawn from the bubo (if one is present) permits of an easier and earlier diagnosis. The blood examination is of most value in the pulmonary and septicæmic forms of plague.

10. The *spirillum of relapsing fever* is easily found, for it possesses well-marked characters and is present in great numbers. The diagnosis of relapsing fever cannot be made until it has been demonstrated (see Fig. 32). It is best seen by mounting a small drop of blood between slide and cover-glass, and examining it in a perfectly fresh state, when the spirilla are easily found from the commotion they cause by pushing aside the red corpuscles.

11. The *gonococcus* has been found in the blood in a few cases of ulcerative endocarditis. Its detection by cultural methods is very difficult, and the services of a bacteriological expert should be called in if the characteristic cocci are not found in blood-films in a case in which the diagnosis of gonorrhœal ulcerative endocarditis is probable, as further information upon this point is greatly needed. We may point out that ulcerative endocarditis, septicæmia, etc., supervening in the course of an attack of gonorrhœa, are not necessarily due to the gonococcus. Any pathogenic bacteria may enter through the lesion of the mucous membrane which the gonococcus has caused.

12. The *B. coli* is present in some cases of septicæmia.

## EXAMINATION FOR BACTERIA IN FILMS

This is the easiest method in which bacteria may be found in the blood, and it does not require such a rigid antiseptic technique as is necessary if cultures are to be taken. The films are prepared and fixed in one or other of the methods which will be described subsequently (see p. 198), the only point worthy of notice being that the skin must be very thoroughly cleaned; it may be scrubbed with soap and a nail-brush, using plenty of hot water. The films need not be very thin and even.

The method of staining will depend upon the organism which is likely to be found, and more especially whether it stains by Gram's method. This is so important in this connection that a repetition of a previous table will not be out of place.

## GRAM'S METHOD.

<i>Stained.</i>	<i>Unstained.</i>
Streptococci.	Typhoid bacilli.
Staphylococci.	Bacillus of glanders.
Bacillus of anthrax.	Bacillus of influenza.
Bacillus of tubercle.	Bacillus of plague.
Pneumococcus.	<i>Bacillus coli.</i>
	Spirillum of relapsing fever.
	Gonococcus.

If the organism which is present appears in the first list, the staining process is simply that which we have described previously, and the organism will be stained dark blue or violet, and the other structures will be unstained.

If the bacteria which are present in the films do not stain by Gram's method the matter is more difficult, for any stain which colours them will colour the nuclei of the leucocytes also. Jenner's stain may be used, or the film may be stained by eosin and methylene blue separately. The organisms will then be stained blue. Carbol thionin is even more suitable, as the colour which it imparts to the nuclei of the leucocytes is not deep and the red corpuscles are merely tinged. This is the strain which we recommend for general use, and in cases in which the nature of the organism (if one be presented) is entirely unknown.

If bacteria are detected by any of these methods their nature must be recognised by a consideration of their morphological features and staining reactions.

## MALARIA

The blood in a suspected case of malaria may be examined fresh or in stained films. Of these methods the former is the better, and should be used if possible. An examination of stained specimens should also be made, and is convenient, as it can be performed away from the patient and at leisure.

Fresh films are made by touching a drop of blood on the patient's finger with the centre of a perfectly clean cover-glass, so as to remove an extremely small quantity of blood. This cover-glass is then allowed to fall on to a clean slide, so that the droplet of blood may be spread out by capillary attraction and by the weight of the cover-glass, just as is the case in the method of making blood-films to be described subsequently. But the slide is not separated from the cover-glass; they are examined just as

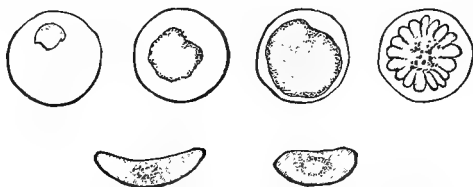

FIG. 33 —MALARIAL PARASITES IN THE BLOOD.

The dark area shows the parasite as it appears when stained with thionin.

they are, a ring of vaseline being painted round the edge of the cover-glass to prevent evaporation.

The specimen is examined with a  $\frac{1}{8}$ -inch objective, and a place found in which the corpuscles are spread in a single layer; this part is then searched thoroughly with a  $\frac{1}{12}$ -inch oil-immersion lens. The parasites are seen as pale, irregularly shaped bodies with indistinct margins, which occupy the interior of the red corpuscles, and show *amœboid movements* of greater or less rapidity. When the parasites are older they occupy a larger space in the corpuscles, and there are granules of dark pigment around their periphery. These granules are often the first indications of the presence of parasites in the examination of an unstained specimen. At a still later stage the granules will be found in the centre of the corpuscle (the hæmoglobin of which is now almost entirely removed), and the parasite will show segmentation into a larger or smaller number of spores by lines which have a radial arrangement and give the whole an appearance resembling that of a



marguerite daisy. These are only found when a rigor is imminent.

Crescents are found in the æstivo-autumnal form of malaria; they are crescentic bodies with rounded "horns," and contain a ring of pigment granules in the centre. They cannot be mistaken for anything else, and if a single one is found it affords conclusive proof that the patient has been infected with malaria.

Films for staining are made in the ways already described, and must be thin and perfect. They may be fixed by any of the methods we have recommended, the alcohol-ether and the alcohol-formalin methods being perhaps the best. They may be stained by Jenner's stain, or by eosin and methylene blue used separately; the parasites are stained pale blue and the corpuscles bright red.

A simpler stain is that recommended by Rees (*Practitioner*, March, 1901), involving the use of carbol thionin, prepared by dissolving 1.5 grammes of thionin in 10 c.c. of absolute alcohol and 100 c.c. of a 5 per cent. solution of carbolic acid. This is to be kept for at least a fortnight, and diluted with four times its bulk of distilled water immediately before use. Staining is complete in about ten minutes. Ordinary carbol thionin answers very well indeed. Thionin stains the red corpuscles a faint green, nuclei blue, and the parasites an intense purple.

In a suspected case of malaria the search should not be abandoned in less than half an hour, or, in the case of an inexperienced observer, much longer.

A fuller description of the parasite and the differences between the forms which are present in the various forms of the disease is beyond the scope of this work, and the reader is referred to the admirable special number of the *Practitioner* mentioned above.

## EXAMINATION BY CULTURAL METHODS

This is a much more difficult matter. The difficulty arises from the abundant bacterial flora of the skin; unless the most thorough antiseptic precautions have been taken the results are *absolutely useless*. They are worse than useless—they are misleading. A case of ulcerative endocarditis, for example, might be due to streptococci, but might be attributed to staphylococci on the strength of an inadequate bacteriological examination. For this reason we are chary of recommending this method of diagnosis in any hands other than those of an expert, and must

urge the practitioner not to attempt it unless he is prepared to carry it out properly in the most minute detail. It is in particular absolutely useless to attempt to obtain cultures with the blood taken from a skin puncture; it must be drawn direct from a vein, and a large quantity (not less than 1 c.c., and preferably 4 or 5, or even 10) must be employed.

One plan is to use a hypodermic needle, and to plunge it directly into a vein.\* The process may be carried out as follows:

*Requisites.*—1. An all-glass hypodermic syringe of at least 5 c.c., and better 10 c.c., capacity, preferably furnished with platinum-iridium needle.

2. Means of sterilizing the above. I personally keep the syringe always sterilized with carbolic lotion (1 in 20). After use at any time it is washed out with the lotion, a little of which is allowed to remain in the barrel, which is thus always sterile. Before use the antiseptic has to be removed, and this is effected by filling the syringe two or three times with sterile nutrient broth, a spare culture-tube being taken for the purpose. This gets rid of the waste of time involved in boiling, and the necessity for carrying cumbrous sterilizers.

Another method is to boil the instrument for ten minutes.

Or Wright's method may be adopted. Oil is heated to 150° in a metal capsule, and the syringe washed out two or three times with the hot oil. If no thermometer is at hand the temperature of the oil can be estimated roughly by dropping a crumb of bread into it. If the crumb gives off bubbles, the temperature is 100° or above; it is turned brown at 150°.

3. Materials for sterilizing the skin are described under the heading of Lumbar Puncture.

4. A narrow bandage or piece of tape.

5. A spirit-lamp (not indispensable).

6. *Culture Tubes.*—On the whole broth is the most suitable media, and rather large tubes, containing about 25 c.c. of broth, the best to use. One or two cultures on agar should also be taken.

7. Collodion, to be applied to the puncture after the operation.

*Method.*—Apply the narrow bandage to the upper arm suffi-

\* Dr. Horder has applied this method with great success, and has fully described his technique and results in the *Practitioner*, November, 1905, to which the reader is referred for further information.

ciently tightly to obstruct the venous circulation, but not tightly enough to check that in the artery; if the former do not become prominent, the patient should be made to hang his arm down, and to clench and relax his fist.

Select a large vein in the antecubital fossa, and choose, if possible, one that is *superficial* (as shown by its blue colour), not merely prominent, since a deep vein may slip in front of the needle. Avoid, if you can, a vein lying near an artery. Proceed to sterilize the skin in the ordinary way.

Next take the sterilized syringe and sterilize the point of the needle in the flame of the spirit-lamp. Proceed to make the



FIG. 34.—COLLECTION OF BLOOD DIRECT FROM VEIN.

puncture as shown in the illustration (Fig. 34). Direct the point of the needle away from the patient's body, so that it faces the blood-flow, and enter it at a point about  $\frac{1}{4}$  inch from the vein, at one or other side. (This diminishes the chance of subsequent leakage, and possibly of sepsis, organisms picked up by the needle being wiped off during the passage of the latter through the tissues.) Press it gradually onwards until the needle pierces the wall of the vein, when, in most cases, the blood will rise in the syringe, slowly pressing out the piston before it. If it does not you may make *very gentle* suction with the piston: it must not be forcible, or the wall of the vein will be sucked in and act as a valve.

In most cases the only difficulty to arise will be in entering the vein, which may slip in front of the needle if the intravenous

pressure is low or the instrument blunt. In this case the vein may be made tenser by gently massaging blood in it towards the bandage and retaining it there by a finger pressed on to the vessel.

As soon as the requisite amount of blood has been obtained,



FIG. 35.—PIPETTE FOR COLLECTION OF BLOOD FOR BACTERIOLOGICAL EXAMINATION.

remove the bandage from the upper arm, and then withdraw the needle; if you leave it on longer there may be a considerable amount of hæmorrhage into the tissues, which does no harm, but leaves an unsightly bruise.

Next make the cultures as follows: Expel nearly all the blood into one of the broth tubes and shake gently, and then put about 1 c.c. into the agar tube, and place the latter in an inclined position, so that the blood will clot in an even film over the surface.

Seal the puncture in the skin with colodion. If there is hæmorrhage into the tissues, bandage the forearm evenly from below upwards.

Undoubtedly the simplest and best of all methods is that described by James and Tuttle (*Report of the Presbyterian Hospital, New York, 1898*). "A piece of glass tubing  $4\frac{1}{2}$  inches in length, and  $\frac{1}{4}$  inch in diameter, is drawn out to a tapered end, and ground to fit the cap of a rather fine hypodermic needle. The larger end of the tube having been stopped with a cotton plug, the whole is then placed in a larger tube, and both ends of this are similarly plugged with cotton\* (Fig. 35).

"The apparatus is then sterilized by dry heat. In using it the inner tube with needle attached is removed; the skin over one of the most prominent veins of the anterior surface of the forearm, near the bend of the elbow, is selected, a piece of rubber tubing or a few

turns of a bandage being passed round the arm above with moderate pressure, in order to produce distension of vessels. The needle is then plunged into the vessel, and generally blood begins to flow by the blood-pressure itself, but any quantity desired may

\* These may be obtained from F. Ash, Edmund Street, Birmingham.

be obtained by making gentle suction, either by applying the mouth directly to the end of the tube where it is stopped with cotton, or through the medium of a small piece of rubber tubing slipped over it.

“By the above instrument vein punctures have been made in about 150 cases of a variety of diseases. At no time was any difficulty experienced in obtaining the amount of blood desired, which was generally about 1 c.c. In a few instances it was necessary to try two punctures before securing a free flow through the needle; in no case was there any local reaction whatever at the seat of puncture, nor did the patient complain of pain and annoyance.”

I used this method for four years, and found it by far the best for clinical work. The needle is carried ready sterilized, and no time is wasted in boiling it, and the whole process may be performed in five or ten minutes. The main disadvantage is that it requires a special instrument, whereas an all-glass exploring syringe should be always available.

The advisability of employing some such method in which the blood is drawn directly from a vein in place of the simple skin puncture is very apparent from the researches of Kühnau (*Zeitschrift f. Hyg. und Infct.*, 1890), who made parallel series of experiments by the two methods. He found that in cases in which the blood drawn directly from the vein remained sterile growth (mostly streptococci or staphylococci) occurred in as many as 90 per cent. of cultures inoculated from skin punctures, though the most careful antiseptic precautions were used.

The cultures thus obtained are incubated at the body temperature, and examined from day to day. The blood in the broth tube will coagulate, and the appearance of growth may be delayed by the entanglement of the colonies in the clot; sooner or later, however, the clear fluid will become turbid if bacteria are present, and subcultures can be made on agar or blood-serum, and films examined.

If colonies appear on the agar tube, they are to be carefully examined with a lens, and their characters noticed. The organisms which will be most likely to develop are streptococci, staphylococci, anthrax bacilli, pneumococci, typhoid bacilli, the bacillus of plague, or the *B. coli*; the gonococcus may also develop, for it will obtain the hæmoglobin necessary for its development from the blood itself.

*Streptococci* form small white colonies which show no tendency to run together to form a film. The centre of each colony is more opaque than its periphery.

*Staphylococci* form a more or less uniform film, the colonies extending laterally and fusing together. The growth is opaque, and is of a dead white, lemon, or orange colour, according to the nature of the staphylococcus present (*albus*, *citreus*, or *aureus*).

*Anthrax bacilli* form small white colonies, having the "barrister's wig" appearance already described.

The colonies of the *pneumococcus* are small flat white points, which do not tend to fuse together. They are difficult to see when they are young, and, in case of doubt, the tube should be returned to the incubator.

The colonies of the *typhoid bacilli* and the *B. coli* are whitish and opalescent. They usually have an angular or polygonal appearance when small, and tend to run together when older if they are thickly set. Their discrimination must be left to an expert.

The *bacillus of plague* forms white colonies which are circular or have a crenated outline; they tend to run together, and form a uniform film over the surface of the medium.

The *gonococcus*, if it develops, forms very minute transparent colonies which have been compared to droplets of dew. They do not become confluent. This organism will not grow if transplanted on to the surface of ordinary media, unless a film of blood be previously spread over it.

After cultures have been obtained they are to be examined microscopically by the method described on p. 22, and the morphological appearances compared with those of the pathogenic organisms which we have enumerated. It is especially important to test whether the organism which has been isolated stains by Gram's method or not.

## ESTIMATION OF THE OPSONIC POWER OF THE BLOOD

A very important branch of blood-work, and one that seems destined to be of great value in the future, has been introduced by Wright, who has demonstrated the presence in the blood of substances which he calls *opsonins*, and which have the power of acting on pathogenic bacteria and altering them so that they can

be taken up and digested by leucocytes. These substances are of great importance in that they appear to be the chief agents in the production of some forms of immunity. Take, for instance, the defence of the body against staphylococci. Leucocytes have no power of taking up these organisms, and if the protection of the body were entrusted to them alone a slight staphylococcic lesion would be a very serious matter. But the blood contains a certain amount of antistaphylococcic opsonin—a greater amount in some persons and less in others—and this, by combining with the staphylococci, renders them easily attacked by the leucocytes. It follows that where we can measure the amount of opsonin present we can form some estimate of the patient's resisting power against the organism in question. It is found, for instance, that the serum of patients in the early stages of staphylococcic diseases, such as pustular acne or boils, is usually very deficient in antistaphylococcic opsonins, whilst when cure takes place the amount rises above normal. These opsonins are probably specific—*i.e.*, each organism has its own appropriate opsonin: that for tubercle, for example, is devoid of action on staphylococci, and *vice versa*.

The method given is practically that used by Wright. It is a general method, and is available for almost any organism, the only points of difference arising in the preparation of the emulsion of bacteria, which differs somewhat with the various organisms. The method is a relative one. Two tests are made, one with the serum of the patient, and one with that of a healthy person, and the results of the two are compared in the manner to be described subsequently.

The process is not altogether an easy one, and requires a considerable amount of patience and some practice. Yet I know that several practitioners have been able to accomplish it, and as the test is of great importance and interest, and as it requires little in the way of apparatus, it seems right to give a description of it here.

The *requisites* are—

1. The serum of the patient to be tested.
2. That of the healthy person taken as a control.

These are best collected in Wright's curved pipettes (see p. 34). They must be taken at approximately the same time (within a few hours), since the opsonin gradually becomes inert. The test should be made not more than three or four days after the blood has been taken.

3. The emulsion of bacteria. In the case of tubercle an emulsion of dead bacilli in normal saline solution is employed. This can be obtained ready prepared from Messrs. Allen and Hanbury. If you wish to prepare it for yourself, it is necessary to take a culture of tubercle bacilli in glycerinated broth; incubate for two months; boil to kill the bacilli; filter through filter-paper; wash with normal saline solution; let the bacillary mass drain as dry as possible, and then place it in a sterile tube and immerse in boiling water for half an hour to make certain of its sterility. The yellowish mass thus obtained will keep indefinitely, and will serve for many tests. To prepare the emulsion from this, take a small portion (about as big as a grain of rice) and place it in a small agate mortar, and grind it up with the pestle; then add normal saline drop by drop until about 2 c.c. have been added, continuing to grind meanwhile. This gives an emulsion which contains isolated bacilli as well as clumps. These latter must be got rid of, and to do this it is necessary to centrifugalize for three or four minutes.

The staphylococcic emulsion is prepared by taking an agar culture not more than twenty-four hours old, adding some normal saline solution, and shaking gently so as to wash off the growth. When the emulsion is made it must be pipetted off into a small tube and centrifugalized for a few minutes. The emulsion must not be too thick, otherwise the leucocytes will take up an uncountable number of cocci; the proper density can only be judged by experience, but the emulsion should only be faintly opalescent. Emulsions of pneumococci and other organisms are made in the same way.

4. An emulsion of living leucocytes. To prepare this take about 10 c.c. of normal saline solution containing  $\frac{1}{2}$  per cent. of sodium citrate, to prevent the coagulation of the blood. This must be freshly prepared (or kept sterile, which is inconvenient), and the simplest method is to use "soloids" prepared for the purpose by Messrs. Burroughs and Wellcome (No. 2,456); one of these dissolved in 10 c.c. of water will yield the solution required.\* This is put into a centrifugalizing-tube and warmed to blood-heat. A healthy person is then pricked in the ear or finger, and his blood is allowed to drop into the fluid until 1 c.c. or more has been collected. This is then put into the centrifuge, very exactly counterbalanced, and centrifugalized until all the corpuscles have

\* This very convenient method was suggested by Dr. Whitfield.



come to the bottom and the supernatant fluid is left clear. If the deposit is closely examined the red corpuscles will be seen to be at the bottom, whilst above them there is a thin whitish layer of leucocytes. Then, with a capillary pipette armed with an india-rubber nipple, the whole of the clear fluid is to be pipetted off as close as possible to the leucocyte layer, but without disturbing the latter. Next, this layer and the upper quarter or so of the column of red corpuscles (which also contain leucocytes) are to be pipetted off and put into a small tube, and thoroughly mixed together by repeatedly sucking them into the pipette and then expelling them. The result is an emulsion of living leucocytes mixed with red corpuscles. The presence of the latter is a decided advantage. (It is advantageous, though not absolutely necessary, to rewash the leucocytes in saline solution in order to get rid of the citrate of sodium.)

5. Two Wright's pipettes. These are drawn out from a piece of ordinary glass tubing about 4 inches long and about as thick as a lead-pencil. This is held at each end, and the central portion is thoroughly softened in a Bunsen or blowpipe flame, the tube being turned round the while. When quite soft the tube is removed from the flame, and the ends then pulled firmly and steadily apart until the softened portion is pulled out into a thin tube (about the thickness of a steel knitting-needle or a little less, and a foot or more long). This will give two pipettes, and to separate them melt the central portion in a *small* flame, such as that of a wax vesta, and when the glass is softened pull them quickly apart. The whole pipette should be like this—



FIG. 36.

The lower figure represents the point, which must have as nearly as possible the shape represented in the figure. The ease and accuracy of the process depends in great measure on this being the case.

*The Process.*—1. Prepare a pipette by placing an indiarubber nipple on the thick end. Then with a grease pencil or with pen and ink make a transverse line about 1 inch from the pointed end,

The volume of fluid contained in the tube between the point and this mark is spoken of as the unit.

2. Having the patient's serum, the emulsion of leucocytes, and the emulsion of bacteria, ready in front of you, take the pipette between the index-finger and thumb of the right hand, and compress the nipple. Immerse the point beneath the surface of the emulsion of bacilli and relax the pressure on the nipple until the emulsion has risen exactly to the mark, so that you have drawn up one unit; then remove the point from the fluid and relax the pressure again, so that a *small* column of air will be sucked up. This will be quite easy if the point is a good one; otherwise it will be difficult or impossible, as the column of fluid will either refuse to stir or will oscillate violently.

Next immerse the point in the emulsion of leucocytes and draw



FIG. 37.

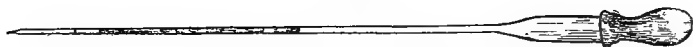

FIG. 38.

up one unit. This will be separated from the emulsion of bacteria by the short column of air. Remove the point from the emulsion and draw up a second column of air; reinsert it and draw up a second unit of leucocytes, and then a third column of air.

Lastly, draw up one unit of the serum. You will then have in your pipette (counting from the nipple towards the point) one unit of bacterial emulsion, a column of air, a unit of leucocytes, a column of air, a second unit of leucocytes, a column of air, and, lastly, a unit of serum (Fig. 37).\*

3. Put the point of the pipette on to a clean slide and express the whole of its contents, and mix them well together, sucking them repeatedly into the pipette and expelling them. When thoroughly mixed suck them into the pipette, suck up a short column of air, and seal the tip in the flame (Fig. 38).

Then place the pipette point downwards in the incubator at  $35^{\circ}$  to  $37^{\circ}$  C., noting the time exactly, and proceed to prepare a second pipette in exactly the same way, using the same emulsions

\* It is not necessary to take more than one unit, and where many estimations are being made one only should be employed, as less "cream" is required.

of bacteria and leucocytes, but the control serum instead of the patient's. Place this in the incubator by the side of the other, noting the time at which you do so. When no incubator is at hand the tubes may be placed in a vessel of water, which can be kept at blood-heat for the necessary time (fifteen minutes) with very little trouble, or the Dewar flask mentioned on p. 21 may be used.

When each pipette has been incubated for a quarter of an hour, remove it from the incubator, break off the end, fit the nipple to the thick end, and expel the contents on to a clean slide. Next mix them thoroughly together. Then prepare suitable films in the usual manner. The best method for this is the one given on p. 198, in which the film is spread on two cover-glasses. A small drop of the mixture is placed on one of the cover-glasses held in the left hand in the manner described, the second glass applied, and the two slid apart. The process is very easy, and if the cover-glasses have been properly cleaned two excellent films will result.

Most bacteriologists spread their films on slides, using a second slide as a spreader. I am convinced that this method is not so good as that given above. It is true that it renders the counting somewhat easier, since the leucocytes are all collected together at the end of the film, whereas with the cover-glass method they are scattered all over the surface. But the counts by the latter method are much more uniform, the leucocytes more defined, and there is less danger of bacilli being ground mechanically into the cells; there is always a considerable margin of error in the process, and I believe that the extra amount of accuracy obtainable in this way is quite worth the additional trouble involved.

The films have next to be stained. When the organism in use is the staphylococcus, pneumococcus, etc., Jenner's stain is as good as any; or the film may be fixed with formalin (p. 203) or perchloride of mercury (p. 203), and stained with carbol thionin. In the case of tubercle bacilli it is best to fix with saturated solution of perchloride of mercury (one or two minutes), wash, stain in the ordinary way with hot carbol fuchsin, decolorize for half to one minute in  $2\frac{1}{2}$  per cent. sulphuric acid in methylated spirit, and to counterstain for about five minutes in borax methylene blue, or in Delafield's hæmatoxylin. It is necessary to get the protoplasm of the leucocytes clearly defined, so that a powerful stain is necessary. Wash, dry, mount.

Lastly, the films are examined with the oil-immersion lens. The polynuclear leucocytes will be found to contain the bacteria, and it will be necessary to count the number in each of fifty leucocytes in both your preparations—*i.e.*, in that made with the patient's serum and in the control made with that from a healthy person. The ratio between the two gives the *opsonic index*. For example, in one case the number of tubercle bacilli contained in fifty polynuclear leucocytes taken at random amounted to 78. In the control specimen from a healthy person the same number of polynuclears contained 172. The ratio  $\frac{78}{172} = 0.45$  gives the opsonic index; it shows that the patient has less than half the normal amount of opsonin, and probably, therefore, less than half the normal resisting power to the tubercle bacillus.

The diagnostic value of the examination is considerable. In acute infections the index is almost always low to the organism causing the disease, but normal to others. For example, in a case of severe furunculosis the index to staphylococci was 0.65, and in a case of pustular acne 0.7. In a case of septicæmia due to streptococci the index (tested with a culture of streptococci obtained from the patient's blood) was 0.6 on several occasions.

When spontaneous cure takes place it is accompanied by, and is apparently due to, an increase of the opsonic power of the blood. Thus, in pneumonia the opsonic index tested with pneumococci is below normal until the crisis is reached, when there is a sudden rise above normal, so that the patient is for a short period more resistant than the healthy person. In staphylococcic lesions the rise is as a rule more gradual and irregular, and the lesions may persist when the index is high, though in most cases this heralds a rapid improvement.

The behaviour of the opsonic index in tuberculosis is very interesting. The main feature is that it is very *variable*, especially in patients in whom the disease is progressing rapidly and in those who are taking exercise. This variability is supposed to be due to auto-inoculation, bacilli being detached from the lesions and lodged in the tissues, where they act as small doses of vaccine. As a general rule it is thought that (in lupus especially\*) a high index is of favourable import, and *vice versa*, but there is not the same more or less direct relation between a high index and the process of cure that there is in pneumococcic and some other

\* Bulloch, *Trans. Path. Soc.*, 1905.

infective processes. A patient may die of tuberculosis whilst his opsonic index is high. This seems paradoxical, but the conditions are exceedingly complex, and the symptoms of pulmonary tuberculosis are due almost as much to the other organisms (streptococci, etc.) as to the tubercle bacilli itself. In miliary tuberculosis the index is often high, and shows great variations in a short time. I believe you are almost safe in diagnosing tubercle if the index is below 0·8 or above 1·2, and if it shows marked variations from day to day the probability is still greater.

A low opsonic index towards a given organism, therefore, denotes either (1) an infection with that organism, or (2) a low power of resistance, so that if the patient is exposed to infection invasion will readily take place. In such cases he should be carefully shielded from exposure, and the general health improved by fresh air, careful feeding, tonics, etc.

A high opsonic index (*i.e.*, one decidedly above normal) usually indicates that the patient has had an attack of the disease caused by the organism in question, and has overcome it. Normal persons differ very little amongst themselves; for instance, in a series of healthy persons, if the average index be taken as normal, it is unusual to find one below 0·95 or above 1·05.

A study of the opsonic index is the basis of Wright's method of treatment by means of vaccines. In carrying this out the patient's opsonic index is raised by injections of the organisms which cause the disease (carefully sterilized) in appropriate doses. These are given in a healthy part of the body, where the tissues are stimulated to produce opsonins against the organisms introduced, and these opsonins are carried in the blood to the lesion. The reason why it is necessary to estimate the opsonic index of the blood from time to time in carrying out this process is that the injection causes it to fall for a variable time (usually a few days—the negative phase), and if a second injection be given before this fall has gone off and been succeeded by a rise above the initial level, harm rather than good will follow.

The method of preparing these vaccines is roughly as follows: The cultures should in all cases where practicable be prepared from the organisms isolated from the patient himself. "Stock" vaccines may do good in some cases, especially, perhaps, in staphylococcal diseases; but in diseases due to streptococci, *B. coli*, etc., they are not nearly so likely to succeed as vaccines specially prepared: these organisms differ slightly in different cultures, and

a vaccine prepared from one variety may have little action on another. The culture should be made on agar (or blood-agar in the case of gonococci, etc.), and should be one or two days old. To each culture-tube about 2 to 5 c.c. of sterile normal saline solution are added, and the bacteria scraped off by means of a platinum needle and the tube gently shaken, so that the organisms are emulsified. The number of bacteria in this emulsion must next be counted. Wright's method is usually employed, and is carried out by mixing the bacterial suspension with blood in known proportions, making films, and counting the red corpuscles and bacteria in the same field of the microscope, so as to obtain the relative proportions of the two. The number of red corpuscles per cubic millimetre is known (or can be counted), and from that the number of organisms can be calculated. Proceed as follows: Take an opsonin pipette, and draw up one volume of blood from a healthy person, then a bubble of air, then one volume of citrate solution (p. 150), then one volume of the emulsion. Mix them together on a slide, make films on two cover-glasses, dry, and stain by Jenner's method. Proceed to count the red corpuscles and bacteria on several fields of the microscope: this will be easier if you rule four ink lines enclosing a square on the lower lens of your eyepiece, and count the objects lying therein. When you have done this, move the slide so as to get a fresh film, and count again. Do this a large number of times, and add the totals of the corpuscles and of the bacteria, and calculate the ratio between the two. (Thus in one case the total red corpuscles on the various fields were 18, 15, 20, 21, 14, 17, 10, and 15; and the bacteria 37, 26, 31, 40, 25, 30, 32, 36: the totals were 130 and 257, or, roughly, 1 to 2.) The calculation of the number of bacteria per cubic millimetre is then easy, and that multiplied by 1,000 gives the number per c.c.

Next the emulsion has to be sterilized by heat. It is placed in a test-tube, which is drawn out and sealed in a blow-pipe flame and *completely* immersed in a water-bath at 60°. After one hour it is removed, and a small amount placed on a suitable culture medium and incubated (in order to ascertain its sterility), and the tube re-sealed. If sterile, it is now to be diluted with a 0.25 per cent. solution of lysol or carbolic acid in sterile normal saline solution to such an extent that the dose required is made 1 c.c. Thus an emulsion of staphylococci was found to contain 2,500,000,000 cocci per c.c. The dose required was 500,000,000,

so that 1 part of the emulsion was diluted with four of 0·25 per cent. lysol. Lastly, it is pipetted off with a 1 c.c. pipette or hypodermic needle (of course, sterile) into 1 c.c. ampoules, previously sterilized by heat.

The dosage varies with different bacteria and with different cultures, and the following are approximate only. With staphylococci it varies between 50,000,000 and 1,000,000,000, 500,000,000 being a good average. Meningococci may be given in the same doses, or rather smaller: with a young child I commence with 25,000,000. *B. coli* is usually rather toxic, and may cause a good deal of local and general reaction, and the first dose should not exceed 20,000,000; it may subsequently be increased somewhat if thought necessary. With pneumococci the dose may be 50,000,000 to 100,000,000 or more, and with gonococci 50,000,000 to 250,000,000.

The dose of tuberculin (T. E. or T. R.) is  $\frac{1}{10000}$  milligramme to  $\frac{1}{30000}$  milligramme. The material is bought in bottles containing 1 to 5 c.c., with the strength stated on the label, and dilutions prepared with 0·25 per cent. normal saline solution, previously sterilized.

As regards the question as to the necessity of controlling the injections by observations of the opsonic index, it is difficult to speak with confidence. With staphylococci it is probably unnecessary, and a small dose every week, or a larger one every fortnight, will usually yield good results. In the case of tubercle I am doubtful as to its advantage, but usually carry it out for one or two injections in order to make sure that I am not dealing with a patient with a very long negative phase, in which case I lower the dose. In the other organisms I prefer, if possible, to take the index regularly, and I believe this is especially desirable in the case of meningococcal infections.

The results of this method of treatment are extremely good in the case of staphylococcal lesions (boils, acne, etc.), though in some chronic cases a long course is necessary. In the complications and sequelæ of gonorrhœa (iritis, arthritis, etc.) great benefit is also obtained, and some chronic pneumococcal lesions (such as sinuses left after empyemata) heal very rapidly after one or two injections. Chronic cystitis and pyelitis due to *B. coli* are sometimes cured, but more often the symptoms are greatly relieved without actual cure being obtained. Some cases of ulcerative endocarditis and septicæmia have been completely

cured, and the other applications of the process are too numerous to mention here. In general we may say that it should be tried in all chronic infective diseases that do not yield readily to easier methods.

In tuberculosis the results have been on the whole disappointing, and the method should be reserved as an adjuvant to other treatment, or for lesions (tuberculous iritis, ulceration of the bladder, etc.) in which direct surgical treatment is unavailable. Tuberculous sinuses often heal well after a few injections, and tuberculous ulceration of the skin does better than ordinary lupus.

### COLLECTION OF MATERIAL AT POST-MORTEM EXAMINATIONS

The saprophytic bacteria which occur in such vast numbers in the skin and alimentary canal during life undergo very rapid multiplication after death; hence, in cases where bacteriological examinations have to be made, the *sectio* should be performed as soon as possible after death.

The materials which should be examined in all cases are the heart-blood, the spleen, and the liver, and the following methods are to be employed:

The *heart-blood* should be collected in the method which has been described previously (see p. 33), and cultures may be made upon the spot, or the pipettes sealed at both ends and taken to the laboratory.

The *spleen* may usually be examined in the same way. If it is so firm and hard that no fluid rises into the pipette, it should be treated in the same way as the liver.

Cultivations should be made from the *liver* at the time when the autopsy is performed. The organ should be cut in half, and a small portion of the cut surface deeply seared with a hot iron. This area is then to be perforated with a stout platinum needle, and the culture media inoculated at once.

If the material has to be taken to a distance, and no culture-tubes are at hand, a different course must be adopted. The simplest way is to cut out a cube of liver substance from the centre of the organ, and to sear *every part* of its surface with the flat of a red-hot knife. The block (which may be about as large as a lump of sugar) must be dropped at once into a sterilized bottle. Another



plan is to sear the surface of the block, and then to tie a piece of string round it and dip it quickly into melted paraffin (a candle will do), and allow the coating to set; the dipping is to be repeated several times, and the specimen (string and all) may then be packed without further precautions. In any case it must reach the laboratory as soon as possible.

Where cultural examinations are not required, small portions of the organs should be placed in a suitable hardening fluid as soon as possible. Equal parts of methylated spirit and water is perhaps as good as anything, and, in the absence of this, undiluted whisky or other spirit answers equally well (see p. 161).

Other solid organs are treated in the same way. Fluids (pus, the contents of cysts, pericardial or other fluid, etc.) should be collected in pipettes in the manner adopted for the heart-blood.

## SECTION-CUTTING

The methods employed in section-cutting are somewhat outside the scope of this work, inasmuch as sections are rarely *necessary* for the purposes of bacteriological diagnosis, and I have attempted to give the simplest possible methods in all cases. The presence of bacteria in the tissues can usually be demonstrated by the simple processes of smearing the cut surfaces of tissues on clean slides or cover-glasses, and treating the films thus obtained by the fixing and staining methods previously described. If, for instance, we have to search for tubercle bacilli in tuberculous glands, it is usually sufficient to smear the cut surfaces of the glands on a slide, dry, fix by heat, and stain in the same way as sputum is stained for the tubercle bacillus. If anthrax bacilli were being looked for in the liver or other organ removed post-mortem, the same method of procedure would be adopted, except that Gram's method of staining would be used. So also for typhoid bacilli in the spleen, where the film would be stained with a simple stain such as thionin or Löffler's methylene blue.

It seems advisable, however, to give a short general account of the processes involved in section-cutting, for they are by no means difficult, and do not require very elaborate apparatus. Further, the same methods of section-cutting are used for investigating the nature of tumours, etc., and this is done already by many practitioners and should be done by still more.

Slices of organs or tissues which are to be cut have first to be *fixed*. The process of fixation consists essentially in the application of some agent which brings about coagulation of the component proteids with as little distortion of the morphological elements as possible; if this step were not carried out the subsequent processes would be liable to cause alterations in the shape, size, and appearance of the cells and fibres. There are two chief methods of fixation, that involving the use of *chemical substances*, and that involving the use of *heat*. The processes which are used in fixing the tissues *harden* them at the same time; this is necessary, for fresh tissue would yield before the sharpest knife, and could not be cut into thin sections. These processes are always carried out, no matter what method of section-cutting is to be adopted.

In cutting sections it is necessary that the material should be sufficiently *firm* and *homogeneous* in consistency. The former is secured to some extent by the process of hardening, but a properly hardened block is rarely firm enough to permit of its being cut into sections without further preparation. Further, it almost invariably happens that some parts of the material are firmer or harder than others; and if such a substance were cut the harder parts might be sufficiently firm, whilst the softer parts would simply crumble before the knife. There are two methods of overcoming this difficulty—*freezing* and *embedding*.

The *freezing process* is very simple, and it is one which can easily be carried out at home. The sections which it yields are usually quite sufficient for purposes of histological research (the diagnosis of tumours, etc.), but they are rarely sufficiently thin for a proper demonstration of the bacteria which they may contain. The sections are cut more easily by the freezing than by the paraffin process, but they are decidedly more difficult to manipulate.

In the freezing process the block or tissue after fixing and hardening is dipped, or, better, soaked for some hours, in a thick solution of gum arabic. It is then placed on the plate of a microtome and frozen until the tissue assumes the consistency of fairly hard cheese, and can be cut into thin sections.

The *embedding process* should be called the infiltration process; the tissue to be cut is infiltrated throughout with some firm substance, and not merely embedded therein. Two embedding materials are in general use—paraffin and celloidin. The latter will not be described, as it is only necessary for special work, and

for ordinary purposes cannot compare with paraffin for beauty of results and facility of application.

In the paraffin process the tissue is infiltrated throughout with hard paraffin (such as is used for the better varieties of paraffin candles), so that every cell and every fibre is permeated and supported on every side. To do this requires a number of processes. It would be of no use to immerse the block of tissue in the paraffin just as it is, for the paraffin would not wet it, much less soak into it. The water is first removed; and this is done by soaking the material in absolute alcohol. But alcohol does not dissolve paraffin or mix with it; it is therefore necessary to remove it by means of some fluid which will mix with it on the one hand and paraffin on the other. Of these there are many: xylol, chloroform, benzine, cedar oil, and many more are in use for special purposes. Chloroform answers most purposes, and is to be generally recommended. The block of tissue is now ready to be soaked in melted paraffin; it is kept in a bath of this substance until the chloroform has been entirely driven off and replaced by the paraffin. The whole is then allowed to cool, is shaped into suitable blocks, and is then ready for cutting.

We shall now describe the processes in fuller detail.

## FIXING MATERIAL FOR CUTTING

These processes must be understood by all practitioners, even although they do not intend to cut sections for themselves. It happens to every medical man to find it necessary to send tumours, etc., to a laboratory to obtain a pathological diagnosis; and in very many cases the materials are treated in a way which absolutely prevents good sections being obtained. Many fixing fluids are in use, and any of them may be selected, but it is absolutely necessary that the material to be investigated should be cut into *small* pieces and put into a large bulk of the fluid *at once*. This is especially necessary in the case of material removed at a post-mortem examination, where the tissues and organs have already undergone alteration.

As regards the size of the slices which are to be placed in the hardening fluid, it is sufficient to say that they should never exceed  $\frac{1}{4}$  inch in thickness, and if perchloride of mercury is used should be even thinner. The other dimensions of the block are of less importance.

The bulk of the fluid in which the block is placed should be at least twenty times that of the block, and it is not advisable to place two blocks in the same vessel.

The fluids which we shall recommend for this purpose are :

1. Perchloride of mercury in normal saline solution. This is prepared by dissolving common salt in water in the proportion of 7 grammes to a litre (about  $3\frac{1}{2}$  grains to the ounce), and saturating this solution whilst hot with perchloride of mercury. The solution must be allowed to cool completely ; as it does so, crystals of the mercury salt will separate out.

This fluid fixes completely in twenty-four hours, or less, and gives most excellent results. Its powers of penetration are not very great, so that slices of tissue which are to be fixed in it should be thin.

The after-treatment of the blocks fixed in this fluid must be described briefly. They are allowed to remain in the solution for twenty-four hours and no longer, and are then washed for twenty-four hours in running water to remove the perchloride of mercury. They are then passed through the various strengths of spirit (as will be described subsequently), a little tincture of iodine being added to each to remove any mercury which may still remain. The other steps are the same as those which are used if other methods of fixation have been adopted.

2. Formalin. This should be used in a 5 per cent. solution in normal saline solution (0·8 per cent.). It yields very good results, and is perhaps the fluid which can be most warmly recommended to a practitioner who is going to send his material to a public laboratory.\* The fluid has very great powers of penetration, and the slices may be much thicker than we have recommended. The one objection to the fluid is that it interferes somewhat with the way in which the sections stain.

3. Alcohol is a very good fixing fluid. When it is used the blocks should be cut small and placed at once in methylated spirit diluted with an equal quantity of water.

\* Formalin should not be used for tissues which are to be searched for the tubercle bacillus, as it prevents the decolorizing action of the acid.

## SECTION-CUTTING BY THE FREEZING METHOD

Sections which are prepared by the freezing method are rarely as thin as those prepared by one or other of the infiltration processes, but are prepared very rapidly, and are often sufficient for diagnostic purposes, where rapidity is the first consideration.

The blocks of tissue must be hardened before being cut, any of the above fluids being applicable; where alcohol is used it must be washed out in water, as it will not freeze. Where more rapid work is required the best method is a modification of the old boiling process, as revived by Mr. Strangeways. The slices of tissue from which sections are to be cut are thrown at once into boiling water, and allowed to boil vigorously for two or

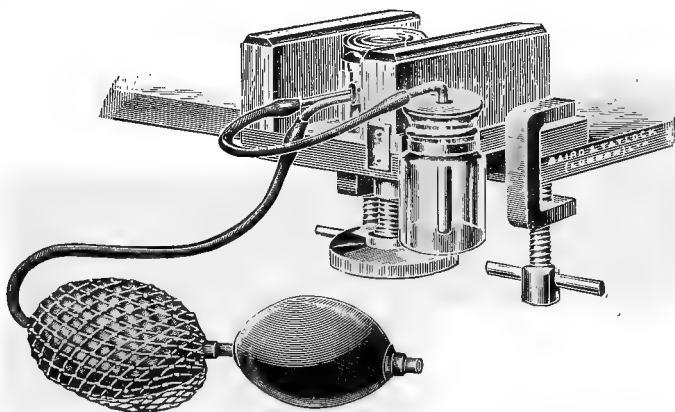

FIG. 39.—CATHCART'S MICROTOME ARRANGED FOR CUTTING FROZEN SECTIONS.

three minutes; the water must be actually boiling when the tissues are added, and the bulk used should be large as compared with the block. The tissues are then rapidly cooled by being thrown into cold water, and are then ready for cutting. The outer surface of the block should be rejected.

This method of fixation leads to a little distortion of the tissues and alters any blood which they may contain, but it is very good for diagnosing tumours. It is invaluable in the post-mortem room, and for diagnosis of the nature of a tumour during operation. In skilful hands a section may be cut, stained, mounted, and a diagnosis made in ten minutes; or if no process of fixation

by boiling be used, in much less. I have cut, stained, mounted, and diagnosed a tumour within three minutes.

A microtome is necessary for the successful cutting of sections, and the Williams and Swift patterns are those in general use for the freezing process. We shall recommend the practitioner who intends to take up this branch of work to procure a Cathcart microtome, which is exceedingly cheap (it costs about a guinea) and answers admirably. The great advantage of this machine is that it will serve for cutting sections in paraffin as well as for frozen sections.

The blocks of tissue which are to be cut are dipped in a thick and syrupy solution of gum arabic; if time is no object it is a great advantage to soak them in this for several hours. A block is then placed on the corrugated plate of the microtome and frozen by means of the ether spray which impinges upon it. When the mass is nearly frozen a section is taken off by means of a razor which is ground flat on one side, or the special knife which may be obtained with the apparatus; it is better to moisten the upper surface of the knife with a little of the gum. The section is carefully removed with a camel's-hair brush and placed in a large vessel of clean water, so that the gum may be dissolved out of it, and is then ready for staining. The block is then raised by means of a very slight turn of the large milled head under the apparatus, and another section cut.

The mass must not be frozen too hard; if this has been the case, the necessary thawing will be hastened by gently breathing on the block. If it begins to thaw, a few squeezes of the bellows will bring it to the proper consistency.

For extremely rapid work, the best method of freezing is by the use of liquid carbon dioxide: this, however, is difficult in private practice, owing to the unportability of the cylinders. The best method is to use ethyl chloride or anæstle in metal cylinders, such as are used for local anæsthesia. The best method is as follows: Place a few drops of water on the plate of the microtome, and freeze it solid by the ether spray whilst the surgeon is removing the tumour; cut a suitable slice off the latter and place it on the layer of ice thus formed; direct the ethyl chloride spray downwards on to the slice, which will be frozen in a few seconds. Unless the water be previously frozen on the plate of the microtome, the block of tissue is very liable to slip, the lower portion being frozen last.

Where very rapid work is required it is not advisable to stain the sections in the method described in the next paragraph, since it takes too long. A simple stain (such as watery methylene blue) is used, the staining being done on the slide, a cover-glass applied, and the excess of stain removed by means of blotting-paper. It is necessary to acquire a considerable amount of experience of this method before using it for diagnosis, as the appearance of sections prepared in this way and examined in a watery fluid is very different from that which they have when double-stained and mounted in balsam.

## STAINING AND MOUNTING FROZEN SECTIONS

These processes are best carried out in watch-glasses. No attempt will be made to describe the methods by which frozen sections may be stained for the purposes of bacteriological research, for they are not so suitable as paraffin sections for this purpose. We shall describe the process of staining in hæmatoxylin (with or without eosin as a counterstain) and mounting in balsam.

The *requisites* are: Five watch-glasses containing respectively hæmatoxylin, watery solution of eosin (about 1 per cent.), alcohol (50 per cent.), absolute alcohol, and clove oil; a saucer or other vessel containing water to which a few drops of ammonia have been added; several strips of thin writing-paper, each about 1 inch wide and 2 inches long; some needles, which may be mounted in handles; slides, cover-glasses, and balsam.

A section is to be removed from the bowl of water in which it is floating by means of one of the strips of paper; this must be inserted under it, and the section "pinned" in place upon it by one of the needles. A special section-lifter may be used, but is not so good. It is then transferred to the watch-glass containing the hæmatoxylin solution, and the staining process is allowed to go on for a minute or two, a fresh section being manipulated whilst it is taking place. The first section is then removed in the same way as before, and placed in the water containing the ammonia; it soon turns blue, and when this is the case it is ready to be transferred to the eosin, then into the dilute alcohol, the absolute alcohol (where it should remain for a minute or more), and finally into the oil of cloves. It is then ready to be mounted in balsam. A convenient way in which a section can be transferred to a slide is as follows: The section is carefully spread out whilst in the

oil of cloves, two needles being used for the purpose, and a slip of paper insinuated beneath it. This strip of paper is then drawn slowly out of the liquid, and any folds or creases which may be in the section straightened out with the needles, the excess of the oil of cloves being allowed to drop off whilst this is taking place. The strip of paper is then inverted (the section remaining adherent to the under surface), placed upon a clean slide, and pressed firmly upon it; the pressure squeezes out the greater part of the oil, so that the section adheres to the slide, and the paper can be stripped cautiously from it. A drop of balsam is then applied, the section covered with a cover-glass, and examined under the microscope.

It is a great advantage to rinse the section in distilled or clear rain-water after removing it from the hæmatoxylin.

The solution of hæmatoxylin is best bought ready made, as its preparation is somewhat difficult. Delafield's solution is the best for general work.

A counterstain is not really necessary for diagnostic purposes, and its omission hastens the process somewhat.

## THE PARAFFIN PROCESS

Tissues which are to be cut in paraffin may be hardened in any of the fluids mentioned above. They are then dehydrated, cleared in chloroform or other fluid which mixes with alcohol and dissolves paraffin, and finally soaked in a mixture of hard and soft paraffin kept just at the melting-point. This paraffin should be obtained specially for the purpose; the Cambridge paraffin is the best. It is made in two varieties, the soft, which melts at  $48^{\circ}$  C., and the hard, which melts at  $55^{\circ}$  C. The amounts of each which should be used for embedding depend upon the external temperature: in very hot weather hard paraffin may be used alone, while under average circumstances a mixture of equal parts of each is best.

We shall now proceed to describe the various processes seriatim.

*Dehydration.*—This is very simple. The blocks of tissue are placed in weak spirit for a few hours or for a day, then changed into stronger spirit, and so on until absolute alcohol is reached. The slower this process is carried out the better will be the results; in practice the strengths of the successive lots of spirit used may be 40 per cent., 75 per cent., and the strong methylated spirit, and the block may remain in each for twelve hours. Lastly, it goes into two successive lots of absolute alcohol.



In all cases the amount of fluid must be greatly in excess. It is useless merely to cover the block with the spirit.

*Clarification.*—In the next step the alcohol is removed from the tissue and replaced by some fluid which will dissolve paraffin. Fats are dissolved out from the tissues at this stage.

This step is also very simple. The blocks are passed directly from absolute alcohol into chloroform, and allowed to remain there for twelve to twenty-four hours, according to their size. It is not necessary to use a preliminary bath of a mixture of alcohol and chloroform.

It is a good plan to place the bottle containing the block in a warm place with the cork out for an hour or so before proceeding further, as by so doing the last traces of the alcohol will be removed.

*Infiltration with Paraffin.*—This is the stage which presents most difficulties to the home-worker, for it is necessary to keep the

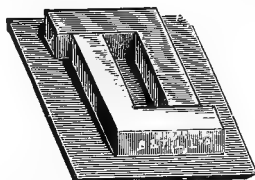

FIG. 40.—L-SHAPED MOULDS FOR EMBEDDING IN PARAFFIN.

block of tissue soaked in paraffin which is just melted for at least twelve, and more often twenty-four, hours. To do this properly involves the use of some sort of incubator. This might possibly be rigged up out of a tin biscuit-box in the manner already described, though considerably more heat would be necessary, as the paraffin melts at about  $50^{\circ}$  C. But the writer has often embedded the blocks by placing them in bottles containing the paraffin at such a distance from the fire that the paraffin is never completely melted, but always shows a thin solid layer on the surface. To do this it is only necessary to look at the bottle occasionally, and move it a little further from the fire if the paraffin is completely melted, and *vice versa*. The process may be stopped at night without any harm resulting, and if the soaking only continues for a few hours at a time it is of no consequence so long as the total period is made up.

*Casting the Blocks.*—Special metal moulds are used in the laboratory (Fig. 40). A pill-box will do quite well. A small amount of melted paraffin is poured into the box, and the piece of tissue is

taken from the bottle containing the melted paraffin with a pair of forceps (previously warmed, so as to prevent the paraffin from setting upon the points), and placed in the paraffin in the pill-box. It is necessary to see that the surface from which sections are to be cut should be placed downwards. The box is then filled up with melted paraffin, and placed in a cool place or surrounded with water. The moment a firm film has formed over the surface the whole is plunged in cold water to hasten the setting of the paraffin; the more rapidly this takes place the better will the block cut. When the paraffin mass has hardened completely throughout, it is trimmed into shape, taking care that the edges of the surface which is to be cut are accurately parallel.

*Cutting the Sections.*—For cutting sections in paraffin no microtome can be compared with the Cambridge Rocker, but very excellent results can be obtained by the use of the

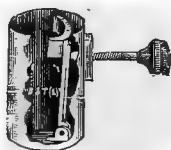

FIG. 41.—CLAMP FOR HOLDING WOODEN BLOCK WITH THE PARAFFIN BLOCK.

Cathcart microtome already mentioned. The paraffin block containing the piece of tissue is mounted on the freezing-plate of the microtome (which must be heated, and the lower surface of the block pressed upon it), and the sections cut in the manner described; a very sharp knife is essential, and the stroke must be quicker and sharper than is the case when frozen sections are being cut. In another form of the microtome a special inner tube is provided for cutting sections by the paraffin process. The blocks are retained in place by a clamp, and appear in the same position as that occupied by the mass of frozen gum. As the paraffin is not sufficiently hard to be gripped by this clamp, they must first be mounted on a piece of wood of a suitable size and shape. This can be cut out of a piece of firewood, and should have one surface left rough; this surface must be dipped in melted paraffin, and the under surface of the block partially melted in the flame and pressed firmly upon it. The piece of wood is then to be placed in the jaws of the clamp, and the screw tightened up.

In the Cambridge Rocker and in some other forms of microtomes the sections adhere to one another at the edges, and form long ribbons as they are cut. In the Cathcart microtome this is not the case, and each section must be dealt with separately; it is to be removed carefully from the knife-blade with a camel's-hair brush or a finely pointed pair of forceps, and placed upon the surface of a bowl of water, just hot enough to warm the paraffin without melting it. When this is done the sections will spread out and lose all the creases, and are then ready to be mounted on slides or cover-glasses.

It often happens that the sections roll up on the knife. In this case they must be placed on the surface of *cold* water, and an attempt made to straighten them out by careful brushing with a camel's-hair brush; when fairly flat they are to be lifted up on a slide or piece of paper (dipped into the water and insinuated below them), and transferred to the hot water as before. But the rolling of the sections may often be prevented by sharpening the knife, by re-embedding the tissues in harder or in softer paraffin according to the weather, or by varying the angle which the knife edge makes with the glass runners of the microtome. These devices can only be learnt by experience.

When the sections are flattened out on the surface of the hot water, they are ready to be mounted upon slides or cover-glasses: slides are by far the best for beginners. The slides (or cover-glasses) must be perfectly clean, and are best kept in methylated spirit until they are to be used, and the spirit not wiped off. Each slide is then inserted separately into the water in an oblique position, and the section moved until it lies over the centre; the slide is then raised out of the water, and carries the section out with it.

The excess of water is now to be removed by a piece of blotting or filter paper, and the slide placed in the warm incubator for a few hours. At the end of this time the sections will adhere by atmospheric pressure (like a boy's leather sucker to a stone), and will not come off in the subsequent processes. If an incubator is not at hand the slides may be placed near the fire (protected from dust), and kept at the body temperature or a little higher for a few hours; the exact temperature does not matter, and no harm will result if the paraffin melts, provided that the section has previously become dry.

In the older methods of fixing sections to the slides various

forms of cements had to be used, and were a great disadvantage. They are quite unnecessary except for sections of the central nervous system; if these are being dealt with the slide must be coated with a very thin layer of a solution of egg-albumin in water before the section is laid upon it. The process is then exactly the same as before.

## STAINING AND MOUNTING PARAFFIN SECTIONS

We will suppose that the sections have been cut, flattened out on hot water, and caused to adhere to slides, and shall describe in general terms the steps through which they must be taken before they are ready for examination. In the first place, it is obvious that the paraffin, which permeates all parts of the section and surrounds it on all sides, must be removed, and this is done by pouring xylol, benzine, or turpentine upon it. At least two supplies of the fluid should be used, and it should be allowed to act for at least two minutes, the slide being rocked all the time. We have now removed the paraffin, and the next step is to remove the xylol or other solvent; this is done by means of absolute alcohol. At least two lots should be used, and it should be allowed to act for two minutes. The slide is then washed in water, and is ready for staining. When the section is wet with xylol it will be quite transparent; this is because the refractive index of the xylol is almost the same as that of glass, and the rays of light which come through the section are not bent. But when the alcohol is added the section will suddenly become opaque, and for the opposite reason.

If there is a milkiness on the section or slide when the water is poured on, it is a sign that the xylol has not been completely removed; xylol will not mix with water, and forms an emulsion with it. If this should happen, you must give the section another dose of absolute alcohol, and rewash in water.

It is an advantage to wipe the surface of the slide (of course avoiding the section) before going from one fluid to another.

A cardinal rule in dealing with paraffin sections is *never to let the section get dry* from the moment the first dose of xylol is added until the final mounting in balsam.

The methods of staining which are in use are legion, and it would be far beyond the scope of this book to describe even a few of those which are used in histological work, and to give indications for their use. It will be sufficient to describe (1) a

method suitable for the diagnosis of tumours, etc., and for ordinary histological purposes; (2) a method of staining to demonstrate bacteria which stain by Gram's method; (3) a method for bacteria which do not stain by Gram's method; and (4) the process for demonstrating tubercle bacilli in the tissues.

1. Staining sections for histological purposes:

1. Xylol, two lots (to remove paraffin).
2. Absolute alcohol, two lots (to remove xylol).
3. Water (to remove the alcohol).

4. Stain with hæmatein (or hæmatoxylin\*) for ten minutes or more, according to the nature of the specimen and the condition of the stain. The exact length of time can only be learnt by trial, but ten minutes will be about right. Rinse in distilled water.

5. Wash thoroughly in tap-water, continuing the washing until the sections have a decidedly blue tinge. The hæmatoxylin compounds are very much like litmus, being red in presence of acids and blue in presence of alkalis; the sections are to be coloured blue, and the necessary alkali is contained in the tap-water. It will hasten the process to rinse them in a very dilute solution of ammonia, or, best of all, a saturated solution of lithium carbonate.

6. Stain in watery eosin for a minute or so. This is the *counterstain*. The hæmatin will stain all nuclei blue, but will scarcely tinge anything else; the eosin is added to stain other structures a pale pink, and thus make them more visible. It stains almost instantaneously.

7. Wash off the eosin under the tap.

The sections are now stained. But they are opaque, and not in a suitable condition to be examined under the microscope, and are to be rendered transparent by being mounted in balsam. Now, this cannot be done in the same way as was used in the mounting of films, for the drying would cause the sections to shrivel and obscure their structure. The water is to be removed, it is true, but by the use of absolute alcohol; at least two lots should be used, and the slide rocked from time to time. Then the alcohol (which will not mix with balsam) is to be removed by the use of xylol, balsam added, and the section covered with a cover-glass. The remaining steps are therefore:

8. Absolute alcohol, two lots (to dehydrate).

\* Delafield's hæmatoxylin is the best for ordinary work, and is best bought ready made.

9. Xylol, two lots (to render the section permeable to balsam).

10. Balsam and a cover-glass.

The last three steps are practically the same as the first three, but in the reversed order, and similar phenomena are seen. The section is opaque whilst wetted with the alcohol, and becomes transparent when the xylol is added, and this transparency is the proof that the steps have been carried out properly. If the section looks opaque when held against a perfectly dark background, an additional dose of alcohol must be used, and the xylol applied again.

II. Gram's method as applied to sections, suitable for sections of diphtheritic membrane, organs containing anthrax bacilli, streptococci, staphylococci, etc. :

1. Xylol, two lots.

2. Absolute alcohol, two lots.

3. Water.

These steps are always the same with paraffin sections, no matter what stains are to be used subsequently.

4. Aniline gentian violet—five minutes.

5. Gram's iodine solution—three minutes or more.

6. Absolute alcohol or methylated spirit—*until no more colour comes out*. This step is best carried out as follows: Hold the slide by one end, keeping the fingers clean by using a duster or pair of dissecting forceps, and pour a little spirit on the section; rock it gently from side to side and notice the clouds of colour which it takes up. After a little time pour off the spirit and add a fresh lot; repeat the rocking, and pour off again. Do this until the spirit comes away quite clean, and does not take up any colour from the section. This may take a long or short time, and no definite rules can be laid down.

In some cases decolorization can be carried out best by the use of clove oil. This is applied when the section is wet with absolute alcohol (for it will not mix with water), and must be entirely removed by the same fluid before the section is mounted, or it will cause it to fade. Clove oil is a very powerful decolorizing agent, and requires careful use, or the colour may be removed from the bacteria.

7. Eosin—half a minute or more. This is a counterstain, and is used to demonstrate the structural elements, which are not coloured by the gentian violet. It may be omitted in some cases.

8. Absolute alcohol—two lots (to remove the water).
9. Xylol—two lots, or until the section becomes transparent.
10. Balsam and a cover-glass.

This method of staining is very easy of application, and the results are exceedingly beautiful. Bacteria which take the stain are coloured blue or violet, and actively dividing nuclei and keratin are stained in the same way, while all other structures are stained pink.

III. Method for bacteria which do not stain by Gram's method, suitable for sections of typhoid ulcers, lymphatic glands containing plague bacilli, etc.

The problem before us in this case is not at all easy of solution. In the first place, the stains which colour the bacteria also colour the tissues, especially the cell nuclei; the bacteria are easy to stain, but it is difficult to stain a section in which there is good differentiation. In the second place, the stains which are used for bacteria are all soluble in alcohol: but alcohol is used to dehydrate the sections. The following method will be found to serve fairly well in most cases, though it requires a certain amount of practice for its successful accomplishment.

1, 2, and 3. Xylol, alcohol, and water, as before.

4. Stain in carbol thionin for ten minutes or a quarter of an hour.

5. Wash in running water for ten minutes or longer. This removes the stain from the tissues before decolorizing the bacteria, and a fairly differentiated specimen may be obtained if the processes of staining and washing are carried out for suitable lengths of time.

Unna's polychrome methylene blue may be used in a similar manner, and gives even better results. The staining should be continued for about ten minutes, and decolorization effected by *very short* immersion in dilute acetic acid (about  $\frac{1}{2}$  per cent.), followed by a good washing in pure water.

6. Remove as much water from the section as you can without actually drying it by the cautious use of clean blotting-paper. Then apply aniline oil until the section becomes perfectly translucent. Aniline oil mixes with water on the one hand and xylol on the other, and can be used for dehydration just as alcohol was; the process is slower, and several lots of the oil must be used.

7. Wash off all the aniline oil by successive applications of

xylol. The permanence of the preparation will depend on the thoroughness with which this step is carried out.

8. Balsam and a cover-glass.

IV. Staining sections to demonstrate the tubercle bacillus; applicable to the leprosy bacillus also.

1, 2, and 3. Xylol, alcohol, and water, as before.

4. Carbol fuchsin heated until the steam rises for five minutes or longer, care being taken that the section does not dry up. Or the slide may be immersed in the stain and kept in a warm place for twenty-four hours.

5. Dilute sulphuric acid until only a faint pink tinge appears after washing. This will generally require an immersion of ten minutes or more.

6. Methylene blue for three or four minutes. Some of the stain comes out in the alcohol, so that the section must be stained more deeply than will be required ultimately.

7. Rinse off the blue stain in water, and then remove the greater part of the latter with blotting-paper; this is to render the dehydration more rapid.

8. Absolute alcohol, two lots in rapid succession.

9. Xylol.

10. Balsam and a cover-glass.



PART II  
HÆMATOLOGY

ESTIMATION OF THE AMOUNT OF HÆMOGLOBIN

THE best form of hæmoglobinometer now obtainable is undoubtedly Haldane's; it was introduced since the first edition of this book (in which Gowers' and Oliver's were described) was published, and is now generally used. It is as simple and cheap

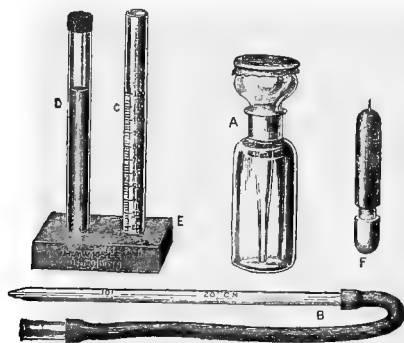

FIG. 42.—GOWERS' HÆMOGLOBINOMETER.

as Gowers', and almost as easy to use, and gives much more accurate results. In Gowers' method the margin of error is very considerable, though it will answer perfectly well when we simply wish to see whether a patient is improving under treatment, but must not be relied on for absolute results. Oliver's hæmoglobinometer is a little more difficult to use, but is somewhat easier to read; its price prevents it from coming into universal use.

GOWERS' HÆMOGLOBINOMETER consists of two tubes mounted

in a small stand. One of these tubes is filled with a jelly tinted to represent the colour of normal blood of a certain degree of dilution. The other is graduated into a hundred parts, the graduation being such that when 20 cubic millimetres of normal blood are diluted with water up to the 100 mark, the colour of the two tubes should be exactly the same. A pipette measuring 20 cubic millimetres and a dropping-bottle (which is to be filled with water) are also provided.

*Method of Use.*—Place a few drops of water (preferably, but not necessarily, distilled) in the graduated tube. Draw the blood in the usual way. Apply the tip of the measuring pipette to the drop, and suck gently until the blood reaches up to the mark. Now put the tip of the pipette into the small quantity of water in the bottom of the graduated tube and blow out the blood; this will sink to the bottom of the tube; now raise the tip of the pipette into the supernatant layer of clear water; suck water up the pipette until it reaches above the mark, and blow it out; repeat this process until the blood is thoroughly washed out from the tube. Take great care not to withdraw any of the diluted blood when removing the pipette. Finally shake the tube so as to mix the blood and water thoroughly.

Place the two tubes side by side on a sheet of white paper in front of a well-lighted window which is not exposed to direct sunlight; look at them by the light which is reflected from this paper, and add water from the pipette belonging to the dropping-bottle, drop by drop, until the colour in the two tubes is exactly the same. Read off the height of the column of diluted blood; this gives the percentage amount of hæmoglobin.

HALDANE'S HÆMOGLOBINOMETER is similar in principle, but here the standard tint consists of a sealed tube containing a solution of carboxy-hæmoglobin. The rest of the apparatus is exactly like Gowers', and the method of use is similar, except that, after the 20 cubic millimetres of blood have been diluted with the few drops of water in the comparison-tube, it is to be converted into CO hæmoglobin by saturation with ordinary coal-gas. To do this, take the curved tube supplied with the apparatus, fit it to an ordinary gas-burner, and insert the other end of the tube in the comparison-tube, taking care not to touch the solution of blood: turn on the gas, and allow it to run into the tube for some time. When the comparison-tube is filled with gas remove it, close it quickly with the finger, and shake gently for a minute or two; if you wet your finger

with the diluted blood, wipe it off carefully on to the top, so as to avoid loss.

The remaining steps are again like those in Gowers' hæmoglobinometer, but with this difference: that you are comparing two solutions of the *same substance*. These are very easy to match, and the exact quality of the light does not matter, so that the method may be used by any artificial light.

I find it convenient to saturate the water in a bottle with CO by bubbling coal-gas through it for some minutes. The hæmoglobin is then converted into CO hæmoglobin in the process of dilution, no further gassing is necessary, and the procedure is exactly like Gowers' in all respects. The solution will keep for a day or two if well stoppered.

OLIVER'S HÆMOGLOBINOMETER differs from that of Gowers in that the degree of dilution is constant and the colour of the diluted blood is read off by comparison with a series of carefully graduated standards. It consists of (1) a capillary glass tube with thick walls and ground ends, one of which is flat and the other pointed: this tube is mounted in a metal handle, the other end of which serves as a stirrer (Fig. 43, *c*); (2) a small cell with an opaque white bottom, and provided with a cover-glass which has a slight bluish tint (*e*); (3) a series of twelve coloured glass discs mounted over an opaque white background (*a*); (4) certain small pink glass discs used as riders; (5) a short glass pipette with an indiarubber nipple at one end and a short length of indiarubber tubing at the other (*d*): the latter fits over the pointed end of the capillary tube mentioned first; and (6) a small wax candle such as is used for Christmas-trees. A camera-tube lined with a green material is used to screen the eyes whilst the comparison is being made.

*Method of Use.*—Prick the patient in the usual way. Apply the polished end of the capillary tube to the drop of blood; this will completely fill the tube, being drawn up by capillary attraction. When quite full, wipe both ends of the tube with the fingers, and apply the end of the glass pipette (previously filled with water) to the pointed end of the capillary tube. Now squeeze the nipple gently, so as to force the blood and (subsequently) the water drop by drop into the cell. Interrupt the process occasionally, and stir the contents of the cell with the metal handle of the measuring-tube. Continue to add water until the cell is *exactly* full: this is the first step which presents the slightest difficulty. Apply the

cover-glass; this must not enclose any air under it, nor cause any of the diluted blood to flow into the moat round the cell.

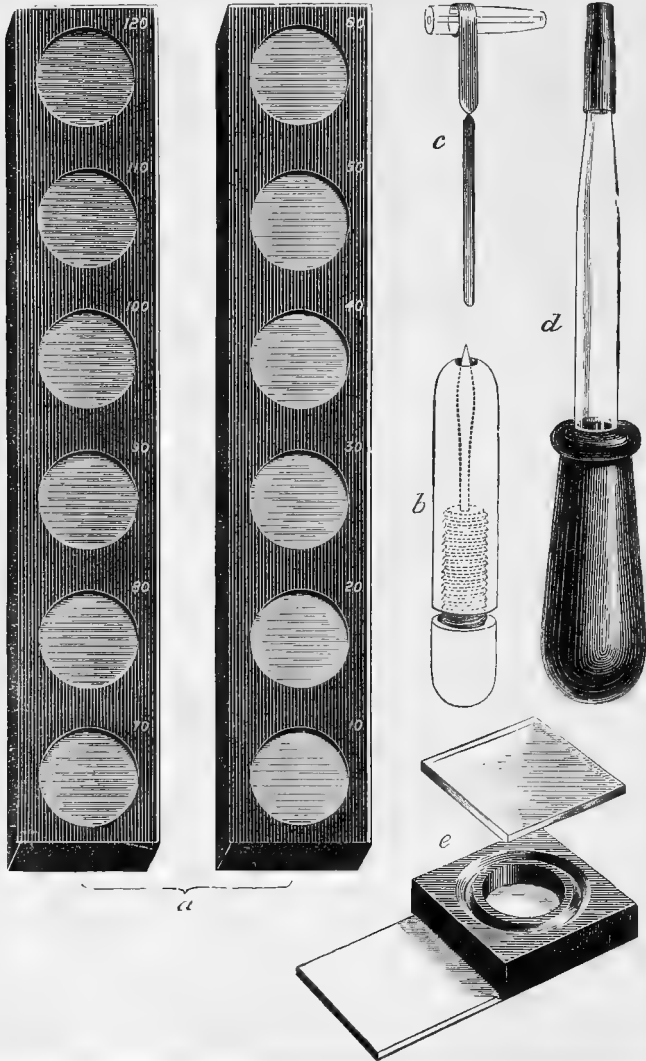

FIG. 43.—OLIVER'S HÆMOGLOBINOMETER.

The specimen is now ready for comparison with the standards. It is to be taken into a dark room and examined by the light of

one of the candles. This is to be placed in front of the observer at a short distance from the specimen and standards, which must lie side by side.

The viewing is best done by means of a camera-tube which folds into the box containing the whole apparatus. It terminates in a diaphragm which is perforated by two small holes, one of which is to be placed over the centre of the specimen and the other over the centre of the standard. The latter is to be moved about until a disc is found which nearly or quite corresponds in colour with the diluted blood in the cell. If the correspondence is exact, the process is at an end; the number against the disc in question represents the percentage amount of hæmoglobin. If there is no disc which exactly matches the specimen, the latter is placed against the disc which is nearest to it, but not so deep in colour. For example, if we found that the specimen was darker than the disc numbered 50, but paler than that numbered 60, then it would be placed opposite to 50. A slip of colourless glass is then applied over the specimen, and riders over the standard disc, until an exact match is obtained. If, in the case mentioned above, we had to add a rider marked 5 to the standard to bring about an exact match, the percentage amount of hæmoglobin in the blood would be 55.

It is an advantage to place cell and standards side by side rather than one above the other, for the upper and lower portions of the retina differ in sensitiveness to colour, whilst the sides do not.

## CLINICAL APPLICATIONS

1. It is impossible to estimate even the *presence* of anæmia, to say nothing of its *degree*, without an examination of the amount of hæmoglobin. I have been repeatedly asked by highly skilled clinical observers to examine cases presenting all the appearances of anæmia in whom the blood has been in every respect normal. The examination, therefore, should be made in all cases of supposed anæmia, and the diagnosis should not be considered as established until this has been done.

The recognition of the degree of anæmia is advisable, in that it permits the effect of treatment to be watched and ineffective remedies to be discontinued. It also affords a guide as to prognosis, for if a patient's amount of hæmoglobin increases during,

say, the first week of treatment, a good prognosis may be given, although there are no other signs of improvement, and some idea as to the time necessary to effect a complete cure may be obtained.

2. Apart from an ordinary anæmia, the estimation of the hæmoglobin may give an important clue as to the presence or absence of other diseases. For instance, in severe *sepsis* there is usually a very marked and rapid fall in the amount of hæmoglobin, due to the destruction of the red corpuscles by the toxin of the infective organisms. This is especially valuable in that it occurs in severe infections in which the leucocytes often do not undergo characteristic alterations (p. 222). Thus, if an increasing anæmia is found in a patient during the puerperium, it points strongly to puerperal fever, and the prognosis is bad, assuming, of course, that there is no hæmorrhage or other cause of anæmia.

In interpreting the results of this examination you must remember that when there is severe diarrhœa, sweating, polyuria, or any other symptom in which there is a great loss of water, the blood may be temporarily concentrated, and the amount of hæmoglobin (and of red corpuscles, but not of leucocytes, or not to a proportionate extent) may appear to rise. Discount this in giving a good prognosis in septic conditions from the increase in the hæmoglobin. A similar concentration may occur from mitral disease or venous stasis from any cause.

3. A fall in the amount of hæmoglobin in a case watched from day to day indicates hæmorrhage, and is occasionally valuable in the differential diagnosis of internal hæmorrhage—*e.g.*, in cases of ruptured tubal gestation.

4. In malaria there is a fall in the amount of hæmoglobin, very rapid and sudden in the early stages, and often marked, though less rapid, in the later ones. The fall is often to an extent only equalled in acute *sepsis*. This may be of much diagnostic value. In typhoid fever and in the other diseases for which malaria may be mistaken the anæmia is usually developed much more slowly, if at all.

5. Considerable help is afforded in the diagnosis of syphilis by Justus's test, which is based on the fact that in the primary and secondary stages of that disease the red corpuscles are abnormally easily destroyed by the action of mercury, provided that that drug has not been previously administered. The test is also of value in the diagnosis of hereditary syphilis.

To use it, estimate the hæmoglobin as accurately as possible,

and then give the patient a single large inunction of mercury, thoroughly rubbed in: Justus recommends 3 grammes (45 grains) for an adult, 1 gramme for an infant. About twenty-four hours afterwards estimate the hæmoglobin again. In a positive case there will be a fall of 10 to 20 per cent., and this fall may continue for a day or two, and then give place to a gradual rise.

The test should not be employed when there is marked anæmia to begin with, as in these patients the blood-corpuscles seem very sensitive to the mercury, even when the disease is not syphilitic. With these exceptions, I believe the test to be of very great value, though more importance is to be attached to a positive than to a negative result.

### ESTIMATION OF THE RED CORPUSCLES

The best apparatus for the estimation of the number of corpuscles (whether red or white) is the Thoma-Zeiss hæmocytometer. It should be provided with two pipettes, one for counting the red corpuscles and one for the leucocytes. The latter is rarely used and need not be procured.

Examine the pipettes. Each has a small bulb containing a little glass ball, and a stem which is graduated into several parts below the bulb, and has a single transverse graduation above it.

The pipette intended for use in counting the leucocytes may be distinguished by the fact that it has the figure 11 over the single transverse graduation above the bulb.

There are two sorts of pipettes used for counting the red corpuscles. In the one form the stem below the bulb is divided into ten parts, the upper one (nearest the bulb) being marked 1, and the middle one 0.5 (Fig. 44, S). In the other one the same portion of the stem is graduated into three portions numbered  $\frac{1}{100}$ ,  $\frac{1}{50}$ , and  $\frac{1}{200}$ ; the figure mentioned first is placed nearest the bulb. These pipettes are used in the same way, and it is quite immaterial which is obtained; we shall describe the use of the first form.

The *rationale* of the method is this: Blood is sucked up to one of the divisions on the lower part of the stem, and then an inert diluting fluid is drawn up to the single mark above the bulb, and the two mixed by rotating the whole apparatus for a minute or two. This gives us a dilution of blood of definite strength, the exact amount of dilution depending upon the amount of blood which was taken. Thus, if blood had been drawn up to the

figure 1, we should have a dilution of 1 in 100, while if blood had been drawn up to the figure 5 the dilution would be 0.5 in 100, or 1 in 200, and so on. In the case of the other form of pipette the dilution is read off directly from the figures on the lower stem.

The diluted blood thus obtained is spread out in a film of a definite known thickness on the slide supplied on the instrument (Fig. 44, *a*). This is ruled in squares, and the squares are of known size. The amount of blood lying upon each square is thus known, and the number of corpuscles which lie upon it being counted under the microscope, all the data for the calculation are obtained.

In blood examinations it is absolutely necessary that all points

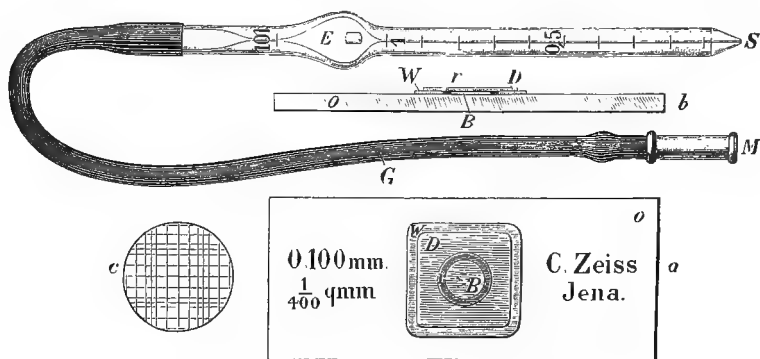

FIG. 44.—THOMA'S HÆMOCYTOMETER.

in the technique should receive the most careful attention, or the result will be worse than useless. For this reason we shall describe each step in the process at some length, and advise the practitioner to make several estimations before placing any reliance whatever on his results.

*Requisites.*—1. The hæmocytometer.

2. A needle suitable for obtaining a small quantity of blood. A straight Hagedorn's needle (about 2 inches long) is the very best that can be used, and an ordinary hare-lip pin will answer very well. It is best to use a needle with a flat cutting-point, and not a round or triangular one, as the prick is less painful.

3. Diluting fluid. There are a good many formulæ for this, and some are rather complicated. Isotonic saline solution (common salt 0.8 or thereabouts) will answer perfectly; it is advisable to add to it a small quantity of some stain, methyl violet being



the best, although gentian violet will do very well. This colours the *leucocytes*, so that they are readily distinguished from the red corpuscles.\*

4. A microscope having a  $\frac{1}{8}$ -inch lens which will focus through the thick cover-glass supplied with the hæmocyto-meter. If the examination is not to be made by the bedside, a strong indiarubber band a little shorter than the pipette should be carried.

#### PROCESS.

1. *Pricking the Patient.*—The blood may be procured from the convex border of the lobe of the ear or from the lateral surface of the last phalanx of the finger. The advantage of the former situation is that the pain is very slight, the skin being thin, and that the patient cannot see what you are doing, and is not likely to start at the critical moment. It is to be recommended for children and nervous women. The advantage of the finger is that the skin is free from hairs, and these are objectionable in the preparation of films by the cover-glass method; an additional advantage is that the patient can put his hand into the position most convenient to you, and you have not to lean over him.

The area of the skin to be punctured may be washed with soap and water and then with pure water, and wiped dry, but this is not really necessary. It is necessary, however, to rub the patient's ear or finger well with a towel or piece of lint, so as to make it hyperæmic; unless you do this you may have difficulty in collecting sufficient blood, especially if the skin is cold. The needle is sterilized by being passed slowly through the flame of a spirit-lamp or Bunsen burner; the area of skin to be pricked is taken between the finger and thumb of the left hand, and a rapid and fairly deep stab made with the needle. The skin is then released, and a drop of blood allowed to exude; this is wiped away, and the next drop which oozes out is used for examination.

The skin must never be pinched when blood is being withdrawn for this examination; the blood must always be allowed to flow out naturally, but if a flat needle be used, the edges of the cut made by it may be held apart by gentle pressure with the finger and thumb.

\* The following formula is better: Distilled water, 160 c.c.; glycerin, 30 c.c.; sodium sulphate, 8 grammes; sodium chloride, 1 gramme; methyl violet, a trace (Toison's fluid).

2. *Filling the Pipette.*—The degree of dilution is determined by the number of corpuscles per cubic millimetre which you expect to find. If the patient is anæmic, use 1 in 100; if he has approximately the normal number of corpuscles, or if you have reason to think that they are present in increased quantities, use a dilution of 1 in 150 or 1 in 200.

In most cases you will find it advisable to count the red and the white corpuscles in the same specimen, and if this is the case, use a dilution of 1 in 100, whether you expect the patient to be anæmic or not. It is less easy to count the reds (if numerous) with this low degree of dilution than with a higher one, but it is not really difficult, and if you use a higher degree of dilution considerable error will be introduced into the leucocyte count.

Having decided upon the degree of dilution, insert the tip of the pipette into the drop of blood lying on the skin, take the bone mouth-piece attached to the indiarubber tube in your mouth, and suck the blood up to the appropriate mark. If air-bubbles gain access, blow the blood out and begin again quickly. If you overshoot the mark, remove some of the blood by touching the tip of the pipette against some lint or absorbent cotton-wool. Be careful, also, to wipe off any blood there may be on the outside of the tip. Place the tip of the pipette in the diluting fluid; a small quantity should be poured out into a watch-glass or other suitable vessel, so as to avoid any possibility of allowing some blood to escape into the stock bottle, and invalidating a subsequent observation. Suck the diluting fluid slowly into the pipette until it reaches the single mark above the bulb; rotate the pipette between the finger and thumb as you do so.

Now remove the pipette from the diluting fluid, place the tip of the finger over the aperture of the pipette (Fig. 44, S), and proceed to mix the contents by rotating the pipette and by turning it over and over.

If the examination is to be made at a distance, remove the indiarubber tube and stretch an indiarubber band over it, so as to close both apertures of the pipette. It is advisable to make the examination in a few hours, otherwise considerable errors may creep in.

3. *Preparation of the Specimen.*—The slide which is supplied with the instrument consists of a thick and perfectly flat slip of glass (Fig. 44, o), on which is cemented a glass square having a round hole in its centre (W). In the centre of the hole thus left there

is a circular disc of glass (*B*); this inner disc is made of glass which is exactly  $\frac{1}{10}$  millimetre thinner than that of which the outer glass is constructed. When the whole cell is covered with a perfectly flat cover-glass (*D*) there will, therefore, be a space exactly  $\frac{1}{10}$  millimetre between the lower surface of this cover-glass and the upper surface of the central disc; this space is to be filled with the diluted blood.

Slide and cover-glass are to be wiped clean with a soft handkerchief moistened with water (*not* alcohol or xylol, which may spoil the former), and then thoroughly dried; there must not be the minutest particle of dust on any part of the surface.

The slide and cover-glass being ready, mix the contents of the pipette as you did before (this must always be done immediately before making the specimen, no matter how carefully it had been done a short time previously), and blow out about half of the fluid in the bulb; this is to wash the diluting fluid out of the lower part of the stem. Now clip the indiarubber tube firmly between your finger and thumb, so as to prevent the access of air, and therefore the escape of fluid, and wipe the tip of the pipette from all fluid; this may be done with the forefinger. Place the tip of the pipette on the centre of the central disc of the slide, and relax your pressure on the indiarubber tube so as to allow a *small* drop of fluid to escape; this is perhaps the most difficult part of the process, and the exact amount which must be allowed to fall on to the slide can only be learnt by experience.

Cover the slide in this way: Place your finger at the side on the glass square on the slide, and apply the cover-glass, letting it rest against your finger; lower it gently in place with a needle or other suitable object. When it is in place press it gently with the needle at each corner in succession, and look at it obliquely, so as to see the light reflected from the surface. If the slide and cover-glass are in sufficiently close contact, you will see Newton's rings (looking like the eye of a peacock's feather) round the point at which you are applying pressure. If you do not see this, the inference is that there is some dust between the slide and cover-glass; you must clean both and begin again.

It is a great advantage to *clip* the cover-glass to the counting-chamber until the corpuscles have had time to settle. When this has taken place the depth of the chamber is immaterial, and it does not matter if it rises somewhat. The simplest method is to

use four Cornet's forceps, or even only two (applied at opposite sides), as in the figure. Where this is done an ordinary No. 1 cover-glass may be used instead of the special thick one. Newton's rings should appear round the tips of the forceps, as shown in the illustration. The preparation should stand for five minutes to allow the corpuscles to settle, when the forceps are removed and the count made (see Fig. 45).

If you have taken the right amount of fluid, the drop should extend exactly to the edge of the central glass disc, but should not run over into the "moat" (Fig. 44, *r*). If this happens, or if there are any bubbles under the cover-glass, you must begin again.

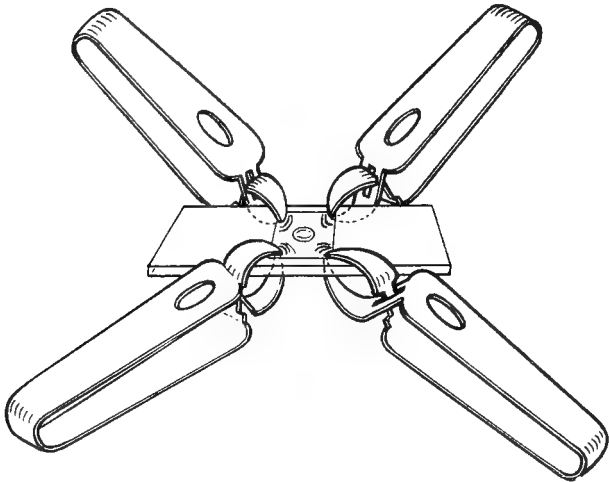

FIG. 45.—COUNTING CHAMBER WITH COVER-GLASS CLIPPED INTO POSITION.

If the drop does not quite extend to the edge of the central disc, no great harm is done.

4. *Focussing the Specimen.*—This is somewhat difficult for beginners, and merits a short description. Place the slide under the microscope, taking care to get it accurately centred, and examine it with the low power. You will find that the central disc is ruled into squares like a chess-board (Fig. 44, *c*). Get these squares into the centre of the field (see Fig. 46).

Do not forget you are dealing with an unstained object ; use a flat mirror and a small diaphragm. The examination is often easier if artificial light is used.

Now turn on the high power ( $\frac{1}{8}$ -inch or  $\frac{1}{7}$ -inch), and screw it

downwards until it *almost* touches the cover-glass ; look down the microscope and focus gently upwards, using the fine adjustment, and keeping a careful look-out for the rulings.

Some  $\frac{1}{8}$ -inch lenses focus too near the object to be of any use. If this is the case, you must either get an objective specially for the purpose, or a cover-glass which is hollowed out in the centre. These can be bought from the same place as the hæmocytometer.

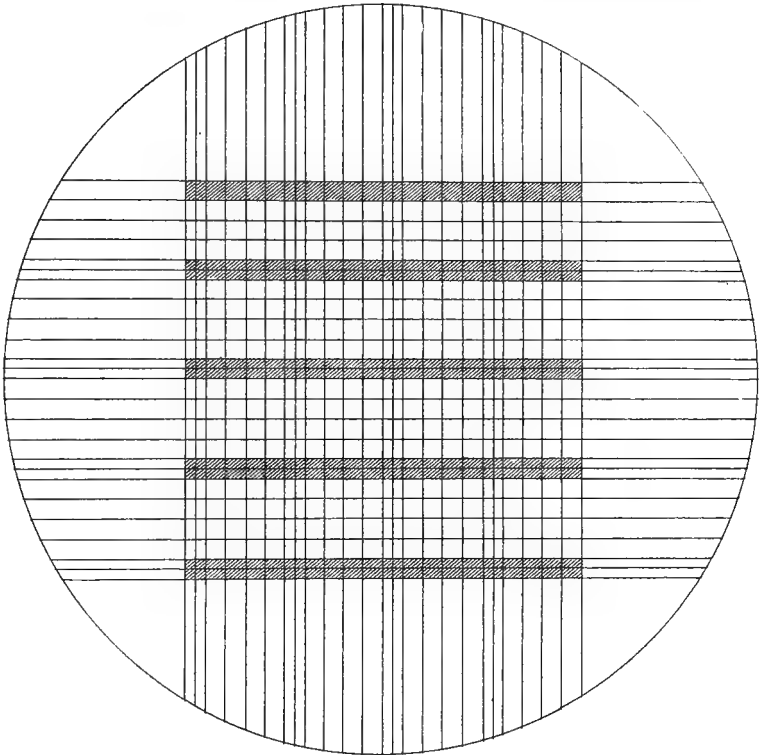

FIG. 46.—THE "BARS" WHICH ARE TO BE COUNTED ARE SHADED.

If the rulings of the slide are indistinct, they may be darkened by rubbing them with a very soft lead-pencil.

5. *Counting the Corpuscles.*—Move the slide about until you have come to one corner (preferably the left upper corner) of the ruled area. You will see that each fifth space is marked off by a line running down its centre ; this is to guide the eye and facilitate counting. The whole square consists of four hundred small

squares, twenty along each side. You have to count at least a hundred of these small squares. The simplest way to do this is to count five "bars" of twenty each, each bar extending right across the ruled "chess-board." The bars selected should be as far as possible apart from one another, so as to get a good average. In practice it is simplest to take the top one, and all the others that have a double ruling; when you have counted these you will have counted five rows of twenty each at equal distances from one another, which will give you a very fair average. (See Fig. 46, where the bars which are to be counted are shaded.)

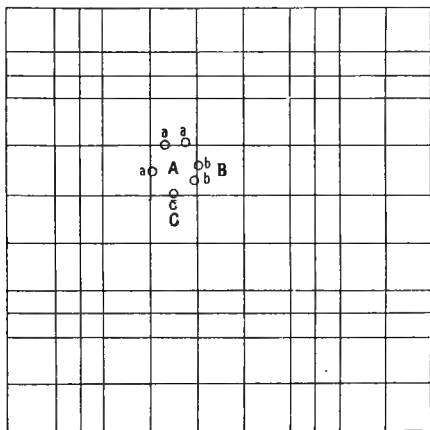

FIG. 47.—SHOWING METHOD OF COUNTING RED CORPUSCLES.

*a, a, a*, are counted in square A; *b, b*, in B; *c* in C. In this method each corpuscle is counted once, and once only.

In counting these bars count all the corpuscles which are lying *on* or *touching* the top line, as in the bar you are counting, also those which are lying on or touching the extreme left-hand limit of the bar. Exclude those on or touching the lower and right-hand lines. The reason for this will appear subsequently.

This is the most convenient way when you have no assistant to take down numbers, since you only have to remove your eye from the microscope for the purpose of recording results five times in the whole process, which takes about five minutes or less. It is, however, rather more accurate to take down the count square by square, dictating the number to an assistant, who tells you when you have counted a hundred; you are less likely

to make errors in the count by this method. If you follow this method in place of that given above, the following notes should be taken into consideration.

If you exclude the spaces which are thus marked with a double line, the whole area will be marked out into a series of large squares, each consisting of  $4 \times 4 = 16$  smaller squares (Fig. 47). It is convenient to count the smaller squares in these groups of sixteen. *At least* a hundred of the smaller squares—*i.e.*, six of the large groups and four small squares—should be counted.

In counting one of the smaller squares it is convenient to begin with the corpuscles which are lying in the middle of the square, and then to count those which are lying on the lines. In dealing with these you count those which are lying on the *upper* and *left-hand* lines as being within the square, and those that are on the *lower* and *right-hand* lines as being without it; if you like you may reverse this, but you must keep to the same method throughout (see Fig. 47).

A few white corpuscles will be met with in every case, while if the blood was taken from a patient with leucocytosis or leucocythæmia there will be many. They may be distinguished from the red corpuscles by their greater refractivity, or, if a stain has been used in the diluting fluid, by their being faintly tinged. It is scarcely necessary to say that they should not be counted.

6. *The Calculation.*—The best way of calculating the number of corpuscles present from the data thus obtained is the following:

First add up the number of corpuscles in all the squares which you have counted, and divide the sum by the number of squares counted. This gives the average in each square.

Now the space enclosed between each square and the cover-glass above it is  $\frac{1}{10}$  millimetre deep,  $\frac{1}{20}$  millimetre wide, and  $\frac{1}{20}$  millimetre long; its cubic capacity is therefore  $\frac{1}{10} \times \frac{1}{20} \times \frac{1}{20} = \frac{1}{4000}$  cubic millimetre. Therefore the  $\frac{1}{4000}$  part of a cubic millimetre contains the number of corpuscles which we have already found as the average.

But the square contained *diluted* blood; if the amount of dilution was 1 in 100, the amount of blood contained in the space over each square was  $\frac{1}{100}$  part of  $\frac{1}{4000}$  cubic millimetre.

Therefore the number of corpuscles which has been determined as being the average per square is contained in  $\frac{1}{4000}$  of  $\frac{1}{100}$  cubic millimetre of undiluted blood, the dilution being taken as 1 in 100.

Hence the number of corpuscles in 1 cubic millimetre of

undiluted blood is obtained by multiplying the average per square by the number which expresses the dilution (in this case 100), and then by 4,000.

It may be expressed as a formula, thus :

If  $n$  is the total number of corpuscles counted,  
 $s$  is the number of squares counted,  
 and if the dilution is 1 in  $d$ ,  
 then the number of corpuscles per cubic millimetre is  $\frac{n}{s} \times d \times 4,000$ .

*Example.*—Suppose that we have counted 100 squares, and have found that they contain 1,200 corpuscles, then the average per square is 12.

Then  $\frac{1}{4000}$  cubic millimetre of *diluted* blood contains 12 corpuscles.

Or,  $\frac{1}{100}$  of  $\frac{1}{4000}$  *undiluted* blood contains 12 corpuscles, supposing the dilution was 1 in 100.

Therefore 1 cubic millimetre of undiluted blood contains  $12 \times 100 \times 4,000 = 4,800,000$  corpuscles.

Or by the formula—

Number of corpuscles per cubic millimetre :

$$\frac{1200}{100} \times 4,000 \times 100 = 4,800,000.$$

Where the dilution is 1 in 100 (as is recommended, since it enables the red corpuscles and the leucocytes to be counted in one specimen) the calculation can be simplified still further. Add up the number of corpuscles in the hundred squares counted and multiply by 4,000. If you count 200 squares, multiply by 2,000, and so on.

*In a normal count there are 1,250 in the hundred squares counted, 250 in each "bar" of twenty squares, and 12½ in each small square, with the dilution of 1 in 100.* A knowledge of these facts will enable the approximate condition of the blood to be obtained at a glance.

The beginner is strongly advised to work out the problem at full length until he has become absolutely familiar with the reason for all the steps.

#### CLINICAL APPLICATIONS.

As this is more tedious than the estimation of the hæmoglobin, and is really less important in the recognition of anæmia, it may often be omitted in clinical work. When possible it should be



done, as it serves as a useful check on the results obtained by the estimation of hæmoglobin. The normal numbers in health are taken to be 5,000,000 red corpuscles per cubic millimetre in adult males, and 4,500,000 in adult females. As a matter of fact, these figures are very frequently exceeded. In newly born children the number is about 5,250,000, and in older children about 5,000,000 in both sexes. Any decided fall from these figures indicates anæmia.

The number of red corpuscles per cubic millimetre is *increased* in any condition in which the total volume of the blood is diminished by loss of the fluid portion of the blood—*e.g.*, in severe diarrhœa.

This fact is occasionally of diagnostic value. For example, the red corpuscles appear more numerous in typhoid fever, especially in the earlier stages of the disease: the figure may exceed 6,000,000. Later in the disease a fall takes place, though it is never very great, and if in a continued fever the red corpuscles are less than 3,000,000, the diagnosis of typhoid is unlikely. This is very different to what happens in malaria, where there is great and progressive destruction of the red cells, and a figure below 2,000,000 very common. This may be of value in diagnosis in cases where the parasites cannot be found, and Widal's reaction fails or cannot be tried.

On the other hand, care must be taken not to mistake this concentration of the blood for an actual improvement—*e.g.*, if in a case of septic infection, puerperal fever, etc., the number of reds shows a sudden rise, the question of whether the blood has been concentrated by profuse diarrhœa, sweating, etc., must be inquired into before the findings raise hope of a speedy recovery. Mistrust all results showing an increase of more than 100,000 red corpuscles a day. Such rapid improvement does occur, but is unusual.

The red corpuscles are also very numerous (up to 10,000,000) in congenital cardiac disease with cyanosis, and as an obscure primary condition, and in venous stasis from mitral disease or any other cause.

A *decrease* of the number of red cells indicates anæmia, and the numbers may be taken as a criterion of the degree of anæmia present. But this is not so accurate a test as the percentage of hæmoglobin, since it is the quantity of this substance that is of importance, the number of parcels into which it is divided being of comparatively little moment. The grade of anæmia, therefore, should be expressed by the percentage of hæmoglobin, not by the number of corpuscles. This is of some importance, since in the

cases of typhoid fever referred to above the hæmoglobin is usually slightly lowered, showing that there is anæmia, even where the number of corpuscles is abnormally high.

In the diagnosis of the nature of an anæmia the enumeration of the red corpuscles is necessary, and the result is to be considered in connection with the percentage of hæmoglobin. The *colour-index*, or *index of corpuscular richness*, is the figure which indicates the richness of each corpuscle in hæmoglobin, the normal figure being unity. It is obtained by dividing the amount of hæmoglobin by the number of corpuscles, each being expressed as a percentage of the normal amount. In health there are 5,000,000 red corpuscles = 100 per cent. of normal and 100 per cent. of hæmoglobin. The index is therefore :

$$\frac{100}{100} = 1.$$

If we found a case in which the red corpuscles were 4,000,000 (= 80 per cent. of normal) and the hæmoglobin 40 per cent., the colour-index would be :

$$\frac{40}{80} = 0.5.$$

In another case we might find:—Red corpuscles 1,000,000 (= 20 per cent. of normal), and hæmoglobin 25 per cent. The colour-index is :

$$\frac{25}{20} = 1.25.$$

These figures would be suggestive of chlorosis and pernicious anæmia respectively.

The percentage of red corpuscles is obtained from the absolute count by multiplying the millions figure and the hundred thousand figure by two (since the normal is 5,000,000, the said figures of which become 100 when multiplied by two). Thus, 2,500,000 = 50 per cent.; 900,000 = 18 per cent., etc. The same rule may be used for women, for the slightly lower normal total of reds is accompanied by a smaller amount of hæmoglobin.

The following are the general rules (to which exceptions are rare) for the interpretation of the colour-index :

1. An index decidedly above unity indicates pernicious anæmia, and usually in this disease the greater the anæmia the higher the index.
2. In chlorosis the index is greatly diminished: 0.2 has been recorded, and the average is about 0.5. The exact figure throws

no light on the severity of the case, which must be estimated by the amount of hæmoglobin.

3. In anæmia due to a single large hæmorrhage the index is 1 at first, both hæmoglobin and corpuscles being, of course, lost in equal proportions. As the blood begins to be regenerated it falls somewhat, not usually lower than 0.9. In anæmia due to multiple hæmorrhages, infectious diseases, poisoning, malnutrition, etc. (*secondary anæmia*), blood loss and regeneration are taking place simultaneously, and the index falls to 0.9, 0.8, or even lower.

### ESTIMATION OF THE NUMBER OF LEUCOCYTES

In clinical work it is quite sufficiently accurate to count the leucocytes in the same preparation as was used for the red corpuscles, and this is a great saving of time and trouble. Proceed as follows:

Having focussed the rulings on the slide, move the draw-tube

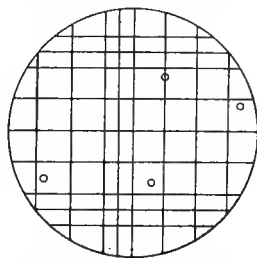

FIG. 48.—SHOWING FIELD OF MICROSCOPE ADJUSTED SO THAT ITS DIAMETER IS EQUAL TO THAT OF EIGHT SQUARES.

of the microscope up and down until the upper and lower limits of the field of the microscope coincide *exactly* with two of the horizontal lines, and count the number of spaces (each enclosed between two horizontal lines) in the diameter of the field. Using a  $\frac{1}{8}$ -inch objective it will be found possible to arrange matters so that these are eight in number, and this will be found convenient, though any other number will do. The essential thing is that the upper and lower borders of the field shall coincide exactly with the rulings. We will suppose that the number is eight. Then the diameter of the field of the microscope is equal to eight times the length of a side of a square, and its radius is equal to four times the length of a side of a square. The total area of the field of the microscope is therefore

$4 \times 4 \times \frac{22}{7}$  ( $r^2 \times \pi$ , where  $\pi$  is taken as  $\frac{22}{7}$ ), or 50 and a frac-

tion. Practically, therefore, when we look down the microscope after it has been adjusted in this way we are looking at fifty squares; and this fact enables us to dispense entirely with the rulings, and count over the whole area of the disc with great rapidity. The slide is placed in position, and all the cells which are seen in the field counted and the result noted down, or, preferably, dictated to someone else. The slide is then moved on until a perfectly fresh portion of the field comes into view; it is advisable to go too far rather than not far enough. For this purpose (as for a great deal of blood-work) a mechanical stage is a great advantage. In this way 4,000 squares—*i.e.*, eighty fields—may be counted in a very short time.

It is a very great advantage to be able to dictate these numbers to an assistant, who will tell you when forty fields have been counted. In most cases this will be enough, but if the numbers come out irregularly—*i.e.*, several in one field and none in others—it is best to count eighty fields or to make a fresh preparation.

With the arrangement recommended—that is, with a field eight small squares in diameter—you can tell at a glance whether there is or is not leucocytosis. *If the leucocytes average one per field, they are 8,000 per cubic millimetre, a normal count; if two per field, they are 16,000 per cubic millimetre, a moderate leucocytosis; if three per field, they are 24,000 per cubic millimetre, a high leucocytosis.*

The calculation in this case is very simple. If you have counted eighty fields, the total number is the number of leucocytes in  $80 \times 50 = 4,000$  small squares. Now this is the number of small squares in a cubic millimetre, so that the number only requires to be multiplied by the dilution, in this case 100, to give the number of leucocytes per cubic millimetre. If you have counted eighty squares, therefore, add up the result and put on two noughts; if you have counted forty squares, multiply the result by two and then put on two noughts. Thus, if there are 112 leucocytes in 40 fields, the number per cubic millimetre is 22,400.

Where very great accuracy is required the special diluting pipette should be used.\*

All the steps are similar to those just described at full length, except that a different diluting fluid is used.

\* I allow this statement to stand, but have now great doubts as to its correctness, and believe that the results obtained by the field method are even more accurate, especially in unpractised hands,

The diluting fluid is one which destroys ("lakes") the red corpuscles, but does not injure the leucocytes. It consists of a 0.3 or 0.5 solution of acetic acid (glacial) in water; it is better to add a small quantity of methyl violet or gentian violet, so that the leucocytes are stained and thereby rendered more prominent. This solution is best prepared fresh, or at any rate kept in a well-stoppered bottle.

The pipette is distinguished from that used for the red corpuscles by its having the number 11 above the bulb. This indicates that if blood be sucked up to the mark 1 below the bulb, and diluting fluid up to the transverse mark above the bulb, the dilution will be 1 in 10, and so on.

The blood should be sucked up to the mark 1 if a great excess of leucocytes is not expected. If the case is one of leucocytosis, a greater dilution is better; whilst if there is a great excess of leucocytes (such as occurs in severe leucocythæmia), it is best to use the red corpuscles pipette with a dilution of 1 in 100, but employing the acetic acid diluting fluid. Then proceed to make the preparation, and count by the field method as above.

Immediately after use the pipettes must be thoroughly cleaned. The fluid which remains in the bulb must be blown out, and for this purpose, as well as for the subsequent washings, it is an advantage to reverse the position of the indiarubber tube, so that the fluid may be blown out through the upper part of the pipette, this being the wider. The whole pipette must now be filled with water (preferably distilled), and the water blown out. This process is repeated, using absolute alcohol, and allowing it to run out of the pipette without blowing it. Lastly, fill the whole pipette with ether, remove the indiarubber tube, replace it with the tube of an ordinary spray (such as is used for scent fountains, throat sprays, etc.), and pump air through until the apparatus is absolutely dry. You can tell when this has happened by the fact that the ball inside the bulb will emit a clear ringing sound when the pipette is shaken. It is useless to attempt to dry the tube by blowing through it from the mouth.

If blood has coagulated within the apparatus, it must be digested out. Fill the whole with an artificial digestion fluid (pepsin and very dilute hydrochloric acid), and place it in a test-tube of the same fluid in a warm place for twenty-four hours. Then try to clean it as before, and repeat the digestion if this is impossible.

## CLINICAL APPLICATIONS.

The clinical applications of the leucocyte count are so wide that it is hardly possible to summarize them here; it is more convenient to refer to each special case separately under the heading of the blood-count as a whole. For example, in dealing with typhoid fever the leucocyte count is explained and the points on which a diagnosis is framed are given, which, in a case in which there is a doubt as to the diagnosis between this condition and pneumonia, may be referred to in conjunction with the account of the latter.

It will be convenient, however, to give a list of the usual counts met with in certain diseases, classified under five headings in respect of the number of leucocytes to be expected in them. But these figures must always be considered with reference to the fuller accounts of the diseases in question.

I. ENORMOUS LEUCOCYTOSIS (100,000 to 1,000,000).—Such figures are practically only met with in myelogenous or lymphatic leucocythæmia, though suppuration, pneumonia, and whooping-cough may very rarely approximate thereto.

II. HIGH LEUCOCYTOSIS (20,000 to 100,000).—*Suppuration* in all situations and of all kinds, the degree of the leucocytosis being a measure of the virulence of the organism and the resisting power of the patient.

*Pneumonia*, in which the same facts hold.

*Whooping-cough*.

*Meningitis*, especially suppurative meningitis, whether cerebrospinal, pneumococcal, etc. In tuberculous meningitis there may be as many as 25,000 leucocytes.

*Pleurisy*, especially empyema. A leucocyte count of 20,000 does not exclude tuberculous pleurisy, but tells strongly against it.

*Scarlet fever*.

*Diphtheria*.

*Hæmorrhage*.—After a very severe hæmorrhage, whether internal (e.g., rupture, extra-uterine gestation) or external (e.g., from gastric ulcer), figures over 20,000 are occasionally seen, but usually rule lower (12,000 to 15,000). The number usually falls in a few days.

Similar figures are seen immediately *before death*, especially if the death is lingering, and very high figures are occasionally seen. It is sometimes of value in prognosis.

In ovarian cysts with twisted pedicle, in intussusception and volvulus, the figures may exceed 20,000.

III. MODERATE LEUCOCYTOSIS (10,000 to 20,000).—Here come mild cases of almost all the diseases mentioned above. Thus, a very mild case of pneumonia may show a leucocytosis within these limits, or be normal.

*Inflammatory*.—Leucocytosis in inflammatory conditions other than suppuration rarely exceeds 20,000, and does not often reach 16,000: this is a most important diagnostic feature.

*Rheumatism*, in the absence of complications.

*Tonsillitis*, except when very severe, when higher figures may be seen.

*Secondary anæmia* (see p. 217).

*Gout*.—Here the condition is normal during the interval, with a slight leucocytosis during the attack.

*Small-pox*, during the pustular stage. In severe cases the count may exceed 20,000, and figures much above this indicate a bad prognosis.

*Perforation in Typhoid Fever*.—Here the leucocytosis usually attains 15,000 in less than an hour, and may go much higher.

*Secondary syphilis* in most cases.

*Malignant Tumours*.—There is often, but not invariably, a slight rise in the leucocytes with malignant tumours, but it is hardly marked in the early stages.

In addition to these pathological leucocytoses, there are two physiological conditions associated with a moderate leucocytosis.

*Digestion*.—Under normal conditions there is a rise of 1,000 to 3,000 soon after a meal. This must always be remembered in interpreting a leucocyte count. A figure of 12,000 obtained in a patient an hour or two after a full meal does not necessarily indicate disease. If possible, examine the patient when fasting.

*Pregnancy*.—The figures rise gradually toward the end of pregnancy, and at term may reach 15,000 or even higher. Recollect this in interpreting counts in pregnancy or soon after parturition.

IV. NORMAL COUNTS (5,000 to 10,000, average 7,500) are met with in a variety of conditions, but in comparatively few that are attended with pyrexia. Of these the most important are:

*Tuberculosis*, except tuberculous meningitis (15,000 to 25,000), and occasionally in tuberculous pleurisy (10,000 to 20,000).

*Typhoid fever.*

*Malta fever.*

*Measles.*

*Malaria.*

*Mumps.*

*Varicella.*

*Pernicious anæmia.*

*Chlorosis.*

*Primary syphilis.*

*Influenza.*

In any of these there will be leucocytosis if an inflammatory complication is present. Thus, in typhoid fever with perforation or pneumonia the count is raised.

*Very severe sepsis.*

V. A LOWERED COUNT, OR LEUCOPENIA (under 5,000).—This is not met with very frequently, and all the cases are included under IV. The chief are *typhoid fever*, *pernicious anæmia*, *chlorosis*, *influenza*, *malaria*, and *uncomplicated tuberculosis*. It is also found in *starvation and malnutrition*.

## THE INVESTIGATION OF THE MORPHOLOGY OF THE LEUCOCYTES AND RED CORPUSCLES

To study the morphology of the leucocytes and red corpuscles it is necessary to prepare thin and even films of the blood, and to submit them to appropriate methods of staining.

### METHOD OF PREPARING FILMS—I. WITH COVER-GLASSES.

This is the best method for ordinary purposes, and, if the instructions are carried out *exactly*, is a very easy one.

*Requisites.*—I. Perfectly clean cover-glasses. They should be cleaned by one of the methods described on p. 31, and kept in spirit. Immediately before they are required for use they must be removed with a clean pair of forceps and dried with an old and soft handkerchief. They may then be passed rapidly through the flame, and allowed to cool.

I prefer No. 2 cover-glasses for this examination, as much better films are made on them than on thin ones, which are



liable to bend under the powerful suction exerted by the capillary attraction of the drop of blood when spread out thin.

2. A needle for drawing blood.

(3. A platinum loop having a diameter of about  $\frac{1}{10}$  inch is sometimes useful, especially to a beginner.)

Rub the patient's ear or finger *thoroughly* with a piece of lint or a towel, so as to make it hyperæmic. Prick it, and wipe away the first drop of blood. Then allow another drop to exude; if necessary, you may squeeze it a little.

Take a cover-glass between the first finger and thumb of the left hand, holding them by the opposite angles, and take another between the first finger and thumb of the right hand, holding it by adjacent angles (Fig. 49).

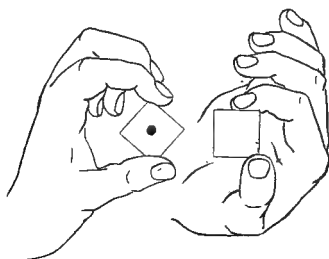

FIG. 49.

Touch with the upper surface of the cover-glass in your left hand the drop of blood on the patient's skin, so as to remove a very small droplet. This is the most difficult step: you must not get too much or too little blood, otherwise the films will be useless. It is advisable to avoid letting the cover-glass touch the patient's skin.

Now put the right-hand cover-glass over the left-hand one, the centres coinciding; lower the upper (right-hand) one until the droplet of blood just touches it, and then let go (Fig. 50).

You will see the droplet of blood spread itself out by capillary attraction between the two cover-glasses.

At this stage you will see whether you have taken the right amount of blood or no. If you have, the drop will spread out, still retaining its circular shape, until it approaches the octagon formed by the intersecting edges of the two cover-glasses (Fig. 50); if you have taken too little it will not reach so far, and if you have taken too much it will extend further, and the upper cover-glass will float loosely on the lower.

It is necessary to lay great emphasis on the fact that the cover-glasses must *not* be squeezed together, but must simply come together by capillary attraction.

When the drop has ceased to spread take hold of the upper cover-glass with the finger and thumb of your right hand and slide the two apart, keeping them in the same plane; this is

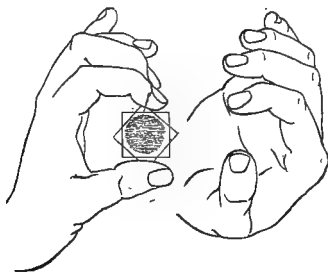

FIG. 50.

readily done, since the cover-glasses are free to turn, being only held loosely at the points. If you do not do this, either the cover-glasses will break, or else the upper cover-glass be lifted from the lower one, and the film will resemble the marks left on a knife which has been pressed on butter and lifted off; such films are useless.

Here, again, you find whether you have taken the right amount

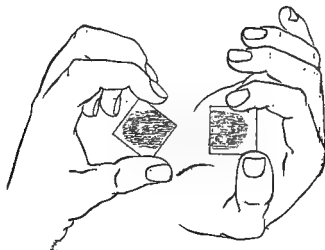

FIG. 51.

of blood. If you have taken too little, the cover-glasses will be very difficult to separate; it may, indeed, be impossible to do so without breaking them. If you have taken too much, they will separate with great readiness, and the blood will spread in uneven smears instead of forming a uniform film.

I used formerly to recommend the use of forceps for holding the cover-glasses in making these films. The only advantage is that it avoids "steaming" the cover-glasses by the condensation

of moisture from the fingers, which may distort the corpuscles. Except when the operator's fingers are very moist it is quite unnecessary, and perfect films may be obtained with the cover-glasses held in the fingers.

The blood may be taken by means of the platinum loop, and this is a good plan, as all danger of smearing the cover-glass upon the skin is avoided. If several films are to be taken, a number of platinum loops should be provided, as the blood upon them soon coagulates. The exact size of the loop can only be learnt by experiment, and when one has been found to deliver a drop of the right size it should be kept entirely for this work and carefully protected from injury.

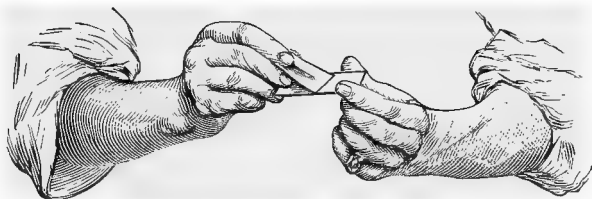

FIG. 52.—METHOD OF SPREADING FILMS WITH CIGARETTE-PAPER.

## II. METHOD WITH CIGARETTE-PAPERS.

*Requisites.*—1. Perfectly clean slides.

2. Some fairly stiff cigarette-papers cut in half longitudinally. Paper which is decidedly ridged or ribbed will not answer.

3. Needle.

*Method.*—The patient is pricked, and the first drop of blood wiped away as before. One of the half strips of cigarette-paper is now held in the right hand, the index-finger being placed above the strip, and the edges held between the thumb and index-finger and the index and middle fingers respectively; this converts it into a gutter, the convex edge of which is downward. The edge of this gutter which points away from you (and which is formed by a machine-cut edge of the paper) is now dipped into the drop of blood, and a small quantity picked up on its lower surface. This lower surface is then placed on a clean slide parallel to one of its shorter edges and about  $\frac{1}{2}$  inch from it, and pressed gently upon it so as to flatten out the paper gutter; as this flattens out the edge of the drop of blood on its under surface will follow it. The strip of paper is now drawn towards

the other end of the slide with a steady uniform movement, and in doing so the drop of blood is spread out into a long uniform film. In this way a film  $\frac{1}{2}$  inch wide and 2 inches long can be made on a single slide. A fresh piece of paper is to be used for each specimen (see Fig. 52).

The author is of opinion that it is best to adopt the cover-glass method, as he has found that it presents fewer difficulties for beginners; this is not the universal experience, and it is a good plan to try both, and adopt that with which you get the best results.

Films are sometimes spread on one slide by means of another, which is used as a spreader in much the same way as the cigarette-paper described above. This is very good for malaria parasites, and for alterations in the red corpuscles, but is useless for making differential counts, as some of the leucocytes are carried along with the spreader and left at the end of the film.

#### FIXATION OF BLOOD-FILMS.

If films are required simply for bacteriological purposes (*i.e.*, to search them for bacteria), they may be fixed by passing them three times through the flame, just as if they were ordinary films. This, however, is not to be recommended in the study of the cells of the blood or of the parasite of malaria, though it answers very well in skilful hands. Three methods should be learnt: the method by heat, the alcohol and ether method, and the formalin method. Of these, the first is necessary if Ehrlich's triacid stain is to be used, but the others are perhaps better for other stains. In addition to these we must mention that *if Jenner's stain is used a preliminary fixation is unnecessary, as the fluid fixes the film and stains it at the same time.* This is the method of blood examination which is most suitable for practitioners, and it is doubtful whether it is not also the best for the most accurate and delicate scientific research.

I. *Method of Fixation by Heat.*—Slides or cover-glasses to be fixed by this method must be exposed to a temperature of  $120^{\circ}$  C. for about five minutes—slides requiring a slightly longer time than cover-glasses.

The ideal way is to use a dry-air sterilizer (see p. 5), to place the films in it whilst cold, to heat up to  $120^{\circ}$  C., and then to turn out the gas. In the absence of this apparatus a metal slab or plate such as has been recommended for use in staining the

tubercle bacillus answers well. It is mounted upon a tripod stand, and the heat applied at one end. After a time the temperature of various portions of the plate is tested by the application of a few drops of water; the point at which the drop assumes the "spheroidal state" (*i.e.*, takes the form of a sphere, and does not wet the plate) is about the right point to use. The slides or films are placed at this point for the appropriate time.

II. *Fixation by Perchloride of Mercury.*—Flood the film with a saturated watery solution of perchloride of mercury, allow to act for a minute, and wash for a minute under the tap, or by washing it in a vessel of water.

This method of fixation is about the best that can be used for general purposes.

III. *Fixation by Alcohol and Ether.*—This is very simple; the films are placed in a mixture of equal parts of alcohol and ether for at least half an hour.

This method of fixation is good, but slow.

IV. *Fixation by Formalin.*—There are several methods by which the fixative action of formalin can be used for blood-work. Of these, the use of a mixture of 1 part of formalin with 9 parts of absolute alcohol answers perfectly. The films are immersed in this for half a minute, and then washed thoroughly under the tap.

This method of fixation is both good and rapid.

#### STAINING BLOOD-FILMS FOR THE INVESTIGATION OF THEIR CELLS.

There are a great many methods of staining blood-films, and all depend upon the division of stains into two varieties, the *acid* and the *basic*. All the stains which are used in this branch of histology are salts, and in some of these salts the acid radicle does the staining, in others the basic.

*Acid stains* are those in which the colouring property resides in the acid of the salt. A familiar example is picrate of potash, a yellow stain in which the picric acid is the active ingredient. The acid stains in chief use are eosin, *acid* fuchsin, and orange G. Substances which stain with an acid stain after suitable exposure to a mixture of an acid and a basic stain are called oxyphile, or, from the frequent use made of eosin as an acid stain, eosinophile.

*Basic stains* are those in which the colouring property resides in the basic radicle of the salt; they include all the stains which are in use for staining bacteria, and they all colour the nuclei of

cells. The most important are methylene blue, methyl green, and toluidin. Ordinary basic fuchsin used in staining the tubercle bacillus belongs to this group, as do hæmatoxylin, carmine, etc.

We shall describe three methods of staining, and these are sufficient for all purposes of diagnosis. They are: (1) Ehrlich's method with his triacid stain; (2) Jenner's method; and (3) eosin and methylene used separately. Of these, the second method is the simplest, and all that is necessary in the vast majority of cases. The third method is an emergency one, for use when Jenner's stain is not at hand: the first is now almost obsolete, but occasionally useful when a study of the granulations of the leucocytes is of importance.

1. *Ehrlich's stain* consists of a mixture of acid fuchsin, orange G, and methyl green dissolved in water, glycerin, and alcohol. It is difficult to prepare, and should be purchased from a trustworthy maker. Its use is very simple. The film is fixed by heat in the manner already described, and the stain is poured on to it, and allowed to act for five minutes. The film is then washed, dried with blotting-paper, and then by gentle heat, and mounted in balsam.

Nuclei are stained green, red blood-corpuscles orange, and eosinophile granulations bright red. The small eosinophile granulations which are present in the polymorphonuclear cells (the neutrophile granulations of Ehrlich) are stained a purplish or coppery colour. The basophile granulations are unstained.

This stain is not suitable for the parasite of malaria, nor for bacteria.

2. *Jenner's stain* consists of a solution of a compound of eosin and methylene blue in methyl alcohol. It must be bought ready prepared. Nothing could be more simple than the way in which it is used; no preliminary fixation is necessary, the film being allowed to dry and flooded with the stain. After a period of from a minute and a half to three minutes, the stain is washed off by waving the film to and fro in distilled or rain water for a few seconds, and the specimen dried by blotting it between two pieces of clean blotting or filter paper, allowed to get quite dry, and mounted in balsam or cedar-oil, and the specimen dried and mounted.\*

\* It has been objected that Jenner's method does not always give good results, and that the above is an insufficient account of the process. Provided that the stain is good (Grubler's can always be relied on, and will keep for

After the use of this stain nuclei are stained blue, red corpuscles red, eosinophile granules red, and basophile granules violet. The descriptions of the leucocytes and abnormal red forms, which are appended, are all based on the appearances seen in films stained by this method, from which also Plates VII. and VIII. were drawn.

Jenner's stain is suitable for a study of the parasite of malaria, which it stains blue. It may be used for the detection of bacteria.

*Leishman's stain* is similar in some respects to Jenner's, and is used as follows: The film is flooded with the stain, which is allowed to act for two minutes; two or three drops of distilled water are then added, and the process allowed to continue for two or three minutes longer. It is then washed, dried, and mounted as above. The colours of films stained by this method differ from those in which Jenner has been used, the main point being that the nucleus of the leucocytes is a fine purplish red; the leucocytes, however, can be easily recognised from the coloured plates.

Leishman's method is the best for working with malaria and all parasitic protozoa, the nuclei of which are stained a bright red. For ordinary blood-work I personally prefer Jenner (perhaps because I am more used to it), and the practitioner is recommended to choose one process and stick to it. If he is likely to need it for malaria or other parasites, Leishman's stain should be used.

### 3. *Eosin and methylene blue used separately.*

In this method the films are to be stained with the eosin first, and then with the methylene blue. Its successful application requires a certain amount of practice.

The eosin used must be in watery solution, and the exact strength does not matter: 4 per cent. is a convenient strength to use. Most specimens of red ink (slightly diluted) will do quite well. The films are to be stained in this solution for three or four minutes; no harm will result if they are left in much longer. They are then washed and immersed in a saturated watery solution of methylene blue. This is the difficult part of the process, for no general rule can be given as to the length of time for which this stain must be applied; it may be ten seconds, or it may be two or three minutes. The only safe way is to stain the

---

several months after being opened, if kept well corked), the method described will always succeed if well-spread films are used. This is essential. But even with bad films (and very bad ones are sent me at times) the results are always sufficiently good to allow a differential leucocyte count to be made,

film for a quarter of a minute, wash it, and then examine it under the low power of the microscope. If the film is properly stained, the nuclei of the leucocytes will be seen as blue points, which can be distinguished with great ease with the  $\frac{2}{3}$ -inch objective. If they are not visible, the methylene blue must be applied for about a quarter of a minute more and the examination repeated. When the nuclei are seen to be well stained the film is dried and mounted.

This process gives results which resemble those afforded by Jenner's stain, except that the fine eosinophile granulations in the polymorphonuclear cells are always less obvious and often quite invisible. It is also suitable for malarial parasites and bacteria.

The practitioner is recommended to practise this method of staining, as it does not require any reagents which are not to be found in every well-stocked surgery. The watery solution of methylene blue which is used as a counterstain for the tubercle bacillus and some red ink are all that are necessary.

## DIFFERENTIAL LEUCOCYTE COUNT

The following varieties of leucocytes are to be recognised, the description in each case being taken from a preparation stained by Jenner's method.

### A. CELLS DEVOID OF GRANULES.

1. *Lymphocytes* (Plate VII., Figs. 1, 2, 3, 4) are variable in size, some being about as big as a red corpuscle, others nearly twice this size. Each has a single nucleus, which is circular or nearly so, and which stains a deep blue. The protoplasm forms a narrow band round the nucleus, and also stains blue, often more deeply than the nucleus.

Variations of these cells occur. In some cases the whole seems to stain uniformly, in which case it is probably a free nucleus (Plate VII., Fig. 3). In others the protoplasm appears to be studded with blue granules, which often lead beginners astray. They are not true granules, but knots in the protoplasmic network.

In healthy adults they average about 25 per cent. of all the leucocytes present, varying between 22 and 28 per cent. In childhood they are more numerous—up to 60 per cent.



The small forms are the more numerous, but as no trustworthy diagnostic information can be drawn from the proportions of the large and small forms, they are usually counted together. Very large forms are often abundant in acute lymphatic leucocythæmia.

*Large Hyaline or Large Mononuclear Leucocytes* (Plate VII., Figs. 5, 6).—These are the largest cells met with in normal blood, and may have a diameter two and a half that of a red corpuscle. They have a round, oval, kidney-shaped, or twisted nucleus, which stains less deeply than those of the lymphocytes, and has often a purplish colour. The protoplasm is relatively more abundant than in the lymphocytes, and stains very faintly of a bluish or purplish colour. It often has false granules similar to those of lymphocytes, but no true ones.

It occurs in small numbers (1 to 4 per cent.), and variations are of little diagnostic importance.

## B. CELLS CONTAINING TRUE GRANULES IN THEIR PROTOPLASM.

1. *Polynuclear Leucocytes* (Plate VII., Fig. 7).—These are rather larger than a red corpuscle, and have a nucleus which is twisted into various irregular shapes; it is often deeply lobed, so that it *appears* to be multiple, but is always really single except in degenerated forms.

It contains in its protoplasm numerous *very fine* granules of a substance which stains pink with the eosin in Jenner's stain, and which are therefore considered by many English pathologists to be fine eosinophile granules. With triacid stain they are a sort of copper colour, quite unlike the large eosinophile granules, and are frequently spoken of as neutrophile. The term is a convenient one, whatever the scientific justification for it.

They vary in numbers between rather wide limits. In the adult 70 per cent. is a fair average, but they may be much higher, and approach 80 per cent. In childhood they are much less numerous (30 to 40 per cent.).

1a. *Myelocytes or Neutrophile Myelocytes*.—These are the mother-cells of the above, and do not occur in the blood in health, but may be found in the bone-marrow. There are two varieties.

*Cornil's myelocyte* is usually a very large cell with a large, faint-staining round or kidney-shaped nucleus, often placed decidedly to one side of the cell or even touching the periphery. The pro-

toplasm is relatively scanty and contains neutrophile granules, often in very small numbers and of feeble staining power. It is often necessary to use triacid stain to demonstrate them; neglect to do this may lead to their being confounded with large lymphocytes or hyaline cells (Plate VII., Fig. 11).

*Ehrlich's myelocyte* is similar to the above, but smaller; it is usually rather larger than a polynuclear. It has a round or oval nucleus, which is often central or but slightly excentric, and which stains deeper than that of Cornil's myelocyte, but not so deeply as that of a polynuclear. Its neutrophile granules are usually distinct (Plate VII., Fig. 10).

Cornil's myelocyte is probably derived from Ehrlich's by a process of degeneration, especially dropsy of the nucleus.

2. *Eosinophile Leucocytes* (Plate VII., Fig. 8).—These are about as large as a polynuclear, and have a nucleus which is usually bilobed, but which may be more distorted. The chief feature of the cell is the presence of numerous relatively large granules which stain brilliantly with the eosin: they are spherical in shape and very uniform in size. They average about 1 to 4 per cent. of the leucocytes in health, but slightly higher or lower figures may occur.

2a. *Eosinophile myelocytes* (Plate VII., Fig. 12) do not occur in healthy blood, and bear the same relation to the eosinophile cells as ordinary myelocytes to the polynuclear cells. They are distinguished from eosinophiles by their larger size and relatively large circular nucleus.

3. *Basophile Cells or Mast Cells* (Plate VII., Fig. 9).—These are about as large as polynuclears, and have twisted (usually *trilobed*) nuclei, which occupy more of the cell than do those of the polynuclears. They have a comparatively small number of granules, which (unlike those of the other leucocytes) vary in size and stain blue or purplish-blue with Jenner. The granules do not stain at all with triacid.

They are often not found in persons in robust health, but in the average hospital patient occur in small numbers—usually less than  $\frac{1}{2}$  per cent.

3a. *Large Mast Cells* (Plate VII., Fig. 13).—These occur only in the blood in myeloid leucocythæmia, and are very characteristic of that condition. They may possibly be eosinophile myelocytes with degenerated granules.

## METHOD OF MAKING A DIFFERENTIAL COUNT.

Having prepared a film by any of the methods previously described, the next step is to make a differential count in the following way: Focus the film under the microscope, using an oil-immersion lens; when you have had sufficient experience it is quite easy to make the count with a  $\frac{1}{8}$ -inch lens, which is quicker, but not advisable for beginners. Then note down the nature of each leucocyte as you come to it, moving the film across the stage of the microscope from end to end, and then moving it a little way upwards or downwards and returning in the opposite direction, so as never to pass over the same part of the film twice. The simplest way of noting down the leucocytes is to assign single letters to each variety, P for polynuclear, E for eosinophile, etc., and to put these down in blocks of five each way, thus:

P P P L E  
 P P L L H  
 L P P P P  
 P L L P L  
 P P P L P

In this way you can tell at any time how many leucocytes you have counted. It is much quicker to dictate the numbers to a second person, who takes them down as described; you do not then have to look constantly from the microscope to the paper, and *vice versa*, and the whole process takes a very few minutes, unless the leucocytes are very scanty.

For most clinical purposes 400 leucocytes will be enough to count, though where very great accuracy is required 1,000 is not too many. Having counted the required number, proceed to count the numbers of P's, L's, etc., and reduce them to a percentage.

Whilst making the differential count keep a sharp look-out for abnormal leucocytes, abnormal red corpuscles (see p. 213), parasites, etc. The collections of blood platelets which form such a prominent feature in some blood films should not be confounded with anything else, as they are quite characteristic, though a single blood platelet lying on the top of a red corpuscle may look very like a young malaria parasite. Each platelet is a very small mass which stains blue or purple with Jenner's stain, and often appears hollow or irregular in shape, and they are often grouped in masses of quite large size.

## ALTERATIONS IN DISEASE.

1. *Lymphocytes*.—They may be relatively increased (*e.g.*, to figures above 30 per cent.) when the total figures are normal or raised. These have different meanings.

Lymphocytosis with *normal* or *lowered* total counts occurs in pernicious anæmia, typhoid fever, uncomplicated tuberculosis (but not always), in some cases of purpura (so-called idiopathic purpura), and occasionally in syphilis, Hodgkin's disease, and some other diseases.

Lymphocytosis with a *high* total count occurs as a normal condition in infancy, and is accentuated both as regards the percentage of lymphocytes and the total number of leucocytes in almost all infantile diseases, especially rickets and hooping-cough.

In adults a very high total count (100,000 or more) with a very high percentage of lymphocytes (up to 99.5 per cent.) indicates lymphatic leucocythæmia. Smaller increases sometimes occur in other diseases.

A relative *diminution* of the lymphocytes frequently occurs as a result of the increase of other leucocytes, rarely as a true absolute diminution.

*Large Hyaline Cells*.—An increase or decrease of these is occasionally observed, but so erratically that it is of no use in diagnosis.

*Polynuclear Leucocytes*.—This is the most common cell to undergo increase, so much so that in the list of causes of leucocytosis given on p. 196 it may be assumed that the increase is due partly or entirely to an increase of polynuclears, unless the opposite is stated here.

One special case needs a reference. In severe sepsis with a normal or diminished polynuclear count it is usual for the polynuclears to be relatively increased, just as they are when the total count is raised. This is very important in diagnosis, for in cases where sepsis is suspected a normal leucocyte count must always be followed by a differential count, and if there is a relative increase (*e.g.*, 85 per cent. or more) of polynuclears it must be regarded as a bad sign. A relative increase of polynuclears with a normal or moderately raised total count may also occur in malignant disease.

A form of degeneration of the polynuclears requires notice, as it is of some practical value. This is the iodine or glycogenic

reaction. To test for it make a film in the ordinary way, dry and mount it without fixation in the following mixture :

Iodine	1 part.
Iodide of potassium	3 parts.
Saturated watery solution of gum acacia	100 parts.

This should not be used more than a fortnight after it has been made. A simpler but equally good method is to expose the film to the fumes of solid iodine for a few hours. This can be done by fixing the film (without previous treatment of any sort) at the top of a wide-mouthed bottle containing the substance; it is then mounted in oil or balsam. Allow it to act for a quarter of an hour or more, then examine with a  $\frac{1}{12}$ -inch lens in a white light—daylight if possible. In cases where the reaction is present a variable number of the polynuclears will be found to contain granules or masses of a reddish-brown or mahogany colour; sometimes there are large masses, and sometimes almost the whole of the protoplasm appears brown.

The importance of this reaction is that it usually occurs, and is indeed very marked, in the cases of severe sepsis in which there is no increase of the total leucocyte count (see p. 198), as well as in suppuration. It occurs in other conditions, such as pneumonia, hooping-cough, uræmia, etc. In many cases a small percentage only of the cells is affected, and a good search must be made.

The fact that it occurs in so many diseases detracts somewhat from its value in diagnosis, but when the question is simply the presence or absence of pus—*e.g.*, in appendicitis—a positive result will usually indicate that suppuration has occurred, and *vice versa*. Hence it is sometimes of value when the leucocyte count yields uncertain results—*i.e.*, figures between 16,000 to 20,000 per cubic millimetre.

*Myelocytes*.—Ehrlich's myelocytes occur in small numbers in many infectious diseases, especially diphtheria, and occasionally in forms of anæmia, but they are only present in large numbers in myeloid leucocythæmia. Cornil's myelocytes are practically limited to the latter condition, where the two forms frequently together make up 60 per cent. of all leucocytes.

*Eosinophiles*.—An increase of eosinophiles (eosinophilia) occurs to a small extent in numerous diseases, and is of diagnostic importance in the following :

1. In diseases due to *animal parasites*. Here the increase may

be very great, as in *trichinosis*, where the eosinophiles usually form 40 to 80 per cent. of all leucocytes, a fact of great importance, and absolutely distinguishing the disease from typhoid fever, rheumatism, and other diseases which may be confounded with it; rarely, however, there may be no eosinophilia, so that its absence does not definitely exclude the disease. In bilharzia disease there is often, though not always, a mild eosinophilia. There is practically always an increase in ankylostomiasis. It may be moderate, or may reach 70 per cent. This fact enables infected individuals to be picked out of a gang of workmen with much less trouble than by an examination of the fæces. In diseases due to other intestinal worms (*ascarides*, *oxyuris*, *tæniæ*), there may or may not be eosinophilia.

In hydatid disease there is frequently a moderate eosinophilia, and sometimes a great one. This is important in the diagnosis between hydatid and abscess of the liver, since in the latter condition the eosinophiles are usually scanty. In such a case the higher the count is above 4 per cent., the more likely is the disease to be hydatid, and *vice versa*.

In the only case of *cysticercus* I have seen the eosinophiles ranged between 5 and 7 per cent.

2. In extensive skin diseases, especially pemphigus and urticaria, there is often a great increase, but it occurs in so many conditions that its diagnostic value is but slight (see p. 232).

3. *Diseases of the lungs*.—In true asthma there is during the paroxysms, and for a short time after them, a very decided increase—to 10 per cent. or so. The cells in the sputum, too, are practically all eosinophiles. This does not occur in the other spasmodic diseases which so mimic true asthma, and is often of critical importance in the diagnosis. Eosinophiles are never found in the sputum in tuberculosis.

4. *Myelogenous leucocythæmia*.—Here there is an enormous absolute increase in the *total* numbers of the eosinophiles, counting the eosinophile myelocytes with them; the *percentage* may not be greater than in health.

This is one of the most constant signs of the condition.

A *decrease* of eosinophiles occurs in nearly all inflammatory leucocytoses, especially in pneumonia, where a careful search over many films may fail to reveal the presence of a single cell. Their reappearance in any of these diseases is of distinctly good omen, and one on which I place a good deal of reliance. It is not of

much value in pneumonia, as it does not occur till after the crisis, but in chronic suppurative diseases, etc., a gradual increase in the eosinophiles often heralds improvement. Neusser holds that the same is true in tuberculosis also.

*Eosinophile Myelocytes.*—The presence of these is practically diagnostic of myelogenous leucocythæmia.

*Mast Cells.*—These only occur in fractional percentages in any disease, except myeloid leucocythæmia, where 5 or 10 per cent. is common; this is perhaps the most definite, constant, and readily recognised sign of the disease. The large forms, with circular or kidney-shaped nuclei, are practically only seen in this condition.

#### MORPHOLOGICAL CHANGES IN THE RED CORPUSCLES.

Normal red corpuscles (Plate VIII., Fig. 1) hardly need description, and the practitioner can readily make himself familiar with their appearance. They are strongly oxyphile, staining pink with the eosin in Jenner's stain, and with acid fuchsin in the triacid. It is especially important to become familiar with their *size*, since modifications in this respect are very important in the diagnosis of certain forms of anæmia.

#### ABNORMAL FORMS OF RED CORPUSCLES.

Two great classes are to be recognised—those which retain the characters of a normal red corpuscle, in that they have no nuclei, and those which resemble the embryonic corpuscles in being nucleated. The former, where they have special designations, have names terminating in -cyte (microcyte, megalocyte, etc., based on the type of the normal corpuscle, which is called erythrocyte, xanthocyte, or normocyte, convenient terms that have never gained wide currency), whilst the nucleated forms have names ending in -blast.

#### ABNORMAL NON-NUCLEATED FORMS (-CYTES).

1. *Microcytes* (Plate VIII., Fig. 4) are red corpuscles which are decidedly below the normal in size, but are otherwise normal. They are indications of anæmia, but, as they may occur in *any* severe anæmia, and do not serve to indicate its type, their recognition is not a matter of much importance.

2. *Megalocytes or Macrocytes* (Plate VIII., Fig. 5).—These are large corpuscles, and the name should be restricted to forms

that are at least one and a half times as broad as a normal corpuscle ; they may be much larger.

It is important to learn to recognise them, since their presence is an almost constant sign of pernicious anæmia, and it is rare to find them in any considerable numbers in other conditions. When you are frequently examining blood-films with the same lens and eyepiece, you will soon be able to pick out forms of abnormal size. When you have not had this experience it is advisable to make a film of normal blood for comparison, and to look first at one and then at the other. A still better method (due to Shattock) is to mount the two films (the normal and abnormal, both stained) face to face, and then to mount the pair on a slide, and examine them with an oil-immersion lens ; a slight turn of the fine adjustment will enable you to pass at once from the one to the other, and to compare the diameters of the corpuscles with some degree of accuracy. Another useful method is to employ the counting-chamber of the hæmocyto-meter, and an idea of the diameter of the reds should be gained in all cases of pernicious anæmia whilst the count is being made. The diameter of one of the small squares is almost exactly six times that of a normal red corpuscle. If you look at the squares with a central ruling, you will be able to compare any corpuscles which may be in them with the semi-diameter ; the one should be one-third of the other, and you may consider as a megalocyte any corpuscle which is one-half or more of this semi-diameter.

3. *Poikilocytes* (Plate VIII., Fig. 6) are deformed corpuscles, and are typically shaped like a pear, but may be kidney-shaped or quite irregular. They may be about as large as a normal corpuscle, or smaller, or larger, and they may stain abnormally. Poikilocytes are more common in pernicious anæmia than in other diseases, but are not of much diagnostic importance, since they only occur in advanced stages of the disease, long after the diagnosis should have been made. To recognise them, put a small drop of blood on a perfectly clean slide, apply a cover-glass, and examine at once ; do not identify poikilocytes in dried films or in the counting-chamber of the hæmocyto-meter until you have had a good deal of experience, as accidentally injured and contorted forms may occur in either.

4. *Polychromatophil Degeneration* (Plate VIII., Fig. 3).—In this condition the corpuscle (which may otherwise be normal or abnormal in other ways), instead of being strictly acidophile in



its staining reactions, stains with the basic stain to a greater or less extent; thus, with Jenner's stain it stains a variable mixture of pink (from the eosin) and blue (from the methylene blue). It may be lilac, purplish, or almost pure blue. The change is readily recognisable in ordinary films stained by Jenner's method.

It is especially common in pernicious anæmia and in von Jaksch's anæmia of children, but may occur in almost any form of anæmia, if very severe. It is not a very important diagnostic feature, but its presence always constitutes a bad sign.

5. *Granular degeneration* (Plate VIII., Fig. 2) takes the form of numerous granules of varying size, which occur in the red corpuscles, and which stain almost black with the basic portion of the stain; the rest of the corpuscle often shows polychromatophil degeneration.

It occurs also in any severe anæmia, especially in von Jaksch's anæmia, where corpuscles in which it occurs may be extremely plentiful. Except where this occurs it is not of much diagnostic importance, unless it is true that it occurs as a very early and constant sign in lead-poisoning.

#### NUCLEATED FORMS (-BLASTS).

1. *Normoblasts* (Plate VIII., Figs. 7, 8, 9).—These are corpuscles which resemble the normal in shape and size, but which have a nucleus. This is central, large in proportion to the corpuscles, surrounded by a comparatively narrow band of stroma, and circular; in some cases it is double or multiple. Normoblasts can usually be recognised with ease from any other cells which occur in the blood, from the fact that the nucleus stains very deeply—more deeply than any other found in the blood. It frequently happens that the narrow ring of stroma may show polychromatophil degeneration and stain blue; in this case it is difficult to distinguish the cell from a lymphocyte, but the deeply stained, almost black, nucleus should prevent mistakes.

Normoblasts are the cells from which the normal blood-corpuscles are formed, but in health they are confined to the bone-marrow, except in very young infants, in whom a very few may be found in the circulation. Their presence in the blood of older persons indicates an anæmia of some severity, and that this anæmia is being combated in a normal way; the bone-marrow is so active that some of its normoblasts overflow into the circulating blood. They are therefore rather a good sign than otherwise.

Occasionally you may find them in very large numbers in the blood of a case of anæmia, especially in chlorosis: this is called a "blood-crisis," and when it occurs the patient will improve very rapidly. If you want to count their numbers, the simplest way is as follows: Count the leucocytes in the way already described, and calculate the number per cubic millimetre. Then take a stained film and count 400 or 500 leucocytes, noting how many normoblasts you see whilst doing so. A simple calculation will give the number of normoblasts per cubic millimetre. Thus, if there are 8,000 leucocytes per cubic millimetre, and 72 normoblasts are seen whilst counting 500 leucocytes, the total number of normoblasts per cubic millimetre is  $\frac{72 \times 8,000}{500} = 1,152$ .

2. *Megaloblasts* (Plate VIII., Figs. 10, 11, 12).—The recognition of these is of the utmost importance, as if they are present in any appreciable numbers in the blood of an adult the diagnosis of pernicious anæmia is almost a certainty, and if a single example is found the diagnosis is highly probable. They occur very rarely in adults in other conditions, but are more common in severe anæmia in childhood, especially in von Jaksch's anæmia, where they may be plentiful.

In size megaloblasts resemble megalocytes, but may be even larger; very large forms are called gigantoblasts, and may have a diameter nearly three times as great as a normal corpuscle. A megaloblast has a nucleus which is usually larger than that of a normoblast, though it may be smaller in proportion to the size of the cell; it is sometimes double or multiple. It stains much less deeply than the nucleus of a normoblast—in fact, it may stain so faintly that it is overlooked. Except for this the only mistake commonly made by beginners is to confuse a megaloblast with polychromatophilic stroma (which frequently occurs) with a large hyaline leucocyte.

## DIAGNOSTIC APPLICATIONS OF THE BLOOD-COUNT AS A WHOLE

In this chapter a brief outline of the chief practical applications of the blood-count will be given, with especial reference to cases where it is of use in the discrimination between two diseases which are difficult to distinguish clinically.

**HÆMORRHAGE.**—After a severe hæmorrhage there is at first no alteration of the blood; the total volume is diminished, but the

part that remains is normal. In a very short time, however, fluid is absorbed from the tissues so as to make up the normal volume, and in consequence the red corpuscles and hæmoglobin fall *in the same proportion*. With this there is usually a leucocytosis, high figures (20,000 or more) being sometimes reached; do not forget this in dealing with a blood-count in a patient who has recently had a hæmorrhage. As the process of regeneration continues, the improvement shows itself first in an increase of the red corpuscles, so that the colour-index falls slightly (to about 0·9).

The anæmia from repeated hæmorrhages is one of the varieties of secondary anæmia.

**SECONDARY ANÆMIA.**—This term is used for anæmia which is due to any definitely recognised cause—hæmorrhage, malnutrition, sepsis, intoxications (*e.g.*, lead-poisoning), etc.—that is to say, it includes all cases of anæmia except those of unknown pathology, such as chlorosis and pernicious anæmia.

In secondary anæmia there is a reduction of red corpuscles to an extent dependent on the potency and continuance of the cause, and a slightly greater reduction of the hæmoglobin, so that the colour-index is lowered. It does not usually fall below 0·7, and 0·8 may be taken as a fair average. Anything below this is rarely met with apart from chlorosis. The red corpuscles are usually practically normal in appearance; normoblasts are rare, and their presence is a good sign.

The leucocytes, especially the polynuclears, are usually slightly increased, and this is the chief or only means of distinguishing a secondary anæmia with low colour-index from chlorosis, in which the leucocytes are normal or reduced.

**PERNICIOUS ANÆMIA.**—The feature which usually first raises suspicion of pernicious anæmia is the *high colour-index*. It is usually over 1, and, taking the average of a number of cases, it increases in proportion to the amount of reduction of the corpuscles, thus:

RED CORPUSCLES.	AVERAGE COLOUR-INDEX.	
	Pernicious.	Secondary.
Under 500,000	1·6	—
500,000 to 1,000,000	1·4	—
1,000,000 to 2,000,000	1·23	0·77
2,000,000 to 3,000,000	1·2	0·82
3,000,000 to 4,000,000	0·99	0·82

When you find a case with a high colour-index, it should immediately raise a suspicion of pernicious anæmia. Look again at the preparation in which you have counted the reds in the Thoma-Zeiss hæmocytemeter, and look for unusually large corpuscles (megalocytes), which, according to Ewing, should form 35 per cent. of all corpuscles, or the diagnosis is to be made with caution. Then count the leucocytes in the same preparation. *Leucopenia* is very characteristic; if the number exceeds 6,000, pernicious anæmia is unlikely, unless inflammatory complications are present. Then make a differential count on a stained film, looking out for *megaloblasts* and *normoblasts* as you do so; in pernicious anæmia there is almost always a *relative lymphocytosis*, and the diagnosis is unlikely with the lymphocytes much below 40 per cent. If you have not yet seen a megaloblast, continue to search for them, as they are usually present in pernicious anæmia of moderate severity, and comparatively rare in other conditions, except in children. The significance of the discovery of a single megaloblast will depend on the other findings; if these point to pernicious anæmia, the megaloblast may be taken as clinching the diagnosis, but if they are not of this nature its importance is much less. Do not exclude pernicious anæmia because no megaloblasts are found. According to Ehrlich and others they always exceed the normoblasts in numbers, but this is not a safe guide, as in some cases you may find normoblasts alone on some occasions, and megaloblasts and normoblasts in differing proportions on others. Polychromatophil and granular degeneration and poikilocytosis are common in advanced stages of the disease, but the diagnosis ought to have been made before their appearance.

The diagnosis from *secondary anæmia* rests on the high colour-index, the leucopenia, lymphocytosis, nucleated corpuscles and megalocytes, and is usually easy. Anæmia associated with *intestinal parasites* may resemble idiopathic pernicious anæmia in every respect except in that the former is accompanied by eosinophilia. In pernicious anæmia the eosinophiles are usually low, and if they exceed 4 per cent. the fæces should be searched for the ova of parasites (especially ankylostoma, bothriocephalus and oxyuris). The anæmia of *carcinoma of the stomach* and other gastric diseases may closely resemble pernicious anæmia, but in most cases there is a high leucocyte count, with increase of polynuclears and diminution of lymphocytes.

CHLOROSIS.—Here there is a moderate reduction of the red

corpuscles and a great reduction of the hæmoglobin ; the colour-index falls, therefore, and 0·5 may be taken as an average, though much lower figures occur. The corpuscles are pale, but abnormal forms are rare. Normoblasts are very rare, but when they occur usually herald a rapid improvement. The leucocytes are normal in numbers, or there may be leucopenia.

It may be confounded with various forms of secondary anæmia, but in them the colour-index is usually higher, and the leucocytes, especially the polynuclears, tend to be increased.

MYELOGENOUS LEUCOCYTHÆMIA ("spleno-medullary").—There is an enormous increase in leucocytes, which in an average case may amount to 400,000. *All* varieties of leucocytes are increased in absolute numbers, but the increase mainly affects the polynuclears and the eosinophiles ; the lymphocytes are relatively so scanty that they may be difficult to find. In addition, there are abnormal cells : eosinophile myelocytes and large cells with basophile granulations, cells occurring in practically no other disease, and both Ehrlich's and Cornil's myelocytes.

There is usually anæmia of the secondary type, and normoblasts are numerous.

The whole picture is most characteristic, and can hardly be mistaken for anything else.

LYMPHATIC LEUCOCYTHÆMIA.—There is no difficulty in the recognition of a typical case of chronic lymphatic leucocythæmia ; the leucocytes are enormously increased (100,000 to 1,000,000), and consist almost entirely of lymphocytes (often up to 99 per cent.) : in many cases the large forms predominate. There is also a varying degree of secondary anæmia.

In an adult these appearances are quite characteristic, but in childhood similar counts may be seen in a variety of conditions, such as hooping-cough, broncho-pneumonia, etc., though it is rare to find a figure as high as 100,000.

In some acute cases of lymphatic leucocythæmia similar appearances occur. In others the increased percentage of lymphocytes is present, but not the total increase ; thus, in one case fatal in a few weeks I never found more than 10,000 leucocytes, in which the lymphocytes varied between 76 per cent. and 100 per cent. These cases are very difficult to diagnose from acute tuberculosis of the lymphatic glands. In the latter case the total count may be expected to be low, in the former slightly raised ; in tubercle the percentage of lymphocytes rarely

exceeds 50, whilst 75 per cent. at least would be required before the condition under discussion could be diagnosed.

Other diseases (especially acute purpura hæmorrhagica) give very high lymphocytoses in adults, but as they are quite different clinically the blood-count would not be misleading.

HODGKIN'S DISEASE.—There is little doubt that several diseases are included under this heading. In the true Hodgkin's disease there is at first no change in the blood, not even anæmia; in one case I examined at intervals for over a year the red corpuscles were always above 5,000,000, and the hæmoglobin above 100 per cent. Later, there is anæmia of secondary type, with a slight leucocytosis, with or without a moderate increase of polynuclears. In other cases there may be anæmia from the first, a normal or diminished number of leucocytes, and a relative increase of lymphocytes of moderate amount; these cases are probably more closely allied to lymphatic leucocythæmia, and for them the term "pseudo-leukæmia" might be used. I believe them to be of more rapid course than true Hodgkin's, but the two cannot be definitely separated on clinical grounds alone.

The diagnosis between these forms of enlarged glands and those due to tuberculosis cannot be made by a blood-count. The opsonic index to tubercle may be of assistance.

LYMPHOSARCOMA is also associated with a practically normal blood condition, and cannot be diagnosed from aleukæmic leucocythæmia and Hodgkin's disease.

SPLENIC ANÆMIA.—It is very doubtful whether this disease is really a distinct entity, and it is certain that many of the reported cases have nothing in common but the accidental and not unusual concomitance of anæmia and an enlarged spleen. In the cases in which the name may fairly be applied there is idiopathic enlargement of the spleen, with anæmia; the latter is usually of medium grade, figures under 2,500,000 being uncommon, and the colour-index is moderately low (0·7 to 0·9). In severe cases there may be numerous normoblasts, poikilocytes, and polychromatophil degeneration of the red corpuscles. The only feature that can be considered as characteristic is the frequent presence of *leucopenia* with relative *lymphocytosis*; there may be a few myelocytes.

It may be confounded clinically with myelogenous leucocythæmia or pernicious anæmia, but is readily distinguished by the blood-count. In secondary anæmia with an enlarged spleen (such as occurs in malignant disease, infective processes, etc.) there will

probably be a polynuclear leucocytosis. Hodgkin's disease with an enlarged spleen and without palpable glands may be indistinguishable from splenic anæmia, and probably some of the recorded cases have been of this nature.

**ANÆMIA IN INFANCY.**—The rules for the interpretation of blood-counts in adults are not applicable in infancy, where the conditions of blood formation are so different. In particular the presence of nucleated red corpuscles, and especially of megaloblasts, is of little importance, and frequently occurs in conditions insufficient to call for their appearance in older patients. The colour-index is extremely variable; it usually tends to be very low, although this does not indicate a disease having any connection with chlorosis, a disease which does not occur in infancy. On the other hand, a high colour-index is not infrequent, and does not necessarily point to pernicious anæmia, which is excessively rare. Lastly, degenerative changes, such as poikilocytosis, granular degeneration, and polychromatophilia, are very common, occur in comparatively mild grades of anæmia, and have not the serious import they have in the adult.

*Leucocytosis in Anæmia in Infants.*—This is very common, 20,000 to 60,000 being frequently met with; in most cases there is a predominance of lymphocytes, and the presence of myelocytes is quite common, rendering the diagnosis from leucocythæmia a matter of some difficulty. As a general rule, the presence of a high leucocytosis in infantile anæmia is a bad sign, and indicates a worse prognosis than if it is absent.

*Secondary Anæmia in Infancy (Syphilis, Rickets, Scurvy, Tubercle, etc.).*—There are no characteristic changes by which the different causes of secondary anæmia can be recognised. The colour-index is usually low (especially, perhaps, in syphilis), normoblasts are not uncommon, an occasional megaloblast may be seen, and there is often leucocytosis, with increase of lymphocytes.

*Von Jaksch's Anæmia (Anæmia Infantum, Pseudo-leukæmia).*—It is uncertain whether this is to be considered as a definite disease, as an intermediate form between pernicious anæmia and leucocythæmia, or as a form of secondary anæmia with somewhat characteristic blood changes. I am rather inclined to the belief that it does represent a definite blood disease, but that it is frequently associated with, and perhaps due to, other diseases such as syphilis, rickets, tubercle, or gastro-intestinal diseases. The blood changes are—(1) An excessive grade of anæmia, usually

associated with a low colour-index; in some cases, however, it may be high, and I have seen it as high as 1·8. (2) High leucocytosis, often 50,000 or more, with extraordinary changes in the leucocytes, so that they can hardly be classified on the usual lines; myelocytes are not uncommon. (3) Striking and profound changes in the red corpuscles, the most important being the presence of numerous normoblasts, many of which show *dividing nuclei* (Plate VIII., Fig. 8); megaloblasts and atypical forms occur, but are less numerous. The non-nucleated red corpuscles show all forms of degeneration, poikilocytes, megalocytes, and microcytes being present, whilst many are affected with granular basophilia (Plate VIII., Fig. 2) or polychromatophilia (Plate VIII., Fig. 3). In severe cases the majority of the red corpuscles may be abnormal, and the appearance of the stained films is very extraordinary.

The prognosis of these cases is fairly good if proper treatment be adopted—much better than in the primary blood diseases with which they might be confounded.

SEPSIS, SUPPURATION, AND SEPTICÆMIA.—In most cases of infection with septic bacteria, whether local or general, there is marked leucocytosis, due especially to an increase in the polynuclear leucocytes. For instance, in an ordinary case of appendicitis of average severity we may expect the number of leucocytes to rise gradually to 25,000 or 30,000, about 90 per cent. being polynuclears. At the same time there is usually a moderate fall in the amount of hæmoglobin and in the number of red corpuscles. In practice we have to consider three types, in each of which the blood-counts vary.

1. *Very Severe Cases.*—Puerperal and other forms of septicæmia, general septic peritonitis due to very virulent bacteria, especially in an enfeebled patient, etc.

Here there may be but slight leucocytosis, and this, taken in conjunction with the patient's general condition, is not a good sign, but a bad one. In many cases the total number is within the normal limits, but whether this is the case, or whether the leucocytes are slightly increased, a clue to the condition will be given by the fact that the polynuclears show their usual increase, and the glycogen reaction is present and often very marked.

The hæmoglobin, however, gives much more valuable indications; the severer the case the more rapidly it falls, and *vice versa*. The same information can be obtained, though not so well, from



the variation in the red corpuscles. Thus, in a case of severe sepsis of any sort the red corpuscles and hæmoglobin may fall enormously in a few days. This is a very valuable test for puerperal fever. Under ordinary circumstances the amount of blood lost at parturition should not lower the corpuscles below 4,000,000, and if a count greatly below this is found in a few days' time, there having been no severe hæmorrhage in the meantime, the diagnosis of septic infection is probable, whatever be the numbers of the leucocytes; if at a later date the numbers are lower still, the diagnosis is almost certain. The hæmoglobin may fall 10 per cent. per day, or even more in a severe case.

Conversely, a rise in the number of red corpuscles and hæmoglobin is a good sign when the existence of septic infection is certain, whatever be the clinical condition; a cessation of the fall is good also, but to a less extent. (Beware, however, of mistaking a concentration of the blood from diarrhœa or profuse vomiting for a true rise.) As an example I may quote the case of a patient under Dr. Hayes in King's College Hospital, in whom about a fortnight after parturition there were 1,306,000 reds, 26 per cent. hæmoglobin, 13,400 leucocytes, of which 87 per cent. were polynuclears. Here 2,700,000 reds had been lost in two weeks, indicating a very severe sepsis. Her condition appeared desperate, yet in a week the reds had increased to 2,750,000, in a fortnight more to 3,760,000, when for the first time she showed clinical improvement. In nine days more they had reached 4,000,000, and the patient was out of danger. Here a good prognosis was given solely on the blood-count.

In these cases a great diminution or total disappearance of the eosinophiles is a bad sign, their reappearance a good one.

2. *Suppuration.*—Where the sepsis is localized and not so severe, so that a limited focus of suppuration occurs, there is a leucocytosis which, in round figures, exceeds 20,000, and the increase is mainly due to a rise in the polynuclears. Various writers give different figures as that above which pus is indicated: some take 15,000, which I find to be reached fairly often when there is no pus; others 25,000, which is frequently not reached when suppuration has occurred. The number 20,000 has been taken as the result of a considerable amount of experience of all forms of suppuration, and will prove a correct indication in *at least* 90 per cent. of all cases. It is especially useful in appendicitis, in which

it is an almost certain guide. The glycogen reaction is usually present, and is a valuable confirmatory test.

The following considerations must be remembered:

(a) The increase of leucocytes to the figures mentioned above only occurs when the pus is pent up, not when it occurs on a free surface and can escape. I have twice seen a rapid fall of the leucocytes due to rupture of an appendicitic abscess into the intestine.

(b) Where the spread of the suppuration ceases (due to the death or latency of the organisms it contains) the leucocytosis gradually subsides, and an old, thick-walled collection of pus in the tissues may give a normal count. This is especially common in gonorrhœal pyosalpinx; the gonococcus dies out rapidly, but the pus remains, and unless you examine the case early there will be no leucocytosis, or but little.

(c) The leucocytosis gives no indication of the seat of the pus; there may be a small abscess in the body far from the region under suspicion.

(d) The height of the leucocytosis gives no indication of the size of the abscess or of its severity.

(e) In interpreting a high leucocytosis to mean pus, you must exclude the other causes of a similar blood condition—pneumonia, etc. Thus, in a severe abdominal disease leucocytosis may be due to an ovarian cyst with a twisted pedicle, a ruptured tubal gestation, etc.

(f) Cold (tuberculous) abscesses do not usually give a polynuclear leucocytosis; if there is one, it indicates a secondary septic infection, and is a decidedly bad sign.

3. In moderate cases of septic or other form of inflammation, suppuration of free surfaces, etc., there is usually a moderate leucocytosis (up to 18,000), with increase of the polynuclears.

TYPHOID FEVER.—In the early stages there is usually some concentration of the blood, the red corpuscles often exceeding 6,000,000; at a later period they fall somewhat, but rarely below 4,000,000. In most other diseases (malaria, septicæmia, tuberculosis, etc.) for which typhoid is likely to be mistaken the rule is to find marked diminution of the red corpuscles; when these are high with a fever of some duration typhoid fever should be suspected.

The leucocytes are usually normal or diminished in numbers (3,000 to 6,000), and there is often slight excess of lymphocytes (average about 50 per cent.). This is not unlike what occurs in

tubercle and malaria, but is of diagnostic value in distinguishing typhoid from septicæmia, in which case there may be no excess of leucocytes, but there is usually a relative excess of polynuclears. The number of leucocytes in typhoid is of some value in prognosis; the lower the count, the more severe the case, though to this rule, as to all others in blood-work, there are exceptions.

In the later stages of the disease the diagnosis is best made by Widal's reaction.

*Complications.*—Here the condition of the patient must be taken into account; a complication (*e.g.*, perforation) which causes a rapid and marked leucocytosis in a patient who has not been greatly enfeebled by a long and severe illness may cause no increase, or even a diminution, in an exhausted subject. If this rule is forgotten, the indications from the blood-count may be unjustly stigmatized as misleading.

*Perforation.*—There is a rapid increase of leucocytes, which is said to occur in half an hour; the total number may be 15,000 or more. In a patient who is not greatly exhausted this is a very sure sign; exceptions do occur, but are not frequent.

*Hæmorrhage.*—If a count has been made a short time previously, a fall in the red corpuscles may be noticed in some cases, but does not always seem to occur. There may also be slight leucocytosis; this is only of importance in that it leaves the diagnosis of perforation or hæmorrhage doubtful, though raising the presumption that one or other has occurred. As a rule it is not high, and the more it rises above 15,000, the more likely is perforation to be the cause.

*Pneumonia.*—When it occurs early in the disease there is usually a *slight* leucocytosis; when it occurs later there may be none. Do not exclude pneumonia, therefore, because of its absence.

It follows from the above that a raised leucocyte count in typhoid fever always points to a complication of some sort, but does not necessarily indicate its nature.

**PNEUMONIA.**—Here the results of blood examinations are fairly constant, and of much value in diagnosis and prognosis. In ordinary cases there is marked leucocytosis, due entirely to an increase of the polynuclears, which may reach 95 per cent. There is also moderate secondary anæmia.

According to Ewing, who has had much experience on the subject, the grade of leucocytosis is roughly proportionate to the extent of the lesion. The following are his averages:

	Average Leucocytes.
1 lobe affected	20,000
2 lobes    ,,	22,700
3    "    "    -    -	25,000
4    "    "    :	27,000

But higher counts, often much higher, are frequently seen.

These figures serve to exclude typhoid fever, tuberculosis, acute tuberculous pneumonia, and influenza, which do not cause leucocytosis; a true lobar pneumonia implanted on the latter raises the leucocyte count, a lobular one does not.

In a few cases of pneumonia there is no leucocytosis, but these hardly detract from the value of the sign. They are (1) very mild cases, and (2) very severe ones, usually rapidly fatal, in which the system fails to react to the infection; the iodine reaction of the leucocytes is well marked in these. A low count in pneumonia, therefore, may be a good or bad sign: which it is can be told by a glance at the patient. A moderate leucocytosis which gradually declines is a bad sign in a case of any severity.

As a rule the leucocytes fall to nearly normal at the crisis, sometimes a little before; in such cases the crisis may be predicted, and a sudden fall to normal after a week or so is of very good omen. If the leucocytes remain up after a crisis it is most likely to be due to empyema.

**MALARIA.**—Here, of course, the diagnosis should be made by finding the specific micro-organism in the blood (p. 142). Where this cannot be done the case may still be one of malaria, and the blood-count may aid in the diagnosis. There is anæmia, often coming on rapidly and attaining very low figures. There is no leucocytosis, and according to many observers there is a great increase in the large lymphocytes, which almost always become more numerous than the small ones. This test is not interfered with by the administration of quinine, which renders the parasites difficult or impossible to find.

**SCARLET FEVER AND MEASLES.**—In the former there is, except in the very mildest cases, a marked leucocytosis; in the latter the blood is normal in the absence of pneumonia or other complications. In scarlet fever the leucocytes range from 10,000 to 40,000, and according to some authors the prognosis is very bad in cases showing more than 30,000; there is an excess of polynuclears (80 to 90 per cent.), which is very noticeable in children, where there is usually a high proportion of lymphocytes.

GERMAN MEASLES is not accompanied by leucocytosis.

HOOPING-COUGH.—There is a high grade of leucocytosis (20,000 to 60,000), due mainly to an increase of lymphocytes. This is said to occur before the hooping occurs and to be of diagnostic value, but leucocytosis with lymphocytosis is so common in children that little value should be attached to it unless really high figures are found.

INFLUENZA.—Here the blood-count may be of value, since, in contradistinction to the majority of acute febrile diseases, there is no leucocytosis if complications are absent. In other febrile diseases of rapid onset—pneumonia, tonsillitis, rheumatic fever, septic affections, plague, etc.—leucocytosis is almost constant.

RHEUMATISM.—Except in the very mildest cases there is leucocytosis, and, according to Turk, Ewing, and others, when there are more than 20,000 there is almost certainly some complication, such as endocarditis, pericarditis, pneumonia, or hyperpyrexia. I believe this may be taken as a safe general rule, though exceptions do occur.

Turk believes that a clue to prognosis may be got from the percentages of eosinophiles present; with a proportion above the normal the case is likely to be a mild one.

TUBERCULOSIS.—There is usually marked anæmia of the secondary type, but in cases with sweating and diarrhoea this may be masked by the concentration of the blood; an apparent improvement in this respect may in reality be a bad sign. The leucocytes are usually normal, though the lymphocytes may be rather high.

Where secondary septic infection takes place—*e.g.*, in a vomica—the blood is that of sepsis; there is a variable leucocytosis, excess of polynuclears, and advancing anæmia.

The blood-count is not of much value in the *diagnosis* of tubercle; it is of some value in *prognosis*. Increase in the polynuclears and in the grade of anæmia are bad signs in phthisis.

There are one or two precautions to be noted in special cases. In tuberculous empyema there is *frequently* a secondary infection, and the presence of a leucocytosis does not show that the disease is not tuberculous; the same thing applies to tuberculous abscesses in other parts, including the joints.

Tuberculous meningitis appears to offer the most marked exception to the rule, that uncomplicated tubercle does not cause leucocytosis. Here there is often moderate leucocytosis, and

according to Horder it may reach 25,000. I have several times met with 20,000 or thereabouts. Tuberculous pleurisy is usually without marked leucocytosis, but *occasionally* the figures may reach 18,000 to 20,000.

**SYPHILIS.**—There is usually progressive secondary anæmia with moderate leucocytosis (12,000 to 16,000), due mainly to increase of lymphocytes, often of the large type, but the figures are too inconstant to be of much value in diagnosis (see p. 180, Justus's test).

**PURPURA HÆMORRHAGICA.**—There is naturally advancing anæmia, which may be associated with a low or normal colour-index. In the most common type of case, in which the prognosis is relatively good, there is also the usual slight polynuclear leucocytosis met with in secondary anæmia, or it may reach a very high grade. In some cases, however, in which the prognosis is extremely bad, there is leucopenia with lymphocytosis. In one case (under Dr. Dalton at King's College Hospital) which was fatal in a few days the leucocytes were 2,000 and the lymphocytes over 95 per cent. A blood-count should always be made in purpura hæmorrhagica, when these cases (probably quite different in nature) may be diagnosed early and their gravity recognised.\*

**MALIGNANT TUMOURS.**—These are frequently associated with a moderate leucocytosis, with increase of the polynuclears, and slight anæmia. The leucocytosis is said to be more marked in the sarcomata than in the carcinomata. These facts are very rarely of value in diagnosis, since whilst the growth is small and removable the blood is usually normal, except in an ulcerated carcinoma of the gastro-intestinal tract, and in any case there are so many examples of malignant growth with normal blood, and so many causes of slight leucocytosis, that its presence is not much help. Malignant tumours of the œsophagus are occasionally unaccompanied by leucocytosis, but most follow the general rule. †

**CANCER OF THE STOMACH.**—The frequency with which difficulty arises in the early diagnosis of this condition renders any assistance important, and although the indications given by the blood-count are not conclusive, they are helpful in conjunction with the clinical examination and the investigation of the vomit (p. 115). In some cases the blood is normal, but usually there is one of two conditions: either a marked secondary anæmia with a rather low colour-index (averaging 0.63 according to Osler and McCrae),

\* Some at least of these cases are really acute lymphatic leucocythæmia without glandular lesions.

with slight polynuclear leucocytosis—about 12,000 to 18,000, of which 80 to 90 per cent. are polynuclears; or a condition closely resembling pernicious anæmia, with a high colour-index, megalocytes, and occasionally megaloblasts. In the latter case the diagnosis from true pernicious anæmia may usually be made by the fact that in carcinoma ventriculi there is polynuclear leucocytosis instead of the leucopenia with lymphocytosis of pernicious anæmia. The blood finding in this case is very suggestive.

According to some authors there is no digestion leucocytosis in cancer of the stomach, whilst there is in other diseases. There appear to be numerous exceptions to this rule, though it is true in the majority of cases, and might be allowed *some* weight in forming a diagnosis. To test for it enumerate the leucocytes in a patient who has eaten nothing since the previous day; let him take a meal (of which meat should form part), and repeat the examination in three or four hours' time; a rise of 2,500 to 3,500 may be considered normal.

ULCER OF THE STOMACH with hæmorrhage leads to secondary anæmia, but, unlike carcinoma of the stomach, is usually unassociated with leucocytosis. There are exceptions to this rule, and when the ulcer reaches the peritoneum and causes local peritonitis, or ruptures and causes general peritonitis or localized abscess, leucocytosis occurs.

CIRRHOSIS OF THE LIVER.—In ordinary uncomplicated alcoholic cirrhosis there may be anæmia, but there is no leucocytosis, or at most very little. In most of the diseases for which it may be mistaken an ordinary polynuclear leucocytosis is present.

Hanot's cirrhosis is said to be accompanied by leucocytosis, but, as this may be intermittent, the diagnostic value of the test cannot be great in cases where no leucocytosis is found.

ABSCESS OF THE LIVER AND HYDATID CYST.—The former disease is usually associated with leucocytosis, the latter is not, though here, again, there are exceptions. Some importance should be attached to the simple count, but more to the differential count, since in hydatid the eosinophiles are usually raised (57 per cent. has been recorded, but 6 to 8 per cent. is more usual), and in ordinary septic disease are absent, low, or normal, and these rules apply whether the leucocytes are normal or increased.

PERITONITIS AND APPENDICITIS.—See p. 222, Sepsis and Suppuration.

PLEURISY AND EMPYEMA.—With a mechanical pleural effusion

(cardiac or renal) there is no leucocytosis. With simple non-tuberculous pleurisy the blood is usually normal, and the same holds in the tuberculous cases, but here the leucocytes are occasionally raised to 18,000 or more. Such cases may be distinguished from pneumonia or empyema by the presence of the iodine reaction in the latter and its absence in pleurisy. Empyemata are always associated with a high leucocytosis, except sometimes in the tuberculous forms.

ASTHMA.—True asthma has a very characteristic blood condition. During an attack there is a leucocytosis of moderate grade, with a great increase of eosinophiles; 10 per cent. may be taken as an average, though much higher counts have been recorded. In the intervals the total numbers are normal, but there is usually a moderate eosinophilia, 5 to 7 per cent. or more, and I have found a slight increase of mast cells (about 1 per cent.), which is so rare a phenomenon that it may be of some diagnostic value. Eosinophilia rarely occurs associated with other forms of spasmodic dyspnoea, and its presence serves to diagnose asthma from cardiac or renal dyspnoea—often a matter of great importance—or from dyspnoea due to pressure on the bronchi, trachea, etc.

The sputum in asthma is usually characteristic, and contains the peculiar spirals and vast numbers of eosinophile cells; these are rarely seen in cases of bronchitis, but never in any numbers in other diseases.

BRONCHITIS AND BRONCHO-PNEUMONIA.—With simple bronchitis there is the usual inflammatory leucocytosis, usually about 12,000 to 14,000. In broncho-pneumonia the count is much higher—20,000 or more. This applies to children as well as to adults.

ENDOCARDITIS.—Not much help can be obtained from the leucocytes in the diagnosis between the simple and the malignant form, since in either case there may be a normal or slightly raised count. But in malignant endocarditis there is usually a rapidly increasing anæmia of secondary type. The true test, however, is the bacteriological one; the blood is sterile in simple endocarditis, whereas organisms are usually found in ulcerative cases, though more than one examination may be necessary.

VALVULAR LESIONS require brief mention, since their presence causes alterations which might cause embarrassment in the diagnosis of other conditions if unrecognised. With mitral lesions, if not fully complicated, there is a tendency for an increase in the red corpuscles (due to venous stasis) which may reach 8,000,000.



In morbus cæruleus it may be still higher—10,000,000 or more. In aortic disease, on the other hand, there is a tendency to slight anæmia. The leucocytes remain normal in both cases.

**PUERPERAL FEVER.**—The great difficulty in interpreting blood findings in the puerperium is the fact that the blood is not normal immediately before child-birth. The change affects the leucocytes, which are increased, it may be as high as 36,000 (Cabot); this is a very unusual figure, and on the average the numbers do not exceed 16,000 in primiparæ and 12,000 in multiparæ. Leucocytoses within these limits are to be looked on as being probably normal, and not as indicating sepsis. More information may be gained by counts at intervals. The figures should decrease rapidly after delivery, becoming normal in less than a fortnight, and if a count remains the same on two successive days an inflammatory process is suggested, and a definite rise constitutes almost absolute proof. It is in these cases especially that the glycogen reaction is of value, and its presence should outweigh that of the total numbers. The differential count is not of much value, since the polynuclears are increased in normal pregnancy, unless these cells reach 90 per cent. or more.

The chief reliance is to be placed on the hæmoglobin. It should be normal or slightly reduced at the end of pregnancy, fall in proportion to the hæmorrhage at parturition and for a day or two after, and then be rapidly regenerated. Under normal circumstances it should not be much below 70 per cent., nor the red corpuscles much below 4,000,000. Figures much below these (unless there has been great hæmorrhage, or unless it has been repeated) raise suspicions of sepsis, whilst an observed fall is almost definite proof. This has also much value in prognosis (see p. 223).

**PERIMETRITIS, PARAMETRITIS, ETC.**—Here the usual relations hold good. There is a moderate leucocytosis in a non-suppurative lesion, a high one when suppuration occurs. The figures are usually somewhat lower than in other parts of the body, and 18,000 may be taken as fairly definite evidence of pus, provided other sources of leucocytosis can be excluded.

**OTHER PELVIC SWELLINGS.**—The blood-counts in these cases have to be interpreted with much caution, and are often very equivocal. Thus, *pyosalpinx* is usually associated with the ordinary signs of pus, but the cases are frequently tuberculous, when there is no leucocytosis, or gonorrhœal, when there is only leucocytosis

if the count is made whilst suppuration is in progress. The sterile collections of pus left after an attack of gonorrhœal salpingitis do not cause leucocytosis. A normal count, therefore, does not exclude pus in the tubes. Similarly, there are exceptions to the rule that *simple ovarian tumours* and *cysts* are associated with normal blood. Where there is inflammation and formation of adhesions there is slight leucocytosis, where there is much peritoneal irritation a higher one, and with twisting of the pedicle very high figures may be reached. These latter are liable to be mistaken for acute peritonitis, but the leucocytes do not give the iodine reaction. Further, *malignant ovarian tumours* usually cause a slight leucocytosis and decrease of reds; this has been suggested as of diagnostic importance, but it might be due to so many other conditions that not much reliance can be placed on it. A normal condition of the blood, however, would be some evidence against malignancy. In *tubal gestation* the blood is normal. After rupture there is anæmia and increase of the leucocytes, which may reach 24,000 or more.

PEMPHIGUS, DERMATITIS HERPETIFORMIS, and ERYTHEMA MULTIFORME, are associated with a high percentage of eosinophiles, and this is of importance in the diagnosis of these diseases from local infective processes, which they often closely resemble. The eosinophiles in the former group of diseases may be expected to exceed 10 per cent., and may be much higher, and there may be a high leucocytosis.

## PART III

# CYTO-DIAGNOSIS

CYTO-DIAGNOSIS is the diagnosis of the cause of exudates by the recognition of the cells which they contain. It may be regarded as a branch of hæmatology, though the cells which are encountered are not wholly those of the blood. Its results are less certain than those obtained by the recognition of the organism (if any) present in the exudate, but are often easier to obtain; they are more certain than those obtained by an examination of the blood, as easy to obtain, and in most cases very much easier to interpret. As the methods are very simple and require no special apparatus (though a centrifuge is a very great help), they are within the reach of all practitioners, and a cytological examination should *always* be made when fluid is withdrawn from the chest, abdomen, etc., whether for diagnosis or treatment.

METHOD OF COLLECTING THE CELLS.—No description will be given of the methods of obtaining the exudate, as those which are not in general use have been dealt with already.

If the fluid does not clot spontaneously, it is only necessary to centrifugalize a portion (as much as the tube will hold—about 10 c.c.) for five minutes or so, and then to invert the tube and pour off as much of the supernatant fluid as will come away. The sediment will be left, and a drop or two of fluid will run back down the sides of the tube. These must be thoroughly mixed in with the deposit so as to form a uniform emulsion.

In the absence of a centrifugal machine, allow the fluid to stand for twelve hours or so to settle, adding a crystal of thymol to prevent decomposition. Then remove some of the deposit with a pipette; you cannot invert the tube in this case, as the sediment is not so compact, and will pour out.

When the fluid has coagulated, put it in a strong bottle with some glass beads or balls, or fragments of glass of any sort, and shake for ten minutes. This will break up the coagulum and set most of the cells free. Allow the fluid to stand for a minute or two so that the pieces of fibrin may settle; then decant the supernatant fluid into the centrifugalizing or sedimenting tube, and proceed as before.

Where the fluid is pus no preparation is usually necessary. If it clots it does so very feebly, and in this case a little stirring with a platinum loop will set free plenty of cells for examination, or you may take up the clot with a loop and rub it on the slide or cover-glass.

**METHOD OF PREPARING THE SPECIMEN FOR EXAMINATION.**—The specimens may be examined wet or dry. In most cases the former method is best, as it is quicker, and often yields information which cannot be obtained by a dry specimen. The preparations, however, do not keep, and where permanent ones are required the method is inapplicable.

*Wet Method.*—Place one drop of watery methylene blue or borax methylene blue on a slide and add two or three drops of the emulsion of cells. Stir with the platinum loop or needle, allow the mixture to stand for two or three minutes, and then apply a cover-glass. The cover-glass may be cemented to the slide by means of melted paraffin applied with a hot iron rod; it is best to do this if the oil-immersion lens is to be used, otherwise the suction of the lens may lift up the cover-glass.

Or, put two or three drops of the emulsion on a slide, cover, and examine without staining. Then put a drop or two of acid methylene blue (see p. 30) on the slide just touching the cover-glass; it will pass in by capillarity, and at different distances from the edge you will get an unstained area, an area where the stain is faint, but very selective, and a deeply stained area. The middle zone is best to examine. The red corpuscles, if present, will be dissolved by the acid, and after a few minutes the cells will be stained with great distinctness.

*Dry Method.*—Prepare films on the slide or cover-glass (p. 199), using the emulsion exactly as if it were blood. This may be stained by Jenner's method (p. 204) or fixed and stained subsequently. Any of the fixing and staining methods described for blood may be used, but I prefer to allow the film to dry, fix with saturated solution of perchloride of mercury for a minute

or two, wash, stain in carbol thionin for two minutes, wash, dry and mount. This renders everything very distinct except (sometimes) the nucleoli of the endothelial cells and the granules of the polynuclears. Where the latter have to be inquired into (which rarely happens) the film must be fixed with heat and stained with triacid (p. 204).

#### CELLS MET WITH IN EXUDATES.

Leucocytes derived from the blood are present in the majority of exudates, and in most cases they are of ordinary appearance, and readily recognised from the descriptions already given. The polynuclears, however, may undergo various forms of degeneration, and become so altered that their nature may be difficult to make out. This occurs mainly in old exudates, especially in pus. There are three chief forms :

(a) In some cases the nucleus undergoes fragmentation—*i.e.*, breaks up into several isolated masses, so that the cell becomes truly polynuclear (Plate IX., Fig. 2, where the ingested leucocytes are fragmented). These masses stain deeply, and the cell is easy to recognise, but it often happens that the fragments of the nuclei are set free, and may then be mistaken for small lymphocytes. If a specimen be stained by the triacid stain, they may often be distinguished by a few granules which remain adherent to the nucleus.

(b) *Dropsy* of the nucleus, which converts it into a large circular or reniform mass which stains faintly. In this case the cell resembles a large lymphocyte, large hyaline leucocyte, or myelocyté. It may usually be distinguished from the former by the presence of granulations, and the latter is not known to occur in exudates except in cases of leucocythæmia.

(c) *Fatty degeneration* of the cell, shown by the occurrence of clear refractile granules with sharp contour. These are only seen in wet preparations. In this case the cell usually undergoes severe degenerative changes or even complete solution, and in old pus it may be difficult to make out any definite cells at all (Plate IX., Fig. 3).

As a matter of fact, these degenerative changes rarely cause the slightest difficulty in diagnosis. It frequently happens that no pathologist is able to say definitely what is the nature of any particular cell, but the nature of the cells as a whole is usually obvious at a glance.

Red corpuscles occur frequently, especially in tuberculous and malignant exudates, which may be definitely hæmorrhagic. It is necessary to distinguish corpuscles belonging to the exudate, which are intimately mixed with it, from those derived from the puncture, in which case the blood is most marked at the beginning or end of the flow.

*Endothelial cells* are very important, and it is necessary to be able to recognise them at once. In certain passive exudates (due to cardiac and renal disease) these cells occur as large flat plates, exactly as if the endothelial coat had been scraped off the pleura (Plate X., Fig. 2). They are then seen to be much larger than the largest of leucocytes, and to have a diameter three or four times that of a red corpuscle. Each has a nucleus (sometimes more) which does not usually stain very deeply, protoplasm which stains more faintly still, and one or more nucleoli which stain very deeply in wet preparations, less so in dry ones.

These cells are often grouped into "placards" (Plate X., Fig. 2), the edges of adjoining cells fitting into one another like those of the counties on a map. The groups of cells thus formed are always flat, and careful focussing up and down shows that they consist of a single layer of cells—an important fact, as it distinguishes them from masses of cells of a malignant growth.

Endothelial cells are very phagocytic, and ingest bacteria, red corpuscles (Plate X., Fig. 3), leucocytes (Plate IX., Fig. 2), etc. They often undergo fatty degeneration (Plate X., Fig. 1) or general degeneration, shown by their very faint staining; complete solution of the protoplasm may occur, and the nucleus be set free. It may then be mistaken for a lymphocyte.

Where inflammation takes place in a serous membrane the first thing that happens is that the endothelial cells are set free, so that they are always found with the leucocytes in the early stages of pleurisy or peritonitis. If the inflammation is severe they are destroyed, and the fluid at a later date does not contain them. If the inflammation is less intense they are stimulated to growth, and the young proliferating forms are often very similar to the large lymphocytes and hyaline leucocytes. They vary greatly in size, forming a continuous series between a cell as large as the large lymphocyte to one as large as the plates described above. They are round or oval, not mutually adapted, as in the endothelial cells which have desquamated in passive exudates; sometimes two hemispherical cells may be found in apposition

(Plate X., Fig. 1). The smaller (*i.e.*, younger) the cell, the smaller is the ring of protoplasm in proportion to the size of the nucleus, and the more deeply does it stain. Cells of the type described above will be referred to as "active" endothelial cells, in contradistinction to the "passive" plaques of desquamated endothelium.

*Malignant Cells.*—These cannot be distinguished with certainty from some types of endothelial cells—at least, I must confess myself unable to do so. Cells in mitosis are, of course, very suggestive, but very rare, and there is no reason why they should not occur in ordinary active endothelium. But malignant cells may occur grouped in a characteristic way (p. 239).

#### PLEURITIC EFFUSIONS.

It is in these that cyto-diagnosis is of chief value, and its results most trustworthy. A diagnosis based on the subsequent rules will rarely be found erroneous.

**TUBERCULOUS PLEURISY.**—Two forms are to be recognised: the *primary*, the so-called idiopathic form, in which the prognosis is good as regards immediate recovery, but which indicates a great probability that the patient will subsequently become phthisical; and the *secondary*, which is due to the extension of a tuberculous lesion to the surface of the lung, and is probably due to tubercle plus mild sepsis.

*Primary Tuberculous Pleurisy.*—The fluid is fairly clear, yet yields numerous cells on centrifugalization. It usually clots spontaneously.

The cells are *almost all lymphocytes*, and there are some red blood-corpuscles (Plate IX., Fig. 1). There may also be a few large endothelial cells, flat plates with a well-marked nucleus, and often one or more nucleoli; their characters will be described more fully subsequently. They are cells which have been desquamated from the pleura, and play no part in the pathological process.

In cases examined at an early stage there may be a few polynuclear cells—up to 15 per cent. As the case progresses, these become fewer and fewer, and after the first week only isolated specimens can be seen. The diagnosis may be clinched in some of these cases by the demonstration of the tubercle bacillus.

*Secondary Tuberculous Pleurisy.*—In this case the *lymphocytes* are mixed with *polynuclear leucocytes* in approximately equal proportions; this is a reason for thinking that there is a septic element superadded to the tuberculous one. As the case progresses, the septic

organisms may gain entrance in larger numbers, and the case would become indistinguishable from an ordinary empyema unless a cytological examination had been made early; or, and this is more usual, the polynuclears may gradually disappear, and the case become a simple tuberculous one.

In tuberculous pyopneumothorax the polynuclears greatly predominate, but lymphocytes are usually present in fair numbers. The lesion is due to the bursting of a vomica or abscess that is almost necessarily septic.

"SEPTIC" EXUDATES (*i.e.*, those due to the pneumococcus, streptococcus, gonococcus, and similar pyogenic bacteria).—The characteristic cell is the polynuclear leucocyte. In the early stages the films show these cells in large numbers, and they are mixed with red corpuscles and with endothelial cells of active type (Plate IX., Fig. 2). The pathogenic organism may be distinguished either in films or in cultures. The process may evolve on one of two lines, and in either case the cytology is fairly characteristic.

(a) The process is mild, and *recovery* takes place; this is most likely to occur when the inflammation is due to the gonococcus (in joints especially) or to the pneumococcus in a strong subject. The polynuclears and endothelial cells become more and more scanty, and lymphocytes make their appearance in increasing numbers. The discovery of these cells in a septic exudate is a good sign; the discovery of the pathogenic organism mainly or entirely *within* the cells is another.

(b) The process may pass on to *suppuration*. In this case the endothelial cells become less and less abundant, and the polynuclears become more numerous and undergo the various forms of degeneration described above (Plate IX., Fig. 3).

CRYPTOGENIC PLEURISY, POSSIBLY DUE TO TRUE RHEUMATISM.—In this case the predominating cell is the active endothelial cell in various stages of fatty degeneration, and in addition there is a comparatively small number of all the leucocytes in approximately the same proportions as in the blood, and a few red corpuscles. The exudate is sterile. These appearances are found in the very rare cases of true rheumatic pleurisy, and may be regarded as a good sign, in that they do not indicate a tuberculous or septic origin (Plate X., Fig. 1).

PLEURITIC EXUDATES DUE TO MALIGNANT DISEASE.—The appearances vary, and a definite diagnosis cannot always be



made. There is no criterion (other than certain mitoses, which, as far as I know, have never been made out in an exudate) by which an *isolated* malignant cell can be distinguished from an active endothelial cell. In some cases, however, the masses of cells, which can be seen to be *solid* and *several cells thick*,\* occur in the exudate mixed with red corpuscles and a few leucocytes. These cells are variable in size, usually stain deeply, and often have a well-marked nucleolus. In the figure shown (which comes from the ascitic fluid in a case of carcinoma of the ovary) the resemblance to an alveolus of carcinoma as seen in a section is very distinct (Fig. 53).

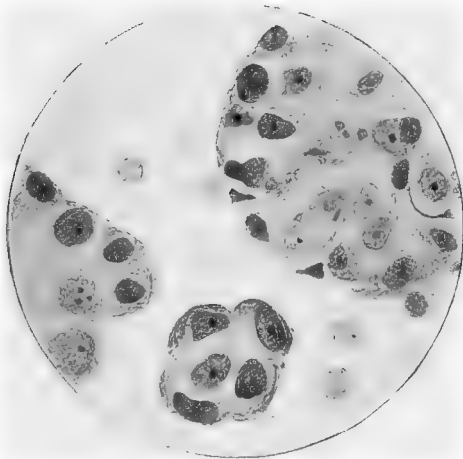

FIG. 53.—MALIGNANT MASSES IN ASCITIC FLUID.

In other cases, and much more frequently, these masses are absent, and their place is taken by large endothelial cells (often many times larger than a red corpuscle), which can be seen in a wet preparation to be in various stages of fatty and other forms of degeneration, and which in dry preparations are found to be extensively vacuolated (Plate X., Fig. 3), and often contain ingested red corpuscles. These may be arranged in masses, are mixed with red corpuscles, and perhaps a leucocyte or two.

Some writers consider these cells to be growth-cells, but on what grounds I do not know. When they form masses they are always one cell thick, never solid alveoli; and, more conclusive,

\* As shown by focussing up and down whilst examining a wet specimen, so as to obtain a series of "optical sections."

when an opportunity is obtained of examining the cells of the growth post-mortem, they are often absolutely different from those found in the exudate during life.

In yet other cases the endothelial cells are of the ordinary passive type, but a suspicion of the nature of the growth may be obtained from the number of red corpuscles present.

“MECHANICAL” EXUDATES (*i.e.*, those due to cardiac disease, pulmonary congestion, or renal disease).—The deposit from the exudate is usually very scanty, and consists of large flat masses of passive endothelial cells, there being often many cells in one large plate; their outlines may be indistinct. There is usually nothing else, but there may be a few red corpuscles or leucocytes.

PLEURISY SECONDARY TO INFARCTS.—Endothelial cells mixed with much blood and with many polynuclear leucocytes have been described, but I have no personal experience of the condition.

#### PERITONEAL EXUDATES.

These are very equivocal, and often difficult or impossible to interpret. The ultimate conditions leading to the production of the cells are doubtless the same in the peritoneum as in the pleura, but here the fluid is in close proximity to the intestine, and liable to constant mild infective processes. These call forth a polynuclear leucocytosis, which is very common in ascitic fluid, and devoid of the significance which it has in the pleura.

TUBERCULOUS PERITONITIS may be accompanied by a pure lymphocytosis, the cells becoming extraordinarily abundant, so that the fluid may be turbid, or there may be polynuclears in a practically pure state. I do not think the condition can be diagnosed unless tubercle bacilli are found.

SEPTIC PERITONITIS.—The cells are all polynuclears, except in the early stages, in which a few endothelial cells and red corpuscles may be found. The diagnosis is to be made by the discovery of the organism, which is usually easy.

MECHANICAL ASCITES (*i.e.*, that due to cirrhosis of the liver, renal disease, cardiac disease, etc.).—Here endothelial cells, often in masses, are almost always present, and sometimes practically unmixed with other cells. But chronic inflammation of the peritoneum, with or without mild sepsis, is frequently present, and polynuclears and lymphocytes frequently occur.

**MALIGNANT DISEASE.**—Here the large vacuolated endothelial cells shown on Plate X., Fig. 3, may occur, and are extremely suggestive, though they cannot be taken as definite proof. Rarely you may find definite malignant masses, which, of course, settles the diagnosis. In other cases there may be numerous polynuclear cells, and in yet others mostly lymphocytes. The presence of an abundance of red cells is suggestive, provided you can be sure it does not come from the puncture, in which case it will be most abundant at the beginning of the flow. It will be apparent that the diagnosis of malignancy cannot be made in the majority of cases by the cytology of the ascitic fluid.

#### THE MENINGES.

Here the technique is somewhat different. Clotting is not so likely to occur, and when it does so is much slower, so that if the fluid can be examined in any reasonable time there is no necessity to break up the clot. This is fortunate, since the number of cells present is of importance, and they cannot be counted in a specimen which has coagulated. My own method is to count the cells directly, without concentration and without dilution, in a Thoma-Zeiss counting-chamber, by the method used for the leucocytes and described on p. 193. If the specimen has had time to sediment, shake it thoroughly; then place a loopful or two on the counting-chamber, cover it, getting Newton's rings, and allow to settle. Then arrange the microscope so that the diameter of the field is equal to that of eight small squares, and proceed to count the leucocytes on forty or eighty fields; in the former case the result multiplied by two gives the number of cells per cubic millimetre, whilst if eighty are counted the number is given direct, no calculation being necessary. (There is no dilution of the fluid, and you have counted the actual number in  $\frac{1}{2}$  or 1 cubic millimetre.) The only difficulty arises if red corpuscles are present; they may be distinguished by being less granular and less refractile than the leucocytes, and are not to be counted.

The following rules may be taken as approximately correct for the numbers of cells met with in various conditions. In *health* there may be none, and never more than single figures per cubic millimetre: the average is perhaps one or two. In "*aseptic*" *meningitis*—*i.e.*, that due to *syphilis*, or that which occurs in *tabes*, *general paralysis*, some forms of *herpes*, and in almost any organic lesion involving the meninges—the number per cubic millimetre

is expressed in two or three figures, and usually ranges between 50 and 200. In *tuberculous meningitis* the numbers are higher, and 1,000 is perhaps the average, but it may go much higher, and in "septic" *meningitis*, including *cerebro-spinal meningitis*, the numbers are very large, often running into tens or even hundreds of thousands.

Having counted the leucocytes, proceed to centrifugalize the fluid, and examine films from the deposit by the wet or dry method. The former shows the cells more clearly, and is to be preferred when a cytological examination only is required, as in the diagnosis of tabes or general paralysis. Where bacteria are to be looked for, dried films should be made and stained by Jenner's method, or fixed with perchloride and stained by thionin. Then proceed with the chemical examination of the fluid already described.

Normal fluid occurs in any nervous disease *not attended by an organic lesion of the meninges*: deep cerebral tumours, hysteria, deep cerebral hæmorrhages, peripheral neuritis, epilepsy, syringomyelia, etc.

In *cerebral tumour* the fluid may be under excessive pressure, so that it squirts out of the needle; in such cases there may be great relief to the headache after the withdrawal of a considerable amount of fluid. With a *cortical* tumour there is usually slight lymphocytosis. According to some writers, the pressure is moderately raised in epilepsy.

*Aseptic meningitis*, using the term to indicate that there are no cultivable organisms present, occurs in *syphilis*, *tabes*, *general paralysis*, *superficial gummata* and *other tumours*, *insular sclerosis*, *chronic alcoholic meningitis*, *hypertrophic pachymeningitis*, *acute softening*, some cases of *herpes*, etc. In these cases we may expect to find a hundred or two leucocytes—practically all of which are lymphocytes—per cubic millimetre. In addition there is usually a slight excess of albumin, and sugar is present, though sometimes reduced in amount.

A slight lymphocytosis, therefore, does not in itself give a clue to the diagnosis unless it rests between two conditions, one of which causes lymphocytosis, whilst the other does not. Thus, if the diagnosis is either insular sclerosis or hysteria, the presence of a moderate leucocytosis tells strongly in favour of the former. Similarly in the differential diagnosis between tabes and peripheral neuritis, and between general paralysis and most of the diseases which it simulates. It is to be noted that excess of lymphocytes

in the cerebro-spinal fluid is a very *early* and a very constant finding in these affections, and often occurs long before the diagnosis can be made by ordinary clinical methods. Its absence is most important as a negative test ; its presence is only equally important if the diagnosis certainly lies between a disease in which this sign is present and one in which it is absent.

**SYPHILIS.**—In syphilis without involvement of the meninges the cerebro-spinal fluid remains normal, but with the slightest involvement of these structures a lymphocytosis occurs.

**TUBERCULOUS MENINGITIS** has been described already. The lymphocytes may be so numerous as to make the fluid very slightly turbid as compared with pure water, and may number 10,000 per cubic millimetre. There is a slight excess of albumin, no sugar, and sometimes albumose is present. Occasionally the films show a few polynuclear cells, but they are never numerous.

**HÆMORRHAGE.**—With a deep cerebral hæmorrhage the fluid is usually clear for two or three days, and then tinged with blood and blood pigment ; the time necessary for this to occur depends on the depth of the hæmorrhage from the surface or from the cerebral ventricles.

When you find blood in the cerebro-spinal fluid, make sure that it does not come from the paretetes. If this is the case, it will be most abundant or limited to the commencement of the flow, and if much is present the fluid will coagulate. If it is due to a lesion it will be intimately mixed with the fluid, and will not coagulate. After blood has been present in the cerebro-spinal fluid for about two days, part of the hæmoglobin is converted into a yellow pigment ; if, therefore, after centrifugalization the supernatant fluid is yellow, it indicates that the blood was actually present in the cerebro-spinal fluid whilst in the body, and that the hæmorrhage had occurred two days or more previously. If the supernatant fluid is colourless, the blood came from the puncture, or had only been recently effused.

If, as sometimes happens, you can only get a few drops of fluid from a lumbar puncture, it is not wise to attach any importance to the presence of a moderate amount of blood. The needle always picks up some corpuscles in its passage through the paretetes, and these may be quite obvious if not diluted with a considerable amount of fluid.

Large endothelial cells containing numerous red corpuscles

(similar cells to those shown on Plate X., Fig. 3) may appear in the fluid after a cerebral hæmorrhage. They do not make their appearance until three or four days after the blood has been poured out.

*Hæmorrhage into the meningeal cavities* or into the *ventricles* is, of course, accompanied by blood in the cerebro-spinal fluid. This may be found in cases of fracture of the skull, especially of the base, or of the spinal column, or in contusion of the brain, and it is worth noting that in some cases there has been great relief of the symptoms after the fluid has been drawn off. Lumbar puncture should always be remembered as a means of diagnosis in patients found unconscious.

“SEPTIC” MENINGITIS—*i.e.*, that due to the meningococcus, pneumococcus, streptococcus, typhoid bacillus, etc.—is characterized by the presence of large numbers of polynuclear cells in the fluid (see p. 133). In all cases the numbers tend to be more numerous than in tuberculous meningitis, and may run into hundreds of thousands per cubic millimetre, in which case the fluid resembles watery pus.

The importance of this fact is very great, and the discovery of polynuclear leucocytoses has led to the discovery that mild cases of this affection occur which are hardly diagnosable clinically, and which may be completely cured. According to several French authorities, the first indication of commencing cure is the appearance of lymphocytes, which must therefore be looked on as a good sign; after a time the polynuclears become less and less numerous, and finally the lymphocytes alone remain, and may persist for some time after cure has taken place. I have watched several septic cases recover, and have seen this occur two or three times. The appearance of lymphocytes in an acute septic meningitis may therefore justify a good prognosis.

## APPENDIX

### I

THE following tables may be useful if stains, etc., have to be prepared when the metric weights and measures are not at hand. The equivalents given are not absolutely accurate, but are sufficiently near for most purposes :

1 Litre	-	$35\frac{1}{4}$ fluid ounces.
100 c.c.		$3\frac{1}{2}$ fluid ounces.
1 Gramme		15.43 grains.
1 Fluid ounce	-	28.4 c.c.
1 Fluid drachm		3.5 c.c.
1 Grain		0.064 gramme.

To convert grammes per litre into grains per ounce, multiply by the factor  $\frac{7}{18}$ . Thus, 10 grammes per litre =  $10 \times \frac{7}{18} = 4.4$  grains per ounce.

To convert cubic centimetres per litre into minims per ounce, multiply by the factor  $\frac{1.2}{2}$ . Thus, 25 c.c. per litre =  $25 \times \frac{1.2}{2} = 12$  minims per ounce. (A close approximation is given by multiplying by  $\frac{1}{2}$ .)

To convert degrees Centigrade into degrees Fahrenheit, multiply by the factor  $\frac{9}{5}$  and add 32.

### II

#### NEISSER'S METHOD OF STAINING THE DIPHTHERIA BACILLUS.

The following method has been placed in the Appendix, as there is some doubt as to its value. It is a method by which the so-called polar bodies are stained with methylene blue, while the rest of the organism is coloured a faint yellowish-brown with Bismarck brown.

Cultures should be made on blood-serum, and should not be less

than nine nor more than twenty-four hours old. Films are spread in the ordinary way and stained for half a minute in—

Methylene blue	1 gramme.
Alcohol (96 per cent.)	20 c.c.
Glacial acetic acid	50 c.c.
Water	950 c.c.

They are then washed and treated for half a minute with—

Bismarck brown	5 grammes.
Water	1000 c.c.

The polar bodies are small spheres which are contained in the bacilli, there being usually two in each bacillus, one at each end. In a film specimen of the true diphtheria bacillus stained in this way they appear as very minute dark blue or black dots, which may easily be mistaken for cocci; the bodies of the bacilli are often almost invisible. According to some authorities, the presence of these granules in young cultures of bacilli which present the morphological characters of the diphtheria bacillus is proof of their virulence, whilst their absence proves the cultures to be of the non-virulent "pseudo-diphtheria" bacillus. The method can also be applied to films made directly from the swabs, and recent researches seem to prove that the results thus obtained are of considerable diagnostic value.

If this method be adopted the films must be very carefully searched, as it often happens that characteristically stained bacilli may be seen in one part of the field, while they are entirely absent elsewhere. This is especially true of films made direct from the swabs.

The author is inclined to attach very considerable importance to a positive result obtained with this method of staining, but would not consider a negative result as indicating the absence of the diphtheria bacillus.

### III

#### LEISHMAN'S METHOD OF STAINING THE SPIROCHÆTE OF SYPHILIS.

I have seen better specimens of the spirochæte obtained by this method than by any other, but my own results have been less satisfactory. Prepare films in the usual manner, allow them to



dry, and fix by means of methyl alcohol for five minutes; then pour off the spirit and allow the films to dry again. Next spread a little fresh blood-serum (obtained from a Wright's pipette in the usual way) in a thin film over the specimen, using the end of a slide as a spreader. When dry, flood the slide (or cover-glass) with Leishman's stain diluted with an equal volume of distilled water. Allow it to act for one hour, wash, blot, and dry.

#### IV

##### DEMONSTRATION OF TUBERCLE BACILLI IN CLOTS FROM PLEURITIC FLUID, ETC.—IMPROVED METHOD.

This method yields better results than the simple digestion of the clot previously referred to. Remove the clot from the fluid and place it on a large filter-paper on a funnel, so that the fluid can drain away. When it has shrunk to a small size remove it and place it in a large volume of water (not necessarily distilled), and keep in gentle movement for a few minutes. Repeat the process two or three times, so as to wash away all hæmoglobin, soluble proteid, etc., from the clot. Place the latter in a clean (preferably new) test-tube, add 4 to 5 c.c. of water, a drop of dilute (1 to 10) HCl, and a pinch of pepsin, shaking until the latter is dissolved. Keep it in the incubator until the clot is completely dissolved, adding a crystal of thymol to prevent excessive bacterial growth. Then shake the fluid, put it in a clean centrifugalizing tube, and centrifugalize thoroughly. Prepare films from the exudate and stain in the usual way, taking great care to avoid over-decolorization; one or two dips in 2½ per cent. sulphuric acid will usually suffice.

The clot from a pint or more of fluid can be treated in this way; the more the material taken, the greater the chance of success.

## INDEX

- ABSCESS, bacteriology of, 102**  
     cold, 105  
     collection of pus from, 102  
     leucocytosis in, 223  
     of liver, 219  
**Achorion Schönleinii, 99**  
**Acid-fast bacilli, 61**  
**Acid, hydrochloric, test for, 116**  
     lactic, test for, 117  
     stains, 203  
**Actinomycosis, 65**  
**Adamson's staining method, 97**  
**Agar, 14**  
**Anæmia, 179, 191**  
     in infancy, 221  
     pernicious, 217  
     secondary, 217  
     splenic, 220  
     Von Jaksch's, 221  
**Anaërobic bacteria, 47**  
**Angina, 106**  
     scarlatinal, 109  
     simple, 106  
     syphilitic, 110  
     Vincent's, 107  
**Aniline gentian violet, 30**  
**Ankylostomiasis, 212**  
**Anthrax, 54**  
**Antitoxin, diphtheria, 37**  
     tetanus, 45  
**Antrum, suppuration of, 111**  
**Aortic lesions, blood in, 231**  
**Appendicitis, 212, 229**  
**Arthritis, bacteriology of, 126**  
     gonorrhœal, 84, 127  
     tuberculous, 127  
**Ascites, cytology of, 240**  
**Asthma, blood in, 230, 212**  
     sputum in, 114  
**Bacilluria, 121**  
**Bacillus, acid-fast, 61**  
     of anthrax, 54  
     in blood, 139  
     of Boas and Oppler, 115  
**Bacillus, "bottle," 100**  
     coli, 69, 105  
         in urine, 119  
     comma, 91  
     of diphtheria, 40, 42  
     Ducrey's, 94  
     fusiformis, 108  
     geniculatus, 115  
     of glanders, 68, 105  
     Hoffmann's, 44  
     of influenza, 52  
     of Koch and Weeks, 112  
     of leprosy, 65  
     mallei, 68, 105  
     of Morax and Axenfeld, 112  
     Pfeiffer's, 52  
     of plague, 93  
     pyocyaneus, 102, 104, 105  
     of smegma, 61  
     of soft sore, 94  
     of tetanus, 47  
     of tubercle, 60. See also Tubercle  
     of typhoid fever, 69, 105  
         in blood, 69  
         in urine, 119  
     vaginæ, 88  
     xerosis, 113  
**Bacteriuria, 121**  
**Basic stains, 203**  
**Basophile cells, 208**  
**Bilharzia disease, blood in, 212**  
**Bismarck brown, 246**  
**Blood, bacteriology of, 138**  
     collection of, for serum, 55  
     crisis, 215  
     cultures, 69, 138  
     -films, fixation of, 202  
         preparation of, 198  
         staining of, 203  
     opsonic index of, 148  
     platelets, 209  
     -serum culture medium, 15  
**Boils, 104**  
**Borax methylene blue, 29**  
**Bottle bacillus, 100**

- Bottles, sterilization of, 7  
 Bouillon. See Broth  
 Bronchitis, 230  
 Broncho-pneumonia, 230  
 Broth, preparation of, 10  
 Bubo in plague, 93  
   in soft sore, 95  
 Bulloch, 154  
  
 Capsules of pneumococci, 51  
   Wright's blood, 33  
 Carbol fuchsin, 29  
   gentian violet, 30  
   thionin, 30  
 Carcinoma ventriculi, blood in, 228  
 Catarrhalis, micrococcus, 53, 54  
 Cathcart's microtome, 163  
 Cells, alveolar, 114  
   bronchial, 114  
   endothelial, 236  
   malignant, 237  
   squamous, 114  
 Cerebral tumour, lumbar puncture  
   in, 242  
   cerebro-spinal fluid in, 242  
 Cerebro-spinal fluid, 132  
   cytology of, 133, 241  
   fever, 134, 135  
 Cleaning blood pipettes, 195  
   cover-glasses and slides, 31  
 Chlorosis, 218  
 Cholera, 91  
 Clumping of bacteria, 71  
 Cirrhosis, blood in, 229  
 Colour-index, 192  
 Comma bacillus, 91  
 Conjunctiva, bacteriology of, 111  
 Cornet's forceps, 23  
 Cornil's myelocytes, 207  
 Corpuscles, red, enumeration of, 181  
   morphology of, 213  
 Cotton-wool, sterilization of, 8  
 Cover-glasses, cleaning, 31  
 Crescents in malaria, 143  
 Cultures from blood, 143  
   from cerebro-spinal fluid, 137  
   from pus, 103  
   from throat, 106  
   examination of, 22  
   incubation of, 18  
   inoculation of, 16  
   media, 9  
   stab and stroke, 13  
   sterilization of, 8  
 Cysticercus, eosinophilia in, 212  
 Cystitis, bacteriology of, 119  
 Cyto-diagnosis, 233  
  
 Degeneration, glycogenic, 210  
   of leucocytes, 235  
   of red corpuscles, 214  
  
 Dermatitis herpetiformis, blood in  
   232  
 Dewar's flask, 21  
 Differential leucocyte count, 209  
 Diphtheria, 37  
 Diplococcus meningitidis intracellu-  
   laris, 136  
 Ducrey's bacillus, 94  
 Durham, 71  
  
 Ehrlich's myelocytes, 208  
   triacid stain, 204  
 Embedding in paraffin, 160, 166  
 Empyema, 124, 230  
 Endocarditis, blood in, 230  
   ulcerative, 50  
 Endothelial cells, 236  
 Enteric fever. See Typhoid fever  
 Enumeration of bacteria in water, 12  
   in vaccines, 156  
   of leucocytes, 193  
   of red corpuscles, 181  
 Eosin, 30, 203  
 Eosinophile leucocytes, 208, 211  
   myelocytes, 208, 213  
 Eosinophilia, 211  
 Epilepsy, cerebro-spinal fluid in, 242  
 Erysipelas, 50  
 Erythema multiforme, 232  
 Ewing, 225  
  
 Fæces, tubercle bacilli in, 63  
 Fauces, bacteriology of, 105  
   cells from, 114  
 Favus, 99  
 Fever, puerperal, 223, 231  
   relapsing, 140  
   scarlet, 226  
 Films, blood, fixation of, 202  
   preparation of, 198  
   staining of, 203  
   of exudates, 234  
   of sputum, 62  
 Fixation of blood-films, 202  
   of tissues, 160, 162  
 Flasks, sterilization of, 7  
 Follicular tonsillitis, 106  
 Folliculitis, 104  
 Foulerton, 88  
 Fragmentation of nucleus, 235  
 Freezing process, 160, 163  
 Fuchsin, carbol, 29  
  
 Gastric contents, examination of, 115  
 Gelatin, 13  
   liquefaction of, 12, 58  
 General paralysis, cerebro-spinal fluid  
   in, 241  
 Gentian violet, aniline, 30  
 German measles, 227  
 Giemsa's stain, 90

- Glanders, 68  
 Glycogen reaction, 210  
 Gonococcus, 84  
   in blood, 140, 145  
   in conjunctiva, 112  
   in joints, 127  
   in meninges, 134  
   in urine, 120  
 Gowers' hæmoglobinometer, 175  
 Gram's iodine, 30  
   method, 24, 172  
 Granular degeneration, 215  
 Grünbaum, 71
- Hæmatoxylin, staining by, 165, 171  
 Hæmocytometer, Thoma's, 182  
 Hæmoglobin, estimation of, 175  
 Hæmoglobinometer, Gowers', 175  
   Haldane's, 176  
   Oliver's, 177  
 Hæmorrhage into meninges, 243  
 Hairs, ringworm in, 95  
 Haldane's hæmoglobinometer, 176  
 Hanging-drop preparation, 73  
 Hanot, 229  
 Herpes, cerebro-spinal fluid in, 241  
 Herxheimer, 90  
 Hewlett, 41  
 Hodgkin's disease, 220  
 Hoffmann's bacillus, 44  
 Hooping-cough, 227  
 Horder, 228  
 Hyaline leucocytes, large, 207  
 Hydatid disease, blood in, 212  
 Hydrochloric acid, test for, 116  
 Hysteria, cerebro-spinal fluid in, 242
- Impetigo, 104  
 Incubation of cultures, 18  
 Incubators, 19  
 Infancy, anæmia in, 221  
 Influenza, 52  
   blood in, 227  
 Inoculation of cultures, 16  
 Iodine reaction, 210  
   Gram's, 30
- Jenner's stain, 204  
 Joints, fluids from, 126  
 Justus's test, 180
- Kerion, 99  
 Koch-Weeks bacillus, 112  
 Kühnau, 147
- Lactic acid, test for, 117  
 Large hyaline leucocytes, 207  
 Lead-poisoning, blood in, 215  
 Leishman's stain, 205  
 Leprosy, 65  
 Leptothrix, 110
- Leucocytes, enumeration of, in blood,  
   193  
   in cerebro-spinal fluid, 241  
   morphology of, 206  
 Leucocythæmia, 219  
 Leucocytosis, 196  
 Leucopenia, 198  
 Liquefaction of gelatin, 12, 58, 104  
 Liver, abscess of, 229  
   cirrhosis of, 229  
   examination of, 158  
   hydatid, blood in, 229  
 Locomotor ataxy. See Tabes  
 Löffler's blue, 29  
 Lumbar puncture, 128  
 Lupus, opsonic index in, 154  
 Lymphocytes, 206, 210  
 Lymphocytosis, 210  
   of cerebro-spinal fluid, 210, 242  
 Lymphosarcoma, 220
- Macrocyes, 213  
 Malaria, blood in, 226  
   parasites of, 142  
 Malignant disease, blood in, 228  
   exudates, cells of, 237, 239  
   pustule, 54  
 Manson's methylene blue, 29  
 Mast cells, 208, 213  
 McCrae, 228  
 Measles, 226  
   German, 227  
 Media, culture, preparation of, 9  
 Megaloblasts, 215  
 Megalocytes, 213  
 Megalosporon ectothrix, 99  
   endothrix, 98  
 Meningitis, 132, 134  
   tuberculous, 133, 137, 227  
 Meningococcus, 136  
 Methylene blue, 29  
   acid, 30  
   Löffler's, 29  
   Manson's, 29  
 Micrococcus catarrhalis, 53, 106  
   epidermidis, 26  
   ureæ, 120  
 Microcyes, 213  
 Microscope, choice of, 1  
   use of, 27  
 Microsporion Audouini, 97  
   furfur, 101  
 Microtomes, 163, 168  
 Milk, tubercle bacilli in, 63  
 Mitral lesions, blood in, 230  
 Mononuclear leucocytes, large, 207  
 Morax-Axenfeld bacillus, 112  
 Morbus cæruleus, blood in, 231  
 Mouth, bacteriology of, 105  
 Mycelium, 67  
 Myelocytes, 207, 211

- Myelocytes, eosinophile, 208, 213  
 Myelogenous leucocythæmia, 219  
  
 Nails, ringworm of, 100  
 Needles, platinum, 16  
 Negative staining, 51  
 Neisser's method, 245  
     stain, 245  
 Nile blue, 90  
 Normoblasts, 215  
 Nose, bacteriology of, 110  
 Nutrient gelatin, 11  
  
 Oïdium albicans, 109  
 Oil-immersion lens, 28  
 Oliver's hæmoglobinometer, 177  
 Opsonic index, 148  
 Osler, 228  
 Osteomyelitis, 105  
 Otitis media, 50  
 Ovarian tumours, blood in, 232  
  
 Paraffin process, 166  
 Parametritis, 231  
 Parasites, animal, 211  
 Pemphigus, 212, 232  
 Perimetritis, 231  
 Peritoneal fluid, cytology of, 240  
 Peritonitis, 50  
     blood in, 213, 229  
     tuberculous, 240  
 Petri dishes, sterilization of, 8  
 Pfeiffer's bacillus. See Influenza  
 Pipettes, 32  
     Wright's, 151  
 Plague, 93  
 Platelets, blood, 209  
 Plating, isolation of bacteria by, 12,  
     57, 103  
 Platinum needles, 16  
 Pleurisy, 50, 123  
     blood in, 229  
     cytology of, 237  
     due to infarcts, 240  
     malignant, 238  
     rheumatic, 238  
     septic, 238  
     tuberculous, 123, 237  
 Pneumococcus, arthritis due to, 126  
     in blood, 139  
     capsules of, 51  
     characters of, 51  
     cultivation of, 126  
     empyema due to, 124  
     lesions due to, 49  
     meningitis, 134  
 Pneumonia, blood in, 225  
     lobar, bacteriology of, 49  
     lobular, bacteriology of, 49  
     opsonic index in, 154  
 Poikilocytes, 214  
  
 Polar bodies, 246  
     staining, 93  
 Polychromatophil degeneration, 214  
 Polynuclear leucocytes, 207, 210  
 Post-mortem examinations, 158  
 Potato culture medium, 15  
 Proteus vulgaris, 119  
 Pseudo-leukæmia, 230  
 Psoriasis, 101  
 Puerperal fever, blood in, 231  
 Pulmonary anthrax, 54  
 Purpura hæmorrhagica, 228  
 Pus, actinomycotic, 66  
     bacteriology of, 102  
     collection of, 102  
     pleuritic, 124  
     pneumococcal, 50  
     tuberculous, 63  
 Pustule, malignant, 54  
 Pyelitis, 119  
 Pyosalpinx, 231  
  
 Ray fungus, 66  
 Red corpuscles, enumeration of, 181  
     morphology of, 213  
 Relapsing fever, 140  
 Rheumatic pleurisy, 238  
 Rheumatism, 227  
 Ringworm, 95  
     staining of, 96, 97  
 Rocking microtome, 168  
  
 Sabouraud, 99  
 Saccharomyces albicans, 109  
 Sarcinæ, 117  
 Scarletinal angina, 109  
 Scarlet fever, blood in, 226  
 Schaudinn, 89  
 Seborrhœa, 101  
 Section cutting, 159  
     staining, 165, 170  
 Sepsis, 210, 222  
 Septicæmia, 50  
 Serous cavities, fluids from, 121  
 Skin diseases, eosinophilia in, 212,  
     232  
 Slides, cleaning, 31  
 Smegma bacillus, 61  
 Soft sore, 94  
 Spirillum of relapsing fever, 140  
     Vincent's, 109  
 Spirochæta pallida, 89  
     refringens, 89  
 Spleen, examination of, 158  
 Splenic anæmia, 220  
 Spleno-medullary leucocythæmia, 219  
 Spores, 11, 48, 55  
 Sputum, collection of, 61, 113  
     cytology of, 114  
     in influenza, 53  
     pneumococci, 51

- Sputum, tuberculous, 60  
 Stab and stroke cultures, 13  
 Staining, negative, 51  
 Stains, 28  
   acid, 203  
   basic, 203  
   Ehrlich's, 204  
   Jenner's, 205  
   Leishman's, 205  
   triacid, 204  
 Staphylococci, 104  
   in blood, 139, 148  
   in joints, 127  
   in meningitis, 134  
   in pleura, 125  
   in urine, 120  
 Sterilization, 5  
   of cultures, 8  
   by dry heat, 6  
   intermittent, 11  
   of skin, 122, 130  
   by steam, 8  
 Stomach, carcinoma of, 115, 228  
   dilatation of, 117  
 Streptococci, 104  
   in blood, 139, 148  
   in joints, 127  
   in meningitis, 134  
   in pleura, 124  
   in urine, 120  
 Streptothricosis, 65  
 Suppuration. See Pus  
 Swabs, 38  
 Syphilis, 89  
   blood in, 228  
   cerebro-spinal fluid in, 241  
   Justus's test, 180  
 Syringomyelia, cerebro-spinal fluid  
   in, 242  
 Tabes, cerebro-spinal fluid in, 241  
 Test-tubes, sterilization of, 7, 8  
 Tetanus, 47  
 Thionin, 30  
 Throat swabs, 38  
 Thrush, 109  
 Tinea versicolor, 101  
 Toison's fluid, 183  
 Tonsillitis, 106  
 Treponema pallidum, 89  
 Triacid stain, 204  
 Trichinosis, 212  
 Trichophyton ectothrix, 99  
   endothrix, 98  
 Tubal gestation, blood in, 232  
 Tubercle, bacillus of, 60  
   in blood, 139  
   in conjunctiva, 113  
   in joints, 127  
   in meninges, 134, 137, 241  
   in pleura, 125  
   in pus, 105  
   in sputum, 60  
 Tuberculin, 64, 157  
 Tuberculosis, blood in, 227  
   opsonic index in, 154  
 Tuberculous meningitis, 134, 137, 242  
   pleurisy, 125, 237  
 Tumours, malignant, blood in, 228  
 Turk, 227  
 Typhoid fever, 69  
   blood in, 213  
   Widal's reaction, 70, 72, 77  
 Ulcer of stomach, 229  
 Ulcerative endocarditis, 50, 104  
 Unna's bacillus, 94  
   bottle bacillus, 100  
 Uræmia, 134  
 Urine, bacteriology of, 118  
   gonococci in, 87  
   tubercle bacilli in, 62  
 Urticaria, 212  
 Vaccines, 104, 155  
 Vaginæ, bacillus, 88  
 Vaginitis, 88  
 Valvular disease, 230  
 Vibrio of cholera, 91  
 Vincent's angina, 107  
 Vomit, examination of, 115  
 Von Jaksch's anæmia, 221  
 Water, examination of, 12  
 Weichselbaum, 136  
 Weights and measures, 245  
 Whitfield, 101  
 Whooping cough. See Hooping  
   cough  
 Widal's reaction, 70, 72, 77  
 Wool-sorter's disease, 54  
 Wright's blood capsules, 33  
   opsonic method, 149  
   pipettes, 151  
 Xerosis bacillus, 113  
 Yeasts, 116









