

Cornell University

Library

OF THE

New York State College of Agriculture

Ag. 8622.

10/17/17

8101

Cornell University Library
SB 107.P42 1910

Agricultural botany, theoretical and pra



3 1924 000 603 971

mann

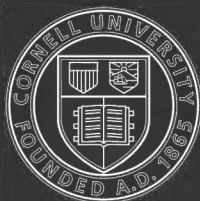

Cornell University
Library

The original of this book is in
the Cornell University Library.

There are no known copyright restrictions in
the United States on the use of the text.

<http://www.archive.org/details/cu31924000603971>

AGRICULTURAL BOTANY

AGRICULTURAL BOTANY

THEORETICAL AND PRACTICAL

BY

JOHN PERCIVAL, M.A., F.L.S.

PROFESSOR OF AGRICULTURAL BOTANY UNIVERSITY COLLEGE, READING

FOURTH EDITION



NEW YORK
HENRY HOLT AND COMPANY

1910
L L,

All Rights Reserved

PREFACE

PRACTICAL men and the agricultural press have from time to time complained of the absence of text-books of botany suited to the wants of the student of agriculture, those in existence being works which treat the subject from a purely scientific standpoint and contain a large amount of matter which, though important to the botanist, is nevertheless of little interest or value to the agriculturist whose time for training in such matters is necessarily limited.

The recent growth of interest in technical instruction, which has resulted in a large increase in the number of colleges and schools for agricultural education, has rendered it imperative that so serious a defect should be remedied, and this I have endeavoured to do by writing the present volume.

The contents are based upon many years' experience in teaching and lecturing to students, practical farmers and gardeners, and embrace all those botanical matters which such experience has led me to consider essential to a sound working knowledge of the general principles of the science and its more immediate application to the crops of the farm.

Although the book has been primarily written for the benefit of students of agriculture, the greater portion of it is equally well adapted to meet the requirements of gardeners and all who desire to obtain an insight into the general structure and life-processes of plants, a knowledge of which must undoubtedly conduce to a more satisfactory and economical management of all cultivated plants.

Until quite recently botanical knowledge has apparently been deemed of little importance in examinations in the science and practice of agriculture, the science of botany being usually treated as an 'optional subject.' It is, however, gratifying to note that in the new regulations for the examination for the National Diploma in the science and practice of Agriculture, issued by the National Agricultural Examination Board, Botany takes its proper place as an obligatory subject beside its sister science Chemistry.

All the drawings in the work are original, and with the exception of the diagrammatic figures have been made by the author from living or natural examples. The panicles or 'ears' of the grasses are all drawn the natural size of average specimens, in order that the figures may be of use in the identification of these important plants.

The farm seeds are also drawn to a uniform scale; their relative sizes may therefore be seen at a glance.

In this as in all scientific study, practical work is absolutely essential to a proper understanding of the subject; in recognition of the importance of such work I have introduced into the text of the volume a series of exercises and experiments, illustrative of the principles and facts to be studied. These and others, which will suggest themselves to intelligent students, should be attacked and carried out in the spirit of research, so that students may learn to observe, record and discover things themselves.

In conclusion, I tender my sincere thanks to my colleague Mr Cousins, and also to Mr W. H. Hammond, Milton Chapel, Canterbury, and Dr A. B. Rendle, of the British Museum (Natural History Department), for valuable criticism and assistance in reading through the proofs.

JOHN PERCIVAL.

SOUTH-EASTERN AGRICULTURAL COLLEGE,
WYE, KENT.

March, 1900.

PREFACE TO THE SECOND EDITION

THE very appreciative reception and rapid sale of the first edition have proved that a real want has been met by the book.

The present edition has been emended and revised throughout in accordance with recent work and the criticisms of botanical friends.

I shall be grateful for any further suggestions which may be deemed necessary to render the work more complete for educational purposes or more useful to the student of this and allied branches of applied botany.

JOHN PERCIVAL.

Nov. 1901.

PREFACE TO THE FOURTH EDITION

To this edition a new chapter has been added and very considerable additions made throughout the work, with a view of improving its usefulness and keeping the matter up to date.

It is gratifying to find that the volume is highly appreciated by teachers and students in all countries wherever English is spoken.

JOHN PERCIVAL.

Jan. 1910.

PART II.

INTERNAL MORPHOLOGY (ANATOMY).

CHAPTER	PAGE
IX. THE PLANT CELL : CELL-DIVISION : TISSUES . . .	104
The cell, 105; Cell-division; Continuity of protoplasm, 110; Tissues, 111.	
X. THE ANATOMY OF THE STEM, ROOT AND LEAF . . .	113
The herbaceous stems of dicotyledons, 113; The perennial woody stems of dicotyledons, 122; Stems of monocotyledons, 136; The root, 140; The green foliage-leaf, 144; The growing-points of stems and roots, 148.	

PART III.

PHYSIOLOGY OF PLANTS.

XI. THE CHEMICAL COMPOSITION OF PLANTS . . .	152
Carbohydrates, 155; Fats and fixed oils, 163; Volatile or essential oils, 164; Organic acids, 164; Proteins or Albuminoids, 165; Amides, 166; Alkaloids, 167.	
XII. THE COMPOSITION OF PLANTS (<i>continued</i>) . . .	168
The elementary constituents of plants, 168; Water-culture, 169; Essential elementary constituents of plants, 171; Non-essential elementary constituents, 175.	
XIII. OSMOSIS ; ABSORPTION OF WATER . . .	177
Osmosis, 177; Absorption of water, 182; Exudation pressure; Root pressure; 'bleeding' of plants, 186.	
XIV. TRANSPIRATION : THE TRANSPIRATION-CURRENT . . .	191
Transpiration, 191; Transpiration-current, 198.	
XV. THE ABSORPTION OF FOOD-MATERIALS . . .	201
Food and food-materials, 201; Food-materials and their absorption, 202.	
XVI. 'CARBON-FIXATION,' 'ASSIMILATION' or 'PHOTOSYNTHESIS'	208

CHAPTER	PAGE
XVII. FORMATION OF PROTEINS. TRANSLOCATION AND STORAGE OF FOODS	217
Formation of proteins, 217; Utilisation, translocation and storage of plant-foods, 219; Nutrition of semi-parasites and semi-saprophytes, 225.	
XVIII. ENZYMES AND THE DIGESTION OF RESERVE-MATERIALS	227
XIX. RESPIRATION	233
Ordinary respiration in the presence of free oxygen of the atmosphere: aerobic respiration, 233; Anaerobic or Intramolecular respiration, 238.	
XX. GROWTH	240
Growth, 240; Conditions which influence growth, 243; spontaneous movements of growth; nutation and tissue-tension, 247; induced movements of growth, 250.	
XXI. REPRODUCTION	258
Vegetative reproduction, 258; Cuttings, 259; Layers, 261; Budding and grafting, 262.	
XXII. REPRODUCTION (<i>continued</i>)	269
Sexual reproduction, 269; Structure and germination of the pollen-grain, 269; The ovule and its structure, 271; Fertilisation and its effects, 273; Pollination; Self-fertilisation and Cross-fertilisation, 279; Transference of pollen, 281; Sexual affinity; hybridisation and hybrids, 285; Mendelian laws of inheritance, 289; Artificial pollination; methods of crossing plants, 299.	
. XXIII. CULTIVATED PLANTS AND THEIR ORIGIN; PLANT BREEDING	303
Bud-varieties or 'sports,' 304; Variation among seedling plants, 305; Variations, how induced, 312; Correlated variability, 316; Reversion, 'throwing back' or atavism; Degeneration of varieties, 317.	

PART IV.

CLASSIFICATION AND SPECIAL BOTANY OF FARM CROPS.

XXIV. THE CLASSIFICATION OF PLANTS	320
Individual and species; variety and race, 321; Genus; plant-names, 321; Divisions of the Vegetable Kingdom, 323.	

CHAPTER	PAGE
XXV. CANNABACEÆ	332
The Japanese Hop, 332; The common Hop, 332; Hemp, 348.	
XXVI. CHENOPODIACEÆ	350
Sea Beet, 351; Common Beet, 351; Mangel Wurzel, 352; Sugar-Beet, 361.	
XXVII. CRUCIFERÆ	365
Wild Cabbage, 366; Cultivated cabbage and its varieties, 367; Turnip, 371; Swede, 376; Rape, cole or coleseed, 379; Black mustard, 381; White mustard, 383; Charlock, 385; Wild Radish, 386.	
XXVIII. LINACEÆ	389
General characters of the Order, 389; Flax or Linseed, 389.	
XXIX. ROSACEÆ	397
Plums and Cherries, 397; Sloe, Bullace, Wild Plum and Apricot, 399; Dwarf Cherry, Gean, Bird Cherry, Almond, Peach, 400; Strawberries, 401; Raspberry and Blackberry, 403; Dog Rose, 404; Pear, 405; Apple, 406; Medlar, Whitethorn and Quince, 407; Lesser Burnet, 408.	
XXX. LEGUMINOSÆ	410
Peas, 412; Bean, 416; Vetch, 418; Vetchling, 420; Red clover, 421; Zig-zag clover, 424; Alsike, 425; White clover, 425; Crimson clover, 426; Yellow suckling, 428; Hop clover, 428; Black medick, 429; Lucerne, 429; Melilot, 432; Sainfoin, 432; Serradella, 434; Kidney Vetch, 434; Bird's-foot trefoil, 435; Gorse, 436; Rest-Harrow, 437; Lupins, 437.	
XXXI. UMBELLIFERÆ	441
Wild carrot, 444; Cultivated carrot, 444; Parsnip, 452; Hemlock, 454; Water Hemlock or Cowbane, 454; Water Dropwort, 455; Fool's Parsley, 455.	
XXXII. SOLANACEÆ	456
Potato, 456; Bitter-Sweet, 468; Black nightshade, 468; Deadly nightshade, 468; Henbane, 469.	
XXXIII. COMPOSITÆ	470
General characters of the Order, 470; Yarrow; Millefoil or Thousand-leaf, 473.	
XXXIV. GRAMINEÆ. TRUE GRASSES	475
XXXV. GRAMINEÆ (<i>continued</i>). CEREALS	483

CHAPTER	PAGE
XXXVI. CULTIVATED AND WILD OATS (<i>Genus Avena</i>) .	493
Wild Oat, 493; Bristle-pointed Oat, 494; Animated or Fly Oat, 494; Short Oat, 494; Common Cultivated Oats, 494.	
XXXVII. CULTIVATED BARLEYS (<i>Genus Hordeum</i>) .	500
Cultivated Barleys, 501; Distinguishing features of Barley-grains, 506; Characters of a good malting barley, 508.	
XXXVIII. CULTIVATED RYE (<i>Genus Secale</i>) . . .	512
XXXIX. CULTIVATED WHEATS (<i>Genus Triticum</i>) . . .	515
XL. COMMON GRASSES OF THE FARM . . .	530
XLI. GRASSES AND CLOVERS FOR TEMPORARY AND PERMANENT PASTURES . . .	556
Grasses and clovers for leys of one, two or three years' duration, 558; Grasses and clovers for temporary pastures lasting from three to six years; Grasses and clovers for permanent pasture, 561; Weight of seed to be used, 569.	

PART V.

WEEDS OF THE FARM.

XLII. WEEDS: GENERAL	571
Their injurious effects, 571; Mistletoe, 575; Duration of weeds, 577; Habit of growth of weeds, 579; How weeds are spread, 580; Extermination of weeds, 582.	
XLIII. WEEDS: SPECIAL	589
Weeds of arable ground, 589; Weeds of pastures, 604.	

PART VI.

FARM SEEDS.

XLIV. FARM SEEDS: GENERAL	614
Purity, 616; Germination Capacity, 620; Speed of germination or germination energy, 626; Weight, 629; Form, colour, brightness and smell, 635.	
XLV. FARM SEEDS: SPECIAL	639

PART VII.

FUNGI, CONSIDERED CHIEFLY IN RELATION TO SOME
COMMON DISEASES OF PLANTS.

CHAPTER	PAGE
XLVI. FUNGI: GENERAL	677
Hypha and mycelium, 677; Reproduction, 679; Germination of spores, 682; Mode of Life; saprophytes and parasites, 683; General advice to be followed when dealing with plant diseases, 686.	
XLVII. FUNGI (<i>continued</i>) PHYCOMYCETES	688
Eumycetes, 688; Phycomycetes (sub-class i. Zygomycetes), 689.	
XLVIII. FUNGI (<i>continued</i>) PHYCOMYCETES	692
Phycomycetes (sub-class ii. Oomycetes), 692; Damping-off, 693; Potato diseases, 698.	
XLIX. FUNGI (<i>continued</i>) BASIDIOMYCETES	715
'Smut' of Oats, 716; 'Smuts' of wheat, barley and rye, 718; Bunt of wheat, 723; Rust and mildew of wheat, 726; Other species of Rusts, 735; The common mushroom, 740.	
L. FUNGI (<i>continued</i>) ASCOMYCETES	745
Yeasts, 746; Mildews, 748; Ergot, 758.	
LI. 'CLUB-ROOT' DISEASE	763

PART VIII.

BACTERIA.

LII. BACTERIA: THEIR MORPHOLOGY AND REPRODUCTION	769
Forms of Bacteria, 769; Vegetative reproduction, 770; Reproduction by means of spores, 771; Conditions affecting development, 774; Sterilisation and pasteurisation, 776.	
LIII. BACTERIA: THEIR WORK	779
Lactic fermentations, 780; Butyric fermentations, 782; Acetic fermentations, 784; Fermentation of cellulose, 785; Fermentation of urea, 786; Putrefaction, 787; Nitrification, 789; Denitrification, 792; Fixation of free nitrogen, 793; Bacteria and diseases of animals, 803; Diseases of plants caused by bacteria, 805; Black rot of cabbages, 806.	

PART I.

GENERAL EXTERNAL MORPHOLOGY.

CHAPTER I.

INTRODUCTORY.

1. THE things met with every day can be separated into two distinct classes or groups, namely, those which are alive, such as birds, insects, cattle, trees, flowers, and grasses, and those which are never possessed of life, such as air, water, glass, and iron.

Although it is impossible to give a complete and satisfactory account of what life is, for all practical purposes the difference between the two classes of objects is easily recognised, and a more extended study of them leads to the conclusion that between the living and the inanimate world there is a hard and fast line of separation.

The chief and most obvious peculiarity of living things is their power of giving rise to new individuals—that is, their power of reproduction. They are ordinarily separated into two classes, namely *animals* and *plants*. The term Biology in its widest sense is used to denote the study of all forms of living things, that branch of it dealing with animals being known as Zoology, while the science of Botany is concerned with the study of plants. The most familiar animals have the power of moving about in a way which is not possessed by plants. Moreover, the former require as food, substances which have been derived from other living things, such as flesh of all kinds, milk, bread, potatoes, and similar materials; while most common plants are capable of utilising substances which belong entirely to the inanimate world,

such as carbon dioxide, water, and various minerals. Although these points of difference between plants and animals are sufficient to separate the two classes from each other, so far as the purposes of everyday life are concerned, it must be mentioned that a further examination of living things shows that there are some which in structure and power of utilising inorganic substances as food-materials resemble plants, but which are nevertheless able to move about as freely as animals, and that other structures usually considered as animals move very little. Then, again, there are living things always classed as plants, which produce flowers and seeds, although they cannot live when supplied with carbon dioxide, water and minerals, but must be fed upon the same or similar substances to those needed by animals. Indeed, all attempts to draw a hard line of separation between plants and animals are found to end in failure. The living substance within them appears to be the same, and between the so-called animal and vegetable kingdoms there is no distinct point of difference. The living world is essentially one, and not two, and it is very necessary to constantly bear in mind that plants are just as much living structures as animals are, since by far the larger number of mistakes in the management and cultivation of plants are due to want of proper appreciation of this fact.

2. For the present our attention will be confined to the common plants of the farm and garden. In form and structure these are altogether different from animals, and as the difficulty of defining the two classes of living things is only met with in studying minute and practically unseen organisms it may be dismissed for the present.

It will be readily understood that plants may be studied from a great many different points of view, and consequently special branches or divisions of the science arise. Attention may be confined to an investigation of the uses of the various parts of a plant's body—to the work which the leaves, roots, and flowers perform in the life of the plant ; this part of the subject is known

as *physiology*. Another branch is concerned with the form, origin, development, and relationship of the various parts to each other, without any reference to the work they do: the term *morphology* is used to denote this division of the science.

Then, again, the structure and arrangement of the various parts of plants may be studied in order to determine their points of similarity and of difference with a view of placing together in groups all those possessing certain degrees of resemblance: this is usually termed *Systematic Botany*. For purposes of convenience and methodical extension of knowledge of the subject many other divisions of the Science are made, and in each of them the study of plants is made from a somewhat different standpoint. Although other classes of the vegetable kingdom need attention it is advisable to confine our study at first to the seed-bearing plants, as this division includes all those which are everywhere most familiar. It is essential that farmers and all who are interested in the management of plants for pleasure or profit should examine and investigate them from as many different aspects as possible, as only by so doing can real progress be made in their cultivation.

3. Most plants of the farm belong to the class known as *Sperma-phytes* or seed-bearing plants; the latter are sometimes called Flowering plants or Phanerogams, but their chief characteristic is the production of seeds. The life-history of a spermaphyte is a continuous process of development or unfolding of parts in which we may recognise four fairly distinct periods, namely:—

- (1) Germination of the seed and the escape of a young plant from it;
- (2) The development and growth of roots, stems, and green leaves;
- (3) The flowering period or formation and opening of flowers; and
- (4) The production and ripening of fruits with their contained seeds.

The succession of events is generally in this order, and usually the formation and unfolding of roots, stems, and leaves occupies by far the greatest portion of the plant's life.

There is, however, great variation in the time taken to reach the several stages of development, and the periods are not always of the same duration in the same species of plant,

4. So far as their total duration of life is concerned, plants may be usefully divided into *annuals*, *biennials*, and *perennials*.

By an *annual* is meant a plant which completes its life-history in one growing season. Starting as a seed in spring or early summer, it develops root, stem, and leaves, and then produces flowers and seeds, after which it dies, leaving behind it offspring in the form of seeds. The time taken by annuals to reach the stage of seed-production is not always the same; usually the whole of the season, from spring to autumn, is necessary, and only one generation is produced in that time. Some of them, however, termed *ephemerals*, such as chickweed and groundsel, produce seeds in a few weeks, and these may germinate and produce a second and third crop of plants before frost cuts them down in autumn and winter.

Biennials, beginning life as seedlings in spring or summer, occupy the first growing season in the production of root, stem, and leaves only. They then rest during winter, and in the following year start growth again, and produce a stem bearing flowers and seeds, after the ripening of which the plant dies. Wild carrot, parsnip, and some varieties of thistles behave in this manner.

Perennials are plants which live more than two years, and often several seasons elapse before flowers and seeds are produced. They are frequently divided into two classes, namely, (1) *herbaceous perennials* and (2) *woody perennials*. In the former the leaves and stems above ground are of a soft nature and die down at the

end of the growing season, the parts of the plant which still remain to carry on growth in subsequent years being underground: the stinging nettle, hop, and potato are representatives of this class. In woody perennials, of which all trees and shrubs are examples, the stems above ground are hard and woody.

This method of dividing plants according to their length of life, although useful, is by no means a strict one, as the duration is dependent to some extent upon season, time of sowing, and the treatment which they receive. Wheat, for example, if sown in early spring behaves as an annual, but if sown in late summer or autumn does not perfect its seed and die until the following year. If kept continually cut or cropped down by animals it may even remain two years or more without dying, especially when thinly sown on good soils and allowed plenty of room for branching. Annual mignonette of gardens is often made to last several years in pots by pinching off the flowering stems as soon as they begin to form.

Turnips and other plants, usually biennials in ordinary farm practice, are invariably annuals if sown early in the year, say in February.

Climate and soil also influence the duration of plants, annuals in some districts becoming biennial or even perennial in others.

Ex. 1.—Sow short rows of the cereals and ‘roots’—mangels, turnips, swedes and carrots—on the first day of each month during a whole year, and make careful observations and notes on their subsequent growth up to the time of seed production. Interesting and useful results are obtained.

5. As the duration of flowering plants is subject to such variation and their classification into annuals, biennials, and perennials, consequently somewhat arbitrary, they are sometimes placed in groups according to the number of times they are able to produce seeds.

Those which yield only one crop and then die are termed

monocarpic plants : annuals and biennials are of this nature, and some perennials also.

Such plants as most trees and shrubs, thistles, bind-weed, coltsfoot, and many grasses which are able to produce flowers and seeds during an indefinite number of seasons are described as *polycarpic*.

CHAPTER II.

SEEDS : THEIR STRUCTURE AND GERMINATION.

1. IT is well known that one of the most ordinary methods of raising plants is to sow what are called seeds, yet how few there are among the many who use them who fully appreciate their real nature and capabilities. This want of knowledge is not due perhaps so much to want of interest in them, as to the fact that for their proper management they are usually buried away in the ground, and are therefore unseen ; moreover, many of them are so small that their structure is difficult to observe with the naked eye.

In order to understand the true nature of a seed it is necessary to examine its origin and construction, and watch its development as far as possible from the earliest stages to the time when it gives rise to a completely formed young plant.

The Common Bean.—A broad bean is one of the largest seeds met with in ordinary farm or garden practice, and as its parts are all sufficiently large to be observed without the special aid of anything more than an ordinary pocket lens, it is especially fitted for study.

When a nearly ripe pod of a broad bean plant is opened, each seed within it is found attached to the inside by means of a short stalk or *funicle*

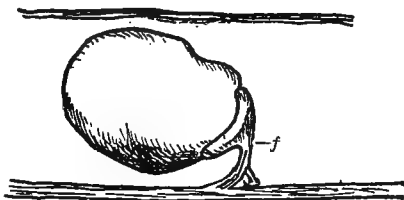

FIG. 1.—Piece of bean pod showing the funicle (f) and its attached seed

(Fig. 1), and it is through this stalk that all the nourishment

8 SEEDS : STRUCTURE AND GERMINATION

passes from the parent to enable the young seed to develop. At first the pod exists in a rudimentary form in the centre of a flower, and its parts and contents are very small; they are nevertheless readily seen with a pocket lens. After the fading of the flower, the pod and seeds within it grow larger and larger at the expense of food supplied by the rest of the plant, and ultimately when ripe the funicles wither and dry up, and the seeds become detached from the parent which has produced them.

When dry and ripe each bean seed is hard, with an uneven surface, but its internal construction cannot be clearly examined in this condition. On soaking in water for twelve hours, however, it becomes softer, and the parts can then be easily investigated.

The outside, which is a pale buff colour, is smooth, and has at one end a narrow elongated black scar called the *hilum* of the seed. It is known popularly as the 'eye' of the bean, and marks the place where the broad end of the funicle separated from the seed when it ripened in the pod.

Quite close to one end of the hilum is a very minute hole known as the *micropyle*, easily seen with a lens, and through which water oozes out usually accompanied by bubbles of air

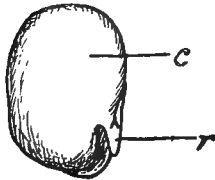

FIG. 2.—Bean embryo, showing (r) radicle and (c) cotyledon.

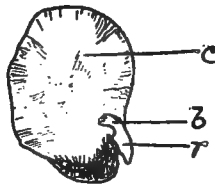

FIG. 3.—The same as Fig. 2, after removal of one cotyledon; r radicle; b the plumule; c cotyledon of embryo.

when soaked beans are squeezed between the finger and thumb. This opening communicates with the interior of the seed, and is the only one it possesses.

On slitting round the edge with a knife,

the outer part of the bean can be stripped off as a pale, semi-transparent, leathery membrane; this is known as the *testa* or seed-coat, and is thickest

and of softest texture where the hilum is situated. The rest of the seed after the testa is removed, is of oval flattened shape similar to the complete bean, and is divisible into two large fleshy halves called *cotyledons* (Fig. 3, *c*), which, however, are not completely separate from each other, but connected at the side with a conical projecting body (Fig. 3, *r*), one end of which is found to fit into a hollow cavity in the seed-coat exactly opposite the micropyle; the other end is bent and turned inwards between the fleshy cotyledons. The extent and shape of this small curved structure is most easily observed when one of the cotyledons is removed completely; it remains attached to the other as in Fig. 3.

Ex. 2.—Soak some broad beans in water and keep them in a warm place all night. Examine them next day and make drawings of the various parts seen both before and after stripping off the testa. Observe the relative position of the parts of the embryo in reference to each other and to the seed-coat.

Examine and compare the structure of the following seeds after soaking in the same way:—Pea, scarlet runner beans, vetches, and red clover.

The bean seed contains nothing more than what has already been described; the nature and relationship of its component parts only become intelligible when the seed is placed in the ground or maintained under certain conditions, and allowed to grow. When growth commences the lower end of the small curved structure (Fig. 3, *r*) elongates and breaks its way through the coat of the seed at a point very close to the micropyle, but not, as often erroneously stated, through the micropyle itself. It soon assumes the form seen in Fig. 4, and is recognised as a root of a young bean plant. The upper bent half, which lies between the cotyledons, also pushes its way out of the same opening in the seed-coat and develops into a stem, from the tip of which leaves are gradually unfolded. It is thus seen that the seed of a broad bean is a packet containing a bean plant in a rudimentary condition.

This plantlet is called an *embryo*, and the portion of it which

becomes root and stem is its *primary axis*. The part of the primary axis which is below the point where the cotyledons are attached is known as the *radicle*, and consists of a very small piece of stem, the *hypocotyl*, at the end of which is a *root*. Where

the stem ends and the root begins cannot be determined in the bean seedling without the aid of the microscope and examination of the internal structure of the axis of the plant.

The curved end of the primary axis above the cotyledons is the *plumule* of the embryo, and consists of a very short piece of stem, the *epicotyl*, on the top of which is a bud. From the latter is derived the ordinary stem which comes above ground with its green leaves and flowers.

In the early stages of the growth of the embryo from the seed the hypocotyl grows very little, the part of the stem which grows most being the epicotyl. It is on account of the elongation of this

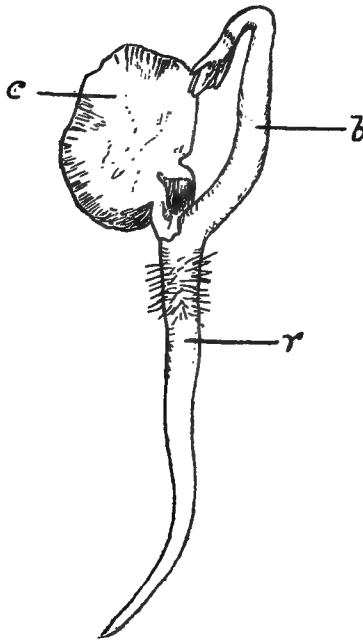

FIG. 4.—Bean embryo after four days' growth. One cotyledon has been removed. *c* Cotyledon; *r* primary root; *b* epicotyl with bud at its tip. Compare with Fig. 3.

portion of the plantlet that the plumule with its young leaves are driven above ground, the cotyledons remaining below enclosed within the seed-coat.

The upper part of the stem bearing the plumule comes out of the seed bent, as in Fig. 4, and it maintains this curved shape for

some time after emerging. By this behaviour the delicate leaves of the plumule are protected from injury during their progress upwards when a seed is sown in earth or sand.

Ex. 3.—Fold up some soaked beans in two thicknesses of white flannel made damp, and place them on a plate. Cover them with another plate placed upside down, and leave them in a warm room. Examine them twice a day, leaving them exposed to the fresh air for a few minutes each time, and keeping the flannel damp, not wet. When they sprout notice the place where the radicle has come out of the seed-coat. Let some grow till the radicle and plumule are well out of the seed, and compare the various parts of the sprouted seeds with unsprouted ones.

2. **GERMINATION.**—When the pod of the bean is developing, the embryo in the seed is being fed by the parent and visibly grows until ripeness is attained. The young plant then assumes a dormant or resting state within the seed without showing any signs of life. Under certain conditions, however, the plantlet begins to wake up, and soon escapes from its protective coat to lead a separate and independent life. This awakening from a resting condition to a state of active growth is called *germination*, and is dependent upon an adequate supply of (1) water, (2) heat, and (3) air or oxygen. It is also essential, of course, that the plantlet in the seed must be alive.

The exact nature of the dormant state of seeds is not understood, but in old seeds and those which are gathered in an immature condition or badly stored the embryo is often weakened or actually dead; in the latter case no germination is possible. The exact length of time which seeds may be kept before death of the embryo takes place has never been satisfactorily determined; it varies with the species of the seed, its ripeness and composition, and also with the method of storage. In the case of most farm and garden seeds kept in the ordinary way, few of them are found capable of growth after ten years, and a large number die in two or three years, but on this point more will be said in a later chapter. For present purposes it will suffice merely to mention that age is a deter-

mining factor in the germination of seeds, apart from the three conditions previously mentioned.

3. That water is necessary is well known, as beans may be kept indefinitely in a sack or drawer at various temperatures and with access to air without germination taking place. When placed in moist ground, or between damp blotting-paper, they absorb water very readily. This is most easily observed when beans are soaked for twelve hours in a dish containing water. The water is transmitted through all parts of the coat, but much more quickly and easily through the micropyle and the line of softer material which runs the whole length of the centre of the hilum. It is rapidly brought into contact with the part of the embryo which grows first, namely, the radicle. The soft spongy thicker part of the inside of the testa lying beneath the hilum stores up a considerable amount of water for the benefit of the developing plant, and the whole of the embryo and the seed-coat absorb water and become softer and larger in consequence; it is only after this swelling has happened that a bean begins to show any signs of germination.

Ex. 4.—To show the influence of the micropyle and hilum in the absorption of water, take twenty beans all as near the same size as possible. Paint over the micropyle and hilum of ten of them with quick-drying varnish or 'cycle black'; on the other ten paint streaks of the same size on the *sides* of the seeds, leaving the micropyle and hilum untouched. Weigh both lots separately, and place them together in a basin of water all night. Take them out next morning, dry them carefully with a towel, and weigh again, and see which lot has increased most.

4. The need of an adequate temperature for germination is a matter of common knowledge among those accustomed to sow seeds. If soaked beans are placed in the ground in midwinter they show little or no signs of waking from their dormant condition, yet when placed under a glass on damp blotting-paper indoors, the radicle makes its exit from the seed in a few days. Seeds differ in the temperature which is necessary to induce them to germinate, the embryos in some commence to extend

their radicles and push their way through the seed-coat even if just kept above freezing point ; others require a temperature of 9° or 10° C. to start growth. If attempts are made to grow beans at 45° C. it will be found to be too hot, and they make little or no progress. Between this high temperature at which growth appears impossible, and the freezing point where the development of the embryo of the bean is also suspended, there is a temperature at which the embryo makes the most rapid progress, and emerges from the seed-coat in the shortest possible time ; this most favourable temperature is about 28° C., both above it and below it the germination of the bean is retarded.

Ex. 5.—Arrange two separate lots of similar-sized beans soaked for the same length of time in damp flannel as described in Ex. 3, and place one in a warm kitchen and the other in a cold cellar. Observe which show their radicles first.

5. The supply of fresh air is also an essential condition for growth of the young plant from the bean seed, but the evidence for its need is not so manifest or so generally recognised as the necessity for moisture and warmth. It will be found, however, when beans are placed in a flask or bottle containing carbon dioxide or hydrogen gas they refuse to germinate, even when they are supplied with a proper amount of water, and kept at summer heat.

Ex. 6.—Place ten soaked beans in a wide-necked bottle. Fill the bottle with carbon dioxide gas or coal gas, and cork it up with a tightly-fitting indiarubber stopper.

Arrange another bottle in the same way, but with ordinary air in it instead. Take out the stopper of this one twice daily and blow in fresh air, so as to ensure a good supply to the seeds. Place both in a warm situation and observe which germinate best.

6. The peculiar extension or growth of the parts of the interior of the bean seed, and the fact that a suitable supply of water, air and heat is necessary for the manifestation of these changes, suggests to us that we are dealing with a living structure. This becomes all the more apparent when we observe that the oxygen

14 SEEDS: STRUCTURE AND GERMINATION

of the air is absorbed, and in its place carbon dioxide is given off into the surrounding air, for this is what happens in the breathing of a living animal.

Ex. 7.—Carbon dioxide is produced when beans germinate. Place twenty soaked beans in a wide-mouthed bottle, and cork them up after showing that a match burns freely in the bottle. Leave them in a warm place for twenty-four hours, and try if a match will now burn in the bottle.

The carbon dioxide gas can be poured out into a beaker containing lime water; on shaking, its presence is proved by the lime water becoming 'milky' owing to the precipitation of carbonate of lime.

The particular use of the water, heat and air to the plant we cannot at present discuss. It may, however, be mentioned that without water the embryo would have little chance of becoming free from the tough and hard seed-coat surrounding it; water softens the latter, and makes it more easily torn by the extending radicle and plumule.

In the early stages of the life of the bean plant, from the commencement of germination up to the time when the first green leaves are unfolded, the development and building up of the elongating rootlet and shoot depend upon the thick cotyledons. At first the latter are thick and fleshy, but as the radicle and plumule grow the cotyledons become softer and thinner, ultimately shrivelling considerably. The cotyledons are leaves, the interior of which is packed with food for the rest of the growing embryo, and a large amount of the water absorbed by the seed is used for the purpose of dissolving the nutrient material in them, and carrying it from them to the various parts of the root and shoot of the young plant where growth is going on.

Ex. 8.—Germinate beans in damp flannel as in Ex. 3, and show that the cotyledons are essential to the development of the root and shoot of the embryo by cutting them off as soon as the two latter parts have emerged from the seed-coat. Try separating one cotyledon and then two at various stages of development, and see if the axis (root and shoot) can be made to develop without them. The growth should be allowed to continue some time in order to obtain well-marked effects.

7. Not only do the changes observed in the embryo of a ger-

minating bean point to the conclusion that it is a living structure and like an animal dependent on a proper supply of water, heat and air for the manifestation of its life, but the parts of a young bean plant after emerging from the seed soon give evidence of the possession of peculiarities which are associated with life. When put in the ground, the radicle, in coming out of the seed, turns straight downwards and continues to grow in this direction. This is the case no matter in what position the seed is placed. If, after germination has commenced, it is taken and replanted with the primary root pointing to the surface of the soil, the tip of the root soon begins to curve downwards again, and will maintain this course until again disturbed.

The plumule behaves in exactly the opposite manner ; after emerging from the seed-coat its bent tip grows upwards and away from the root ; if the seed is reversed and replanted the plumule begins to curve in such a manner that its tip is driven upwards towards the surface of the ground. That these peculiarities are somehow connected with life is clear, as dead embryos show no such behaviour.

Ex. 9.—Sow soaked beans in a flower pot or box filled with ordinary garden soil placing them in various positions in it, some laid on the flat side, some with the hilum directed upwards, and others with the hilum downwards. Allow them to grow in a warm place : take them up as soon as signs of germination are noticed, and observe the direction the root and shoot have taken.

The peculiar tendency for the root always to go downwards and stem upwards can be investigated by sowing beans in ordinary garden soil and afterwards reversing them. To avoid error all should be taken up, and then placed again in the soil in various positions—some as they were, a few with their roots and stems reversed, and others laid in a horizontal position. They may be re-examined at the end of a week.

Another method of showing the same peculiarity may be carried out thus:—Germinate soaked beans in damp flannel as in Ex. 3. When the roots have extended about half an inch take two seeds and suspend them by means of thread side by side in a bottle with their roots downwards and stem upwards. The bottle should contain a little water to keep the air damp. When the roots have grown about two inches reverse one of the seeds so that its root points upwards and stem downwards. Notice that the tip of the

16 SEEDS: STRUCTURE AND GERMINATION

root of the reversed seed in about twelve hours begins to turn downwards, while the plumule more slowly bends in such a way as to assume the position it had before it was reversed. The bottle should be placed in a dark box or cupboard to avoid the influence of light on the plant, and fresh air should be blown into the bottle twice a day.

8. Although seeds vary almost indefinitely in regard to size and shape they are similar to the bean in so far as they all contain a young plant packed away within the seed-coats. In this essential feature all seeds agree with few exceptions, and it is on account of the existence of a young plant within them that they are of use in the raising of crops or plants.

The manner, however, in which the embryo is arranged, and the relative size and appearance of its various parts, differ considerably in seeds; moreover, the growth during and after germination is not the same in all cases. A few of the more important and common variations in these respects must be noticed.

White Mustard.—The seed of white mustard (*Sinapis alba* L.) contains an embryo which like that of the bean consists of a radicle, plumule and two cotyledons; the latter, which are folded together, are relatively thinner than those of the bean and deeply notched as in Fig. 5. The radicle is bent round and lies in the fold of the cotyledons, between which is the very small, almost invisible plumule.

On germination the cotyledons, instead of remaining within the seed-coat and below the ground as in the case of the broad bean, escape from the enclosing coats altogether and grow up out of the ground, enlarging at the same time, and becoming green like ordinary leaves. They are the first 'smooth' leaves of the seedling mustard plant.

After a short time the plumule grows up from between the cotyledons and forms a stem upon which are gradually unfolded the ordinary divided 'rough' leaves.

Ex. 10.—Soak white mustard seeds, and examine their structure, noting especially the way in which the embryos are packed in them. Allow some to

germinate and grow for a week or more on damp flannel, and examine them in various stages of development, noting the notched cotyledons with small

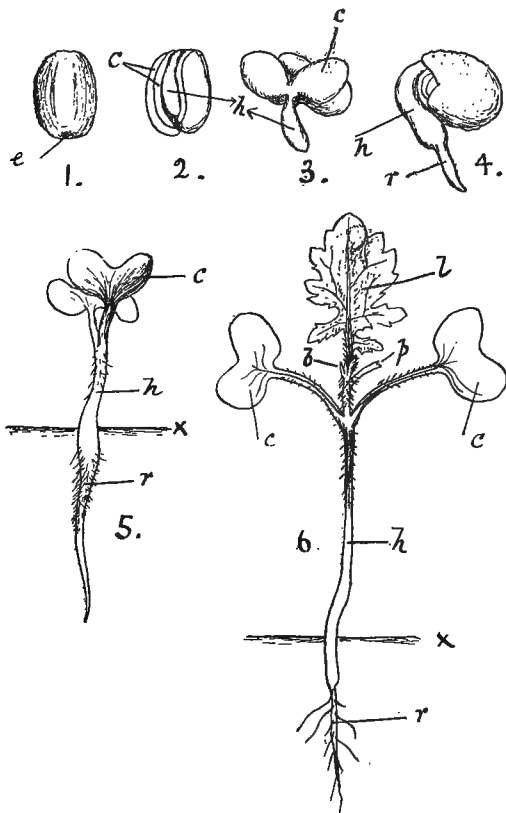

FIG. 5—1. Seed of White Mustard. 2. Folded embryo as seen after removal of seed-coat. 3. The same unfolded. 4. Seed germinating. 5. Young seedling. 6. Same as 5, but a week older.

c Cotyledons or 'smooth leaves'; *h* hypocotyl; *r* radicle and primary root; *l* first foliage leaf ('rough leaf'); *p* petiole of another leaf similar to *l* with blade removed; *b* terminal bud; *x* surface of the soil.

plumule, well-marked hypocotyl, and distinct separation between the latter and the root.

18 SEEDS : STRUCTURE AND GERMINATION

9. The term *hypogean* is applied to cotyledons which remain below ground, those coming above being *epigean*, the relative amount of growth in the hypocotyl and epicotyl determining their position. If the hypocotyl grows vigorously during or after germination the cotyledons are forced above ground ; when only the epicotyl grows the plumule is lifted up above the soil, but the cotyledons remain below where the seed is placed.

In the broad bean the hypocotyl is very short, and the point where it ends and the root begins is not clearly defined. In a mustard seedling, however, the point of separation between the root and stem is somewhat swollen and readily distinguished (Fig. 5).

10. All plants whose embryos, like those of the bean and mustard, possess two cotyledons, are known as *Dicotyledons* ; they form a very large, well-marked class of the flowering or seed-bearing plants.

11. The seeds hitherto mentioned contain within their coats nothing but an embryo plant, which depends for the development of its root and shoot upon the substances stored up in some part of its body, its cotyledons chiefly. This is true even in the case of seeds like those of white mustard, in which the cotyledons of the embryo are comparatively thin. There are, however, a number of plants, such as the ash, mangel and potato, which, although belonging to the *Dicotyledons*, have seeds in which there are stores of food inside the seed-coat, but free from the embryo and its cotyledons (Fig. 109). Such *separate* reserve-food, whatever its chemical composition may be, is known as *endosperm* or 'albumen,' and seeds in which it is present are called *endospermous* or *albuminous* seeds. Those like the bean, pea, and vetch, mustard, and turnip, which have no *separate* reserve-food, are known as *exendospermous* or *exalbuminous* seeds.

Ex. 11.—Take out a seed from the fruit of the ash tree in autumn ; carefully cut thin shavings from the flat side of the seed, starting about the middle of

the seed and cutting towards the narrow end. Note the white embryo with its well-marked radicle, hypocotyl and two flat cotyledons lying within the semi-transparent endosperm.

12. Some of the most commonly occurring endospermous seeds will be found to have embryos within them which are not dicotyledonous, and whose structure is in many respects very different from those we have hitherto mentioned. A good example is met with in the onion.

Onion.—The seed is black, somewhat oval in outline, with one side convex, the other almost flat. Each contains within it endosperm and an embryo which lies curled up inside in the form seen in 1, Fig. 6. When germination commences, the curved part (*c*) imbedded in the middle of the endosperm grows and forces the end (*a*) of the embryo out of the seed. From this exposed end, which is the radicle, a straight, slender, primary root develops, the extent of which is seen at 3 and 5, Fig. 6.

The part of the young seedling which extends from the root into the interior of the seed, grows very rapidly at first, at the same time assuming a sharply bent outline (2, Fig. 6). It comes above ground in the form of a close loop (*c*), but on further growth the end within the seed is pulled out of the soil, and grows up in the air. The tip within the seed changes and absorbs the endosperm, and usually remains there until all the nutrient material has been transferred from it to the various centres of growth in the young plant. After the food-reserve is exhausted the tip withers and becomes free from the seed-coat. In loose soils the latter is pulled above ground before the endosperm is exhausted, and remains on the end of the tip for some time. In other cases where the soil is damper and of a stiffer nature the seed-coat remains below ground altogether.

The curved part of the embryo which comes above ground is a leaf. It is the cotyledon of the embryo, and is in reality a thin hollow leaf like those of the full grown onion plant: within it is the plumule, which consists of a series of hollow conical

20 SEEDS : STRUCTURE AND GERMINATION

leaves arranged one inside the other. Just at the point where the root joins the cotyledon there is a thickening which marks

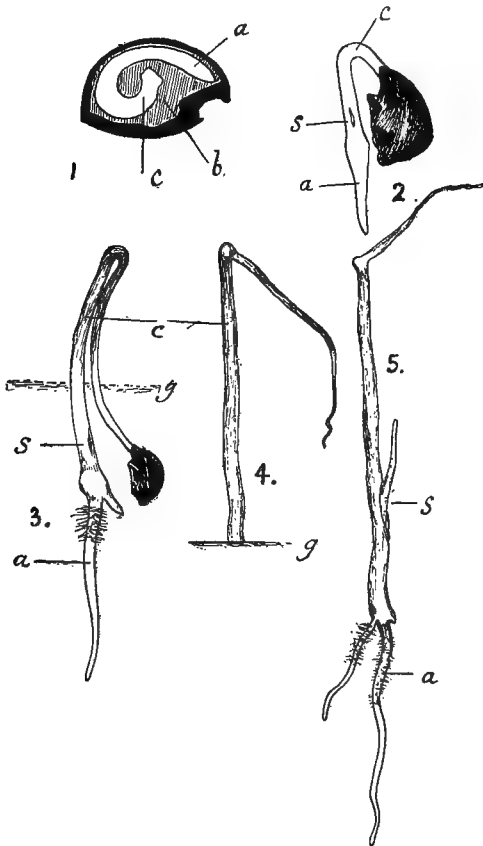

FIG 6—1. Section of an Onion seed. 2. Germination of same. 3. Young seedling. 4 and 5. Same as 3, but some days older. In 3 and 5 a secondary root is seen. *a* Radicle and primary root; *c* cotyledon; *s* slit in cotyledon from which the first foliage-leaf of the seedling emerges; *b* endo-perm of seed.

the place where the plumule is situated within, and at a short

distance above this is a very narrow slit (*s*), through which the first green leaf of the plumule makes its exit (*s*, 5, Fig. 6). After one leaf emerges others soon follow, the younger ones coming out in regular order through slits in the sides of those immediately older than themselves.

Ex. 12.—Soak fresh onion seeds in water for a few hours. With a razor cut through some parallel to their flat sides in order to show the embryo within, as at 1, Fig. 6.

Sow others in damp blotting-paper; allow them to germinate and the seedlings to develop; make observations of them at different stages of growth.

Watch the germination of seeds sown in boxes or pots containing ordinary garden soil.

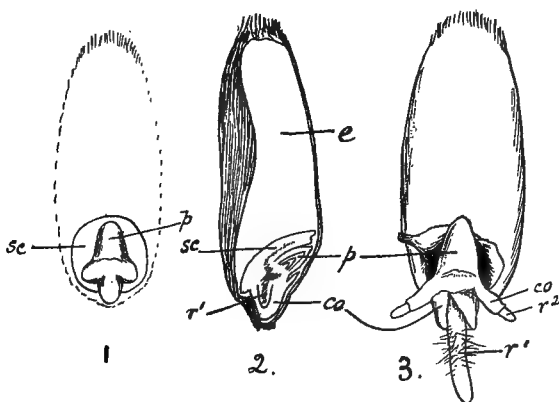

FIG. 7.—1. Outline of wheat grain showing the position and form of the embryo. 2. Longitudinal section through a wheat grain. 3. Wheat grain germinating.

Sc Scutellum; *p* plumule; *r*¹ primary root; *r*² secondary root; *co* coleorhiza.

13. Plants whose embryos possess only one cotyledon are known as *Monocotyledons*, and form the second large class of seed-bearing plants.

Few of the representatives of this class with which we are ordinarily familiar have true seeds large enough for examination. The onion is probably one of the best commonly occurring

examples which may be considered typical of the monocotyledons and easily obtainable.

To this class, however, belong all the grasses, but their seeds and embryos are so different in many respects from those of the onion that it is necessary to examine one of them in detail.

Wheat.—A wheat grain, which may be taken as an example, is not a seed, but a kind of nut with a single seed within it. The seed grows in such a way as to completely fill up the interior of the nut, and become practically united with its inside wall. The embryo occupies only a small part of the grain, the rest being taken up by the floury endosperm of the seed (2, Fig. 7).

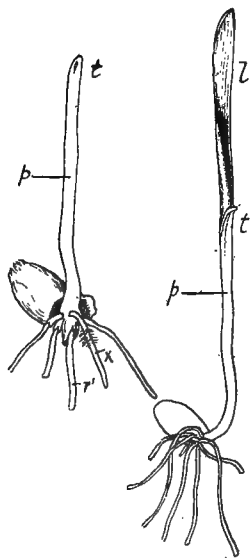

FIG. 8.—1. Seedling wheat plant.
2. The same a few days older.
p First sheathing leaf of plumule;
t slit at tip of p from which
the first green leaf l emerges.

The embryo is easily seen at the base of a soaked grain on the side opposite the furrow. When removed it has the appearance seen at 1, Fig. 7. The part of it which lies close up to the endosperm is a flattened somewhat fleshy shield-shaped structure called the *scutellum* (*sc*); attached to the front of the scutellum is the plumule (*p*), consisting of a bud formed of an extremely short stem, upon which are sheath-like leaves enclosing each other. The embryo generally possesses three roots, the middle one seen at *r*¹, Fig. 7 being the primary root. They are all completely enclosed by a sheath which is continuous with the scutellum, and are consequently not visible from

outside; their position, however, is marked by three projecting bosses. The sheath round the roots is termed the *coleorhiza* (*co*),

and when germination takes place it expands and bursts the coats of the grain, the roots about the same time breaking through the enclosing coleorhiza. When a wheat grain is sown in the ground it remains there, but the plumule grows upwards, and appears above the soil as a single pale tube-like leaf; from a slit in the tip of the latter the first flat green blade soon appears (*l*, Fig. 8), and is followed by a succession of single green leaves, the younger ones growing from within the older ones in regular order.

Ex. 13.—Soak some white wheat grains in water until well swollen out, and note the following points:—The furrow along the back of the grain, the bearded tip, and the side opposite the furrow. Keep them damp a day. The embryo, which is easily seen through the semi-transparent coat, can be removed by slitting round the circular cotyledon with a needle. Examine its structure, and compare with Fig. 6.

With a sharp knife or razor cut through from back to front, so as to divide the grain into two longitudinal halves, and note the floury endosperm and the shape and parts of the divided embryo.

Place a folded sheet of damp blotting paper on a plate, sow some soaked wheat grains on it, and cover with a tumbler. The grains will germinate. Watch their development up to the time the first green leaf appears, taking out the embryo and examining it at different stages of its growth.

There is difference of opinion as to which part of the embryo is to be considered the cotyledon. Some authorities regard the scutellum as the cotyledon, while others give this name to the first sheathing leaf which comes above ground, and which has no green blade (*p*, Fig. 8). Others, again, consider that the first sheathing leaf is an extension of the scutellum, and the two combined is therefore the cotyledon. In any case, there is only *one* cotyledon present, and wheat therefore belongs to the class of monocotyledonous plants.

14. During the growth of the embryo of a wheat grain, it will be noticed that the endosperm becomes soft and decreases in quantity as the roots and plumule expand and develop; the endosperm is the food upon which the young plant depends during the early stages of its life, the scutellum acting as a

24 SEEDS : STRUCTURE AND GERMINATION

structure for changing, absorbing, and transferring this reserve-food to the growing parts which need it.

Ex. 14.—Note the softening of the endosperm in germinated wheat grains and its decreased amount after seedlings have grown considerably.

Remove the embryos from well-soaked grains, and grow them without the endosperm on damp blotting-paper. Allow ordinary uninjured grains to grow with them. Both the embryos in the grains and those removed from the grains develop, but there is a great difference in the results after a few days.

15. The store of reserve-food on which the young plant depends for its early development is sufficient to enable it to form a root, stem, and several leaves, as is evident when seeds are allowed to germinate upon damp flannel or blotting-paper, from which nothing but water is absorbed.

No food-materials or manures are needed for this primary development, and seeds germinate and the seedlings grow for a considerable time as well in poor soil or sand as in good rich ground. As soon as the reserve store is exhausted hunger becomes apparent, and unless the plants are then supplied with suitable nutriment from the soil and air, and are also placed under conditions favourable for growth, weakness and death are likely to occur.

Among the larger seeds, such as beans and peas, where there is an abundant store of reserve-food, the young seedlings begin to manufacture food for themselves from materials absorbed from the soil and air, long before their reserve is exhausted. In small seeds the reserve is sometimes almost consumed before the roots and leaves are sufficiently developed to carry on their work properly, in which cases a more or less temporary starvation and check to growth ensues. Especially does this happen when seeds are sown too deeply, for a large amount of food is then used in the production of a stem long enough to lift the leaves up into the air.

CHAPTER III.

THE ROOT.

1. From observations made upon the seedlings mentioned in the preceding chapter, it is seen that each of them is made up of distinct parts, namely, root, stem, and leaves. These parts are usually present in all the common flowering plants, and it is needful to examine them separately and in detail.

Primary and Secondary Roots.—It was noticed, when dealing with the bean seedling, that its two ends always grow in opposite directions; the plantlet can be considered as an elongated axis, one end of which bears the leaves and invariably comes above ground, while the opposite end never bears leaves, and persistently follows the plumb-line downwards. The descending part is known as the *root*. As will be pointed out later, all roots do not behave in this manner, and it is to be specially noted that many of the underground parts of plants are not roots; the exceptions, however, may be left for future consideration.

The first or *primary root* which the bean plant possesses is merely an extension of the radicle of the embryo which exists within the seed. Soon after making its exit from the seed, it takes a downward course, and elongates by growth taking place near its tip.

Ex. 15.—Germinate a broad bean on damp flannel. When the primary root is about $\frac{3}{4}$ of an inch long, make small dots upon it about $\frac{1}{8}$ of an inch apart, with a pen or fine brush dipped in Indian ink. Wrap the bean in damp cotton wool, allowing the marked root to be free, and place it in the bottom of a glass funnel with a narrow stem, so that the marked root projects down the latter. Cover over the funnel with a piece of glass or cardboard to prevent

evaporation, and, after allowing it to grow in a dark place two or three days, take it out and notice the position of the dots on the elongated root. Measure the distances apart, and find out which part of the root has grown most.

After it has grown two or three inches long, branches arise upon it similar in appearance to the primary root itself, only thinner (Fig. 9).

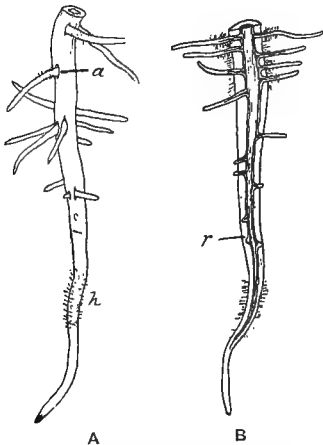

FIG. 9.—*A*, Primary root of bean, showing lateral secondary roots; *h* root hairs. *B*, Longitudinal section of a similar root, illustrating the endogenous origin of the lateral roots.

Instead of growing vertically downwards, they grow away from the primary root almost at right angles to it. These *lateral* branches lengthen in the same manner by growth near their tips, and are called *secondary roots*. They ultimately produce *tertiary roots*, which grow out obliquely from the secondary ones, and further branching may go on in this manner until a very extensive collection of roots is obtained, the whole of which is called the *root-system* of the plant.

2. On careful examination of a well-developed root of a seedling bean, the secondary roots are seen arranged in five rows along the primary root, and not in irregular order, as appears at first sight. They are not, however, equidistant from each other in the rows. The first to appear arise near the cotyledons, followed subsequently by others, which grow out at points nearer the tip, the youngest being always nearest the apex of the primary root, the older ones farther away from it. The relative age of the various lateral roots can therefore be determined by examination of their *position* on the primary root. This kind of sequence where the youngest parts are nearest the tip of the axis on which they grow, and the older ones farther away from it in regular order, is known as *acropetal succession*.

3. Another point to be noted is that the lateral roots do not arise as up-growths on the surface of the primary root, but come from within it, and are described as *endogenous*. The slits which they make in the substance of the primary root, and through which they emerge, can be readily seen in a bean seedling (*A*, Fig. 9, *a*). A section of a root lengthwise, as at *B*, shows that the secondary lateral roots are connected with its central more solid core; the three lowest ones, although they have just begun to grow, have not yet penetrated the outer layer of the root, and would not be visible on the outside of the latter.

This mode of origin is characteristic of lateral roots generally wherever they are met with.

Ex. 16.—Germinate and allow broad beans to grow upon damp flannel as in Ex. 3. Watch the development of secondary roots, noting their position and longitudinal rows on the primary root. Slice some and note the endogenous origin of the secondary roots.

Very carefully dig up a half-grown mangel, turnip, and carrot; wash away the soil and note the arrangement of the secondary roots on the primary root.

Make a deep longitudinal slit with a knife through the 'rind' down to the 'core' of a carrot. Split off the 'rind' and examine the 'core' from whence the secondary roots arise. How many rows of the latter are there?

4. Many dicotyledonous plants have roots similar to those of the bean plant. When, as in this case, the primary one continues to grow, keeping distinctly larger than the lateral ones, it is called a *tap root*. Very good examples are met with among cultivated plants in the carrot, mangel, red clover, and mustard; in shepherd's-purse, poppy, and many other weeds, as well as in most broad-leaved trees.

A number of plants have swollen fleshy roots in which food materials are stored for future use; they are described as *tuberous* roots, and must be distinguished from tubers, which are fleshy underground stems.

To designate the different forms of thickened roots various special terms are in use. The typical carrot root is *conical*; that

of the turnip *napiform*. The root of the radish is spoken of as *fusiform*.

In some instances the primary root is soon rivalled in size by its branches; it may even cease growth altogether. Such plants, on being pulled out of the ground, exhibit a bunch of slender roots, the chief of which are all much the same diameter and length; roots of this character are described as *fibrous*, and are well exemplified in common groundsel and grasses.

5. **Adventitious Roots.**—The roots of monocotyledonous plants differ in their development from those of dicotyledons. The single primary root of the onion, for example, lasts but a short time, and is succeeded by others which do not arise as branches upon the primary one, but spring from the very short stem of the plant. Roots which arise on stems and leaves, or on various parts of the roots of plants, but not in acropetal succession are described as *adventitious*. They are very common upon all monocotyledonous plants of the farm and garden, and may be considered the chief ones which such plants possess. In wheat, for example, the embryo within the grain possesses three roots; in barley, five or six. These are, however, merely temporary structures of use during the earlier stages of growth.



FIG. 10.—Young barley plant showing adventitious roots (*a*) growing out from the first joint or node of the stem.

By the time the wheat or barley plant has begun to unfold a few leaves above ground the primary roots of the embryo are succeeded by adventitious roots which grow out from the lower *nodes* or joints of the stem near the surface of the soil (Fig. 10).

Although common upon monocotyledons adventitious roots are not confined to this class. Examples are abundant upon many kinds of dicotyledonous plants. Good instances are met with on the underground stems of mint, potato (Fig. 144) and hop, and on the runners of the strawberry, stems of creeping crowfoot (Fig. 21) and white clover, as well as many others.

They are generally produced at the joints where leaves grow upon the stem, and may arise in some plants (*e.g.*, on strawberry runners) from internal causes apart from any external influences; in other instances their development depends upon contact of the stem with water or moist soil. Almost all parts of certain plants may be made to produce them, and the propagation of plants such as gooseberries, currants, roses and hops by means of slips and cuttings depends upon their development. Pieces of stem cut off just below a leaf, and placed in moist earth soon develop adventitious roots near the cut end. Advantage is taken of their formation in the propagation of plants by means of layers.

Ex. 17.—Examine the roots on young strawberry runners in July. Also those on creeping crowfoot, young shoots of ivy, underground stems of potato, couch-grass and mint, and on the lower parts of the stems close to the ground, of oats, wheat, and barley. Note the position, number, and extent of these roots.

Examine the roots upon any cuttings or slips which can be obtained, and observe whether they arise on the cut surface or at a point some distance away from it.

Usually adventitious roots are thin and fibrous, but those of the dahlia are tuberous.

6. The complete root-systems of plants vary enormously in extent, but in all cases the total length is much greater than is usually anticipated. That of an ordinary oat plant, although not spreading through more than a cubic yard or two of soil, measured in one instance over one hundred and fifty yards in length.

A tree uprooted by the wind exposes to view a small number of

stout roots similar to the thicker branches of the crown, and from these are given off a larger number of a finer texture. By far the greater bulk, however, which the tree possessed remain in the ground in the form of extremely fine rootlets or *fibrils* extending outwards generally as far, or a little farther, than the branches and leaves of the tree, but in some instances to much greater distances. Not only do the roots grow out horizontally and near the surface of the soil, but they extend downwards as well. In isolated instances, where an adequate supply of air has been maintained along open cracks and fissures, roots have been found to descend many yards into the ground, but in general the roots of the tallest trees rarely go down more than seven or eight feet. The want of air and presence of noxious substances in the lower regions of the soil checks further growth in this direction.

With many plants almost every cubic inch of soil immediately beneath their shade contains fine delicate rootlets, and the extent of their root-branching is very rarely realised on account of the ease with which these hair-like fibrils are broken off when the plant is pulled up or disturbed.

Many forest trees have a natural habit of sending their roots several feet into the soil. Examples of fruit-trees belonging to this class, and requiring a deep soil for proper growth, are the cherry and wild pear.

Some trees, such as larch, keep their root-system nearer the surface, spreading out more horizontally in the ground. The quince, used as a stock on which to graft pears, has roots which remain in the upper regions of the soil. Similar surface-rooting habit is very marked in the 'Paradise' apple on which apples are grafted, and in *Prunus Mahaleb* upon which cherries are often grafted.

The root-system of wheat penetrates more deeply than that of barley; the mangold sends its fine rootlets more extensively into the deeper layers of the soil than cabbage or turnip;

red clover roots more deeply than white clover, and almost all plants have distinct and peculiar habits in this respect.

7. The character and extent of root-development is not, however, altogether dependent upon the species of the plant concerned, but is materially influenced by external circumstances, such as the texture of the soil, and the amount of water in it. In deep open soils and loose sands the root-system of a plant is much larger than that of a similar plant grown in compact heavy ground.

In soils which are not water-logged, increase of moisture up to a certain extent increases the branching of the root, and excellent examples of the influence of water, coupled with good air supply, are seen in well managed plants in pots, and also among plants growing near wells and in drain pipes; the latter in some instances become completely blocked by the large number of fine rootlets of trees growing in their neighbourhood.

The root-system is also considerably modified by the total amount and kind of the manures or food-materials present in the soil. Up to a certain point an increase of nutrient substances increases root-development; an excess hinders it.

Mutilation influences the development of the root-system. If the growing-point of the tap root of a cabbage or tree is cut off its further elongation is prevented, but the secondary roots make up for the loss by more vigorous growth and often many adventitious roots arise near the cut end.

In order to properly cultivate plants of all kinds it is very important to study the habit or manner of branching of their roots and the relative proportions of the thick tap and secondary roots to the fine ramifications to which they give rise and which spread through the soil in all directions. The proportion of root-system below ground to the branches and leaves above is also worthy of attention.

The adaptability of plants to the various kinds of soils, their need of water, the cultivation which the ground should have and

the rational application of manures to the plant are best understood and appreciated after a careful study of these points. Tap-rooted crops, such as sugar-beet, mangold, carrot, and parsnip, require the soil to be well-worked to some considerable depth.

Surface-rooting plants, such as barley, can be grown upon comparatively thin soils. The same is true of pears grafted on the quince and apples on the Paradise stock, and such plants respond more quickly to, and are more benefited by, top-dressings of soluble manures than plants with a deeply-penetrating root-system.

Ex. 18.—The student should dig up and examine specimens of the roots of all the chief plants of the farm; especially is it necessary to investigate the general form and extent of the roots of the common weeds of arable and pasture land. Begin with the examination of young seedlings, which are readily obtained in a complete condition. Note the presence or absence of tap root, extent of branching, the depth to which they descend, and their horizontal extension.

8. **Root-Hairs.**—On the root of a seedling bean grown on damp flannel or blotting-paper is seen a fine white silky band of hairs. These are called root-hairs, and they are never present at the extreme tip of the root but arise at some distance behind its growing point. As the root elongates the root-hairs on the older parts die and turn brown, but others are produced on the younger parts, so that no matter what the length or size of the root may be for a short distance behind its tip it is clad with these delicate transparent hairs. When secondary roots make their appearance hairs are produced upon them in the same manner and follow the same order of development as those upon the primary root.

Their size and abundance are dependent on the species of the plant, and the amount of moisture surrounding the root. Plants growing in very wet situations or completely in water have few or no root-hairs. In very dry soils their development is checked, the greatest abundance being met with in moderately damp soils.

A good supply of lime is found to increase the number and length of the root-hairs of many plants.

The hairs are hollow tube-like structures and should not be confused with fine small rootlets. They are outgrowths from the surface of the root (Figs. 72 and 78), and as long as they last are concerned with the absorption of water and various ingredients in solution from the soil.

Upon plants growing in the ground the root-hairs are very intimately in contact with the particles of soil and are of so delicate a nature that it is practically impossible to remove a plant without destroying them.

Ex. 19.—Germinate beans, mustard, oats, barley, and wheat in damp flannel, and examine the root-hairs on the primary roots. Note their delicate nature, and their position, length, and abundance.

Although almost invisible they are among the most important organs which plants possess. All the food constituents obtained from the soil and from the various manures applied to the latter are taken in by the root-hairs. By their means plants are kept constantly supplied with water; their destruction in the process of transplanting or any disturbance of their development and action, such as may be caused by excessive dryness or imperfect aeration of the soil, leads to a deficient water supply and consequent withering of the plant.

CHAPTER IV.

THE VEGETATIVE SHOOT : STEMS, LEAVES, AND BUDS.

1. It has been already noticed that the seedling bean plant consists of a descending portion, the root, and an ascending part which comes above ground. The latter is known as the *primary shoot*, and consists of an axis—the *stem*—upon which are arranged a series of lateral appendages which are called *leaves*. The points on the stem to which the leaves are attached are usually slightly thickened, and are called *nodes* or ‘joints,’ the lengths of stem between them being termed *internodes*. Flowers ultimately arise upon the shoot, and it is one of the characteristics of seed-bearing plants that seeds are always produced on their shoots and never on roots. For the present, however, flowers may be left for future consideration, and attention paid to the origin and nature of the *vegetative shoot* or stem with its ordinary green leaves.

2. In the earliest stages of the development of a bean plant the primary shoot is very short and bears the cotyledons or primary leaves, its tip ending in the plumule.

The latter is a *bud*, and at the time when the seed commences to germinate, its parts cannot be fully made out by observations with the naked eye. As soon as it comes above ground, however, the bud is found, on examination, to consist of a short stem hidden by a number of enfolding leaves. An external view of it in this stage is given at 1, and a longitudinal section at 2, Fig. 11.

As growth proceeds, the short stem inside the bud elongates, and the leaves, which at first are crowded upon it, become

separated from each other. Marks made upon the stem as previously explained for the root in Ex. 15, reveal the fact that the increase in length takes place at the tip of the shoot. After reaching a certain length the lowest intervals between the leaves cease to elongate; the upper, younger and shorter ones also lengthen and cease in a similar manner, to be followed in turn by still younger parts of the stem nearer the tip. The stem, before the growing season is over, may thus reach a height of two or three feet, or even more, the extreme tip, or *growing-point* as it is called, remaining young all the time, and acting as a manufactory for the addition of more stem and leaves. The growing-point, which is of a tender and delicate nature, is protected by the enfolding young leaves, the latter arising as outgrowths from its external surface. The youngest leaves are always nearest the tip of

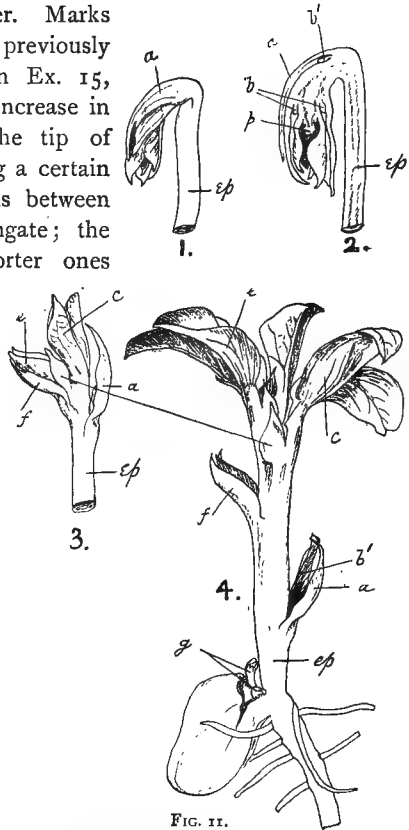

FIG. 11.

1. Epicotyl of bean, with plumule.
2. Longitudinal section of the same; *ep* epicotyl; *β* terminal growing point of the plumule; *a* a leaf in whose axil is a bud *β'*; *b* buds in axils of inner leaves of the plumule.
3. Epicotyl, with plumule unfolding.
4. Later stage of growth of 3, showing connection with bean seed; *ep* epicotyl; *a* first leaf (rudimentary), in whose axil is bud *β'*; *f* second leaf (rudimentary); *c* and *e* ordinary foliage leaves; *g* buds in axils of the cotyledons ready to develop into stems which may come above ground.

the stem which bears them, the older ones being further removed from it in regular order—that is, they arise in acropetal succession, and adventitious leaves are never met with.

Ex. 20.—1. Sow beans in pots or boxes containing a mixture of damp sand and garden soil.

Cut longitudinal sections, and examine the structure of the stem and terminal bud of a seedling as soon as it has come above the surface of the soil.

2. Watch the development of the stem up to the time of unfolding of the green leaves.

Observe the rudimentary character of the first leaves.

3. Make small marks on the stem about a quarter of an inch apart with Indian ink, and observe which part elongates most.

4. Make similar observations upon the seedlings of mustard and peas.

3. While numerous annuals, such as mustard and charlock, and some perennials, resemble the bean, many plants differ somewhat from it in the development of the plumule. Instead of the latter growing at once into a long shoot, bearing leaves at some distance from each other, the primary axis within the plumule elongates very little, its internodes remain very short, and the leaves arising upon it appear crowded together, usually in the form of a rosette, a short distance above where the cotyledons were placed; this form of stem with short contracted internodes is well illustrated in the first season's growth of mangels, turnips, carrots, certain thistles, and red clover. In such plants as these, the primary root and hypocotyl become much thickened by the deposition within them of reserve-food prepared by the leaves, and it is only during the following year that the growing-point of the stem, which is hidden in the centre of the rosette, elongates and produces a shoot with long internodes, and bearing a series of new leaves at considerable intervals.

In the onion and many bulbous plants the primary stem also remains very short, and the reserve-food prepared by them are deposited in the bases of the leaves, instead of being stored in the root and stem, as in the former instances (see Fig. 24).

4. **Buds.**—The stems and leaves of all flowering plants originate from buds in the manner indicated above ; buds may therefore be termed embryonic or incipient shoots. It is by their growth that trees, which appear so bare in winter, become clothed with fresh green leaves in the succeeding spring. The relationship which they bear to the leaves and stems produced by them is easily discerned by examining the structure and watching the development of the terminal bud of a young sycamore tree (Fig. 16).

On the outside is observed a series of scaly leaves, which overlap each other, and protect and cover up the delicate growing point of the twig.

A section through the bud (Fig. 12) shows the disposition of these scaly leaves and within are also seen the ordinary leaves (*l*) arranged upon a very short stem (*s*). In spring the inner scaly leaves

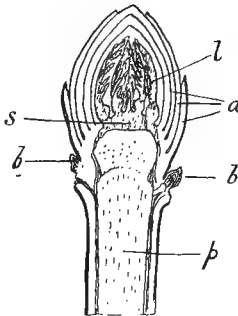

FIG. 12. — Longitudinal section of a terminal bud of a sycamore tree as seen in autumn. *a* bud-scales; *s* rudimentary stem, with foliage-leaves *l*; *b* lateral buds; *p* pith.

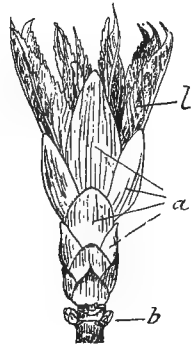

FIG. 13. — Terminal bud of sycamore, similar to that of Fig. 12, developing in spring. *a* bud-scales; *l* foliage-leaves; *b* lateral bud.

grow for a time (*a*, Fig. 13), and ultimately fall off, leaving small scars where

they were attached to the twig. The stem (*s*), which bears the rudimentary green foliage-leaves (*l*), elongates, and the latter are pushed out from between the protective scaly leaves of the bud (Fig. 13). After a week or ten days, the stem has reached a considerable length, and the leaves, which were rudimentary and packed away in the bud, unfold themselves and grow out flat as in Fig. 14.

The number of foliage-leaves present upon a developed shoot is often indicated in the bud, but in some plants, especially those of a herbaceous character, the growing point of the bud continues to produce new leaves until frost checks it in autumn.

Ex. 21.—Cut longitudinal sections through a Brussels sprout and the ‘heart’ of a cabbage. Note the stem, leaves, and axillary buds within.

Ex. 22.—Examine with a lens longitudinal sections of the buds of sycamore, horse-chestnut, oak, beech, and other trees.

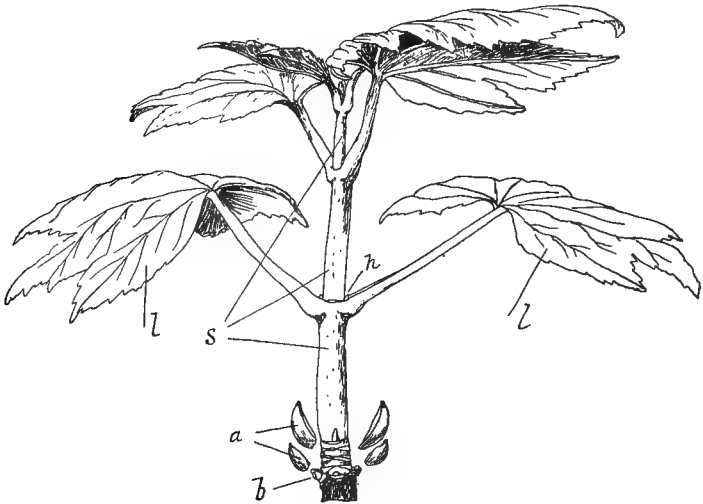

FIG. 14.—Later stage of development of bud in Fig. 13. *a* Bud-scales falling off; *s* stem; *l* foliage-leaves in axils of which are lateral buds *h*.

5. The vegetative shoots of plants usually end in *terminal buds*, and an examination of almost any kind of plant shows that not only are buds present at the tips of the stems, but on their sides as well. These lateral buds arise ordinarily in the upper angles formed where the leaf-bases and stem join each other. The angles are termed the *axils* of the leaves, and the buds are designated *axillary buds*. Most fre-

quently only one bud is produced in each leaf-axil, but in some instances, two or more may be present.

6. Generally the first leaves of the bud which are outermost or lowest down on the stem, are rudimentary structures, smaller and different in appearance from those which unfold later. In the primary bud or plumule of the bean (Fig. 11), and many similar herbaceous plants, this is observable, but it is most evident in buds which are met with upon perennials, such as shrubs and trees. In the latter the outermost leaves of the buds are generally more or less firm, tough structures, termed *scales* or *scale-leaves*, which protect the interior of the bud from being injured by frost, rain, and other agents during the winter. Buds, such as those of the sycamore (Fig. 16) and pear (Fig. 17), having scales are termed *scaly buds*, those without, such as mealy guelder-rose, being known as *naked buds*.

7. Buds similar to those of the bean and sycamore, previously described, which develop into shoots bearing green foliage-leaves, are termed *leaf-buds*: when met with upon trees they are sometimes named *wood-buds*, as it is from them that new woody twigs are produced. Many buds, however, on opening, give rise to flowers only, and are termed *flower-buds*: a third kind is met with producing short shoots bearing both green leaves and flowers; these are *mixed-buds*. Among gardeners the two latter forms are known as *fruit-buds*, as it is from them that fruit is obtained. The general appearance and development of a mixed bud from a pear tree is illustrated in Figs. 17 and 18.

It is not possible in all cases to distinguish fruit-buds and wood-buds by their outward appearance, although for budding and pruning operations and the general management of fruit-trees it is desirable to do so. In apples and pears the wood-buds are small and pointed, the fruit-buds being blunter, more plump, and of larger size. In cherries and plums both kinds are very similar in appearance in winter, and it is only in spring when

they begin to develop that the stouter and blunter characters of the fruit-buds show themselves.

Their position upon the shoots is a great aid in distinguishing the two classes of buds (see pp. 44-50).

8. **Branching of Stems.**—The axis or stem of the primary shoot of plant is at first single, and may continue to grow as a simple straight structure. Usually, however, after a time, *branches* or *secondary axes* arise upon it, and these in all cases proceed from buds. In Fig. 11, of the primary bud of a bean, secondary lateral buds are seen in the axils of the leaves of *b'* and *b*: these are flower-buds, and consequently do not produce long leafy shoots; but secondary axes bearing green leaves frequently occur in the bean, and are generally produced from buds in the axils of the cotyledons as at *g* (Fig. 11).

In many plants the buds in the axils of each leaf of the primary stem develop into leafy shoots, and upon the latter branches may again arise in a similar manner. The total number of stems bearing leaves may thus become very large on a single plant. In the best fodder crops, where large yield is always a desirable feature, branching is exhibited in high degree, and the same may be observed in trees of all kinds, and many weeds, such as groundsel and chickweed.

9. The main stem of a plant is spoken of as a *primary axis*, or axis of the first order, the branches upon it being *secondary axes*, or axes of the second order, those borne by the latter *tertiary axes*, and so on. For purposes of convenience in description, any axis may be considered a main one, its branches then being secondary axes.

10. When a stem continues to grow at its apex, for a long time it is spoken of as *indefinite* in growth: the branches upon it are usually many in number, and smaller than the main stem. This form of branching is spoken of as *racemose* (*a*, Fig. 15).

In many plants the terminal bud produces a flower or a collection of flowers, and the main axis then ceases to elongate:

such a stem is *definite* in growth. When lateral branches arise upon it, they are generally few in number, and soon equal or exceed the main stem in vigour. Branching of stems of definite growth is said to be *cymose*; it often resembles the diagrammatic sketch *b*, Fig. 15. Cymose branching, however, sometimes leads to the formation of what at first sight appears to be a simple main axis of indefinite growth, but which is in reality composed of a series of short axes of different orders. At *c*, Fig. 15 is a main or primary axis 1, which ends at *x*, its growing point having developed a flower or been destroyed by frost, wind, insect attacks or other means, and elongation

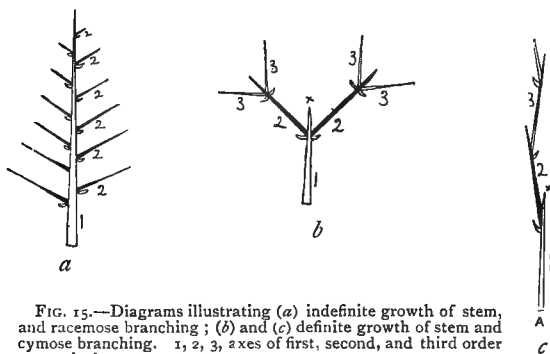

FIG. 15.—Diagrams illustrating (*a*) indefinite growth of stem, and racemose branching; (*b*) and (*c*) definite growth of stem and cymose branching. 1, 2, 3, axes of first, second, and third order respectively.

thereby prevented. Below its tips a lateral bud has produced the branch or secondary axis 2: the latter axis soon ceased growth, and a branch of the third order, 3, was produced, a further one, 4, being developed in a similar manner. The whole shoot from *A* to *B*, although crooked at first, may ultimately straighten and appear similar to a simple single axis of the first order of indefinite growth: when this happens such a stem is termed a false main-axis or *sympodium*.

The branches of elm, hazel, and many other trees which

appear straight and of indefinite growth, are often in reality sympodia, the terminal bud upon each annual shoot having been destroyed or terminated by a flower, and a false axis formed by the subsequent vigorous growth of the highest lateral bud. The 'spurs' or short shoots on pear (Fig. 17), apple (4, Fig. 19), and currant trees and also many of the underground shoots of grasses are examples of sympodia.

Ex. 23.—Examine the kind of branching of the shoots of various common plants, such as groundsel, chickweed, nettle, charlock, mustard, vetches, beans, peas. Note the origin of the branches above the leaves.

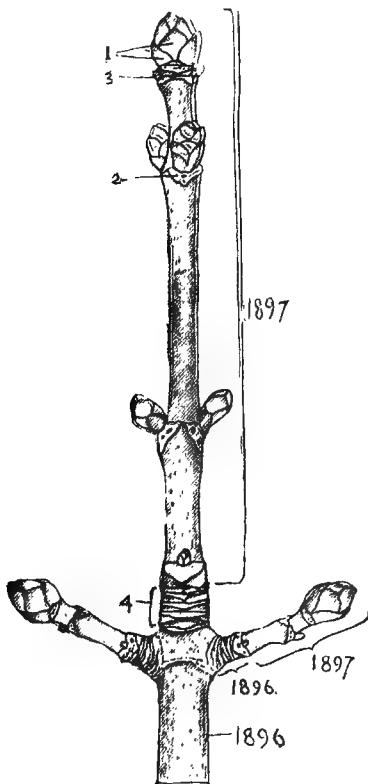

FIG. 16.—Piece of sycamore stem as seen in autumn.
For explanation see text.

II. Twigs of Trees in Winter.—A study of the appearance of the shoots of trees in winter and their subsequent development during the following spring and summer is instructive.

On the sycamore branch shown in Fig. 16, large terminal buds are visible and several lateral ones, beneath which are well-marked *leaf-scars*, as at 2, indicating the place where the leaves were attached in the previous summer. In 1896 the part marked 1897 did not exist, but

the twig was terminated by a bud similar to that of Fig. 12, and had also two small lateral buds resembling *b*, Fig. 13. In the spring of 1897 the buds opened, and the bud-scales fell off and left scars at 4. The terminal bud then grew as in Figs. 13 and 14 and produced a considerable length of stem marked 1897, with several lateral buds upon it, each of which developed in the axil of a leaf, as at *h*, Fig. 14. From the small lateral buds just beneath the terminal one short shoots originated in a similar manner.

12. The amount of growth of twigs during one year or one growing-season is represented by the length between two sets of bud-scale scars (4, Fig. 19, n^1 to n^2).

As the scars are often visible upon the bark for several years they are useful aids in the determination of the age of any length of tree, stem, or twig. Frequently small buds are present in the axils of bud-scales, and as the internodes between the latter remain short such buds appear crowded together upon the twigs and are often visible after the scars have been obliterated (Fig. 57, between *A* and *B*).

The length of stem which a bud produces during a year's growth is very varied, some leaf-buds giving rise to shoots not more than a small fraction of an inch long, while others reach a length of several feet. Much depends upon the kind of plant, its age, treatment, and the position of the bud upon the tree, as well as upon external circumstances, such as climate and soil. In trees which are unmolested the length of the shoots produced each year by the terminal buds goes on increasing from extreme youth onwards until a certain age is reached, after which the yearly length of the shoots begins to diminish. The age at which the growth is at a maximum is different for different trees, some forming their longest shoots when they are 15 to 20 years old, others not until 30 to 40 years have elapsed. In old age the large number of buds to be supplied with water and food-constituents, and their increasing distance from the water-supply in the

ground, prevents the extensive growth which is noticed in youth : the shoots upon aged trees are therefore very short.

The difference in the general appearance between young and old trees is striking ; so long as long shoots are produced the crown or head remains open and largely composed of long straight branches, but when the formation of short shoots begins the crown assumes a denser aspect.

In most trees the terminal bud of a shoot usually develops the strongest shoot, the lateral buds giving rise to shorter branches in regular decreasing order from the tip to the base, where the buds usually produce very short shoots or none at all. In the ash and willow, however, the branches on a shoot are much the same size from top to bottom, and in a few instances the branches are short near the tip and base and long near the middle of the shoot. In good soil and a favourable climate the branches of trees are longer than where the ground is poor and lacking in moisture or where the climate is severe.

Nitrogenous manures and absence of light due to overcrowding tend to the production of long shoots, while the bearing of fruit checks the vigour of trees and leads to the formation of short shoots.

13. 'Spurs.'—The short branches upon trees often grow very little each year and may take many years to reach a length of even four or five inches. They are readily recognised by the large number of ring-like scars which mark the place where the bud-scales have fallen off each year. Upon fruit-trees they are known as *spurs* or *fruit-spurs*, and they need special attention, as it is upon them that fruit buds are most frequently borne in some kinds of trees.

The formation of a fruit-spur and its development is illustrated in Figs. 17 and 18.

4, Fig. 19 is a typical piece of a long shoot of an apple tree three years old bearing fruit-spurs.

The part 1898 is one season old, and grew from a terminal

bud arising at n^2 , the bud-scale scars being visible at this point. The three buds upon it similar to a are wood-buds: they may in 1899 develop into (1) long shoots, or (2) short ones, or (3) remain undeveloped. The part of the shoot between the bud scale-scars n^1 and n^2 is the previous year's growth, namely, that of the summer of 1897. The buds upon it in the winter of 1897 were similar to those marked a : during the summer of 1898, when the terminal bud at n^2 was growing into a long leafy shoot, they developed short leafy shoots, similar to B and C , Fig. 17, each of which went to winter rest with a terminal *fruit-bud* upon it.

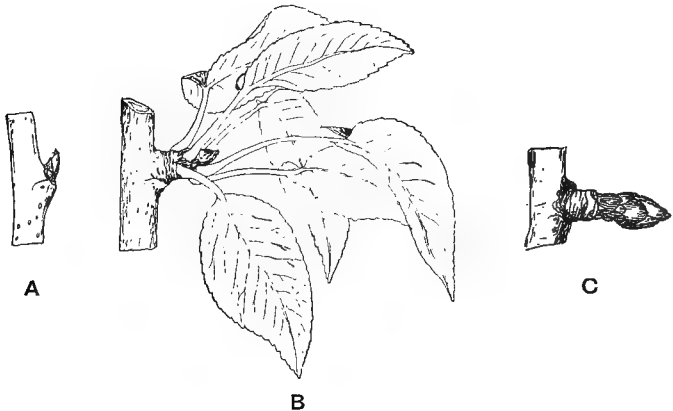

FIG. 17.—*A*, Piece of last season's shoot of pear tree with wood or leaf-bud as seen in autumn. *B*, The same in the following midsummer; the bud has now given rise to a short shoot or 'spur' bearing leaves and terminated by a fruit-bud. *C*, The same as *B* after leaves have fallen in autumn, showing 'spur' terminated by the plump fruit-bud.

Parts similar to b , therefore, are not merely stalked buds, but short branches bearing terminal fruit buds; they are one-year-old fruit-spurs, the terminal buds of which in 1899 will open into a short stem bearing flowers similar to B , Fig. 18. At d is a bud still in the undeveloped condition in which it was first produced, and is therefore similar to a , except that it is two years old: it is a *dormant bud*.

Upon the three-year-old piece of the shoot marked 1896 are two spurs, *c* and *e*, two years' old. In 1897 they resembled *b*,

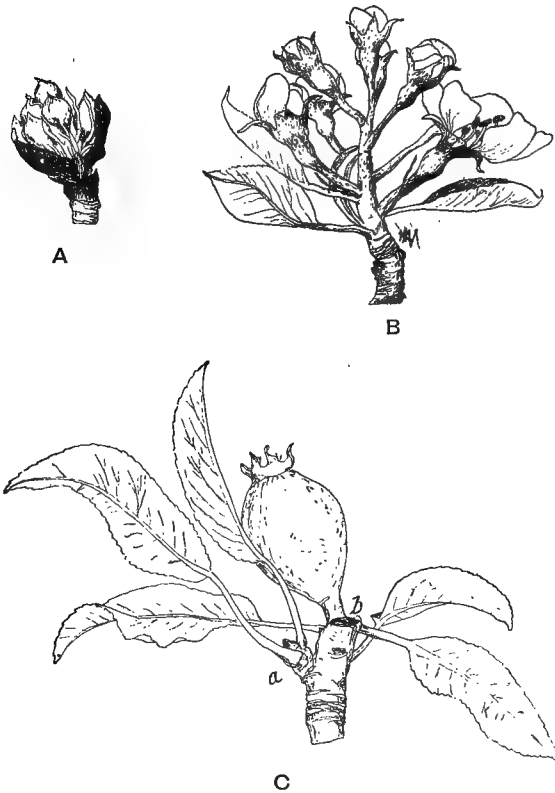

FIG. 18.—Fruit-bud of pear (same as *C* of previous Fig.), showing various stages of its growth. *A*, opening in spring; *B*, later with flowers and leaves expanded; *C*, later still, only one flower has 'set' or developed into a fruit, the rest having fallen off at *b*: *a*, a lateral bud which will continue the growth of the spur in the following year.

and in the spring of 1898 opened into a stem bearing flowers, such as *B*, Fig. 18. Fruit was produced during the summer, and

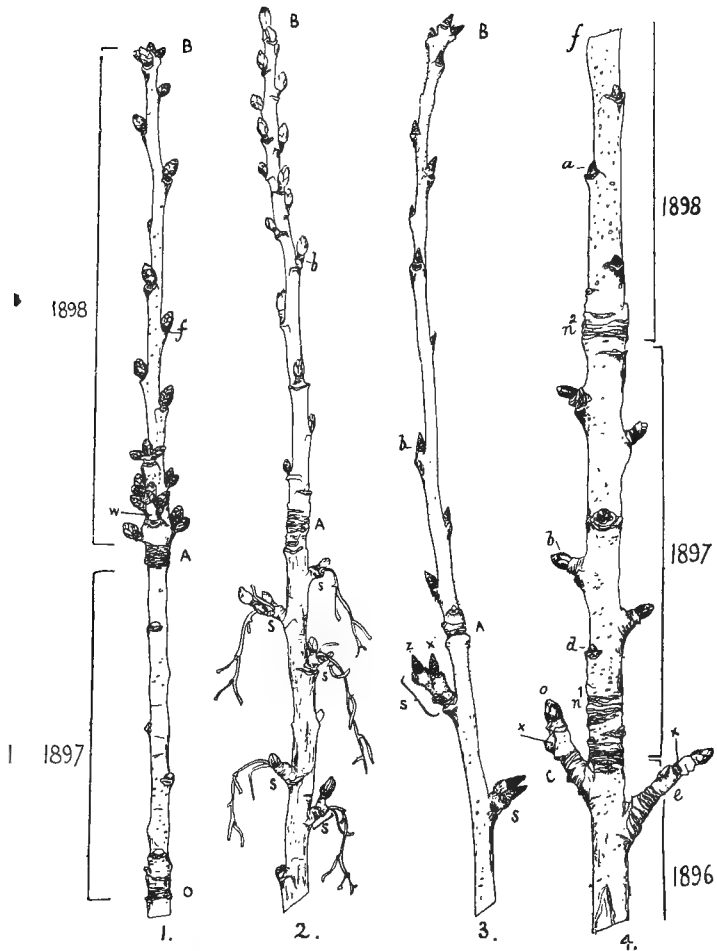

FIG. 19—Shoots of various fruit-trees.

1. Morello cherry. *A* to *B*, long shoot of last season, 1898, with *fruit-buds*, *f*; similar shoots of 1897 and earlier years are practically bare. *w* a spur.
2. Black currant. *A* to *B*, long shoot of last season, with *fruit-buds*, *b*; long shoots of previous year have *fruit-buds* on spurs, *s*.
3. Plum. *A* to *B*, long shoot of last season, with *wood-buds*, *b*; long shoots of previous year have *fruit-buds* on spurs, which terminate in a wood-bud, *z*, and bear lateral *fruit-buds*, *x*.
4. Apple. *n*² to *f*, long shoot of last season, with *wood-buds*, *a*; long shoots of previous year have spurs which terminate in *fruit-buds*, *b* and *o*. For further explanation see text.

the large scar at *x* indicates that one apple ripened, the small fruit-scar at *x* on spur *e* being evidence that the fruit fell from the latter prematurely.

It must be noticed that after the production of fruit such a spur as this cannot continue growth in the same line; it may die altogether, but usually one or more lateral wood-buds arise upon it in the axils of its leaves, and these continue its future growth. On spur *c* the lateral bud *o* has arisen in this manner during 1898 when the fruit was being ripened. The spurs of

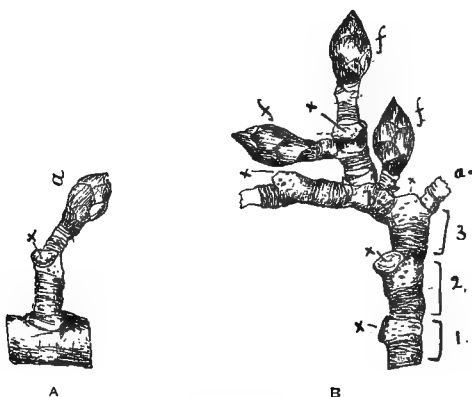

FIG. 20. *A*, 'Spur' of pear tree which has borne one mature fruit at *x*; *a* a fruit-bud. *B*, An old 'spur' from the same tree; 1, 2, and 3, growth of three successive years, forming a symposium: *x* large scars left where fruit has matured and fallen off; *f* fruit-buds.

the apple and pear, therefore, present a zig-zag appearance (see Fig. 20); those of black currant are similar.

The spurs of the plum terminate in wood-buds, and consequently grow in a straight line; the lateral buds are fruit-buds (3, Fig. 19).

No hard and fast rule can be laid down in regard to the position of the fruit-buds upon trees, as it is not absolutely constant for any one kind; exceptions occur due to manuring, cultivation, season, kind of tree, and the pruning it has received.

Three fairly distinct classes of trees may, however, be recognised. Some trees, such as the peach, bear almost entirely on long shoots one year old and have few or no spurs, while others produce their fruit-buds chiefly at the apex or on the sides of spurs, the long shoots of the tree bearing only wood-buds in their first year; a third group bears almost equally both upon long shoots and spurs.

The apple and pear produce fruit-buds chiefly upon spurs, and rarely upon long shoots which are only one season old. A few varieties of apples, however, such as Cox's Orange pippin, Ribston pippin, and Irish peach, sometimes produce fruit-buds freely on the long shoots of last season.

The plum bears largely upon spurs (*s*, 3, Fig. 19), but sometimes the fruit-buds may appear upon its young long shoots: when the latter happens they are usually accompanied by wood-buds placed on each side.

The red currant carries its fruit chiefly upon spurs; the black currant, both on young long shoots and spurs, but chiefly on the former.

In the black and white Hearts, Bigarreau and Duke cherries, the fruit-buds are mostly met with upon spurs, but the Morello and Kentish types bear largely upon the one-year-old long shoots (*1*, Fig. 19).

The gooseberry and apricot resemble the black currant in the arrangement of their fruit-buds.

The raspberry bears upon leafy shoots, which arise in summer from buds on the previous year's cane. The canes or stems which come above ground are biennial. The fruiting cane dies down in autumn, but before this takes place the buds at its base on the underground rootstock grow up into canes: in the following year the buds upon the latter open out into leafy shoots which bear the fruit, after which these canes die away, and are followed by a new set of young canes which originate in a similar manner.

There is considerable difference in the age to which fruit-spurs attain ; some, like those of apple and pear, live many years ; upon red currant they remain productive longer than upon the black currant ; the spurs on the Morello cherry are shorter lived than those upon the other varieties. In pruning those trees with spurs of short life, endeavour should be made to secure relays of young long shoots at frequent intervals.

14. **Dormant Buds.**—On examining trees in spring when the buds are beginning to develop, it will be observed that some of them remain inactive and continue in this condition all the summer. Not only may they refuse to grow in what may be termed their proper season, but they frequently remain undeveloped for long periods. Such buds are termed *dormant* or *resting buds*, and are met with upon almost all kinds of plants, chiefly near the *base* of the stems, as at *d*, 4, Fig. 19.

Although many dormant buds soon die, some remain capable of development for several years after their formation, and may give rise to what are termed *deferred shoots*. In fruit-trees they are termed 'water-sprouts' ; if they spring from beneath the surface of the ground they are known as 'suckers.' They not uncommonly arise upon 'stocks' which have been grafted or budded.

Destruction of the terminal and lateral buds near the top of a stem tends to promote the growth of deferred shoots from dormant buds at its base. This is well illustrated in shoots of fruit-trees and roses when they are pruned severely. Moreover, pinching out the terminal buds of herbaceous and other plants is often practised with a view to insure the development of all the lateral buds upon it, and the formation of a bushy plant instead of one with a single main stem and few branches.

The grazing and mowing of grasses promotes the full development of all their buds, and a consequent increase of leafy stems.

Not only does cutting away or pinching off the terminal buds

promote the development of basal buds likely to become dormant, but anything which impedes the movement of water or 'flow of sap' to the terminal and highly-placed buds tends towards the same result.

In the early formation of cordon fruit-trees, where it is important that all the buds upon the main stem should develop shoots or short spurs, bending the shoot for a time is practised in order to promote the 'breaking' of those buds at the base of the stem which might otherwise remain dormant and leave a length of unfruitful wood.

15. **Adventitious Buds.**—Dormant buds, mentioned above, are buds which have arisen in regular order in the axils of leaves, but which have remained inactive some time; the only irregularity about them is their period of development. Buds may, however, arise at any point of a plant, not necessarily in the axil of a leaf, but on any part of the stem, or even upon roots and leaves: such are termed *adventitious buds*. Examples are met with on the roots of docks, poplars, roses, and many other plants, especially when the upper bud-bearing parts have been removed. They frequently arise and produce shoots upon stems which have been injured. In some instances they proceed from the callus covering the wounds where branches have been cut off; some of the shoots of 'pollard' trees spring from adventitious buds originating in this manner.

Adventitious buds are often produced upon leaves which have been removed from the parent and pegged down on moist sand or loam. Gardeners take advantage of this peculiarity in propagating begonias.

Similar buds occur upon some kinds of leaves when they are severed from the plant and their petioles stuck in moist ground: the scales of the hyacinth and other bulbs give rise to new plants in this manner.

Ex. 24.—Examine twigs of ash, sycamore, elder, horse-chestnut, oak, beech, and other trees and shrubs in winter. Make notes of the arrange-

ment of the buds, the scars left where the foliage-leaves and old bud-scales have fallen off, and the hairyness, smoothness, and any other peculiarities of the bark and buds. (See Tables, page 61.)

Ex. 25.—Measure the lengths of internode between successive buds on last year's shoots of the common trees and shrubs. At which parts,—those which are youngest or those which are oldest,—are the buds most closely placed on the stems?

Ex. 26.—Examine young ash, sycamore, oak, and other trees in winter.

(1) Try and find out the yearly growth in length of the various parts of each.

(2) Make observations in regard to the length of the branch produced by buds near the apex, middle and base of each year's growth. Note the presence or absence of "dormant" buds.

(3) Find out if the branching is generally racemose or cymose. Look for sympodia upon hazel, beech, elm, and horse-chestnut, and other trees.

(4) Note the difference in length of yearly growth of branches in very old trees and young ones of the same species.

Ex. 27.—Examine the long shoots and short shoots ('spurs') of apple, pear, plum, cherry, gooseberry and currant. Observe the size and form of the buds upon the various parts of the shoots. Cut longitudinal sections and examine with a lens: endeavour to determine which are wood-buds and which are fruit-buds.

Ex. 28.—Examine the unfolding buds upon the chief fruit trees in spring when the different kinds of buds can be easily distinguished: observe the position of the leaf-buds, mixed-buds, and flower-buds respectively.

16. Stems and their Varieties.—Stems which are soft and which usually last but a short time, are termed *herbaceous*; practically all our annuals have stems of this nature, and many perennial plants also, *e.g.* nettles and hops. Most stems which last several seasons develop within themselves considerable quantities of wood, and are harder and firmer in consequence: such stems are said to be *woody*. It must be pointed out, however, that herbaceous stems in reality also possess wood, but only in the form of thin strands, which are relatively small in amount when compared with the remaining soft parts. All stems, moreover, are soft and herbaceous when very young, so that no real distinction exists between herbaceous

and woody stems, as it is a matter of degree of development of the wood within them: a wall-flower or a rose, for example, may be soft and herbaceous in its upper parts and hard and woody below.

Trees and *Shrubs* have well-developed woody stems, the former possessing a single main stem or *trunk*, which is devoid of branches for some distance above the ground; the latter have no very distinct main stem, and the chief branches are all much the same in thickness and spring from a point either on or close to the ground.

Many plants have stems which are too weak to maintain an erect position; they consequently grow along the surface of the soil. Some plants have weak stems which always remain *prostrate*, while others, designated *climbing plants*, have stems which, although too weak to stand upright of themselves, are nevertheless able to use suitable objects near them as supports. Climbing plants support themselves in various ways. In ivy, adventitious roots are developed on one side of the stem, and these serve to fix the plant to bark of trees, walls, and rocks.

Tropæolums of gardens and wild clematis are supported by their leaves, the petioles of which curve round the stronger branches of plants growing near them.

Peas and vetches are also enabled to climb by means of their leaves, some of the leaflets of which are modified into thin thread-like structures termed *tendrils*. The latter are sensitive to contact, and wind round any slender object which they touch. Plants such as the blackberry, rose, &c., are supported by means of their stiff prickles.

In *twining plants* the whole stem upholds itself by twisting round neighbouring objects. The stems of some of them always twine to the right when growing round a support; the hop is an example: others, such as bindweed, twine to the left.

17. A number of peculiar modifications of shoots are met with,

many of which receive special names; the most familiar are mentioned below:

i. Above ground.

(a) In the wild pear, wild plum, hawthorn, sloe, and buckthorn, some of the branches end in hard, sharp points, termed *thorns* or *spines*. That they are modified shoots is seen from the fact that they arise in the axils of leaves, and also themselves bear leaves and lateral buds in some instances.



FIG. 21.—Runner of Creeping Crowfoot (*Ranunculus repens* L.).
r Adventitious roots; s internodes.

(b) A *runner* or *stolon* is a shoot which extends horizontally over the surface of the ground. Its internodes are long, and from its nodes adventitious roots are produced, and grow into the soil (Fig. 21). The buds present on the runner then become fixed to the ground, and, developing into upright shoots, form separate plants as soon as the internodes at *s* die away or are severed.

Strawberry runners and those of creeping crowfoot are good examples.

Ex. 29.—Examine the thorns upon the hawthorn, sloe, wild plum, wild pear, and buckthorn. Note their origin in the axils of leaves, and that some of them bear buds and leaves.

Ex. 30.—Examine the origin of the runners upon strawberry plants, mouse-ear hawkweed, and creeping crowfoot. Observe the position of the leaves and buds upon the runners.

ii. Underground.

Stems within the soil sometimes resemble roots, but they can be distinguished from the latter by the possession of leaves and buds, and by their originating in the axils of leaves.

(a) A *rhizome* or 'rootstock' is an underground shoot, which grows more or less horizontally. Adventitious roots arise at the nodes, and the internodes may be long or short, thick or thin, so

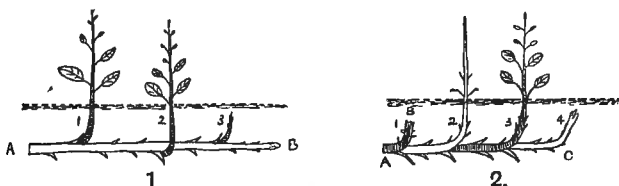

FIG. 22.—1. Diagram illustrating growth of an indefinite rhizome. *A* to *B*, indefinite primary axis which remains below ground permanently. 1, 2 and 3, lateral branches of *A B* which come above ground.

2. Diagram illustrating growth of a definite rhizome. *A* to *B*, definite primary axis which has flowered and decayed away; 2, a branch from the primary axis coming above ground; 3, a branch from 2; 4, a branch from 3. The whole stem from *A* to *C* below ground is a sympodium or false main-axis.

that the general appearance of a rhizome is variable, those of couch and other grasses being long, thin straggling shoots, while in iris, hop and other plants they are thick and fleshy. When leaves are present, they are generally reduced to the form of membranous scales.

Rhizomes may be indefinite or definite in growth; in the former case, the true and main axis continues to grow at its tip, and always remains below ground; the parts which come above ground are secondary or lateral branches, which arise in the axils of its scaly leaves (1, Fig. 22). Most rhizomes are, how-

ever, definite in growth, the main axis, after growing a longer or shorter distance below, comes above ground, the continuation of the rhizome within the soil being carried on by lateral branches (2, Fig. 22). In perennial rhizomes of definite growth, such as those of sedges, grasses, and many other plants, the permanent part which remains below ground is a false main-axis or sympodium (p. 41).

(*b*) The term *sucker* is applied to any adventitious shoot which originates below ground on the stems or roots of shrubs and trees. It possesses adventitious roots and by separation from the parent may become a new individual plant. Suckers often develop very rapidly and rob the parent of water and nutriment, so that except for purposes of propagation they should be destroyed.

Ex. 31.—Examine the underground parts of couch-grass, bindweed, mint, potato, horse-radish, asparagus, raspberry, and hop, and observe the scale-leaves and the buds in the axils of some of them.

Note the connection of the shoots which come above ground with the underground parts.

(*c*) A *tuber* is a shoot with a short, thick, fleshy stem, and minute scaly leaves, in whose axils are buds or 'eyes.' The most common tubers are developed below ground—*e.g.* those of potato and Jerusalem artichoke—but they may occur on parts of plants above the soil. The scaly leaves are not visible on the fully-developed potato tuber, as they drop off or shrivel up before ripening is accomplished. For the development and structure of the potato tuber see pp. 457-462.

(*d*) A *corm* is a short, thick, fleshy stem, with a few thin, scaly leaves covering it, and bearing one or more buds at its apex. Examples are seen in the ordinary crocus and gladiolus of gardens.

Fig. 23 is a section of a crocus in flower. At *b* is the solid, fleshy stem of the corm, with the remains of an old corm (*a*) adhering to it, and several adventitious roots (*r*). From its summit

at *h*, the terminal bud has grown in spring into a short stem (*c*), bearing on its sides thin, membranous leaves (*d*) and ordinary green foliage leaves (*e*), which come above ground. One or more flowers are produced from the axils of the leaves, as at *f*. The substances stored in the stem of the corm (*b*) are used up in production of these leaves and flowers, and consequently, at the end of summer, this part becomes shrivelled and dead, like *a*. The green leaves (*e*), however, after they have developed, manufacture a considerable amount of food, and this descends from the leaves, and is stored in the short stem (*c*), which thickens in consequence and becomes a new corm at the end of the season. The buds (*x*) in the axils of the leaves of the new corm remain near its apex, carry on the production of a new series of flowers, leaves and corms in the following year.

A corm, instead of possessing only one bud at its summit, as at *h*, often has several buds there, each of which develops into a new corm in the manner described; thus one corm may give rise to many in a single season.

(*e*) A *bulb* often resembles a corm in external appearance, but consists of a comparatively small stem, upon which is arranged a

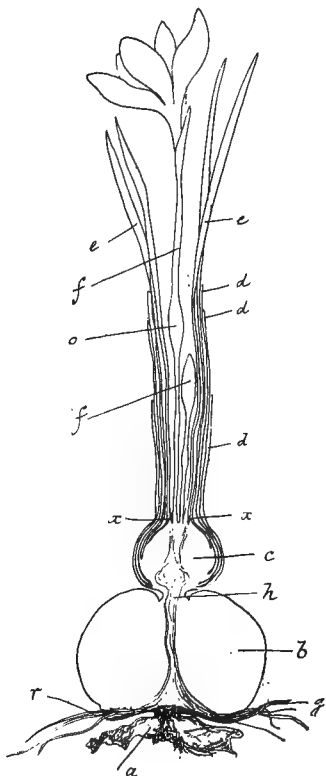

FIG. 23.—Section of Crocus in flower.
For explanation, see text.

number of thick, fleshy, scale-leaves, which overlap each other

more or less completely. The whole structure is practically a huge bud, and in the axils of some of its scales are small, rudimentary buds. Familiar examples are met with in the onion, tulip, lily, hyacinth, snow-drop, and narcissus.

The onion seedling, figured on page 20, develops several leaves during summer, as at *A*, Fig. 24, and the plant swells at its base and forms a bulb. A section, as at *B*, reveals its structure. Tracing the leaves from the green parts downward, it is observed that the bases, especially of the inner ones, are thickened, and it is these leaf-bases which form the main mass of the bulb, the stem (*s*) upon which they grow being comparatively small. At

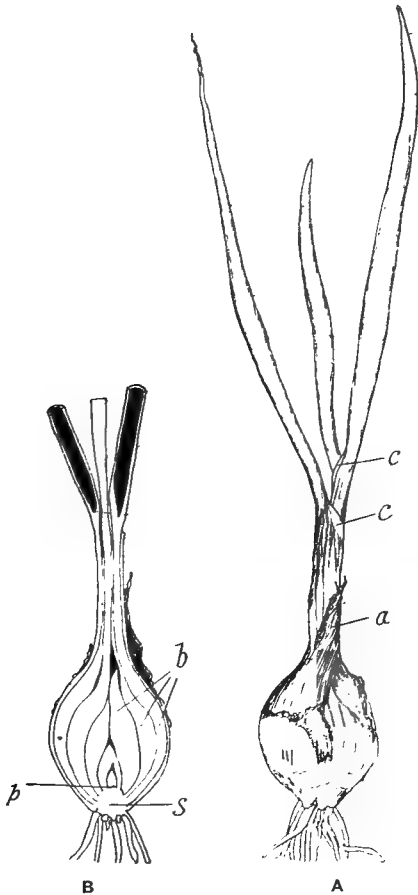

FIG. 24.—*A*, Young onion plant; *a* remains of an old leaf; *c c* younger leaves.

B, Longitudinal section of the same; *s* short stem; *b* leaves and leaf-bases forming the chief part of the bulb; *p* growing point of stem.

the end of summer, the green parts of the leaves die and shrivel ; their lower parts, which have become thin, act as a cover for the rest of the bulb, and prevent the rapid loss of water from the interior.

The onion bulb, if planted next year, forms adventitious roots from the base of the stem, and the terminal growing-point (p) inside grows up into the air, and produces leaves and an inflorescence of white flowers at the end of a long hollow stem. The buds in the axils of the scale leaves develop usually in the same manner, so that from one bulb several flowering shoots are often produced. The materials stored in the bulb-scales are used up in this development of the flowering stems, and after the production of ripe seeds, the whole plant is generally exhausted, and dies away, in which case the onion is a biennial plant. Occasionally, however, some of the lateral buds from the axils of the scales do not produce inflorescences, but leafy shoots only, which form small bulbs in the same manner as an onion seedling. After the death of the parent, these smaller bulbs remain, and carry on the growth in the succeeding year. The onion plant in this instance is a perennial.

A tulip bulb in autumn consists of a short, thick stem, upon which are placed a series of large, overlapping, fleshy scales. The latter are complete leaves, and not merely leaf bases, as in the onion. At the apex of the stem is an embryonic shoot, having leaves upon it, and bearing a terminal flower ; in the axils of some of the scales are rudimentary buds.

In spring the flower-bearing stem grows from within the bulb and comes above ground, carrying with it the flower and two or three leaves, as indicated in Fig. 25. This development takes place at the expense of the food stored in the scales (ρ) : the latter therefore soon become soft, and at the end of the season shrivel up and decay. The leaves (e) on emerging from the soil turn green, and during the spring and summer manufacture a considerable amount of food ; that part of it

not needed for the plant's immediate requirements is transferred to lateral axillary buds below ground, and is there stored. These buds consequently grow rapidly and become young daughter bulbs; one of them is shown at *n* in course of development.

Bulbs like the onion, tulip, and hyacinth, which have broad, concave scales arranged in such a manner that the outer ones completely enclose those within, are known as *tunicated* bulbs. In lilies the bulb scales are not so broad, and are arranged to overlap each other like the tiles on a roof: such bulbs are said to be *imbricated*.

Ex. 32.—Cut a longitudinal section through a young onion plant when the bulb is well formed. Watch the development of a young plant into an old bulb. Cut sections of a mature onion bulb and compare its internal structure with that of a Brussels sprout.

Ex. 33.—Examine old onion bulbs which have been kept all winter and allowed to sprout. Note the number of separate sets of green leaves produced by it. Cut it open and examine the origin of the latter.

Ex. 34.—Cut longitudinal sections of tulip, hyacinth, snowdrop, and narcissus bulbs. Note the stem, the number of scales, and their relative thickness in each; also the presence or absence of rudimentary flowers and axillary buds.

Ex. 35.—(1) Examine the structure of a crocus corm in autumn. Pull off the outer

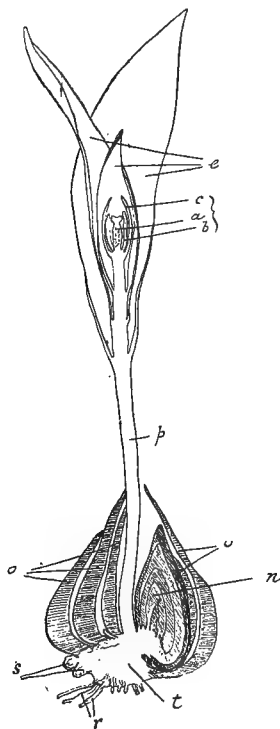

FIG. 25.—Section of a tulip in flower. *t* Stem on which are fleshy bulb scales, *o*; *b* flowering stem bearing green leaves, *e*; *a* ovary; *b* stamens; *c* perianth of the flower; *n* bud developing into a new bulb; *s* small dormant buds.

scaly leaves and observe the position and number of the buds on the thickened stem. (2) Cut longitudinal sections of a corm. (3) Examine a corm in bloom, and observe the roots, remains of old corms, foliage and membranous scale-leaves, and number and position of the flowers. Compare with Fig. 23.

RECOGNITION OF TREES BY MEANS OF TWIGS
IN WINTER.

The chief deciduous British forest and fruit trees and shrubs may be recognised in winter by the character and arrangement of the buds, as given below:—

GROUP I.

BUDS OPPOSITE EACH OTHER ON THE TWIGS (Fig. 26).

The following belong to this group:—

Dogwood.	Honeysuckle.
Mealy Guelder-Rose.	Elder.
Common do.	Sycamore.
Ash.	English Maple.
Spindle-Tree.	Norway do.
Privet.	Horse-Chestnut.
Buckthorn.	



FIG. 26.—Twig of Sycamore showing opposite arrangement of buds.

1. Buds naked, *i.e.* without protecting bud-scales.

(a) Young twigs, smooth, slender, and blood-red in colour.

Dog-wood: Wild Cornel (*Cornus sanguinea* L.).

(b) Twigs with a powdery grey covering consisting of stellate hairs.

Mealy guelder-rose: Wayfaring-tree (*Viburnum Lantana* L.).

2. Visible bud-scales few (one or two).

(a) Bud-scales sooty black.

Ash (*Fraxinus excelsior* L.). Twigs smooth, greenish-grey; terminal bud much larger than the round lateral ones.

(b) Bud scales pinkish.

Common guelder-rose (*Viburnum Opulus* L.). Young twigs with longitudinal ridges or angles, especially near their tips; lateral buds closely pressed to stem.

3. Several bud-scales visible; closely and compactly arranged.

(a) Twigs slender, bright sage green.

Spindle-tree (*Euonymus europæus* L.). The bud-scales are green, with pinkish margins and tips.

(b) Twigs slender; grey, brownish-grey, or brown; all buds small and similar in size, including the terminal ones.

* Bud-scales smooth.

Buckthorn (*Rhamnus catharticus* L.). Many of the branches

terminate in a thorn: the buds of the shrub are not always opposite; bud-scales dark reddish-brown.

Privet (*Ligustrum vulgare* L.). Without thorns; buds much smaller than the preceding, and their scales dark olive-brown; leaves often remain on all winter.

** Bud scales hairy, especially at the tips.

Common maple (*Acer campestre* L.). The twigs are stiffer than the two preceding shrubs; hairy when young; older parts of bark with longitudinal cracks or fissures.

(c) Twigs stiffer and thicker; terminal buds usually much larger than the lateral ones.

Horse-chestnut (*Aesculus Hippocastanum* L.). Buds brown in spring, covered with a sticky resinous substance; large triangular leaf-scar.

Sycamore (*Acer Pseudo-platanus* L.). Bud-scales yellowish-green with dark-brown margins and tips; leaf-scar well marked.

Norway maple (*Acer platanoides* L.). Bud-scales pinkish or reddish-brown, sometimes greenish at their bases; leaf-scar narrower than in sycamore.

4. Several bud-scales visible, very loosely arranged.

Elder (*Sambucus nigra* L.). Twigs pale brownish-grey, with longitudinal ridges and distinct lenticels; bud-scales brownish-red and puckered; very wide spongy pith.

Honeysuckle (*Lonicera Periclymenum* L.). The young twigs which climb up and wind round supports are shining and cylindrical, with a hollow pith. Bud-scales brownish-green.

GROUP II.

BUDS ALTERNATE; ARRANGED IN TWO LONGITUDINAL ROWS ON OPPOSITE SIDES OF THE TWIGS (Fig. 27).

The following belong to this group:—

Spanish chestnut.		Elms.
Limes.		Beech.
Hazel.		Hornbeam and (Birch).

1. Buds roundish-oval: each about twice as long as broad.

(A) Visible bud-scales few (one or two).

* Young twigs with longitudinal ridges or angles.

Spanish chestnut (*Castanea vulgaris* Lam.). Twigs deep red or reddish-green, straight: the buds are placed not immediately above the distinct leaf-scar, but slightly on one side.

** Young twigs cylindrical; one large and one small bud-scale to each bud.

Common lime (*Tilia vulgaris* Hayne). Twigs smooth, blood-red or orange-red, with a shining surface, somewhat long and bowed.

Small-leaved lime (*T. parvifolia* Ehrh.). Similar to the preceding species, but bark lighter colour and a smaller tree.

Broad-leaved lime (*T. platyphyllos* Scop.). Twigs slightly hairy: a larger tree than *T. parvifolia* Ehrh.

(B) **Several bud-scales visible.**

* Buds flattened on one side; bud-scales pale, brownish, or reddish-green.

Hazel (*Corylus Avellana* L.). Young twigs hairy and with a few stalked glands.

** Buds rounder and more pointed; bud-scales dark brown or dark maroon.

Common elm (*Ulmus campestris* Sm.). Young twigs more or less hairy; older twigs with fine rich brown-coloured fissures on the bark. A variety (*U. suberosa* Sm.) with longitudinal thick ridges of cork is met with.

Wych elm (*U. montana* With.). Twigs and buds similar to the preceding, but twice or three times the size. The leaf-scars are large.

2. **Buds pointed, often three or more times as long as broad.**

Beech (*Fagus sylvatica* L.). Twigs slender, smooth; the buds are usually over half an inch long, round in section, and jut out from the stem.

Hornbeam (*Carpinus Betulus* L.). The buds lie closer to the stem, and are not nearly so long as those of beech; they are also slightly angular in section.

Birch possesses twigs and buds somewhat similar to Hornbeam, and although it belongs to Group III., it sometimes has buds nearly arranged as in Group II., and may be noticed here.

Birch (*Betula alba* L.). The twigs are slender and elastic: in some varieties they are hairy, in others covered with small resinous tubercles.



FIG. 27.—Twig of Spanish chestnut showing alternate arrangement of buds.

GROUP III.

BUDS ARRANGED SPIRALLY ON THE TWIGS (Fig. 28).

To this group belong :--



FIG. 28.
Twig of Plum
tree, showing
spiral arrange-
ment of buds.

Birch.	Plums.
Walnut.	Cherries.
Oaks.	Pear.
Willows.	Apple.
Poplars.	Black Currant.
Alder.	Red Currant.
Wild Service.	Gooseberry.
White Beam.	Raspberry.
Mountain Ash.	Blackberry.
Hawthorn.	Barberry.
Blackthorn.	

1. Pith divided into chambers.

Walnut (*Juglans regia* L.). Young twigs thick, leaf-scars very large. Lateral buds small, round, black and smooth, the terminal one much larger and hairy.

2. Buds naked, *i.e.* without protecting bud-scales.

Black alder (*Rhamnus Frangula* L.). Young twigs reddish.

3. Buds distinctly stalked.

(a) Apparently only one bud-scale visible.

Alder (*Alnus glutinosa* Gaert.). Young twigs irregularly triangular in section, brown or reddish-brown in colour. The buds are angular, dark brownish-red, and their stalks $\frac{1}{4}$ -inch or more long.

(b) Several bud-scales visible.

Black Currant (*Ribes nigrum* L.). Twigs smooth, pale brown or pale greyish buff; buds plump, round, blunt at tips, bud-scales dark pink or brownish-pink, sometimes greenish. With aid of a lens yellow glands are visible on the bud stalks and scales.

Red Currant (*Ribes rubrum* L.). Twigs with loose, fluffy, ashy grey bark; buds thinner, longer, and more pointed than black currant; their scales dark chestnut brown, with fine woolly hairs.

4. **Buds sessile, with apparently only one large bud-scale (really two united).**

Willows (*Salix* Sp.). The willow hybridises so freely that it is impossible to distinguish all of them by characters of the buds and twigs alone.

The following, however, may be mentioned :—

Those with hairy buds :—

Osier (*Salix viminalis* L.). Buds of unequal size ; older twigs smooth and shining.

Sallow (*S. cinerea* L.). Very soft hairy twigs and large buds.

White Willow (*S. alba* L.). Very small buds ; older twigs reddish-grey and dull.

Those with smooth buds :—

Crack or Redwood Willow (*S. fragilis* L.). Twigs brown and polished ; buds almost black.

Bay-leaved Willow (*S. pentandra* L.). Similar to above, but buds brown.

Rose Willow (*S. purpurea* L.). Very long pointed buds.

Great Sallow (*S. caprea* L.). Short, plump, yellowish or reddish buds.

5. **Buds sessile, each with several visible bud-scales.** Twigs with spines (hairs and emergences) upon them, but no spiny branches present.

(a) Spines straight, situated just below the buds only.

Gooseberry (*Ribes Grossularia* L.). Twigs round, light yellowish-grey ; buds pointed and slightly stalked.

Barberry (*Berberis vulgaris* L.). Young twigs, with slight longitudinal ridges, thin ; buds bluntish at tips, and sessile.

(b) Spines with stout bases, tips bent backwards usually, and irregularly arranged on the twigs.

Wild Dog-Rose (*Rosa canina* L.). Twigs round ; buds smooth, roundish, blunt-tipped.

Blackberry (*Rubus fruticosus* L.). Twigs angular ; buds hairy, longer, and more pointed ; spines very irregularly placed.

(c) Many small soft spines, and hairs on twigs.

Raspberry (*Rubus Idæus* L.). Twigs pale reddish or yellowish-brown, shining ; bud-scales loosely arranged.

6. **Buds sessile ; several bud-scales visible.**

(a) Bud-scales green, with narrow brown edges.

Wild Service Tree (*Pyrus torminalis* Ehrh.). Buds oval, bluntish tips, smooth, and somewhat flattened on one side.

White Beam (*Pyrus Aria* Sm.). Buds hairy at tip, longer than the preceding, and pointed ; bud-scales keeled.

- (b) Bud-scales black or dark purple.
Rowan-tree or **Mountain Ash** (*Pyrus Aucuparia* Gaert.). Buds large, often $\frac{1}{2}$ inch long or more.
- (c) Bud-scales hairy all over.
White Poplar (*Populus alba* L.). Young twigs covered with a white, loose cottony film: older ones smooth, yellowish-grey: buds plump and pointed.
Apple or **Crab** (*Pyrus Malus* L.). Twigs partially hairy; small wood-buds on long shoots closely pressed to stem and triangular in outline. In the wild or crab-apple short branches ending in a "thorn" are present.
- (d) Bud-scales smooth or hairy only at the tips or margins.
- (1) Several buds crowded at the tips of the long shoots.
Common English Oak (*Quercus pedunculata* Ehrh.). Young branches greyish-brown, without hairs and furrowed. The buds stand out from the stem, are yellow or chestnut-brown colour, quite smooth, plump, and rounded at the tips.
Durmast or **Sessile Oak** (*Quercus sessiliflora* Salis.). Young branches slightly hairy; buds longer than the preceding, and their scales tipped and edged with hairs.
- (2) Long narrow-pointed buds, chestnut-brown in colour, and covered with resin at tips; twigs furrowed.
Black Poplar (*Populus nigra* L.). Bud-tips straight or pointing outwards.
Aspen (*Populus tremula* L.). Tips of the buds pressed close to stem.
- (3) Buds dark brown; leaf-scar a narrow crescent.
Pear (*Pyrus communis* L.). Twigs smooth, yellowish-brown; not hairy. In wild pear short branches terminating in "thorns" are present.
Hawthorn or **White Thorn** (*Crataegus oxyacantha* L.). Twigs greyish-purple or greenish-grey; buds paler than the pear and rounder; usually two together—one large, the other smaller. Generally spiny branches are present at the side of the buds.
- (4) Buds dark brown; leaf-scar rounder, almost a semicircle.
 * Buds small and round.
Sloe or **Blackthorn** (*Prunus spinosa* L.). Young twigs smooth, greyish-brown; older ones black. Buds very small, usually two or three together.
 ** Buds larger and conical.
Apricot (*Prunus armeniaca* L.). Young twigs greenish-

brown or reddish-green, smooth and shining; usually three buds together above leaf-scar.

Bullace (*Prunus insititia* L.). Young twigs hairy; older ones smooth and dark brown. Bud-scales hairy.

Wild Plum (*Prunus domestica* L.). Young twigs smooth, reddish or purplish brown.

*** Buds oval.

Bird Cherry (*Prunus Padus* L.). Young twigs thinnish, reddish-brown. Buds large ($\frac{1}{4}$ inch long and more) and pointed. Bud-scales chestnut-brown, keeled, mucronate tip.

Gean: Bigarreau and Hearts (*Prunus Avium* L.). Twigs stout and short, reddish-brown and grey. Buds large and crowded on short shoots. Bud-scales chestnut-brown; not keeled.

Dwarf Cherry: Morello and Kentish (*Prunus Cerasus* L.). Twigs thin and slender, yellowish or greenish-brown and grey. Buds smaller ($\frac{1}{8}$ inch long).

Mahaleb (*Prunus Mahaleb* L.). Buds smaller and not so plump as the dwarf cherry: stand closer to the stem. Twigs similar in colour.

CHAPTER V

THE LEAF.

1. As previously noted leaves arise in all cases from buds, and are side or lateral appendages of the stems of plants. They may be of many forms but are generally flattened structures, and, with the exception of those known as floral leaves, usually have buds in their axils. Their growth differs from that of the stem and root in being of short duration, for after reaching a certain size their increase ceases.

2. **Foliage-leaf.**—Those which are most conspicuous upon plants are green and are designated foliage-leaves. They are important organs generally concerned with the manufacture of food needed by the growing part of the plant, and are also organs from which much of the water taken from the soil by the roots is given off into the air. A typical green foliage-leaf (Fig. 29) consists of the following parts—(i) a broad expanded portion termed the *blade* or *lamina*; (ii) a slender *stalk* or *petiole*; and (iii) a somewhat flattened basal *sheath* which connects the leaf to the stem.

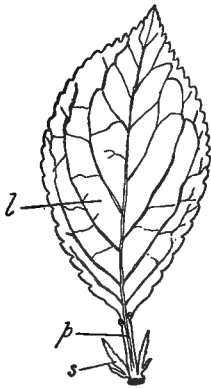

FIG. 29.—Foliage-leaf of plum. *l* Lamina or blade; *p* petiole; *s* stipule.

The leaf-sheath often bears two appendages—the *stipules*—which may be broad and wing-like as in the clovers and pea, or small and narrow as in pear and apple; leaves possessing them are said to be *stipulate*, while those without are *exstipulate*.

The parts of the leaf are of very varied form. In the grasses the *sheath* completely embraces the stem, and in the Umbelliferae (e.g. carrot, parsnip, and celery) it is very prominent; in many plants it is scarcely visible.

The *petiole* where present is usually narrow and cylindrical; frequently it is very short or missing altogether, in which case the leaf is described as *sessile*.

The *blade* is generally the most obvious part of a foliage-leaf and the points of importance to notice at present are its venation, outline, margin, apex, and character of its surface.

(a) *Venation of leaf-blade*.—The substance of the leaf is traversed by a number of woody strands which are termed veins or nerves, although it must not be inferred that they are similar in structure or function to the veins or nerves of animals. The *arrangement* of these strands is termed the *venation* of the leaf, of which there are two common types, namely (1) *parallel* and (2) *reticulate* or net-venation. In the first type the chief strands all run parallel to each other from the base of the leaf to the tip, as in the leaves of grasses, onion, hyacinth, lily-of-the-valley, and Monocotyledons generally.

In net-veined leaves the smaller very delicate strands form a fine net-work within the leaf and this arrangement is characteristic of Dicotyledons.

Of reticulate veined leaves two divisions are made according to the arrangement of the main strands. In one, the leaves have a central strand or mid-rib running down the middle of the leaf and from it are given off slightly smaller branch strands as in Fig. 29; such leaves are *pinnately* veined or feather-veined, those of the apple, plum, and peach are good examples.

In the other division each leaf has several strong strands which start from the base of the blade and spread across to its margins somewhat like the fingers of an outstretched hand; such a leaf is described as *palmately* veined. Ivy, sycamore, and currant leaves show this type of venation.

(b) *Forms of blade.*—The outline of the blade of the leaf may assume almost any geometrical figure (Fig. 30). When it is

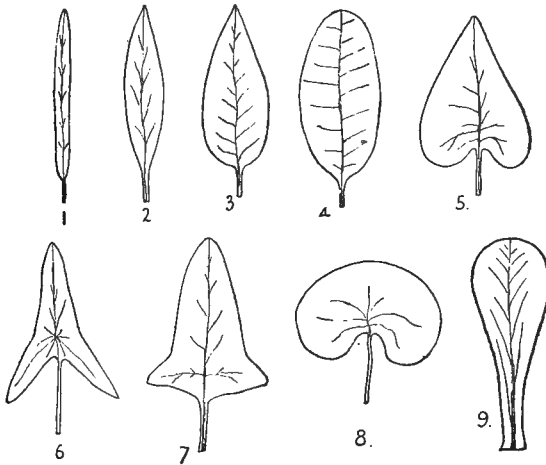

FIG. 30.—Common Forms of Leaves: 1, Linear; 2, lanceolate; 3, ovate; 4, elliptical; 5, cordate; 6, sagittate; 7, hastate; 8, reniform; 9, spathulate.

much elongated and narrow as in grasses it is termed a *linear* leaf. It may also be *lanceolate* as in the narrow-leaved plantain; *ovate* (egg-shaped); *elliptical*; *reniform* or kidney-shaped; *cordate* (heart-shaped); *sagittate* (arrow-shaped); *spathulate* (spoon-shaped) as in the daisy; and *hastate* (halberd-shaped) as in sheep's sorrel.

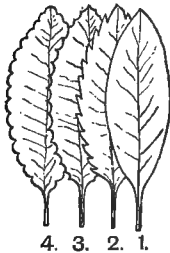

FIG. 31.—Leaf-margin: 1, Entire; 2, serrate; 3, dentate; 4, crenate.

(c) *Leaf-margin.*—The edge of the leaf-blade is sometimes *entire* as in privet; or variously indented with larger or smaller incisions. (Fig. 31.) Leaves having margins like the edge of a saw are *serrate*; when the small tooth-like incisions stand out at right angles to the edge of the leaf it is described as *dentate*; the term

crenate is used when the edge has small semi-circular prominences. If the indentations are deeper the leaf is then described as *lobed* (*-fid*), *parted* (*-partite*), or *dissected* (*-sect*) respectively, according as the divisions reach about one half, three quarters, or nearly the whole way down towards the midrib.

As the indentations follow the direction of the main strands or veins of the leaf we have two types of lobed, parted or dissected leaves namely:—(1) *pinnatifid* (1, Fig. 32) *pinnatipartite*, *pinnatisect* and (2) *palmatifid* (3, Fig. 32), *palmatipartite*, and *palmatisect*.

So long as the divisions of the blade do not quite reach to the main ribs the leaf is said to be *simple*; in many cases, however, the partitions are such that the leaf appears to have several distinct blades; it is then *compound*, and the separate parts are its *leaflets* (*t*, Fig. 32).

Compound leaves are either *pinnate* as in pea, vetch, potato, rose and ash; or *palmate* as in clover, horse-chestnut, and lupin.

(d) *Surface*.—The surface of the blade is smooth or *glabrous*, or sometimes covered on one or both sides with hairs.

(e) *Apex*.—The tip of the leaf when it is pointed is *acute*; when drawn out to a longer point it is *acuminate*: it may also be *obtuse* (blunt), *emarginate* (notched), or *mucronate*; in the latter case the midrib appears to project as a sharp point—see leaves of lucerne (Fig. 133) and trefoil.

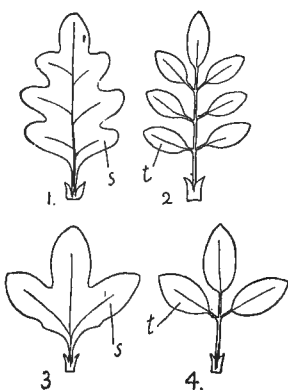

FIG. 32.—1. Simple pinnatifid leaf, *s* lobe. 2. Compound pinnate leaf; *t* leaflet. 3. Simple palmatifid leaf; *s* lobe. 4. Compound palmate leaf; *t* leaflet.

Ex. 36.—Examine and describe the leaves of the chief farm plants and as many of the common weeds as possible. Observe first if they are simple or

compound, then note the presence or absence of stipules and petiole, after which describe their form, margin, apex, and surface.

3. Modified Leaves.—Structures are often met with upon plants which although they do not possess all the parts of a foliage leaf as just described, are, nevertheless to be regarded as leaves on account of their origin and position upon the plant, and also by the fact that they frequently bear buds in their axils, and under some circumstances may become changed into ordinary green leaves. Several of these modified leaves receive special names as indicated below, according to their position upon the stem, or according to their texture, colour, and other peculiarities.

(a) *Cotyledons* or *seed-leaves*.—These are the first leaves which a flowering plant possesses, and are nearly always simple and entire, and without stipules.

Some coniferous trees (pines and firs) have seedlings with several cotyledons, but dicotyledons usually possess only two (Figs. 5, 103, 110), while in monocotyledonous plants only one is present.

In the bean, pea, and vetch they serve merely as storehouses for the food upon which the seedling depends for its early growth. In the cereals and grasses generally, the chief work of the cotyledon is to absorb the endosperm of the seed, and transfer it to the growing-points of the young root and shoot; while in the turnip, mangel (Fig. 110) and many other plants they come above ground and carry on the work of 'assimilation,' thus behaving as ordinary foliage-leaves.

(b) *Scales*.—These are usually thin membranous leaf-structures, generally brown, white, or yellowish in colour, and may be either complete leaves, or merely the sheaths and stipules of leaves the blades of which have not developed.

On the stems above ground they are often present as coverings to the buds of trees and shrubs, acting as a protection for the interior of the bud against frost, heat, rain, and the attacks of

insects. Scales are always present upon the underground stems of perennial plants, and vary much in size. Upon the rhizomes of couch-grass and potato, they are small and membranous, while the leaves of a resting bulb are large scales, some of which are thick and fleshy, and stored with food.

(c) *Bracts and Bracteoles*.—The leaves which occur upon the stem at points where the flowers and inflorescences arise are termed *bracts* and *bracteoles* (see p. 89). They are very variable in size, texture and colour. In some plants they cannot be distinguished from the ordinary green foliage-leaves except by their position; more often they are rudimentary leaves somewhat resembling scales. The chaffy bracts surrounding the flowers of grasses are termed *glumes*. In Arum, Iris, Narcissus, and snowdrop, a large bract, termed a *spathe*, encloses the whole inflorescence.



FIG. 33.—A single compound leaf of pea: *st* Stipule; *l* leaflet; *t* tendril.

The cup of the acorn and the husk of the filbert and hazelnut are persistent united bracts.

Bracts are sometimes brightly coloured.

(d) *Floral leaves*.—The special leaves constituting the chief parts of a flower are termed *floral leaves* (see next chapter).

(e) *Leaf-spines*.—In the sloe and other shrubs and trees certain branches are found which have been modified into short, stiff spines. That the latter are branches or shoots is seen from the fact that they frequently bear small leaves and buds.

In some plants however, such as hawberry, the spines are evidently not branches, but modified leaves, for buds and stems frequently appear in their axils, and in the former plant all stages of transition between an ordinary green leaf and a branched spine are frequently observable on the same plant.

(f) *Leaf-tendrils*.—In the vetch and pea (Fig. 33) the terminal leaflets, instead of being green, are modified into thin, thread-like structures termed *tendrils*. They are sensitive to contact and wind round any small object which they touch.

In some plants, such as the vine and passion-flower, the tendrils are not leaves but modified branches.

Ex. 37.—Examine the cotyledons of the seedlings of weeds springing up on garden soils and arable ground. Note the difference between these and the first foliage-leaves.

Examine the cotyledons of seedlings of the common farm crops.

Ex. 38.—Examine the scales of an onion, tulip, and lily bulb, and those upon the underground stems of couch-grass and other plants.

Ex. 39.—Examine the spines on a gooseberry bush. Do they belong to the leaves or are they modified shoots?

Note both the leaf-spines and stem-spines upon ordinary gorse.

Compare with Ex. 29.

Ex. 40.—Note the form and position of the tendrils of a vetch and pea, both when free and when wound round a support.

4. *Leaf-arrangement*.—Although to a casual observer the leaves appear to be without any regular arrangement upon a plant, careful inspection shows that they are distributed on the stems in a very definite order, which is usually constant for each species.

In some, such as the sycamore (Fig. 14), dead-nettle, and cleavers, two or more leaves arise at the same node of the stem. Each collection of leaves is then called a *whorl*, and the

individuals comprising it are always separated from each other by regular angular intervals. Thus, if two leaves are present they are half the circumference of the stem apart or exactly opposite each other, and not both on the same side; if three arise at the same node, they are separated from each other by regular intervals of 120 degrees, or one-third of the circumference, and so on for any number of leaves.

On many stems the leaves are not in whorls but scattered singly along it, only one leaf arising at each node: such an arrangement is spoken of as *alternate* or *spiral*. A line drawn from the bottom to the top of a shoot in such a manner that it touches the base of each successive leaf is a spiral. The distances between the leaves measured *along* the stem are variable, some being an inch apart, others two or more; their *angular intervals* apart are, however, as definite and regular as in plants with the whorled arrangement.

The *divergence* or angular distance is usually expressed in fractions of the circumference. In elm, spanish chestnut and grasses, it is $\frac{1}{2}$, that is, the spiral in passing from one leaf to the next winds half round the stem. In birch it is $\frac{1}{3}$, while in pear and plum the angular distance is $\frac{2}{5}$ of the circumference.

The divergences most frequently met with are, $\frac{1}{2}$, $\frac{1}{3}$, $\frac{2}{5}$, $\frac{3}{8}$, and $\frac{5}{13}$. On inspection these spirally arranged leaves are seen to be in straight longitudinal rows along the stems; plants with a divergence of $\frac{1}{2}$ having two rows, those with $\frac{1}{3}$ three rows, and those with $\frac{2}{5}$ five rows, and so on, the denominator or lower figure of the above fractions indicating the number of rows present.

If any particular leaf in a row is selected and the spiral traced round the stem touching each successive leaf until another leaf is reached on the same row, the number of leaves touched, not counting the one at which we start, is equal to the number of the denominator of the fractions expressing the angular divergence, and the numerator indicates the number of com-

plete turns round the stem which the spiral line traces. For example, the angular divergence of the leaves on a pear shoot is $\frac{2}{5}$: selecting any one leaf as a starting point, the spiral line passes twice round the stem by the time that it reaches the next leaf on the same row, and in doing so touches the bases of five leaves. To determine the leaf-arrangement upon any particular shoot, it is necessary to observe the bases of the leaves and not the blades, as the position of the latter is affected by external conditions, especially by light and the force of gravitation. Occasionally the stems become twisted during growth, and the leaves are consequently displaced from their normal position.

The orderly arrangement of the leaves upon stems is dependent on the internal forces of the living plant. By growing in this manner all the leaves become equally exposed to light and air, and interfere very much less with each others requirements in this respect, than would be the case if the leaves were disposed irregularly.

Ex. 41.—Examine and describe the leaf-arrangement upon the shoots of all common farm plants, trees, and weeds.

5. Bud-arrangement.—As buds arise normally in the axils of leaves, it follows that the arrangement of buds upon trees in winter will be similar to that of the leaves during the previous summer. A careful recognition of the position and arrangement of buds upon the shoots of plants is of some importance in the practice of pruning, where buds are required to produce branches growing in some particular direction.

For the arrangement of the buds upon the chief shrubs and trees, see pp. 61-66.

6. Leaf-fall: 'Evergreens.'—In most of the broad-leaved trees and shrubs of temperate regions the leaves produced from buds in spring usually last only one growing-season, and then all fall off before the plants enter a state of rest in the following winter.

A number of shrubs and trees, however, appear clothed with green leaves at all times of the year. These are described as *evergreen*. In such plants the leaves produced from buds in spring are not shed in the following autumn or winter, but live sometimes several seasons before they die and fall off. The length of time during which the leaf remains on a so-called evergreen tree after it is produced depends upon the kind of tree, the climate, situation, soil and other conditions.

In privet the leaves often remain on the twigs during winter, and fall off when the new buds open in spring; while in some conifers the leaves are not shed until they are ten years old or more.

The leaf usually separates from the shoot bearing it, at a point close up to the latter, and a more or less conspicuous mark, termed the *leaf-scar*, is left upon the shoot. The dangerous effects of an open wound is prevented by the formation of a protective layer of cork over the surface of the scar, which layer originates some time before the actual fall of the leaf.

Leaf-fall is not merely the dropping off of dead, withered leaves, but a distinct physiological process, which does not take place in leaves which are prematurely killed by the action of frost or excessive heat. Moreover, the leaves do not fall off from branches of trees and shrubs broken or cut off, in early summer.

Ex. 42.—Observe the manner of leaf-fall upon the common shrubs and trees, paying special attention to those with compound leaves, such as ash and horse chestnut.

Note the form and size of the leaf-scars.

Try and determine how long the leaves persist upon box, laurel, privet, holly, silver-fir, Scotch pine, and other common evergreen shrubs and trees.

CHAPTER VI.

THE FLOWER.

1. THE root stem and green leaves which have been under consideration in the last three chapters are termed the *vegetative organs* of the plant. Although our attention has been chiefly directed to their morphology or origin, form and relationship to each other, it may be remarked that the work which these organs perform, for the benefit of the plant, is principally concerned with the maintenance of the life of the individual which bears them.

2. Sooner or later, however, flowers arise upon the plant, the special function of which is reproduction: in them seeds are produced containing embryos capable of developing into a new generation of plants when opportunity offers.

Before discussing the work of the flower it is necessary to become acquainted with the form and arrangement of its parts, and for this purpose it is advisable to begin with the study of a simple example such as a buttercup. A section through the latter is given in Fig. 34. In the centre of the flower is seen a stem-like axis (*r*) which is a continuation of the *peduncle* or flower-stalk. This is the *receptacle* of the flower and upon it is arranged a considerable number of lateral appendages of which there are four distinct forms present. The lowermost of these appendages, that is, those farthest away from the apex of the receptacle, are yellowish-green in colour and resemble boat-shaped scales (*m*). There are five of them free from each other and arranged in a whorl: each is termed a *sepal*, and the whole collection or whorl is known as the *calyx* of the flower.

Immediately above the sepals, and alternating with them, are five bright yellow heart-shaped leaves (n); these are the *petals*, the whole collection of which is termed the *corolla* of the flower.

Next to the whorl of petals are the *stamens* (s), of which there are a large number. Each consists of a thin thread-like stalk surmounted by a swollen and elongated tip. In the buttercup the stamens are not arranged in a whorl but in the form of a closely wound spiral round the receptacle; the whole collection of them is the *androeium* of the flower.

Occupying the highest position upon the receptacle is a series of small, green, flask-shaped bodies (c); they are hollow and it

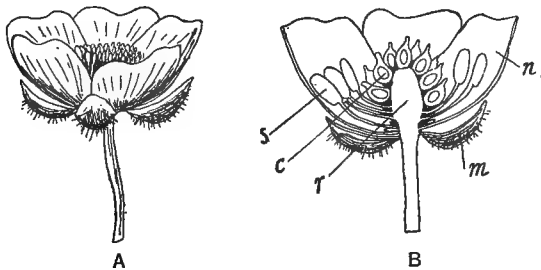

FIG. 34.—A, Flower of Buttercup (*Ranunculus acris* L.). B, Vertical section through the same. r Receptacle of the flower; n sepal of the calyx; n petal of the corolla; s stamen of the androeium; c carpel of the gynaeium.

is within them that the seeds of the plant are produced. Each is termed a *carpel*, and the whole collection is known as the *gynaeium* or *pistil* of the flower.

3. Although the flower of a plant appears different in many respects from anything we have yet examined it is in reality a form of simple shoot or a stem with leaves upon it. The whole of its parts, however, have been modified to serve the purpose of seed production, and at first sight its likeness to a simple vegetative shoot is not appreciated.

That a flower is essentially equivalent to a simple shoot with

very short internodes is, however, apparent from a study of its origin and position upon the plant and also from an examination of abnormal or *monstrous* flowers which occasionally occur.

A flower always occupies the position of a shoot; it arises either at the apex of a stem or in the axil of a leaf. Its receptacle, which normally ceases growth in length at an early period, occasionally grows on through the centre of the flower and develops into an ordinary leafy vegetative shoot.

The sepals, petals, stamens and carpels occupy the position of leaves upon the receptacle or axis of the flower; they are lateral appendages of the receptacle and are termed *floral leaves*. Moreover, the leaf-like character of the sepals and petals is generally obvious, and in so-called '*double flowers*' some or all of the stamens and carpels assume the appearance of petals.

4. Arrangement, Symmetry and Number of Floral Leaves.—When the whole of the floral leaves are arranged in whorls, the flower is said to be *cyclic*: if they are inserted in a spiral line on the receptacle, the flower is described as *acyclic*. The term *hemi-cyclic* is applied to those flowers which like the buttercup have some of their floral leaves in whorls and others in spirals.

Generally the successive whorls alternate with each other: the petals for example are not opposite to the sepals, but occupy the spaces between the latter; the stamens alternate with the petals and the carpels with the stamens.

Very often the individual members of each separate whorl in a cyclic flower are all alike in shape and size; such a flower is *regular*, while those in which this is not the case, as in the pea and violet, where some of the petals are larger than the rest, the flower is *irregular*.

All those flowers which can be divided into two equal and similar halves by a plane passing through the axis of the receptacle are *symmetrical*. Usually regular flowers can be divided into two halves by planes passing through the axis in several different directions: they are designated *actinomorphic* flowers, examples

of which are chickweed, poppy and wallflower. Those which can be cut into two equal halves in one direction only are *zygomorphic*; for example vetch, pea and dead-nettle.

The number of members constituting each whorl in a flower is subject to much variation, but it will frequently be observed that in Monocotyledons each whorl consists of *three* floral leaves or some simple multiple of three (such as six or nine). In Dicotyledons the floral leaves are usually in *fours* or *fives*.

The pattern flower just described consists of four distinct kinds of floral leaves and is termed a *complete* flower. Sometimes flowers are met with in which one or more entire sets of floral leaves are missing—either calyx, corolla, andrœcium or gynœcium; such are spoken of as *incomplete* flowers: examples are seen in the mangel and ash.

5. **The Receptacle.**—In the Buttercup the receptacle is an elongated cylindrical or conical axis and the whorls of floral leaves are arranged upon it at successively higher levels, the gynœcium occupying the highest and the calyx the lowest points respectively, with the corolla and andrœcium between. In many cases the receptacle is thicker and not so long as that of the buttercup, but the relative positions of the parts upon it is the same. Flowers which like the buttercup have the corolla and andrœcium inserted on the receptacle at a lower level than the gynœcium and free from the latter are termed *hypogynous* flowers, and the gynœcium is described as *superior* (1, Fig. 35); examples are charlock, poppy and chickweed.

In the plum the apex of the receptacle ceases to grow at an early stage, but the parts below the apex grow up all round it and form a hollow basin or urn-shaped structure, on the edge of which the calyx, corolla and stamens are arranged (Fig. 124).

The gynœcium, consisting of a single free carpel, is placed at the bottom of the hollow receptacle (2, Fig. 35), this point being the real apex of the floral axis.

Flowers in which the corolla and andrœcium are arranged on

the edge of a more or less hollow receptacle, surrounding the free gynæcium, are *perigynous* and the gynæcium is said to be *superior* as in hypogynous flowers. The flowers of plum, cherry, strawberry, are examples: in the strawberry, the part of the receptacle which bears the gynæcium is a solid lump, but round the latter the rest of the receptacle forms a flattish rim on which the petals and stamens are borne (Fig. 125).

In some flowers the receptacle appears to be hollowed out as in the plum, but the carpels instead of being free from it are closely invested by its walls and completely adherent to the latter, so that the receptacle and gynæcium appears to be one structure: the ovaries of the carpels are imbedded in the receptacle, and

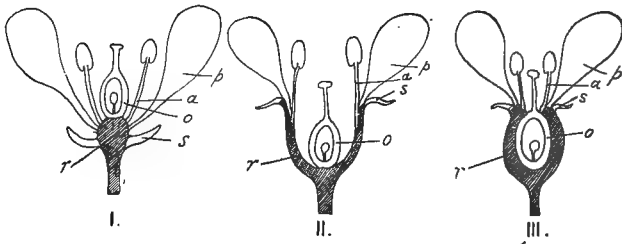

FIG. 35.—Diagrammatic vertical section through—I. a hypogynous flower; II. a perigynous flower; and III. through an epigynous flower. *r* Receptacle; *s* sepal of calyx; *p* petal of corolla; *a* stamen of andræcium; *o* the gynæcium.

only their stigmas and upper parts are free and exposed. In such flowers the sepals, petals and stamens, seem as if they were produced on the upper part of the gynæcium, or its ovary, although in reality they spring from the receptacle which encloses and is completely united with the latter. Flowers of this type are described as *epigynous*, and the gynæcium is *inferior* (3, Fig. 35). Examples are seen in the apple, pear, gooseberry and carrot. The exact limits of the receptacle and the gynæcium cannot be seen or understood in fully developed flowers, and in many cases uncertainty exists in regard to them. The above description and

diagram (Fig. 35), however, are sufficient to enable students to distinguish epigynous flowers from hypogynous or perigynous ones.

6. **Non-essential parts of the flower: the Perianth.**—The calyx and corolla whorls of floral leaves together constitute the *perianth* of the flower, and as they are not directly concerned in the production of seeds are termed the *non-essential parts* of the flower.

When one of the whorls of the perianth is absent as in the mangel, male hop, and anemone, the flower is spoken of as *monochlamydeous*; if both calyx and corolla are absent, as in the ash and willow, the flower is *naked* or *achlamydeous*.

(i) **The Calyx.**—The Calyx forms a protective covering for the rest of the flower when the latter is still young, and may either fall off when the flower opens, in which case it is *caducous*, or remain attached to the receptacle for an indefinite period, when it is described as a *persistent* calyx. It is usually green but may assume some other colour, in which case it is spoken of as *betaloid*.

A calyx which consists of free separate sepals, as in the buttercup, is termed *polysepalous*; those in which the sepals are united, as in the primrose and pea, are said to be *gamosepalous*.

In groundsel, thistle, and other plants belonging to the Compositæ, the calyx takes the form of a ring of hair known as a *pappus* (Fig. 148), which generally develops rapidly after the corolla has faded and acts as a float for the distribution of the seed-case by means of the wind.

(ii) **The Corolla.**—This part of the flower is usually of bright colour and serves mainly as an attraction for insects. When the petals forming it are free from each other, as in the buttercup and rose, the corolla is *polypetalous*; the term *gamopetalous* is applied to corollas which are composed of united petals, as in the primrose and Canterbury bell.

7. **The essential parts of the flower.**—The andrœcium and

gynæcium are directly concerned in the production of seed, as explained hereafter (Chap. xxii.), and are termed the *essential parts* of a flower.

(i) **The Andrœcium** consists of stamens, each of which, as previously stated, is a modified form of leaf, although its appearance and structure is very different from the petals and sepals of the perianth.

A stamen usually consists of a more or less elongated thread-like portion—the *filament*—surmounted by a swollen thicker part termed the *anther* (Fig. 36).

The anther consists of two somewhat elongated halves or *anther-lobes* (*a*), which are situated usually on opposite sides of the upper part of the filament: the part of the filament uniting the anther-lobes is termed the *connective* (*c*).

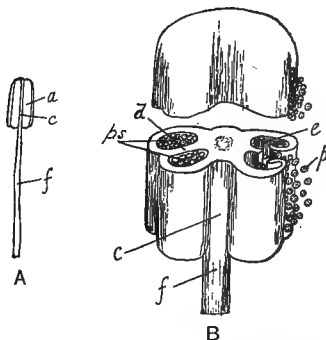

FIG. 36.—*A*, A common form of stamen. *f* The filament; *a* anther-lobe; *c* the connective. *B*, View of stamen showing internal structure. *f* Filament; *c* connective, on each side of which are the anther-lobes; *bs* pollen sacs, between which is a partition *d*, when the anther is young; on the right the anther-lobe has dehisced, setting free the pollen-grains *p*; *e* empty pollen-sac.

Running lengthwise in the interior of each anther-lobe are two chambers or hollow spaces named *pollen-sacs*, within which the *pollen* is produced usually in the form of loose round or oval *pollen-grains*. In a young state

the latter are completely enclosed in the anther-lobes, but in a longer or shorter time after the opening of the flower the partition between the pollen-sacs is ruptured and the anther-lobes open by longitudinal slits

along the line of union of the two pollen-sacs (*B*, Fig. 36), the pollen-grains being then set free in the form of dust-like powder.

In some cases the pollen-grains escape by pores or valve-like openings situated near the apex of the anther.

Most frequently the stamens of the andrœcium are distinct and completely free from each other as in the buttercup, but in some flowers *the filaments* of the stamens are united together and only the anthers are free. When all the filaments are united the stamens are described as *monadelphous*; if two or several separate bundles of united filaments are present the stamens are said to be *diadelphous* and *polyadelphous* respectively.

In the daisy, dandelion, and most plants belonging to the Compositæ, *the anthers are united* and the filaments are free; such stamens are termed *syngenesious*.

Stamens attached to the petals, as in the potato flower, are described as *epipetalous*.

(ii) **The gynœcium** is composed of carpels, each of which generally consists of three parts: (1) a swollen hollow basal portion termed the *ovary*, (2) a thin more or less elongated part called the *style*, at the apex of which is (3) the *stigma*.

The style is in many instances missing and the stigma is then sessile upon the upper part of the ovary.

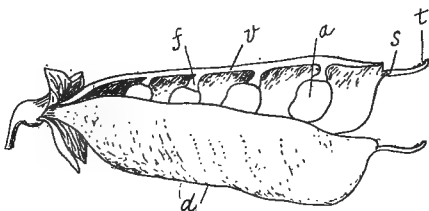

FIG. 37.—Pod of a pea (a single carpel). *v* The ventral suture; *d* the dorsal suture; *s* style; *t* stigmatic surface; *f* funicle of the seed; *a* seed.

Within the cavity of the ovary are small round or oval bodies termed *ovules*, which under certain circumstances to be mentioned later develop into seeds. The part inside the ovary on which the ovules are borne is termed the *placenta*.

The carpel may be considered as a leaf which has been folded along the midrib and united at its edges. The line corresponding to the united edges of the leaf is termed the *ventral suture* of the carpel, and it is along this line that the ovules are generally attached in two rows—one row belonging to each edge; the line corresponding to the midrib of the folded leaf is the *dorsal suture*.

These parts are readily seen in the pod of a pea (Fig. 37), which bears considerable resemblance to a folded green leaf.

The gynæcium may consist of separate carpels as in the buttercup, in which case it is said to be *apocarpous*. Frequently the carpels are united and then form what is termed a *syncarpous* gynæcium (2, Fig. 38). The amount of union among the carpels varies, but very frequently their ovaries are completely united to form one common ovary: in such cases the styles are generally united to form one common style, the corresponding stigmas usually remaining free. When the carpels of the syncarpous

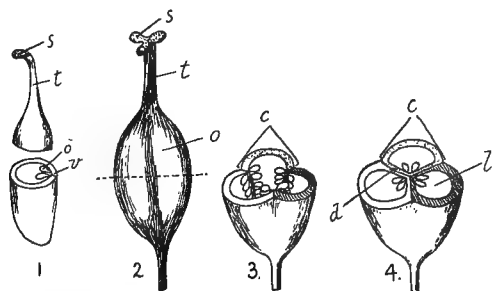

FIG. 38.—1. Gynæcium, consisting of a single carpel. *v* Ventral suture; *o* ovules; *t* style; *s* stigma. 2. Syncarpous gynæcium, consisting of three completely united carpels. *o* Ovary; *t* style; *s* stigma. 3. Transverse section of a syncarpous gynæcium which is unilocular. *c* The extent of one of the component carpels; the ovules are on parietal placentas. 4. Transverse section of a syncarpous gynæcium which is trilocular. *l* A loculus; *d* a partition or dissepiment; *c* the extent of a single component carpel; the ovules are on axile placentas.

gynæcium are united by their edges as at 3, Fig. 38 the ovary possesses only one cavity or *loculus*, and is said to be *unilocular*. In other examples the carpels are folded so that their edges meet in the middle of the ovary, the united parts forming partitions or *dissepiments* dividing up the common ovary into several cavities (4, Fig. 38); such ovaries are described as *multilocular*, and each loculus corresponds to a single carpel.

Occasionally the number of loculi inside an ovary does not

correspond with the number of carpels present in the latter, as dissepiments occur which are not formed from the united walls of two neighbouring carpels but which are produced by the growth inwards of a portion of the ovary wall. The latter are termed *false dissepiments*, an example of which is the septum which divides the ovary in the Cruciferae.

8. **Placentation.**—The *arrangement of the placentas* or points from which the ovules arise inside an ovary is termed *placentation*. When the ovules are arranged in lines on the wall of the ovary, as at 3, Fig. 38, the placentation is *parietal*.

In multilocular ovaries, such as at 4, Fig. 38, the ovules are generally arranged in the angles formed at the centre where the edges of the carpels are united, and the placentation is described as *axile*.

In the primrose and chickweed families of plants the ovules are attached to a placenta which arises in the form of a short column from the base of the ovary and has no connection with the sides: this arrangement is known as *free central* placentation.

9. **Monoclinous and diclinous flowers: monœcious and diœcious plants.**—When both the essential parts are present in the same flower, as in the buttercup, charlock, and the majority of common plants, the flower is described as *monoclinous*; sometimes the terms *perfect*, *hermaphrodite* or *bisexual* are applied to such flowers.

In certain flowers, as those of the cucumber, melon, hop, hazel, and willow, one or other of the essential parts are missing: such are said to be *diclinous*, *imperfect* or *unisexual*. Diclinous flowers may be of two kinds, namely, (1) those in which the andrœcium is alone present and described as *staminate* or *male* flowers, and (2) those in which only the gynœcium is met with and spoken of as *carpellary*, *pistillate* or *female* flowers.

When both kinds of diclinous flowers are met with on the same individual plant, as in the case of the cucumber and hazel, the plant is said to be *monœcious*; in examples, such as the hop

and willow where the two kinds of diclinous flowers are produced on separate individuals, the plants are spoken of as *diœcious*.

Ex. 43.—The student should examine a large number of flowers and specially note the peculiarities of the receptacle, calyx, corolla, andrœcium and gynœcium in each: note the arrangement of the ovules within the ovary.

He should also make himself thoroughly familiar with the terms employed in this chapter.

Ex. 44.—Examine the flowers of the bean, pea, cherry, buttercup, primrose, apple, anemone, vegetable marrow, cucumber, tomato, hyacinth, tulip, snowdrop, willow, hazel, ash, oak, sycamore, lime, oat, wheat, and any others at hand.

Determine which are monoclinous and which are diclinous. If diclinous, are the plants monœcious or diœcious?

CHAPTER VII.

THE INFLORESCENCE.

IN many plants the flowers are borne *singly and terminally* at the end of the main axis, as in the poppy, or *singly and laterally* in the axils of the foliage-leaves of the stem or its branches, as in pimpernel and ivy-leaved speedwell. Such flowers are described as *solitary*. In most instances, however, flowers are grouped more or less compactly together on a special shoot or axis of the plant, as in the hollyhock, foxglove and hyacinth; such a flower-bearing shoot with its flowers is termed an *inflorescence*, and the leaves upon it, in the axils of which the flowers arise, are known as *bracts* (see p. 73). The axis of the inflorescence is termed the *rachis* or *peduncle*, and the individual flower-stalks are called *pedicels* (*p*, Fig. 39), the leaf-like structures upon the pedicels being spoken of as *bracteoles* or *prophylla*.

A great variety of forms of inflorescence are met with differing in their manner of branching, the length and thickness of their axes, the presence or absence of pedicels, and in many other particulars. They are conveniently divided into two groups, namely (1) *racemose* or *indefinite*, and (2) *cymose* or *definite* inflorescences, in accordance with the principles of branching described on pp. 40 and 41.

I. Racemose Inflorescences.

In this type of inflorescence the main axis, or rachis, bears either lateral sessile flowers, or flowers with pedicels, developed in acropetal succession, that is, the youngest flowers are nearest

the apex and the oldest nearest the base of the rachis. If the flowers are sessile, or borne immediately on pedicels, that is, on lateral branches of the first order, the inflorescence is described as *simple* (Fig. 39); when the main axis branches more than once before bearing the flowers the inflorescence is *compound* (Fig. 41).

A. SIMPLE RACEMOSE INFLORESCENCES.—In these the main axis bears either sessile flowers or flowers with pedicels.

(i) *With elongated axis and sessile flowers.*

The *spike* (A, Fig. 39). Examples are seen in Greater Plantain (*Plantago major* L.) and *Verbena*.

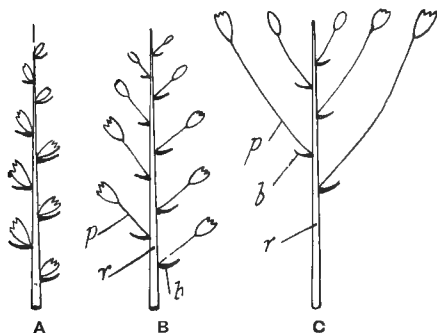

FIG. 39.—Racemose, or indefinite inflorescences, with elongated axis. A a spike; B a raceme; C a corymb; *b* bract; *r* rachis; *p* pedicel.

Parts of the inflorescences of most grasses are small spikes or *spikelets* (see p. 476).

The *spadix* is a form of spike with a thick, fleshy axis. Sometimes a large bract, termed a *spathe*, encloses this form of inflorescence, as in Lords-and-Ladies (*Arum maculatum* L.),

white 'Trumpet-Lily' (*Richardia*), and many palms.

The *catkin* is a spike-like inflorescence, which bears only unisexual flowers. Examples of catkins of staminate flowers are seen in the hazel and willow; catkins of carpellary flowers are found on the willow.

In some plants the catkins are compound inflorescences.

(ii) *With elongated axis and stalked flowers*—

The *raceme* (B, Fig. 39). In this form of inflorescence the flower-stalks or pedicels are of nearly equal length. Examples

are seen in the hyacinth, lily-of-the-valley, wallflower, snapdragon, mignonette, and currants.

The *corymb* (*C*, Fig. 39) has its pedicels of different lengths, those at the base of the rachis being longest, followed by pedicels of decreasing length upwards; all the flowers are nearly on the same level. Examples occur in candytuft.

(iii) *With shortened axis and sessile flowers*—

The *capitulum* or *head* (*A*, Fig. 40) possesses a short thick rachis termed the *receptacle* (*r*) upon which are a number of closely-packed, small, sessile flowers. Examples are seen in the

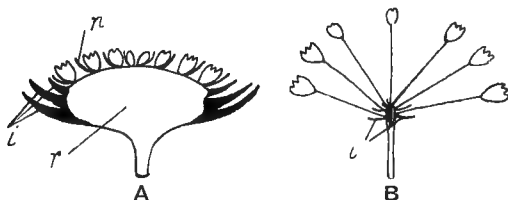

FIG. 40.—Racemose indefinite inflorescences with short axes.
A A capitulum; *r* "receptacle"; *i* involucre of bracts; *n* scale-like bracteole or palea. *B* Simple umbel; *i* involucre of bracts.

daisy, marigold, dandelion, groundsel, and all the *Compositæ* (Chap. xxxiii.).

Usually one or more dense whorls of bracts surround the whole head and are collectively termed the *involucre* of the capitulum: in many instances a small, scale-like bract termed a *palea* is also associated with each flower of the head.

(iv) *With shortened axis and stalked flowers*—

The *umbel* (*B*, Fig. 40). In this form the main axis is short and bears a number of flowers with stalks of similar length. Examples occur in ivy, cowslip, and onion.

B. COMPOUND RACEMOSE INFLORESCENCES.—In these the main axis does not bear sessile or pedicellate flowers directly, but bears lateral branches which are themselves inflorescences.

(i) *With elongated main axis*—

The *panicle* (*A*, Fig. 41). In this form of compound inflorescence the lateral branches of the main axis are racemes, or more complicated branched racemose inflorescences with stalked flowers. Examples occur in the vine and lilac.

The *compound spike* (*B*, Fig. 41) bears lateral inflorescences which are spikes. Examples are seen in wheat and rye-grass.

In meadow-grasses, oats and other grasses the inflorescences are panicles of spikelets, but are commonly termed panicles only (see pp. 477 and 478).



FIG. 41.—Compound inflorescence: *A* panicle or compound raceme: *B* compound spike: *C* compound umbel. *i* involucre, *i*¹ involucel.

(ii) *With shortened main axis*—

The *compound umbel* (*C*, Fig. 41). In this compound inflorescence the lateral inflorescences are arranged in the form of an umbel and are themselves simple umbels. The carrot, parsnip, hemlock, parsley and nearly all the Umbelliferæ (Chap. xxxi.) furnish examples.

II. Cymose Inflorescences.

In this type of inflorescence the main axis terminates in a flower and its growth is therefore stopped. If other flowers arise

upon the axis they must spring from lateral axillary buds below the apex. Usually each axis bears one, two, or a few branches only, which grow more vigorously and overtop the main one: these lateral axes terminate in flowers and repeat the same form of branching. The terminal flower of the main axis opens first, and is followed by those terminating the secondary, tertiary, and other axes in regular succession.

There are a number of complicated forms of cymose inflorescences the commonest simpler types being:—

(i) The *monochasium* or *forked cyme* (A and B, Fig. 42) in which the main axis and only one lateral branch; examples occur in forget-me-not (*Myosotis*), rock rose (*Helianthemum*), and some species of *Geranium*.



(ii) The *dichasium* or *forked cyme* (C, Fig. 42) in which the main axis has two lateral branches, and each of the latter again bear two branches; examples are met with in stitchworts (*Stellaria*) and centaury (*Erythræa*).

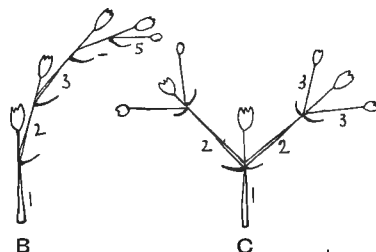

FIG. 42.—Cymose or definite inflorescences. A and B, Monochasium; C, dichasium: 1, main axis; 2, 3, 4, and 5, axis of second, third, fourth, and fifth orders respectively.

(iii) The *polychasium* in which more than two secondary branches are given off from the main axis and below each flower of the inflorescence; examples of polychasia are seen in many spurges (*Euphorbia*).

III. Mixed Inflorescences

are frequent in which the first branches of the main axis exhibit a racemose arrangement, while the subsequent branches are cymose in character, and *vice-versâ*.

Ex. 45.—The student should examine the inflorescences or as many plants as possible, and determine which are racemose and which cymose in type. Pay special attention to the position of the bracts whenever present.

He must understand that a large number of complicated inflorescences are met with, to which no names have been given.

The structure and nomenclature of those of the simple racemose and cymose types should be specially studied.

CHAPTER VIII.

THE FRUIT. DISPERSAL OF SEEDS.

1. It is from the flower of a plant that the fruit arises after the completion of a physiological process known as fertilisation. A satisfactory account of the latter and its effects can, however, only be given after the student has become acquainted with the finer details of plant structure ; it is therefore deferred to Chapter xxii.

It is sufficient here to remark that the process consists in the union of a certain portion of the contents of the pollen-grain with a minute structure termed an egg-cell situated within the ovule, after which the latter grows and finally becomes a seed.

Soon after fertilisation has taken place, the andræcium and corolla of the flower usually drop off or wither up, and sometimes the calyx falls also. The stigma and style of the gynæcium generally wither, but the ovary in all cases remains, and grows extensively to allow the rapid development of the seeds within it.

When the gynæcium has reached its full state of development and the seeds within its ovary have become ripe, it is termed *the fruit* of the plant, and the carpel-walls of the ripe gynæcium enclosing and protecting the seeds constitute the *pericarp* of the fruit.

It must be observed that the term 'fruit,' in popular language, is applied to a number of different parts of plants which are often in no way connected with the ripe gynæcium of the flower, and are therefore not fruits in this restricted botanical sense. In the strawberry and apple, for example, the succulent edible portion is the enlarged receptacle of the flower, the true fruit in the former being the small seed-like bodies (achenes) studded over

the receptacle, while the ripened gynæcium of the apple is its 'core' (see p. 404).

The tomato, vegetable marrow, and cucumber are true fruits, that is, they are the products of the gynæcium only, but are nevertheless popularly designated 'vegetables.'

The term *pseudocarp*, or '*spurious fruit*,' is frequently used for structures, such as the apple, strawberry, fig, and mulberry, produced from a flower or inflorescence, but which includes something more than the gynæcia and their contents.

2. A complete satisfactory classification and nomenclature of fruits is still wanting : they may, however, be divided into four groups as indicated below, according to the texture of the pericarp and the manner in which the seeds are set free from the fruit.

I. Indehiscent Dry Fruits.

In these the pericarp is dry and woody or leathery in texture, and does not split or open along any definite lines. The seeds are set free by the decay of the pericarp. As the necessary protection for the embryo and its store of food against adverse climatic influences and the attacks of animals, is afforded by the strong pericarp, the testa of the seed itself is usually thin in these fruits.

The following are the commonest forms of fruits of this class :—

(i) The *nut* is a one-seeded fruit, with a woody pericarp ; it is developed from an inferior syncarpous ovary. Examples are hazel-nut, beech-nut, acorn and Spanish chestnut.

The fruit of the horse-chestnut is not a nut, but a berry-like capsule.

The fruit of the Compositæ (Figs. 147, 148) is termed a *cypsela*, and is a form of nut developed from a syncarpous inferior ovary of two carpels. Its pericarp is thin, and contains within it only one seed ; the calyx is frequently present as a pappus.

(ii) The *achene* is a one-seeded fruit, with a thin leathery pericarp ; it is the product of an apocarpous superior ovary. Examples are seen in the buttercup (Fig. 226), rose, and strawberry.

In the rose, the achenes or true fruits, are enclosed within the hollow receptacle which, when ripe, is scarlet and soft.

In the strawberry the receptacle is succulent, the true fruits being the small achenes studded over it (see Fig. 125).

(iii) The *caryopsis* is a superior one-seeded fruit resembling an achene, but the seed within it, instead of being free as in the latter, is united with the wall of the pericarp. The fruits of grasses are caryopses.

(iv) The *samara* resembles an achene, but the pericarp is furnished with wing-like appendages, e.g. ash, elm and sycamore (a double samara).

II. Schizocarps.

These are dry syncarpous fruits, the united carpels of which, when ripe, separate from each other, but do not set free the contained seeds as in the dehiscent fruits mentioned below. Each separate carpel of the fruit is termed a *mericarp*, and usually contains a single seed enclosed within it.

Sycamore fruits, and those of the carrot, parsnip, and other Umbelliferæ, are examples of schizocarps (see Fig. 134).

III. Dehiscent Dry Fruits.

In these the pericarp splits in various ways or opens by pores. The interior of the fruit is exposed, and the seeds, which usually have thick protective testas, are set free.

Most dry fruits of this class have many seeds.

The commonest forms of dry dehiscent fruits are mentioned and described below.

(i) The *follicle* is a superior fruit consisting of a single carpel which opens along one suture only, most frequently the ventral one. Columbine fruits are examples (Fig. 43).

(ii) The *legume* is also a superior fruit of one carpel, but

it dehisces along both the dorsal and ventral lines (Fig. 37). The pods of peas and beans are examples.



FIG. 43.—Follicle of Columbine (*Aquilegia*) showing dehiscence along one suture.

(iii) The *siliqua* (Fig. 44) is an elongated superior fruit composed of two united carpels. In the interior of the fruit is a thin false dissepiment or partition, termed the *replum*, which separates the fruit into two chambers. When ripe the two carpels dehisce from below upwards and leave the seeds attached to the placentas and replum. Examples are met with in the turnip, cabbage, and wallflower. The term *silicula* is applied to fruits of this description which are short and broad as in shepherd's purse.

(iv) The term *capsule* is generally applied to practically all forms of syncarpous, dry dehiscent fruits except those just mentioned. They may be either superior or inferior, and usually contain many seeds. The manner and amount of dehiscence is very varied: most frequently it is longitudinal, but in some cases it is transverse. The dehiscence may extend a part of the way along the fruit and the carpels remain partially united with each other; or it may extend the whole length of the capsule and the carpels become free and fall away from each other. If the latter happens and the splitting takes place along the dorsal suture, the dehiscence is described as *loculicidal*; the term *septicidal* is used when the dehiscence occurs along the line of union of the carpels.

In some cases the outer parts of the capsules fall off as separate pieces or *valves* leaving the partition or septa of the gynæcium attached to the flowerstalk: such dehiscence is described as *septifragal*.

Dehiscence by pores is seen in the capsules of the poppy.

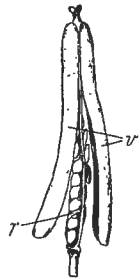

FIG. 44.—Siliqua of wallflower, showing manner of its dehiscence; *v* valves of fruit; *r* replum with seeds attached (cf. Fig. 123).

The *pyxis* or *pyxidium* is a form of capsule in which the dehiscence is transverse, the upper part of the carpels falling off in the form of a cap or lid (Fig. 45). Examples are seen in plantain, pimpernel, and red clover.

IV. Succulent or Fleshy Fruits.

In these the pericarp is more or less soft and sappy and, when ripe, is usually of considerable thickness. The commonest forms are mentioned below.

(i) The *drupe* is an indehiscent superior fruit of this class, consisting of a single carpel, and usually with one or two seeds. In the ripe pericarp three layers are visible, namely, (1) an outer thin delicate skin, the *exocarp* or *epicarp*, (2) a soft, thick, fleshy middle layer, the *mesocarp*, and (3) a hard, bony layer, the *endocarp*, which forms the so-called 'stone' of the fruit. The seed of course is quite separate from the 'stone,' but enclosed within it (Fig. 124). The fruits of the plum, cherry, apricot, peach and almond are drupes. The individual separate carpels in a single raspberry flower become small drupes or *drupels*, so that the whole fruit is a compound one consisting of a collection of drupels. The fruit of the walnut is a form of drupe differing only from those above mentioned in being the product of a syncarpous gynæcium: the endocarp develops partitions which extend irregularly into the fleshy lobes of the single seed.

(ii) The *berry* is an indehiscent succulent fruit in which both the mesocarp and endocarp are soft and fleshy. Sometimes the berry is the product of superior ovary as in the grape, tomato, and potato 'apple,' while in other instances it is inferior as in the gooseberry (Fig. 46), currant, and cucumber.

'Dates' are berries the 'stone' of which is a true seed not to be confused with the 'stone' of a drupe.

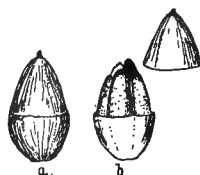

FIG. 45. — Pyxidium of greater plantain (*Plantago major* L.); a closed; b upper part removed and showing the seeds within.

(iii) The *pome*, of which an apple or pear are good examples,

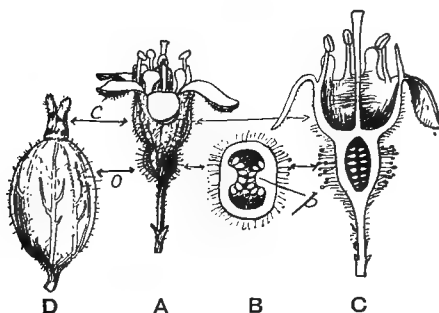

FIG. 46.—Flower and fruit of gooseberry. *A* the flower, calyx-tube, *o* inferior ovary; *C* longitudinal section of the flower; *B* transverse section of the young ovary, *p* placenta with ovules attached; *D* half-ripe fruit.

is an indehiscent fleshy pseudocarp whose gynæcium or true fruit is embedded in the receptacle. When the pseudocarp is ripe the pericarp belonging to each carpel of the gynæcium develops a tough, leathery or bony inner wall—its endo-

carp—the rest of the pericarp being in some cases fleshy, in others hard and bony. Surrounding and united with these fleshy or bony carpels is the thick, fleshy receptacle of the flower which forms the chief edible portion of the pome (see Fig. 126 and chapter on Rosaceæ, p. 387).

EX. 46.—The student should watch the development of the common fruits of the garden from the opening of the flowers to the ripe fruit.

Observe what becomes of the receptacle, calyx, corolla, and andrœcium in each case.

He should also examine the fruits of all useful plants of the farm, and those of common weeds.

Careful descriptions of each should be made, noting whether they are:—

- (1) Dry or succulent.
- (2) Dehiscent or indehiscent and manner of dehiscence.
- (3) Developed from an apocarpous or a syncarpous gynæcium.
- (4) Developed from a superior or an inferior ovary.
- (5) One or many-celled, and the number of seeds in each.

3. Dispersal of Seeds.—In some cases the ripe seeds or the fruits containing them fall to the ground in the immediate neighbourhood of the parent plant; it will however, be observed, that by far the larger proportion of plants exhibit

special adaptation to secure the dispersal of their seeds to longer, or shorter, distances.

The chief agents at work in the transport of the seeds are wind, water, and animals.

In some instances the pericarps of the fruits when ripe are subject to spring-like tensions, and at the time of dehiscence open, more or less violently, and scatter the seeds in all directions, often to a distance of several feet. The ripe pods of many leguminous plants, such as peas, beans, and bird's-foot trefoil, disperse their seeds in this manner, and the valves of the pods after the opening of the fruit twist or curl up suddenly.

Fruits, which scatter their seeds by the sudden released mechanical strains when dehiscence takes place, are also met with on the bitter-creesses (*Cardamine hirsuta* L. and *C. impatiens* L.) several species of cranesbill (*Geranium*) and many balsams (*Impatiens*).

The wind is, however, the most powerful and most obvious agency at work in the distribution of seeds, and an enormous number of modifications are noticeable among plants to secure dispersal by this means.

In the orchises, poppies, and other plants, the seeds are small enough to be readily blown considerable distances in the air as soon as they escape from their capsules. Some seeds are smooth and round, and easily roll along the ground. More commonly, however, the adjoining bracts or some portion of the flower, fruit or seed, is modified in such a manner that it presents a large and light surface to the air, and the whole structure is thus rendered buoyant.

In many plants of the Compositæ (Chap. xxxiii.), such as thistles, groundsel, and dandelion (Fig. 148), the calyx is represented by a tuft of long delicate hairs which act as a parachute capable of preventing the rapid fall of the fruit when once the latter is taken up by the wind. Even in a moderate breeze the fruits of such plants are carried long distances before they finally drop.

In the kidney-vetch (p. 432) the calyx is large, thin, and inflated, and in some species of clover the faded corolla is large and of small weight in comparison with the single-seeded pod which it encloses.

The perianth in many docks develops into thin wing-like projections surrounding the fruit, and winged extensions of the pericarp are seen in the ash, sycamore, elm, and certain umbelliferous plants. Some of these fruits are of such weight that they fall almost vertically when allowed to do so, although with a slow spinning motion. They are, however, only detached by strong winds or gales, and under these circumstances, may be carried considerable distances. Not only are the external parts of the pericarp and other portions of the flower modified for wind distribution, but the seeds themselves of many dehiscent fruits show similar adaptations to the same end. In the willow, poplar, willow-herb (*Epilobium*), and cotton, the testa is more or less covered with long, silky, buoyant hairs, and many seeds, such as tulip and yellow rattle (p. 608), have thin, wing-like membraneous margins.

In the hop, and most grasses, the buoyant agents are the bracts surrounding the fruit.

Water-plants have fruits and seeds, the bracts of which enclose more or less air which enables them to float some distance.

A large number of seeds are spread over the earth by animal agency. Upon the pericarp of the carrot, hedge-parsley (*Torilis*), and other umbelliferous plants, and also that of cleavers (*Galium aparine*), and many medicks, spinous and hook-like structures are present, which cling to the fur, wool and feathers of animals. Similar hook-like projections are seen also on the receptacle of agrimony and on the involucre bracts of the common burdock (*Arctium Lappa* L.). Eventually the fruits are rubbed off or fall off the animal's coat in another locality from that in which they were collected; in this manner seeds may be transported long distances.

Moreover a number of succulent fruits are eaten as food by animals of various kinds, especially birds, and the seeds of such fruits pass through the stomach and intestines without injury.

The protection of the embryo against the action of the digestive liquids of the body is generally afforded by the hard parts of the pericarp, or the seed coats. The alluring or attractive succulent parts of the fruit in drupes—cherry, sloe, and plum,—and in all berries, is the pericarp, or some part of it, while in the strawberry, rose, apple, and hawthorn, the receptacle is the attractive portion.

In the stone-fruits and hawthorn the hard, bony endocarp protects the embryo while passing through the body of an animal, and in berries the testa of the seed serves the same purpose. In the strawberry and rose-hip the seeds are protected by the hard pericarp of the achenes.

It will be noticed that when the seeds are unripe and unfit for dispersal the parts of the fruit used as food in all these cases are at first green, sour, and firm in texture. But at the time of ripening of the seeds, or soon afterwards, when they are ready for distribution the parts of the fruit change to some conspicuous colour, become softer and sweeter, and often develop a distinct and characteristic odour.

Ex. 47.—Examine the fruits of common weeds and endeavour to find out how the seeds are dispersed in each.

Ex. 48.—Notice the number and kinds of seeds and fruits attached to the wool of sheep ; also to the fur of dogs after passing through a dense copse in summer or autumn.

What means of attachment do the fruits exhibit ?

Ex. 49.—Look out for evidence of the dispersal of seeds by birds :

- (a) Examine the excreta of fieldfares and thrushes in winter.
- (b) Observe the kinds of shrubs and trees which grow sometimes on the face of cliffs and walls of old ruins. Have they mostly succulent fruits ?
- (c) What kinds of fruit have the plants found growing away from the ground on old trees ?

PART II.

INTERNAL MORPHOLOGY (ANATOMY).

CHAPTER IX.

THE PLANT CELL: CELL-DIVISION: TISSUES.

1. IN the preceding chapters we have been concerned with the larger external features of the bodies of flowering plants. It is now necessary to study the internal and minute structure of root, stem, leaf and flower in order that the physiology, or the work which each of these organs carries on may be satisfactorily understood.

2. A knowledge of the internal structure is obtained by cutting thin slices of the various organs with a sharp razor, and examining these slices or *sections* as they are called with the naked eye and with the microscope. For a complete understanding of the nature and relationship of the several internal parts of any plant organ, it is not sufficient to examine a section through it in one direction only: sections must be made in several directions. In stems, roots, and other parts, which are longer than broad, it is usual to make sections in the manner indicated in Fig. 47. Those cut at right angles to the main axis as at C, are

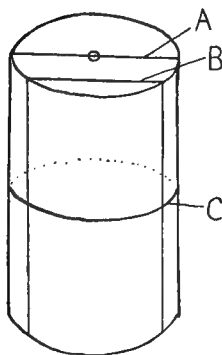

FIG. 47.

termed *transverse* sections: those which are cut parallel to the main axis are *longitudinal sections*, the terms *radial* and

tangential being added respectively to the latter according as the sections pass through the centre of the stem as at *A*, or not, as at *B*.

3. **The Cell.**—If a very thin section of a turnip 'root' is examined with a microscope a kind of net-like structure is seen as in Fig. 48. By further examination of slices taken in several different directions, a similar appearance is observed in each case, from which we conclude that the substance of the turnip is composed of an enormous number of very small more or less cubical or spherical compartments surrounded by thin walls. These closed chambers are called *cells*. Although they vary in size they are usually quite invisible to the unaided eye, being rarely more

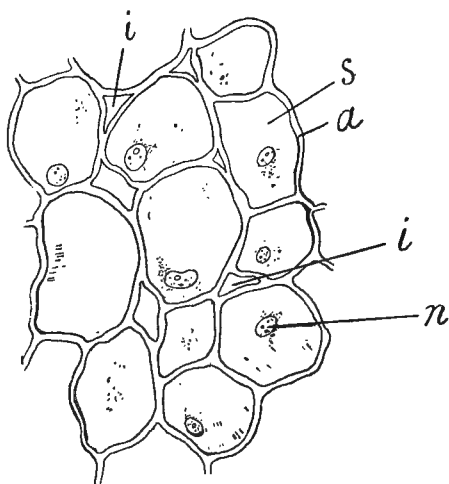

FIG. 48.—Cells from the fleshy 'root' of a turnip. *a* Cell-wall; *s* cell-cavity; *n* nucleus; *i* intercellular space. (Enlarged 180 diameters.)

than $\frac{1}{100}$ of an inch and not unfrequently as small as $\frac{1}{1000}$ of an inch in diameter. A full-grown living cell (*C*, Fig. 49) taken from near the apex of a root or stem is seen to consist of the following parts:—

(i) A thin completely closed membrane (*a*) termed the *cell-wall*;

(ii) A continuous lining (*r*) of a substance known as *protoplasm*; and

(iii) A central space (*v*), the *vacuole*, which appears to

be empty, but which is filled with a watery liquid termed *cell-sap*.

(i) The **cell-wall** is formed of a solid, elastic and transparent dead material, called *cellulose* by chemists ; it acts as a protective covering for the protoplasm and is manufactured by the latter.

(ii) The **protoplasm**, which is the most important part of the cell, is a more or less slimy or jelly-like substance containing

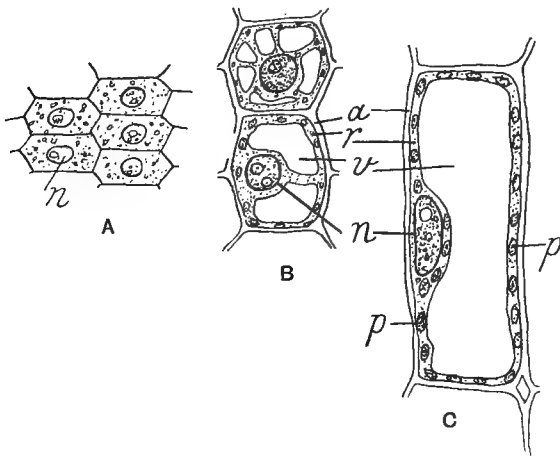

Fig. 49.—*A*, Very young cell from near the tip of a root. *B*, Two older cells. *C*, Single full-grown cell ; *a* cell-wall ; *r* cytoplasm ; *n* nucleus ; *p* plastids ; *v* vacuole. (Enlarged about 350 diameters.)

a considerable proportion of water. Its chemical nature is not understood, but within it there always appears to be a complex mixture of protein compounds. It is the substance directly associated with the peculiar phenomena which we call *life*. The process of respiration, and all the remarkable chemical changes involved in 'assimilation' and nutrition generally, are due to the protoplasm, as well as the powers of growth and reproduction possessed by living organisms of all kinds, plants and animals alike. Wherever life is, protoplasm is present, and death implies its decomposition or destruction.

In many cells the living protoplasm exhibits a characteristic spontaneous movement; in some instances it flows in one direction in a continuous stream round and round the cell, in others, currents in several different directions are observed in the protoplasm.

From Fig. 49 it is seen that the protoplasm of the cell is not homogeneous, but consists of the following parts:—

(a) A dense more or less spherical or oval portion (*n*), the *cell-nucleus*;

(b) A number of smaller bodies (*p*), termed *plastids* or *chromatophores*; and

(c) A more liquid and finely granular substance the *cell-plasm* or *cytoplasm* (*r*), in which the nucleus and plastids are always imbedded.

In very young cells (*A*, Fig. 49), the protoplasm entirely fills the cell-cavity and it is only after the growth of the cell that vacuoles appear. In the majority of living cells of the higher plants a single nucleus is present in each; in some long cells, however, several nuclei are frequently found.

All nuclei arise by the division of previously existing nuclei. Their functions are not completely known, but cells artificially deprived of them soon die. As the essential part of the sexual fertilisation process consists in the union of two nuclei it is thought that the latter are the carriers of the hereditary characters of the parent organisms from which they are derived. Moreover, in cell-division which results in multiplication of cells the nucleus seems to initiate and control the process of division.

The thin lining of cytoplasm, or the *primordial utricle* as it is sometimes called, controls the passage of soluble substances into and out of the cell-sap filling the vacuole.

The plastids are small bodies of protoplasm resembling nuclei in density: three kinds are recognised, namely—

(a) *chloroplasts*, (b) *chromoplasts*, and (c) *leucoplasts*.

They always arise from previously existing plastids by division

and like the nucleus are never produced *de novo*. The chloroplasts, sometimes known as *chlorophyll-granules*, are green, their substance being saturated with a green-colouring matter named *chlorophyll*. All green parts of plants owe their colour to the chloroplasts in their cells, and the very important 'assimilation' process (chapter xvi.) is due to their activity.

The chromoplasts, which are frequent in the cells of flowers and fruits, are yellow or red, instead of green, the parts of the plants in which they occur being rendered conspicuous by them and attractive to birds and insects.

The term leucoplast is applied to all colourless plastids: examples are met with in roots, tubers and other underground parts of plants. They possess the power of forming starch-grains from sugar. The three kinds of plastids are convertible into one another; the chloroplasts of green unripe fruits usually become chromoplasts when the fruit is ripe, and the leucoplasts of a potato tuber become green when the latter is exposed to light.

(iii) The **cell-sap** filling the vacuole of the cell consists of water in which a number of substances are dissolved. In the cells of beetroot, as well as in many fruits, flowers, and leaves, the cell-sap contains a purple or reddish colouring-matter; most frequently, however, it is colourless. It is generally acid, but the nature and amount of the compounds present in it often varies from cell to cell in different parts of the same plant. Various products of the activity of the protoplasm, such as sugars, soluble proteid, acids, and organic salts, are commonly present, as well as nitrates, sulphates, phosphates, and other inorganic compounds, absorbed from the soil.

Most of the peculiar taste of the fruits and vegetables we eat is due to the substance dissolved in their cell-sap, the protoplasm and cell-wall being tasteless.

4. The cells of the body of a plant at the time of their formation at the growing-points of the root and stem, are all about the same size and cubical or polyhedral in form. They soon

increase in size and become variously modified in shape and structure in accordance with the special functions which they have to perform in the fully-developed organs of the plant.

If during growth the cell-wall increases in all directions alike, the original cubical or polyhedral form is maintained; most frequently, however, growth is irregular and the cells assume a great variety of shapes, the chief of which will be mentioned when dealing with the organs of the plants in which they occur.

A great many cells after a time lose their protoplasmic contents and nothing then remains except the cell-wall and the cell-cavity

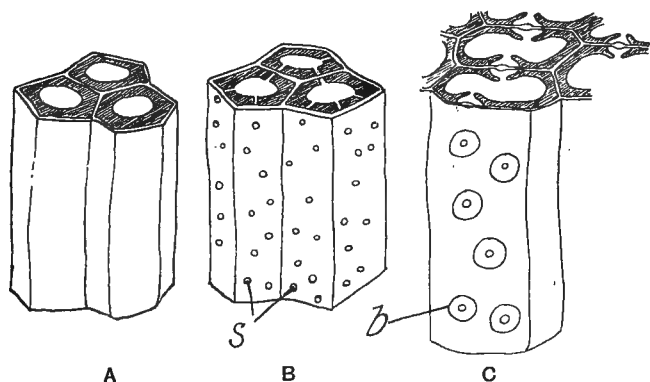

FIG. 50.—Diagrammatic illustration of thickened cell-wall; *A*, uniformly thickened wall; *B*, wall with simple pits; *C*, wall with bordered pits.

generally filled with air. To these empty shells the term cell is commonly applied although some other term would be more suitable. Sometimes the cell-walls remain thin, but very often they become greatly thickened before the cell completely loses its protoplasm; such thickened cell-walls give firmness and strength to the structures which contain them and act as mechanical supports for the delicate parts of the plant.

The thickening consists in the deposition of successive layers of some form of cellulose on the inner surface of the cell-wall.

Sometimes the layers are disposed uniformly all over the inside as in *A*, Fig. 50, but more frequently the increase in thickness goes on at some points more rapidly than at others. In some cases small areas of the cell-wall are left unaltered; these thin places appear as bright spots termed *pits* when a surface view of the cell is examined.

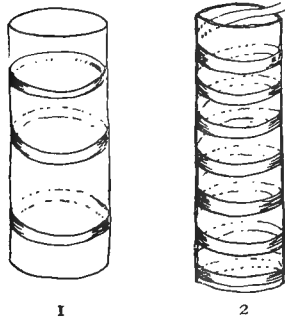

FIG. 51.—Portions of vessels showing (1) annular, (2) spiral thickening of their walls.

In *simple pits* (*B*) the cavity left unthickened is roughly cylindrical and viewed end on appears as a circle or ellipse. The cavity left unthickened in a *bordered pit* is funnel-shaped, and in surface view appears as two concentric circles or ellipses (*C*). The pits of one cell-wall are generally exactly opposite the pits of an adjoining cell-wall, and serve as a means of communication between the two cells.

Thickening in the form of *spiral* and *annular* or ring-like bands is also very common (Fig. 51).

5. Cell-division: continuity of protoplasm.—With the extension in length of the stem and root, and the production of new organs at the growing-points of ordinary green plants, a great increase in the number of cells takes place. This cell increase is the result of division of previously existing cells, all of which in any individual plant have originated from the division of a single cell, namely, the fertilised egg-cell of the ovule.

During the process of division of a cell at the growing-point of a shoot or root, the nucleus first divides into two exactly similar halves in a complicated manner which cannot be discussed here. The two halves or daughter-nuclei then recede from each other a short distance in the dividing cell, and a new cell-wall arises midway between them. The new cell-wall divides the cytoplasm into two distinct parts, and is always placed at

right angles to a straight line drawn from one nucleus to the other (Fig. 52).

From ordinary examination of cells and their contents, it might be concluded that the living material of a typical plant-cell is completely shut off by the cell-wall from communication with its immediate neighbours.

Comparatively recent research has, however, shown that in a number of instances, the protoplasm of one cell is connected with that of adjoining cells, by means of extremely delicate protoplasmic strands which pass through minute openings in the cell-walls, and it appears very probable that the whole protoplasm of an organism is continuous.

In some instances, as in the embryo-sac of the ovule, the successive division of a nucleus and its associated cytoplasm goes on for a time without being immediately followed by the formation of corresponding cell-walls; sooner or later, however, the protoplasm of almost all vegetable cells becomes enclosed in a cell-wall.

6. **Tissues.**—The body of a plant consists of a vast number of cells of very varied forms. These different kinds of cells, instead of being distributed uniformly through the plant, are associated together in the form of bands, plates and cylindrical masses: such associated groups of cells are spoken of as *tissues*. The latter may be classified in many ways according as we take into consideration their origin, structure or function. A tissue consisting of thin-walled living cells which are embryonic and capable of division is termed a *meristem* or *formative tissue*, the fully-developed adult tissues being spoken of as *permanent*.

Taking into consideration the form of the cells composing them, two chief types of tissues may be distinguished, namely,

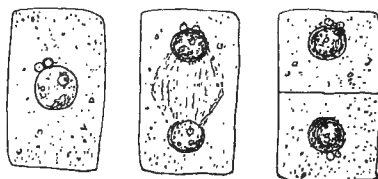

FIG. 52.—1, Young cell previous to cell-division; 2, the same after division of the nucleus; 3, cell-division completed (enlarged 500 diameters).

parenchyma and *prosenchyma*. Between them no sharp distinction can be made, but the former usually consists of cells which are individually much the same in length, breadth and thickness, and each cell is united to its neighbours by broad flat ends and sides.

Although in young tissues all the cells are in complete contact at all points of their surfaces, in permanent parenchymatous tissues the common cell-walls of adjoining cells frequently separate from each other at the angles and give rise to *intercellular spaces* (*i*, Fig. 48), which are generally filled with air. It is important to note, however, that in some cases intercellular spaces arise through the complete dissolution or drying-up of masses of cells in which instances the cavity left is most commonly filled with gums, oils, resins and other excreted products.

The cells of *prosenchymatous* tissue are long and pointed at both ends; moreover, the ends dovetail between each other and fit closely without intercellular spaces. Prosenchymatous and parenchymatous tissues, whose cell-walls are thickened and hard, are distinguished as *sclerenchyma*.

Ex. 50.—Take one of the inner fleshy leaves of an onion bulb, and, after making a shallow cut into the surface with a sharp knife, tear or strip off a small portion of the 'skin.' Place it in eosin solution or red ink for a few minutes: then wash it and mount in a drop of water on a glass slide. Examine with a microscope, first using a low, and subsequently a higher power. Notice and make drawings of the cells, their cell-walls, stained nuclei, protoplasm, and vacuoles.

Ex. 51.—Cut very thin slices of a turnip with a sharp razor and examine in a similar manner; observe the intercellular spaces between the cells. Cut slices of a coloured beet-root: examine without staining, and notice the coloured cell-sap.

Ex. 52.—Make and examine a section of Elder pith: observe the form and size of the dead cells and also the thickness and markings of the cell-walls.

Ex. 53.—Make transverse and longitudinal sections of the wood of an ordinary safety match, notice the thickness and markings of the cell-walls. Examine in a similar manner pieces of other common woods.

Ex. 54.—Cut thin slices of the leaves or any green part of a plant: examine the cells and notice the greenness is not due to coloured cell-sap, but to the existence of numerous small green chloroplasts.

CHAPTER X.

THE ANATOMY OF THE STEM, ROOT, AND LEAF.

WE propose in the present chapter to discuss the general arrangement and structural character of the various ordinary tissues in the different plant organs and incidentally to mention their uses in the economy of the plant leaving the more detailed account of physiological processes for subsequent chapters.

THE STEM.

A. The Herbaceous stems of dicotyledons.

A great portion of the herbaceous stems of dicotyledons consists of soft succulent tissue, in which are imbedded a number of thin, tough, stringy strands termed *vascular bundles*. The latter give firmness to the stem, but their chief function is the conduction of sap to all parts of the plant.

Covering the surface of the stem is a thin skin or tissue of cells called the *epidermis*. To the remainder of the tissues, that is, to all except the epidermis and vascular bundles, the term *fundamental* or *ground tissue* is applied.

In a transverse section of the stem the vascular bundles are seen to be arranged side by side in a circle (Fig. 53). That part of the fundamental tissue enclosed by the ring of vascular bundles is spoken of as the *medulla* or *pith* (*p*), the part outside the ring is the *cortex* (*c*), while the small narrow

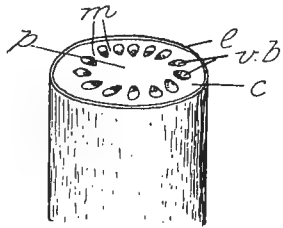

FIG. 53.—Diagram illustrating the distribution of the chief tissues in the stem of a dicotyledon; *e* epidermis; *v.b* vascular bundles; *c* cortex; *p* medulla; *m* medullary rays.

bands running radially between the bundles and connecting the cortex with the medulla are the *medullary rays* (*m*).

The vascular bundles, together with the medullary rays and pith, form a cylindrical mass of tissues known as the *vascular cylinder* or *stele*, which extends continuously throughout the plant from the tip of the stem to the growing-point of the root.

(i) The **epidermis** is usually one cell thick and acts as a protective coat for the plant, preventing the latter from too rapid loss of water and also defending the delicate internal cells of the plant against mechanical injuries due to rain, hail, frost and insect attacks.

The cells are tubular flattened cells fitting quite closely together, except where the openings named stomata occur: as the latter are more abundant in the epidermis of a leaf, their structure is deferred to page 145. Usually the outer cell-wall of each epidermal cell is much thicker than the lateral and inner walls, and is differentiated into two or three layers, the outermost layer in contact with the atmosphere being spoken of as the *cuticle*. The cuticle is composed of a substance known as *cutose*, which is very impervious to water, and a remarkably stable body capable of resisting the action of various solvents which dissolve ordinary cellulose.

On the cuticle of the stems and leaves of cabbages, swedes, and many varieties of cereal and other grasses, as well as on grapes and plums, an ash-coloured bloom is seen. It is an excreted product of the epidermal cells, and consists of minute round, rod-like or scaly particles of wax. Surfaces of the different parts of plants covered with this bloom lose less water than those from which the substance has been removed by rubbing.

This waxy layer appears also to act as a partial protection against the attacks of fungi and insects.

The cells of the epidermis contain the usual cell-contents with the exception of chloroplasts which are generally missing ;

they are especially rich in cell-sap, which is often tinted pink, red or purple by a colouring matter which appears to protect the cells of the cortex from excessive light. In some plants, if not in all, the cell-sap of the epidermal cells functions as a store of reserve water upon which the more internal cells of the stem can draw in time of need.

It is well known that the surface of stems and other parts of plants are frequently covered with *hairs*. These belong to the epidermis, and in their simplest form are merely single cells which have grown much longer than their neighbours. Some hairs are, however, multicellular extensions of the epidermis (*h*, Fig. 54), and like the unicellular hairs may assume a great variety of shapes.

Hairs are often harsh to the touch, and furnish a means of defence against insects and animals generally. They also act as a mantle which prevents too rapid escape of water from the plant, and acts as a screen against excessively bright sunshine.

In young stems and buds, hairs protect the tender parts against injury by frost. Certain hairs function as secreting organs, and are then designated *glands* (Fig. 106): they often produce resinous and oily compounds, which in the case of mint, hop, and other plants have a characteristic odour. Many excreted products of such hairs are sticky, and effectually prevent insects such as ants from climbing up the stem and getting at the nectar of the flower.

(ii) The **cortex** of the stem extends from the epidermis to the vascular cylinder. A great part of it generally consists of living parenchymatous cells which contain abundant chloroplasts. The cells of the portion immediately beneath the epidermis frequently have their cell-walls thickened at the corners, and form what is spoken of as *collenchymatous* tissue: the latter serves to strengthen the epidermis, and gives rigidity to the whole stem. The innermost layer of cells belonging to the cortex forms a continuous sheath surrounding the vascular cylinder

termed the *endodermis* (*en*, Fig. 54); its cells are not very much differentiated from the rest of the neighbouring cortical cells, but they usually contain numbers of starch-grains which render them somewhat conspicuous in sections of certain stems.

(iii) The **vascular cylinder** or **stele** includes all the tissues inside the endodermis, namely, the vascular bundles described below, and also the medulla or pith and the medullary rays.

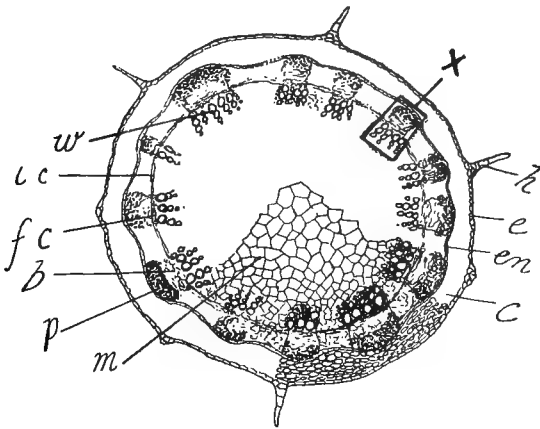

FIG. 54.—Transverse section of the stem of a sunflower (enlarged about 8 diameters.) *X*, portion including a vascular bundle; *e* epidermis; *h* a hair; *c* cortex; *en* endodermis; *w* wood; *b* bast; *fc* fascicular cambium; *ic* interfascicular cambium; *p* pericycle fibres.

The outermost portion of the stele which lies immediately in contact with the endodermis is known as the *pericycle*. The latter may consist of a single layer of cells or of more than one layer; in some stems, its cells are thin-walled, and from it arise most adventitious roots and shoots.

The medullary rays and pith are composed of thin-walled parenchymatous cells; the cells of the medullary rays generally retain their living contents for a long time, but those of the pith live for a short time only.

If we select an individual bundle in the internode of almost any dicotyledon and trace it upwards it will be found to pass out of the stele across the cortex and into the leaves, where it branches and forms the veins. Bundles of this kind common to both leaf and stem are termed *common bundles*, that part of each present in the stem being spoken of as the *leaf-trace* of the bundle. From each leaf one or several bundles may enter the stem, and on being followed downwards they are found to descend perpendicularly through one or more internodes, finally uniting with bundles which have entered the stem from older leaves lower down. The bundles in their descent all keep about the same distance from the centre, so that in a transverse section they appear arranged in a circle.

Great variation exists in the manner and amount of branching and union of the bundles in different plants, but the arrangement is always such that the vascular bundles of the leaves, stems and roots form a continuous conducting system of tissues specially adapted to facilitate rapid and easy transmission of sap to all parts of the plant.

In this type of stem each vascular bundle consists of three kinds of tissue, namely:—

- (1) *xylem* or *wood* (*n*, 1, Fig. 55);
- (2) *phloëm* or *bast* (*d*); and
- (3) a thin-walled meristem tissue termed the *cambium* of the bundle (*c*).

These tissues are arranged side by side in such manner that in a transverse section of the stem a radius drawn from the centre to the outside passes through all three; the cambium lies between the wood and the bast, the wood being nearest to, and the bast farthest away from the pith.

Bundles in which the wood and bast lie on the same radius are termed *collateral* bundles; when as in dicotyledons they also possess cambium they are said to be *open*.

- (a) *Wood* or *xylem*.—The elements met with in the wood

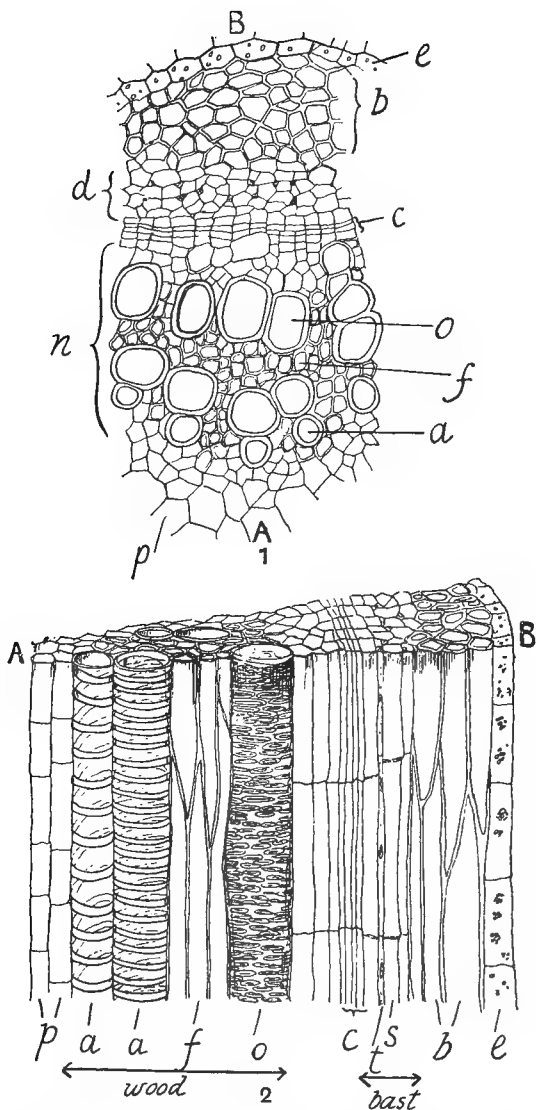

FIG. 55.—1. Transverse section of a vascular bundle of a sunflower stem (enlarged about 120 diameters). Enlargement of X in previous fig. 2. Longitudinal radial section through the same. *p* Medulla of stem; *n* the wood; *d* the bast; *c* the cambium of the bundle; *a* spiral vessel; *f* fibre; *o* pitted vessel; *s* sieve tube; *t* companion-cell; *b* pericycle fibres; *e* endodermis.

are usually (1) *vessels* or *tracheæ*, (2) *tracheids*, (3) *fibres* and *fibrous cells*, and (4) *wood-parenchyma*, all of which commonly have much thickened firm cell-walls consisting of lignocellulose. The proportion is not the same in all bundles and in some cases certain elements are missing altogether; *tracheæ* or *tracheids*, however, are constantly present in all wood.

The *vessels* or *tracheæ* (*a* and *o*) are not cells, but long continuous open tubes, each formed from a row of superimposed cells, many of the transverse cell-walls of which have been absorbed or dissolved away. In some climbing plants the cavities of the vessels are 9 or 10 feet long: according to Adler's measurements, the vessels of oak wood average about 40 inches long, those of hazel and birch about 5 inches. Their walls always exhibit either annular, spiral, or reticulate thickening or pits. Those first formed in the bundle possess only annular or spiral thickenings, and constitute the *protoxylem*.

At first all vessels contain protoplasm, but during their growth the living substance is used up in the thickening of the cell-walls: when fully formed they are dead empty structures which serve for the conduction of water.

Tracheids resemble vessels in the character of their cell-walls and in their function: they are, however, long, single, empty cells and not compound structures.

The *fibrous cells* are long and pointed at both ends; they possess living contents and their cell-walls are most frequently thickened and sometimes marked with small pits. *Fibres* (*f*) are similar thick-walled cells which have lost their protoplasmic contents and contain air or water only.

The *wood-parenchyma* consists of somewhat elongated cells with square, blunt ends and living contents: the cell-walls are thickish and slightly pitted. In these cells starch is often stored.

(*b*) *Bast* or *phloëm*.—The elements composing the bast or phloëm are (1) *sieve-tubes* or *bast-vessels* (*s*) with their *companion-*

cells (*t*), and (2) a certain amount of thin-walled *bast-parenchyma*: their cell-walls consist of ordinary cellulose.

The *bast-vessels* are long thin-walled cells arranged end to end. The transverse or end-walls which separate one vessel from another, are not completely absorbed as in the vessels of the wood, but merely perforated by open pores through which the contents of adjoining vessels are in continuous open communication: these transverse perforated walls are called *sieve-plates*.

When mature the bast-vessels contain a thin lining of cytoplasm but no nucleus: the rest of the cell-cavity is filled with an alkaline slimy substance, rich in proteids, and frequently containing starch-grains as well.

The bast-vessels serve for the conduction of various complex organic substances, but more especially for those of a proteid character.

The *companion-cells* are long narrow cells which lie alongside the sieve-tubes: they are filled with granular cytoplasm in which a nucleus is always present. Both the sieve-tube and its companion-cell arise from the same mother-cell.

(*c*) *Cambium*.—The cambium lies between the wood (*c*, Fig. 55) and the bast, and consists of a layer of thin-walled meristematic cells, each of which has the form of a long, narrow, rectangular prism with obliquely pointed ends.

In young stems the cambium is confined within the vascular bundles, but in older ones a new and exactly similar meristematic tissue termed the *interfascicular cambium* arises in the medullary rays, and extends across the latter, joining the cambium of one bundle with that of the next (*ic*, Fig. 54). We thus have in the older stems a thin complete cylinder of dividing-cells which in transverse section appears as a narrow zone, spoken of as the *cambium-ring*.

The cambium-ring adds new elements to the wood and bast of the stem in a manner explained below; but in short-lived herbaceous dicotyledons this additional growth soon ceases, so

that its effect is not so noticeable in these as in perennial woody stems.

Ex. 55.—Cut across the young soft stems of the sunflower, Jerusalem artichoke, groundsel, bean, potato, and any other common herbaceous plants. Examine the cut surfaces with a pocket lens, and observe the presence and arrangement of the vascular bundles and pith.

Ex. 56.—Place some young sunflower stems in a mixture of two-parts methylated spirit and one-part of water. Keep them in this mixture for further use. From a stem which has been in the mixture three or four days cut very thin transverse sections with a razor wetted with the mixture. Transfer the sections to a watch glass containing water; after remaining in the water for a few minutes, take one out and mount it in a drop of water on a glass slide. Cover with cover-slip and examine with the lowest power of the microscope.

Make drawings indicating the position and general character of the

- (a) epidermis,
- (b) cortex,
- (c) endodermis,
- (d) vascular bundles,

and (e) pith and medullary ray tissue between the bundles.

Examine with a high power, and make sketches of small portions of the various parts above-mentioned, paying especial attention to the wood, cambium and bast (compare Fig. 55).

Try and see if the interfascicular cambium has been formed across the medullary rays.

Ex. 57.—Take a piece of sunflower stem about a quarter of an inch long, preserved as in preceding exercise, and cut longitudinal sections so as to pass through a vascular bundle. (In cutting longitudinal sections of stems, the razor should cut from one *side* of the stem to the other, not from end to end.)

Examine first with a low and then with a high power: make sketches of the form of the cells met with in the epidermis, cortex, bast, cambium, wood and pith respectively.

Try and determine which cells of the longitudinal section correspond with those seen in the transverse sections.

Ex. 58.—Make a careful study of the anatomy of a stem of groundsel, bean, and other common herbaceous dicotyledons.

Always begin the examination of sections with the lowest power at disposal, namely, with the naked eye or a good pocket lens. After the general arrangement of the chief tissues is understood, then apply higher powers in succession.

B. The perennial woody stems of dicotyledons.

(a) **Division of the cambium-cells.**—In the earliest stages of the stems of shrubs and trees the arrangement and constitution of the tissues are essentially the same as in simple short-lived herbaceous stems. With an increase in age there is, however, a steady increase in thickness from year to year, and in transverse sections of such thickened stems the isolated small vascular bundles, so obvious when the stems are very young and soft, are no longer visible.

The greatest part of the increased bulk of tissues in such stems as these, is brought about by division of the *initial cells* of the cambium-ring.

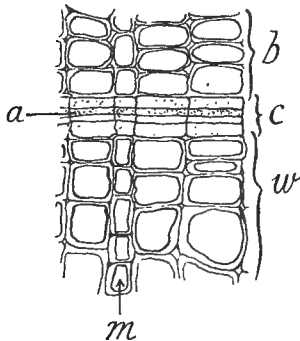

FIG. 56.—Transverse section through a small portion of the cambium-ring in a young black currant shoot. *c* Cambium; *a* initial cell; *w* wood; *b* bast; *m* medullary ray. (Enlarged about 450 diameters.)

Each initial cambium-cell (*a*, Fig. 56) divides in two by a wall parallel to the surface of the stem; one of these two daughter-cells remains permanently capable of division while the other is either directly converted into a permanent cell, or divides once or twice, after which the cells produced become gradually changed into permanent elements. The change into a permanent cell or cells may happen

to either of the two produced by division of the initial cell; if the inner one is modified it is added to the wood (*w*), if the outer one is altered it goes to increase the bast (*b*)

Division of the cambium-cells, and the growth and development of the products continue from spring to autumn; in winter, cell-division ceases. Since the cambium extends in the form of a continuous cylinder within the stem, a new cylinder of wood is added every growing season to the outside of that already

present, and a similar addition is made to the bast on its inside. The amount of wood produced by the cambium is always very much greater than the bast. Moreover, the bast tissue consists chiefly of thin-walled elements which become crushed into very thin sheets by the pressure of the expanding wood and the resistant bark, whereas the wood with its thick-walled cells and vessels suffers little in this manner ; in transverse sections of the

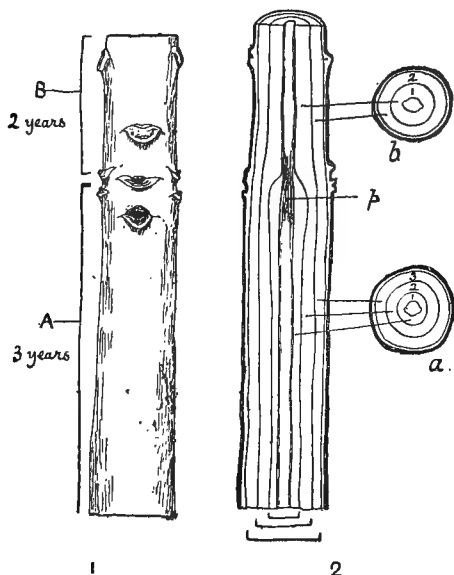

FIG. 57.—1. Piece of a stem of an ash tree. *A*, Portion three years old ; *B*, portion two years old. 2. Longitudinal and transverse sections of same.

trunks and branches of trees and shrubs the cambium appears to the naked eye to produce wood only.

(*b*) **Annual rings : knots.**—If a tree is sawn across and the cut surface then smoothed with a chisel a number of ring-like zones are noticeable in the wood (Figs. 57 and 58) ; these are

termed *annual-rings* and each represents the wood-tissue produced by the cambium during one active vegetative period. From the beginning of one vegetative period to the commencement of another is generally one year, so that in a two-year-old stem two rings are visible, in one three-year-old three rings are seen, and so on (Fig. 57).

It is on account of certain differences between the wood made at the commencement of the growing season and that produced at the end that we are able to recognise these successive yearly additions to the wood as distinct bands, for if the elements produced by the cambium were of exactly similar character throughout its life, it would not be possible to determine the points at which the cambium had ceased or recommenced its growth.

When the cambium commences growth in spring it gives rise to vessels and cells with thinner walls and wider cell-cavities than those which it manufactures in late summer and autumn; in each annual ring (*r*, Fig. 64), therefore, two more or less distinct portions are visible, namely, (i) a layer of *spring-wood* (*s*) produced early in the growing season, and (ii) a layer of what is termed *autumn-wood* (*a*) produced in late summer and autumn.

The spring-wood is generally of soft nature and pale colour; in oak, elm, ash, and Spanish chestnut its vessels are so wide that they appear to the naked eye as a zone of pores.

The autumn-wood is harder and generally of darker colour; fewer vessels are present in it, and they are usually too small to be seen with the naked eye.

The cambium of a stem is continuous with that of its branches, and in a longitudinal section (Fig. 58) the annual increment to the wood of the stem is seen to be continued in the branches, although in the latter the amount added per annum is smaller than in the stem, and consequently the annual rings of a branch are narrower than those of same age in the stem.

It will be seen from the above Fig. that the basal portions

of a branch become buried by the wood added to the stem year by year: on cutting a longitudinal board as indicated at *C*, the buried part of the branch is cut almost transversely, and appears as an oval *knot* (*k*).

(c) **Elements produced by the cambium: medullary rays.**—As the cambium lies between the wood and bast, it is obvious that the *primary* first-formed wood and bast of the vascular bundles

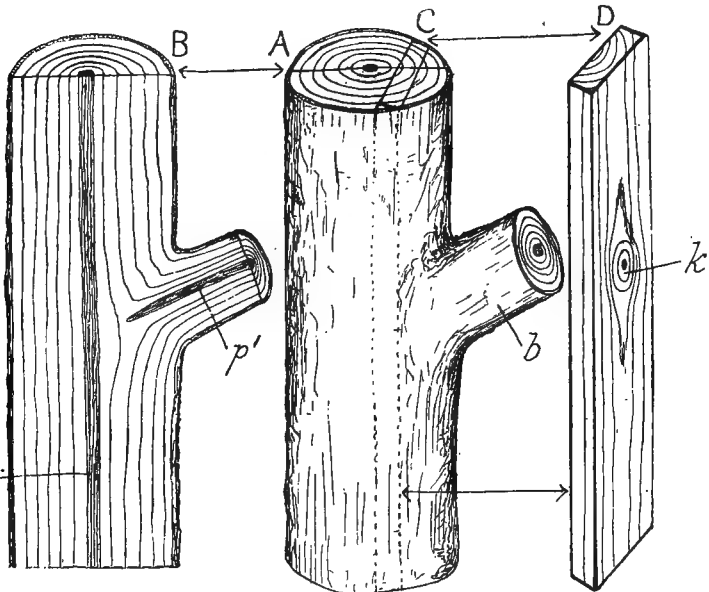

FIG. 58.—*A*, Stem of a tree six years old with branch *b*; *B*, longitudinal section of the same, showing all annual rings of stems except the first continued in branch; *D*, longitudinal board cut from *A*; *k* knot (transverse section of branch *b*).

must be gradually pushed further apart by the *secondary* wood and bast produced by the cambium, so that in old stems the primary wood is found surrounding the pith in the centre, while the primary bast is met with near the outside (*C*, Fig. 60).

The elements forming the secondary wood are similar to those

of the primary wood, namely, tracheæ or vessels, tracheids, fibres, fibrous cells and wood-parenchyma ; the vessels and tracheids, however, are never spirally or annularly thickened, but usually marked with bordered pits and reticulate thickenings.

All these elements may be present or only a few ; for example, the wood of the yew consists of tracheids only, that of the bulk of coniferous trees of tracheids and wood-parenchyma, while the wood of most dicotyledons contains all the above-mentioned elements.

The elements of the secondary bast are similar to those of the primary bast, namely, sieve-tubes with their companion-cells and parenchyma ; bast-fibres and living fibrous cells are also present in some cases. After functioning for a short time as conductors of food, the sieve-tubes, companion-cells and most of the bast-parenchyma become empty, and in the older parts are compressed into an irregular mass in which no cell cavities are visible. When firm thick-walled bast-fibres are abundant, as in lime and other trees, the bast in transverse sections appears in the form of thin, ring-like bands.

Besides the production of wood and bast, certain cells of the cambium-ring become changed into medullary ray cells (*m*, Fig. 56); the primary medullary rays existing between the first-formed vascular bundles of the unthickened stem are continued by the interfascicular cambium when thickening begins and therefore always extend right through from the pith to beyond the bast. Totally new *secondary* medullary rays are subsequently started by certain cells of the cambium ring at successive irregular intervals during the growth in thickness. These new medullary rays extend from the annual rings of wood in which they first appear to the corresponding bast rings on the opposite side of the cambium ; they are therefore of variable length.

The medullary rays are of variable width even in the same stem. Sometimes they are only one cell thick and in trans-

verse sections are scarcely visible to the naked eye, while in oak, beech and other kinds of timber, many of them are several cells thick, and in transverse sections appear as distinct light-coloured radial bands (*m*, Fig. 64). In true radial longitudinal sections, when seen at all, they appear as transverse bands of variable vertical diameter running from the pith outwards (Fig. 62), the primary rays have the greatest vertical breadth. In longitudinal sections cut obliquely to the radius of the stem small portions only are visible as bran-like spots.

The cells of the medullary rays are brick-shaped, generally with thick pitted walls and living contents, which they often retain for a long time. They conduct various food-products manufactured in the leaves, and in winter starch and various food-substances are stored in them for use in the following season. Air circulates to all parts of the wood and bast in the intercellular spaces between the medullary ray cells.

(*d*) **Heart-wood and splint-wood.**—In the old stems of oak, walnut, larch, yew and other trees, the wood of the annual rings in the centre of the tree is heavier, harder, darker in colour, and drier than that of the younger rings near the cambium: this dark wood is known as *heart-wood* or *duramen*, while the light-coloured softer wood surrounding it is termed *splint-wood*, *sap-wood* or *alburnum*. The width of the splint-wood or the number of annual rings over which it extends is not the same in all trees, nor is it always the same in the same species of the same age.

The splint-wood is the part which conducts the 'sap' and many of its parenchymatous cells are still living: starch, sugar and other compounds readily attacked by fungi are generally stored in it, and from its liability to rot it is valueless as timber.

The heart-wood acts as a strong support for the rest of the tree: its vessels no longer conduct water and the parenchyma of the wood and medullary rays have lost their living contents. Various gummy and resinous compounds block up the cell-cavities and in some cases calcium carbonate is present in

them. *Tyloses* or peculiar bladder-like protrusions from the adjoining thin-walled cells also block up the cavities of the vessels. Tannin and colouring matters are also present in the cell-membranes and cavities of the heart-wood of many trees. Some of these substances act as preservatives against the attacks of insects and fungi, and to them the durability of the heart-wood is due. Whilst in oak, ash, elm, walnut, apple, laburnum, larch, various pines, and many other trees a considerable difference in colour is observable between the heart-wood and splint-wood; in beech, hornbeam, sycamore, lime, silver-fir, and spruce no such distinction of colour is visible to the naked eye; but the heart-wood of these trees can frequently be distinguished from the splint-wood by its dryness, although small numbers of living cells are sometimes present in wood of this character right through to the pith even in trees of considerable age. Trees of the latter type are more liable to become hollow than those in which a coloured heart-wood is present.

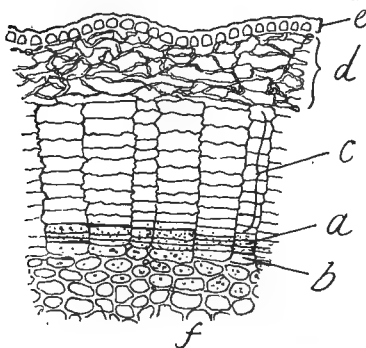

FIG. 59.—Transverse section through periderm of a young black currant shoot. *a* Phellogen; *c* cork; *b* phelloderm just forming; *f* bast of the stem; *d* withered primary cortex; *e* epidermis. (Enlarged 270 diameters.)

(*e*) **Periderm.**—In annual and perennial herbaceous stems, the epidermis and primary cortex grow at the same time as the cambium is increasing the bulk of wood and bast in the vascular cylinder, so that a continuous covering is maintained in such stems in spite of the internal growth in thickness. Even in some woody stems,

such as mistletoe and holly, the epidermis persists and keeps pace for years with the growth of the wood and bast within. In the majority of woody stems, however, the epidermis and primary cortex are ruptured

by the pressure exerted by the growth of the wood, and their place is taken by totally new tissues which arise by division of a meristem known as the *phellogen* or *cork-cambium* (*a*, Fig. 59).

This phellogen may arise in the epidermis itself, in the cortex or even in the pericycle within the vascular cylinder. The divisions of its cells take place in a manner similar to those of the ordinary cambium, but instead of producing wood and bast tissue it gives rise on its inside to *phellogen* or *secondary cortical tissue* (*b*) and on its outside to *cork* (*c*). To the phellogen and the products of its growth the term *periderm* is applied.

In most aerial stems little or no phellogen is formed: when present its cells have thin walls, and protoplasmic contents; chloroplasts are generally present in the tissue when it is developed near the surface of the stem.

The cork-tissue formed by the phellogen shields and protects the interior of the stem from mechanical injuries and prevents the stem from losing water by transpiration.

Cork is also a bad conductor of heat and efficiently protects the delicate phellogen and cambium from excessive heat in summer and frost in winter.

It consists of a number of layers of cells which fit closely together in regular radial rows (*c*). The cells soon die and generally become filled with air only; their walls are mostly thin, often brownish in colour and impermeable to water and gases.

'Corks' for bottles are cut from the extensive cork-tissue of the Cork Oak (*Quercus Suber* L.).

When the phellogen originates in a deep layer of cortical cells or in the pericycle, all the tissues outside it become cut off from water and food supply by the cork which is formed: these tissues dry up in consequence, and, together with the cork constitute what is sometimes spoken of as *bark* by botanists, although in popular language the term bark is applied to all tissues which are external to the cambium of a stem.

Scattered over the outer surface of the periderm of most woody

branches and stems are small brownish or whitish spots termed *lenticels*; they are well seen on elder stems, potato tubers, and

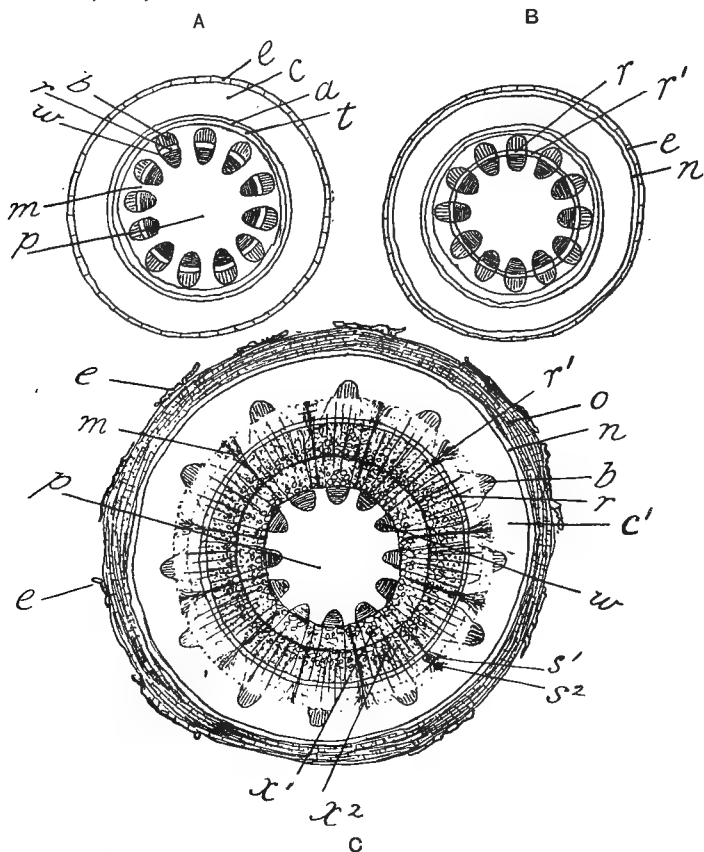

FIG. 60.—Diagrams illustrating secondary growth in thickness of the stem of a dicotyledon. *A*, A young stem before the formation of interfascicular cambium. *B*, After interfascicular cambium has formed. *C*, The same stem two years old. *e* Epidermis; *c* cortex; *a* endodermis; *t* pericycle; *w* primary wood; *r* cambium; *b* primary bast of a vascular bundle; *r'* interfascicular cambium; *p* pith or medulla; *m* medullary rays; *n* phellogen; *o* cork; *c'* secondary cortex; *x'* and *x²* annual rings of secondary wood; *s'* and *s²* rings of secondary bast.

young apple and pear shoots. On ordinary shoots they are developed at the places where stomata occur in the epidermis and serve for the admission of air through the periderm into the intercellular spaces of the medullary rays and other parts of the stem.

(*f*) **Healing of wounds on woody stems.**—Wounds made into the soft parenchymatous parts of herbaceous stems, leaves, tubers,

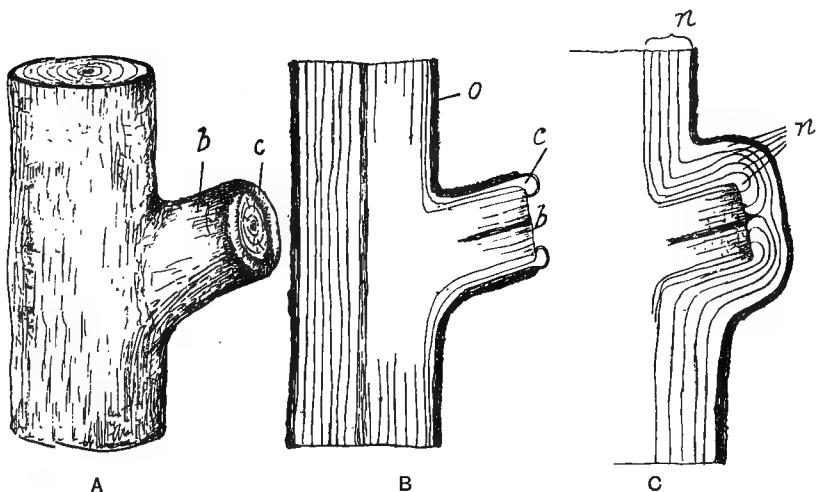

FIG. 61.—*A*, Stem with amputated branch (*b*); *c* callus.
B, Longitudinal section of *A*; *c* callus formed by exposed cambium; *b* exposed wood of the branch.
C, Longitudinal section after the exposed wood of the branch has been completely covered over by five annual growths (*x*).

and fruits soon become healed over by the formation of a layer of cork-cells which develop from the uninjured cells exposed by the wound. When the mature wood of a stem or branch is exposed (*b*, Fig. 61) it becomes covered by the gradual extension of a tissue manufactured chiefly by the cambium. The cambium exposed by the cut and the very young cells of the wood and bast at first give rise to a mass of soft parenchyma-

tous tissue termed *callus* (*c*). In the outer parts of the latter there soon forms a cork-cambium while within it is developed a new cambium from which wood and bast are ultimately produced. Year by year the new tissues produced by the cambium extend further and further inwards over the exposed wood (*b*) until the edges meet all round, after which time the cambium exists as a continuous layer over the wounded surface (*C*, Fig. 61).

The new wood formed as a cap-like covering over the exposed old wood (*b*) does not actually coalesce with the latter and the position of old wounds into the wood can always be easily recognised in sections, although they may be so completely overgrown and buried in the succeeding growth that no external sign of their existence is visible.

The length of time necessary to cover a wound depends upon its size, and the vigour and nutrition of the cambium. Clean cut wounds heal more rapidly than jagged ones, and when large branches are amputated with a saw it is advisable to trim the exposed edges of the cambium with a sharp chisel or knife. In the case of wounds where a considerable portion of old wood is laid bare and which cannot therefore be overgrown in a short time it is also important to cover this portion of the wounded surface with Stockholm tar or some similar antiseptic dressing to prevent its decay.

Ex. 59.—Cut across one, two and three year old branches of ash, and make the surface of the section smooth with a sharp knife : notice the annual rings in each.

Make longitudinal sections of similar pieces of ash twigs, and notice the arrangement of the yearly growths where one piece joins another a year younger (compare with Fig. 57).

Make similar observations on as many common trees as possible.

Ex. 60.—Prepare sections of a piece of a larch pole 4 or 5 inches in diameter : cut with a saw and then carefully smooth with a sharp chisel or plane.

Transverse, longitudinal, and oblique sections should be made.

Study the arrangement of the yearly rings in sections cut as in Fig. 58 to illustrate the nature of a knot.

Ex. 61.—Examine boards of different kinds of wood : observe the arrangement of the annual rings on the sides and ends. Try and determine whether the boards were cut from near the middle or the outside of the trees. Observe also the distribution and size of the knots.

• **Ex. 62.**—Cut blocks as in Fig. 62 of various kinds of common timber. Examine with the naked eye and with a pocket lens : notice the presence

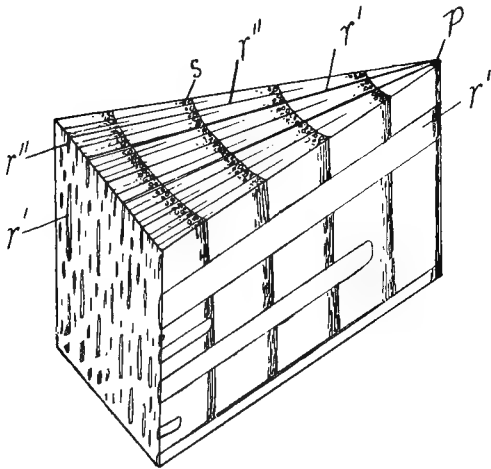

FIG. 62.—Diagram showing transverse, radial, and tangential views of a block of wood from a tree five years old. *P* Pith or medulla; *r'* primary, *r''* secondary medullary rays; *s* zone of porous spring-wood.

or absence of wide vessels in the spring zone of the annual ring, and the number, width and other characters of the medullary rays as seen in transverse and longitudinal sections.

Ex. 63.—Notice the well-marked heart-wood in transverse sections of larch, laburnum and other trees ; test whether the splint-wood is harder or softer than the heart-wood.

Ex. 64.—Notice the development of callus at the edge of the wound where a thickish branch has been cut off an apple, pear or other tree.

Ex. 65.—Make transverse sections through a young stem of a black currant about mid-summer, mount them in a drop of water or glycerine.

Sketch the parts as seen with a low power ; afterwards use a high power, and make drawings of small portions of the epidermis, cortex, cork, phellogen, bast, cambium, wood pith and medullary rays.

Cut longitudinal sections of the same ; examine and make sketches of the various parts.

Ex. 66.—Cut and examine in a similar manner young one-year-old shoots of beech, oak, elm and ash trees.

Also make and compare under a low power, transverse, radial and tangential, longitudinal sections of pieces of the common timbers.

In the following tables are given the characters of the common timbers, which can be easily distinguished with the naked eye and a pocket lens :—

I.—TIMBER OF CONIFEROUS TREES.

In these timbers the annual rings are very distinct (Fig. 63), the autumn-wood is hard and dark-brown or reddish in colour, and sharply marked off from the spring-wood, which is soft and much paler in tint. Neither medullary rays nor porous rings are visible.

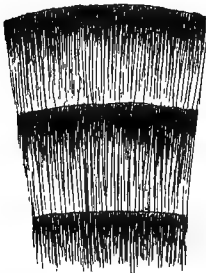

FIG. 63.—Transverse section through annual rings of larch timber. (Four times natural size.)

1. Heart-wood same colour as the Splint-wood.

(a) **Silver Fir** (*Abies pectinata* D. C.).

(b) **Common Spruce** (*Picea excelsa* Lk.).

Both these are soft 'white woods,' pale yellowish or reddish-white in colour. The spruce possesses a few fine resin ducts in its autumn-wood which may be seen in cross-sections as very small light spots: they are missing from the wood of the silver fir.

2. Heart-wood in old dry timber, reddish-brown ; splint-wood, pale yellow.

(a) **Larch** (*Larix europæa* D. C.). Rings of autumn-wood dark red and very distinct. The branches arise irregularly on the stem, so that the knots on larch boards are scattered irregularly.

(b) **Scots Pine** (*Pinus sylvestris* L.). Rings of autumn-wood not so dark as larch, and contains larger, more distinct resin-ducts. The branches arise in whorls at regular intervals, and the knots are similarly distributed on boards cut from this tree.

II.—TIMBER OF DICOTYLEDONOUS TREES.

GROUP A.

Vessels of the spring-wood of each annual ring visible to the naked eye as a distinct circle of pores (Fig. 64); autumn-wood denser.

To this group belong :—

Oak.	Elm.
Ash.	Spanish Chestnut.

1. Many medullary rays wide, and visible as light coloured radial bands.

Oak (*Quercus Robur* L.). (Fig. 64.)

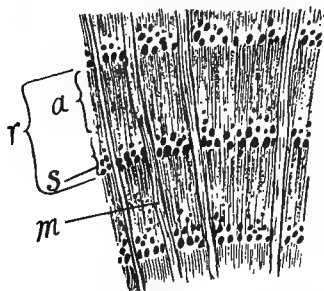

FIG. 64.—Transverse section through annual rings of oak timber. *r* One annual ring; *s* spring-wood; *a* autumn-wood; *m* broad medullary ray. (Four times natural size.)

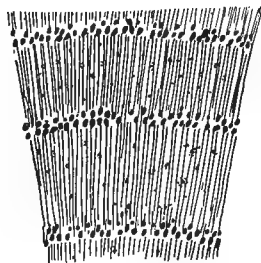

FIG. 65.— Transverse section through annual rings of ash. (Four times natural size.)

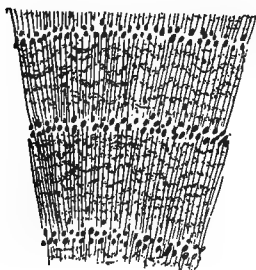

FIG. 66.— Transverse section through annual rings of elm. (Four times natural size.)

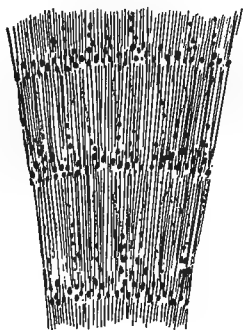

FIG. 67.— Transverse section through annual rings of Spanish chestnut. (Four times natural size.)

2. All medullary rays narrow, and scarcely, or not at all, visible to the naked eye.

(a) **Ash** (*Fraxinus excelsior* L.). With a lens the fine vessels in the autumn-wood appear few and scattered fairly regularly throughout. (Fig. 65.)

- (b) **Elm** (*Ulmus campestris* Sm.). The fine vessels in the autumn-wood appear arranged in many light coloured bands or lines more or less parallel to the boundary of the annual ring (Fig. 66). The wood of elm is darker than that of ash.
- (c) **Spanish Chestnut** (*Castanea vulgaris* Lam.). The fine vessels of the autumn-wood are arranged in radial lines (Fig. 67), distinguished from oak, which it somewhat resembles in colour, by absence of wide medullary rays.

GROUP B.

Annual rings with little or no difference between the spring and autumn portion; vessels scarcely, or not at all, visible to the naked eye.

To this group belong:—

Beech.	Lime.
Hornbeam.	Willow.
Sycamore.	Poplar.

1. Some of the medullary rays broad and readily visible to the naked eye, the rest fine and only seen with a lens.

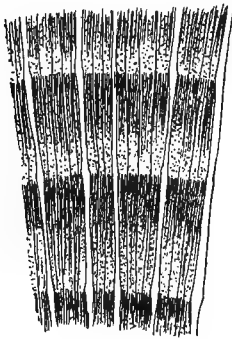

FIG. 68.—Transverse section through annual rings of beech. eye. (Four times natural size.)

(a) **Beech** (*Fagus sylvatica* L.). (Fig. 68.) Wood reddish; medullary rays with a silky-shining lustre.

(b) **Hornbeam** (*Carpinus Betulus* L.). Wood yellowish-white; medullary rays dull and indistinct.

2. All the medullary rays very narrow, but appearing to the naked eye as very fine distinct lines.

(a) **Sycamore** (*Acer Pseudo-platanus* L.). Wood hard, heavy, and white or pale yellow in colour.

(b) **Lime** (*Tilia* Sp.). Wood light, soft, and reddish-white.

3. Medullary rays quite invisible to the naked eye.

(a) **Willow** (*Salix caprea* L.). Splint-wood very pale red; heart-wood deeper.

(b) **Poplars** (*Populus* Sp.). Splint-wood white; heart-wood brownish.

C. Stems of Monocotyledons.

In transverse sections through the stem of a monocotyledon, a conspicuous difference is seen in the arrangement of the

vascular bundles from that met with in dicotyledons. Instead of being arranged in a single ring, they appear scattered in several irregular circles throughout the ground tissue (Figs. 69 and 70). Usually the cortex is very narrow and inconspicuous and a distinct pith is rarely present. The bundles are common to leaf and stem as in dicotyledons, but on entering from a leaf they bend gradually inwards to near the middle of the stem, and then generally curve outwards again, finally joining other bundles near the outside of the stem.

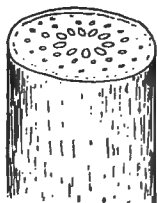

FIG. 69. — Transverse section through a young asparagus stem. (Three times natural size.)

In addition to these differences, measurement shows that the older parts of such stems which have ceased to grow in length are no thicker than the young parts near the tip; that is to say, the stems of most monocotyledons do not increase in thickness when once they have ceased to grow in length. This incapacity for growth in thickness is due to the fact that the vascular bundles do not possess a cambium tissue, nor is such meristem developed in the ground tissue except in a few special cases which we cannot deal with here. Vascular bundles in which no cambium is present are known as *closed* bundles.

In most grasses the vessels of the wood of each bundle are few in number, and in transverse section appear arranged in the form of a V (Figs. 70 and 71); the vessel nearest the centre of the stem is annular, the others being spirally thickened. Tracheids are not uncommon and thin-walled wood-parenchyma is always present.

The bast which lies between the free limbs of the V-shaped wood consists entirely of sieve-tubes and companion-cells. The ground-tissue immediately surrounding each bundle is generally thick-walled and gives mechanical support and protection to the soft parts of the bundle. Similar thickened ground-tissue in larger or smaller amount is met with beneath the epidermis, the rest being thin-walled tissue.

Ex. 67.—Cut sections through the stems of maize, asparagus, or any species of lily : observe with a lens the scattered arrangement of the vascular bundles.

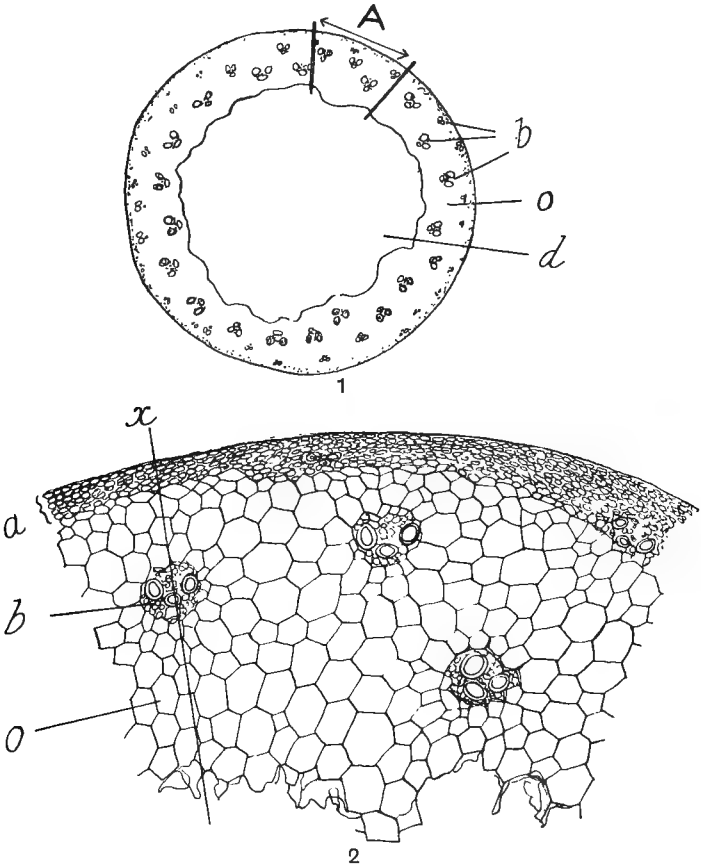

FIG. 70.—1. Transverse section through a barley stem. *b* Vascular bundles ; *o* ground-tissue ; *d* hollow cavity. (Enlarged 14 diameters.)
 2. Enlarged view of portion *A*. *a* Thick-walled ground-tissue cells and epidermis ; *o* thin-walled ground-tissue cells ; *b* vascular bundle. (Enlarged about 90 diameters.)

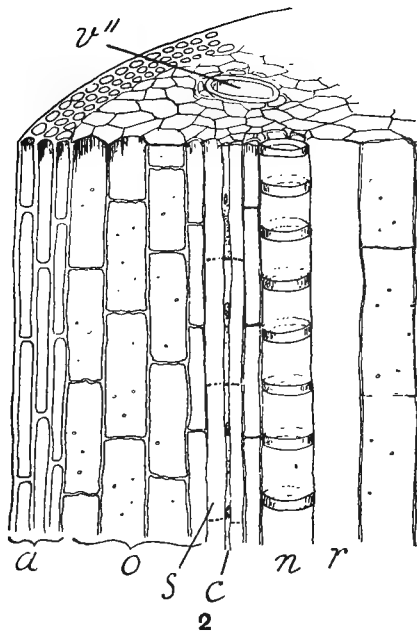
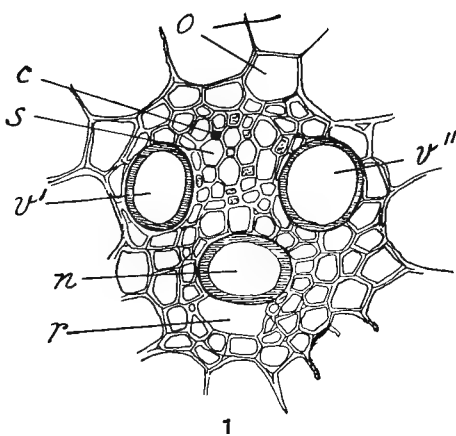

FIG. 71. —1. Transverse section of a vascular bundle in barley stem. (Enlarged 420 diameters.)
 2. Longitudinal section through portion ground-tissue and a vascular bundle along line *x* in previous figure. *a* Epidermis and thick-walled ground-tissue cells; *o* thin-walled ground-tissue cells; *s* sieve-tube; *c* companion-cell of the bast; *n* annular vessel; *v'* and *v''* spiral vessels of the wood; *r* intercellular space.

Ex. 68.—Make thin transverse sections of a wheat or barley stem. Examine with a low power: observe the thick walls of the epidermal and subjacent ground-tissue cells; note also the scattered vascular bundles and hollow centre.

Sketch a single vascular bundle as seen under a high power; note especially the absence of cambium.

Take two or three pieces of barley or wheat straw each about a quarter of an inch long, and press them flat. After placing them together, hold them in your fingers and cut longitudinal sections, some of which will pass wholly

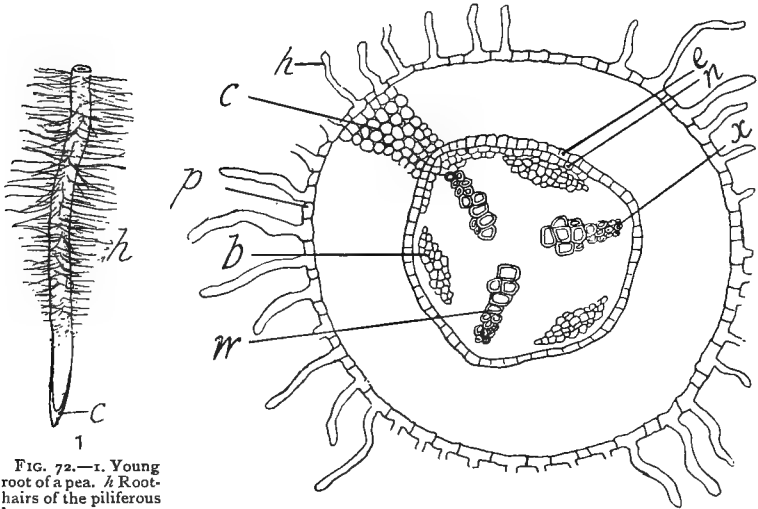

FIG. 72.—1. Young root of a pea. *h* Root-hairs of the piliferous layer; *c* root-cap. (Twice natural size.)

2. Transverse section through a young root of a pea near *h* in 1. *h* Root-hairs; *c* cortex; *p* piliferous layer; *e* endodermis; *n* pericycle; *w* wood strand; *x* its protoxylem; *b* bast strand. (Enlarged 48 diameters.)

or in part through a vascular bundle. Examine the sections first with a low and then with a high power; make sketches of the epidermis, thick and thin walled ground-tissue, and annular or spiral vessels of the wood.

THE ROOT.

The outermost part of a young root, corresponding in position with the epidermis of the stem, consists of a single layer of cells

termed the *piliferous layer*: it is directly concerned with the important work of absorbing watery solutions from the soil. In a transverse section (2, Fig. 72) taken at a point not far away from the extreme end of the root, many of the cells of this layer are seen to be much elongated; these are the *root-hairs*, previously mentioned in chapter iii. The cell-walls are all thin and uncuticularised and are readily permeable to water, thus differing essentially from the epidermal cells covering the parts above ground.

Immediately beneath the piliferous layer is the *cortex* (*c*), which is continuous with the same ground-tissue in the stem. The cells of the cortex are usually parenchymatous and thin-walled with many intercellular spaces between them; chloroplasts are frequently absent, hence the pale colour of most young roots.

The innermost layer of the cortex, or the *endodermis* (*e*), is generally very distinct in roots. Its cells are closely united with each other in the form of an uninterrupted circle, an arrangement which effectually prevents the leakage of gases from the intercellular spaces of the cortex into the water-conducting tissues of the central cylinder. The transference of water from the root-hairs and cortex through the endodermis into the conducting tissues of the central cylinder is, however, not interfered with.

In most roots the central cylinder is of smaller diameter, and contains less parenchyma than that of the stem, although one is a continuation of the other. It is, however, in the disposition of the tissues within the central cylinder that the most important differences between stems and roots are seen.

The pericycle (*n*), like that of a stem, may consist of a single layer or several layers of cells. From this internal tissue arise all lateral secondary roots, which must therefore necessarily bore their way outwards through the surrounding cortex before they become visible on the outside of the root (see Fig. 9). The wood (*w*) and bast (*b*) portions of the vascular bundles, instead of being conjoined as in a stem, are arranged alternately side by

side on separate radii drawn from the centre of the root with small intervening bands of ground-tissue between them.

Moreover, in roots the first-formed, narrow-bored elements (x) of the primary wood are nearest the outside, while in stems they are nearest the centre.

According as the number of separate strands of wood is two, three, or many, the roots are described as *diarch*, *triarch* (as in Fig. 72), or *polyarch* respectively.

The number of rows of secondary roots generally corresponds to the number of strands of primary wood in the parent root, each row being formed in the pericycle almost opposite a wood strand.

In all roots the development of the primary wood proceeds inwards and frequently it goes on until the several strands unite to form a mass which occupies the centre to the complete exclusion of pith. Nevertheless, in some roots, and especially those of monocotyledonous plants, pith is present.

The roots of perennial dicotyledons increase in thickness just as the stems do, but owing to the different disposition of the primary tissues the first formation of the cambium is not the same as in a stem. In roots the cambium first forms in the ground-tissue on the inside of the bast-strands, and subsequently within the pericycle opposite the primary wood; in transverse sections, therefore, the cambium in the early stages of its existence appears as a wavy band of meristem (2, c, Fig. 73).

When active growth of the cambium takes place, the wavy outline is soon lost and it is then seen as a simple ring of meristem, producing secondary wood and bast in a manner precisely similar to the cambium of an ordinary stem.

In roots which grow in thickness, a phellogen arises in the pericycle and like that of thickening stems produces cork externally and phelloderm internally. In consequence of the formation of a ring of cork by the phellogen, all the tissues external to it, namely, the endodermis, primary cortex and

piliferous layer, wither and shrivel. The older portions of a root after becoming covered by a protective periderm lose their absorptive function and henceforward act chiefly as conductors of the watery solutions absorbed by the younger parts still possessing root-hairs. For an account of the characteristic root-cap which covers the growing point of practically all roots see pp. 149 and 150.

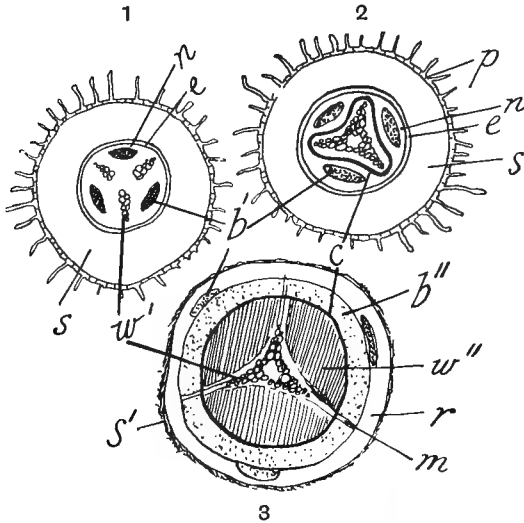

FIG. 73.—Diagram illustrating secondary growth in thickness of the root of a dicotyledon. 1. Transverse section of a very young root. 2. The same after the cambium (*c*) has formed a continuous band. 3. The same after secondary thickening has been in progress some time. *p* Piliferous layer; *s* primary cortex; *e* endodermis; *n* pericycle; *b'* primary bast; *w'* primary wood; *c* cambium; *b''* secondary bast; *w''* secondary wood; *r* secondary cortex; *m* primary medullary ray.

Ex. 69.—Soak some peas and barley grains in water for six or seven hours, and afterwards allow them to germinate on damp blotting paper or flannel as in Ex. 3. When the root-hairs are visible on the young roots examine them with a lens and make sketches noting especially their origin away from the extreme tip.

Strip off with forceps a piece of the outer portion of a root, so as to

include the root-hairs: mount it in water and examine first with a low and then with a high power.

Ex. 70.—Cut transverse sections of a young root of a bean or pea through the region bearing root-hairs, and place them for twenty minutes in 'Eau de Javelle' (Ex. 75): wash them and mount in glycerine.

Examine with a low power; observe and sketch the piliferous layer bearing root-hairs, the parenchymatous cortex and the central vascular cylinder.

Examine with a high power and make drawings of the wood and bast strands, pericycle and endodermis.

Ex. 71.—Cut transverse sections of the older parts of the root of a pea or bean, near where the lateral roots are just beginning to appear. Clear with 'Eau de Javelle' and mount in glycerine. Make a sketch of a section which shows the lateral roots boring their way through the cortex.

THE GREEN FOLIAGE-LEAF.

The leaves are built up of the same tissues as the stems and roots, namely, of epidermis, vascular bundles, and ground-tissue, but the arrangement and constitution of these tissues are different. The vascular bundles coming from the stem run into the leaf and in dicotyledons branch repeatedly in one plane to form a fine net-work of strands, which conducts sap to and from all parts of the leaf and at the same time acts as a firm framework for the support of the soft ground-tissue. In monocotyledons the main branches of the bundles which enter a leaf generally take a parallel course and are connected by smaller oblique strands.

The bundles of the leaves are always *closed*, there being no need for an active cambium in parts of the plant which are of such limited growth.

As the bundles curve out of the stem into the leaf without twisting, the wood comes to lie nearest the upper surface of the leaf, and the bast nearest the lower surface.

With the exception of the absence of cambium the larger vascular bundles of the leaf resemble those of the stem. The wood of the finer strands, however, consists of spirally thickened elements only, and the extreme tips of the bundles which in

dicotyledons end blindly among the ground-tissue cells, are formed entirely of tracheids.

The bast-tissue also undergoes a reduction of elements: as the end of the bundle is approached, the sieve-tubes and companion-cells are replaced by single long cells which do not extend so far as the woody elements of the bundle. Surrounding each bundle of the leaf is a sheathing tissue of parenchyma which is continuous with the parenchyma of the vascular cylinder of the stem. Such bundle-sheaths conduct carbohydrates from the leaf to the stem and frequently contain small starch-grains.

The epidermis covers the whole leaf and, like that of the stem with which it is continuous, consists of a single layer of cells, the outer walls of which have a protective cuticle.

A surface view (Fig. 74) shows that the cells fit closely together except where the *stomata* occur. Each stoma consists of two curved sausage-shaped cells (*a*) termed *guard-cells*, which are joined together at the ends in such a manner that a narrow slit-like pore or opening is left between them. The pore leads through the epidermis into a somewhat large *air-chamber* just inside the ground-tissue of the leaf, and this chamber communicates with the air-filled intercellular spaces all through the leaf.

Changes in the curvature of the guard-cells reduce or increase the size of the pores of the stomata; when the cells are much curved the pore is widely opened and when they become straight the slit is closed.

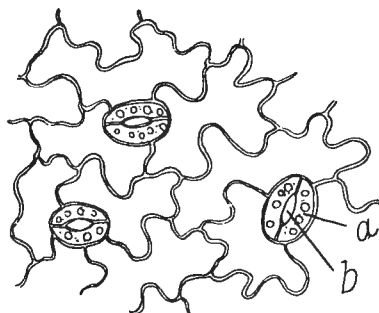

FIG. 74. — Surface view of the epidermis of a bean leaf. *a* Guard-cel's of a stoma; *b* the opening between them. (Enlarged 320 diameters.)

The stomata are organs specially adapted for the escape of

water-vapour in the transpiration process, and are concerned also with the interchange of gases which goes on between the atmosphere and the air within the plant in the process of respiration and 'assimilation.'

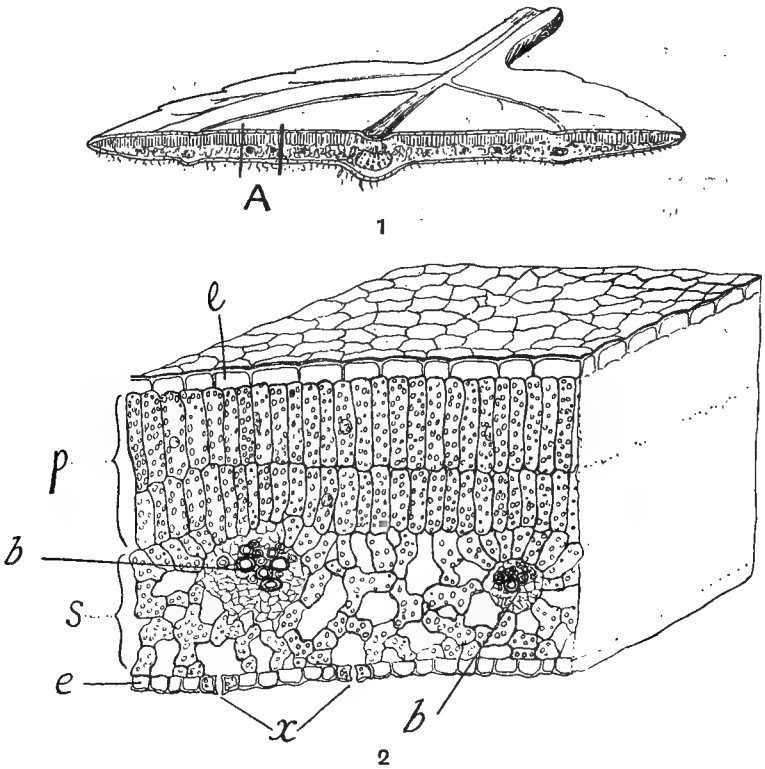

FIG. 75.—1. Transverse section through a plum leaf (somewhat diagrammatic).
2. Enlarged view of portion A from 1. *e* Epidermis; *x* stomata; *p* palisade parenchyma; *s* spongy parenchyma; *b* vascular bundles. (Enlarged 160 diameters.)

The ground-tissue of the leaf is a continuation of the cortex of the stem and is termed the *mesophyll*. In ordinary flat leaves

it is generally differentiated into two distinct parts, namely, (i) the *palisade parenchyma* which lies beneath the upper epidermis of the leaf, and (ii) the *spongy parenchyma* which extends between (i) and the lower epidermis. A transverse section across a leaf is given in Fig. 75. The cells forming the palisade tissue are somewhat cylindrical with their long cells at right angles to the surface of the leaf; they have very few intercellular spaces between them. The cells of the spongy parenchyma are very irregular in form and enclose large intercellular spaces.

All the cells of the mesophyll contain numerous chloroplasts but it is in the palisade cells that they are most abundant, a fact which, together with the comparative absence of intercellular spaces, accounts for the upper side of a leaf being usually a deeper green colour than the lower side.

Ex. 72.—Strip off a piece of the lower epidermis of a bean leaf and mount it in water. Note the irregular outline of the cell-walls and the way in which they fit one with another. Make sketches of these and of the stomata with their guard-cells. Examine, in a similar way, the upper and lower epidermis of the leaves of turnip, plum, apple, onion, grasses and other common plants. Note the form of any hairs which are present.

Ex. 73.—Cut five or six pieces, each about one-eighth of an inch broad and half an inch long, from the blades of a plum leaf. Place them one on another, hold them in the fingers and cut transverse sections. Mount some of the thinnest sections in water and examine first with a low and then with a high power.

Sketch the parts seen, namely,—

- (1) The upper and lower epidermis with nuclei, protoplasm, and clear cell-sap;
- (2) The palisade tissue of several layers; and
- (3) The spongy parenchyma in which are many large intercellular spaces.

Possibly the sections of one or more stomata may be seen.

Ex. 74.—Cut transverse sections through the mid-rib and petiole of several different kinds of leaves. Note and sketch the position and character of the wood and bast of the vascular bundles cut across; and also the thickness of the walls and nature of the contents of the cells surrounding the bundles.

Ex. 75.—Prepare some 'Eau de Javelle' by first dissolving two ounces of carbonate of soda in a pint of water and then adding one ounce of 'bleaching

powder.' Allow the mixture to stand after stirring, and pour off the clear liquid into a well-stoppered glass bottle: keep in the dark.

Collect a few thin leaves of plants and kill them by immersing them for a minute in boiling water. Then place them in some 'Eau de Javelle'; leave them in it a few hours and when quite bleached, wash in water for an hour or two and then mount in weak glycerine. Examine with a low power, observe the ramifications and endings of the bundles, also the parenchymatous bundle-sheath. Focus on the surface and note the form, number, and size of the stomata and hairs.

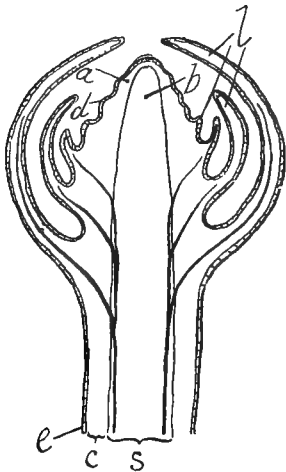

FIG. 76.—Diagrammatic longitudinal section through the apex of a stem. *d* Dermatogen which gives rise to the epidermis *e*; *c* cortex produced from perilem *a*; *s* vascular cylinder produced from plerome *b*; *l* leaves.

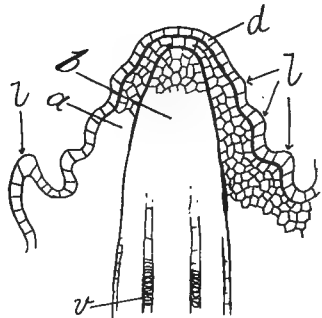

FIG. 77.—Enlarged view of the apex of the stem in the previous figure. *d* Dermatogen; *a* perilem; *b* plerome; *v* vessels of the protoxylem; *l* rudimentary leaves.

THE GROWING-POINTS OF STEMS AND ROOTS.

The *growing-points* or regions where the formation of new organs and tissues takes place are situated at the end of the stems and roots.

(i) *Growing-point of the stem.*—The apex of the stem is

always completely enclosed and protected by young leaves (Fig. 76) and consists of a dome-shaped mass of meristem, from which are derived all the various tissues already studied in the mature stem and leaf. The cells forming the meristem, are approximately uniform in size and form : they possess thin walls and are rich in protoplasm.

In a favourable longitudinal section through the growing-point three distinct strata are often visible (Figs. 76 and 77). Covering the apex is a single layer (*d*) termed the *dermatogen* which divides only by walls at right angles to the surface and gives rise to the epidermis of the plant.

Beneath the dermatogen comes the *periblem* (*a*) from which the cortex is derived. At the extreme apex it may be only one cell thick, but in the older parts division takes place in several directions and a many-layered stratum is produced.

Occupying the centre is a solid mass of meristem termed the *plerome* (*b*): from it the vascular cylinder is developed within which at a short distance from the apex the differentiation of the vascular bundles begins to appear.

The leaves of the plant are first seen as slight projections (*l*) on the surface of the growing-point ; the tissues taking part in their formation are the dermatogen and a portion of the periblem.

The branches which arise in the axils of the leaves are also developed from the dermatogen and periblem ; the plerome is not concerned in the production of either leaves or branches.

(ii) *Growing-point of the root.*—The apex of a root differs very considerably from that of a stem. The delicate meristem in the latter always exists within a bud and is protected from external injurious influences by the rudimentary leaves which curve round it.

Roots, however, produce no leaves, but the tender cells of the meristem at the apex of each are protected by a covering of cells termed the *root-cap*. Moreover, as fast as the exterior of

the root-cap dies off or is worn away by the soil in which the root is growing, additions are being made to the interior of the cap where it is in union with the meristem.

A common arrangement of the tissues at the end of a root is seen in Fig. 78.

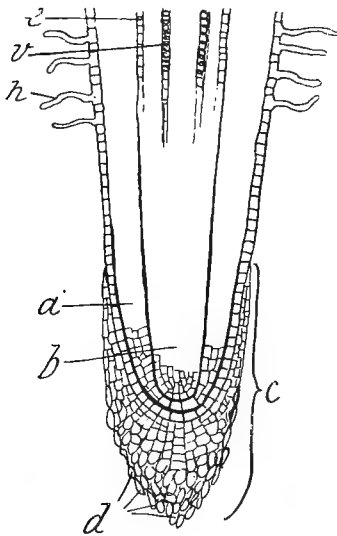

FIG. 78.—Longitudinal section through the apex of a root. *b* Pterome; *a* periblem; *c* root-cap; *d* external dead and dying cells of root-cap; *e* pericycle; *v* vessels of the protoxylem; *h* root-hair. (Enlarged about 60 diameters.)

becomes the piliferous layer: the rest of the cells which are continually cut off towards the outside form the root-cap proper.

The innermost part of the meristem which gives rise to the vascular cylinder is the pterome (*b*), while round it is the periblem (*a*), from which the primary cortex of the root is derived. In almost all respects these portions of the apical meristem are identical with those present in the apex of the stem. The outermost part of the meristem is termed the *calyptrogen* or cap-forming layer; instead of remaining a single layer as in the stem it divides by walls parallel to the surface as well as perpendicular to the latter, and thus a many-layered root-cap (*c*) is formed.

In many instances the innermost single layer of cells produced by the calyptrogen becomes the piliferous layer: the rest of the cells which are continually cut off towards the outside form the root-cap proper.

Ex. 76.—Soak some beans or peas, and allow them to germinate. As soon as the tip of the radicle is visible through the micropyle, strip off the coat of the seed and cut longitudinal sections of the young root. Place them or half an hour in Eau de Javelle (see Ex. 75), then wash in water and

mount in dilute glycerine. Examine first with low and then with a high power. Make a sketch showing the general arrangements of the parts seen, viz., root-cap, plerome and periblem.

Endeavour to prepare sections of the apex of the roots of maize, peas, and other large seeds.

Ex. 77.—Cut longitudinal sections through the apex of stems within the terminal buds of common trees. Treat and examine as indicated above. Observe and sketch the parts seen : note the first beginnings of leaves.

PART III.

PHYSIOLOGY OF PLANTS.

CHAPTER XI.

THE CHEMICAL COMPOSITION OF PLANTS.

I. AFTER becoming acquainted with the external and internal structure of plants, it is necessary to proceed to study the work which the various parts perform in the maintenance of the life of the plant : this branch of the science of Botany is termed *physiology*. Among the higher forms of plants various members and tissues are adapted to carry out certain *functions* or certain kinds of physiological work ; the individual members and tissues by which the functions are performed being termed *organs* of the plant.

It is at the outset important to emphasise the fact that all the various functions are dependent upon the living protoplasm, and that the activity and power of the latter to carry them on satisfactorily is bound up with certain external conditions, namely, a suitable temperature, adequate supply of food-materials, and in the case of green plants a certain intensity of light, and access to free oxygen of the atmosphere ; without the fulfilment of these conditions death takes place and the various vital phenomena cease.

The functions of plants may be divided into two groups :—

(i) The *nutritive functions* which are concerned with the absorption, elaboration, and appropriation of the food-supply and therefore specially adapted to the maintenance of the life of the individual,

and (ii) *the reproductive functions* concerned with the production of new individuals and the maintenance of the species.

2. Before examining the nutritive processes in detail, it is necessary to learn something about the substances entering into the composition of plants.

If a fresh plant is dug up from the ground and placed in an oven heated to a temperature a little above that of boiling water (105° - 110° C.) it soon loses weight, the loss being due to the escape of water from the tissues of the plant. By continuing the drying process for some hours, all the water from the cell-sap, protoplasm, and the cell-walls is expelled, and there remains only the solid matter of the plant.

This residue or *dry matter* consists of a great variety of chemical compounds, organic and inorganic; when ignited and burnt it always leaves a small amount of white or yellowish incombustible *ash*, composed of inorganic compounds, the chief constituents of which have been originally absorbed from the soil by the roots of the plant.

The following table shows the amounts of water, dry matter, and ash in 100 parts by weight of the seeds, fruits, leaves, and other portions of a few common plants:—

	Water.	Total dry matter.	Combustible portion.	Ash.
Wheat (grain), . . .	14·3	85·7	76·5	9·2
Barley „ . . .	14·3	85·7	72·7	13·0
Oat „ . . .	14·3	85·7	75·7	10·0
Beans, . . .	15·0	85·0	79·5	5·5
Turnip-seeds, . . .	11·8	88·2	84·3	3·9
Apples, . . .	84·8	15·2	14·8	0·4
Roots of Carrot, . . .	85·0	15·0	14·1	0·9
„ Swede, . . .	87·0	13·0	12·0	1·0
„ Mangold, . . .	88·0	12·0	11·2	0·8
Potato tubers, . . .	75·0	25·0	24·1	0·9
Good dry hay, . . .	14·3	85·7	79·5	6·2

	Water.	Total dry matter.	Combustible portion.	Ash,
Meadow grass (green),	80·0	20·0	18·0	2·0
Red Clover, . . .	80·4	19·6	18·3	1·3
Green potato haulm,	85·0	15·0	13·4	1·6
Swede leaves, . . .	88·4	11·6	9·3	2·3
Mangel leaves, . . .	90·5	9·5	7·7	1·8

The amount of water in ripe seeds is comparatively small, generally averaging from 10 to 15 per cent. In succulent fruits, fleshy roots, tubers, green leaves and fresh vegetative organs, it is rarely less than 75 per cent. and not unfrequently as high as 85 to 90 per cent. of their total weight.

The proportion of ash in the dry matter of seeds and succulent roots and tubers is generally very much smaller than in the leaves and bark of plants.

Ex. 78.—Weigh pieces of carrot, turnip, mangel, potato, apple and strawberry in separate porcelain dishes, then cut each piece into several small pieces and place the porcelain dishes and contents in a warm oven or ‘water-oven.’ Weigh at intervals of three hours and note the loss in weight.

Ex. 79.—Repeat the previous experiment with leaves of potato, turnip, ash and other trees, freshly-cut grass, and freshly-ground ‘whole-meal’ flour, oat-meal and bean-meal.

3. The dry matter of a plant consists of (1) a small amount of unutilised inorganic substances absorbed from the soil; and (2) a large amount of various organic compounds manufactured by the plant out of the food-materials which it has absorbed from the soil and air.

To merely give a list of the compounds met with in plants would fill a large volume: it is, however, not needful here to describe more than the chief organic substances of which the plant-body is composed: for present purposes they may be classified into two groups, namely:—(1) *non-nitrogenous* and (2) *nitrogenous* substances according as they are free from or contain nitrogen.

I. NON-NITROGENOUS ORGANIC SUBSTANCES.

The most important members of this group are the carbohydrates, fats, and acids enumerated below.

1. **Carbohydrates.**—These compounds form the largest part of the body of all plants and contain carbon, hydrogen and oxygen, the elements hydrogen and oxygen being present in the same proportion as they exist in water. The chief carbohydrates are the sugars, starch, inulin, celluloses and pentosans.

a. *Sugars.*—Almost all the sugars possess a more or less sweet taste, and are generally met with dissolved in the cell-sap. The commoner representatives are glucose, fructose, cane-sugar and maltose.

(i) *Glucose, dextrose or grape-sugar* ($C_6H_{12}O_6$), occurs in most fruits, and especially in grapes whose cell-sap may contain from 20 to 30 per cent. ; ripe apples contain on an average 7 to 10 per cent. ; cherries 9 to 10 per cent., and plums 3 to 5 per cent of this sugar.

(ii) *Fructose, fruit-sugar, or levulose* ($C_6H_{12}O_6$) is found also in ripe fruits associated with grape-sugar.

Both dextrose and levulose reduce Fehling's solution, and are directly fermentable by yeast.

Ex. 80.—Dissolve 35 grams of copper sulphate in 500 c.c. of water, label this solution A : then dissolve 160 grams of caustic potash and 173 grams of sodium potassium tartrate in 500 c.c. of water and label the solution B. By mixing equal quantities of A and B, Fehling's solution is produced. (The solution A and B should be kept separate and only mixed when needed as the mixture does not keep long.)

Squeeze a few drops of grape juice into a test tube containing 10 c.c. of the Fehling's solution : heat over a Bunsen flame and note the reddish precipitate of cuprous oxide (Cu_2O).

Test the juice of ripe plums and other fruits in the same way.

(iii) *Cane-sugar or saccharose* ($C_{12}H_{22}O_{11}$) occurs dissolved in the cell-sap of the stems and roots of many plants and especially in the sugar-cane, mangel and sugar-beet, from which it is extracted on a commercial scale.

Sugar-cane stems contain from 15 to 20 per cent., the sugar-beet from 12 to 16 per cent. of this carbohydrate.

It differs from the two previous sugars in that it does not reduce Fehling's solution and cannot be fermented directly by yeast. When boiled with dilute acids or acted upon by the enzyme invertase, which is present in yeast and in various tissues of plants, it decomposes into a mixture of dextrose and levulose which mixture is termed *invert-sugar*.

Ex. 81.—Boil some pieces of mangel or sugar-beet in water and

(i) Test some of the solution for a 'reducing' sugar as in Ex. 80.

(ii) Take 10 c.c. of the solution and add to it three or four drops of strong hydrochloric acid: boil for twenty minutes, and after neutralising the acid with a solution of sodium carbonate, boil and test again with Fehling's solutions.

(iv) *Maltose* ($C_{12}H_{22}O_{11}$) is a variety of sugar formed by the action of the enzyme diastase upon starch and is present in malted barley and other germinated grain. It is capable of direct fermentation by yeast, and reduces Fehling's solution but not to the same extent as grape-sugar.

b. *Starch* ($C_6H_{10}O_5$)_n.—This carbohydrate is found in the form of minute solid, organised grains, built up of several successive layers of the substance arranged round a more or less central nucleus or *hilum*; sometimes two or more nuclei are visible in the same grain in which case the latter is described as *compound*.

Starch-grains are usually manufactured by the plastids of the cells, and occur in greatest abundance in roots, tubers and seeds where they form a store of reserve-food: from 50 to 70 per cent. of the dry weight of cereal grains, and 10 to 30 per cent. of potatoes is starch.

The grains are variable in size and form even in the same plant: nevertheless, in many cases the starch-grains from certain plants are so characteristic in shape and dimensions that they may be readily identified under the microscope.

Those from potato tubers are flattened irregularly oval grains of comparatively large size, with an excentric nucleus (1, Fig. 79).

Large and small grains are present in the endosperm-cells of wheat, barley and rye; they are all flattened and lentil-shaped with a central nucleus (2, Fig. 79).

In the cotyledons of the seeds of pea, bean and other leguminous plants, the grains are oval and kidney-shaped as in 4, Fig. 79, with radiating cracks or fissures in the centre.

In oats the grains are oval and compound (3, Fig. 79), the component fragments (n) being small and angular.

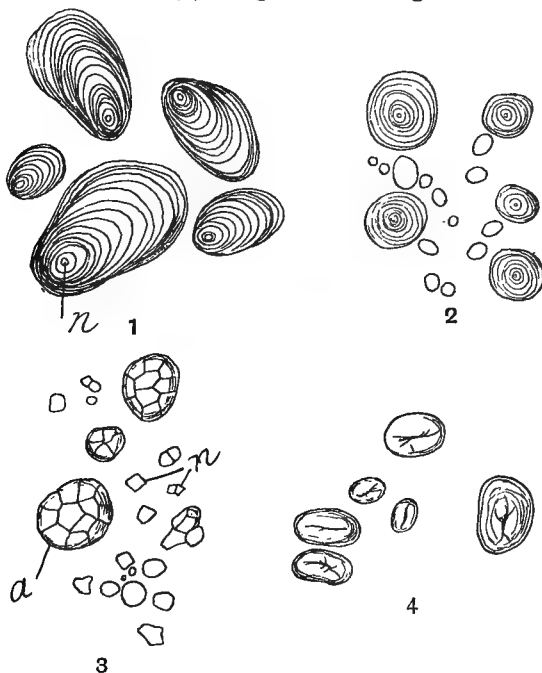

FIG. 79.—(1) Starch-grains of potato: n nucleus of a grain. (2) Starch-grains of wheat. (3) Starch-grains of oat; a a compound grain; n fragments of a compound grain. (4) Starch-grains of bean. (All enlarged 360 diameters.)

The substance forming the grain is termed *starch* or *amylose*, of which there appears to be two slightly different modifications. When treated with a solution of iodine it turns a characteristic deep violet-blue colour.

The enzyme diastase converts it into maltose and various soluble gum-like carbohydrates termed dextrins.

Formerly Nägeli and others considered that a starch-grain consisted of two substances, namely, *granulose*, and a substance *starch-cellulose* or *farinose* which remains as an insoluble residue when starch-grains are treated with saliva or weak acids: this residue, however, does not pre-exist in the starch-grains but is a product of the action of the solvents employed, and according to A. Meyer is amyloextrin.

On boiling with dilute acids starch is changed into glucose and dextrin.

Heated with water starch swells and forms an insoluble jelly-like paste: subjected to dry heat or roasted to a temperature of 150° to 200° C. it turns brown and becomes altered into a form of dextrin.

In certain cases starch-grains contain amylose with a larger or smaller proportion of amyloextrin: the latter is coloured wine-red by a solution of iodine.

Commercial starch is obtained chiefly by mechanical separation with water from crushed potato tubers, or from maize and wheat grains.

Ex. 82.—Divide a grain of wheat, barley, oat, rye, maize and rice transversely with a knife. Gently scrape off a very small portion of the endosperm and mount in water. Examine the starch-grains with a low and a high power, noting whether simple compound, their form and relative size, and also the shape and position of the hilum in each.

Ex. 83.—Cut through the cotyledons of a bean and pea seed and also through a potato tuber: gently scrape the cut surface with the point of a knife and transfer the starch-grains obtained to a drop of water on a slide. Examine and note the form, size and shape of the starch-grains.

Ex. 84.—Cut thin sections from a piece of potato tuber and from a wheat

grain : examine with a low power and make drawings of the starch-grains within the cells observed.

Ex. 85.—Make a strong solution of potassium iodide in water and add to it a few crystals of iodine. Allow the mixture to stand for twelve hours, and shake occasionally in order to facilitate the solution of the iodine. When the latter is all dissolved, add more water until the whole is the colour of dark sherry.

When examining the starch-grains in Exs. 82 to 84, place a drop of this solution near the edge of the cover-slip so that it may run under the latter and come in contact with the starch-grains. Note the change in colour of the starch-grains.

Ex. 86.—Make an extract of malt diastase as follows :—Shake up five grains of ground malt with 50 c.c. of cold water and after allowing it to stand for four hours, filter so as to get a clear solution.

Next grind some starch with water in a mortar and pour a little of the mixture into a 200 c.c. flask of boiling water. When cool pour about 20 c.c. of this thin starch paste into three test tubes : show the presence of starch by adding a few drops of the solution of iodine mentioned in Ex. 85 to one tube, and to the other two tubes add 3 or 4 c.c. of the diastase extract, and warm them to 60° C. Test for the presence of starch in one of these two tubes by taking out at intervals of five minutes a few drops with a pipette and adding them to weak solutions of iodine kept in a series of test tubes.

After a time the starch is changed into sugar and dextrin : When this has happened show the presence of the sugar by means of Fehling's solution.

See if Fehling's solution is acted upon by the thin starch-paste when no diastase is added.

c. *Celluloses.*—The solid fabric of a plant consists mainly of cell-walls which are produced by the protoplasm of the cells. At first the walls are thin, but in many cases thickening takes place by the deposition of layer after layer of substance on the inside of the walls where they are in contact with the cytoplasm. Where cells are in a state of division and new walls are being produced, the latter are first visible in the form of thin plates of cytoplasmic substance stretched across the dividing cells, and in the process of thickening the new layers appear to be produced by a conversion of the outermost layers of the cytoplasm, for where thickening of a cell-wall takes place there is always noticed a gradual diminution of the protoplasmic cell-contents until at last none remain within the cell-cavity.

It has been customary to term the material forming the cell-wall *cellulose*, as if it were a single chemical substance. A variety of celluloses are, however, now known and the cell-walls of plants invariably consist of mixtures or compounds of these with several other substances.

What may be named the typical cellulose can be readily obtained from cotton-wool and flax-fibre by treating the latter with various chemical reagents to eliminate the substances combined or mixed with it: it is a carbohydrate possessing the empirical composition represented by the formula $n(C_6H_{10}O_5)$. This typical cellulose is insoluble in dilute acids and alkalies, but is soluble in ammoniacal cupric oxide, hot concentrated solutions of zinc chloride and other solvents.

It stains blue when treated with sulphuric acid and iodine or with 'chlor-zinc-iodine,' and when acted upon with concentrated sulphuric acid yields dextrose sugar.

Another type of cellulose is present in the cell-walls of lignified tissues. When obtained free from the substances with which they are combined or mixed, these celluloses differ from the cellulose obtained from cotton fibre not so much in empirical composition as in chemical structure. They contain a slightly higher percentage of oxygen, are less resistant to hydrolysis, and yield only small quantities of dextrose and mannose sugars when treated with sulphuric acid; moreover the aldehyde *furfural* is produced when celluloses of this type are hydrolysed with dilute hydrochloric acid.

The cell-walls of the cells of the endosperm-tissue and cotyledons of seeds are formed of substances termed *hemicelluloses*, which are so different in chemical properties from the two types just mentioned that they have little right to be considered celluloses at all, except that they resemble the latter in appearance and are the materials of which certain cell-walls are composed. Hemicelluloses are very easily hydrolysed by dilute acids and alkalies into galactose, mannose and pentose sugars.

None of the above-mentioned celluloses are ever met with in a pure state in plants; they are always combined or mixed with other substances forming three main types of what may be termed compound celluloses as indicated below.

(i) *Pectocelluloses*.—These are compounds or intimate mixtures of typical celluloses with *pectose*; the latter when hydrolysed with dilute acids or alkalis yields *pectin*, a substance whose solutions gelatinise easily. The cell-walls of raw cotton, flax-fibres and other unligified fibres, as well as most parenchymatous tissues and especially those of fleshy roots and fruits, such as carrots, mangel, turnips, apples, pears and currants, consist chiefly of this form of compound cellulose.

Mangin asserts that the first walls produced during cell-division, consist mainly of pectose, the secondary thickening-layers of most unligified cell-walls being formed of cellulose and pectose combined.

Closely allied to pectocelluloses are the *mucocelluloses* composed of cellulose and substances which yield mucilaginous solutions with water: they are chiefly met with in certain seeds and fruits.

(ii) *Adipocelluloses*.—The cell-walls of cork-tissue appear to be composed chiefly of a fatty or waxy substance termed *suberin* combined with a very small amount of cellulose. Allied to these are the *cutocelluloses* forming the cell-walls of the epidermis of plants: the substance *cutin* closely resembles suberin in its composition and properties. Both suberised and cutinised cell-walls turn brownish-yellow when treated with 'chlor-zinc-iodine'; they are impermeable to water and successfully prevent the loss of water from tissues covered by them. Whether cutin and suberin are products of the direct conversion of cellulose is a question at present unsolved.

(iii) *Lignocelluloses*.—The cell-walls of the woody tissues of plants consist of *lignocelluloses* which are homogeneous compounds of (a) cellulose or oxycellulose,

(b) a pentosan known as wood-gum,

and (c) certain aromatic compounds not yet isolated in a pure state: the substances *b* and *c* are together generally spoken of as *lignin* or *lignone*. Lignocelluloses are primary constituents of plant tissues, and are not celluloses on which 'lignin' is encrusted or deposited as the result of secondary chemical changes.

Lignified walls become pink when treated with phloroglucin and hydrochloric acid, and stain a yellow colour in solutions of aniline chloride; with chlor-zinc-iodine the walls become yellow.

The cell-walls of lignified tissues in the heart-wood of trees, and other parts of plants, frequently become stained by tannin and various colouring matters.

Paper of all kinds consists chiefly of cellulose obtained from linen rags, cotton, wood and straw.

Ex. 87.—To prepare 'chlor-zinc-iodine,' dissolve 25 parts of zinc chloride and 8 parts of potassium iodide in $8\frac{1}{2}$ parts of water, and add as much iodine as will make the solution a dark sherry colour.

Cut sections of the stems and other parts of plants, and mount them in the solution; note the blue colour of the unlignified and uncuticularised walls. Notice the effect of the solution upon 'cotton-wool,' and upon sections of wood.

Ex. 88.—Cut sections of the seeds with a dry razor; mount and examine some of the sections in water, and some in pure glycerine. Soak some white mustard and flax-seeds (linseed) in water; note the slimy mucilaginous nature of the surface of the seeds when wetted.

Ex. 89.—Cut sections of the stems of various plants, and mount them in a saturated solution of aniline chloride, to which a few drops of hydrochloric acid have been added; the lignified walls stain a golden yellow colour.

d. Pentosans.—Associated with the cellulose of plant tissues are carbohydrates termed *pentosans* ($C_5H_8O_4$). When heated with dilute acids they are hydrolysed and converted into the pentose sugars ($C_5H_{10}O_5$) arabinose or xylose.

Pentosans are produced during the early stage of growth, and the amount generally increases with the age of the plant. These carbohydrates appear to be of little use in the nutritive processes of plants, but are partially digested and assimilated by herbivorous animals. They are common in all plant tissues and are especially abundant in grasses and cereal straw.

e. *Inulin* is a carbohydrate possessing the same percentage composition as starch; it is soluble in water, and is met with dissolved in the cell-sap of many plants belonging to the Compositæ, Campanulacæ and other orders. It is also found in the bulbs of many plants belonging to the Liliacæ and Amaryllidacæ, as well as in the leaves and other vegetative parts of these plants.

Inulin is especially abundant in dahlia and chicory roots, and in tubers of Jerusalem artichoke, where it takes the place of starch as a reserve-food. When portions of these roots and tubers are placed in dilute alcohol for several days, the inulin separates in the form of solid spherical masses of needle-like crystals, arranged in a characteristic radiated manner (sphærites).

Inulin does not reduce Fehling's solution, but when boiled for a long time with water, or for a short time with dilute acids, it is converted completely into levulose.

Ex. 90.—Soak a piece of a dahlia root in strong methylated spirit for several weeks: cut sections and mount in pure glycerine. Examine and draw the sphærocrystals of inulin.

2. **Fats and fixed oils.**—These substances, which are mixtures of different compounds of glycerine and fatty acids, contain the same three elements as the carbohydrates, but possess less oxygen proportionately to hydrogen than the latter substances. They are at first most frequently observed in the form of small round drops of irregular softish semi-solid particles within the cytoplasm of cells: afterwards the drops run together and are then excreted into the cell-sap where they accumulate.

Oils and fats are reserve plant-foods, and are consequently most abundant in the endosperm and cotyledons of seeds, and in certain fruits. The seeds of the rape plant contain on an average 42 per cent.; flax-seeds (linseed), 36 per cent., and cotton seeds, 25 per cent. of oil.

The various kinds of 'Oil-cakes' used for feeding cattle are formed from the residue of different seeds and fruits, the greater

portion of whose oil has been extracted from them by crushing and other means.

Ex. 91.—Cut thin sections of the seeds of the almond, rape, Brazil-nut and linseed. Mount in water and examine with a high power: note the round bright oil-drops in the cells, and in the water round the section.

3. Volatile or essential oils.—To these compounds are due the aroma or odour of various plants, such as roses, mint, hops, and lavender.

Many essential oils are composed of carbon and hydrogen only, while others contain oxygen in addition to these elements. They frequently occur in the form of drops in the cytoplasm of the cells, and are sometimes accumulated and deposited in special parts of glandular hairs and other receptacles.

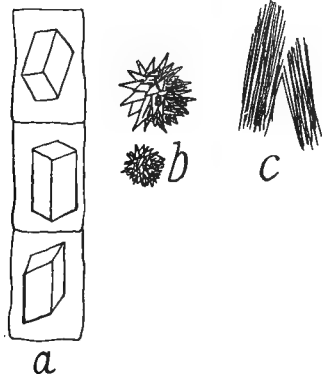

FIG. 80.—*a* Single large crystals of calcium oxalate in cells of the parenchyma of a red clover leaf; *b* crystal-aggregates from a rhubarb leaf; *c* raphides from a leaf of a fuchsia.

4. Organic acids.—The commonest examples of these compounds found in the cells of green plants are oxalic, malic, citric, and tartaric acids. They are met with either in the free state, or combined with various organic or mineral bases to

form acid and neutral salts.

The commonest acid in plants is oxalic acid, which occurs, free, or more commonly combined with calcium or potassium, in the parenchymatous tissue of leaves, stems and roots; to the acid potassium salt, is due the sour taste of the leaves of Sorrel (*Rumex acetosa*) and Wood-sorrel (*Oxalis acetosella*).

Crystals of calcium oxalate are very common in the tissues of a great variety of plants; they are formed in vacuoles within the cytoplasm, and occur in the form of (1) single crystals (*a*,

Fig. 80), (2) radiating crystal aggregates (*b*), or (3) bundles of needle-shaped crystals or *raphides* (*c*). The latter form is frequent in the cells of many monocotyledons.

Malic, citric and tartaric acids are also found free or combined with lime or potash, especially in unripe fruits of various kinds. A lemon contains from 5 to 7 per cent. of free citric acid.

Ex. 92.—Mount a very small portion of rhubarb jam in water, and look for crystal-aggregates of calcium oxalate resembling *b*, Fig. 80. Many will be observed within the thin parenchymatous cells present in the jam.

Ex. 93.—Treat some clover, vetch, fuchsia and other leaves with Eau de Javelle as in Ex 75, wash in water and mount a small piece in glycerine: note the form of the crystals of calcium oxalate, and their position in the leaves. In which special tissues of the leaves are they most abundant?

II. NITROGENOUS ORGANIC SUBSTANCES.

These compounds contain nitrogen and frequently other

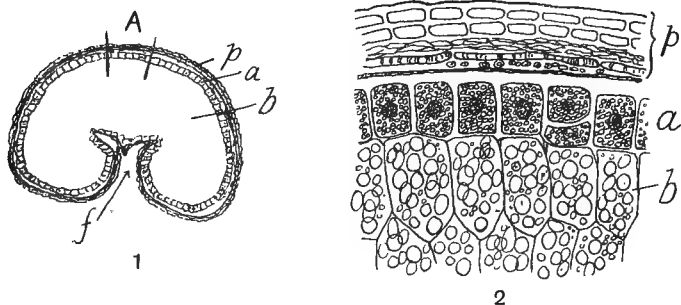

FIG. 81.—1. Transverse section of a wheat-grain. *p* Pericarp; *a* 'aleuron-layer'; *b* starchy part of the endosperm; *f* furrow at back of the grain.

2 Part *A* of 1 (enlarged 160 diameters). *p* Pericarp; *a* 'aleuron-layer' showing small aleuron-grains and a central nucleus within each cell; *b* cells of endosperm containing starch-grains.

elements such as sulphur and phosphorus, in addition to carbon, hydrogen and oxygen.

The most important examples are the proteins or albuminoids amides and alkaloids.

1. **Proteins or albuminoids.**—The proteins are exceedingly

complex compounds to which no chemical formula can yet be given. They are generally slimy like the white of an egg, and like the latter substance many of them coagulate on heating; some of them are soluble while others are insoluble in water. The simplest proteins are composed of carbon, hydrogen, oxygen, nitrogen and sulphur; they contain from 15 to 17 per cent. of nitrogen and from $\frac{1}{2}$ to 3 per cent. of sulphur.

As protoplasm consists largely of proteins, they are met with in all living parts of plants: moreover some of these compounds are found dissolved in the cell-sap.

Certain proteins are stored in the vacuoles and cell-sap of seeds and other resting-organs as nitrogenous reserve-food in the form of round or irregularly-shaped solid grains; such grains are termed *aleuron-* or *protein-grains*. In cereals the aleuron-grains are very small and round, and are chiefly stored in the outermost cell layers of the endosperm (Fig. 81). In other starchy seeds such as beans and peas they are small, but in many oily seeds such as those of the castor-oil plant and Brazil-nut, the aleuron-grains are large, and generally contain a small round particle or *globoid* of calcium and magnesium phosphates, together with a larger or smaller *protein-crystal* or *crystalloid*.

The seeds of the lupin contain on an average about 34 per cent., beans 24, wheat-grains 13, barley-grains 10, straw 3, potatoes 2, and turnips about 1 per cent. of proteins.

Solid proteins stain a yellow colour with iodine.

Ex. 94.—(a) Divide a wheat-grain in two transversely: then cut a thin section to include a small portion of the pericarp and aleuron-layer as in Fig. 81.

Mount in dilute glycerine and run a drop of iodine solution under the cover-slip: note the colour of the starch-grains and the aleuron-grains.

(b) Cut a similar section of a barley and an oat grain. Are the aleuron-layers in these grains the same as in wheat?

Ex. 95.—Cut sections of the cotyledons of beans and peas: mount and examine in dilute glycerine: note the small aleuron-grains in the cells along with large starch-grains: stain with iodine and re-examine.

2. **Amides.**—These are soluble crystalline nitrogenous com-

pounds found dissolved in the cell-sap. Most of them are amido-acids or simple derivatives of the latter. They are reserve-foods chiefly present in the rhizomes, bulbs, tubers and roots of plants and rarely in resting seeds.

The most widely distributed representative is *asparagine*, which is present in the parenchyma of almost all parts of plants: it is more particularly abundant in the young shoots of asparagus, sprouts and tubers of the potato and in seedlings of lupins, vetches and other leguminous plants grown in the dark.

Other common amido-acids are *glutamine*, *betaine*, *leucine*, and *tyrosine* met with in the mangold, sugar-beet, turnip and other roots.

3. **Alkaloids.**—The alkaloids are organic compounds of a basic nature; most of them are poisonous and form the active principle of many plants used as drugs. The most familiar examples are *morphine*, obtained from the opium poppy, *nicotine* from the tobacco plant, *conine* from hemlock, and *strychnine* from *Strychnos Nux vomica*.

CHAPTER XII.

THE COMPOSITION OF PLANTS—*(continued)*.

1. **The elementary constituents of plants.**—Chemical analysis has shown that the following elements are always present in the compounds which form the body of a healthy green plant, namely, carbon, hydrogen, oxygen, nitrogen, silicon, sulphur, phosphorus, chlorine, potassium, sodium, calcium, magnesium and iron.

In sea-weeds bromine and iodine are usually present, and many other elements, such as aluminium, zinc and copper, have been occasionally discovered in small quantities in certain species of plants.

On burning the dry matter of a plant, the carbon, hydrogen, oxygen and nitrogen within it escapes into the air in the form of water, carbon dioxide, free nitrogen and other volatile compounds: the other elements are left in the ash.

While chemical analysis enables us to determine the particular elements of which the body of a plant is composed, it does not furnish a means of deciding which and how many of these elements are necessary for the plant's existence.

Since the majority of plants contain no zinc, tin or lead, it is clear that these elements and others which are only occasionally present are not necessary for plant-growth. On the other hand, that carbon, hydrogen, oxygen and nitrogen are absolutely essential may be inferred from the fact that these elements are essential components of the organic compounds of which the cell-walls and protoplasm are constructed. It does not, however,

follow that elements which are invariably present are therefore absolutely necessary for the life of a plant.

To determine with certainty which elements are indispensable for proper nutrition and growth, cultivation experiments must be carried out in soil or other media, the composition of which is accurately known, and which can be regulated and kept under control. This is best achieved by the methods of *water-culture* and *sand-culture*, which consist in growing the plants in pure water or in pure sand, to which are added compounds of the various elements whose influence is to be studied. By means of such experiments it has been proved that only ten elements are really essential for the growth of green plants, namely, carbon, hydrogen, oxygen, nitrogen, sulphur, phosphorus, potassium, magnesium, calcium and iron: possibly to this list chlorine should be added.

All attempts to grow plants in soil, water or air from which any one or more of these elements are excluded end in failure. The other elements sometimes found in plant ash are superfluous; even sodium and silicon, which are present in all plants growing in ordinary soils, are not indispensable, for healthy specimens capable of producing seed can be reared without them.

Ex. 96.—Water-culture.—For the growth of plants in nutrient solutions glass cylinders or wide-necked bottles holding about 600 or 700 c.c. of water should be used.

Before use the cylinder must be rinsed out first with nitric acid and then thoroughly washed with distilled water. It should be fitted with a cork bung through which two holes should be bored, one for the exit of the stem of the plant to be grown, the other into which a short glass tube is fitted being convenient for adding water to replace that which is lost by transpiration.

The solutions to be used must not contain more than from 2 to 5 grams of dissolved salts in 1000 grams of water: a higher concentration is detrimental to growth.

Moreover a slightly acid reaction should be maintained, alkaline solutions being injurious.

For complete nutrition the composition of the solution may vary considerably so long as the essential elements are present in a suitable state for absorption by the roots of the plants. The following solution contains all

that is needed by green plants, the necessary carbon being obtained from the carbon dioxide of the air :—

	Grams.		Grams.
Water,	1500	Acid potassium phosphate	
Calcium nitrate,	2	(KH_2PO_4),	$\frac{1}{2}$
Potassium chloride,	$\frac{1}{2}$	A few drops of ferric chloride	
Magnesium sulphate,	$\frac{1}{2}$	solution.	

For demonstration purposes buckwheat, barley, maize, small dwarf-beans, and wallflowers are easily grown. Seeds should be germinated in damp sawdust or on damp blotting-paper, and when the seedlings are large enough to handle they should be arranged as in Fig. 82, so that their roots dip into the culture solution, their stems being allowed to develop through the hole in the cork (*c*). Seedlings of maize, barley and beans may be fastened in position by means of a pin pushed through the side of the pericarp or the seed-coat into the lower side of the cork ; or they may be supported by inserting cotton wool in the hole through which the stem emerges.

It is important to see that only the roots dip into the solution : wetting the endosperm, cotyledons, or hypocotyl frequently leads to ill-health and death of the plant.

The sides of the glass cylinder should be covered with cardboard or several thicknesses of paper to prevent access of light and heat to the solution : or the cylinder may be sunk in a box containing cocoa-nut fibre.

Avoid placing the culture in the direct sunlight so that the solution in which the roots are immersed may remain cool.

In experiments extending over a period of several weeks the culture solution should be changed every week, and the plant should be placed occasionally for a day or two with its roots in distilled water, or water containing a small amount of calcium sulphate.

Ex. 97.—Fit up a water-culture as above but do not add ferric chloride or any other compound of iron to the solution : compare the growth of the plant with one growing in a complete solution.

Ex. 98.—Note the differences between plants growing in a complete solution as above and some growing in the following solutions in which nitrogen and potassium are respectively missing.

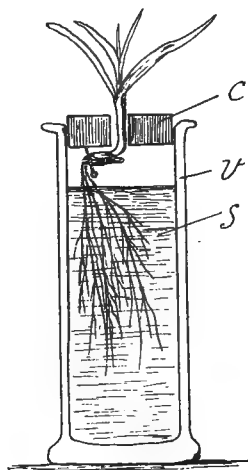

FIG. 82.—Water-culture of barley plant. *v* Cylindrical glass vessel ; *s* culture solution ; *c* perforated cork bung.

SOLUTION WITHOUT NITROGEN.		SOLUTION WITHOUT POTASSIUM.	
	Grams.		Grams.
Water,	1000	Water,	1000
Calcium sulphate,	1	Calcium nitrate,	1
Acid potassium phosphate,	$\frac{1}{2}$	Magnesium sulphate,	$\frac{1}{2}$
Magnesium sulphate,	$\frac{1}{2}$	Acid sodium phosphate,	$\frac{1}{2}$
Potassium chloride.	$\frac{1}{2}$	Sodium chloride,	$\frac{1}{2}$

To both the solutions add a few drops of ferric chloride solution.

2. **Essential elementary constituents of plants.**—The following is a brief account of the elements which are absolutely necessary for the nutrition of plants.

(i) **Carbon.**—Carbon is one of the essential constituents of protoplasm, and enters very largely into the composition of the cell-wall, and many reserve foods of plants. The amount present in plants usually amounts to between 40 and 50 per cent. of the dry matter within them. The greater portion of it is derived from the carbon dioxide of the atmosphere, but in some cases, and perhaps in all, a certain amount of carbon is taken from the soil in the form of organic compounds.

Fungi among the lower, and Dodder (*Cuscuta*), (p. 573), Broom-rape (*Orobanche*), (p. 574), and Bird's-nest orchis (*Neottia*) among the higher plants, obtain their carbon in the form of organic carbon compounds from living animals and plants, or from the decaying remains of these organisms.

(ii) **Hydrogen and oxygen** are found combined with carbon and other elements in the protoplasm, cell-wall, sugars, fats, and other compounds present within the plant.

Hydrogen is a constituent of water, and in this form is chiefly absorbed from the soil. Between 5 and 6 per cent. of the dry matter of a plant is hydrogen.

The amount of oxygen present in the dry matter of plants averages between 35 and 45 per cent. It is absorbed in a free state from the air in the respiration-process, and is also taken up from the soil in nitrates, sulphates, carbonates and phosphates.

(iii) **Nitrogen.**—This element enters into the composition of

protein or albuminoid substances, amides and a few other less important organic substances; it is also found in the inorganic nitrates which are frequently present in small quantity in the cell-sap of plants.

The amount of nitrogen present is especially high in the seeds of leguminous plants, being in peas 4·8 per cent., in beans 5 per cent., and in yellow lupins as much as 7 per cent. of the dry matter: in starchy cereal grains such as wheat, barley, and maize the amount is usually less than 2 per cent.

The vegetative parts of leguminous plants are generally richer in nitrogen than those of most other plants: for example, in red clover and lucerne cut in bloom the amount present is from 2 to 2½ per cent., while in grasses the average amount is about 1¾ per cent. of the dry matter.

With the exception of leguminous plants which derive most of their nitrogen from the free nitrogen of the atmosphere (see p. 792), green plants take up this element from the soil chiefly in the form of nitrates. It has been proved by means of water cultures that they are also able to absorb and utilise the nitrogen of ammonium compounds, but as the latter when applied to the soil become changed into nitrates in the process of nitrification (see p. 785) it may be said that nitrates are the chief natural source of nitrogen for green plants.

Although it has been shown that most plants can grow equally well with nitrogen in the form of ammonium salts as with nitrates, Mazé found that solutions of the former when more concentrated than about ·5 gram in 1000 damage the plants, whereas bad effects are not visible with nitrates until the solution applied to the roots contained 2 parts in 1000 of water.

Nitrogen when supplied to plants in considerable quantity specially increases the luxuriance of their leaves, stems and vegetative organs; such plants are dark green in colour, and show little tendency to produce reproductive organs and seeds.

(iv) **Phosphorus**.—Phosphorus is a constituent of several kinds

of protein compounds, and is more especially abundant in the protein of the nucleus of plant-cells.

Besides being met with as a constituent element of organic compounds, it is often present in the form of inorganic phosphates.

Phosphorus constitutes a large proportion of the ash of seeds, and without an adequate supply of this element, the formation and development of seeds do not take place satisfactorily. The amount of phosphorus calculated as phosphoric acid in the ash of wheat-grains averages from 45 to 50 per cent., and in beans about 40 per cent. : in the ash of the vegetative parts the amount is considerably smaller, *e.g.*, in wheat-straw about 5, in turnips 7, in hay 6, and in potato tubers about 17 per cent.

Phosphorus is absorbed by plants from the soil in the form of phosphates of potassium and calcium.

(v) **Sulphur** enters into the composition of proteins, although the amount is small, rarely exceeding 2 per cent. It is also a constituent of 'mustard-oil' obtained from many cruciferous plants, and is found in the form of inorganic sulphates in which condition it is absorbed from the soil.

(vi) **Potassium**.—This element is specially abundant in the ash of the young actively-growing part of plants where cell-division is going on, and probably is an essential constituent of the protoplasm of all cells. It also exists combined with tartaric, oxalic, malic, and other organic and inorganic acids in the cell-sap.

Tissues containing large reserves of carbohydrates are frequently rich in this element ; for example, in potato tubers 2·3 per cent., in grapes about 3 per cent., and in mangels 4 per cent. of the dry matter is potash (K_2O).

It is taken up from the soil chiefly as nitrate, chloride, carbonate, sulphate and phosphate.

The part which potassium plays in the economy of the plant is not known with certainty. According to De Vries its salts are especially concerned with the maintenance of the turgidity of the cells, and as the latter condition is essential for growth

the particular abundance of the element in growing tissues is thus partially explained.

It has been observed that the 'fixation of carbon' in green tissues ceases when potassium is absent, and cereals and peas grown with an insufficient supply produce small thin grains and seeds.

The place of potassium in the economy of the plant cannot be taken by any of the other nearly allied elements such as sodium and lithium.

(vii) **Calcium**.—Fungi appear to be able to dispense with calcium, but for green plants it is an essential element. It is absorbed from the soil in the form of a nitrate, phosphate or sulphate.

In the young parts of plants calcium is generally present in small quantity only and in some instances it may be missing altogether from such parts for a time, its absence leading to no apparent injurious effect. It is most abundant in the older parts of plants, such as fully-developed and dying leaves, bark and pith, and occurs in the form of salts of organic and inorganic acids more especially as oxalate and carbonate. The amount of lime (CaO) in the ash of barley, oat, and wheat straw is generally about 7 per cent.

Although seedling plants may continue to grow for one or two months without calcium, they always appear stunted under such conditions and present other features of ill-health ; if calcium compounds are still withheld death takes place.

Like some other essential elements calcium plays a many-sided rôle in plant-nutrition.

Oxalic acid and soluble oxalates are formed in certain plants and when present in very slight excess act injuriously upon the nucleus and other cell-constituents ; in the presence of calcium salts their accumulation and poisonous action is prevented by the formation of insoluble calcium oxalate.

Calcium is, however, not exclusively utilised for the neutralisation of oxalic acid, for there are many plants which never contain oxalic acid, and yet it is found that such plants still require this element for perfect growth. The assumption that calcium oxalate

is a waste product is not apparently true in every instance, for there is evidence to believe that it is dissolved again sometimes and utilised as a reserve of calcium.

(viii) **Magnesium** is found in the ash of all parts of the plant, but more especially in that of seeds. About 12 per cent. of the ash of wheat grains consists of magnesia (MgO), while the ash of the straw and vegetative parts contains less than 2 per cent. Magnesium is taken from the soil, chiefly as carbonate and sulphate, but its use to the plant is still very obscure.

(ix) **Iron**.—The amount of iron in green plants is generally very small, rarely exceeding 0·2 per cent. of the ash. It is, nevertheless, absolutely necessary for their nutrition since without it no chlorophyll is formed. Sufficient iron is present in seeds for the production of a certain amount of chlorophyll, and the first few leaves of seedlings grown in culture solutions free from iron are green; the subsequent ones are, however, pale and incapable of utilising the carbon.

3. **Non-essential elementary constituents of plants**.—Some of the elements are of such rare and abnormal occurrence in plants that they need not be mentioned. Others, such as silicon, sodium and chlorine, although found to be non essential to the growth of green plants, are universally met with in the ash and demand brief notice.

Although healthy plants can be grown in the absence of several elements, which are commonly met with in ordinary plant ash, these so-called non-essential constituents may be, and probably are, of use in stimulating or depressing the activity of various functions carried on by plants.

Silicon is specially abundant in the cell-walls of the external portions of the stems and leaves of barley, wheat, oats and grasses generally: more than one-half of the total ash of the cereals consists of silica (SiO_2).

The accumulation of silicon in the cell-walls was formerly supposed to be the cause of the rigidity and firmness of well-grown straw and the 'lodging' of cereal crops was attributed to a

lack of this compound. 'Lodging' is, however, due to a weakness caused chiefly by want of proper amount of light for normal growth, and firm-strawed, well-developed plants of maize, oats, and other cereals have been grown in water-cultures without silicon. Moreover, analysis has shown that the straw of 'lodged' crops generally contains more silicon and is much more brittle than straws of crops which have stood upright.

Jodin grew four generations of maize plants without any silicon.

Cultures of oats from which this element is missing do not yield so much grain as those to which it is applied.

Silicon is absorbed from the soil in the form of soluble silicates, the bases with which the latter are associated being apparently utilised in the nutritive processes.

Sodium in the form of sodium chloride is common in all plants, but is absorbed in greatest amount by *halophytic* plants which flourish on salt-marshes near the seashore, or inland near salt-mines and salt-lakes, where the amount of salt present in the soil is more than can be tolerated by ordinary inland plants.

Many halophytes, such as Glasswort (*Salicornia herbacea* L.), Saltwort (*Salsola Kali* L.), beet and mangel, and species of *Atriplex*, belong to the Chenopodiaceæ (p. 349.) Several cultivated cruciferous plants, such as the cabbages and seakale, are descendants of halophyte; asparagus is another example of the same class.

Culture experiments have shown that even the most typical of these halophytes can be grown without salt; nevertheless when supplied with it, they present a different appearance and have different physiological characters from plants deprived of the compound.

Under the influence of an abundance of salt the vegetative organs become plumper, more fleshy and succulent and transpire less than they do when grown without much salt.

Plants, such as the cereals and others not habitually growing near the sea, are killed by solutions containing more than 1 or 1½ per cent., whereas sea-beet and certain species of *Atriplex* are not destroyed by solutions containing 3 or 4 per cent. of salt.

CHAPTER XIII.

OSMOSIS : ABSORPTION OF WATER.

1. **Osmosis.**—When a bladder filled with a solution of sugar has the opening into it tightly tied with string and then placed in a vessel full of pure water it is found that a considerable amount of the latter soon passes through the walls of the bladder into the interior and mixes with the sugar-solution, in spite of the fact that no visible openings are present through which the water travels.

The result of this inward transference of water is that an outward pressure is set up within the bladder and it becomes more and more distended, just as it would be if water or air were forced into it mechanically. The amount of internal pressure set up under these circumstances depends upon the amount of sugar dissolved in the sugar-solution and also upon the temperature at which the experiment is made: with a concentrated solution a greater pressure is produced than when a weak solution is used, and at a high temperature the pressure is greater than at a lower one.

Similar internal pressure tending to expand the bladder is observable when solutions of potassium nitrate, copper sulphate, and many other substances are used instead of sugar solution. Each of these soluble compounds possesses a different power of attracting water through the walls of the bladder; the pressure set up by a solution of say one per cent. of sugar is not the same as that induced by a solution of one per cent. of potassium nitrate.

In these experiments it will be found that while pure water

passes inwards through the walls of the bladder a certain amount of the sugar or the other soluble compounds employed passes outwards into the pure water within the vessel : and it is noticed that the process of diffusion or passage of the dissolved substances goes on through the membrane until the percentage, composition, or strength of the solution is the same inside and out.

Certain membranes are, however, known which allow water to pass through them but which are not permeable to sugar and other dissolved compounds.

The diffusion or passage of liquids and solutions of substances through membranes in which no visible openings are present is termed *osmosis* : the pressure set up in the interior of closed permeable membranes is spoken of as *osmotic pressure*, and the dissolved substances upon which the pressure is primarily dependent may be designated *osmotic substances*.

A bladder or other structure distended by osmotic pressure becomes firm or rigid instead of limp and flabby and in this condition is spoken of as *turgid*.

Dissolved in the cell-sap of all living plant cells are osmotic substances, such as sugars and salts of various kinds, which have the power of attracting water into the interior, and when plant cells are immersed in pure water they become turgid.

In all living parts of plants which are adequately supplied with water, and especially in those regions in which active growth is going on, the cells are distended by osmotic pressure, and this state of turgidity is the cause of the elasticity and firmness exhibited by the thin-walled living parenchymatous tissues of leaves, growing-points, and other delicately-constructed portions of plants.

The pressure within young turgid cells usually amounts to five or ten atmospheres and under its influence the cytoplasm is forced outwards into close contact with the cell-wall at all points ; the cell-wall becomes stretched until its elastic recoil equals that of the outward pressure. In the cells of fruits containing considerable amounts of osmotic substances in the cell-sap the pressure set

up in wet weather when abundance of water is conducted to them is sometimes sufficient to burst the cell-walls and the fruits split.

The osmotic properties of a plant cell are, however, not the same as those of a bladder filled with sugar-solution, for in many instances cells containing sugar or other substances do not allow these to pass out into water in which the cells may be immersed.

It is obvious that even a very slight permeability of the substances to which turgidity is due would make it practically impossible for any submerged water-plant to remain turgid, and the accumulation and retention of sugars and other soluble substances in the roots of beet and similar plants growing in damp soil would be equally difficult if the protoplasm and walls of the external cells were permeable to such compounds.

Whatever substances pass into or out of a living plant cell must permeate both the cell-wall and the thin lining of cytoplasm. While pure water finds a ready passage through both membranes the cytoplasm is very frequently either quite impermeable or permeable in a very different degree to many substances which easily travel through the cell-wall. Moreover, the permeability of the cytoplasm to any particular substance is not the same at all times.

When a turgid cell is immersed in a solution of a substance whose attraction for water is greater than that possessed by the substances dissolved in the cell-sap, a larger or smaller amount of water is abstracted from the cell and the osmotic pressure is reduced, the cell becoming smaller and more or less limp. If the vitality of the cytoplasm is not destroyed and the osmotic action of the solution continues, more water is abstracted from the vacuole, but the cytoplasm instead of remaining in contact with the cell-wall and allowing the solution to penetrate into the vacuole, shrinks away from the cell-wall and takes the form of a nearly spherical hollow ball in the centre of the cell-cavity: a living cell in this condition is said to be *plasmolysed*. The space between the cell-wall and the shrunken cytoplasm becomes occupied by the solution which has penetrated inwards through the

cell-wall, but none is allowed to pass through the living cytoplasm. Moreover, the osmotic substances dissolved in the cell-sap do not travel outwards through the cytoplasm. Cells plasmolysed in this manner regain their turgid condition when placed in pure water ; the plasmolysing substance which has passed through the cell-wall diffuses out and water again enters the vacuole so that the cytoplasm becomes forced into contact with the cell-wall.

When a leaf or a branch with leaves upon it is cut from a plant and left exposed to the air, water soon escapes from the cells in the form of vapour ; the turgidity of the cells is rapidly reduced and, in consequence, the leaves instead of maintaining their elasticity and firmness, become limp and unable to support themselves in a normal position.

This flaccid state of 'wilted' or 'faded' parts of plants is always brought about by the loss of water from the cells whereby their turgid stretched condition is reduced, although the conditions which lead to the loss of water is not the same in all cases.

If the loss of water from a cut shoot has not gone too far, and the cytoplasm is still living, it is generally possible to renew the former turgid state of its cells by placing the end of the stem in water, or by forcing water into the 'wilted' shoot as in Ex. 105.

From various extensive observations and experiments it is evident that the passage of substances in solution into or out of a cell, is under the control of the living cytoplasm ; the phenomena of turgidity and other osmotic properties are destroyed when death of the cytoplasm takes place.

Ex. 99.—Stretch a piece of wetted bladder across one end of a glass lamp-chimney and firmly tie it with string ; then fill about $\frac{1}{3}$ of the chimney with a saturated solution of sugar, and suspend it in a vessel of water, so that the sugar-solution inside the glass chimney is level with the surface of the water outside. Allow it to remain for a few hours ; note that the water passes inwards through the bladder into the sugar solution and causes the level of the latter to rise.

Ex. 100.—Repeat the preceding experiment, using a strong solution of copper sulphate or potassium bichromate. Observe if the copper sulphate or potassium bichromate passes outwards and colours the clear water.

Ex. 101. Cut a few slices, about $\frac{1}{4}$ of an inch thick, through a beetroot or sugar beet; wash them in distilled water and place—

(1) Some in a vessel in distilled water.

(2) Others first in boiling water for a minute or two to kill the cytoplasm of the cells, and then into a vessel containing distilled water. Allow them to remain for four hours; afterwards take out a small quantity of water from each vessel and test for sugar by boiling with a drop or two of hydrochloric acid and subsequently adding Fehling's solution (see Ex. 80).

Ex. 102.—Cut a transverse section through a portion of a garden beetroot. First wash it in water in a watch-glass, and then mount in water and examine with a low power of the microscope.

(i) Observe the presence of pink cell-sap in the uninjured cells; note that it does not escape into the surrounding water.

(ii) Run under the cover-glass a few drops of a 4 per cent. solution of common salt, and observe that as the colourless solution of salt penetrates into the cell plasmolysis begins and the cytoplasm recedes from the cell-wall. Notice that although water is withdrawn through the cytoplasm, the latter does not allow the colouring matter of the cell-sap to diffuse outwards, for the salt-solution which passes inwards through the cell-wall remains uncoloured.

(iii) Remove the cover-glass when the cells have become plasmolysed, wash away the salt-solution by soaking the section for a second or two in pure water, and then re-mount in water.

Examine with microscope and note that the cytoplasm gradually recovers its original position close to the cell-wall.

Ex. 103.—Cut a similar section of a piece of beetroot, and dip it for a moment into methylated spirit to kill the cytoplasm of the cells; wash quickly and then mount in water; note that the pink cell-sap now diffuses out into the surrounding water.

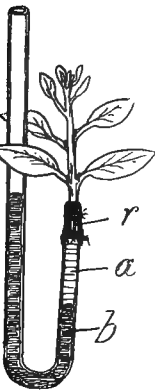

FIG. 83

Ex. 104.—Make careful measurements of portions 2 or 3 inches long of the young primary roots of beans and peas, young hop shoots, young flower-stalks of a dandelion, and other turgid portions of plants. Place them in a 10 per cent. solution of salt for six or seven hours and measure again; note the shrinkage and flabbiness of the parts due to loss of turgidity of the cells.

Ex. 105.—Cut off a shoot of a Jerusalem artichoke and leave it to wither in an ordinary room for about an hour; note the limp state of its leaves after that time. After cutting off half an inch of the stem fasten it to a bent glass tube by means of a short piece of rubber tube (*r*) as in Fig. 83.

Firmly tie the rubber tube to the glass tube and to the stem of the plant, and then partially fill the glass tube with water taking care that no air is left between the end of the stem and the water. Pour in mercury until the level in the free limb of the tube is considerably higher than in the other (*b*); the pressure of the mercury will force the water (*a*) into the shoot and the leaves will soon begin to assume their natural position and firmness.

2. **Absorption of water.**—In all actively-growing plants water forms considerably more than half their total weight; it saturates the living protoplasm and the cell-walls, and is the chief component of the cell-sap.

Water is utilised by plants for maintaining the turgidity of their cells, and a small amount is employed as a food-material. It is also of the greatest importance for the purpose of dissolving the various foods present in the plant and conveying them to the different organs requiring nourishment. Moreover, the absorption of water is the only means which a plant possesses of obtaining the various essential food-materials which are derived from the soil, for it is only when these necessary constituents are dissolved that they can find an entrance into plants: no solid particles of manures or other components of the soil, however small, are taken up by them.

Water and the dissolved compounds which plants absorb pass into them by osmosis and therefore only gain an entrance through organs whose external cell-walls are uncutinized or unsubsized. During the life of an ordinary farm or garden plant, the absorption of water and the absorption of dissolved food-materials are necessarily carried on at the same time: they may, however, be treated as separate phenomena.

The nature of the dissolved substances which are absorbed by plants, and the conditions which govern their absorption, are dealt with in chapters xii. and xv.; at present it is advisable to consider the absorption of water alone.

Plants which live completely immersed in the sea and in ponds and rivers rarely have a well-developed cuticle and take

in water through the surfaces of their stems and leaves as well as through their roots, but the crops of the farm and garden and all ordinary land-plants absorb all the water which they require from the soil by means of their roots only.

When the soil in a pot in which a plant is growing is allowed to become dry the plant begins to droop and wilt, and no amount of syringing or even immersion of the leaves and stems in water will completely revive and sustain the life of the plant so long as the soil is kept dry.

In good well-drained soil, the chief amount of rain which falls upon it sinks through into the subsoil, but a certain amount remains behind in the form of more or less thin films of water surrounding each solid particle of which the soil is composed.

In such soil some water is retained in the minute spaces present in it, and a certain amount of water travels upward from the subsoil by capillarity into these spaces in the upper layers of the soil. Good well-drained soils, while thus retaining an adequate supply of water, allow a free penetration and circulation of air within them. Only in water-logged soils totally unsuited to the growth of ordinary farm and garden crops are all the spaces between the component particles of the soil completely filled with water, and air excluded.

Soon after the appearance of the primary root from a seed secondary roots spring from it, and from these new roots arise, so that the soil becomes penetrated in all directions by fine rootlets, near the ends of which numbers of root-hairs are developed. The growing rootlets push their way through the small crevices in the soil and the root-hairs are brought into close contact with the small particles of soil and with the films of water surrounding the latter.

Formerly the absorption of water was supposed to take place through the root-caps which were termed 'spongioles'; experiments, however, have shown that plants are able to absorb all the water they need when the root-caps are exposed to the air

or destroyed, so long as the other young parts of the roots are kept in contact with water.

It has been experimentally proved that it is only through the root-hairs and the youngest parts in the immediate neighbourhood of the root-hairs that the absorption of water occurs: through the older parts on which the root-hairs have shrivelled and which have become covered with a tissue of cork-cells water is unable to penetrate.

The walls of the root-hairs consist of ordinary uncutinized cellulose through which water readily passes, and it is on account of the existence of osmotic substances in the cell-sap within the hairs that water with which they come in contact is attracted into them.

After carrying on their work for a short time they wither and die, but before this occurs a new set of hairs arises on the extending rootlet.

The greatest development of root-hairs occurs upon roots which are allowed to grow in damp air or in a moderately dry soil. When roots are immersed altogether in water, root-hairs are generally absent; the necessary absorption in such roots is carried on by the unextended superficial cells of the piliferous layer, there being no need for the extension of these cells into long hairs.

In very dry soils the development of root-hairs is feeble or entirely checked.

On account of the delicate nature of the root-hairs it is not possible to remove a plant from the soil without breaking the connection of the hairs with the fine particles of earth and permanently destroying many of them; transplanted plants, therefore, always suffer for want of water until new hairs are formed on the rootlets. Among certain plants new roots and root-hairs do not form readily and such plants cannot be transplanted. When trees or other plants are removed, it is advisable to specially preserve the youngest rootlets from which fresh

growths are most easily produced, and after re-planting her-
baceous plants exposure to a dry atmosphere, or to strong light
and other influences which promote loss of water from the leaves
by transpiration (see chap. xiv.), should be avoided for a time
wherever possible.

The osmotic absorption of water by the root-hairs of plants only
goes on when the following conditions are fulfilled, namely:—

- (i) A certain degree of warmth of the surrounding soil;
- (ii) Access to fresh air; and (iii) A suitable supply of water.

Cabbages and many other plants are able to absorb consider-
able amounts of water at freezing-point, but at the low tempera-
tures of winter absorption generally ceases or is vastly decreased
and it is not until the return of warm days in spring that the
activity of the roots is manifest.

The application of water from wells to the roots of tropical
and sub-tropical plants growing in pots in warm houses frequently
checks their absorptive power by lowering their temperature
considerably.

Sachs showed that the absorption by a tobacco plant at a
temperature of 4° or 5° C. was so small that withering com-
menced in spite of the fact that the roots of the plant had
access to an abundance of water.

In consequence of the presence of a considerable amount of
water which requires much heat to warm it, the temperature of
imperfectly-drained soils is usually lower than that at which the
roots of ordinary farm and garden plants do their work best.
Moreover, such soils do not allow of the free circulation of fresh
air within them, and the respiration process carried on by the
living protoplasm of the root-hairs is interfered with.

Without the access of an adequate supply of oxygen, or where
there is much carbon dioxide in the soil, poisonous compounds
are formed within the roots as the result of imperfect respiration
and the plants become unhealthy. Over-watered plants growing
in pots commonly exhibit injuries of this character.

Roots die or develop badly when plants are transplanted and put into the soil too deeply. Although the root-hairs come into very intimate contact with the small particles of earth, and are specially adapted to use the thin films of water surrounding the latter, they are not able to withdraw the whole of the water which a soil is capable of holding. When soils are allowed to dry, plants growing in them begin to wither as soon as the water present sinks below a certain amount, which varies with the composition of the soil in question. Beans, tobacco and cucumber plants have been found to wither and die in good garden soils containing 12 to 15 per cent. of water and in loams containing 8 per cent.

Ex. 106.—Grow a dwarf-bean in a pot of sandy soil and one in a pot of good garden soil. When the plants have three or four well-developed leaves allow the soil to become dry and when the plants are dead shake out the soil from each pot and determine what percentage of water remains in it. To do this, weigh a porcelain dish; then place a small amount of the soil in the dish and weigh again; the difference gives the weight of the soil taken. Place the dish with the soil in a 'water-oven' to drive off all the water; leave for five or six hours and when cool weigh again; the loss gives the amount of water which has evaporated from the amount of the soil taken; from these weights calculate the percentage loss of water.

Ex. 107.—Select three seedling cabbages as near the same size as possible; take one of them up carefully with a small amount of earth with it so as to damage the roots as little as possible; the second take up and shake off all the soil; take up the third and after shaking off all the earth from its roots pull off all the finest rootlets. Then transplant all three and notice the further growth of the three plants for ten days.

3. Exudation-pressure. Root-pressure: 'bleeding' of plants.—After water has been absorbed from the soil by the root-hairs, it passes by osmosis from the latter into the adjoining parenchymatous cells of the cortex (c, 2, Fig. 72). The cortical cells then absorb from each other until they all become highly turgid, and the same turgid condition is soon reached by the parenchymatous cells within the vascular cylinder of the root. When a certain degree of pressure is attained within the innermost parenchymatous cells

bordering on the wood-strands (*w*, 2, Fig. -72), the protoplasm of the former becomes permeable, and a portion of the cell-sap within them is forced into the cavities of the vessels and tracheids with which the cells are in contact.

The pressure thus set up by the turgid parenchymatous cells of the cortex and the cells of the ground tissue within the vascular cylinder of a root is termed *root-pressure*.

Under this pressure the vessels and tracheids of the vascular bundles become filled with water, and on cutting off the stem of a tree in spring after the roots have begun their absorptive work and before the buds have opened, the water is forced out of the cut end of the stump still connected with the root in larger or smaller quantities; such outflowing of water from plants which have been cut is spoken of as '*bleeding*.' The liquid forced out of a 'bleeding' plant is not pure water, but a solution containing small quantities of various substances, such as soluble carbohydrates, acids, organic and inorganic salts, and proteids. In the sugar maple the liquid contains over 3 per cent. of sugar which in some parts of the world is profitably extracted from it.

In the case of the vine, sycamore, birch and other trees, 'bleeding' may continue for several days, during which time several pints of 'sap' may be exuded.

By attaching a suitable manometer or pressure-gauge to the stump of a 'bleeding' stem, the pressure with which the sap is forced out can be measured: in the vine it frequently amounts to more than one atmosphere, or sufficient to support a column of mercury 760 mm. in height.

The root-pressure of a stinging nettle was found to be sufficient to balance a column of mercury 460 mm. in height, while that of an ash tree was only able to support a column of 20 mm. of mercury.

The phenomena of root-pressure and 'bleeding' are best observed in woody perennials, such as the vine, birch and sycamore, in spring and early summer about the time when the

buds are opening. At this season, the warmth of the soil encourages very active absorption by the roots and the water taken into the plant finds no outlet: the vessels and tracheids of the young wood throughout the plant become, therefore, gorged with water and cutting into the stems allows the water to escape. Later in summer, however, when the leaves are expanded, the water absorbed by the root and forced into the vascular cylinder, travels through the stem and into the leaves, from whence it escapes into the air in the form of vapour as described in the next chapter. The rapid loss of water from the leaves results in the removal of large quantities of water from the cavities of the vessels and tracheids and these latter elements of the wood are then found to contain considerable amounts of air as well as water: plants cut at this season do not 'bleed.'

Moreover, the evaporation of water from the leaves goes on so rapidly that a partial vacuum is created and a *negative pressure* is set up in the vascular system of the plant; under such conditions, instead of water being pressed out with considerable force from the cut stump of a plant connected with its root, the stump is found to absorb any water given to it, and not until it has become saturated can a positive root-pressure be detected.

Root-pressure and 'bleeding' are not confined to trees and shrubs, but are observable in greater or lesser degree in many plants when evaporation of water from the leaves is retarded or prevented. They may be as readily observed in many herbaceous plants, such as the sunflower, potato, tobacco, dahlia and maize, as in woody plants.

The force of root-pressure is usually highest in the afternoon and lowest in the early morning. Like other vital processes, it is influenced by external conditions: an increasing temperature of the soil increases it.

Although the pressure set up by the osmotic activity of the parenchymatous cells of the cortex and other parts of the root

and stem is not sufficient to force water to the top of tall trees, it brings about the introduction of water into the conducting channels and helps in the rapid translocation of water throughout the vascular tissues of the plant.

When the absorptive activity of the root of a plant is encouraged by warmth of the soil and at the same time the loss of water in the form of vapour from the leaves is diminished or prevented by a damp atmosphere, the plant becomes overcharged and water is forced out of the tips and edges of the leaves in drops which are frequently mistaken for dew-drops.

This emission of drops of water may be often observed on the tips and edges of the leaves of such plants as balsams, 'Arum lilies' and fuchsias when growing in warm houses in which a damp atmosphere is maintained. Similar drops are sometimes seen in the early morning on the tips and edges of the leaves of species of *Tropæolum*, *Alchemilla*, and many wild plants after a warm night when the sky has been overcast.

The 'bleeding' of cut stems and the exudation of drops of water from uncut plants is not caused exclusively by the osmotic pressure of the cells in the root, but is due in some degree to the parenchymatous cells of the leaves and the medullary rays and wood parenchyma of the stem, for 'bleeding' from the cut end of a leafy stem which has no connection with a root can often be induced by immersing its young and easily-wetted leaves and stem completely in water.

The osmotic pressure which results in the 'bleeding' of plants when cut, or the forcible emission of drops of water from leaves and other parts is a general phenomenon observable in greater or lesser degree throughout the body of the plant; it is best termed '*exudation-pressure*' or '*bleeding-*

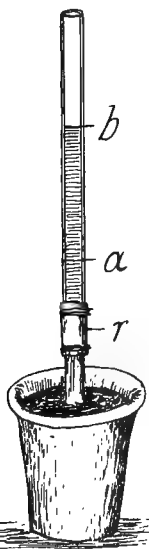

FIG. 84.

pressure, root-pressure being merely a special example of its activity.

Ex. 108.—Water a well-developed sunflower, tomato, or tobacco plant growing in a pot as in Fig. 84, and place it in a warm shaded situation for two or three hours. Then cut off the stem and fasten a glass tube to the stump by means of a piece of rubber-tube (*r*). Pour in a little water and tap the tube to displace air-bubbles; mark the height at which the water stands as at *a*. After a time a considerable amount of sap will be forced from the cut end of the stem and will rise in the glass tube.

Ex. 109.—Cut off the stem of a young vigorously-growing stinging nettle in spring, and after wiping the cut surface of the stump notice with a lens that the sap which is exuded afterwards comes from the vascular bundles and not from the pith.

Ex. 110.—Sow a few barley grains in a pot of good garden soil, and when the plants are about $2\frac{1}{2}$ or 3 inches high place the pot in a warm shaded or dark place and cover the pot with a bell-glass. Notice after three or four hours that from the tips of the young leaves drops of water are exuded. Remove the bell-glass and leave the plants uncovered until quite dry, then cover again and notice a further excretion of water.

CHAPTER XIV.

TRANSPIRATION : THE TRANSPIRATION-CURRENT.

Transpiration.—If the leaf of a growing sunflower or Jerusalem artichoke is enclosed on a warm bright day in a wide test-tube as in Fig. 85, and the end of the tube closed with a split cork (*c*) or a plug of cotton-wool, it will be noticed that the inside of the tube soon becomes covered with a dew-like film of pure water which gradually trickles down and collects in considerable amount as indicated at *a*.

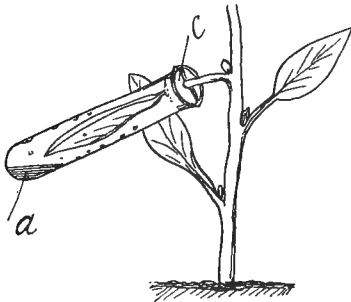

FIG. 85.

From all parts of ordinary land plants there is going on a continuous invisible loss of water in the form of vapour, and unless precautions are taken to collect the water in some manner similar to that described above the existence of its escape from plants into the air is not easily realized.

The exhalation of water in the form of vapour from living plants is termed *transpiration*: it is not a mere physical process of evaporation or drying such as occurs when a damp towel is exposed to the air, but is a physiological process, which, although influenced by external conditions, is nevertheless controlled to some extent by the living protoplasm of the plant. Dead

portions of plants lose water more quickly than similar living portions.

The amount of water transpired by a sunflower $3\frac{1}{2}$ feet high on a warm day was found by Hales to be 20 ounces in twelve hours, and an ordinary cabbage gave off 15 ounces in the same time. At this rate an average crop of cabbages would give off between 3 and 4 tons of water per acre per day. As the loss by the upper parts of the plant must be compensated by absorption of water from the soil, it will be readily understood that land bearing a crop is always drier than bare fallow.

If transpiration goes on at a greater rate than the absorption by the root the turgid state of the cells is more or less decreased and 'wilting' appears. This 'wilted' condition of plants not unfrequently happens in bright hot weather, in dry soils containing too little water, but it may occur in ordinary soils even when the roots are actively taking in what would be a sufficient quantity of water for the needs of the plants, if the brightness, high temperature and other conditions encouraging excessive transpiration were reduced.

'Wilting' does not necessarily imply that no water is entering the plant: it is merely an indication that the plant is losing more than it is taking in.

Unavoidable mechanical injury to the absorbing region of the root when plants are transplanted, injuries from the attack of insects, and reduction of the temperature of the soil below that at which the root is able to carry on its work satisfactorily, are responsible for inadequate absorption of water and consequent 'wilting': moreover, an insufficient supply of air to the root which happens when the latter is growing in water-logged soil prevents proper absorption and may result in flagging of the leaves of the plant.

Among all kinds of plants, and especially among those species living in dry situations, various adaptations are observable which tend to prevent a too rapid loss of water.

The rate at which transpiration is carried on is influenced by the character of the external cell-walls of the various parts of the plants.

From cells with suberised and cutinised walls the loss of water is small, hence, from the stems and leaves of cactuses and house-leek, from many fruits such as apples and pears, with a well-developed cuticle, and also from stems and tubers covered with cork-tissue and bark, the amount of transpiration is comparatively slight: vegetable marrows, potatoes, and many kinds of apples containing a large proportion of water, retain a large amount of it for many weeks and even months.

The presence of a covering of woolly hairs upon the leaves and other parts of plants aids in the prevention of excessive transpiration, and the excretion of a waxy 'bloom' on the exterior of the epidermis of many leaves such as those of the cabbage, swede and onion, and upon fruits such as plums and grapes, acts in a similar protective manner. Experiments show that when the 'bloom' is rubbed from leaves and fruits a greater loss of water takes place than from similar parts untouched.

The amount of what may be termed *cuticular* transpiration, or loss through the external cell-walls of leaves, stems and parts normally exposed to the air, is slight in all cases, except in the youngest members whose epidermal cells have not yet become fully cutinised.

The chief escape of water is by *diastomatic* transpiration, that is by loss through the openings of the stomata, and as these are always met with in greatest abundance upon the leaves of plants, the latter may be considered as the chief organs of transpiration.

The cells of the spongy parenchyma of the leaf (*s*, Fig. 75) possess uncutinised walls which freely allow the passage of water-vapour into the intercellular spaces, and it is mainly from these spaces that the vapour escapes by way of the stomata (*x*).

Generally there are more stomata on the lower surfaces of

ordinary leaves and it may be shown (Expt. 114) that in such cases transpiration is most active from the lower sides.

Unless their surfaces are specially protected by a dense cuticle, plants with leaves of large area usually transpire and need considerable amounts of water for proper growth: they are frequently met with in damp situations unfavourable to transpiration and therefore where a large transpiring surface is a necessity in order to get rid of surplus water.

On the other hand the leaves of plants adapted to live in dry situations are frequently small and narrow, the transpiring surfaces being reduced often to a minimum.

In diastomatic transpiration from a leaf or stem the opening and closing of the aperture between the guard-cells of the stomata (*a*, Fig. 74) regulates and controls the amount of water-vapour given off, and it is the turgidity of these guard-cells which determines whether the pore is open or shut. When the cells are highly turgid they curve away from each other and the opening is as wide as possible; when they become flaccid they straighten and the aperture between them decreases until the free edges of the cells touch and completely close the pore.

The turgidity of the guard-cells, and therefore the possibility of the escape of water-vapour from the leaf, is influenced both by internal and external circumstances. About the nature of the internal vital conditions little is known, but it may be remarked that, when the loss of water is excessive and is not completely compensated by absorption from the soil, the stomata begin to close before actual 'wilting' is observable.

The chief external conditions which influence transpiration are:—

- (i) the intensity of the light to which the plant is exposed,
- (ii) the water-content of the surrounding atmosphere,
- (iii) the temperature of the air and soil,
- (iv) the movement of the air,
- (v) the water-content of the soil and the concentration and

chemical nature of the substances present in the solutions absorbed by the plant.

(i) At night and in darkened rooms plants transpire very little ; in diffuse daylight an increase is noticed, but when exposed to bright sunlight the amount of water given off is vastly augmented. In one of Wiesner's experiments 100 sq. cm. of leaf-surface of a well-grown maize plant gave off in the dark 97 milligrams of water per hour, while in diffuse daylight 114 milligrams were lost and in bright sunlight 785 milligrams.

Usually under the influence of light the turgidity of the guard-cells is increased, the stomatal pore therefore opens and water-vapour is thus allowed to escape freely from the leaf. The action of light upon transpiration is independent of the effect of heat which usually accompanies it ; it is not, however, simply connected with the increased opening of the stomata under its influence, for a similar increase of transpiration is noticed when fungi which possess no stomata are exposed to light of increasing intensity. Light appears to act as a direct stimulus upon the protoplasm, and under this stimulation the latter becomes more permeable to the water of the cell-sap.

It must also be remarked that light indirectly influences transpiration by modifying the structure of the tissues and the composition of the cell-walls of the leaves. Plants grown in well-exposed situations with full access to light have a greater development of cuticle and smaller intercellular spaces within the leaves than those grown in shaded situations ; from the former less water is transpired than from the latter.

(ii) When the air is saturated, as on a dull day or in a close damp greenhouse, transpiration is almost entirely checked ; on the other hand a *dry* atmosphere, even if cold, leads to considerable loss of water, and the injury which occurs to delicate leaves and other recently expanded parts of plants at low temperatures in spring is perhaps caused as much by the dryness of the air at such times as by its coldness.

(iii) Some plants have been found to transpire slightly at temperatures below freezing-point. Increasing the temperature within certain limits accelerates the opening of the stomata, and even in parts of plants free from these openings transpiration is augmented thereby.

(iv) Plants exposed to draughts and stronger currents of air lose considerable amounts of water even when the stomata are closed.

(v) A great decrease of water within the soil in which a plant is growing results in decreased transpiration.

The absorption of a somewhat concentrated solution also decreases transpiration; and plants which have taken up considerable amounts of common salt transpire less than those which have no access to this substance.

Sachs and others found that the alkalies, potash, soda and ammonia in small quantities tended to increase transpiration, while acids decreased it.

Ex. 111.—Collect water from a leaf of a sunflower or other plant in a test-tube arranged as in Fig. 85.

Ex. 112.—(a) Take three flasks, each holding about 100 or 150 c.c., and pour water into each until about three-quarters full.

Cut two similar branches 2 feet long from an apple tree and remove the leaves from one of them; place the branches in two of the separate flasks, and after marking the level of the water in each flask with a piece of gummed stamp paper, expose all three flasks in a well-lighted window or out of doors. Observe the loss of water in each flask after six hours: which branch transpires most?

(b) To obtain a more accurate knowledge of the loss of water, weigh each of the flasks and the branches separately at the commencement and the end of the experiment. It will be observed that the water taken up by the leafy branch is not merely absorbed into its substance but is transpired by its leaves, for its weight at the beginning and end of the experiment are nearly the same, although the weight of water lost from the flask has been considerable.

(c) Repeat the experiment, but keep the apparatus in a dark room.

Ex. 113.—Transpiration from a shoot may be demonstrated by arranging as in Fig. 86. Push the freshly cut shoot (a) through a bored cork: it should fit the hole in the cork tightly and should project a little way through it. Fill the U-tube (n) *completely* with water and put the cork and shoot

into one end of the tube. See that the other end is completely full of water and then insert into it a cork with a bent tube (*b*). Some of the water will be forced along the tube to a point (*c*), which should be marked with gummed paper. Arrange the apparatus so that the tube *b* is horizontal and expose

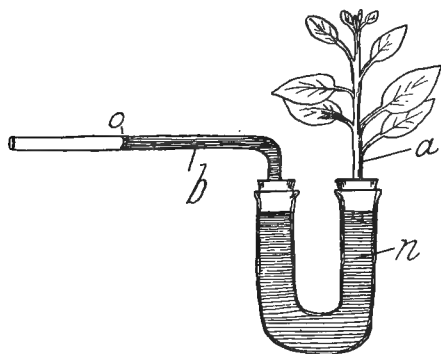

FIG. 86.

to a bright light: the transpiration from the leaves of the shoot soon causes a withdrawal of water along the tube.

It is necessary that the joints of the apparatus should be air-tight and no bubbles of air should remain in the tube (*n*).

Ex. 114.—The difference in the transpiration from the two surfaces of a leaf possessing a great many more stomata on one side than on the other

may be shown by placing the leaf between paper which has been steeped in cobalt chloride solution and dried.

Make a 3 per cent. solution of cobalt chloride and soak some pieces of blotting-paper or circular filter papers in it. Allow the latter to dry in the air. When damp, the cobalt chloride on the paper is pink, but after drying before a hot fire so as to drive off the small remaining amount of water, it becomes bright blue: on absorbing a slight amount of water from the air or from other sources it becomes pink again.

Place a leaf of a scarlet-runner between two blue dry pieces of cobalt chloride paper, and put the whole between two sheets of glass to prevent absorption of water from the air. After a quarter of an hour, examine the papers and note whether that in contact with the lower or the upper side of the leaf is pinkest.

Repeat the experiment with leaves of lilac, elder, pear, poplar, plum and other plants.

Ex. 115.—To show the influence of a covering of cork in preventing loss of water by transpiration, take two potatoes as near the same size as possible. Peel one of them and weigh both separately: leave them exposed to the air for two hours and weigh again to determine which has lost most water.

Show in the same manner that when the cuticle of an apple is removed, a much more rapid loss of water takes place than when the cuticle is present.

Transpiration-current.—The very extensive loss of water from plants by transpiration would soon end in flagging and death if more water were not absorbed to take the place of that which is given off. The necessary absorption takes place at the root in the manner previously explained and between the root-hairs, where the water enters, and the leaves, where the bulk of it escapes into the air, there is a continuous upward movement of a stream of water through the root and stem of a growing plant. This current of water is termed the *transpiration-current*.

By its means the necessary turgidity of the living cells in all parts of the plant is maintained, and it is concerned with the conveyance of a constant supply of dissolved food-materials from the soil.

The water absorbed by the root contains dissolved in it various substances which are essential for the nutrition of the plant, and these substances are carried to the cells of the leaves and other organs where they are left and utilized, only pure water escaping in the transpiration-process. Moreover, it may be noted that the conditions which bring about active transpiration and rapid movement of water, namely, a high temperature and exposure to bright daylight, are just the conditions which are essential for the rapid formation of organic substance from the food-materials and for the utilisation of the food in the nutritive processes carried on by the plant.

The movement of water in all parts of plants from cell to cell by simple osmosis, is much too slow to be of use in maintaining an adequate supply to the upper parts of plants where rapid loss is occurring. The transpiration-current travels more rapidly: in certain herbaceous plants it has been found to move at the rate of 5 or 6 feet per hour, when the conditions for transpiration have been favourable; probably it is slower than this in most trees.

The path along which the water is conducted is the wood of the plant. That it is not conveyed by the pith of a tree is clear

from the fact that many trees carry on their functions after the pith is destroyed and the centre has become hollow and decayed.

It can also be readily shown that the bark and bast do not conduct the rapid upward current, for after a narrow ring-like portion of tissues, as far as the cambium have been removed all round a branch, the leaves above the place where the bark and bast have been cut away do not wither.

By various experiments it has been proved that the current travels in the youngest or outermost annual rings of woody stems and apparently in the greatest amount, if not entirely, in the cavities of the vessels and tracheids; the heart-wood does not conduct water but acts as a mechanical support.

By placing the cut stems of herbaceous plants and the petioles of leaves in coloured solutions of certain dyes, and subsequently making sections of the stems at intervals, and by holding the leaves up to the light, it will be observed that the solutions have travelled along the vascular bundles which have become stained, the rest of the tissues remaining colourless for a long time after the bundles have been coloured.

The cause of the movement of the water through plants, or the force which propels the transpiration-current, has been the subject of very extensive research for more than a century.

No adequate explanation can, however, be given which will meet all the facts of the case. The osmotic action of the living cells of the root and stem which results in 'bleeding-pressure,' and the osmotic attraction of substances within the parenchymatous cells of the leaves, which results in a sucking-force withdrawing water from the vascular bundles, help to set up rapid movement of water in a plant.

In plants of low stature, these forces depending on the activity of living cells, may be sufficient to account for the movement of the transpiration-current, but the conduction of water to the top of very high trees, cannot be satisfactorily explained at present.

TRANSPIRATION

Ex. 116.—(a) Dip the petiole of a leaf of elder in a weak solution of eosin or red ink and place the whole in a bright situation. After an hour hold the leaf up to the light and examine with the naked eye or a pocket lens; the solution is absorbed and travels along the vascular bundles which will be seen to be coloured red.

Cut thin slices of the petiole and observe with a lens that the solution has not diffused much into the tissues round the vascular bundles.

(b) Repeat the experiment with other leaves and herbaceous leafy stems.

(c) Dip the peduncles of snowdrops, pansies, crocuses, narcissi and other flowers in the solution and note that the thin vascular bundles in the petals become stained red.

Ex. 117.—Remove a ring of bark, $\frac{1}{2}$ an inch wide, from the branch of a tree in summer and note that the leaves above the cut do not wither.

Ex. 118.—To show that a rapidly transpiring shoot possesses a considerable sucking-power arrange a shoot of a sycamore, raspberry or sunflower as in Fig. 87.

Take a piece of rubber-tube (*r*) about 2 inches long and slip one end on the end of the shoot, the other on a glass tube (*a*). Firmly tie the rubber-tube to the shoot and the tube with string. Allow the shoot to hang down, and then pour water into the tube; gently tap the latter and squeeze the rubber-tube so as to get rid of all air bubbles. When the tube is full of water close the end with the thumb, turn up the apparatus into the position indicated in the Fig. 87, and place the end of the tube below the water (*n*) and mercury (*b*) in the glass dish. Support the shoot by means of the clip and expose the whole in a bright window. The water in the tube is transpired by the leaves of

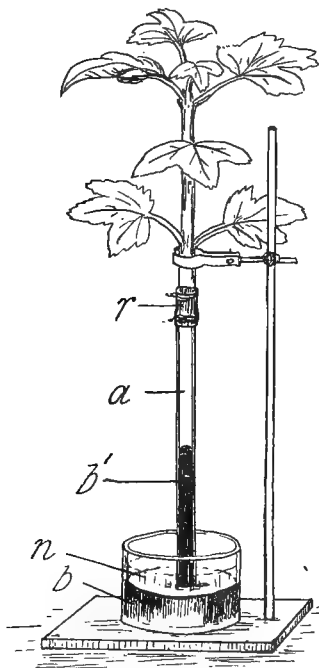

FIG. 87.

the shoot, and a considerable amount of the mercury is lifted into the tube, as shown at (*b*¹).

CHAPTER XV.

THE ABSORPTION OF FOOD-MATERIALS.

1. **Food and food-materials.**—The protoplasm or the living material within actively growing plants and animals is continually undergoing chemical changes which result in its destruction and the formation from it of simpler compounds. To repair its waste and to enable it to carry on the work of constructing new parts, food is necessary.

The nature of the *food* of a plant, or the substances which are utilised by the protoplasm for the formation of new organs and for its own nutrition, is most readily understood after a consideration of the materials which are consumed during the growth of an embryo plant from a seed.

The substances stored by the parent in the endosperm or within the tissues of the embryo for the nutrition of the latter are chiefly complex organic compounds such as starch, fats, and proteids, and it is these substances, or very slightly altered forms of them, which are consumed in the processes of nutrition and growth which occur when germination commences.

Similarly, the substances upon which the young shoots of a sprouting potato tuber or the young leaves and flowering shoots of a growing bulb are fed, are carbohydrates, fats, and proteids or organic compounds of analogous complex constitution.

The developing buds of a tree in spring are also nourished by similar compounds, and there is every reason to conclude that the protoplasm in plants and animals alike, depends at all times for its immediate nutrition upon organic materials of this character.

Animals and parasitic and saprophytic plants obtain these compounds directly or indirectly from the bodies of other living or dead organisms, and without a supply of such substances they soon die. Green plants likewise need food of a similar complex nature for development and growth; they are, however, not generally adapted to obtain compounds of this character from their surroundings, but are able to manufacture them from inorganic compounds such as carbon dioxide, water, and various salts which they derive from the atmosphere and the soil.

Although these simple inorganic materials absorbed from the air and the soil are frequently spoken of as the food of plants, it is better perhaps to speak of them as *food-materials*, for the living substance of a plant cannot directly nourish itself upon them. It is only after they have been elaborated or built up into more complex compounds that they become food which can be used for the nutrition of the protoplasm and the formation of the tissues of growing organs.

A seedling after it has consumed the food stored for its use by its parent, is unable to make use of carbon dioxide and simple salts supplied to it until it is exposed to light under certain conditions which allow it to elaborate and synthetically build up from these inorganic materials compounds similar to those which it has already consumed, and which were supplied and manufactured previously by its parent.

2. **Food-materials and their absorption.**—The food-materials absorbed by ordinary green plants are derived from the surrounding atmosphere and soil upon which the plants grow.

By the methods of sand-culture and water-culture it has been proved that for complete and perfect nutrition, green plants must be supplied with food-materials which contain collectively some ten or eleven elements as explained in chapter xii.

It has also been determined by the same experimental methods that plants are by no means indifferent as to the form in which any particular element is presented to them. For

example, they are not able to utilise all nitrogenous compounds as sources of nitrogen, nor are they able to obtain their necessary carbon from all kinds of carbon-compounds.

A compound to be of service as a food-material capable of supplying a particular element for the nutrition of a plant, must (i) be soluble and able to diffuse through the cell-wall and protoplasm of the cells, and (ii) must also possess a certain chemical structure.

The carbon dioxide gas present in the air is the chief source from which the carbon is obtained; the absorption and subsequent use of the gas is discussed in the succeeding chapter.

The food-materials furnishing the rest of the elements needed by plants are obtained from the soil by osmosis through the root-hairs. Before they can enter the latter they must be in solution, since no solid particle however small is able to pass through the closed cell-membranes of the absorbent hairs.

Moreover it is only from weak solutions of food-materials that plants can absorb what they need; plants grown by the method of water-culture make the most satisfactory progress when the total amount of solids dissolved in the water does not exceed from '2 to '5 per cent. or 2 to 5 parts in 1000 of water. Solutions containing 2 or $2\frac{1}{2}$ per cent. of dissolved substances act injuriously upon the protoplasm of the plant, and prevent growth: hence the importance of avoiding readily soluble manures in excess.

The water of the soil from which plants obtain all they need usually contains not more than '01 to '03 per cent. of solid matter dissolved in it.

Carbon dioxide gas is produced within the soil in the processes of putrefaction and decay of the manures present, and is excreted to a slight extent in the respiration process carried on by the protoplasm of the root-hairs. This gas indirectly assists plants to absorb useful food-materials, for some of the latter which are

insoluble in pure water, dissolve appreciably in water containing carbon dioxide.

It must also be noted that carbon dioxide, potassium hydrogen phosphate and other substances possessing an acid reaction permeate the cell-walls of the root-hairs, and enable the latter to corrode and dissolve certain mineral compounds such as calcium phosphate and the carbonates of calcium and magnesium with which they come into contact.

3. When the roots of a plant are immersed in a vessel of water containing a substance in solution, the dissolved substance may not be able to pass through the cell-wall or the cytoplasm of the root-hairs in which case none enters the plant. If, however, the substance can diffuse through both cell-membranes, it will pass into the root-hairs and from there into the rest of the cells of the plant until the cell-sap contains the same proportion of it as the water outside the plant; when this condition is reached, equilibrium is established and no more of the dissolved material is absorbed. Should the substance after entering the plant be used up in the processes of nutrition, or changed into an insoluble or non-diosmosing compound, the osmotic equilibrium in regard to this particular material is destroyed, and more of it can then enter. In this manner a plant is able to completely extract the whole of a substance dissolved in water to which its roots have access, and can accumulate within itself large amounts of certain elements from solutions containing the merest traces of them. For example, sea-water contains not more than one part of iodine in 100 millions of water, and yet certain sea-weeds accumulate such quantities that from 1 to 3 per cent. of their ash consists of this element.

The total amount of any particular element occurring in the ash of a plant is dependent (1) upon the amount of the soluble material containing it present in the soil upon which the plant is growing; (2) upon the peculiar specific permeability of the protoplasm of the root-hairs; and (3) also upon the question of whether the plant utilises, transforms or removes the par-

ticular material from its cell-sap so that more can enter by osmosis.

Two different species of plants growing in the same nutrient-solution or with their roots in the same soil are generally found to contain very different amounts of each of the various ash-constituents. For example, the amount of silica in the ash of the white water-lily is generally less than a $\frac{1}{2}$ per cent., while that of the common reed (*Phragmites communis* Trin.) growing on the same marshy soil contains more than 70 per cent. of silica; and while the ash of pea plants is found to contain not more than about 7 per cent. of this substance, that of grasses growing on the same soil contains over 20 per cent. of it.

This different *quantitative selective power* is chiefly due to the difference in the power of making use of silica by the two species of plants compared; the substance from which the silica is derived probably diffuses with equal freedom through the cell-walls of both, but whereas the reed continually removes the compound from the cell-sap and deposits large quantities of silica in its cell-walls, thus allowing more to flow in, the water-lily uses very little and a state of osmotic equilibrium is soon reached, after which no more enters the plant.

The amount of any particular substance absorbed from the soil by a plant is in direct proportion to the amount used in the chemical processes carried on by the plant, so that a substance present in abundance may be absorbed in very minute quantities only, whereas a compound present in small amount may be completely extracted from the soil.

4. The nature of the various inorganic compounds from which green plants obtain their supply of the elements essential for complete nutrition, has already been mentioned in discussing the composition of plants in chapter xii.

Practically all these food-materials except carbon are absorbed from the soil.

Experience proves that the continuous growth and removal

of crops from the land end sooner or later in reducing such land to a state in which it refuses to grow a remunerative crop of any kind unless manures are applied to it.

This more or less barren condition of land from which many crops have been removed is explained by the fact that plants lift into their bodies from the soil on which they grow a certain amount of its constituents, and the removal of a crop therefore means the removal of a considerable weight of the most important components of the soil: since the latter does not in any case contain an unlimited supply of these plant food-materials in a soluble and available form, it will be readily understood that the continuous removal of crops from a field must eventually lead to exhaustion, and that plants grown upon it would starve, unless a new supply of food-material is added to take the place of that previously removed.

It is true that the soil under such treatment does not become so completely exhausted of its useful constituents that plants altogether refuse to grow upon it, for soluble food-materials are constantly being released or renewed from the store of insoluble material composing the soil by the disintegrating influence of frost and heat, and the chemical action of the air and water upon it. Nevertheless, in this country, for the production of a remunerative crop, the direct application of manure containing food-materials or from which the latter can be readily set free, is necessary in the case of most soils from which two or three successive crops have been taken.

Plants cannot grow unless they are supplied with all the elements mentioned as essential on pp. 170 to 174; should one of these be totally missing from the soil, growth becomes impossible. From this peculiarity the power of the soil to yield a crop is controlled by the essential element which is present in the least amount.

If a soil contains too small an amount of phosphates for the growth of a crop, the fact that other elements such as

nitrogen or potassium are present in great abundance avails nothing, for these cannot be utilised until the necessary phosphates are available.

The food-materials from which plants obtain the sulphur, iron, magnesium, calcium, carbon, hydrogen and oxygen are almost always present in the soil and air in sufficient abundance for the needs of all crops, but the compounds which yield nitrogen, phosphates and potassium are generally removed in such quantities that the supply is soon reduced to such a point that for full crops manure containing one or all of these elements must be added to the soil.

CHAPTER XVI.

‘ CARBON-FIXATION,’ ‘ ASSIMILATION,’ OR ‘ PHOTOSYNTHESIS.’

1. THE source from which plants obtain the large quantity of carbon of which more than half their dry weight consists, has been the subject of extensive investigation for a long time.

Parasitic plants, such as dodder, broomrape and many fungi, attach themselves to other living organisms and absorb the carbon they need in the form of sugar, proteids and other elaborated carbon compounds from their victims. Saprophytes, such as the bird's-nest orchis (*Neottia*), mushrooms, and the majority of common fungi, which like the above-mentioned parasites are devoid of chloroplasts, obtain their carbon in a similar elaborated form from the carbon compounds present in the remains of dead plants and animals upon which they grow.

It is probable also that all green plants absorb and utilise organic carbon compounds from the *humus* or decaying vegetable and animal remains within the soil, although it has been proved that this source is insufficient to supply all the carbon needed for the perfect healthy nutrition of plants of this kind.

By the method of water-culture or sand-culture it may be readily shown that ordinary green plants flourish and increase in carbon-content when their roots are supplied with a solution of food-materials containing no carbon, so long as the solution contains all other essential elements.

Under these circumstances the only source of carbon is the carbon dioxide of the atmosphere surrounding the leaves, and although the proportional amount of this gas present in the

air is very small, averaging about 2·8 parts in 10,000, it is from this source that the whole of the carbon of plants grown by the method of water-culture is derived.

In the processes of fermentation and decay going on in ordinary soil carbon dioxide is produced and the air permeating the interstices of the soil may contain as much as 5 per cent. of this gas, some of which enters the roots of plants dissolved in the water of the transpiration-current: it has, however, been shown by Cailletet and Moll's experiments that the supply of carbon dioxide obtained in this manner is insufficient for the requirements of ordinary green plants.

Extended and carefully-conducted investigations have proved beyond doubt that the chief food-material utilized by green plants for their carbon-supply, is the carbon dioxide of the air, and that this gas is absorbed by means of the leaves. Moreover, it is through the stomata that the gas enters into the tissues and only in slight degree, if at all, through the cuticle of the epidermal cells.

The rate at which the absorption of the gas is carried on by the leaves has been recently investigated by Brown and Escombe: the amount absorbed by a sunflower exposed to diffuse daylight was found, in one instance, to be 412 cubic centimetres per square metre of leaf-surface per hour; the hourly absorption for a *Catalpa* leaf was 345 c.c. for each square metre. Under favourable conditions the rate of absorption of the gas by a leaf was found to be equal to one-half that of a strong solution of caustic potash of equal area, and, since the actual openings between the guard-cells of the stomata in the leaf investigated amounted to not more than $\frac{1}{100}$ part of the whole area of the leaf, it follows that the rate at which carbon dioxide entered was fifty times as rapid as that at which the gas is absorbed by a solution of caustic potash, a truly astonishing result.

This absorptive activity on the part of green vegetation would soon result in the total removal of carbon dioxide from the air,

were it not for the fact that the atmosphere is being continually replenished with carbon dioxide which is produced in the process of respiration carried on by all living things, and by the combustion of coal, wood and other kinds of fuel containing carbon.

After entering into the cells of the leaf the carbon dioxide, together with a certain proportion of water, undergo chemical changes which result in the formation of soluble carbohydrates, oxygen being also set free during the process.

The carbon of the carbon dioxide thus becomes 'fixed,' and a rapid accumulation of carbohydrates takes place in the tissues of the plant, the oxygen escaping into the air.

The process may be represented thus :—

carbon dioxide + water = a carbohydrate + oxygen.

It has been customary among botanists to use the term *assimilation* for the synthesis of carbohydrates by green plants in this manner from carbon dioxide and water, but it would be better to reserve the term for the conversion of foods into the substance of the tissues, as is done by animal physiologists, and employ another for this synthetical production of carbohydrates which is peculiar to green plants. As the operation is dependent upon light the term *photosynthesis* has been suggested and some such term or the expression '*carbon-fixation*' is much to be recommended instead of 'assimilation.'

The exact nature of the carbohydrate first formed during the process is not known. Von Baeyer suggested that formaldehyde (CH_2O) is first produced according to the equation—



and that this compound subsequently undergoes condensation into a carbohydrate of the formula $\text{C}_6\text{H}_{12}\text{O}_6$. However, formaldehyde cannot be detected in the tissues in which the process of 'carbon-fixation' is going on, and although Bokorny's experiments show that under certain conditions formaldehyde can be utilised by plants for the production of carbohydrates, the view

that this compound is the first step in the formation of carbon compounds from carbon dioxide and water is nothing more than a hypothesis.

What is certain is that sugars are soon formed in the cells of the leaf-parenchyma after the green leaves of plants absorb carbon dioxide from the air, and the brilliant investigations of Brown and Morris point to the conclusion that cane-sugar is the first sugar to be manufactured, and that subsequently dextrose, levulose and maltose sugars make their appearance in leaves in consequence of the action of enzymes upon the previously-formed cane-sugar and starch.

In a great many plants when the accumulation of sugar within the cells of the leaves reaches a certain point the chloroplasts form starch-grains from it; the starch-grains appear within the substance of the chloroplasts and are the first *visible* products of 'carbon-fixation.'

The total amount of carbohydrates produced by leaves of the same area depends upon internal vital peculiarities of the different species of plants; for example, in a given time a sunflower leaf produces more than a leaf of a dwarf-bean of the same area. The amount manufactured by a sunflower during twelve hours on a moderately bright day was found by Brown and Morris in one instance to be a little more than 12 grains of carbohydrates per square metre of leaf-surface.

2. The manufacture or synthesis of carbohydrates in the manner indicated above is dependent upon various conditions, of which the following are the most important:—

- (i) The plants must be living.
- (ii) Carbon dioxide must be present in the air surrounding their leaves.
- (iii) The leaves must contain chloroplasts.
- (iv) A certain intensity of light is essential, and
- (v) an adequate degree of temperature is necessary for the process.

(vi) 'Carbon-fixation' is also influenced by the presence or absence of certain mineral substances, especially compounds of potassium obtained from the soil, but the particular part which these substances play in the process is not known.

The 'fixation of carbon' is a vital process and ceases with the death of the plant.

Plants grown in air from which the carbon dioxide has been extracted do not increase in dry weight, and after a time death takes place from starvation. They are not able to live in an atmosphere of pure carbon dioxide, but are able to carry on 'carbon-fixation' in air containing as much as 20 or 30 per cent. of the gas. According to the experiments of Montemartini the formation of carbohydrates is carried on best and most rapidly in air containing 4 per cent. of carbon dioxide, an amount six or seven times as great as that normally present in the atmosphere.

'Carbon-fixation' is apparently carried on only by specialised portions of the protoplasm of the cells, namely, by the chloroplasts, for it only occurs in the leaves and parts which are green. The roots, the petals of flowers, and the white portions of variegated leaves from which chloroplasts are absent take no part in the process, and parasitic and saprophytic plants which are devoid of these structures are also incapable of utilising carbon dioxide for the formation or synthesis of carbohydrates.

The leaves of the copper-beech, purple cabbage, red beet and many other plants have reddish cell-sap which disguises the green colour of the chloroplasts: the latter are nevertheless abundant in the palisade and spongy parenchyma of such leaves, and the plants as readily carry on the process of 'carbon-fixation' as those having ordinary green leaves.

The chloroplasts are small structures imbedded in the cytoplasm of the cell; their substance is permeated with a green pigment named *chlorophyll*, associated with which is a reddish orange substance known as *carotin*, and a yellow material termed *xanthophyll* allied to the latter.

The chemical nature of chlorophyll is unknown : its production is, however, in some way dependent upon the presence of iron in plants although it does not appear to contain this element.

The chloroplasts of plants grown in the dark or covered up for a time, lose their green colour and become colourless or pale yellow. With the exception of the chlorophyll of the chloroplasts present in the embryos of certain plants, the production of this green pigment is dependent upon light : the cotyledons and first leaves of most seedlings and the leaves from underground buds of perennial plants only become green when they reach the surface of the soil. Moreover, the formation of chlorophyll is influenced by heat ; the plastids of many plants grown in the dark do not develop a green tint even when exposed to light when the temperature is below freezing-point, but do so at higher temperatures.

Chlorophyll, perhaps in a more or less altered form, can be extracted by means of alcohol : its solutions are fluorescent, appearing blood-red when seen by reflected light, and green when viewed by transmitted light. When acted upon by acids it changes to a dirty brownish-green colour. After death of the cytoplasm of the cells, the acid cell-sap, which is confined within the vacuole of the cells when the plant is living, diffuses through the cytoplasm to the chloroplasts, causing them to change to the brownish-green tint so characteristic of dead leaves.

Light is not only essential for the formation of chlorophyll, but it is also directly necessary for the process of 'carbon-fixation,' as it is from the energy of the sun's rays that the energy required to effect the decomposition of the carbon dioxide and water used in the process is derived.

In darkness, green plants are unable to effect the synthesis of carbohydrates from carbon dioxide and water, and under such conditions they decrease in dry weight owing to the loss caused by respiration, which goes on at all times (see chap. xix.).

In shady places, in badly-lighted rooms, and in greenhouses

during the dull days of winter, the manufacture of carbon compounds is usually slow, and is often insufficient to supply the proper needs of plants. Similar partial starvation due to want of light occurs among thickly-planted crops and in the inner boughs of trees bearing an excess of leaves, and in all cases of over-crowded plants. With an increased intensity of light, 'carbon-fixation' increases proportionally up to a maximum, which for many plants is not attained until they are exposed to direct sunlight.

Certain shade-loving plants, however, need a moderate intensity of light for proper nutrition; exposure to intense light retards or altogether suspends their activity in this respect, and at the same time acts injuriously upon their chloroplasts and other protoplasmic cell-contents.

In the majority of plants, the epidermal cells are free from chloroplasts, and the cell-contents of this tissue no doubt screen the chloroplasts of the deeper-lying tissues from the deleterious action of too brilliant light. Moreover, the chloroplasts are moved into more advantageous positions within the cells, when the intensity of the light falling upon the leaves becomes too great.

The red, orange and yellow rays present in sunlight are most effective in promoting 'carbon-fixation,' the purple and violet rays having very little effect upon the process.

In many plants 'carbon-fixation' goes on to a slight extent at one or two degrees above freezing-point: with increasing temperature the process increases in activity up to about 20° or 25° C., beyond which temperatures it decreases until at about 56° C. it ceases altogether with the death of the plant.

Ex. 119.—Place some shoots of *Potamogeton*, *Elodea canadensis*, mare's tail (*Hippuris*) or mint in a beaker full of well water. Slide a glass funnel into the beaker as indicated in Fig. 88, and over the end of the funnel place a test-tube full of water. Expose the whole to bright daylight, and notice that bubbles of gas rise from the leaves of the plants and collect at *o* in the test-tube.

After a few c.c. of gas have been collected, remove the test-tube, and

place the thumb over the open end of the tube while it is below water, so as to prevent air from getting in. Take out the tube completely, turn it up, and keep the thumb over the end of the tube all the time; then remove the thumb, and plunge a smouldering match-stalk into the gas.

Although the gas collected is not pure oxygen, it contains a considerable proportion of the latter, and causes a smouldering match to burst into flame when placed in it.

Ex. 120.—(i) Tie a terminal shoot of *Elodea* 4 to 6 inches long to a glass rod, and place so that the broken end of the shoot is uppermost in a tall glass cylinder full of well water.

Expose the whole to bright daylight; notice and count the number of bubbles of oxygen which rise from the broken end of the shoot in two or three minutes.

(ii) Move the apparatus to a badly-lighted room, and count the bubbles rising in the same time as before. Do more bubbles rise when the plant is exposed to bright light than when exposed to a dim light?

Ex. 121.—Repeat the above experiment, using boiled water from which all the carbon dioxide has been driven off. Notice that little or no gas is evolved. Now supply carbon dioxide to the water by blowing through a glass tube into it.

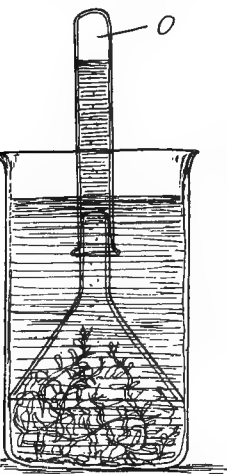

FIG. 88.

Ex. 122.—Repeat Ex. 119, using roots, flowers, or other portions of plants which are not green, to show that oxygen is not evolved from such parts.

Ex. 123.—(i) In the afternoon of a warm, bright day pluck off a leaf from several common broad-leaved plants, and test for starch in them, thus:—

First place them in boiling water for a minute, after which transfer them to a vessel containing warm methylated spirits to dissolve out the chlorophyll and other pigments. Leave them in the latter for a few hours until they are pale in colour, and then transfer them to a saucer containing a solution of iodine (see Ex. 85).

If they contain starch they will turn black or deep purple.

(ii) Test for starch in leaves variegated with white patches and show that none is formed in the white parts from which chloroplasts are absent.

Ex. 124.—(i) Smear one half of a pear or poplar leaf with cacao butter or best lard on both sides to block up the stomata. Leave for two days, and in the afternoon of the following day, test the whole leaf for starch, after removing the butter with hot water.

Note that no starch is formed in the half to which access of carbon dioxide is prevented.

(ii) Smear the upper surface only of a pear or poplar leaf, and the lower surface only of another similar leaf. Leave for three days as before, and then test for starch.

Find out which leaf possesses most starch ; then determine with microscope on which surface stomata are most abundant.

Ex. 125.—To show the effect of darkness on starch formation, tie up a leaf of *Tropaeolum* in a thick brown-paper bag so that no light can get at it. Leave it covered up for two days, and then test for starch.

Ex. 126.—Boil a quantity of young grass leaves for a minute or two and then extract the chlorophyll by placing the leaves in strong alcohol in a dark cupboard.

Pour some of the solution into a beaker or large test-tube ; note the green colour when held up to the light, and dark red colour when viewed by light reflected from it.

Note the effect on the colour when a few drops of hydrochloric acid are added to the solution.

Ex. 127.—Grow some seedlings of wheat, mustard, or peas in total darkness, and note that the leaves are not green. Expose the plants to light and observe when the first signs of a green colour are visible.

Ex. 128.—Place a large can, bowl or basin upside down on a lawn or grassy field so as to exclude light from the plants beneath it. Leave it for one or two weeks and then examine the grass beneath ; note the loss of green colour.

CHAPTER XVII.

FORMATION OF PROTEINS. TRANSLOCATION AND STORAGE OF FOODS.

1. WITHIN the body of a living plant a great variety of chemical changes, which are collectively referred to as *metabolic processes* or *metabolism*, are always being carried on. Some of these changes, like those discussed in the preceding chapter, result in the formation of complex compounds from simpler ones; such constructive chemical processes are spoken of as *anabolism*, the destructive chemical changes, such as those involved in the respiration-process, which result in the breaking down or decomposition of complex compounds into simpler ones, being included in the term *catabolism*.

The conditions under which the chemical reactions take place within a living plant, are very much more complicated and probably of a very different class from those met with in a chemical laboratory, and our knowledge respecting the chemical changes involved in the production of the many different organic compounds present in plants is still very scanty and imperfect.

2. **Formation of proteins.**—During the growth of green plants there is not only the synthesis or construction of sugars and other carbohydrates from simple inorganic food-materials, but other organic compounds are built up, the chief of which are those containing nitrogen, namely, amides and proteins.

The natural sources from which green plants obtain the nitrogen necessary for the production of these compounds are:—

- (i) The free uncombined nitrogen of the atmosphere.

(ii) The complex nitrogenous organic compounds of the humus in the soil.

(iii) The ammonium salts, and

(iv) Nitrates also present in the soil.

Among the higher plants only the Leguminosæ appear to be able to utilise the free nitrogen of the air (see p. 792), and it has been proved by means of sand- and water-cultures that although green plants are able to make immediate use of ammonium salts and a great variety of organic nitrogenous compounds, such as urea and leucine, they nevertheless thrive best when supplied with nitrogen in the form of nitrates; this is true even of leguminous plants, which *can*, under certain conditions, obtain nitrogen from the atmosphere.

As ammonium salts and the nitrogenous organic compounds of dung, urine and humus when placed in the soil are ultimately changed into nitrates (see p. 785), it is inferred that crops ordinarily obtain the chief portion of the nitrogen which they need from the nitrates of calcium, magnesium, potassium and sodium present in the soil.

The chemical changes which nitrates undergo after their absorption by plants and in what tissues or organs these changes take place are still practically unknown.

Plants differ very much in regard to the method of taking up and utilising nitrates; in some species nitrates can be detected in all parts of the plants, while in others they can only be found in the stem or roots, and in some none are found, in which latter case the decomposition of these compounds appears to take place at the very threshold of entry into the plant, namely, in the root-hairs and delicate fibrils of the root.

It may safely be concluded that between the simple nitrates absorbed from the soil, and the proteins produced in the plant, there are many intermediate products manufactured. What these products are is not known with certainty, but there is no doubt that asparagine (amido-succinamic acid) and probably

other amides and amido-acids are among the intermediate nitrogenous compounds from which proteins are ultimately constructed with the aid of previously-formed carbohydrates.

The construction of proteins from asparagine and sugars appears in certain cases, to take place in the leaves and may go on in the dark, but in some instances the process is favourably increased when the plants are exposed to the light. Similar manufacture of proteins occurs in roots and probably in other parts of plants.

Schultze and others have shown that plants can utilize nitrates and ammonium salts for the manufacture of asparagine and allied amido-compounds. According to Suzuki, the conditions for the formation of asparagine from nitrates are a somewhat high temperature and the presence of sugar.

Besides being produced synthetically from absorbed nitrates or ammonium salts and sugars, asparagine is apparently produced in plants by the decomposition of proteins, and this asparagine can be utilised again for the regeneration of proteins when a suitable supply of carbohydrates is present to complete the synthesis.

In addition to nitrates, other inorganic compounds such as sulphates and phosphates take a part in the formation of proteins, for the latter contain sulphur and sometimes phosphorus as well; probably some of the metallic elements, such as potassium and calcium, which are known to be essential for proper nutrition of plants, are also more or less directly indispensable to the formation of complex proteins.

3. Utilisation, translocation and storage of plant-foods.—

The various organic compounds manufactured by anabolic processes are utilised in different ways. A certain amount of sugars and fats are consumed in the respiration-process, and in the case of plants grown in the dark and in the earliest stages of the growth of seeds, tubers and bulbs, the destructive respiratory process results in a considerable loss of carbon which is given off as carbon dioxide into the air; under such conditions there

is therefore a decrease in the dry weight of the plants. However, when the leaves and organs which effect 'carbon-fixation' have been developed, there is usually a continuous increase in dry weight from the beginning to the end of the life of a plant, anabolism being largely in excess of catabolism.

The larger proportion of the sugars, fats, proteins and other organic compounds manufactured by the plant, are employed in the construction of the cell-walls and protoplasm of the new cells arising at the growing points, and in nourishing the protoplasm of more mature cells and also in thickening the walls of the latter. Under ordinary conditions of growth more organic material is constructed than is needed for the immediate nutritive requirements of the individual plant: the excess is stored for the nutrition of its offspring, and, in the case of a perennial, for its own nutrition at subsequent periods of its growth.

According to Brown and Morris' researches cane-sugar appears to be the first sugar formed in the 'carbon-fixation' process carried on by green leaves.

The cane-sugar appears to be subsequently transformed by the enzyme invertase in the leaves into dextrose and levulose; the latter sugars then travel from the leaf-blade through the petiole and into the stem along which they are translocated to the buds, growing-points and other parts of the root and shoot where growth and the formation of new organs or new tissues are taking place, and also to the centres, where storage of reserve-foods is occurring.

The starch formed in the chloroplasts of the leaf-blade, is acted on by the enzyme diastase present in the cells and becomes transformed into maltose which travels from the leaf with the rest of the sugars to the centres of nutrition and storage.

Diastase increases in leaves kept in the dark, and in consequence the disappearance of starch goes on most rapidly at night

The sugars and other soluble carbohydrates travel in the plant osmotically from cell to cell, by far the largest amount being transferred from the leaves to the stem through the bast and elongated parenchymatous cells surrounding the vascular bundles; in the stem and roots these compounds travel through the tissues of the bast and probably to a slight extent through the inner parts of the cortex also.

The medullary rays receive from the bast the materials manufactured in the leaves, and convey them to the cambium and living portions of the wood needing nourishment.

Proteins, which diffuse very slowly or not at all through cell-walls, are transferred long distances in stems and roots through the open sieve-tubes of the bast. These compounds are also frequently acted upon by enzymes which decompose them into peptones and the amides, asparagine, leucine and tyrosine, which diffuse with greater ease.

The stream of sap conveying crude food-materials from the soil to the leaves travels through the wood, but the elaborated foods are translocated chiefly through the bast.

The removal of a complete ring of 'bark' from the stem of a tree as far as the wood-tissue does not interfere with the upward flow of water and food-materials, but it prevents the stream of elaborated food from passing down to the roots, and unless the wound is healed by the formation of new conducting-tissue across the exposed part, the roots ultimately die of starvation and the whole tree succumbs. The time during which a tree will live after being 'ringed' depends upon the kind of tree and also upon the amount of organic material stored in the root-stock and roots before the wound was made.

'Ringed' trees may, however, live an indefinite period if adventitious shoots arise below the 'ringed' part, for these leafy shoots manufacture organic material and as there is an uninterrupted connection between such new shoots and the root-system, the latter can receive a certain amount of nutrient

material which may be sufficient to enable it to grow for a long time.

The substances manufactured in a shoot or branch of a tree are prevented from leaving it when the branch is 'ringed,' and the shoot and fruits upon it grow more luxuriantly in consequence of their increased food-supply.

There is often a special growth of the wood and bast tissues just above the 'ringed' part in consequence of the accumulation and utilisation of organic material at that point.

Similar thickening or enlargement of the stem arising from impeded flow of elaborated sap is seen immediately above the point where scions have been inserted on stocks in the grafting process, especially where the union of the two grafted parts is imperfect.

Wire or string tightly bound round the stems and branches of trees leads to similar results.

Ex. 129.—Remove leaves from *tropæolum*, clover, and other plants in the afternoon and test for starch in them with iodine as in Ex. 123. Remove from the same plants similar leaves in the early morning of next day and test for starch.

Compare the two sets of leaves and note the greater amount of starch in those plucked in the evening

Ex. 130.—Remove in spring or early summer a ring of bark about half an inch wide from the branches of several kinds of trees. Also from some of the branches remove two or three similar rings of bark near each other, so as to leave a bud on some of the unringed portions and no buds on others.

Note the subsequent growth and development of the various parts of the shoots above and below the 'ring.' Do the buds lying between two 'rings' develop satisfactorily?

Ex. 131.—In spring before the leaf-buds are open make cuttings of the willow about a foot long from well-ripened portions of last season's shoots: 'ring' the cuttings about one and a half inches from their base and place some in water and others in damp soil. Leave them until adventitious roots develop; note the relative size and rate of development of the roots and buds above and below the 'ringed' part.

Ex. 132.—Tightly bind string or wire twice or three times round the branch of a tree, and observe the subsequent development of the various organs above and below the bound part.

4. The surplus organic material manufactured by a plant is transferred to various parts of its body to be stored for future use. Among annuals the reserve-food is accumulated only in the seeds; in wheat and other cereals the endosperm of the seed becomes gradually filled with it, while in peas, beans and many annuals the reserve is stored in the cotyledons of the embryo.

Among biennials and perennials, the seeds are similarly stored with reserve-food; but such plants, before the end of one growing-season, accumulate and store a considerable quantity of organic material in their vegetative organs, which material serves for the nutrition and growth of the cambium, buds and roots during the earlier part of the succeeding season.

In turnips, carrots and mangel the reserve-material is stored in the roots: in onions and tulips it is accumulated in the leaves of the bulbs, in potatoes in the tubers, while in hops and many herbaceous perennials it is hoarded in the rhizomes or rootstocks.

Trees and shrubs store their reserve-material chiefly in the parenchyma of the cortex and medullary rays in the stems.

In the onion and many bulbs the carbohydrate reserve is stored chiefly in the form of dextrose, while many fruits store levulose also in their cell-sap.

In the sugar-cane, sugar-beet, turnip and other roots the reserve is cane-sugar dissolved in the cell-sap; in the tubers of the Jerusalem artichoke inulin takes the place of sugar. In the majority of plants the reserve-materials are chiefly stored in a solid insoluble form, in which state they take up less space than they would do in solution.

The commonest solid carbohydrate reserve-material is starch which occurs in the form of small grains previously described (p. 156). In some instances very minute particles of starch are temporarily formed within the cytoplasm but the larger starch-grains present in the special storage centres are produced by the leucoplasts of the cells from sugars which are transferred to them

from the leaves where 'carbon-fixation' is going on. Thus, the starch in the cereal grains, in the tubers of potatoes, and in the medullary rays and cortex of trees in winter, is formed from sugars primarily manufactured in the leaves.

Starch-grains formed by the leucoplasts are usually much larger than those temporarily formed and stored in the allied chloroplasts of the leaves.

In certain seeds some of the carbohydrate reserve is stored in the form of thickened cell-walls consisting of hemicellulose.

The fats and fixed oils occurring in the seeds of flax, cotton, and rape are non-nitrogenous reserve-materials, which are first visible in the form of minute drops in the protoplasm; the small drops run together ultimately and form larger drops. In some cases the fats and oils appear to be manufactured from dextrose and other sugars, while in others they arise by the conversion of starch.

Asparagine, leucine, glutamine, and other amido-compounds frequently form the chief store of nitrogenous materials present in the cell-sap of tubers, roots and rhizomes of plants. With increasing maturity of the root or tuber some of these compounds are converted into proteids. In most ripe seeds the nitrogenous reserve-material consists almost entirely of proteins stored in the form of solid aleuron-grains and other more or less amorphous masses: only a small proportion of amido-compounds are present.

It will be observed that the substances actually stored are usually different in chemical constitution and solubility from the organic materials transported into the cells where the storage is proceeding. One form of sugar is changed into another after entering into the cell or is utilised by the leucoplasts for the formation of starch-grains; the cell-sap, therefore, becomes less concentrated in the particular sugar entering it, and a further osmotic diffusion into the cell takes place.

By these changes a continuous accumulation of reserve-materials

becomes possible ; without them the cell-sap of the storage-tissues would soon become so concentrated that a further movement of material into the cell by osmosis could not occur. Moreover, the change of a soluble osmotic substance into an insoluble form prevents the turgidity of the cells from becoming excessive.

Ex. 133.—Cut transverse sections of last season's branches of ash and other trees in winter : place them for a moment in iodine solution (see Ex. 85) and then mount in water. Examine with a low power and note in what tissues the starch is most abundant.

5. **Nutrition of semi-parasites and semi-saprophytes.**—Certain green plants, in addition to their power of forming organic compounds from carbon dioxide, water, nitrates and other simple inorganic substances, appear to derive some organic materials ready formed either from other living plants or from humus.

To the former class belong Yellow-rattle (*Rhinanthus Cristagalli* L.), Eyebright (*Euphrasia officinalis* L.), Red-rattle (*Pedicularis sylvatica* L.), species of *Melampyrum*, and other *semi-parasites* not uncommon in meadows and pastures. Certain portions of the roots of these plants attach themselves by small haustoria to the roots of other plants growing near them and no doubt absorb a certain amount of organic substance from the latter, for unless they become attached in this manner to other plants they do not grow satisfactorily.

Many flowering plants, such as bird's-nest orchis (*Neottia*) and species of *Monotropa*, possess few or no chloroplasts, and live upon humus: numbers of plants, such as Heaths, Rhododendrons, Azaleas and Winter-green (*Pyrola*) belonging to the Ericaceæ, Beech, Hornbeam and other representatives of the Cupuliferæ, as well as pines and Coniferæ generally, while possessing chloroplasts appear to supplement their own manufactured supply of organic material by absorbing organic compounds from the decaying humus or leaf-mould in which many of their roots are found growing.

The roots of all these humus-loving saprophytes and green semi-saprophytes possess few or no absorptive root-hairs, but are associated with the mycelium of certain fungi present in the humus: the associated fungus and root is termed *mycorhiza*. In ericas, orchids and some other plants the mycorhiza is *endophytic*, the fungus living partially within the cortex of the root, while in beech and most Cupuliferæ the fungus clings to and covers the surface of the fine rootlets with a web-like mantle of mycelium from which separate hair-like hyphæ grow out into the humus and absorb portions of it: the latter type is spoken of as an *epiphytic* mycorhiza.

It is probable that some of the organic constituents of the humus are dissolved by the fungus, and, with the other absorbed constituents of the soil, are finally transmitted to the plant with which it lives in union. The fungus thus appears to act as a beneficial absorptive agent, and without its aid the plant does not thrive; beech and pine seedlings are found to grow feebly, and die off altogether after a time, in forest soil which has been subjected to boiling water or steam so as to kill the fungus.

As the plants of this class possessing green leaves have no absolute need of carbohydrates, it is possible that the fungus is concerned mainly with the absorption and transmission of ammoniacal and organic nitrogen compounds, as well as substances containing the ash-constituents of the plant.

CHAPTER XVIII.

ENZYMES AND THE DIGESTION OF RESERVE-MATERIALS.

1. THE substances stored in seeds, tubers, roots and other organs of plants are chiefly solid, insoluble materials, such as starch and aleuron-grains, which cannot be moved out of the closed cells in which they occur, or are compounds such as oils and fats which, although liquid, are unsuitable for rapid osmotic diffusion.

Before these reserve-materials can be removed from the tissues in which they are stored to the centres of growth where they are needed, they must be digested or transformed into soluble, easily diffusible substances, which can travel in the ordinary channels available for the translocation of foods. In certain cases the necessary transformation appears to be due to the direct action of the living protoplasm, but in many instances it is accomplished by the chemical activity of substances termed *enzymes* or *unorganised ferments*, which are secreted by the protoplasm.

A considerable number of distinct enzymes are known. They all appear to belong to the protein class of organic compounds, and a very small amount of each is able to transform an almost unlimited bulk of the material upon which it acts without changing or suffering much diminution in the process. Enzymes are inactive at low temperature, and most of them are totally destroyed when their solutions are heated to about 70° C. : the optimum temperature at which they carry on their work best lies between 30° and 50° C. Their chemical activity is usually greatest

in the dark ; exposure to bright light suspends and gradually destroys it.

2. The following are the most important kinds of enzymes occurring in plants :

(i) Those which transform the different insoluble carbohydrates into sugars.

(a) To this class belong *diastase* which attacks starch and by a gradual and continuous process of decomposition converts it ultimately into maltose and a small proportion of a gum-like substance termed *dextrin*. Other forms of dextrin arise during the intermediate stages of the process but are soon split up into maltose : some of them give a reddish-brown colour with iodine.

Two slightly different forms of diastase are met with in plants. The one known as *diastase of secretion* is concerned with the dissolution of starch in germinating seeds, and is especially prevalent in the germinating grains of barley and other cereals and grasses. This form of diastase which is the characteristic enzyme in malt, corrodes and eats pit-like depressions in the substance of starch-grains before finally dissolving them.

In the seeds of the Gramineæ this enzyme is secreted by the long cylindrical cells forming the surface-layer or *epithelium* of that side of the scutellum of the embryo which adjoins the endosperm. After its formation by the epithelium, the diastase diffuses into the endosperm and transforms the starch into maltose, which is ultimately absorbed by the scutellum and transferred to the growing-points of the developing embryo.

The other form of diastase is spoken of as *diastase of translocation*. It is more widely distributed than the diastase of secretion, being found in the leaves, shoots and other vegetative parts of plants. The amount present in leaves is greatest during the night or when the plant is kept in darkness. By its agency, the starch produced in the chloroplasts of green leaves during the daytime is transformed into sugar at night.

The same form of diastase is found in all parts of sprouting potato tubers, but is especially abundant near the 'eyes' where growth commences. It converts the starch of the tuber into sugar, which latter compound is subsequently transported to the growing shoots. Small amounts are also secreted by the 'aleurone-layer' in the endosperm of cereal grains when germination takes place. Translocation-diastase acts more readily at lower temperatures than the diastase of secretion and dissolves starch-grains without previously corroding them.

(b) During the germination of the cereal grains it is found that the cell-walls of the endosperm-tissue lying near the embryo and near the 'aleurone-layer' are disintegrated and dissolved by the activity of an enzyme, which commences its work before the diastatic enzyme begins to dissolve the starch in the grain.

This enzyme, named *cytase*, is secreted partially by the epithelium of the scutellum, but more especially by the cells of the 'aleurone-layer.' It is also present in the cotyledons of germinating peas and in the endosperm of buck-wheat. Its function in these cases appears to be that of getting rid of the cell-walls, so as to allow of an easier diffusion and therefore a more rapid action of diastase upon the starch-reserve.

Cytase is also found in the seeds of the date-palm, and is most probably present in germinating seeds of all those plants whose store of reserve-food for the embryo consists of thickened cell-walls composed of hemicellulose.

(ii) The reserve-material, inulin, which is present in the tubers of the Jerusalem artichoke, is transformed when germination begins into levulose by the action of an enzyme named *inulase*. The existence of the same enzyme has been demonstrated in the growing bulbs of snowdrop and other liliaceous plants which contain inulin.

(iii) A very common reserve-material of wide distribution in the vegetable kingdom is cane-sugar. Experiments suggest that as such it is of little or no value for the immediate

nutrition of protoplasm. It is however changed by the enzyme *invertase* or *invertin* into a mixture of dextrose and levulose, both of which sugars possess immediate nutritive value.

In roots, such as sugar-beet and carrot, a great part of the organic material manufactured in the leaves during the first year of growth is sent down to the root and stored in the form of cane-sugar. This reserve-material is utilised during the second year for the production of new stems, flowers and seeds, but before transmission from the root to the seats of renewed growth, the enzyme invertase decomposes the cane-sugar into dextrose and levulose according to the following equation :—

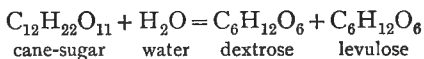

This form of decomposition of a compound which involves the fixation of the elements of water is termed *hydrolysis* or hydrolytic decomposition, and is characteristic of the action of the majority of enzymes of all kinds.

Invertase has been found in leaves, in the roots of young plants, in germinating pollen-grains, and in other portions of plants where cane-sugar is present.

(iv) Certain substances known as *glucosides* occur commonly in plant-tissues: their exact function and nutritive value to the plant are not yet understood. However, under the influence of acids and special enzymes, they are hydrolysed into useful sugars and other bodies, usually aldehydes or phenols.

The sugar produced is generally dextrose (glucose), hence the term glucoside applied to such compounds.

The best known examples are *amygdalin*, present in many rosaceous plants (see p. 388), *sinigrin*, abundant in mustard and other Cruciferæ (see p. 380), and *salicin* in the willow. Some of the astringent compounds so widely distributed in all parts of plants and known as *tannins* are also glucosides.

The decomposition of amygdalin is effected by the enzyme

emulsin, and gives rise to benzoic aldehyde, prussic acid and glucose according to the following equation:—

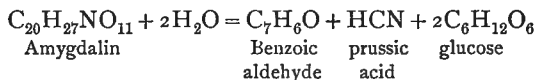

The glucoside sinigrin is decomposed by the enzyme *myrosin* as explained on page 370.

(v) A large amount of reserve-material in the seeds of flax, colza, castor-oil and other plants exists in the form of oil or fat. During the germination of such seeds the oil suffers hydrolysis through the activity of an enzyme which has been named *lipase*. The products of the decomposition in those cases which have been carefully examined appear to be free fatty acids and glycerin: the fate of the former substances is not clear, but it is probable that the glycerin is transformed into some kind of sugar which travels into the tissues of the growing embryo where some of it is not unfrequently converted into a temporary reserve of small starch-grains.

(vi) Another group of enzymes exists in plants by means of which the various insoluble and indiffusible proteins are hydrolysed into simpler diffusible proteins, termed *peptones*, together with a larger or smaller amount of *amides*. So far as they have been examined they all resemble the enzyme secreted by the pancreas of the higher animals, and are termed *vegetable trypsins*.

The chemical changes which proteins undergo in their migration from place to place within the tissues of plants are not the same in all cases, but the reserve proteins of many seeds are made available for the embryo through the action of tryptic ferments. When germination begins the insoluble and slowly diffusible proteins in the cotyledons and endosperm are decomposed into soluble peptones, and one or more amides, such as asparagine, leucine or tyrosine, all of which substances circulate readily to the various parts of the growing embryo needing nitrogenous nutriment.

Trypsins are also met with in the leaves, stems and developing fruits of many plants where they facilitate the rapid translocation of proteids in such organs.

3. The power which parasitic and saprophytic plants possess of absorbing and utilising as food the starch, proteins and various organic materials belonging to other plants, is dependent to a large extent upon their power of secreting diastatic and other enzymes.

Certain parasitic fungi penetrate into the tissues of their victims by secreting an enzyme which is capable of dissolving the obstructing cell-walls.

The production of alcohol from sugar by yeast is apparently effected by an enzyme named *zymase*, which is present in the yeast-cells, and some of the chemical changes brought about by bacteria are the result of the action of enzymes secreted by these organisms.

Ex. 134.—Germinate some barley grains on damp blotting-paper ; when the plumule just appears taste the endosperm and compare its sweetness with that of a soaked ungerminated grain.

Compare the taste of malt with that of ordinary barley grains.

Ex. 135.—Prepare some thin starch-paste and a solution of malt-diastase as described in Ex. 86.

Take two tubes of starch-paste and into one pour some of the diastase-solution, and into the other some of the same solution after it has been boiled three minutes and then cooled. Test with iodine for starch in both tubes every five minutes as indicated in Ex. 86. What has been the effect of boiling the diastase solution ?

CHAPTER XIX.

RESPIRATION.

Ordinary Respiration in the presence of free oxygen of the atmosphere: aerobic respiration.—One of the most familiar physiological processes carried on by living animals is that of *respiration*, during which there is a constant interchange of gases between the body of the animal and the surrounding air: the oxygen of the air is inspired into the lungs, and from the latter carbon dioxide gas is breathed out into the atmosphere. So long as life exists respiration goes on continuously, and one of the certain signs of death is the cessation of the process.

Respiration, however, is not confined to animals, but is carried on by all ordinary plants, and is as necessary for their existence as for the existence of animals.

The amount and rapidity of respiration is usually much greater in animals than in plants, but the process is essentially the same in both classes of organisms. It is well known that animals die when the supply of fresh air is cut off, and plants soon show signs of ill-health under similar conditions. In ordinary farm and garden practice the parts above ground always obtain sufficient oxygen for all their requirements, but the roots of plants are often seriously injured through want of a suitable supply of fresh air in the soil. The unhealthy appearance of over-watered pot plants and of crops growing in badly-drained ground is primarily due to an insufficient supply of oxygen to their roots. Seeds buried too deeply do not obtain sufficient fresh air for normal respiration and either do not germinate at all or do so in an unsatisfactory manner.

Each living cell of the body of a plant respire, the oxygen necessary for the process being supplied from the air which penetrates through the stomata and lenticels and permeates throughout the plant in the intercellular spaces.

In all the higher plants the products of respiration under normal conditions are carbon dioxide gas and water. As the carbon of the carbon dioxide is derived from the compounds within the body of the plant, it is clear that the process is a destructive one and must result in a decrease in the dry weight of the plant. The seedlings of cereals and many other plants when allowed to grow in the dark often lose about half their dry substance in two or three weeks.

In this respect respiration is essentially the opposite of the 'assimilation' process in which there is a fixation of carbon and a consequent increase in dry weight of the plant. Moreover, respiration goes on in all living cells, both in darkness and in light, whereas 'carbon-fixation' is only carried on by those cells which contain chloroplasts, and in these only when they are exposed to light.

During respiration oxygen is consumed and carbon dioxide is set free into the air, but in green plants exposed to daylight the 'carbon-fixation' process consumes twenty or thirty times as much carbon dioxide as is produced by respiration during the same time, so that when both processes are going on there is always a decrease in the carbon dioxide and an increase in the oxygen of the atmosphere, and only at night or in the dark does the process of respiration become apparent. However, in parts of plants which are not green, such as the roots, flowers and germinating seeds, respiration is readily detectable at all times.

The carbon compounds which disappear while respiration is going on, are carbohydrates, such as starch and the various sugars and fats. The oxidation of these substances does not take place at ordinary temperature outside the plant, and the

manner in which they are utilised within the tissues of plants during the respiration process is not understood. The oxidation is controlled and is dependent upon the protoplasm, for respiration ceases when life becomes extinct, and the amount and nature of the chemical changes carried on are not altered either by considerably reducing or increasing the amount of oxygen in the surrounding atmosphere.

The absorption of oxygen and the subsequent emission of carbon dioxide are the beginning and end respectively of a long series of chemical changes, the intermediate stages of which are at present unknown.

The disappearance of starch, sugars, fats and other carbon compounds during respiration is not due to simple direct oxidation; probably the protoplasm itself is directly attacked by the absorbed oxygen after which it uses up the carbon compounds to repair its waste.

The proportion of oxygen absorbed to the carbon dioxide gas given off is dependent on the energy of growth and on the materials consumed during respiration. In certain plants the

ratio $\frac{\text{volume of carbon dioxide produced}}{\text{volume of oxygen consumed}}$ has been found to be as low as .3, while in others it has been observed as high as 1.2.

In germinating seeds, tubers and bulbs containing starch and sugars, and in most flowering plants, the volume of oxygen taken from the air during active normal respiration, is equal to that of the carbon dioxide exhaled; but in the respiration carried on during the germination of seeds containing fats and oils, the volume of oxygen consumed is greater than that of the carbon dioxide exhaled, some of the oxygen absorbed by such seeds being apparently used up in oxidising the fats into some form of carbohydrate.

It is by means of the energy set free by the oxidation of various compounds in the respiration-process that the plant is enabled to maintain its vital activity, and the vital energy of

animals originates in a similar manner: when the physiological oxidation is prevented growth ceases, the streaming movement of the protoplasm within the cells is stopped, and the movements of the leaves, roots, stems and other organs of plants are suspended.

In all cases heat is produced during respiration, and in warm-blooded animals it is easily perceived. In plants, oxidation is generally much less energetic than in animals, and the heat produced is so slight that no difference in temperature can be detected between green plants and that of the air surrounding them. Moreover, in ordinary green plants exposed to the air, the cooling effect of transpiration masks any slight rise in temperature due to respiration. However, when actively germinating seeds or rapidly expanding flowers and buds are heaped together, a rise of two or three degrees above that of the atmosphere may be readily observed, by placing the bulb of a thermometer among them.

The amount of respiration is dependent on external and internal conditions, and in different parts of the same plant the activity of the process is not the same. In all young actively growing parts rich in protoplasm, such as germinating seeds, expanding buds and flowers, respiration is vigorously carried on, and the same is noticeable in injured cut portions of plants. In dormant bulbs, tubers and buds little or no respiration is observable. In dry seeds respiration seems to be entirely suspended, and many have been kept for twelve months in a vacuum, and in nitrogen and other gases under conditions which render respiration impossible, yet after such treatment the seeds germinated freely.

At freezing-point and a degree or two below it, where growth is stopped, respiration may frequently be detected. With increasing temperature there is a steady increase in the amount of respiration up to the point where death takes place, and the process stops suddenly.

Light appears to have no direct influence upon it, respiration continuing very similarly both in darkness and light.

It has also been found by experiment that the process goes on quite normally even when the proportion of oxygen in the surrounding atmosphere is reduced to less than half that ordinarily present in the air.

Ex. 136.—Soak a handful or two of peas or barley grains in water for twelve hours. Take them out of the water and allow them to germinate on damp blotting-paper for twelve hours. Then put them in a wide-necked bottle, cork the latter and place it in a warm, dark room. Cork and place beside it another similar but empty bottle. Allow both to remain for twelve hours, after which time test for the presence of carbon dioxide by introducing a lighted match or taper into the bottles: the light is extinguished by carbon dioxide. Arrange another similar experiment, and test for carbon dioxide with lime-water: pour in the lime-water, and shake the bottles; the lime-water becomes milky if carbon dioxide is present.

Ex. 137.—Partially fill a wide-necked bottle with half expanded young dandelion or daisy 'heads'; cork and leave for twelve hours, after which time test for carbon dioxide as above.

Ex. 138.—Repeat the experiment above, using green leafy shoots, expanding buds, bulbs, tubers and other portions of plants.

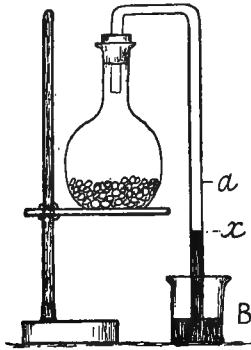

FIG. 89.

Ex. 139.—Soak some peas for twelve hours, and after taking them out of the water allow them to germinate on damp blotting-paper for a few hours. Then place them in a flask arranged on a retort stand, with a tightly fitting rubber stopper and bent glass tube as in Fig. 89. Slightly warm the flask with the hands and dip the open end of the tube (*a*) into mercury in a beaker (*B*). Leave the apparatus for ten or twenty minutes and fasten a piece of gummed paper on the tube (*a*) at a point (*x*) up to which the mercury rises in it. Keep the whole in a room of even temperature for ten or twelve hours, and observe the position of the mercury at the end of that time. If the volume of oxygen absorbed is equal to that of the carbon dioxide emitted, the mercury will remain at the same place in the tube.

Repeat the experiment with oily seeds, such as hemp, linseed and turnip.

With these the mercury rises in the tube, for the volume of oxygen absorbed by them is greater than that of the carbon dioxide emitted.

Ex. 140.—Show that heat is developed during respiration of germinating seeds.

Soak some barley grains or peas in water for a few hours and then allow them to begin germinating on damp blotting-paper. Place them in a large glass funnel (*B*), supported in a beaker or glass cylinder (*C*) containing a small quantity of a strong solution of potash (*D*) as in Fig. 90; dip into the seeds the bulb of a thermometer (*A*) reading to half a degree. Cover the whole loosely with a cardboard or wooden box (*E*), leaving a hole in the top for the thermometer tube.

For comparison, fit up a similar apparatus by the side of the first with balls of blotting-paper soaked in water in the funnel instead of seeds; compare the readings of the two thermometers on three succeeding days.

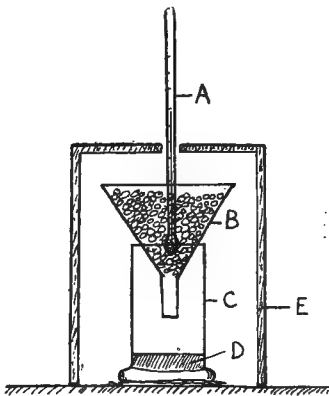

FIG. 90.

Anaerobic or Intramolecular respiration.—When living plants or parts of plants are placed in an atmosphere devoid of free oxygen, they continue to give off carbon dioxide gas for a longer or shorter time before death occurs. This production and evolution of carbon dioxide by living organisms in the absence of free oxygen is termed *anaerobic* or *intramolecular respiration*.

The length of time which plants will live under these circumstances depends upon the kind of plant and the vigour of its growth: actively-growing maize seedlings live and continue to give off carbon dioxide in the absence of oxygen, for twelve or fourteen hours at ordinary temperatures, while ripe fruits, such as pears and apples, live for several months under similar conditions.

In the majority of cases the amount of carbon dioxide thus produced is considerably smaller than that which is given off by the same plants when exposed to the air; for a short time,

however, bean seedlings and other plants emit the same or a greater volume of carbon dioxide when placed in an atmosphere free from oxygen, as they do when growing normally in the air.

During intramolecular respiration carbohydrates and fats disappear from the tissues of the plants just as in ordinary respiration in the presence of abundance of oxygen, but the production of carbon dioxide is accompanied by the formation of alcohol and other compounds. The alcohol produced during the intramolecular respiration of ripe cherries amounted in one of Brefeld's experiments, to more than two per cent., and in pea seedlings to over five per cent. of their fresh weight.

While the higher plants are unable to maintain their vitality in the absence of free oxygen for more than a short time, many of the lower forms of plant life, such as yeasts and bacteria, are independent of the presence of free oxygen and continue to live and multiply without it (p. 772).

CHAPTER XX.

GROWTH.

1. **Growth.**—We have seen in a previous chapter that at the apex of a stem or root of an ordinary green plant, there is usually a *formative region* where the component small cells are in a state of division, and new cells are being manufactured. Immediately behind this is a longer or shorter portion which may be designated the *growing region* of the stem or root. Here the cells are found to be turgid, and in consequence of the pressure within them have increased in size, and at the same time many of them have become changed in form.

These changes of size and form, owing to increased turgidity do not, however, necessarily constitute growth, although they are always associated with growth. Cells which are growing not only become distended by the osmotic pressure within the vacuoles, but also undergo a *permanent* change in size, form and structure, in consequence of the deposition of substances in their cell-walls and other parts; on withdrawing water from such cells the original state in which they existed when first produced in the formative region is not again reproduced by such a proceeding. Moreover, since the growth of a cell cannot go on without increased turgidity, and as this involves an addition of water to the vacuole of the cell, there is always an increase in the *total weight* of the cell when growth is proceeding: however, on account of the loss of substance by respiration, there may be a decrease in its *dry weight* if such loss is not compensated by anabolic nutritive processes.

What is true of a single growing cell is also true in the case

of the whole growing region of a shoot or root, for the latter is merely composed of a number of active cells.

Although it is not possible to define in a single sentence the exact meaning or connotation of the term *growth*, it may generally be taken to imply a permanent change in the form of a living organism or some of its members, and that the region which is growing is also increasing in weight.

The actual growing regions of the shoots developed in the dark from a potato tuber not only change their form but also, while they are growing, increase in weight at the expense of the water and reserve-food drawn from the tuber. It will be found, however, that the total weight of the tuber (which does not grow) and its growing shoots decreases in consequence of the loss of water by transpiration and by loss of carbon dioxide in the respiration process.

During the early stages of its life when a plant emerges from the seed, growth takes place in all parts of its body. After a time, however, growth is confined to certain special localised portions, or *growing points*, and to the cylindrical cambium-tissue which brings about secondary growth in thickness of dicotyledonous stems.

The growing-points in the case of stems and roots are generally *terminal*, or situated near the ends of these members : in such cases the youngest part is nearest, and the oldest part farthest away from the apex of the shoot or root.

In the stems of grasses their increase in length is due to the activity of growing-points which are situated at the base of the internodes ; moreover the growth in length of the long leaves of onions and rushes, and that of many peduncles of flowers goes on at the base of the structures, their tips being the oldest parts : growing-points of this character are described as *intercalary*.

When a cell or a plant member begins to grow its rate of growth is at first slow ; afterwards it grows more and more rapidly until a maximum rate is attained, after which the growth

diminishes gradually until it ceases altogether when the part is mature. The time occupied by this gradual rise and fall is termed the *grand period of growth*.

It is also noticed that the vigour or *energy of growth* of a stem or other member varies during the grand period: at one stage of the development of the complete stem the growing part either grows more rapidly or continues its growth longer than at another stage. For example, during the youngest stages of the development of most stems the energy of growth is low and short internodes are produced, later the energy increases, and larger internodes arise, afterwards the length of the internodes diminishes in consequence of a gradually decreasing energy of growth.

Ex. 141.—In autumn before the leaves have fallen, cut off branches from the common trees and shrubs, and measure the length between the several internodes on that part of each branch which has grown during the same season.

Note the general rise and fall in the length of the internodes.

Note also the relative size of the leaves at each node.

Make similar measurements on the stems of annual herbaceous plants.

Ex. 142.—Repeat experiments 15 and 20: similarly mark with Indian ink at intervals of $\frac{1}{8}$ inch the second and third leaves of a young onion plant soon after they appear; measure the intervals after the leaves have considerably lengthened, and compare the growth with that of a bean root. Is the region of greatest growth near the end of the leaf?

Ex. 143.—Select a stem of wheat or barley in which the ear is just appearing; cut about half-an-inch below the first and also below the second visible node from the top, so as to obtain about one internode of the stem.

Remove the leaf-blade and a small portion of the leaf-sheath and carefully measure the total length of the stem and the small part of it below the node. Make five or six marks with Indian ink $\frac{1}{4}$ of an inch apart at the upper part of the stem. Then place the lower end of the stem in water, cover the whole if possible with a glass globe and leave it in a warm room for twenty-four hours; or place the stem in a glass cylinder with a little water at the bottom for a similar period.

Measure again the total length; how much has the stem grown, and has the growth taken place near its upper marked end or near the base? Has the small portion below the node grown at all?

Ex. 144.—Measure the length of the internodes on a few shoots of any

vigorous common trees, shrubs or herbaceous plants in early summer when they are beginning to grow, and at intervals of two or three days for some time afterwards.

Determine the time during which an internode continues to grow in length.

2. **Conditions which influence growth.**—Only living plants grow and the cells of the growing parts must be in a youthful state. Various external conditions are also necessary for healthy growth, the chief of which are:—(i) a suitable temperature; (ii) an adequate supply of water; (iii) appropriate food or food-materials; (iv) the presence of oxygen. (v) Light although not absolutely essential to growth has a beneficial influence upon it.

(i) *Heat.*—It is well known that growth in winter, when the temperature of the surrounding air and soil is low, goes on very slowly or not at all. As the temperature rises in spring seeds readily germinate and the buds of plants commence to grow; with the increasing warmth of summer growth becomes more and more energetic.

By subjecting a plant to a gradually decreasing temperature, a point is at last reached at which growth entirely ceases; this is described as the *minimum* temperature for growth. It is not the same for all plants; the seeds of many common weeds, and mustard and cress germinate, and the fully developed plants continue to grow near freezing-point, while those of the cereals are stopped when the temperature falls to about 5° C. On the other hand the seeds and plants of maize and the scarlet-runner bean cease to grow at about 10° C., while the minimum temperature for the germination and growth of the cucumber, melon, and many tropical plants is as high as 19° or 20° C.

By raising the temperature from the minimum, a point is reached at which growth goes on most rapidly; this is termed the *optimum* temperature. By further increasing the temperature beyond the latter point, growth becomes slower and slower until a *maximum* is attained, at which growth is entirely checked.

Thus it is seen that plants may be too hot or too cold for growth, and between these extremes there is an optimum or best temperature where they make the most satisfactory progress.

The optimum temperature for most common farm and garden plants is about 28° C., while the maximum usually lies between 38° and 43° C. ; the optimum for maize, scarlet-runner, bean and cucumber is about 33° or 34° C., the maximum about 46° C.

It may be conveniently noticed here that although ordinary plants in an active state of growth have their development stopped at the temperatures indicated above, the death of the protoplasm does not usually take place until the higher temperature of about 56° C. is attained or until it has been cooled to freezing-point or several degrees below the latter.

The power of withstanding heat and cold depends very largely upon the amount of water which the plant contains.

Well-ripened shoots and buds containing little water do not suffer so much from the effects of frost during winter as sappy immature shoots which contain a larger proportion of water. Turgid seedlings, buds just opening and recently unfolded leaves, plants watered in the evening, succulent roots and all parts containing considerable amounts of water are often injured by exposure to sharp frost for a few nights.

Usually when a plant is subjected to a temperature of 2° to 5° C. the cytoplasm allows a certain amount of pure water in the vacuole to ooze out of the cell into the surrounding intercellular spaces where it freezes into small crystals of ice: death in such cases is somewhat analogous to death by drying. Although plants are sometimes killed in the process of freezing, this formation of ice is not always fatal, for in many cases, if the frozen part is thawed very slowly, the cells re-absorb the water and the tissues assume their normal state. If, however, the frozen part is thawed rapidly the water does not re-enter the cells and death takes place.

Frozen potted plants should not be exposed to the direct rays

of the sun ; syringing with ice-cold water is often a useful method of thawing them.

In long-continued frost the water frozen on the outside of the cells may gradually evaporate into the dry cold air ; under such circumstances the frozen parts shrivel and die of thirst.

Dormant seeds contain little water and are able to withstand the lowest temperature attainable without injury ; recently Dewar and Dyer found that the seeds of mustard, wheat, barley, pea and other plants germinated freely after being soaked for six hours in liquid hydrogen, the temperature of which was 453° F. below freezing-point.

In actively growing plants the protoplasm becomes disorganised and its vital powers destroyed at temperatures about 45° or 50° C.

Many dry seeds withstand a dry heat of 80° C. or higher for an hour or longer ; after soaking, however, they are killed by 10 to 30 minutes' exposure to a temperature of 51° or 52° C.

(ii) *Water*.—Water is necessary for the maintenance of the turgidity of the growing cells. It is itself a food-material and is also essential as a vehicle for the transport of foods and food-materials needed for the nutrition of the growing organs.

When plants from the beginning of their lives suffer from want of water their size is much diminished, although in other respects their development appears normal ; individually they become dwarfs.

On persistently dry soils and in dry seasons the bulk of the hay crop, the size of the 'roots' of turnips, the height of the straw of cereals, and the size of the various members of plants are proportionately decreased, while in damp seasons or upon soils which hold considerable amounts of water, the growth of plants is much increased. The growth and consequent size of plants in pots is similarly increased or decreased by judiciously varying the water-supply during the time that growth is proceeding.

Somewhat sudden diminution in the supply of water results in

the rapid cessation of growth followed by withering of the whole plant.

(iii) *Food* is essential for the construction of the protoplasm and cell-walls of the growing parts.

(iv) Oxygen is necessary for the process of respiration without which all vital functions cease.

(v) *Light*.—The various members of a plant's body grow more rapidly in feeble light than when they are strongly illuminated: that is, light retards growth.

When grown in darkness for a considerable time plants become peculiarly modified, in which condition they are said to be *etiolated*.

Among dicotyledons the internodes of the stems of etiolated specimens are abnormally elongated and much more slender than similar parts grown under ordinary conditions of day and night. Their cells are larger than usual and the cell-walls remain thin; the stems in consequence become weak and are unable to maintain a normal erect position. The whole plant contains more water proportionately to its size and the cell-sap is usually more acid than that of normally grown plants.

The leaves of etiolated dicotyledons do not develop but remain small and scale-like and as the chlorophyll does not develop in the plastids the whole plant appears pale in colour.

A few stems such as those of iris and onion, and the hypocotyls of many plants, such as the bean, which ordinarily grow in the dark, do not exhibit the peculiar phenomena of etiolation, nor are the leaves of iris and other similar rhizomatous and bulbous monocotyledons dwarfed when grown in darkness.

The development of the flowers of plants goes on in darkness much the same as in the light.

Ex. 145.—Sow two sets of peas, beans, mustard, and barley in pots, and allow them to germinate. When the young plants just appear on the surface of the soil, place one set of each in a light situation but not in the

direct rays of the sun, and the other set near them but covered with boxes which exclude all light.

(i) From time to time measure and compare the diameters of the stems and the lengths of the internodes of the plants growing in the light with those of the plants growing in the dark.

(ii) Measure and compare the length and breadth of the leaves of the two sets of plants.

(iii) Note the differences in the colour and firmness of the two sets of plants.

Ex. 146.—Make observations similar to the above on the shoots developed in light and in darkness respectively, from the tubers of the potato and artichoke, those springing from the roots of the dahlia, and the leaves of onions.

3. Spontaneous movements of growth: nutation and tissue-tension.—Growth rarely proceeds evenly in all parts of a shoot, root, or other organ of a plant; certain portions grow more rapidly or continue to grow for a longer period than adjoining parts. In consequence of this uneven growth the organs of plants (1) exhibit peculiar, slow, spontaneous movements, and (2) their tissues become subjected to pressures and tensions in various directions.

In stems and roots the growth of one side is more rapid than the other: the more rapidly growing side becomes slightly longer than the other, and the whole growing part forming the end of the stem or root becomes bent or curved in consequence.

The side on which most rapid growth occurs is not always the same but varies from hour to hour, so that the growing organ bends over in different directions and the tip travels slowly round and round, following a spiral line in its upward or downward growth. Movements of this kind are spontaneous and automatic: like the rise and fall in the rate of growth during the grand period they originate within the growing organ itself and occur whether the plant is kept in darkness or exposed to the light.

To such slow nodding movements the term *nutation* is applied.

In most stems and roots their tips travel round from right

to left or in a direction the opposite to that of the hands of a clock ; but the apex of the stem of a hop, honeysuckle and some other plants moves round from left to right when nutating.

By means of such movements roots are enabled to make easier progress through the soil, and climbing stems and tendrils which nutate very conspicuously are enabled by the same means to reach neighbouring supports around which they wind.

The ends of the subterranean shoots of many dicotyledonous plants are bent round by the excessive growth of one side in the manner indicated in Figs. 4, 144. By such arrangement the delicate tissues of the terminal buds are considerably protected against injury when the shoot is growing forward or upward through the soil. After such a bent shoot emerges from the soil, rapid growth takes place on its concave side and the curved portion soon becomes straight.

In a young state the leaves forming the buds of plants are curved round the delicate growing-point or curled up in a characteristic manner in consequence of the growth of one side of each leaf proceeding faster than that of the other side : when the buds open the side which previously grew more slowly grows at a greater pace and the curled leaf consequently unfolds and eventually becomes flat.

In most stems the pith and cortex continue to grow for a longer period than the woody tissue : the pith and cortex strive to elongate but the woody tissue hinders them to a certain extent. The result of such unequal growth is the production of longitudinal tensions in the growing parts. On splitting in two the stems of elder, sunflower and other rapidly growing plants longitudinally the pith elongates a little and the two separated halves curve outwards.

The bark of many trees does not grow so rapidly as the wood within, and consequently becomes more or less stretched.

It must be mentioned that movements of plant organs and

tensions in their tissues may be set up by inequalities in the turgidity of the various component cells as well as by irregular growth: both causes play a part in many instances of plant movements.

Ex. 147.—(i) On a warm day when there is no wind examine some young plants of scarlet-runner beans, hops and other twining plants which are growing round upright poles or string. Draw a line on the ground from the base of the pole, in the direction in which the tip of the stem is found at the time. Examine the plants at intervals of half an hour and similarly mark the direction in which the tip is curved over at these times; try and determine how long it takes the tip to make a complete revolution round the pole as a centre.

(ii) Make similar observations on the nutation of the tip of the stems of runner bean plants grown in large pots and allowed to wind round sticks stuck in the soil. The plants should be placed out of doors, not in direct sunlight.

Ex. 148.—Place some soaked broad beans with the micropyle downwards in damp sawdust, and allow them to germinate. When their roots are about an inch long take them up and select one with the straightest root. Pin it through the narrowest diameter of the cotyledons to a slender stick or thin piece of wood and place the latter through a hole in a sheet of cork or cardboard. Then place the cardboard with the bean attached over the neck of a wide-mouthed bottle containing a very little water, and arrange that the root is vertical within the bottle.

Stand the whole in a dark cupboard or cover it with a box to exclude the light.

Examine the root after 12, 24, 36 and 48 hours and see if it remains vertical or if it nutates in any way.

Does it nutate more in the plane of the cotyledons than at right angles to this plane?

Ex. 149.—Cut pieces two inches long from the full-grown stems of a sunflower and other plants. Carefully measure and then split them into longitudinal strips, so as to include in some the pith only and in others the cortical tissues only. Measure the separate strips and compare their lengths with each other and with the original length of the whole piece.

Note also the form of the separate pieces.

Ex. 150.—In July or August and at other times remove a complete ring of bark an inch long from three or four-year-old branches of sycamore, birch, beech and willow. Then try and place the bark in its original position on the shoot: does it fit exactly?

4. **Induced movements of growth.**—In addition to the vital movements previously discussed which arise in consequence of internal inherited causes operating within the plant organs themselves, other movements are observable in various organs of plants, which are induced by some external provocation or *stimulus*.

The protoplasm of living plants is irritable and sensitive like that of animals only in a somewhat different manner, and is capable of responding to the action of various external influences.

The chief exciting causes which induce movements in the different plant members are (i) contact with a foreign body ; (ii) alterations in temperature and the periodic alternation of day and night ; (iii) lateral or one-sided illumination ; (iv) the force of gravitation ; and (v) variations in moistness of the surrounding soil and atmosphere.

(i) **Movements induced by contact with a foreign body.**—The best examples of movements of this class are met with in tendrils and roots of plants.

The tendrils of peas, vetches, vines, passion-flowers and other plants are susceptible to slight contact.

If a tendril while nutating round and round touches a foreign body, such as the stem or twig of a neighbouring plant, it begins to curve towards the irritating structure. If the latter is not too thick and contact with it is prolonged the tendril becomes more turgid on the side not irritated and also grows more rapidly on the same side, so that the tendrils soon coil completely round the structure.

The particular part of the tendril which is sensitive varies in different plants : sometimes a considerable portion all round the tip is irritable, while in other cases the sensitive region is limited to a short part on one side only. The curvature of the tendril is not confined to the portion actually irritated, but the stimulus is usually transmitted backwards along the tendril, and coiling takes place in the parts which have not been touched.

Similar response to contact with a neighbouring foreign body is met with in the sensitive petioles of certain climbing species of *Tropaeolum* and *Solanum*, and in a lesser degree is observable in many twining and climbing stems.

Small portions near the tips of roots are sensitive to prolonged lateral contact: when such parts touch stones and other hard objects in boring their way through the soil, they curve away from the irritating bodies and the root tips continue their growth in a new direction.

On the other hand the older portions of growing roots when stimulated by contact curve towards and endeavour to grow round the irritating objects.

Both these and the nutating movements previously mentioned are such as enable roots to pass obstructing objects in their path.

Ex. 151.—(i) Observe the form of the free tendrils of the vetch, pea, vine and white bryony (*Bryonia dioica* L.). Compare with tendrils attached to their supports.

(ii) Arrange so that some of the free tendrils which are about three parts grown shall come in contact near their tips with small twigs or other similar support. Examine at intervals of a few hours and note the amount of twining of the tendril round its support.

(iii) Stimulate the concave side of the curved end of a tendril of white bryony, cucumber or melon for about a minute by rubbing with a moderately smooth piece of wood, and then watch its subsequent behaviour for two or three minutes. Does its curvature increase?

Ex. 152.—Examine the mode of climbing of *Solanum jasminoides*.

(ii) **Movements in response to variations in temperature, and the changes of day and night.**—Tulips, crocuses and other flowers open on a warm day or when brought into a warm room and close when placed in a cool situation. The opening and closing movements go on independently of light and are brought about by alterations in the growth and turgidity of the cells forming the upper and lower sides of the petals; the change of temperature stimulates the protoplasm in such a manner that varying amounts of water are allowed to pass through it into

and out of the vacuoles of the cells, and the turgid condition of the cells becomes altered in consequence.

The flowers of scarlet pimpernel and other plants close in the daytime if the weather is dull and the air damp. By closing during unfavourable weather the stamens and other reproductive parts are protected against possible injury from rain and other causes, and by opening on warm days the plant secures a better chance of cross-pollination, for only at such times are insect visitors abundant.

The leaflets of the compound leaves of the clovers, medicks and other Leguminosæ, as well as those of wood-sorrel and other plants, fold together or change their position in a characteristic manner at night and open out again next morning. Movements of this kind are termed *nyctitropic* or *sleep-movements*, and are effected by the plants, in response to the stimulus of varying temperature and altered illumination occurring during the changes from day to night. Frequently the edges of the leaves and leaflets are turned upwards at night, or the whole leaf droops or is folded in such a way that the leaf-area presented to the sky is much diminished, and loss of heat by radiation is consequently reduced. By taking up such positions at night the leaves are considerably protected from being injured by cold.

Ex. 153.—Examine the ‘day’ and ‘night positions’ of the leaves of clover, medicks and runner beans.

In the daytime cover up a white clover plant with a bowl or basin, and after two hours compare the induced ‘night position’ of the leaflets of the darkened plant with the day position of the leaflets on a neighbouring exposed plant.

Ex. 154—Compare the day and night positions of the flowers of wild carrot, *Geranium Robertianum*, and wild pansy.

Pluck two or three full-grown crocus and tulip flowers when closed in the morning of a dull day; place their stalks in water and convey them to a warm room. Notice how soon they open: after opening, stand them in a cool place and observe how soon they close.

Ex. 155.—On a bright day pluck some well-opened heads of daisies and dandelions: place the stalks in water and then transfer them to a dark

cupboard. Note that the heads close after being kept an hour or two in darkness. Remove them to a bright situation and observe if they open again.

(iii) **Movements induced by lateral illumination: heliotropism.**

—When a plant is allowed to grow undisturbed in the window of an ordinary room, one side of its stem is illuminated much more than the other ; in consequence of such lateral illumination the growing part slowly bends over towards the light so that the tip and a certain amount of the stem behind it ultimately points in the direction from which the light comes. Similar curvature is seen in stems of plants growing near walls, and in other situations where they receive light on one side more than the other.

This bending like other cases of the curvature of growing members is due to a difference in the rate and amount of growth on the two sides of the stems, and like the movements of leaves and roots mentioned below, is effected in response to the stimulus of light falling upon the stem from one side. A small portion near the tip of the stem is specially sensitive to lateral illumination, and the stimulus it receives appears to be conducted back to the part which bends in the peculiar manner described.

If the tip of the stem of a seedling which exhibits such movements is cut off or carefully covered by a cap of some material through which light cannot pass, the characteristic curvature does not occur.

The same stimulus of lateral light when applied to roots induces an opposite movement from that observable in the growing part of a stem. The growing part of a root curves away from the stimulating light, and the tip and a small portion near it, although they lie in the line of the incident light, point away from it.

The movements in response to the stimulus of lateral light in which the plant members turn towards the light, like stems, are spoken of as *heliotropism* or *positive heliotropism*, while the term *apheliotropism* or *negative heliotropism* is applied to move-

ments in which the organ stimulated curves away from the light, like roots.

The utility of these movements is clear: by such movements stems are enabled to reach the light and so place the leaves which they bear in the most favourable position for carrying on their function of 'carbon-fixation,' and roots are aided in finding their way and penetrating into the dark crevices of the soil.

The leaves of an onion and the flat sword-like leaves of certain monocotyledons appear to be heliotropic like stems, but the majority of the ordinary green leaves of plants behave differently from either roots or stems. They usually turn or twist on their petioles so as to place the upper surfaces of their blades at right angles to the direction in which the light falls upon them; plant members taking up such a position in reference to the incident light are described as *diaheliotropic*.

A few stems, such as those of the ivy, appear to be diaheliotropic. Instead of bending away from a wall they grow close up to it, and need no special training to keep them there. The ordinary heliotropic stems of fruit-trees, however, growing in a similar situation curve away from the wall, and if this is to be prevented the growing tips must be secured until they have become mature and firm.

Experiments have proved that only the blue and violet rays of light are effective in inducing heliotropic movements: no response is made to red and yellow rays.

Ex. 156.—Sow some mustard seeds in two small three-inch flower-pots, and when the plants are about an inch high place one pot of the seedlings in a box in total darkness, the other pot cover with a box blackened in the inside with lamp black, and having a hole bored in one side about on a level with the top of the seedlings.

Allow the seedlings to grow, and in a day or two compare the direction of growth of their stems in the two pots.

Ex. 157.—Germinate a few mustard seeds in damp sawdust, and when their primary roots are about an inch or an inch and a half long take one or two of the seedlings and push their roots through holes in a strip of

cardboard. Afterwards plug the holes gently with cotton wool so as to prevent the seedlings from slipping, and then place the cardboard over a beaker of well water so that the roots of the plant may dip vertically into the water.

Place the whole in the darkened box with a hole in the side as described above, and allow the seedlings to grow : examine in a day or two and note if the root and stem are vertical as arranged when first put into the box.

Ex. 158.—Examine fuchsias, geraniums and other plants growing in windows, and note the bending of the stems towards the light.

Note that the leaves have their upper surfaces towards the light.

Observe the leaves of ivy shoots and other plants growing close to a wall ; their upper surfaces are towards the light. Do the leaves grow out all on one side of such stems ? Have the petioles curved in any way ?

(iv) **Movements in response to the force of gravitation : geotropism.**—All bodies on the earth behave as if they were attracted towards the centre of the earth by a force which is spoken of as the force of gravitation. This force exerts a peculiar stimulating influence upon the various members of living plants. Most primary stems grow vertically upwards against the force and away from the earth ; when displaced into a horizontal position, the growing regions near the ends of the stems slowly bend upwards until they are again vertical. Primary roots, on the other hand, grow downwards with the force and towards the centre of the earth : when the primary roots of seedlings which have been allowed to grow straight down are placed horizontally, their growing parts soon curve through a right angle and take up a vertical position with the tips pointing downwards.

Roots are described as *geotropic* or *positively geotropic*, while stems which grow away from the earth are spoken of as *apogeotropic* or *negatively geotropic*.

The rhizomes of couch-grass, potatoes, and other plants are generally *diageotropic* ; they grow in a horizontal position and when placed vertically begin to slowly curve to one side until the growing regions and tips are parallel with the surface of the ground.

These movements go on in the dark, and are the result of stimulus of gravity acting upon the sensitive tips of the stems and roots and not directly upon the growing parts which become curved.

The lateral secondary branches of roots and stems appear to be less sensitive to the action of gravity than primary members; for example, secondary roots grow obliquely and not vertically downwards in the soil.

The peduncles of most flowers are generally apogeotropic but in some cases their geotropic irritability changes when the flower opens: many varieties of daffodil become diageotropic when the flower opens, the 'trumpet' of the corolla then taking up a more or less horizontal position.

The stems of wheat, barley and grasses generally curve upwards at the nodes when they are bent on one side by the wind and rain, and the upper internodes and ears may eventually attain an erect position after the crop has become 'laid,' if the latter does not happen too late in the season.

This apogeotropic movement of a cereal stem is due to the stimulus of gravity which induces a renewal of growth in the tissue forming the swollen leaf-bases close to the nodes.

Ex. 159.—Repeat Ex. 9, and note the geotropic behaviour of the roots and stems of the beans employed.

Ex. 160.—Sow a runner bean in a pot of garden soil and keep in a dark place. When the stem of the seedling is two or three inches long turn the pot on its side so that the young stem is horizontal and leave it to grow in the dark as before. After a few hours examine and note the curvature of the stem: which part has curved most?

Ex. 161.—Cut a straight piece of a young barley or wheat stem with a node about the middle of it, and place the lower cut end through a hole in a cork which fits into a small flat medicine bottle. Fill the bottle with water, insert the cork with the straw through it, and place the bottle on its side so that the straw is horizontal. Leave it in a dark cupboard all night and examine next morning. Is the straw still horizontal?

(v) **Movements induced by variations in moistness of the**

soil : **hydrotropism**.—The tips of roots are sensitive to changes in the moisture of the soil : while growing through the ground they bend towards the parts which are dampest. In consequence of this peculiarity, the roots of plants frequently find their way into drain pipes, wells and water courses some considerable distance away from the place where the stems are growing.

CHAPTER XXI.

REPRODUCTION.

1. THE physiological processes previously discussed have been concerned with the maintenance of the life of the individual plant. It is now necessary to consider the process of *reproduction*, or the power of giving rise to new and separate individuals, which is one of the most characteristic peculiarities possessed by all living organisms.

Among flowering plants two distinct modes of reproduction are met with, namely, (i) *vegetative reproduction* and (ii) *sexual reproduction*.

VEGETATIVE REPRODUCTION.

2. The essential feature of vegetative reproduction consists in the separation either naturally or artificially of portions of the vegetative organs of the parent, each detached part subsequently developing into a new and complete individual plant. A good instance of natural vegetative multiplication is seen in the potato. Thin underground rhizomes grow out from the parent plant and become thickened and form tubers at their tips; at the end of the summer the parent plant dies and leaves only the tubers, which in the following year develop into new separate plants. Almost all plants with underground branching rhizomes behave in a similar manner; the older main portions die off and leave the young lateral rooted branches to carry on their existence as separate individuals.

The buds on the stolons or runners of the strawberry and creeping crowfoot (Fig. 21) become rooted to the ground

and after the death of the bare internodes form separate plants.

Other examples of vegetative multiplication are seen in the growth of bulbous and corm-bearing plants (pp. 56-60).

3. In addition to the natural modes of reproduction just mentioned, various artificial modes of vegetative propagation are known. Detached pieces of the roots, stems or leaves of many plants when placed under certain conditions indicated below, give rise to those organs which are necessary to make the part a complete plant: thus the shoots of plants when cut off and placed in suitable soil soon develop a system of adventitious roots, and pieces of roots treated in a similar manner produce buds from which leafy shoots arise. It is a remarkable fact that although roots may be formed when either end of a cutting is inserted in the earth, the best development of roots always takes place when that end of the cutting which was nearest the root of the parent plant is buried in the soil. Also when a root-cutting is buried in the ground, the greatest growth of roots originates from that end of the cutting which was nearest the apex of the root, the other end giving rise to adventitious buds. The severed shoots of certain conifers and other plants do not appear to be able to form roots, nor are their roots capable of forming buds: plants such as these cannot be reproduced vegetatively.

The commonest examples of artificial vegetative reproduction are seen in the propagation of plants by means of *cuttings* and *layers* and in the processes of *budding* and *grafting* so extensively practised by nurserymen and gardeners.

4. **Cuttings.**—The term *cutting* is applied to any portion of a root, stem or leaf cut from a plant and used for propagation. A few plants, such as pelargoniums, have the power of forming adventitious buds upon cut portions of their roots, and may be propagated by root-cuttings. The leaves of gloxinias, begonias and other plants, when cut through the midribs and fastened down or merely laid on damp sand, and kept at a suitable

temperature, produce buds and roots which develop into new plants at points where the midribs are cut.

In the majority of cases, however, shoots are selected for cuttings: they generally give best results when cut through just below a node, for in most instances it is only at the latter points that adventitious roots are formed. Those of leafy herbaceous plants are placed in loose, warm soil to induce a rapid formation of roots and are kept in a somewhat close damp atmosphere to prevent too rapid loss of water by transpiration during the time that the shoots are without roots.

Woody cuttings contain a sufficient store of food for the formation of callus-tissue and roots: herbaceous cuttings, however, usually possess but very small amounts of ready-formed plastic materials and must therefore be exposed to light so as to carry on the work of 'carbon-fixation.'

Currants, gooseberries and vines are very readily increased by cuttings: pears and apples may also be reproduced in a similar manner, but the production of roots by the shoots of these trees is very uncertain.

The cuttings of fruit trees are usually 8 or 10 inches long and taken from well-matured wood of the previous season's growth, after the shoots have lost their leaves in autumn. The buds on the portion of the shoot inserted in the soil should be cut out where 'suckers' are to be avoided, and only the buds needed for the formation of the bush or tree left on the part above ground (Fig. 91).

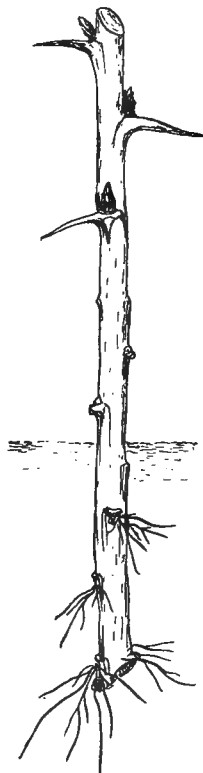

FIG. 91.—Cutting of gooseberry showing formation of adventitious roots below ground.

In the apple and pear, roots form more readily when the cuttings include a 'heel' or small basal piece of wood from the older branch on which the cutting originally grew.

Hops are propagated by cuttings (p. 343), and the tubers of a potato when very large or the variety a scarce one are sometimes cut longitudinally so that each piece possesses an 'eye' or collection of buds which develops into a new plant when the piece is placed in the ground.

5. **Layers.**—The process of *layering* consists in bending and pegging down a shoot of a plant into the soil as indicated in

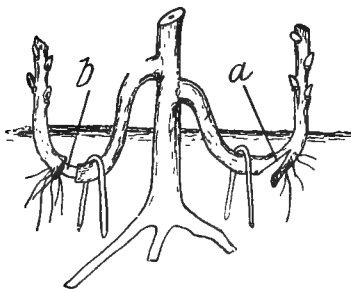

FIG. 92.—Diagram illustrating method of layering. *b* Ringed branch; *a* tongued branch.

Fig. 92. From the bent portion in the earth roots are sooner or later emitted, after which the shoots spoken of as *layers* may be severed completely from the parent plant.

The mere bending and covering the shoot with moist warm soil is sometimes sufficient to induce the emission of roots, but more generally one or other of the various plans of 'tongue-

ing,' 'ringing,' and 'notching,' must be adopted to secure a good formation of root.

'Tongueing' is a term applied to the process of cutting an oblique slit upwards as at *a* almost through the stem at a node. 'Ringing' (*b*) consists in removing a complete half-inch wide ring of bark or tissues as far as the cambium of the stem: by 'notching' is meant the cutting of a V-shaped incision half through the stem. All these devices and others which are practised retard the flow of elaborated sap backward from the free portion of the shoot above ground, and the consequent accumulation of plastic material in the part of the shoot beyond the cut tends to induce the formation of adventitious roots upon it.

Layering is usually more successful than propagation by cuttings, for the latter are liable to die before a root-system is developed adequate to their requirements: in the process of layering the shoot remains attached to the parent until it is rooted, during which time it derives its water-supply and a certain amount of food from the latter.

Currants and grapes are readily increased by layers, and the process is adopted for the rapid production of apple, pear, plum, quince and other stocks which are subsequently employed for budding and grafting purposes. The layering of these usually takes place in autumn, the layers being left attached to the parent about twelve months or until a satisfactory root-system is developed, after which time they may be completely severed from the parent and planted out.

6. **Budding and Grafting.**—In the process of *budding*, a bud is taken from one plant and inserted into the stem, or *stock* as it is termed, of another; in *grafting* a portion of a shoot with several buds upon it is treated in a similar manner. The shoot, which in the grafting process is inserted into the stock, is termed a *graft* or *scion*.

The inserted bud and stock or the scion and stock when properly treated become organically united with each other and behave as one plant. The roots of the stock supply the bud or scion attached to it, with water and other ingredients from the soil, and the leaves of the shoots developed from the bud or scion elaborate plastic material for the nutrition and growth of the root. Nevertheless, in nearly all cases the scion and stock preserve their own individual morphological peculiarities, and in this respect behave as distinct, separate plants.

It is stated that in some instances budded or grafted plants give rise to shoots which in form of leaf, colour of their flowers, and other morphological characters, resemble those of the scion and those of the stock as well. Shoots produced in this manner with such blended characters are described as *graft-hybrids*; they are of very rare occurrence.

Budding and grafting are processes mostly applied in practice to woody dicotyledons; herbaceous plants may, however, be made to unite satisfactorily. Attempts to graft monocotyledons with each other rarely succeed.

One species of plant can often be successfully grafted on a totally distinct species, as, for example, the peach on the plum, the apple on the pear, the pear on the quince, and the tomato on the potato. Moreover, certain species belonging to different genera unite and grow satisfactorily, as the medlar on the hawthorn, and the Spanish chestnut on the oak. Apparently, however, only plants can be grafted on each other successfully when they belong to the same Family or Order.

Although a variety of pear, whether grafted on the quince, apple, wild pear or other stock, remains a pear and possesses all the special characters for which it is grown, the scion is nevertheless influenced in the size and flavour of its fruit, in the earliness or lateness of its fruit-bearing power, its habit of growth, and in other ways, by the stock on which it is grafted. Similar influence of the stock on the scion and its produce, is observable in most other fruit trees, and appears to be connected with the mechanical difficulty of transport of the food material through the wood at the point of union of stock and scion.

Fruit trees on their own roots are less fruitful and the fruit is of poorer quality than that obtained from the same variety of tree grafted on another appropriate stock.

For the production of dwarf trees which fruit at an early age the pear is usually grafted on the quince and similarly the apple is grafted on the so-called 'Paradise' stock, a name given to certain surface-rooting dwarf varieties of apple.

Where larger trees are required which do not fruit so soon but which are of greater longevity than dwarfs, the pear is grafted on stocks raised either from seeds of the wild pear or from common varieties of pear used in the manufacture of perry, and the apple is grafted on stocks raised from seeds of the crab or wild apple,

or upon the so-called Free stocks raised from seeds of cider apples.

Heart and Bigarreau varieties of cherry are budded and grafted on seedlings of the Wild Gean (*Prunus Avium* L.), the Morello and Duke types being inserted on stocks of Dwarf cherry (*Prunus Cerasus* L.).

Mussel and St Julien plums are frequently used as stocks for plums. A great many different ways of preparing and inserting the buds and scions are practised.

In the propagation of fruit trees and roses by budding, the commonest method is that known as *shield-budding*, which is usually performed in July or August when the bark of the stock can be readily separated from the wood along the active cambium-ring. The buds selected for insertion must, of course, be wood buds, and are taken from shoots produced

in the same year. They must not be too young nor too old, and are therefore cut from the middle portion of the shoot where the wood is about half-ripe.

The bud to be used is cut from the young shoot in the manner indicated at *a b*, Fig. 93 : a shield-shaped piece of the bark is removed with the bud, and also a small portion of the wood of the shoot, which must be carefully pulled

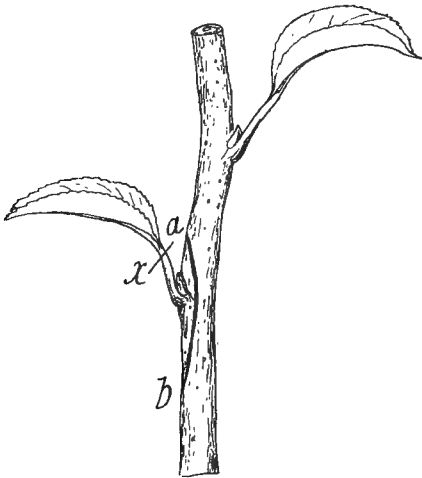

FIG. 93.

from the bark and thrown away. If in withdrawing this small piece of wood the rudimentary vascular cylinder or axis of the

bud comes with it, the bud appears hollow when viewed from inside and is useless, for it cannot develop. The leaf in whose axil the bud is growing is severed as at *x* so as to leave about a quarter of an inch of petiole attached to the bark. This done a T-shaped incision (A, Fig. 94) is cut in the stock and the bark gently raised as at B: the prepared bud is then inserted in the slit as at D and the whole firmly tied round with raffia-grass or cotton-wick so as to press the wounded parts together, leaving the bud itself exposed (E, Fig. 94).

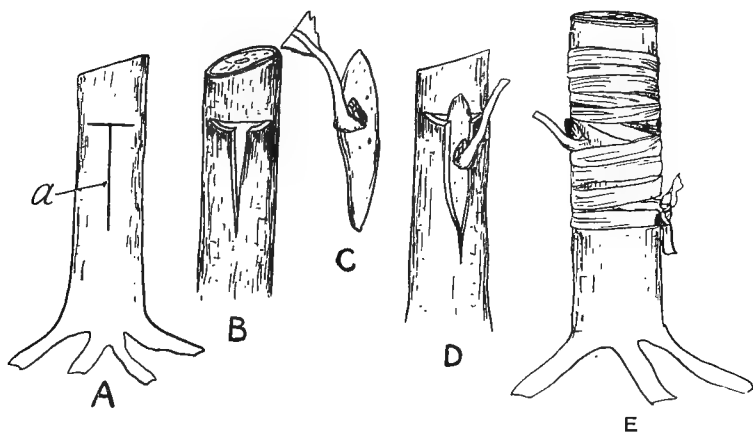

FIG. 94.—Diagram illustrating a common method of 'Budding.'

The bandage should be removed or released in about three weeks or a month after budding, and after the upper part of the stock has been cut off in autumn no growth except that from the inserted bud should be allowed.

In budding operations carried out as above, the healing-tissue or callus formed by the cambium of the transplanted bud becomes united with that formed by the cambium of the stock upon which the bud is placed, and as the cambial surfaces brought

together are comparatively large, a good union is very readily made.

In the process of grafting a short piece of a shoot with from two to four buds upon it is united with the stock.

In the grafting of fruit trees the grafts or scions are cut in January or February before vegetative growth commences, from well-ripened shoots of the preceding year's growth. They are then placed in moist sand or garden soil on the north side of a wall, or kept in a cool cellar in order to prevent them from drying up and to keep them dormant until they are needed in March or April when the actual operation of grafting is generally carried out.

The upper part or 'head' of the tree or stock is cut off completely at a point a little way above where the scion is to be grafted. This preparation of the stock must be done before growth begins in spring, the best time being usually in the early part of February.

Very numerous methods of uniting the scion to the stock are practised by gardeners and nurserymen.

In all cases it is important to remember that the callus or healing-tissue which brings about the union, arises chiefly from the cambium of the scion and stock and the cells immediately bordering on the cambium: the old matured portion of the wood takes no part in the process.

The commonest modes in use are *tongue-* or *whip-grafting* and *ring-* or *crown-grafting*, the former being largely adopted where the scion and stock are approximately the same in thick-

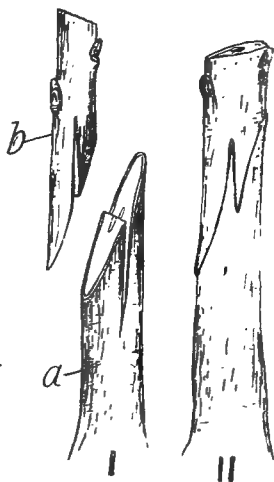

FIG. 95.—Diagram illustrating mode of tongue-grafting. I. Stock *a* and scion *b* separate. II. The same fitted together before being bound and waxed.

ness, the latter where the scions are grafted upon much thicker branches and stems.

In tongue-grafting the scion is first cut with a long sloping cut 2 or 3 inches long, and then notched as at *b*, Fig. 95. The stock is treated in a similar manner so that when placed together the scion and stock fit as at II, Fig. 95. The two parts are subsequently bandaged firmly, and the wound covered either with grafting-wax or clay to exclude air and rain.

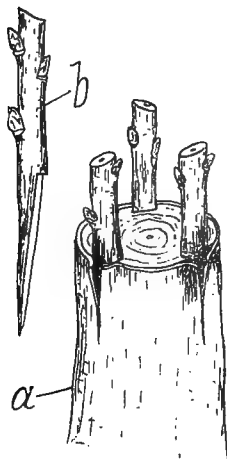

FIG. 96.—Diagram illustrating mode of crown-grafting. *b* Prepared scion; *a* stock with three scions inserted.

As soon as the buds on the scion have grown into shoots 6 or 8 inches long the bandages and covering should be carefully removed, and the scion and stock tied to a supporting stake.

In crown-grafting one or more scions are cut with long sloping cuts and then inserted into longitudinal slits 2 inches long, cut through the bark of the stock as shown in Fig. 96. The wounded parts are then bound and covered with clay or wax as in tongue-grafting.

The growths from bulbs, tubers, cuttings, grafted buds and scions are, strictly speaking, not new plants, but simple extensions of the body of the parent which produced them: with rare exceptions, they possess the same morphological and physiological characters as the plant from which they were derived. Whatever qualities the parent possesses which make it valuable, the same are met with in the plants derived from it by the various methods just described, and it is largely on account of this fact that the farmer, gardener, and nurseryman makes use of the power of vegetative reproduction.

Plants raised from *the seeds* of choice varieties of apple, pear, cherry and other fruit trees usually differ very widely from their

parents, and the same want of resemblance between parent and offspring is seen when seedlings of carnations, chrysanthemums, dahlias, potatoes, hops, and a vast number of other cultivated plants are compared with their progenitors.

The reproduction of plants by seeds cannot, therefore, in such cases, be relied on as a means of obtaining a number of examples all resembling their parent: the only method of obtaining the desired result is to take advantage of the power of vegetative reproduction.

Another reason for the employment of the power of vegetative reproduction is the great saving of time which is effected when the rapid multiplication of certain kinds of plants is the object in view. To raise a remunerative crop of potatoes from true seeds would take five or six years, and an even greater time would be needed to produce an orchard of fruitful trees from the 'pips' of pears or apples: by the use of tubers in the former, and by grafting on well-established stocks in the latter cases, the end is attained in a comparatively short time.

The same saving of time is seen in the raising of strawberries from separated runners instead of seeds, and in the propagation of tulips, hyacinths, and narcissi by means of bulbs rather than by seeds.

Ex. 162.—Examine cuttings and layers of carnations, pelargoniums, goose-berry, black-currant and any others obtainable after they have rooted. Make drawings of the rooted ends.

Ex. 163.—All students should be required to bud a rose and graft a fruit tree of some kind.

Examine the external feature of budded and grafted trees in orchards and gardens. Notice if the stock and scion grow in thickness at the same rate.

CHAPTER XXII.

REPRODUCTION—(*continued*).

SEXUAL REPRODUCTION.

1. THE essential feature of the sexual reproduction of plants and animals also, is the fusion of two special kinds of cells, namely, a male reproductive cell, and a female reproductive cell, which after complete coalescence or commingling of parts, give rise to a single cell capable of growing into a new organism.

In the very exceptional cases of *parthenogenesis*, a female cell develops into a new plant without previously uniting with a male cell; as a rule, however, neither a male cell nor a female cell is capable of further development by itself, and it is only after the process of *fertilisation* or union of the male cell with the female cell that the latter grows into a new individual plant.

The two uniting cells, or *gametes* as they are termed, are produced in special reproductive organs which vary very much in different divisions of the Vegetable Kingdom. We can, at present, only deal with the sexual cells and reproductive organs of ordinary flowering plants.

The reproductive organs of these plants form the essential parts of flowers as mentioned in chap. vi.; the stamens are the male organs and the carpels the female organs of the plant.

The male reproductive cell is enclosed within the pollen-grains produced in the stamens: the female reproductive cell lies within the ovule as explained below.

2. **Structure and Germination of the Pollen-Grain.**—Pollen-grains vary much in form, size and colour: they are, however,

generally oval or spherical bodies of a yellowish colour. The exterior of the grain usually consists of a stout cuticularised cellulose coat—the *exine*—often elaborately ornamented with spiny, wart-like, or net-like thickened markings; here and there more or less definitely arranged, thinner areas are visible on the coat. Lining this outer protective covering is a delicate transparent cellulose membrane—the *intine* (Fig. 97). The interior of the grain is filled with cytoplasm, in which are present two nuclei, representing two cells, between which there is no dividing cell-wall. One of them (*g*) is the *generative cell* or *male reproductive cell*, the other (*v*) being termed the *vegetative cell* of the pollen-grain. Within the cytoplasm, starch, sugar, oil and other food materials can often be recognised.

When a pollen-grain is placed in a weak solution of sugar, and kept at a suitable temperature, it absorbs water, and emits a closed slender tube-like structure, termed the *pollen-tube* (*pt*), which grows from the vegetative cell of the grain, and may under certain conditions attain a length of several millimetres. The pollen-tube is a protrusion of the intine, and makes its way through the specially thin or otherwise modified places in the exine of the grain.

During the germination of the pollen-grain the two nuclei present in it travel into the pollen-tube; the nucleus of the vegetative cell ultimately becomes disorganised and disappears,

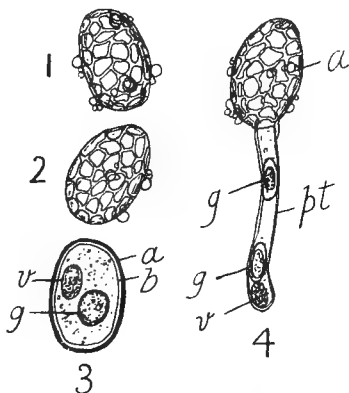

FIG. 97.—1 and 2 Pollen-grains of a species of lily, with netted exine, on which small drops of oil are visible. 3. Section of a pollen-grain: *a* exine; *b* intine; *v* nucleus of the vegetative cell; *g* nucleus of the generative cell. 4. Germinating pollen-grain; *pt* pollen-tube; *v* nucleus of the vegetative cell; *gg* two nuclei produced by division of the nucleus of the generative cell.

but the nucleus of the male or generative cell divides into two portions (*g g*, 4, Fig. 97), which take part in the fertilisation-process described hereafter.

Ex. 164.—Shake out, or otherwise transfer to a dry slide, pollen-grains from the anthers of shepherd's-purse, sunflower, cucumber, dandelion, apple, mallow, sweet-william, tulip, and any other flowers at hand.

(1) Examine with a low power, allowing the light to fall on them from above. Note the colour, and sketch the form and arrangement of the markings on the outer wall.

(2) Mount a few of each of the pollen-grains in water or alcohol, and examine with both a low and a high power.

Ex. 165.—Make a 3 per cent., 5 per cent., and a 10 per cent. solution of cane-sugar; place some of each in separate watch glasses, and shake into them various kinds of pollen-grains. Cover each watch glass with another, and keep the whole in the dark in a warm room. Examine with a high power some of the pollen-grains from each glass after twelve or eighteen hours, and note the production of pollen-tubes from many of them.

3. **The ovule and its structure.**—As previously explained in chapter vi. (p. 85), the ovules are minute roundish or egg-shaped bodies found in the ovary of the carpels of a flower. In most cases each ovule is attached to the placenta of the carpel by means of a short stalk or *funicle*.

The chief part of an ovule consists of a central kernel of thin-walled parenchymatous tissue termed the *nucellus* (*n*, Fig. 98). Surrounding the latter are one or two coats or *integuments* (*c*) which have grown up from the base of the nucellus so as to cover it completely except at its apex where a very narrow canal (*m*)—the *micropyle*—is left.

The ovules of umbelliferous plants and most dicotyledons with gamopetalous flowers have only a single integument; those of the monocotyledons and most apetalous and polypetalous dicotyledons possess two integuments.

The point (*h*) where the coats and the tissue of the nucellus are united is termed the *chalaza* of the ovule.

Various forms of ovule are met with in different kinds of flowering plants. In the dock, walnut and buckwheat, the funicle,

chalaza and micropyle are all in the same straight line, as at 1, Fig. 98: such ovules are described as *orthotropous*.

When the ovule during its development becomes inverted as at 2, Fig. 98, the micropyle lies close to the funicle: this form is met with in the majority of common flowering plants, and is spoken of as an *anatropous* ovule. Among cruciferous plants, and also among the Caryophyllaceæ and Chenopodiaceæ, the ovules are more or less kidney-shaped, the nucellus and integuments being curved or bent: ovules of this type are described as *campylotropous*.

At an early period in the development of the ovule a specially large cell termed the *embryo-sac* makes its appearance in the tissue of the nucellus at a point near the micropyle of the ovule. Within it a series of seven new cells are developed somewhat as follows. The primary nucleus of the embryo-sac first divides, and the two halves then travel to opposite ends of the cell. Here each of these two new nuclei divides into four, so that at this stage eight nuclei are present, each of which has a certain portion of cytoplasm associated with it. After this, one of the nuclei from the chalazal end and one from the micropylar end travel back to

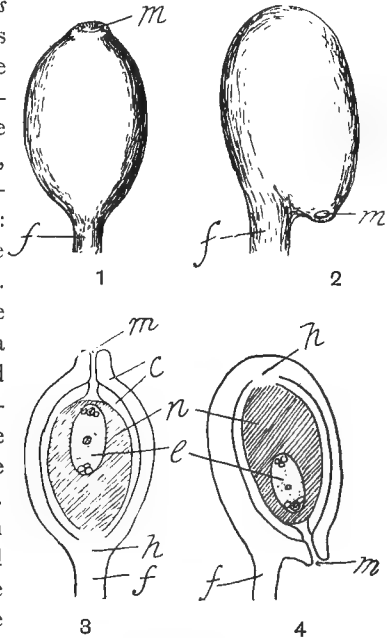

FIG. 98—1. External view of an orthotropous ovule. 2. The same of an anatropous ovule. 3. Longitudinal section of 1. 4. Longitudinal section of 2. *f* Funicle; *m* micropyle; *h* chalaza; *c* coats of ovule; *n* nucellus; *e* embryo-sac.

the centre, and fuse with each other to form what is termed the *secondary* or *definitive* nucleus of the embryo-sac (*h*, Fig. 99).

The three nuclei at the end of the embryo-sac farthest away from the micropyle become surrounded with a certain amount of cytoplasm and then develop cell-walls; the cells produced are termed *antipodal* cells (*a*). At the end nearest the micropyle the nuclei and associated cytoplasm remain without cell-walls and constitute what is known as the *egg-apparatus*; two of these three cells are termed *synergidæ*, the third being known as the *ovum*, *egg-cell* or *oosphere* (*e*). The ovum is the special female reproductive cell of the plant which after fusion with the male reproductive cell of the pollen-grain, begins a new life as it were, and develops into a new plant.

Ex. 166.—Tease out with needles the ovules from the ovaries of the recently opened flowers of pea, bean, tulip, and others of similar size; mount in a drop of water and examine with a low power, noting if possible the funicle and position of the micropyle.

Ex. 167.—Cut transverse sections of these ovaries and mount the sections in a 1 per cent. solution of caustic potash. Observe and sketch under a low power the form, structure and attachment of the ovules to the carpels.

Ex. 168.—Place some flowers of marsh marigold (*Callitha palustris* L.) which have just opened in methylated spirit. After hardening a few days strip off the petals and stamens and cut a number of transverse sections through the carpels with a razor wetted with the spirit; many of the sections will also pass through the ovules within the carpels. Transfer the sections into a watch glass containing a mixture of equal parts of methylated spirit and glycerine. Now pick out one or two sections which appear to have passed through the ovules and mount them in a drop of pure glycerine.

1. Examine and sketch under a low power, noting—

- (1) The section of the wall of the carpel;
- (2) The anatropous ovule and its funicle;
- (3) The large embryo-sac.

2. Examine and sketch the embryo-sac under a high power, noting within it—

- (1) The central definitive nucleus;
- (2) The antipodal cells at one end; and
- (3) The ovum and synergidæ at the other.

4. **Fertilisation and its effects.**—When a pollen-grain is placed

on the stigma of the carpel of a suitable flower it germinates and produces a pollen-tube which penetrates into the tissues of the stigma and grows down through the style into the cavity of the ovary; the time taken to reach this point may vary from a few hours to several weeks, according to the kind of plant.

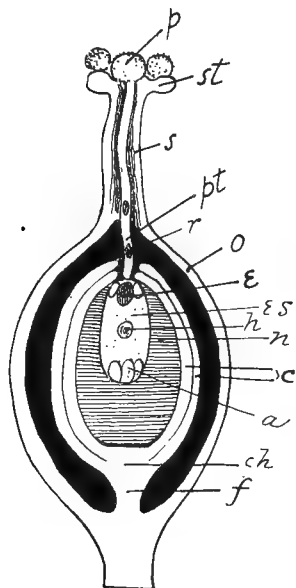

FIG. 99.—Diagram of a longitudinal section of a carpel containing an orthotropous ovule: designed to illustrate the arrangement of the various parts at the time of fertilisation. *o* Ovary; *s* style; *st* stigma of the carpel; *p* pollen-grain germinated on the stigma; *pt* pollen-tube; *r* the generative nucleus; *f* funicle; *ch* chalaza; *c* integuments of ovule; *n* nucellus; *ε* embryo-sac; *e* ovum or egg-cell; *h* definitive nucleus; *a* antipodal cells.

The advancing pollen-tube is guided in some way not completely understood into the micropyle of the ovule and at length comes into contact with the apex of the embryo-sac close to the egg-apparatus (Fig. 99). On reaching this point its tip becomes disorganised and one of the generative cells of the pollen-grain travels on through the open end of the tube until it meets the ovum or oosphere. The generative cell and the ovum then fuse into one, their parts becoming completely intermingled. This fusion of a generative cell with the ovum is the essential feature of the sexual act and is spoken of as *fertilisation*.

In several instances the second generative nucleus from the pollen-grain has recently been found to fuse similarly with the definitive nucleus in the embryo-sac, and this 'double fertilisation process' is probably general among flowering plants.

Unless the ovum is fertilised both it and the whole ovule wither and die, but as soon as fertilisation is effected the ovum commences to divide and grow, developing into an embryo plant, the whole ovule finally becoming a seed.

The development of the embryo of a dicotyledonous plant from the fertilised ovum may be easily studied in the common weed Shepherd's-purse (*Capsella Bursa-pastoris* L.).

The ovum first surrounds itself with a cell-wall and subsequently divides into two cells: of these, the upper one or that nearest the micropyle, by further transverse divisions gives rise to a single row of cells termed the *suspensor* (*s*, Fig. 100). The other

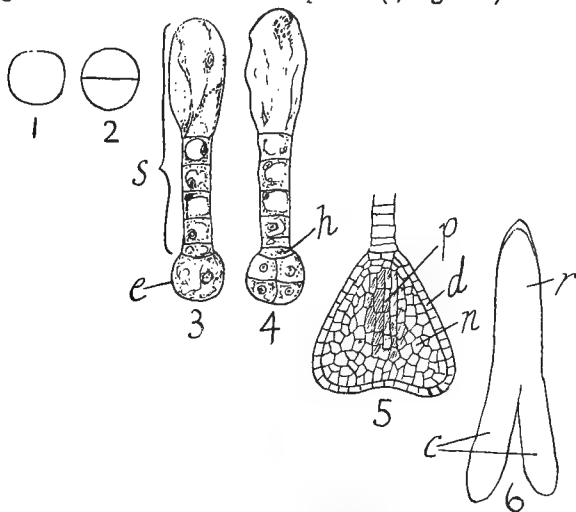

FIG. 100.—1. Diagram of ovum. 2. The same after first division. 3 and 4. Suspensor (*s*) and embryo-cell (*e*) of Shepherd's-purse; in 4 the embryo-cell (*e*) has undergone division; *h*, hypophysis. 5. Later stage of the development of the embryo, showing portion of the suspensor still attached to it; *d* dermatogen; *n* periblem; *p* plumule of embryo. 6. Fully-formed embryo; *r* its radicle; *c* two cotyledons.

or lower spherical cell (*e*) is carried at the end of the suspensor some distance into the cavity of the embryo-sac; it is spoken of as the *embryo-cell* since from it the whole of the embryo is developed except the tip of the radicle and the root-cap.

The single embryo-cell divides in three directions so that eight cells are formed: four of these nearest the suspensor by continued division produce the hypocotyl and radicle, while the other four give rise to the cotyledon and plumule of the embryo. The

tip of the radicle and the root-cap originate by division of the *hypophysis*, or end cell (*h*) of the suspensor.

Ex. 169.—Pull off from an inflorescence of Shepherd's-purse (*Capsella*) an ovary of a flower from which the petals have just fallen. Open the ovary with needles and remove a few of the ovules: place one or two of the latter in a drop of water on a glass slide and cover with a cover-slip.

(1) Examine with a low power and sketch the parts of a single ovule and its funicle.

(2) Press gently on the cover-slip with the end of a lead pencil, so as to burst the ovule: try and find with a low power the embryo and suspensor, as at 3 or 4, Fig. 100, among the contents squeezed out. When found examine and sketch under a high power.

(3) Repeat the above with ovules obtained from successively older ovaries, and trace the development of the embryo up to the time when well-marked cotyledons and radicle are clearly visible with a low power.

At the same time as the development of the embryo is going on, changes occur in the embryo-sac and in the nucleus of the ovule. The synergidæ and the antipodal cells usually become disorganised and disappear. The secondary nucleus of the embryo-sac, however, fuses with one of the generative cells from the pollen-grain and the compound nucleus arising from such union divides repeatedly until a large number of naked cells are produced, between which cell-walls ultimately arise, the whole then forming a parenchymatous tissue within the embryo-sac: this tissue is termed the *endosperm* (*e*, Fig. 101) and is stored with food on which the embryo lives during its development.

In wheat, barley, onion and other species of plants the embryo does not disorganise and consume all the endosperm before the seed ripens, so that in these cases a certain amount of endosperm is present in the mature seed (3, Fig. 101).

In others, however, such as the bean, pea, and turnip, the developing embryo absorbs and utilises practically the whole of the endosperm and the nucellus before the seed ripens, so that mature seeds of these plants contain little or no endosperm-tissue and are described as exendospermous (4, Fig. 101).

Most commonly the tissue of the nucellus is disorganised and absorbed during the development of the embryo, but in

certain plants it becomes stored with food and is present in the ripe seed: such stored nucellar tissue is termed *perisperm* (*n*, 2, Fig. 101).

The fertilisation act brings about the production of an embryo, and stimulates the growth of other parts of the ovule, so that

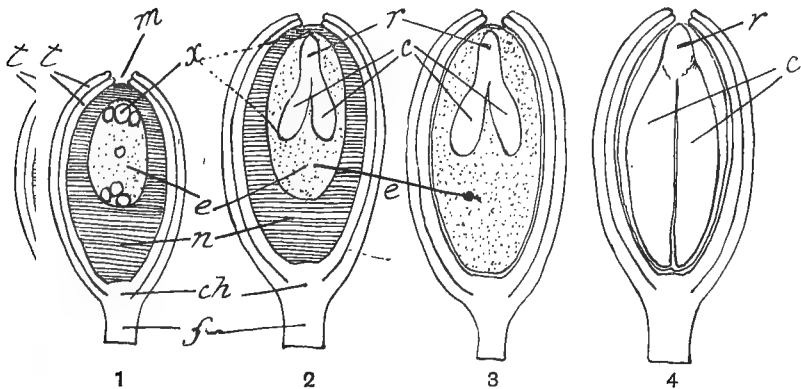

FIG. 101.—Diagrammatic longitudinal sections of an ovule (1) and the seeds (2, 3, and 4) which may be derived from it.

x The ovum which after fertilisation becomes the embryo of the seed; *m* micropyle; *ch* chalaza; *f* funicle; *l* coats of ovule; *e* embryo-sac; *n* nucellus; *r* radicle of embryo; *c* cotyledons of embryo.

2 and 3 are 'albuminous' seeds, tissues derived from the nucellus and embryo-sac being present in them. In 2 the tissue *n* is termed perisperm; it is absent from 3. In 3 the endosperm tissue *e* produced within the embryo-sac is alone present with the embryo.

4 is an 'exalbuminous' seed, both perisperm and endosperm being absent.

the latter is finally converted into a *seed*: the corresponding parts of the ovule and the seed are indicated below:—

• The Ovule.	The Seed.
The egg-cell or ovum becomes the embryo.	
„ integuments	„ „ seed-coats or testa.
„ micropyle	„ „ micropyle.
„ funicle	„ „ funicle.

In so-called 'albuminous' seeds, the 'albumen' may represent storage-tissue developed in the embryo-sac and termed endosperm, or it may be derived from the nucellus, in which

case it is designated perisperm ; some seeds may contain both endosperm and perisperm.

After fertilisation has been accomplished, the style and stigma of the carpels and also the corolla of most conspicuous flowers, wither and fall off. The stimulus of the sexual act incites the ovule to grow, and a similar influence is transmitted to the tissues of the ovary-wall, which also grow and expand to allow the development of the seeds within : the gynæcium of the flower becomes converted into a *fruit*.

Moreover, the act of fertilisation frequently induces growth and change in the receptacle and flower-stalk, as in the apple, pear, and strawberry.

Some cultivated plants, such as varieties of cucumber, grape, pine-apple, orange, and banana, produce 'seedless fruits,' the walls of the ovaries developing extensively apart from any seed production. However, in the tomato, melon, plum, and the majority of plants, fruits either do not develop at all or drop off long before they reach normal size, when fertilisation does not take place.

That the development of the seed influences the growth of the fruit may be seen by watching the development of an apple flower in which some of the five stigmas present have been pollinated and others left : the 'fruit' from such an incompletely pollinated flower becomes somewhat one-sided and unsymmetrical in form, for only the carpels corresponding to the pollinated stigmas produce seeds, and it will be found that the part of the 'fruit' in which the seeds are present grows more rapidly than the seedless part.

Tomatoes and strawberries also develop into one-sided, irregular fruits when pollination is incomplete.

Only one pollen-grain is necessary to fertilise a single ovule, and more pollen is always produced by flowers than is absolutely necessary for the impregnation of all the ovules within their carpels. There is however some evidence to believe that when

an excess of pollen is applied to the stigmas of flowers the tissues of the pericarp are stimulated to develop more extensively and the fruit is consequently larger, than when a small amount of pollen is applied.

5. **Pollination: self-fertilisation and cross-fertilisation.**—It will be understood from the foregoing account that among plants with completely closed carpels the fertilisation-process is preceded by and dependent upon the deposition of the pollen-grain on the stigma of the carpel of a flower. Although the pollen-grains may be induced to germinate on other parts of the carpel, the pollen-tubes have no power of penetrating the tissues of the latter except when placed on the specially receptive stigma. This necessary transference of pollen-grains from the anthers of the stamens to the stigmas of the carpels is termed *pollination*.

Where the stigma receives pollen from the anthers of the same flower the latter is said to be *self-pollinated*: frequently, however, the stigma in one flower receives pollen from a flower growing on another distinct plant, in which case the flower receiving the pollen is spoken of as *cross-pollinated*.

A simple term is needed for the intermediate case where the pollen of a flower is transferred to the stigma of another flower growing on the same plant.

Where self-pollination is followed by fertilisation the plants are said to be *self-fertilised* or *close-fertilised*; the term *cross-fertilisation* is applied to cases where the fertilising pollen is derived from another distinct flower of the same species of plant.

Since most plants have their sexual organs close together in the same flower it might be imagined that self-fertilisation would be the rule among flowering-plants. A number of plants with open flowers are undoubtedly self-fertilised and certain plants such as pansy, violet, wood-sorrel and barley, possess *cleistogamous* flowers which never open and which therefore insure certain self-fertilisation.

Extensive and careful observation, however, shows that a large

number of flowering plants are cross-fertilised, and experiments have proved that the plants derived from seeds which have arisen from cross-pollinated flowers are in many cases taller, more robust in constitution and productive of earlier flowers and more seeds than those arising as the result of self-fertilisation.

A great many devices are met with among flowering plants which are calculated to secure a preponderance of cross-fertilisation over self-fertilisation. The chief arrangements tending more or less completely to this end are the following:—

(i) The flowers are often diclinous (p. 87); that is, the sexual organs are produced in separate flowers, which may occur either on the same plant, as in the hazel and pine, or upon different individual plants, as in mercury (*Mercurialis*), hop and willow.

(ii) Although the male and female sexual organs in monoclinal flowers are in close proximity to each other, they frequently do not ripen together: plants bearing flowers of this kind are described as *dichogamous*.

Two types of flowers are met with upon dichogamous plants, namely, (a) *protandrous* flowers, or those in which the anthers ripen and shed their pollen before the stigma is in a suitable condition to receive it, and (b) *protogynous* flowers in which the stigma is receptive some time before the anthers open and set free their pollen.

Protandrous flowers are abundant; the sunflower, daisy, dead-nettle, carrot, bean, vetch, parsley and most Umbelliferæ, Leguminosæ, Compositæ, and Labiatae are familiar examples: in these, the pollen necessary for the fertilisation of any particular flower usually comes from a younger one, because its own pollen has been shed before the stigma is receptive.

Protogynous flowers are less common: examples are seen in the apple, pear, plantain (*Plantago*), meadow foxtail and sweet vernal-grasses, rushes, hellebore, and species of Speedwell (*Veronica*), and *Calceolaria*. In these the stigmas are pollinated from the

anthers of flowers which have opened previously, their own anthers being not yet ripe when the stigma is fully developed.

(iii) Among monoclinous flowers which are *homogamous*, that is, which develop and ripen their sexual organs simultaneously, the distance apart or the relative position of the anthers and the stigma is often such that the transference of pollen from the former to the latter is rendered uncertain: examples exhibiting adaptations of this class are met with in the primrose and cowslip.

(iv) Among certain plants, especially some orchids, the pollen has no fertilising effect upon ovules produced in the same flower.

Transference of pollen.—Since the pollen-grains of plants have no power of spontaneous movement, they must be carried from one flower to another by some external agency.

In certain cases snails, birds, and currents of water effect the transference of pollen from place to place, but the chief agents which carry the pollen-grains from one flower to another are (1) the wind and (2) insects.

Flowers which are cross-pollinated by aid of the wind are said to be *anemophilous* or *wind-pollinated*: those in which the pollination is brought about by the agency of insects are described as *entomophilous* or *insect-pollinated* flowers.

Wind-pollinated flowers are sometimes loosely described as *wind-fertilised* and insect-pollinated flowers as *insect-fertilised*: it must, however, be clearly understood that the function of the wind and insects is merely the transference of the pollen-grains from the anthers of one flower to the stigma of another, and that these agents have no direct influence upon the act of fertilisation which subsequently takes place in the ovule.

As examples of plants whose flowers are wind-pollinated may be mentioned the hop, docks, almost all grasses and sedges, and many trees and shrubs, such as hazel and birch. Their flowers are generally small and inconspicuous, without scent: 'honey' is generally absent, and the pollen-grains, which are usually produced in large quantities, have a smooth and dry external surface. The anthers

in many cases have long slender filaments which allow of their easy movement even by gentle breezes: the stigmas are often very large and feathery and specially adapted to catch the floating pollen-grains.

Insect-pollinated flowers, of which roses, honeysuckle, clover and primrose may be mentioned as examples, usually have brightly-coloured petals or sepals, and are often highly-scented. *Nectaries* or *honey-glands* which secrete *nectar*, a sweet liquid commonly called 'honey,' occur on various parts of the flower.

Their pollen-grains are less abundant than in wind-pollinated flowers and generally have an ornamented sticky surface which enables them to cling together and to the bodies of insects. The stigmas of such flowers are comparatively small, and when ready for pollination often exude a viscous liquid to which the pollen-grains readily adhere, and in which they germinate freely.

The insects which visit flowers are mainly beetles, flies, moths, butterflies, and bees. The various tints of flowers, their odour and the nectar which is secreted by them, serve to attract these visitors, and in certain measure enable the latter to distinguish the particular species of plant which they wish to visit.

Insects feed upon nectar and also to some extent upon pollen, which they obtain in part from wind-pollinated flowers which contain no nectar.

In their search for a livelihood bees and other insects unconsciously render useful service to the plants which they visit by bringing about cross-pollination.

Where the nectar is exposed or easily accessible, as in most umbelliferous plants and buttercups, a great variety of insects belonging to different families are attracted, and many of them creep about and often merely self-pollinate the flowers. In many cases, however, the nectar is secreted and stored at the base of long, tubular corollas and calyces, or in places otherwise difficult of access, where it can only be reached by insects, such as moths, butterflies, and bees, possessing long proboscides

and tongues, or some particular form and weight of body. In flowers of this character, the insects during their search for nectar, touch the anthers, and the pollen becomes dusted on to their bodies, often at some particular point, which point is brought into contact with the stigma of a flower subsequently visited, and cross-pollination is effected.

An example of the adaptation of a flower to the visits of large bees may be studied in the common White Dead-Nettle. (*Lamium album* L.) (Fig. 102). The flower has a conspicuous,

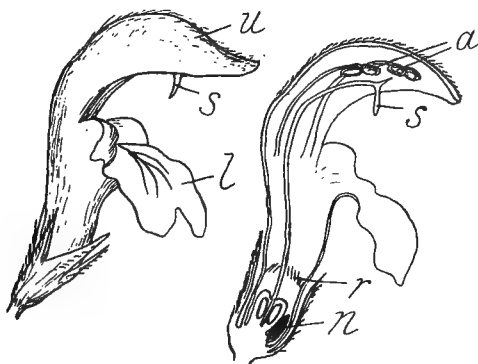

1

FIG. 102.—1. Flower of white dead-nettle (*Lamium album* L.). 2. Section of the same; *s* stigma; *a* stamens; *r* ring of hairs; *n* nectary.

white, two-lipped corolla. The upper lip (*u*) is arched and protects the pollen from being washed away by rain; it also prevents rain from passing down to the nectary which is present at the base of the ovary (*n*). When visiting such a flower, the bee alights on the lower lip (*l*) of the corolla which acts as a convenient landing-stage, and pushes its head down the tube of the corolla in search of the nectar concealed below. The body of a large bumble bee or a hive bee fits almost exactly into the mouth of the corolla, and the back becomes dusted with pollen from the anthers (*a*) under the upper lip (*u*). On enter-

ing another flower, the back of the bee with the pollen upon it comes first into contact with the lower half of the bifid stigma (*s*) which projects a short distance below the anthers, and cross-pollination is readily effected. Pollen from this second flower is removed on leaving and transferred to a third, and so on. The tongues of flies and other insects whose bodies are not stout enough to fill up the mouth of the corolla, and come in contact with the anthers, are too short to reach the honey; moreover, a ring of hairs (*r*) arranged across the lower part of the corolla tube prevents small insects from robbing the flower of its nectar. Almost all zygomorphic flowers, such as the bean, clover, sainfoin, mint, snapdragon, and many others, exhibit striking adaptations to secure cross-pollination by the agency of insects, and many of these, when insects are prevented from visiting them, are practically unable to effect self-fertilisation, and hence produce little or no seed under such circumstances.

It must, however, be mentioned that although many flowers, such as those of the broad-bean, broom, carnation, red clover and foxglove, are either unable to produce seed, or produce but few, when insects are excluded, others which show special adaptation for cross-pollination by insects, and which are usually and most advantageously pollinated by these agents, have also the power of self-fertilisation, and often exercise it in dull weather, or at other times when insect-visitors are scarce. For example, the flowers of vetch, pea, dwarf-bean (*Phaseolus vulgaris*) and tobacco produce seeds when specially protected from being cross-pollinated by insects. Many protogynous flowers in a young state are adapted for cross-pollination, but if the latter does not take place, the stigma frequently receives pollen from its adjoining anthers at a later stage of development of the flower.

Ex. 170.—Examine the following wind-pollinated flowers:—grasses, sedges, rushes, oak, walnut, birch, alder, hazel, hop, plantain and dock

Note (1) the absence of conspicuous calyx or corolla.

- (2) Powdery, dry, character of the pollen.
- (3) The extensive receptive surface of the stigmas.
- (4) General absence of scent and nectar.

Ex. 171.—Examine the following insect-pollinated flowers:—buttercup, columbine, monk's-hood, poppy, cabbage, pansy, violet, pink, carnation, primrose, stitchworts, mallows, horse-chestnut, bean, clovers, birds' foot trefoil and other leguminous plants, strawberry, apple, pear, cherry, plum, dandelion, sunflower, thistle, knapweed, parsnip, carrot and other umbelliferous plants.

Make an examination of the flowers in different states of development, and note:—

- (1) Whether they are protogynous or protandrous.
- (2) Where the nectar is secreted and stored if any is present: it may be at the base of the stamens, on the receptacle, ovary, or in specially constructed parts of the petals and sepals. Frequently ridges and variegated stripes of colour on the petals point in the direction of the nectary, and apparently serve as guides to insect-visitors.
- (3) Determine whether there is any specially convenient landing-place for insect-visitors, and try and find out whether the stigma or anthers are touched first when insects visit the flowers.
- (4) Whenever opportunity offers, carefully watch insects at work extracting honey or collecting pollen from flowers.

6. Sexual affinity: hybridisation and hybrids.—A fertile sexual union between the male reproductive cell of a pollen-grain and the egg-cell within an ovule does not take place indiscriminately among plants. A certain relationship or sexual affinity must exist between the parent plants before their reproductive cells will unite.

Although self-fertilisation is possible, and among certain plants is a normal process, experience teaches that in many cases the pollen of a flower has no fertilising effect on the egg-cells of ovules present in the same flower or in flowers on the same individual plant.

Moreover, it is generally found that fertilisation between the reproductive cells of plants widely different from each other, say, between those of a cabbage and a potato, or those of a peach and a turnip, does not take place.

In some instances the cause of the failure of the pollen of one plant to fertilise the ovules of another may possibly be due to the want of power of the pollen-grain to develop pollen-tubes long enough to reach from the stigma to the ovules within the ovary; or the tissues of the style may offer some mechanical obstruction to the advancing pollen-tubes. In most cases, however, it would appear that there is some other quite unknown cause at work which prevents the living substance, composing the reproductive cells of certain plants, from exercising a fertilising influence on each other.

When the relationship between the male and female reproductive cells is too close, and also when it is too remote, fertility is reduced. For the production of the most vigorous and the most prolific progeny there must be a certain degree of difference between the reproductive cells which unite.

As pointed out previously (p. 279) the most fertile sexual union takes place between the reproductive cells of flowers which arise on different individual plants of the same species. The progeny resulting from such cross-fertilisation grow luxuriantly and produce numbers of seeds capable of giving rise to equally robust offspring.

It is also found that well-marked, wild and cultivated varieties and races of the same species of plant generally cross readily: thus, the cross-pollination of different varieties of wheat, barley, turnips, apples, carnations, roses and other plants, results in the production of offspring. The progeny arising from cross-fertilisation between two varieties or races of the same species are termed *cross-breeds*, or *variety-hybrids*.

Variety-hybrids usually possess the following characters:—

(i) They are often more luxuriant and robust in constitution than their parents; their roots are frequently extensive and the shoots and leaves large.

(ii) They usually grow more rapidly, flower earlier, and produce a larger number of flowers than the parents.

(iii) If the flowers of the parents are dissimilar in colour, those of the variety-hybrids produced by crossing them are generally diversely mottled with both colours, in separate patches, and not blended into one uniform tint.

Other peculiar characteristics, especially of the fruits of the parents, are often found unblended in varying proportion in the offspring; hybrids in which the characters of the parents are found thus unmixed are termed '*mosaic-hybrids*.'

(iv) The power of seed-production is strong and their seedling offspring is generally very vigorous.

It has been found in a large number of instances that the pollen of one plant cannot impregnate the ovules of another widely differing from it, but we have no means of determining beforehand whether any two particular species will cross successfully; nothing save actual trial will decide.

Many examples are known where cross-fertilisation does take place between different species of plants, as for example, between the raspberry and blackberry, wheat and rye, different species of strawberry (*Fragaria*) and various species of *Pelargonium*, *Dianthus*, *Narcissus*, *Digitalis*, *Viola*, *Gladiolus*, *Begonia* and many other ornamental flowering-plants. Cross-fertilisation between distinct species of plants is termed *hybridisation*, and the progeny of such crossing are termed *hybrids*: when the species crossed belong to the same genus, the progeny are sometimes designated *species-hybrids*, to distinguish them from *genus-hybrids*, or *bigeneric hybrids* the progeny of species belonging to different genera.

Few or no crosses are known with certainty between plants belonging to different Families or Orders; even genus-hybrids are comparatively rare.

Generally the more nearly allied the species are the more readily do they hybridise.

The species belonging to certain Orders seem naturally inclined to hybridisation; especially is this true of the Compositæ,

Orchidaceæ, Iridaceæ and Scrophulariaceæ: on the other hand, among the Cruciferæ, Leguminosæ and Umbelliferæ hybrids are uncommon.

True hybrids or crosses between distinct species of plants usually exhibit the following characters:—

(i) If the parents are very widely different from each other, the offspring is usually delicate and difficult to rear, but where the parents are more nearly related the offspring is frequently taller and more vigorous and luxuriant in its vegetative organs than either of the parents.

(ii) In nearly all cases hybrids are less fertile than their parents: their sexual organs are weak, and frequently they are absolutely sterile, the anthers producing no pollen or the carpels no ovules, so that seed-formation is impossible. In certain rare instances there appears no inclination or power to form flowers. In those which do produce flowers and seeds the pollen-grains are generally smaller in size and number, and the ovules more or less imperfectly formed: the male reproductive organs are more deleteriously affected than the female organs.

(iii) The petals and coloured parts of the flower are generally larger and more lasting than those of either parent. 'Doubling' of the flowers and other pathological malformations are more common among hybrids.

(iv) In the first generation raised from seeds obtained by cross-pollinating distinct species, all the individual plants are, in most instances, similar to each other, and resemble both parents: their characters in regard to form and size of root, stem, leaf and flower are intermediate between the two.

The individuals of the second or later generations, that is, the offspring which arise from self-pollination or cross-pollination of the flowers of hybrids, vary much in form and in other ways: they do not resemble each other nearly so much as those of the first generation. Some of them almost exactly resemble the female, others the male parent, while many show the

characters of both parents combined in various degrees. Moreover, in many instances, entirely new characters, not seen in either parent, arise among the offspring of succeeding generations of hybrids.

(v) Hybridisation is usually, though not always, reciprocal: if the pollen of a species A is effective upon the ovules of another species B, the pollen of B is usually similarly effective upon the ovules of A.

In most instances there is no difference between the offspring of reciprocal crosses.

It has been noticed also that in the crossing of certain species the hybrids produced always resemble one of the species more than the other, no matter whether it is used as the male or the female parent of the cross.

Almost all hybrids are more easily crossed with pollen derived from one of the parent species than with pollen from its own flowers or from flowers of another hybrid of the same origin as itself: the progeny of such crossing are termed *derivative hybrids*.

Most derivative hybrids are intermediate between the parent and the original hybrid: they are more fruitful than the latter, and some of them frequently come true from seed. If such hybrids are again pollinated by the same parent, the progeny or members of the third generation resemble the pollinating parent more closely; by a repetition of the crossing with the same parent up to the fourth or fifth generation, all trace of the original second parent of the hybrid is lost or unrecognisable in the progeny.

True hybrids may be crossed with another species different from either of the parents, and the offspring, which may be termed *trispecific hybrids*, can be crossed again with still another distinct species. In this manner plants have been obtained combining the characters of three, four, or more species: the offspring of such crossed plants are very variable.

7. Mendelian laws of inheritance.—(i) Since 1900 much

attention has been devoted to experimental work upon the character of hybrids, or crosses between varieties of plants, and those exhibited by their offspring.

Some remarkable facts were observed by Gregor Johann Mendel in Germany about 1866, but the published accounts of his work and the 'laws of inheritance' deduced from it were lost sight of until about 1900, when De Vries in Holland, Correns in Germany, and Tschamak in Austria rediscovered similar facts.

Mendel worked chiefly with garden peas, and crossed certain varieties which differed from each other in regard to some simple character or pair of characters.

Among other experiments he crossed a variety of pea having smooth round seeds with one bearing wrinkled indented seeds, and found that the offspring consisted invariably of plants which bore only smooth round seeds: the wrinkled character of the parent crossed was not seen in the hybrid obtained.

That character of the parent which appeared in the offspring of the first cross he termed *dominant*, the character not seen being spoken of as *recessive*.

Seeds arising from the self-fertilisation of the flowers of the round-seeded hybrid gave rise not only to round-seeded peas but to plants with wrinkled seeds as well.

The number of seeds showing the dominant round character was found to be three times as many as those exhibiting the recessive wrinkled character.

Mendel continued the raising of plants from these seeds through several generations, and found that the wrinkled seeds bred true: they were as pure in respect of the recessive character as the original parent, and never gave rise to round peas.

The round seeds, however, behaved differently. One in every three bred true; it was pure in regard to the dominant character, but two of the round seeds in every three gave offspring which

bore both round and wrinkled seeds. They were hybrid like the first cross, and the proportion of round seeds to wrinkled ones which they produced was 3 to 1.

If we assume that each plant produces say 4 seeds, the following scheme indicates the proportion of each kind obtained in three successive generations :—

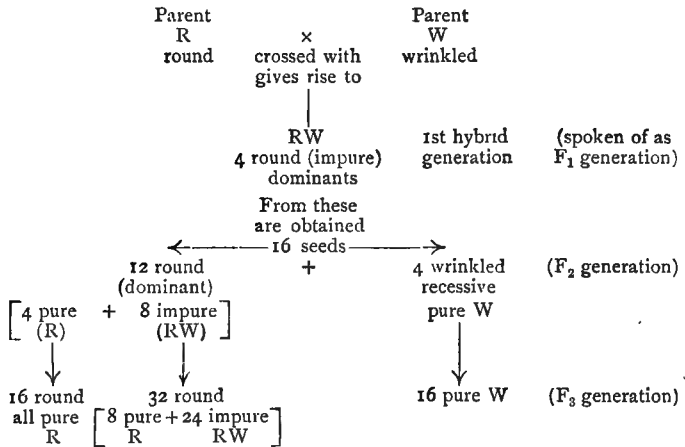

(ii) That certain characters of plants are dominant over others when crossing takes place was well known before Mendel's time, and that among the later generation or offspring of crosses, individuals bearing the parental character not seen in the first generation are obtained, was also known, but the average numerical proportion of each was not noticed previously.

The most important feature of Mendel's work, however, lies in the explanation which he offered of the facts.

He propounded the hypothesis that, so far as a pair of char-

acters which exclude each other, or are opposed to each other are concerned, each male or female reproductive cell or gamete of the hybrid carries only *one* of the characters, not both, *i.e.* each individual gamete of a cross bears either the dominant or recessive character of the original parents, but not both.

Although the hybrid plant arising from the union of reproductive cells of, say, a pea, with round seeds, and one bearing wrinkled seeds, contains both of these characters, even if both are not visible, its reproductive cells carry only the round or the wrinkled character in a pure state; its pollen-grains and ovules or the generative nuclei in them, are either pure 'round' or pure 'wrinkled.'

Moreover, Mendel assumed that the number of male cells (and female cells) bearing the 'round' character was on an average equal to those carrying the 'wrinkled' character.

Such assumptions being made, the result of the union when only self-fertilisation is allowed will be understood from the following:—

A hybrid plant produced by the crossing of a parent bearing round seeds (R) with one bearing wrinkled seeds (W) possesses:—

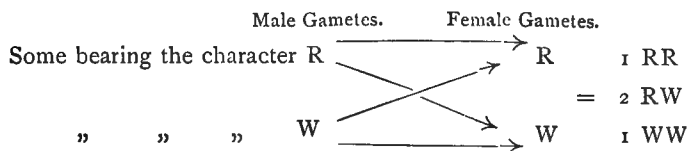

Any male gamete bearing the R (round) character has an equal chance of meeting with a female gamete carrying R or W. If it meets with R the plant produced will bear round seeds, and will be quite pure (RR) in respect of this character of round-

ness. If it meet with a gamete bearing W, the resulting plant will be hybrid, and will not breed true.

We thus see that on an average there will be formed from the male gametes carrying the round character, uniting at random with the female gametes available—

$$\left. \begin{array}{l} \text{pure RR plants} \\ \text{hybrid RW ,,} \end{array} \right\} \begin{array}{l} \text{in the} \\ \text{proportion} \\ \text{of} \end{array} \begin{array}{l} 1 \text{ RR} \\ \text{to} \\ 1 \text{ RW} \end{array}$$

Similarly, from the male gametes possessing the wrinkled character (W) we should have—

$$\left. \begin{array}{l} \text{pure WW plants} \\ \text{hybrid RW ,,} \end{array} \right\} \begin{array}{l} \text{in the} \\ \text{proportion} \\ \text{of} \end{array} \begin{array}{l} 1 \text{ WW} \\ \text{to} \\ 1 \text{ RW} \end{array}$$

Taking the combination of all the gametes at random, where the number of male and female sex cells each bearing only one (R or W) of two characters is the same, we should have the following proportional result :—

$$\underbrace{\begin{array}{cc} 1 \text{ plant} & 2 \text{ plants} \\ \text{RR} & \text{RW} \end{array}}_{\text{Dominant.}} \qquad \underbrace{\begin{array}{c} 1 \text{ plant} \\ \text{WW} \end{array}}_{\text{Recessive.}}$$

As the round is dominant over the wrinkled character, the impure hybrid plants (RW) will *look like* the pure (RR) plants. Therefore the proportion of plants showing the round dominant to those exhibiting the recessive wrinkled character would be 3 to 1, which is what Mendel found to be actually the case in his experiments.

When the hybrid was crossed with the parent bearing the wrinkled character, instead of being self-fertilised, the offspring consisted of round and wrinkled peas in equal proportion, which is also what would be expected from Mendel's hypothesis.

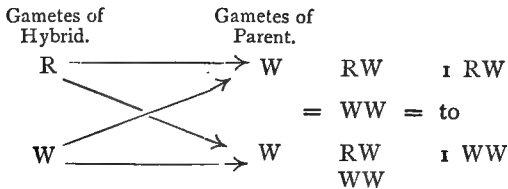

Mendel crossed peas varying in several other characters, and obtained results similar to those described. For example, peas having yellow cotyledons were crossed with varieties having green cotyledons. Yellow was found to be dominant, but *segregation* or splitting into the two types occurred in the second generation: peas having green cotyledons appeared, and in the proportion of 1 with green to 3 with yellow cotyledons.

(iii) Characters which exclude or contrast with each other, as the 'roundness' and 'wrinkledness' of peas, are spoken of as a pair of *allelomorphs*.

A plant or animal which arises from the union of two distinct germ-cells is sometimes termed a *zygote*.

The individual plant formed from the fertilisation of sexual cells bearing similar allelomorphs is termed a *homozygote* (RR for example). Where the allelomorphs are antagonistic the resulting plant is spoken of as a *heterozygote* (as RW).

(iv) The following have been found by experiment to behave as allelomorphic pairs of characters:—

In	Dominant.	Recessive.
Peas	Tall habit	Dwarf habit
	Yellow cotyledon	Green cotyledon
	Brown skin	White skin
	Round seeds	Wrinkled seeds
Wheat	Absence of awns	Presence of awns
	Rough chaff	Smooth chaff
	Red chaff	White chaff
Lychnis	Hairiness	Smoothness
<i>Chelidonium majus</i>	Entire petals	Lacinate petals
Maize	Starchy endosperm	Sugary endosperm
Œnothera	Long style	Short style
Sweetpea	Oval pollen-grains	Round pollen-grains
Many plants	Coloured flowers	White flowers

(v) After dealing with peas varying in one pair of characters, Mendel crossed varieties exhibiting two pairs of allelomorphs, and determined the distribution of the parental features among the offspring.

When a round pea having green cotyledons is crossed with a wrinkled one having yellow cotyledons, two allelomorphic pairs are concerned, viz. (1) 'round' and 'wrinkled'; (2) 'yellow' and 'green.'

- (1) 'Round' seeds are dominant to 'wrinkled' seeds;
- (2) 'Yellow' cotyledons are dominant to 'green' cotyledons.

The first cross, or F_1 generation, is found to consist of round, yellow peas only.

On self-fertilisation F_2 generation is obtained. This yields four types of peas, namely—

- | | |
|-----------------|--------------------|
| 1. Round yellow | 3. Wrinkled yellow |
| 2. „ green | 4. „ green |

in the following proportion :—

9 : 3 : 3 : 1
 round yellow round green wrinkled yellow wrinkled green

Two of these types are like the original parent in appearance, but in addition to these, two new varieties have been obtained, namely, wrinkled green and round yellow peas.

On Mendel's hypothesis this result, both as regards the colour of the seeds and the proportion of each, is to be expected, as is seen from the diagram below—

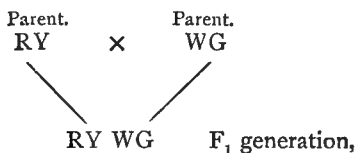

a round yellow pea, since 'round' and 'yellow' are dominant to 'wrinkled' and 'green' respectively.

The gametes of the hybrid would be—

Male.	Female.
RY	RY
RG	RG
WY	WY
WG	WG

The RY male gametes have an equal chance of meeting with either, RY, RG, WY, or WG.

Similarly	RG	do.,	do.,	do.
„	WG	do.,	do.,	do.
„	WG	do.,	do.,	do.

The possible combinations are seen in the following diagram.

		Male Gametes.			
		RY	RG	WY	WG
Female Gametes.	RY	RY ¹ RY ¹	RG ¹ RY ¹	WY ¹ RY ¹	WG ¹ RY ¹
	RG	RY ¹ RG ¹	RG ² RG ²	WY ¹ RG ¹	WG ² RG ²
	WY	RY ¹ WY ¹	RG ¹ WY ¹	WY ³ WY ³	WG ³ WY ³
	WG	RY ¹ WG ¹	RG ² WG ²	WY ³ WG ³	WG ⁴ WG ⁴

a. Those marked (1) in which RY occurs will all be alike in appearance, viz., round yellow peas, roundness and yellowness being dominant characters. Of these there are nine.

b. Three marked (2), viz., RG RG, WG RG, and RG WG, are round green peas, R being dominant over W ; Y is absent.

c. Three marked (3), viz., WY WY, WG WY, and WY WG, are wrinkled yellow peas. R is absent, and Y is dominant over G.

d. One marked (4), WG WG, is a wrinkled green pea.

The wrinkled green pea is a new variety, and it will breed true when self-fertilised, having no Y or R in it. This is found to be the case when tested.

One of the three wrinkled yellow peas WY WY will breed true.

One of the three round green peas RG RG will breed true.

One of the nine round yellow peas RY RY will breed true.

The remainder are impure or hybrid in respect of one or

other allelomorphic pair, and consequently segregate in various ways when self-fertilised.

From the above example it is seen that certain characters existing in two separate varieties of plants may be combined in one variety, and this is not an isolated case. Many others have been worked out experimentally.

(vi) The Mendelian conception of distinct unit characters which are capable of being inherited independently of each other has given precision to our views of the nature of heredity and the constitution of pure breeds and hybrids or crosses.

A *pure-bred* individual is one which has developed from the union of male and female cells containing similar elements or characters, while a *hybrid* or *cross-bred* organism has arisen from sex cells conveying different allelomorphic elements. A plant may be pure bred in respect of one character, and yet be cross-bred in regard to another character.

This hypothesis of the distinctness of hereditary characters greatly assists the efforts of the plant breeder, inasmuch as it indicates the line along which crossing must take place to effect a desired combination in one plant of characters only met with in separate varieties, and makes his selection among the offspring of crosses to obtain the wished-for result, simpler and more direct than heretofore.

(vii) It has been long known among hybridists that certain cross-bred varieties of plants which exhibit characters different from either of the two parents cannot be fixed. On self-fertilisation the new character is not met with in all the offspring, there being many individuals (rogues) which have to be discarded. No amount of selection or self-fertilisation is found to fix the new type.

These hybrid forms are generally merely heterozygotes, and on Mendel's hypothesis ought to break up into 25 per cent.

like each parent, with 50 per cent. hybrid again, which they generally do.

Mendelism, moreover, throws considerable light on various forms of 'reversion' (p. 317).

Some 'reverted' individuals which appear among what is thought to be a selected so-called pure stock, are merely recessives which have never had the chance of showing themselves. The majority of the selected stock might be pure in Mendel's sense—yet if some were impure and contained the recessive character the latter would only be seen when crossing took place between individuals possessing the same recessive character, and the chances in favour of this occurrence might be very remote on account of the numbers of pure population among which the impure individuals were mixed.

Such 'reverted' individuals ought to breed true when crossed among themselves or self-fertilised, and this is sometimes the case.

There are other 'reversions' which do not breed true among themselves in the first (F_1) generation, yet show a small percentage which breed true to the reversionary character in the second (F_2) generation, and cannot therefore be of heterozygote nature.

Such cases are seen in what is termed 'reversion on crossing.'

These can also be explained on Mendelian lines, but further information regarding them must be sought in the growing literature on the subject.

8. Artificial pollination : methods of crossing plants.—Several plants, such as the melon, peach, tomato and egg-plant, which do not set fruit unless the ovules are fertilised, must be cross-pollinated artificially when grown under glass and forced to bloom in early spring or at other seasons of the year, when pollinating insects are not abundant.

The process consists merely in a transference of pollen to the stigmas of the flowers by means of a camel's-hair brush, a plume of pampas-grass, or a rabbit's tail fastened to a small stick.

In the case of the tomato, peach, and other plants with monoclinalous flowers, merely shaking the plants is sometimes sufficient to distribute the pollen satisfactorily, but the most efficient method in the case of the peach and melon is first to collect the pollen from the anthers by means of a camel's-hair brush, and then apply the pollen-laden brush to the stigmas of the flowers: with tomatoes it is best to shake a quantity of pollen from several flowers into a watch glass or spoon, and then dip the stigmas of the flowers into the pollen so collected.

In the case of the melon where the flowers are diclinous, the staminate flowers are sometimes pulled off the plant, and after rolling back the corolla, the exposed anthers may be gently brushed over the stigmas of the pistillate flowers intended to be pollinated, or a whole male flower may be pushed into the corolla of one of the latter and left there. Of course, in these and all other instances the anthers must be in a dehiscent condition, so that the pollen-grains are fully formed and easily set free, and the stigmas must be in a receptive condition.

Where it is desired to cross or hybridise two particular varieties or species of plants, it is necessary to proceed in a more careful manner. One or more flowers upon the plant which is to act as the female parent or seed-bearer, must be selected for the operation, and must be prevented from receiving any other kind of pollen upon their stigmas except that from a flower from the plant which has been chosen as the male parent.

Before attempting to cross two plants it is important to study and become familiar with the structure of their flowers in regard to the number and position of their sexual organs and whether the flowers are protandrous or protogynous; moreover, a knowledge of the appearance presented by the stigmas when they are

ready to receive pollen, and the mode and time of dehiscence of the anthers when the pollen is mature, is useful.

The receptive surfaces of the stigmas of flowers when mature are often moist or sticky : in other cases they enlarge and appear rough and covered with very small round prominences when viewed with a lens. Where the stigmas are bifid the two halves, which in an immature state lie close together, separate and curl away from each other when mature.

The details of the actual method of cross-pollination varies with the structure and arrangement of the flowers to be operated upon, and also to some extent upon the taste and fancy of the operator. The following plan gives excellent and accurate results :—

(i) First select the flower to be used as the seed-bearer. This must be done before the flower has opened and before its own anthers are mature enough to shed their pollen. Unless this precaution is adopted self-pollination or cross-pollination by agency of the wind or insects may have already taken place.

Where several flowers are borne somewhat close together as in the apple and wheat, one or two only should be crossed and the others removed, so that the crossed specimens may have a better chance of developing.

(ii) Open the flower and carefully remove the stamens with fine-pointed forceps taking hold of each stamen by its filament so as not to crush the anther and thereby run the risk of setting free the pollen.

Where the stamens are epipetalous and in other instances it is sometimes more convenient to cut off the calyx, corolla, and stamens with fine scissors. Be careful not to touch or injure the style and stigma of the gynæcium.

After this process of *emasculatio*n or removal of the male sexual organs, the flower or the shoot bearing it must be enclosed in a paper bag tied up at the mouth so as to exclude

insects and prevent wind-pollination : allow the stigma to mature, which usually takes two or three days according to the age of the flower when emasculated.

(iii) When the stigma is ready, remove some ripe stamens from the flowers of the plant to be used as the male parent of the cross, and after lightly crushing the anther on the fingernail so as to set free the pollen, transfer the latter by means of forceps to the stigma. To ensure absolute accuracy the flowers from which the pollen is taken should have been previously enclosed in a paper bag and allowed to open there : if this precaution is neglected and stamens are merely taken casually from open flowers on the male parent there is no certainty about the cross for foreign pollen may have been brought into contact with them by the wind or by insects.

(iv) After pollination has been effected the flower must be again enclosed in a paper bag and kept there until the seeds have been fertilised and the fruit has begun to grow.

The bag may then be removed and the fruit and seeds allowed to ripen in the ordinary way ; in the case of fruits, such as apple, pear and raspberry, it is necessary to protect the ripening fruit by means of a muslin bag or coarse net.

CHAPTER XXIII.

CULTIVATED PLANTS AND THEIR ORIGIN : PLANT-BREEDING.

1. FROM the most remote ages the human race has derived much of its sustenance from the Vegetable Kingdom. At first, no doubt, men were content to roam about and feed upon the roots, stems, leaves, fruits and seeds of various species of plants found growing wild, just as the lowest savage races do at the present day. With a settled mode of life and increasing population would come the necessity to select and cultivate close at hand particular species possessing useful and agreeable qualities, so that a constant and more certain supply of food might always be obtained.

By whom or at what period in the history of mankind was begun the selection and first cultivation of the different wild plants which have given rise to our chief cultivated food-plants, is not known. Extensive researches by De Candolle and others have shown that the majority of our common vegetables, fruits and cereals have been in cultivation for many hundreds and in some instances thousands of years : during this time they have undergone extensive modification.

In the case of wheat, maize, broad bean, and a few others, the wild species from which they have been developed are unknown ; in most cases, however, the wild prototype of the various cultivated farm and garden plants can be recognised with more or less certainty. On comparing cultivated varieties with the wild species it is noticed that the former differ from the latter in possessing a greater development and generally an improved

flavour of those parts of the plants, for which they are grown, the other parts or members of the plant being much the same in both the wild and the cultivated state.

For example, among apples, pears, plums, strawberries and other plants which are grown for their fruits, the flowers, stems and leaves are similar to those of the crab, wild pear, sloe and strawberry from which they have been derived, but how different are their fruits.

In the cases of plants grown for their roots only, it is the root which manifests the greatest amount of deviation from the wild prototype, as may be seen by comparing the roots, stems, leaves and flowers of the wild carrot and wild parsnip with those of the cultivated varieties.

The peculiar characteristics which distinguish cultivated from wild plants are seen to be connected with increased usefulness to mankind, and it is through man's agency that these useful modifications have reached their present state of development: without the care and constant attention of the farmer and gardener the cultivated types would disappear.

In addition to the maintenance of cultivated varieties at their present level of excellence endeavours are continually being made to modify and improve them; old varieties are being altered so that either the yield of their useful parts is increased, or the colour, size, form, flavour, time of ripening, keeping qualities or hardiness is improved. The mode in which this improvement takes place is indicated in the subsequent paragraphs of this chapter.

2. **Bud-varieties or 'sports.'**—The buds upon a plant resemble each other so much that they all develop into shoots very closely alike, so far as the colour and form of their stems, leaves, flowers and fruits are concerned. It is, however, occasionally noticed among perennial farm and garden plants that single buds upon certain individuals grow out and produce shoots which differ very greatly from the shoots arising from the rest of the

buds upon the plant. Thus, single buds upon peach trees have been observed to develop into shoots which, instead of bearing peaches, bear nectarines, and plum trees ordinarily producing purple fruit have been known to give rise to a single shoot bearing yellow plums of a totally different character from any previously known.

Such sudden and extensive variation is termed *bud-variation* or ‘*sporting*,’ and is most frequently met with in those species of perennial plants which have been under cultivation for very long periods of time. It is extremely rare among annual plants and uncommon upon perennials which have only recently been introduced into the garden.

Very few ‘sports’ can be propagated by seeds; they must consequently be removed from the parent and multiplied vegetatively, that is, by cuttings and layers or by budding and grafting.

Many examples of new varieties of plants which have originated from bud-variation are met with among garden flowers such as roses, carnations, chrysanthemums, tulips and pelargoniums.

Also in this manner have arisen practically all the variegated-leaved and ‘weeping’ forms of ash, willow, box, holly, and other trees and shrubs.

Among farm crops potatoes are subject to bud-variation, but its occurrence is extremely rare: varieties bearing tubers with purple skins have, however, been known to produce single white tubers among those of ordinary colour, and purple-skinned tubers have been observed with one or more white ‘eyes’ which, on being cut out and propagated, have grown into plants bearing white-skinned tubers only.

3. Variation among seedling plants.

(a) ‘Seminal sports’: selection and fixation of varieties.—

One of the most important peculiarities of living things of all kinds is the variability of their sexually-produced offspring. Although bean seeds always produce bean plants and wheat grains invariably give rise to wheat plants, nevertheless no two

seedlings of these or any other species are exactly alike in all respects. The variation may be merely morphological, that is, it may consist in an alteration in the form and size of the leaf, stem, or other part of the plant: the individuals may also differ physiologically from their parents and from each other; for example, among potatoes the seedlings differ in their power of starch formation and storage, and in their capability of resisting frost and the attacks of insects and parasitic fungi.

The differences between the parents and their offspring in the case of wild plants are usually very slight, but among a number of cultivated plants the amount of variation seen in the seedling is often very considerable.

A seedling which differs very appreciably from its parent in some of its morphological or physiological characteristics may be termed a '*seminal sport*.'

Although many '*seminal sports*' differ considerably from the parent stock from which they have been obtained, it does not follow that these varieties are necessarily improvements upon the parents; the majority are often mere curiosities, or distinctly inferior varieties, with no intrinsic value from the farmer's or gardener's point of view; others, however, frequently possess characters of sufficient novelty and distinctness to render them especially worthy of cultivation.

The latter is perhaps most commonly the case among ornamental flowering plants, where each new variation in the colour of the leaves or flowers is often sufficient to make the plant attractive.

Careful investigation into the origin of the many varieties of apples, pears, and other fruits leads to the conclusion that by far the larger number of them are '*seminal sports*' produced from seeds casually sown in woods, hedgerows, and fields by birds or self-sown in gardens: long ago they attracted the attention of some one who considered the varieties worthy of cultivation.

Several of the more modern varieties of fruits have arisen as

‘seminal sports’ from pips or seeds selected in a haphazard manner. Scarcely any of them ‘come true’ from seed; the peculiar characters which they exhibit are not hereditary; for example, the seeds of a Cox’s Orange pippin or a Worcester Pearmain apple when sown do not produce trees bearing apples of these kinds, neither do the seeds of the different varieties of roses or carnations (except in rare instances) give rise to plants bearing flowers similar to their parents. But in these cases, just as in most perennial ‘bud-sports,’ the fact that their characters are not transmitted to seedling offspring is no drawback to their usefulness, for they can be and are readily propagated vegetatively.

‘Seminal sports’ are not unfrequent among annual plants; in such instances, their peculiar character to be of use must be hereditary, for there is no practical satisfactory method of propagating these plants except by seeds. Numerous examples of annuals are known in which the new characters presented by them are transmitted, without material modification or alteration, to all plants of succeeding generations derived from them.

Almost all the best cereals are ‘seminal sports’ of this class which were originally discovered on some roadside or growing among the plants of an ordinary crop. The late Mr Patrick Sheriff of Mungoswells, Haddington, Scotland, who introduced several new and excellent varieties of cereals into the market, was in the habit of systematically searching his fields of wheat and oats for plants presenting new and marked peculiarities of grain or straw, and although he attempted to raise new varieties by crossing and repeated selection as described below, his best introductions appear to have been ‘seminal sports’ discovered in his fields with all their meritorious qualities ready-made and transmissible without change to their seedling offspring.

The sowing of large numbers of seeds, selected at random, of the apple, pear, and other cultivated plants, in the hope that a valuable variety may turn up suddenly, is a game of chance in

which enormous odds are against the raiser; nevertheless, the method has more than once led to successful results.

One of the best varieties of potato ever raised, namely, the *Magnum Bonum*, was obtained by Mr James Clarke of Christchurch, who found it among a batch of seedlings derived from a promiscuously selected lot of potato 'apples'; and many other useful and ornamental varieties of cultivated plants have had a similar haphazard origin.

In the case of a new form occurring among seedlings of perennials, such as shrubs, fruit-trees, strawberries, potatoes, roses and other plants which can be propagated vegetatively, and also in the cases of those new forms of annual plants whose peculiarities are completely and faithfully transmitted by seeds to all their offspring, the work of the plant-breeder is reduced to the mere propagation of the new variety.

Most frequently, however, it will be found that on sowing the seeds of a new form or 'sport,' the majority of the seedlings do not inherit the peculiar features of the parent but resemble the original plants from which the parent 'sported.' For example, if in a batch of tomato plants bearing wrinkled inferior fruit, a single individual were observed with superior smooth round fruit, it would generally be found that a large number of the plants raised from the seeds of such 'seminal sport' would have wrinkled fruit and none at all or only a few would bear smooth fruit. When a new variety makes its appearance among crops propagated by seeds, it is generally necessary not only to simply grow it, but to take steps to 'fix' the variety, so that *all* the seedlings raised from it or from its descendants shall exhibit the peculiar characters which make it worth the special attention of the grower. To 'fix' and establish a new variety with constant characters from such 'seminal sports,' can only be attained by the following process of continued selection.

The seeds of the plant showing the new features are sown, and those individuals of the offspring possessing the same

peculiar characters as the parent are allowed to produce seed, all others being pulled out and discarded. The seeds of this first selected generation are then sown, and a further selection and sowing of those possessing the new attributes is made. This process is repeated for several generations until no weeding out is found necessary, that is until the new characters become constant in all the offspring, after which the variety is said to be ‘*fixed*’ and ‘comes true’ from seed. The time taken to ‘fix’ a variety in this manner depends upon the power which the plant possesses of transmitting its characters to its offspring. This power is exceedingly variable and no rules can be laid down in regard to it; in some instances 50 per cent. or more of the first generation may resemble the parent, and, on sowing the seeds of these, 90 per cent. of the seedlings may ‘come true’; in such cases fixation of a new variety is tolerably easy and may be effected in three or four generations. In other cases the number of plants true to type in each succeeding generation may be very small, and even after selection has been carried on for many generations a large proportion of the plants obtained at each sowing may possess none of the characters of the variety which the plant-breeder wished to establish.

H. Vilmorin stated that some of his hybrid varieties of wheat took six or seven years of cultivation and selection before they were of sufficiently fixed character to be put on the market for trial.

The process applied to five or six generations of plants is generally found to be sufficient to ‘fix’ many new varieties of cereals, beans, peas, cabbages, turnips, tomatoes and other annual and biennial plants; probably the raising and selection of a similar number of succeeding generations of plants would be needed to make a variety of a perennial plant ‘come true’ from seed. However, on account of the fact that several years often elapse before seed is produced by many seedling perennials, the process of fixing new varieties of such plants by selecting and propagating in the above manner has rarely been carried out;

hence all our varieties of apples, pears, strawberries, tulips, narcissus and many other cultivated plants do not 'come true' from seed; so far as their usefulness is concerned there is no necessity for them to do so, for the single original sport, when once obtained, may be propagated vegetatively by cuttings, runners, grafts and bulbs. Of course, varieties whose peculiar characters are not hereditary cannot be 'fixed' at all. Varieties which are the result of hybridisation often vary for many generations, and are generally difficult to fix. On this account when fixation is being attempted the several generations raised for the selective process should be protected or prevented as far as possible from crossing with other varieties and with the untrue seedlings.

Self-fertilisation or in-breeding, when not carried to an extreme, tends to fix the characters of new varieties.

(b) **Seminal or seedling varieties.**—As previously mentioned no two seedling plants are exactly the same; even when they are derived from seeds taken from the same pod they differ from each other in one or more particulars. It may be that the colour of the flowers is not exactly the same, or the form of the leaf, the thickness of the root, or the size and habit of growth of the stem may differ in different individuals. Where the variation from the common type is obvious and distinct we have termed the plant a 'seminal sport'; seedlings showing lesser deviations which are scarcely noticeable may be named '*seminal varieties.*' Between a 'seminal sport' and a 'seminal variety' there is no essential difference; it is a matter of degree of variation only.

These very slight indefinable deviations from the common type are of the utmost importance, for experience teaches that almost any one of them may be vastly increased by selecting and cultivating the plant in which the peculiarity is most marked in each successive generation; the development of the peculiarity and its fixation go on simultaneously in such cases.

For instance, if among a bed of plants whose flowers are

ordinarily yellow a single individual is observed whose flowers have a very faint tinge of red, it is often possible to raise and fix a distinctly red variety by selecting from each succeeding generation the plant in which the redness of petals is most marked. Not only can the tints of flowers be modified and increased, but almost all other characters, however they may appear at first in the selected plant, may be increased in a similar manner.

In 1890 E. v. Proskowetz sowed in good garden soil seeds of the wild sea-beet obtained from specimens growing on the south coast of France. All the seedlings had much branched roots like their wild parents, and sent up flowering shoots the same year in which the seeds were sown: the average sugar-content was low although it exhibited wide variation, namely, between 0.3 and 11.2 per cent.

The plants of this generation, with good sugar-content and with the least-branched and thickest roots were selected and their seeds sown. The majority of the plants of this selected second generation resembled their parents, but some of them behaved as biennials and sent up no flowering stems in the first year of their growth.

From these biennial forms a further choice was made and their seed sown; in consequence of the selection and good culture, the roots in 1893 had an average sugar-content of 15.93 per cent. and each had an average weight of 426 grams. In another series of selected plants the average sugar-content in 1894 was 16.99 per cent. and the average weight of a root 368 grams. Although the seeds of these plants still gave rise to a few annual plants resembling the original wild parents most of the seedlings proved to be biennials, and in form of root and amount of sugar greatly resembled some of the ordinary cultivated races of sugar-beet.

In order to determine to some extent how much of the increased sugar-content and size of the root was due to the better garden soil in which the plants were raised, and how much due

to the selection of the best forms and the rejection of the worst, another part of the garden was sown in 1890 with the wild seed and the plants were allowed to remain and sow themselves down year by year. The average sugar-content of the roots of the latter rose year by year: in 1893 it was 4·5 per cent., in 1894 9·38, their average weight in 1893 was 147 grams and in 1894 232 grams. By a comparison with the previous figures it will be seen that the process of selection had nearly doubled the sugar-content and very considerably raised the average weight of each root.

A. L. de Vilmorin by the selective process continued through four generations, obtained from the slender-rooted annual wild carrot (*Daucus Carota* L.) biennial plants having thick fleshy roots resembling some of the ordinary types of cultivated carrots in colour, form and size.

Professor J. Buckman is said to have raised the large hollow-crowned 'Student' parsnip from the small-rooted wild parsnip by a similar process of selection.

These may be taken as instances of the rapid modification of wild species by choosing and propagating by seed what are considered the best specimens of several succeeding generations, all other plants being rejected or destroyed.

Cultivated varieties now existing can be 'improved' or rendered more useful than they are at present in a similar manner, and generally more easily than wild species.

4. **Variations: how induced.**—From the foregoing account it will be understood that the improvement of plants depends primarily upon their variability; for if plants were all alike, and did not vary at all, there could be no selection. Moreover, in plants raised from seeds, the variation must be hereditary, for unless the peculiar quality or character possessed by a specially selected individual plant is passed on to the next generation, the selection becomes useless. For example, no progress can be made in the development of a stiff-strawed race from a kind of

barley or wheat with weak stems, by selecting and propagating an individual plant with rigid straw, unless such stiffness is transmitted to the descendants of the selected plant.

Which variations exhibited by plants are transmitted to their seedling offspring, and which are not, can only be determined by trial. The variations of plants and animals must arise from specific changes in the constitution of their protoplasm, but nothing definite is known of the nature of these changes, and to cause a plant to vary with certainty in some particular and desirable manner is at present impossible. Even to make a plant vary at all appreciably is often a matter of great difficulty, some species being very stable. However, when variation once begins, the desired character will sooner or later appear among the plants, so that the first step in plant improvement is to 'break the type,' or to make the type it is intended to improve vary in any manner whatever.

Since the variations of plants are the starting points from which improvement or modification begins, it becomes important to enquire if there are any methods by which variation can be induced.

Experience has taught that variation can be induced—

- (1) by varying the external conditions of life of the plant ;
- (2) by crossing and hybridisation.

It is well known that an abundance of manurial constituents leads to luxuriance of the various organs of a plant, while a reduction of these substances results in lowness of stature, and general diminution of all parts ; poverty or richness of soil, therefore, leads to variation among plants. Similarly, the intensity of the light, the warmth or coldness of the summer induces variations in sweetness of almost all kinds of fruit. The size of the grains of wheat, barley, and other cereals, and that of many seeds and other parts of plants, is also dependent on the cultivation of the ground in which they are grown, and upon the season and the length of time during which growth goes on : other external conditions

bring about changes in the structure and function of various organs of plants. Generally it may be said that variations of this kind, induced by changes in the amount of food-constituents in the soil, or by alterations of season and climate, are rarely, if ever, hereditary ; they appear under certain conditions, but when the conditions are altered the variations disappear.

For instance, by growing tall varieties of peas, beans, or any other plants upon poor soil, successive generations of short individuals may be obtained so long as the poverty of the soil is maintained ; the seeds of such plants, however, when grown upon good soil at once give rise to tall plants, showing that the dwarfness of habit induced by such soil conditions is not a permanent hereditary modification.

Wheat, oats, and other cereals, when grown upon good garden soils, at wide intervals apart, as has been done by some propagators, develop tall straw, long ears, and large grain, but no new permanent variety can be produced in this manner.

By growing beets possessing 'fanged' roots close together, they have no room to develop their disfiguring branches, and may thus be made to assume a good form ; nevertheless, seeds raised from such plants, when grown under ordinary conditions of cultivation, immediately give rise to plants with 'fanged' roots like their ancestors. When attempting to develop a new race of any kind of plant, it is therefore important that the modification taken as a basis upon which the selective process is carried out, should not have arisen merely as the result of external conditions.

Where increased size of certain organs is the feature desired in a new race, it is perhaps best to raise the successive generations of plants from which the selection is to be made upon a moderately poor soil, rather than a specially rich one ; any increased size of one plant over that of another under such circumstances would be less likely to be due to an accidental excess of manure, and more likely to be due to an innate hereditary quality of the plant.

The most certain method of inducing variation in a plant is to cross or hybridise it with another individual. In this process, there is a mixing of the protoplasm of two distinct plants, and the offspring therefore consists of living matter derived from two distinct and unlike sources. Sometimes the plants of the first and second generation obtained from such a cross all resemble each other very closely. Succeeding generations, however, exhibit very great variability, the plants showing the characters of the two original parents blended in very variable degree, and peculiarities not seen in the parents are very frequently observed among them. The latter characters although apparently new are often those possessed by the grandparents or earlier ancestors of the plant which have been transmitted in a latent state through several generations.

Variations which appear as the result of crossing are much more frequently hereditary than characters produced by the action of external conditions ; moreover, they can generally be increased by selection. Not only is crossing of use for the purpose of inducing variability among plants so that selection may be begun ; it is sometimes resorted to in order to combine in one variety of plant characters previously possessed only by two different and separate varieties. A tender variety which is of good quality in other respects when crossed with a hardy kind of poorer quality, sometimes gives rise to one or more descendants, combining the good quality of the former with the hardiness of the latter : similarly other qualities of two distinct varieties may be blended more or less satisfactorily, although in most cases much selection is needed to fix and augment the peculiarities of the new type thus obtained. The combination of certain peculiarities cannot be attained in one and the same plant by any means ; it is often better to grow one variety for one purpose and another for another purpose, rather than attempt the combination of antagonistic features (see next paragraph).

5. **Correlated variability.**—The various parts of the body of a plant or animal are so co-ordinated with each other that any change in the structure or function of one organ very frequently brings about some necessary change in another. The nature of the connection between the *correlated variations* is in many instances obscure; nevertheless the existence of this kind of variability must be always borne in mind by those who seek to improve plants. Moreover, it is important that every endeavour should be made to elucidate its nature, for a correct and complete understanding of the structural and functional relationships between the different parts of plants would enable the plant-breeder to save much valuable time. There is little doubt that through want of knowledge on such matters, plant-breeders have not unfrequently attempted to do that which is impossible.

In a great many cases quantity of produce and good quality are so connected that beyond a certain point the increase of one brings with it a decrease of the other and to combine both characters in one variety appears to be impossible. For example, all attempts to obtain a race of sugar-beet with very high yield of roots per acre and high sugar-content are found to fail when a certain percentage of sugar in the root is reached; with every increase of sugar-content beyond this point there is invariably a decrease in size and weight of the 'root.'

It appears to be impossible to breed a white wheat of rich gluten-content, with as high a yielding power of grain per acre as 'rivet' starchy wheat; this difficulty is partially dependent on the fact that the glutinous albuminoids are largely stored in the single layer of 'aleurion-cells' which become filled first, the central parts of the endosperm being filled up later chiefly with starch; the longer the assimilation goes on after the aleurion-layer is filled the more starchy the grain becomes, and the larger the crop.

Investigation has shown that thin-stemmed races of barley always give the best quality of grain for malting purposes, and to breed a variety combining very high quality of grain with great stiffness of straw is probably impossible.

It is generally known that seed-production and luxuriance of vegetative organs are mutually antagonistic; for example, with high yield of tubers of good quality, seed-production in the potato has been vastly reduced, and in the case of oats and wheat short-strawed varieties usually give a greater proportion of grain than long-strawed kinds. A turnip of slow, long-continued growth yields a greater dry weight per acre than a rapid-growing variety, for there is a greater time for the manufacture, accumulation and assimilation of food in the former than in the latter; the attempt to produce a variety of turnip of rapid growth and high feeding-value would fail after a certain point of excellence was reached; fortunately in this case there appears plenty of room for systematic work and improvement before the limit is attained, and the same is probably true of practically all farm plants for very few well-organised attempts have been made to improve them.

6. Reversion, 'throwing-back,' atavism: degeneration of varieties.—A new variety of a plant becomes gradually established and 'fixed' by destroying all those individuals of each generation which do not resemble the general type. 'Fixation' is, however, a relative term, for even in cultivated varieties in which the process of destruction has been systematically carried out and which have 'come true,' from seed during many generations, '*false plants*' or '*rogues*' departing considerably from the type appear among the offspring at irregular intervals.

For example, individuals resembling the wild pansy (*Viola tricolor* L.) in form, colour and size of the flowers and leaves, occasionally make their appearance among plants raised from seeds of the best large-flowered cultivated types of pansy; and

among crops of green-topped turnips, purple-topped individuals sometimes occur. 'Rogues' most frequently exhibit characters possessed by the ancestors of the variety in which they are found.

The tendency of plants to revert to long-lost characters is termed *atavism*, '*throwing-back*,' or *reversion*.

Very few if any varieties of plants propagated by seeds remain like the type first sent out by the raiser for more than a limited number of years. In a great many instances where almost everybody raises seed, destruction of 'rogues' is not efficiently or thoroughly carried out, and through the consequent mixing with the progeny of the reverted plants, the type rapidly degenerates in purity.

Apart from the incompetence to distinguish slightly reverted forms and laziness in carrying out their destruction, other changes take place in the type through the different ideal which each raiser of seed sets up before his mind when he selects the individuals to be employed as seed parents. For example, three different raisers of seed of 'Gubbins' "Incomparable" pea' are almost certain to hold different views from Mr Gubbins and from each other in regard to the relative importance of the various characters of a good pea; selection is therefore carried out from three different standpoints, and in a few generations the 'Incomparable' variety no longer exists except in name, unless Mr Gubbins himself also carries on the propagation: three different types bearing the same name would arise. It is therefore very necessary for the farmer and gardener not to be led away by the fascination of an old name, for it does not follow that anything useful is obtained with it; at the same time it must be remarked that a new name does not necessarily represent any new quality or character in the seeds to which it is applied; new names may easily be applied to old articles when the latter cannot be sold by their original names.

Much valuable experience can be gained by growing small

trial plots of several differently named varieties of farm and garden plants of the same species.

Moreover, a useful lesson can be learnt by sowing small plots of seeds of a variety of turnip, pea or other plant bearing the same name and obtained from half a dozen different firms of seedsmen. Farmers rarely do enough testing of this kind.

PART IV.
CLASSIFICATION AND SPECIAL BOTANY
OF FARM CROPS.

CHAPTER XXIV.

THE CLASSIFICATION OF PLANTS.

1. **SYSTEMATIC** or Classificatory Botany is concerned with the naming, describing and arranging of plants into groups.

Various systems of classification have been proposed from time to time, the one which has superseded all others being the so-called Natural System. Underlying it is the assumption that all the different kinds of plants on the face of the earth have been derived by natural descent from a few ancient ancestors, and the object of this system is the arrangement of plants into groups according to their affinity or blood-relationship.

The evolutionary history and genetic affinity of plants can never be known accurately, and there are no universal rules by means of which the relationship of organisms can be determined with certainty. However, in forming the groups into which the Vegetable Kingdom is divided, botanists endeavour to take into consideration as many peculiarities or characters of the plants as possible, and place together only those which agree in a number of characters: it is reasonably contended that by this method plants which are related to each other by descent are likely to be brought together.

2. The terms employed to denote the different groups are indicated below.

Individual and species: variety and race.—When a red clover seed is sown and allowed to grow it produces a single plant, which after a time gives rise to a number of seeds, each of which can grow and produce offspring similarly, so that in a few years a very large number of individual red clover plants may be obtained. It will be found that these individuals, although not exactly like each other, are nevertheless very similar in the form, colour, size and other features of their roots, stems, leaves and flowers. Such plants, and all those upon the face of the earth which resemble them to such an extent that they may be considered to have descended from a common ancestor, are grouped together by botanists, the whole group being termed a *species*.

While the majority of the characters possessed by the various organs of a species are constant, certain features, such as the hairiness of the leaves and stems, or the colour of their flowers, may vary: thus we may find in a field of red clover, plants bearing white flowers instead of purple ones: such are described as *varieties* of the red clover species. The peculiar characters of a variety are usually transmitted to few or none of its descendants.

Varieties presenting some considerable variation from the most prevalent characters of the species are termed *sub-species* or *races* when the variation is known to be hereditary for many generations.

Many of our cultivated crops are permanent varieties, or races developed by the process of selection (see chap. xxiii.) from wild species.

Genus: plant-names.—Even cursory examination of the various species of plants commonly met with, reveals the fact that a certain number of them resemble each other, especially in the form, arrangement and number of the parts of the flower. Thus, red clover, Alsike clover and white clover, although differing from each other in the colour of their flowers and in the

shape, size and habit of their vegetative organs, are nevertheless very similar in the construction and form of their flowers. Species possessing such close resemblances in the structure and arrangement of their reproductive organs are grouped together and are spoken of as a *genus*.

The scientific or botanical name of a plant consists of two Latin words, the first of which indicates the genus and the second the species to which the plant belongs. For example, the true clovers constitute the genus *Trifolium*, the species red clover being named *Trifolium pratense*, while Alsike clover is known as *Trifolium hybridum*. Similarly the various species of buttercups collectively form the genus *Ranunculus*, two common species of the genus being *Ranunculus repens* (creeping crowfoot) and *Ranunculus bulbosus* (bulbous buttercup).

As the same species has sometimes been named differently by different botanists and the same name has not uncommonly been used for two or more distinct species, to prevent confusion it is customary in systematic works to add to the name of the plant the full or abbreviated name of the botanist who gave the plant its name and described it.

For example, the name *Bellis perennis* Linn. or *Bellis perennis* L., indicates that Linnæus gave the name and it also implies that the plant denoted is the particular species which Linnæus described under this name.

Just as species are grouped into genera, so are genera resembling each other grouped into **Orders** or **Families**.

Orders possessing similar characters form **Classes**, and classes having common distinctive characters are finally grouped together into **Divisions**.

Where some of the representatives of a Genus, Order, Class or Division possess characters which mark them off more or less distinctly from the rest of the group to which they belong, it is sometimes useful to subdivide these groups into Sub-genera, Sub-orders, Sub-classes and Sub-divisions.

3. The following are the chief Divisions of the Vegetable Kingdom:—

- Division I. **Myxomycetes.**
- „ II. **Thallophyta.**
- „ III. **Bryophyta.**
- „ IV. **Pteridophyta.**
- „ V. **Spermaphyta.**

The plants included in the first four divisions are often spoken of as **Flowerless plants** or **Cryptogams**. Among them reproduction is carried on chiefly by means of minute one-celled bodies termed *spores*, which are set free from the parent plant and afterwards germinate and give rise to new plants.

The Spermaphytes (Division V.) were formerly designated **Flowering plants** or **Phanerogams**. In these, reproduction is carried on chiefly by means of seeds, each of which contains an embryo-plant.

Division I.—The **Myxomycetes** are commonly known as *slime-fungi*. In a vegetative state the bodies of these organisms consist of naked masses of protoplasm termed *plasmodia*, and are capable of creeping about in a manner similar to the movement of an ordinary amœba. The Myxomycetes are devoid of chlorophyll, and almost entirely saprophytic, that is, they feed mainly upon decaying organic remains, many species being common upon rotten wood and dead leaves. In several respects they greatly resemble the lowest forms of the animal kingdom, and are by some authorities included in the latter and spoken of as Mycetozoa, or *fungus-animals*: their method of reproduction by means of spores is, however, similar to that prevalent among certain Fungi.

One organism generally included in this division and described in chapter I., is parasitic, and the cause of the disease known as ‘Finger-and-toe’ or ‘club-root’ among turnips and cabbages.

Division II.—The **Thallophytes** are plants, such as sea-weeds,

lichens and toad-stools, the bodies of which are of simple construction and exhibit no differentiation into stem, root and leaf. When branching does take place, the members produced are usually all essentially alike, and resemble the previously existing parts from which they arise: the body of a plant of such simple structure is termed a *thallus*. In some instances each plant is very minute, being merely a single cell, while in others, the thallus consists of thousands of cells: in all cases, however, the cells possess a distinct cell-wall.

The Thallophytes are divided into several sub-divisions of which two, namely, the *Schizophyta* and the *Fungi* are of great practical importance: the former includes the *Bacteria* or *Schizomycetes*.

Division III.—The **Bryophytes** comprise two classes of plants, namely, liverworts and mosses.

Division IV.—The **Pteridophytes** include ferns, horsetails and club-mosses.

Some of the above divisions of the Vegetable Kingdom, such as those including the sea-weeds, mosses and ferns, are without practical interest or importance for the farmer, and want of space prohibits more than a mere mention of their existence. Students wishing for information in regard to those divisions are referred to the ordinary text-books of systematic botany.

The *Bacteria* and *Fungi*, however, which are included in the Thallophyta, need special attention on account of their practical bearing, and are dealt with in subsequent chapters.

Division V.—The **Spermaphytes** or **Phanerogams** include all those plants which produce seeds. This division is split up into two sub-divisions namely:—

Sub-division 1.—**Gymnosperms.**
and Sub-division 2.—**Angiosperms.**

In the Gymnosperms, of which the cone-bearing firs and pines are examples, the carpels are flattened structures and the ovules

and seeds lie naked or exposed on the surface of the latter: fertilisation is effected by pollen-grains which come into direct contact with the micropyle of the ovule.

The Angiosperms possess carpels which are hollow closed structures, the ovules and seeds being developed within the completely closed cavity or ovary of the carpels. In these plants the pollen-tube must first pass through the tissues of the carpels before reaching the ovule.

4. As practically all farm plants belong to the Angiosperms it is important to enter into greater detail in regard to the classification of this sub-division of the Vegetable Kingdom. The following is an outline of the arrangement and chief features of the Classes, Sub-classes, and a few common Orders included in it.

Sub-division 2.—ANGIOSPERMS.

Class I. Dicotyledons.—In these plants the embryo has two cotyledons and the floral-leaves are usually in fours or fives. In a cross-section of the stem the vascular bundles appear arranged in a single ring round a central pith and in perennial species concentric zones or 'annual rings' of wood are present, the 'annual rings' being formed by a cambium-tissue. The leaves are generally net-veined.

Sub-class I. Choripetalæ.—The corolla when present is poly-petalous.

In some plants of this sub-class the flowers are imperfect; either the corolla or calyx is absent or both parts of the perianth are missing.

(1) *Flowers regular, hypogynous, usually with a single green or white perianth: fruit one-seeded.*

Order. *Cannabaceæ* (see p. 331).

Order. *Polygonaceæ*.—Flowers small with a perianth of three to six free segments: stamens five to eight opposite the perianth segments; gynæcium of two or three united carpels, the ovary generally triangular or oval in section, and containing a single

erect ovule; fruit an angular nut; seed endospermous. The stems are mostly herbaceous and bear alternate leaves, which possess membranous tube-like stipules (the *ochreae*) clasping the stem. Common plants of this Order are Dock and Sorrel (*Rumex*), Knot-grass (*Polygonum aviculare* L.), Black Bindweed (*Polygonum Convolvulus* L.), and Buckwheat (*Polygonum Fagopyrum* L.).

Order. *Chenopodiaceae*.—This Order which is described in chapter xxvi., possesses close affinities with the *Caryophyllaceae* mentioned below.

(2) Flowers, usually with both calyx and corolla present.

(a) Flowers hypogynous: gynæcium apocarpous.

Order. *Ranunculaceae*.—Flowers mostly regular, with free sepals, numerous stamens and one or many free carpels. The fruit is an achene or a follicle. Most plants of the Order are herbaceous and contain acrid poisonous juices. Common examples are Buttercups (*Ranunculus*), Columbine (*Aquilegia*), Monkshood (*Aconitum*), and Anemone.

(b) Flowers hypogynous: gynæcium syncarpous.

(i) Ovules on a free-central placenta.

Order. *Caryophyllaceae*.—Flowers regular with four or five persistent sepals and the same number of petals: stamens usually eight or ten; fruit a capsule with one or many endospermous seeds. The stems have opposite leaves and thickened nodes and the flowers are generally pink or white. Common examples are Pinks and Carnations (*Dianthus*), Campions (*Lychnis*), Chickweed (*Stellaria*), and Spurrey (*Spergula*).

(ii) Ovules on parietal placentas.

Order. *Papaveraceae*.—Flowers regular with two sepals, four petals and many stamens. Fruit a capsule dehiscent by pores and containing many small endospermous seeds. Plants belonging to this Order contain milky or coloured latex and are often poisonous: poppies are common examples.

Order. *Cruciferae* (see p. 363).

(iii) Ovules on axile placentas.

Order. *Linaceae* (see p. 389).

(c) Flowers perigynous : gynæcium superior and apocarpous.

Order. *Rosaceæ* (see p. 387).

Order. *Leguminosæ* (see p. 408).

(d) Flowers epigynous : gynæcium inferior and syncarpous.

Order. *Umbelliferæ* (see p. 439).

Sub-Class II. Sympetalæ.—Corolla gamopetalous.

(1) *Flowers hypogynous.*

(a) Corolla regular.

Order. *Boraginaceæ*.—Flowers with a five-lobed calyx and a five-lobed corolla; stamens five; gynæcium of two united carpels; the ovary is four-lobed and four-chambered with a single ovule in each chamber; fruit a schizocarp which splits into four nut-like mericarps. Examples of plants belonging to this order are Comfrey (*Symphytum*), Borage (*Borago*), and Forget-me-not (*Myosotis*).

Order. *Solanaceæ* (see p. 454).

(b) Corolla irregular zygomorphic.

Order. *Scrophulariaceæ*.—Flowers with a five-lobed calyx and a four- or five-lobed corolla; stamens epipetalous, generally four, with a rudimentary fifth; gynæcium of two united carpels; ovary two-celled; fruit a capsule, containing many endospermous seeds. Common representatives of the order are: Snapdragon (*Antirrhinum*), Foxglove (*Digitalis*), Speedwell (*Veronica*), Yellow-Rattle (*Rhinanthus*), and Eyebright (*Euphrasia*).

Order. *Labiataæ*.—Flowers with a five-partite ribbed calyx, and a two-lipped zygomorphic corolla; stamens two or four, didynamous, epipetalous; gynæcium of two united carpels; ovary four-celled, with one ovule in each cell; fruit a schizocarp splitting into four nut-like mericarps. The stems of the plants are four-angled, and bear opposite or whorled leaves. Common examples are Mints (*Mentha*), Self-heal (*Brunella* or *Prunella*), Dead-nettle (*Lamium*).

(2) *Flowers epigynous.*

Order. *Compositæ* (see p. 468).

Class II. Monocotyledons.—The embryo of these plants has only a single cotyledon, and the floral-leaves are in threes or fours, never in fives. A cross-section of the stem shows a number of isolated vascular bundles, not in a single ring but usually scattered and without any distinct central pith: no cambium is present in the stems. The leaves are usually parallel-veined.

(1) *Perianth absent or represented by small scales or bristles.*

Order. *Gramineæ* (see p. 473).

Order. *Cyperaceæ*.—Flowers unisexual or bisexual, arranged in spikelets, each flower in the axil of a small bract (glume). Perianth none or consisting of three to six bristles; stamens generally three; gynæcium syncarpous, with a one-celled ovary and a single style, with two or three simple filamentous stigmas; ovule one, erect. The fruit is a three-sided or flattened nut containing a single endospermous seed which is generally free from the pericarp. The plants of this Order are often confused with grasses, but have mostly solid triangular stems and entire leaf-sheaths.

Common examples are the Bulrush (*Scirpus*), Cotton-grass (*Eriophorum*), and Sedge (*Carex*).

(2) *Perianth present and regular.*

(a) Gynæcium superior.

Order. *Liliaceæ*.—Flowers with a six-partite coloured perianth: andrœcium of six stamens.

Common plants belonging to the Order are Lily-of-the-valley (*Convallaria majalis* L.), Ramsons (*Allium ursinum* L.), and other species of 'Garlic' (*Allium*), Hyacinth, Tulip and Meadow Saffron (*Colchicum autumnale* L.).

Order. *Juncaceæ*.—Flowers small with a six-partite green or brown perianth, andrœcium usually of six stamens. Fruit, a one- or three-celled capsule.

Common examples of the Order are various species of Rush (*Juncus*) and Wood-rush (*Luzula*) (see p. 609).

(b) Gynæcium inferior.

Order. *Irideæ*.—Flowers with a six-partite brightly coloured perianth: andrœcium of three stamens, the anthers of which open outwards; gynæcium syncarpous, three-celled, the simple style often surmounted by three leaf-like coloured branches on which are the stigmas. Fruit a capsule containing endospermous seeds. Common plants of the Order are Yellow flag (*Iris Pseud-acorus* L.), Crocus and Gladiolus.

Order. *Amaryllideæ*.—Flowers with a six-partite coloured perianth: andrœcium of six stamens, the anthers of which open inwards. The gynæcium and fruit resemble those of the *Irideæ*. Common examples are Daffodil (*Narcissus*) and Snowdrop (*Galanthus*).

(3) *Perianth present, epigynous, and zygomorphic.*

Order. *Orchideæ*.—Flowers irregular, generally with one stamen, which is united to the style. Gynæcium inferior, ovary mostly one-celled with parietal placentas. The fruit is a capsule containing a large number of very minute seeds. Common examples are Purple Orchis (*Orchis mascula* L.), Spotted Orchis (*Orchis maculata* L.) and Tway-blade (*Listera ovata* L.).

Ex. 172.—Students should describe as many common plants as possible, taking their parts in the order indicated below.

(i) *Habit and general appearance.*—Whether annual, biennial or perennial; herbaceous or woody.

(ii) *Root.*—Fibrous or with a distinct tap-root; presence or absence of adventitious roots.

(iii) *Stem.*—Herbaceous or woody; erect, decumbent, prostrate, or winding, &c.; shape in transverse section, square, round, ribbed, &c.; hairy, spiny, with harsh or hispid hairs, or glabrous: colour.

(iv) *Leaf.*—Radical or cauline; opposite, whorled or alternate; simple or compound; if compound, pinnate or palmate; stipulate or exstipulate; sessile or petiolate; shape of blade or leaflets; character of the margins and tips; smooth or hairy surfaces.

(v) *Inflorescence.*—Definite or indefinite; kind; presence or absence of bracts and bracteoles.

(vi) *Flower.*—Complete or incomplete; regular or irregular; zygomorphic or actinomorphic.

(vii) *Calyx*.—Inferior or superior ; polysepalous or gamosepalous ; number and form of the sepals or lobes of the calyx.

(viii) *Corolla*.—Hypogynous, perigynous or epigynous ; polypetalous or gamopetalous ; number, form and colour of petals or lobes of corolla.

(ix) *Andræcium*.—Hypogynous, perigynous, epigynous or epipetalous ; free, monadelphous, diadelphous, polyadelphous or syngenesious ; di- or tetradynamous.

(x) *Gynæcium*.—Superior or inferior ; apocarpous or syncarpous ; number of carpels, styles and stigmas ; if syncarpous, whether ovary is one, two or more celled ; ovules on axile, parietal or free central placentas.

(xi) *Fruit*.—Dry or succulent ; indehiscent, splitting or dehiscent ; kind.

The following may be taken as an example of plant description :—

Bulbous buttercup (*Ranunculus bulbosus* L.).

Habit.—A hairy perennial with bulbous rootstocks, erect stems about a foot high, divided leaves and yellow flowers ; common in meadows and pastures.

Root.—Fibrous.

Stem.—Herbaceous, lower part bulb-like, branches erect ; peduncles furrowed.

Leaves.—Radicle and cauline ; cauline leaves alternate ; simple, exstipulate ; lower leaves with long petioles ; upper leaves cut into narrow segments ; the blade cut irregularly into three lobes which are tri-partite.

Inflorescence.—Definite ; the main axis and its branches, each end in a single flower.

Flower.—Complete, actinomorphic.

Calyx.—Inferior, polysepalous, five sepals, reflexed.

Corolla.—Hypogynous, polypetalous, five petals, yellow, each petal with a nectary at its base.

Andræcium.—Hypogynous ; stamens free and indefinite.

Gynæcium.—Superior, apocarpous, carpels many spirally arranged on a conical receptacle.

Fruit.—Many free achenes.

Ex. 173.—After describing the plant as in previous Ex., their position in the Vegetable Kingdom should be assigned in accordance with the following scheme :—

- (i) *Division*.
- (ii) *Sub-division*.
- (iii) *Class*.
- (iv) *Sub-class*.
- (v) *Order*.
- (vi) *Genus*.
- (vii) *Species*.

The position of the bulbous buttercup is represented thus :—

Division : Spermaphyte.

Sub-division : Angiosperm.

Class : Dicotyledon.

Sub-class : Choripetalæ.

Order : Ranunculaceæ.

Genus : *Ranunculus*.

Species : *bulbosus*.

CHAPTER XXV.

CANNABACEÆ.

1. **General characters of the Order.**—Flowers unisexual; dioecious.

Male flowers with a five-leaved perianth and androecium of five stamens, the filaments of which are erect in the flower-bud.

Female flowers hypogynous, with a small entire cup-shaped perianth surrounding the ovary. The gynæcium possesses a one-celled ovary with a single ovule within; stigmas two, deciduous, long and papillose. Fruit, a form of nut, dry, indehiscent, containing a single, pendulous seed. Seed with a curved or spirally-rolled embryo and very small reserve of endosperm.

This is a very small Order containing but two genera and three species. It is often treated as a sub-order of the Urticaceæ or nettle family. The flowers are wind fertilised.

The plants representing the whole Order are—**The Common Hop** (*Humulus Lupulus* L.); **Japanese Hop** (*Humulus japonicus* Sieb. et Zucc.); and **Hemp** (*Cannabis sativa* L.).

2. **The Japanese Hop** (*Humulus japonicus* Sieb. et Zucc.) is an annual sometimes grown in gardens as an ornamental climbing plant on account of its rapid growth. It resembles the Common Hop in its stems and leaves, but the female inflorescences or strobiles contain no ‘lupulin’ and are consequently useless for brewing purposes.

3. **The Common Hop** (*Humulus Lupulus* L.) is a perennial herbaceous plant, cultivated almost entirely for the female inflorescences, which are employed in the manufacture of beer. It is probably indigenous in the British Isles, but most of the

so-called wild hops so frequent in the hedges in the south of England, are no doubt generally escapes from cultivation or seedlings from cultivated plants in the neighbourhood.

The short young shoots are occasionally utilised as a substitute for asparagus, and from the 'fibre' of the stem a coarse kind of cloth can be made, but these uses of the plant are of no practical importance.

SEED AND GERMINATION.—In autumn the female inflorescences or 'hops,' if left on the plants, readily break up, and the bracts (mentioned below) to which the fruits are attached are carried some distance by the wind. The single seed within each fruit contains a spirally curved embryo, which germinates only after a rest during the winter. In spring the young plants appear above ground, and possess two narrow strap-shaped cotyledons (Fig. 103).

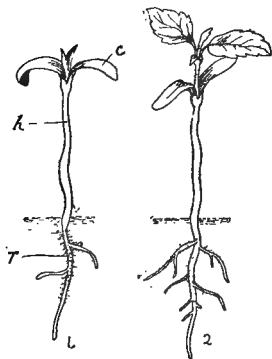

FIG. 103.—1. Seedling hop, one week old. 2. The same, two weeks old.
r Root; h hypocotyl; c cotyledon.

ROOT.—The primary root of a seedling hop produces several branches which soon equal it in

thickness. From all the thicker roots a great abundance of hair-like fibrils are given off.

A striking feature in both old and young plants is the exceedingly large root-system which they possess in comparison with the parts which come above ground. The thicker roots are covered with a mass of loose reddish-brown bark. Some of them penetrate to very great depths in the ground, entering cracks and openings wherever the subsoil is rocky; others remain nearer the surface, and spread horizontally in the upper layers of the soil, giving rise at the same time to an enormous number of fine fibrils. Adventitious roots are abundant on the underground stems.

THE STEM.—The stems, which are generally termed ‘bines,’ are herbaceous, angular and hollow, and of variable colour, being, in some varieties, purplish-red, in others pale green, or green streaked with red. They make their appearance in spring from buds of the underground perennial ‘rootstock’ or rhizome, and die down in autumn. The lower part, however, of each ‘bine’ below ground does not die, but thickens and forms a further extension of the ‘rootstock.’ The ‘sets’ used in propagating the plant are these thickened underground parts of the stems; they are cut off the parent plant in spring, and readily form adventitious roots when planted. The herbaceous stems above ground bear thin opposite lateral branches, which are of considerable length about the middle of the main stem. It is upon the lateral branches that the female inflorescences are produced, hence their formation and preservation is of the utmost importance to the hop grower.

The stems, although too weak to stand erect by themselves, are able to wind round any support such as a pole, a piece of stretched string or wire, or another plant placed near them, and frequently reach in this manner a height of 25 or 30 feet. In ascending a support the free tip of the stem slowly moves round in a circle, from left to right, in the same direction as the hands of a watch. The most rapid growth in length takes place when the support is upright, and in stems growing erect the internodes are longer than upon stems which are allowed to grow along a string inclined away from the vertical. The growth continues for a longer period, and is more even in its rate on sloped supports than on erect ones. When the support is inclined at an angle of between 45 and 60 degrees away from the vertical, the stems are unable to climb satisfactorily without external aid, their tips needing to be trained or assisted to wind, otherwise they hang away from the support. In all kinds of hop, but especially in the wild and coarse cultivated varieties, the stems and also the leaf petioles and main ‘veins’ have

several lines of strong hooked hairs which make the plant rough to the touch, and help it to cling to its support.

THE LEAF.—The hop has opposite leaves which vary considerably in shape even on the same stem. To some extent the variation depends upon the position on the stem and the age and variety of the plant. Upon young seedlings and on the youngest upper branches of older hops they are mostly cordate, with a deeply serrated margin. On older parts the leaves are large and broad, generally palmately three or five lobed, with deep acute serrations. Each possesses a petiole about half as long as the blade, and is stipulate; the stipules of opposite leaves are united and broadly triangular.

THE INFLORESCENCE AND FLOWERS.—The hop plant is dioecious, the male flowers, growing upon one individual plant, while the female ones occur upon another. Occasionally examples are found which are monœcious, that is, both kinds of flowers are present upon the same plant.

a. The inflorescences bearing the male flowers are much branched cymose panicles, which grow either from the axils of the main stem or from the axils of the lateral shoots.

Each **MALE FLOWER** is about a quarter of an inch in diameter, and possesses a five-leaved sepaloid perianth, opposite which are five stamens. The latter have very fine short filaments and long anthers, which dehisce by slits opening most widely at the apex (*st*, Fig. 105).

b. The inflorescences of female flowers somewhat resemble fir cones in external appearance, and are borne on branches which arise either directly from the leaf axils of the main stem itself or from the axils of the leaves upon lateral shoots produced by the main stem. They are spoken of as *strobiles* (A, Fig. 104), and are the 'hops' of commerce.

A fully developed strobile when ripe possesses a long central axis covered with fine downy hairs, and is popularly termed the '*strig*' of the 'hop' in Kent (B, Fig. 104).

Upon opposite sides of the latter are alternate pairs of 'stipular bracts' (*sb*) which appear to form four rows along its entire length. Each pair of these 'stipular bracts' is in reality a pair of stipules belonging to a leaf which has not developed a blade. In some hops, however, notably the coarser varieties, an excess of nitrogenous manure leads to the monstrous development of the missing leaf-blades and the scaly bracts of the hop strobile appear interspersed with small green leaves, a pathological condition which is to be avoided.

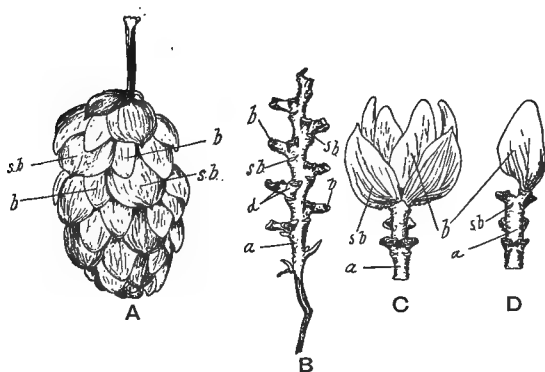

FIG. 104.—A, Hop strobile or female inflorescence. *sb* 'Stipular bract'; *b* bracteole.

B, Axis of the strobile (the 'strig'). *a* The main axis; *d* the cymose branches of the axis on which the female flowers are borne; *sb* point of insertion of 'stipular bract'; *b* point where bracteoles are attached (see D).

C, Piece of axis of the strobile showing the disposition of the 'stipular bracts' *sb*, and the bracteoles *b*.

D, Same as C, with the stipular bracts and one bracteole removed.

In the axil of the true bract, and therefore appearing to arise at a point on the main axis opposite the gap between a pair of its stipules, is a very short cymose axis (*d*) upon which four female flowers arise. Each flower is subtended by a *bracteole* (*b*) whose base partially envelops the former.

The bract-like stipules and bracteoles are popularly termed 'petals' by hop growers.

The FEMALE FLOWER is very minute (4, Fig. 105), and possesses a cup-shaped perianth (*c*) with an entire edge. The ovary is superior, and contains a single pendulous seed. Two long stigmas (*s*) are present, each covered from end to end with small elongated papillæ.

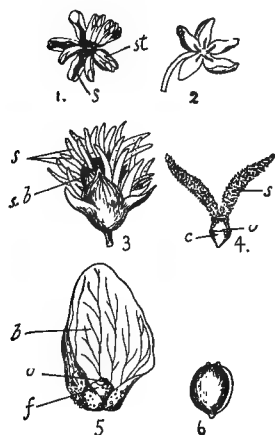

FIG. 105.—1. Single male flower of the hop. *s* Perianth (sepal); *st* stamen.

2. Perianth of male flower with anthers of the stamens removed; the short filaments are visible.

3. Very young female inflorescence or 'hop' in 'burr.' *sb* Stipular bract; *s* stigmas, the 'brush' of the flowers (see 4).

4. Complete female flower. *c* The entire cup-like perianth; *o* ovary; *s* stigma.

5. A bracteole (*b*) surrounding the ripe fruit. *f* The corolla; *o* apex of fruit.

6. The ripe fruit (a nut).

The FRUIT (6, Fig. 105) is oval, about the size of a white mustard seed, indehiscent, and generally described as a nut, although it is superior.

The SEED possesses a curved embryo and a very small amount of endosperm. When the strobile or female inflorescence is very young the 'bracts' are small and scarcely visible except those near its base. The stigmas of the flowers, however, are very conspicuous, and form the so-called 'brush' of the hop.

The plants are said to be 'in burr' when the strobiles have reached this stage of development.

Soon afterwards the stigmas constituting the 'brush' drop off, and about the same time a rapid growth of the bracts takes place. The strobile

then begins to assume its characteristic shape of a fir-cone, and at this period the plant is said to be 'in hop.'

Although the bracteoles develop to a considerable extent and the hop 'grows out,' even when the flowers in their axils are unfertilised and abortive, nevertheless the largest bracteoles in a 'hop' are those in whose axils fertile fruits are present: the fertilisation of the ovule, to a certain extent, stimulates the growth of the bracteole subtending the flower.

The 'Lupulin'-Glands of the Hop. — In the interior of a full-grown hop strobile are seen a large number of golden-yellow pollen-like grains attached to the outer surface of the bracteoles, especially near their bases. The perianth surrounding the fruit is also studded with them, and a smaller number are present upon the bases of the bract-like stipules. They are not met with upon the ordinary leaves or stems of the plant. When hops are shaken or knocked about these small grains are easily detached, and may be obtained in the form of a bright yellow powder sometimes spoken of as 'hop-meal' or '*lupulin*.' Among hop-growers this powder is often designated the 'condition' of the hop, and so far as a brewer is concerned the chief value of a sample depends upon the amount and nature of the 'hop-meal' present in it, all the rest of the hop, such as its axis, bracts, and fruits, having little more than an indirect and comparatively small value in the production of beer.

In an unripe 'hop' the 'lupulin' particles are brilliant and transparent, of a golden yellow hue. As the 'hop' ripens they lose their transparency, becoming opaque, and assume a pale sulphur or citron yellow colour. This change in transparency of the 'lupulin,' which is easily observed with a pocket lens, is the best criterion of the ripeness of a hop. In practice hops are generally picked unripe; they should, however, be left until a few opaque citron yellow particles are seen interspersed among the transparent ones on the lower bracteoles.

When rubbed between the finger and thumb, the 'lupulin' feels oily, and emits a characteristic odour which, in the best varieties, is somewhat pleasant, while in the less valuable coarser kinds the odour resembles that of garlic.

Each particle of 'hop-meal' or 'lupulin' has the form and structure given in Fig. 106. It originates from a single epidermal cell, and at the time the 'hop' is just showing the 'brush,' appears in the form of a hollow cup supported on a very short stalk, consisting of two or three cells (2, Fig. 106). The cup is

one cell thick, and each cell possesses a thick cuticle, dense protoplasmic contents, and a well marked nucleus. Before the hop has quite assumed its cone-like shape, the cells of the cup begin to produce a *secretion* which collects *within the substance*

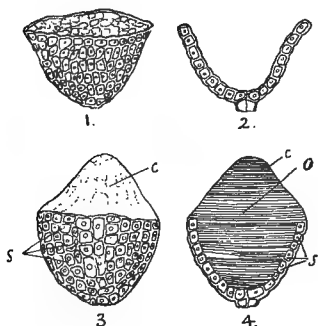

FIG. 106. — Lupulin-gland of the hop (magnified).

1. On very young hops in 'burr' stage.
2. Vertical section of 1.
3. Fully developed gland. *s* Secretory cells; *c* cuticle.
4. Vertical section of 3. *s* Secretory cells; *c* cuticle; *o* cavity filled with resin and oily contents.

of the upper cell-wall of each cell, and gradually lifts up the cuticle much as the skin is lifted up by matter in a blister.

As more and more of the secretion is poured out by the secretory cells the hollow space of the cup becomes filled up with it, and the cuticle which covers the secretion as a fine thin skin is bulged out above the margin of the cup, as at Fig. *c*, 106. The outline of the cells is seen upon the cuticle.

The whole structure arises from the epidermis of the bracts, and is a form of multicellular hair.

On account of its power to secrete it is termed a *gland* or *glandular hair*. The connection of each gland with the surface of the bract is very small and delicate—only the width of one or two cells—consequently they are readily broken off when touched.

By rough treatment on the hair-floor where the hops are dried, and also by careless shovelling when on the 'cooling' floor, the hops often become broken, and a considerable loss of these valuable glands takes place. For the nature of the secretion contained in the glands, see p. 345.

VARIETIES.—So far as names are concerned a very large number of varieties of hops are grown in England. Many of them, however, exist only in name, the same variety passing under dif-

ferent names in different localities or on distinct farms. Only a small number of distinct kinds are in existence; they vary in length and colour of 'bine,' hardness, period of ripening, and quality of the 'hop.'

A Good Hop.—The undermentioned points are of importance in estimating the quality of any variety of hop in a natural fresh state:—

(1) The yield should be good, and the plant should be hardy and capable of resisting the attacks of mould and aphid.

(2) The 'lupulin'-content of the strobiles should be high; the ratio of the weight of the 'lupulin' to the weight of the rest of the strobile (its 'petals,' axis and fruits) should be as great as possible.

(3) The aroma should be fine. It is not possible to define this point, but it must be observed that the best prices are only paid for those hops whose odour is agreeable and free from any smell resembling that of onions or black currant shoots.

(4) In the best varieties the stipular bracts of the strobile are generally smooth and broad, while those of the coarser less valuable kinds, with poor aroma, are narrow and almost always ribbed, appearing as if puckered or crumpled.

(5) The stipular bracts and bracteoles in the fine varieties are thin and firm, and packed closely upon the axis of the strobile. The more 'petals' per inch of 'strig' or axis the better the 'hop.' The axis should be thin, and the fewer the matured fruits with seeds within them the better, as the seeds are said to impart an unpleasant flavour to beer.

(6) When quite ripe the *natural* colour of those varieties which sell for the highest prices is a pale golden yellow with a faint tinge of orange: the less valuable early sorts are deeper yellow with darker greenish stipular bracts.

In order to preserve the 'hops' after picking they are dried in specially-constructed kilns, and during the drying process are subjected to the action of the fumes of burning sulphur (sulphur

dioxide gas), which bleaches and very considerably modifies their natural tint: the greatest alteration, due to this treatment, takes place in unripe hops. The colour of English commercial samples is therefore unlike that of the natural hop.

The following are the chief kinds of hops grown in this country:—

A. Early Varieties—

Prolific and Meopham.

These hops have red bines, and long coarse strobiles of poor quality which, when ripe, have a somewhat orange or brownish tinge. They yield good crops, and usually ripen in the order given.

Early Hobbs'.—An early hop resembling the Prolific, but smaller with a green bine.

Henham's Jones.—An oval medium-sized hop, thin in 'petal' and poor in lupulin, but of good colour and aroma. This name is often applied incorrectly to the Meopham and similar coarse hops.

Bramling.—This is an early variety of good quality, and is the kind most extensively grown for early picking in the best hop districts. The strobile is firm and compact, of medium length, roundish in cross-section, and the stipular bracts and bracteoles are broad and rounded at the tip. The yield is moderate.

White's Early.—This and the Bramling are the only early varieties of good quality. White's Early is a superior kind, exceptionally early, but usually a poor cropper: the 'petals' are thinner and paler than those of the Bramling, and the strobile not so long. The tip of the strobile is generally open and loose.

B. Mid-Season or Main Crop Varieties—

Rodmersham or Mercer's Hop; Cobb's Hop.

These are comparatively modern varieties of medium quality, hardy and good croppers. They resemble the Canterbury White-

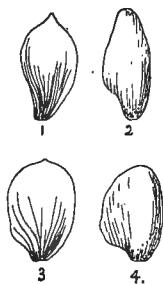

FIG. 107.—1. 'Stipular bract.' 2. Bracteole of Fuggle's Hop. 3 and 4. The same of Bramling Hop.

bine hop in form and were derived from this variety. Both are pale in colour with thin petals.

They are usually ready to pick after Bramblings and before the Canterbury Whitebines.

Canterbury Whitebine ; Farnham Whitebine.

These two strains of hop, grown originally in the neighbourhood of Canterbury in Kent and around Farnham in Surrey respectively, are apparently the same variety, no differences, so far as botanical features are concerned, being noticeable.

They take the first place among hops for quality and also yield good crops on deep rich soils. They are, however, somewhat delicate in constitution.

The 'bine' is pale green, often slightly mottled with red streaks. The strobiles are medium-sized, roundish-oval in shape, with smooth thinnish 'petals' which, when ripe, are a pale golden-yellow colour.

The former variety has several names : it is grown on the best hop ground in East Kent.

The Golding.—At the end of the 18th and beginning of the 19th century a hop known as the Golding was largely grown. It was stated by Marshall in 1798 to have been selected from the Canterbury Whitebine hop by a Mr Golding, living near Maidstone. The true Golding hop is larger than the Canterbury Whitebine variety, and grows more singly on the 'laterals': its flavour and lupulin-content are excellent. The bine is shorter than that of the Canterbury Whitebine, and much more spotted with red.

At present the term Golding is often applied fraudulently to many inferior varieties of hops.

Mathon or Mathon White.—A variety originating or largely grown first in the parish of Mathon, in Worcestershire. It ranks practically equal in quality to the Canterbury Whitebine, which it much resembles in form and colour of hop.

Cooper's White.—An old Worcestershire variety very similar in shape, colour, and texture of 'petal' to the White's Early of Kent.

It is less hardy than the Mathon. Both the above-kinds

appear to be degenerating in constitution as the plants do not last so long as formerly.

Fuggle's Hop.—A modern variety raised about forty years ago, and now largely grown throughout the country on the stiffer soils, where the best quality hops yield but a poor crop.

It produces an elongated pointed 'hop' of rather large size and squarish in cross-section: the stipular bracts and bracteoles are narrow, stiff, and somewhat pointed.

The crop is large but of medium quality.

C. Late Varieties—

Bates' Brewer.—A variety usually ripening after the Fuggle. The strobiles are very compact, the bracts being arranged very evenly and closely on the axis. Both the stipular bracts and the bracteoles are broad and firm with well-rounded tips, and resemble those of the Bramling variety in shape and texture.

It is one of the most distinct varieties of hops, and is considered of good or medium quality, although the flavour is generally somewhat inferior. In most localities the crop is generally small.

Grape Hops.—There are several strains of grape hops many of them having their strobiles closely placed on the branches in dense clusters like grapes, hence the name.

The individual strobiles vary much in size in the different strains, but all are pointed and somewhat triangular in outline.

In some of the examples we have examined the bracteoles are broadish and roundish at the tip, but usually both the stipular bracts and bracteoles are drawn out to a point at the tips and partially resemble a Fuggle hop in these particulars.

The grape hops are a pale golden colour when ripe, but vary much in quality, some of the smaller strains being classed as good, while those producing larger strobiles are of medium quality only.

Among the grape-varieties the best quality late hops are found.

Colgate.—A very late variety, not much grown because of its rank objectionable aroma. The strobiles are small and a pale

yellow or greenish colour : they hang in dense clusters like those of the grape varieties. The stipular bracts and bracteoles are narrow and pointed.

Wild Hops.

Buss' Hops.

These two varieties are practically identical in shape and quality. The strobiles are somewhat small, roundish-oval in shape, with thin pointed stipular bracts and bracteoles ; when ripe the latter are a pale whitish straw colour. The pale colour is very characteristic of these varieties, and both are very poor in 'lupulin.'

It is worthy of mention that the wild hop here mentioned is really a well-selected cultivated variety, and the seedlings often met with wild in hedges are usually quite different from it in form and size.

CLIMATE AND SOIL.—Some of the roots of the hop plant descend to great depths in search of water, and for the successful cultivation of the choicest varieties a deep porous loam rich in humus and containing a considerable proportion of lime is needful.

When grown at all on the stiffer clay loams only the coarser and less delicate varieties are planted : very stiff clays and dry sands are, however, unsuited to the hop plant.

Hops of the best quality are generally grown in open situations with a south sunny aspect, and where a free circulation of air is met with : they must, however, be sheltered from cold or violent winds.

PLANTING.—Hops are propagated by 'sets' or 'cuttings' which are obtained as a by-product when the plants are 'cut' or 'dressed' in spring.

If the plants are allowed to grow freely, in a very few years the rhizomes spread over too large an area for convenient cultivation and training of the 'bines' : to prevent this and keep them within bounds the soil round each plant is scraped away in spring so as to expose the upper parts of the rhizome,

after which the thickened basal portions of each of the previous year's 'bines' are cut off within a quarter of an inch or less of the old rhizome. The latter, therefore, extends but a short distance each year, and the thickened pieces cut off are called 'cuts' and are either used for the formation of 'sets' for the propagation of the crop, or are thrown away.

Each 'cut' is from 4 to 6 inches long and bears upon it two or three opposite groups of buds (Fig. 108).

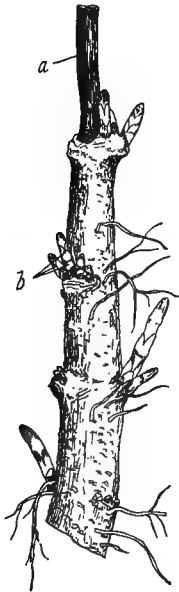

FIG. 108.—Hop 'set' or 'cutting.' *a* Piece of old dead bine or stem; the lower living part bears adventitious roots and several groups of buds as at *b*.

The 'cuts' are either planted out in the garden at once, in which case they are known as 'cut sets,' or are placed in beds in a nursery until autumn, at which time they are removed to their permanent quarters in the hop-garden: the latter is the best and most usual practice, and 'cuts' treated in this way are known as 'bedded sets.'

The 'sets' are planted in rows, the rows being from 6 to 10 feet apart, and the plants from 5 to 8 feet apart from each other in the rows. Usually they are planted at the corners of squares of 6 or 7 feet side.

Hops may also be raised from 'seed' (fruits) sown in autumn. About half the plants obtained in this manner are males and of no use to the grower; the rest—female plants—are generally of poor quality, and very rarely resemble the female parent. For example, most of the female seedlings from the choice Canterbury Whitebine variety yields strobiles which are coarse and of objectionable aroma. The large preponderance of plants of very poor quality among seedlings is no doubt connected with the fact that one of the parents, namely, the male, is always practically a wild form, for, on account of their being of no use

to the grower, males have never been subject to special selection and improvement.

It is somewhat curious that, although female seedlings show considerable variation, we have never seen any morphological differences among males, no matter what their origin, except in one or two solitary instances where the 'bines' were a paler colour than usual.

Raising from 'seed' is, however, the only way of obtaining new and vigorous distinct varieties, but as the practice involves a great deal of time, labour, and patience in the selection and subsequent propagation of the plant, it is rarely attempted. With one or two unimportant exceptions all the modern introductions have been casual selections of individual plants which have shown some peculiarity different from their neighbours in an ordinary hop garden.

YIELD.—The hop crop is subject to very great fluctuation, due to adverse climatic influences and the attack of parasitic fungi and insects.

Cultivation and the application of manures also very largely modify the yield. On some farms not more than five or six cwt. of dry hops is obtained even in the best seasons, while on others a ton per acre is not uncommon.

The average crop in this country for the last ten years is about 8 cwt. of dry hops per acre.

COMPOSITION.—The secretion contained in the 'lupulin' or hop-glands is a complex mixture of several substances, the chief of which are (*a*) hop-oil and (*b*) resins.

The hop-oil is an essential volatile oil, which gives the hop strobile its characteristic aroma; it appears to be secreted most vigorously when the gland is young.

The different aroma of the different varieties is no doubt due to uninvestigated compounds present in the hop-oil.

Of the resins three varieties have been isolated. Two of these, designated soft-resins, are intensely bitter, and communi-

cate their taste to beer; they also have antiseptic properties, and are said to prevent the deleterious fermentative action of the lactic acid and other bacteria inimical to the brewer's work, without affecting the action of yeast and the acetic acid bacteria. The third resin, possibly an oxidation product of hop-oil, is pleasantly bitter, with little or no antiseptic power.

On keeping, the two soft resins lose their useful properties, becoming changed into hard forms. Old 'hops,' therefore, are of inferior value to the brewer.

The volatile oil present in hops varies from '2 to '8 per cent. : the total resin-content is usually from 13 to 18 per cent.

Besides the secretion of the glands the bracts and bracteoles of the hop strobile contain within their cells various compounds usually met with in vegetable leaf-tissue. One of the substances present is hop-tannin, which, with its nearly-allied phlobaphene, is no doubt of service in the precipitation of albuminous material from beer wort, although there is much difference of opinion on this point.

Ex. 174.—Make observations on hop 'sets' and 'cuts' obtained when the plants in a hop-garden are 'dressed' in spring.

Note the thick basal portion of the 'bine' which has borne 'hops' last season, and also the number and position of the buds upon it.

Split one of these 'cuttings' longitudinally, and note how far the 'bine' has died back.

Ex. 175.—Examine which way a hop 'bine' twines round its support.

Observe the colour and roughness of the stem, and the shape and position of the leaves upon it.

Ex. 176.—Examine the structure of a full grown strobile or female inflorescence of a hop.

Note (1) the thickness and length of the 'strig' or axis; (2) the shape and relative size of the stipular bracts and bracteoles; and (3) the presence or absence of ripe fruit.

Which bracteoles are largest, those subtending fertile fruits or those subtending abortive fruits.

Ex. 177.—Carefully slit open a ripe fruit and set free the embryo of the seed; examine the embryo for radicle and cotyledons.

Ex. 178.—Examine young strobiles 'in burr.' Make sections of it, or dissect so as to show the female flower and its parts, and the small stipular bracts and bracteoles.

Carefully watch the strobile from day to day in order to understand the change from 'burr' to 'hop.'

Ex. 179.—Examine the flower and inflorescence of a male hop plant.

Ex. 180.—On which part of the bracteoles of a strobile are the 'lupulin' glands situated? Are any present (1) on the axis of the strobile, (2) on its stipular bacts, or (3) on the perianth of the female flowers?

Ex. 181.—Examine the 'lupulin'-glands with a low-power microscope.

4. Hemp (*Cannabis sativa* L.).—An annual dioecious plant introduced to Europe from the East. It is cultivated for its tough bast fibres, from which sail-cloths, sacking, and other coarse textile materials are prepared.

Its fruits, popularly termed 'seeds,' are also used for feeding small cage-birds and poultry. The seeds contain from 20 to 25 per cent. of a fatty oil, sometimes used as a substitute or adulterant of linseed oil. The 'oilcake' is utilised as a manure. The stems of the plant, which produce many branches, are erect and stiff, and usually grow to a height of 5 or 6 feet. The bast fibres within are not so fine as those of flax, even when the plants are grown thickly together.

The leaves are large and palmate, with from five to seven long lanceolate serrated leaflets.

The male flowers have five-lobed perianths and five stamens; they resemble those of the hop, and are borne in loose paniced inflorescences as in the latter plant. The female flowers are also very similar in structure to those of the hop, and are produced on separate plants usually of larger growth than those on which male flowers are borne.

Sparsely scattered glandular hairs are met with on the leaves and stems of the plant. In the hot climates of India, Syria, and elsewhere these glands secrete a volatile oil, and a resin which has powerful narcotic properties; in colder climates the secretion is almost devoid of poisonous qualities, although the plant possesses a peculiar stupefying odour. Hemp succumbs to a moderate degree of frost, consequently when grown in this

country for its fibre or its fruits, the 'seed' is not sown until the beginning of May, after the disappearance of late spring frosts.

When the seedlings are established they grow very rapidly, but a satisfactory crop can only be obtained on deep rich loams and alluvial soils containing a considerable amount of humus.

Ex. 182.—Examine ordinary hemp 'seed'; note its form and colour; dissect out and examine the embryo of the seed within.

Ex. 183.—Sow some hemp seeds in good garden soil, and make observations on the seedlings and full grown plants.

CHAPTER XXVI.

CHENOPODIACEÆ.

1. **General characters of the Order.**—Flowers small, regular; hypogynous, except in the genus *Beta*, which has epigynous flowers. Perianth green, five partite, persistent. Androecium of five stamens opposite to the perianth segments. Gynæcium with a one-celled ovary containing a single ovule. Fruit usually a nut, more or less enclosed by the perianth, which is membranous, fleshy or woody. Seed endospermous with a curved embryo.

The plants of this Order are generally herbaceous, with simple, entire exstipulate leaves. The latter are often fleshy, and in some genera appear covered with a whitish powder or meal.

This appearance is due to short hairs which grow from the epidermis, each hair consisting of a stalk of one or two cells, terminated by a large round or star-shaped cell containing clear watery cell-sap.

Most representatives of the Chenopodiaceæ are met with near the sea and on the shores and marshes surrounding inland salt lakes.

Many weeds belonging to the Order are specially luxuriant upon well-manured ground and on waste places where urine and faecal matter have been deposited. The whole Order seems specially adapted to exist in soils much impregnated with common salt, nitrates of sodium and potassium, and similar compounds, and the application of common salt to the mangel and beet crop usually improves the yield.

The genera belonging to it which need special mention are

Chenopodium (Fat Hen or Goose-foot), *Atriplex* (Oraches), and *Beta* (Beet and Mangel).

The genus *Chenopodium* includes a number of annual species widely distributed on waste ground, and often prevalent as weeds upon well-manured arable land. They are all very variable plants and difficult to distinguish from each other. Perhaps the commonest species is White Goose-foot or Fat Hen (*C. album* L.) (see p. 596).

Good King Henry or All-good (*C. Bonus-Henricus* L.) is a perennial species sometimes used instead of spinach as a pot-herb, and frequently found on waste ground near villages.

The genus *Atriplex* embraces a number of variable species, most of which somewhat resemble the Goose-foot in outward appearance. They are however monœcious (see p. 596).

To the genus *Beta* belong wild sea-beet, and the cultivated garden and field beets.

2. **Sea-Beet** (*Beta maritima* L.) is a perennial plant common on muddy sea shores. The root is tough, moderately thick, and fleshy. The angular stems, which are many and branched, are prostrate below, but their tips curve upwards to a height of 1 or 2 feet. The lower leaves are smooth, about 3 or 4 inches long, fleshy, ovate-triangular, and the blade narrowed into the broad petiole; the upper ones smaller and lanceolate. The inflorescence, flowers, and fruit resemble those of the mangel described below.

3. A large number of *cultivated forms* of beet are known, some of which are grown chiefly in gardens, and used as a vegetable for human consumption, while others, such as mangels and sugar-beet, are cultivated on the farm. They vary much in the colour and sugar content of their so-called fleshy 'roots,' and also in their resistance to frost. The shape and amount of the 'root' which appears above the soil is also subject to variation. All the forms appear to be merely varieties of one species, which has been named **Common Beet** (*Beta vulgaris* L.) They differ from

the wild sea-beet of our coasts (*B. maritima* L.) in being biennial in habit and in having straighter upright flowering stems, and a more well-defined uniform tap root. These cultivated forms most probably originated from a variety growing wild on the western coasts of the Mediterranean and on the Canary Isles, and known as *B. vulgaris* L., var. *maritima* Koch. Whether this plant is really distinct, or is itself a variety of *Beta maritima* L., is not certain.

Of the *garden forms* little can here be said. Their roots are mostly of conical or napiform shape, with deep crimson tender

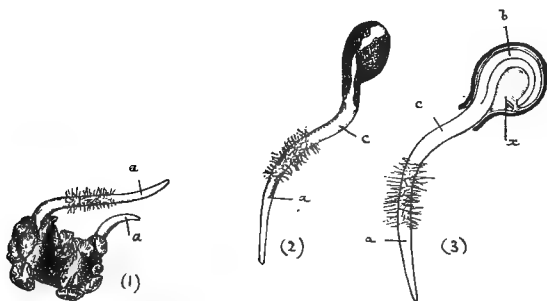

FIG. 109.—1. Mangel 'seed' (fruit) germinating. *a* Primary roots from two separate embryos.
2. True seed separated from 1.
3. Longitudinal section of 2. *a* Root; *b* cotyledons; *c* hypocotyl; *x* endosperm.

flesh, which is rich in sugar. A variety known as **Chard Beet** (*B. vulgaris* L., var. *Cicla* L.) is sometimes cultivated for the broad pale fleshy midribs of its leaves, which are cooked and eaten like sea-kale.

4. **Mangel Wurzel** or **Field Beet**.—Mangel Wurzel is the German for 'Root of Scarcity,' by which phrase this plant was known about the time of its introduction into England as a field crop about 100 years ago.

This appellation appears to have arisen from the fact that it often produces a great crop when other plants fail. It

equally deserves the name from the fact that it keeps well until late spring and early summer, when turnips and swedes have been consumed and grass and other forage crops are scarce.

SEED AND GERMINATION.—The parts known in commerce as mangel 'seeds' are in reality fruits, two or three of which are often joined together. Each fruit contains a single albuminous seed.

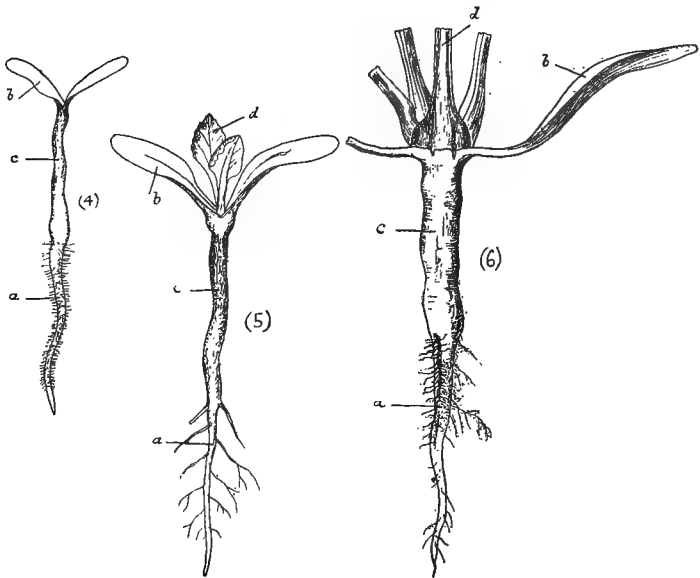

FIG. 110.—4. Seedling mangel; 5 and 6. Older examples of the same. *a* Root; *b* cotyledons; *c* hypocotyl; *d* first foliage-leaves of plumule.

The seed is kidney-shaped, about the size of a turnip seed, with a dark smooth testa. Just within the latter lies the embryo, which is curved round the central endosperm. During germination the cotyledons absorb the endosperm and remain within the seed-coat some time after the root has made

its exit (3, Fig. 109). Eventually the cotyledons become free from the seed and appear above ground. The young plant possesses two narrow cotyledons, a well-marked hypocotyl, and a primary root, which is quite distinct from the latter (4, Fig. 110).

ROOTS AND HYCOTYL.—The primary root is well-developed, and secondary roots arise upon it in two longitudinal rows (6, Fig. 110). The total root-system is very extensive and often penetrates to great depths in suitable soil. It is not infrequent to find drains 4 and 5 feet below the surface of the soil blocked by them. In the subsequent growth of the plant the hypocotyl becomes pulled more or less into the ground by the contraction of the roots, but the hypocotyl and root always remain more or less distinct; the former rarely bears any adventitious roots.

The 'mangel' of the farm, which is generally termed a 'root,' consists of thickened hypocotyl and true root; the relative proportion of each part is not however, the same in all varieties. In the long-red and ox-horn varieties the hypocotyl grows out of the ground; in others, such as the sugar-beet, the hypocotyl is shorter and pulled beneath the surface of the soil.

A collection of leaves is seen at the apex of the mangel, and just below them are the remains of the old leaf-bases, which give to this part a rough rugged appearance (Fig. 114).

A transverse section (Fig. 112) shows a series of concentric rings of firm vascular tissue alternating with rings of soft thin-walled parenchymatous bast; the cell-sap of the parenchyma,

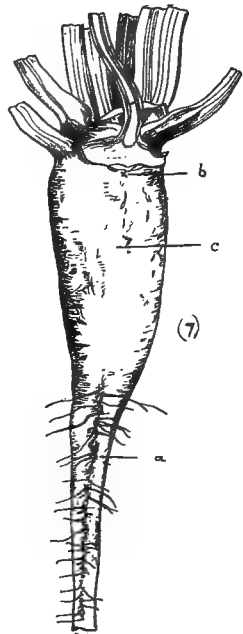

FIG. 111.—Young mangel. *a* Root; *c* hypocotyl; *b* point where cotyledon was present.

midway between the vascular rings, often has a crimson or yellow tint. In white-fleshed varieties the cell-sap is clear, and these parenchymatous zones are translucent when thin slices are held up to the light. The vascular rings consist of isolated strands or groups of vessels with thin-walled parenchymatous medullary rays between.

It is outside the scope of the present work to deal with the complex growth in thickness of the root and hypocotyl of the mangel; but it may be mentioned that each ring of vascular strands, with the medullary rays between and the corresponding zone of thin-walled bast, is the product of a separate cambium tissue.

The individual cambium-rings arise in the pericycle of the root in rapid regular succession from the centre outwards.

Sooner or later the cell-division of the inner ones ceases, but the exact length of time during which

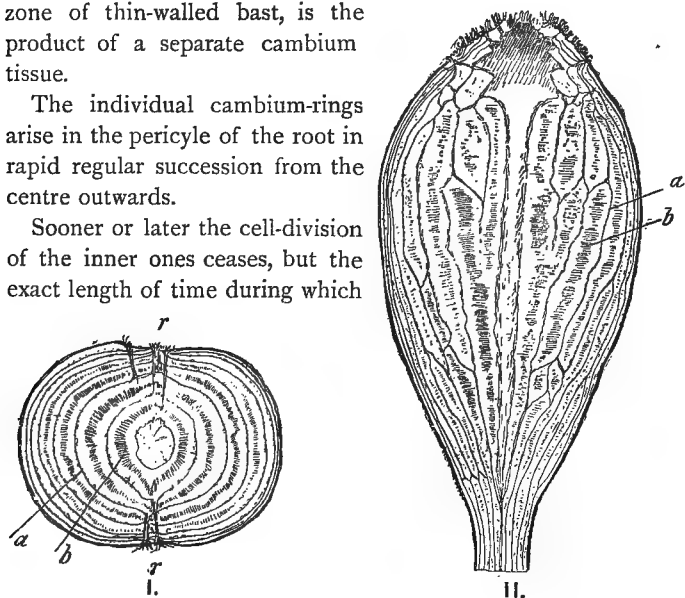

FIG. 112.—1. Transverse section of mangel 'root,'
2. Longitudinal section. *r* Lateral roots; *a* ring of vascular bundles; *b* thin-walled parenchyma (chiefly bast-tissue).

each cambium-ring remains active is not certain. In ordinary varieties usually six or seven cambium-rings complete their

growth in the six months during which the mangel is growing in this country.

Sometimes it is assumed that mangels with yellowish zones of parenchyma, such as is present in the Golden Tankard variety, are richer than those with quite white flesh. This, however, is an error, as very frequently white-fleshed varieties, *e.g.* most sugar-beets, are much richer than those with yellow or crimson flesh. There appears to be no direct connection between the colour of the 'flesh' and sugar-content.

The sugar is not evenly distributed in the tissues of the mangel, the rough 'neck' contains much less than the rest of the 'root.' Moreover, the greatest amount of sugar is present in the cell-sap of the parenchyma lying close to the vascular ring, the cells in the middle of the zone of parenchyma between two successive rings of vascular tissue being comparatively poor in this substance. The richest mangels are therefore those in which the vascular rings are most closely placed together, and in which the parenchyma, poor in sugar, is consequently reduced to a minimum. For 'roots' of the same diameter the best kind are those which have the greatest number of vascular rings.

INFLORESCENCE.—During the first year the mangel usually stores up reserve-food in its hypocotyl and root, and the stem above the cotyledons remains short and bears a number of leaves in a close rosette.

In the following year the terminal bud and axillary buds of this very short stem send up strong leafy angular stems which rise to a height of 3 feet or more, and these and their branches terminate in inflorescences.

The inflorescence consists of an elongated axis upon which at short intervals the flowers are arranged in dense sessile clusters, each containing from two to seven flowers (*A*, Fig. 113); below each cluster is a small bract.

THE FLOWER (*B*, Fig. 113) is epigynous and about $\frac{1}{4}$ of an inch in diameter. It is bisexual and possesses a small green

five-leaved perianth, the lower part of which is united with the fleshy receptacle. The andrœcium consists of five stamens opposite to the perianth.

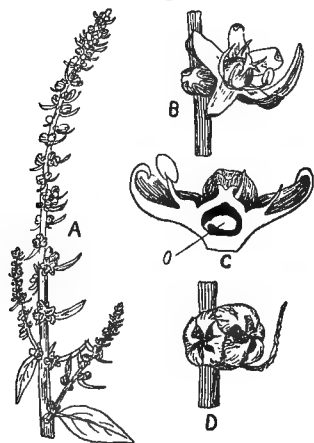

Fig. 113.—*A*, Portion of the inflorescence of the mangel.

B, One open and one closed flower of mangel.

C, Vertical section of a flower. *o* Ovule.

D, Cluster of two fruits developed from flowers of *B*. Such clusters constitute commercial mangel 'seeds.'

The ovary of the gynœcium is sunk partially in the fleshy receptacle and contains a single ovule (*C*, Fig. 113).

The flowers of the mangel and beet are protandrous, and flowers 'set' no fruit if specially isolated or prevented from receiving pollen from neighbouring flowers. Cross-pollination appears to be effected by the agency of small insects and the wind.

THE FRUIT.—After fertilisation the fleshy receptacle and base of the perianth of each flower enlarge considerably and the separate flowers in each cluster become more or less firmly united with each other (*D*, Fig. 113). The fleshy parts with the imbedded ovaries eventually turn hard and woody, and the clusters of spurious fruits finally fall off or are thrashed off the long axis of the inflorescence and come into the market as 'seeds.'

The latter are in reality collections of two or more spurious fruits. Each spurious fruit consists of the hardened receptacle and perianth with the ripened gynœcium containing a single seed, and as several of these fruits may be present in each commercial 'seed' it will be readily understood that when one of the latter is sown several seedlings may spring from it. This peculiarity necessitates the separate hand thinning of a young crop of mangels, otherwise by growing so closely together

the seedlings injure each other and produce deformed and small 'roots.'

The true seed is very small, a fact which must be taken into consideration when sowing is contemplated as it is readily buried too deeply for proper germination.

VARIETIES.—Mangels may be conveniently divided according to their shape and the colour of the skin of the parts below ground. Usually the petiole and main veins of the leaves resemble the skin of the 'root' in tint, and there is frequently a tendency for the parenchymatous zones or soft rings of the flesh to be similarly coloured.

Much variation, however, exists in the colour of the skin and flesh, few crops proving quite 'true' in these respects. The best varieties, especially the Golden Tankard, are most subject to reversion, and need constant attention on the part of the seedsman to keep the strain 'true.'

A good mangel should yield a heavy crop, and the feeding quality should be as great as possible. Besides these points it is of importance to note the depth to which it grows in the soil, as the expense of lifting a deeply-seated crop may materially reduce its usefulness from the farmer's point of view.

It must, however, be borne in mind that, so far as composition is concerned, mangels with 'roots' below the ground are richer in sugar and of better feeding-value than those with 'roots' above ground.

The continuation of the tap root should be single and small; those with 'fanged,' thick secondary roots are more difficult to pull and clean, and generally of a coarse and fibrous nature. The 'neck' or rough upper part of the mangel should be as small as possible, and its flesh firm and solid, with no tendency to sponginess in the centre.

The variety should be as 'true' as possible, so far as its shape and colour of skin is concerned, and its keeping qualities should be good.

A common fault with some strains is their inclination to 'bolt' or behave as annuals, and produce an inflorescence the first season without forming a thickened 'root.'

Long Varieties.—In these the 'roots' are three or four times as long as they are broad (*A*, Fig. 114), and are generally about

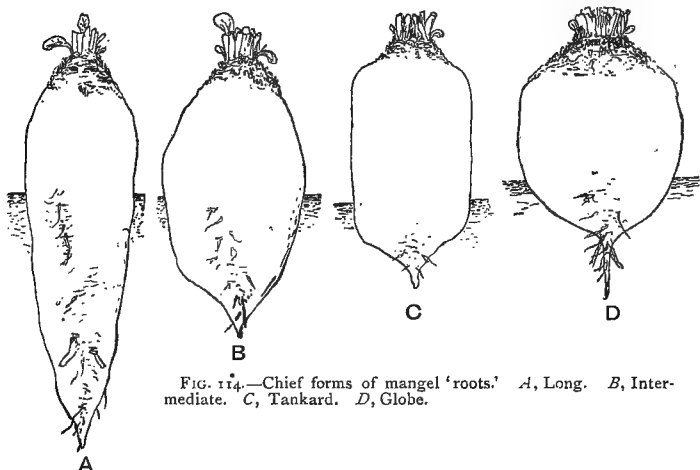

FIG. 114.—Chief forms of mangel 'roots.' *A*, Long. *B*, Intermediate. *C*, Tankard. *D*, Globe.

a half or two-thirds above the soil. These varieties give the greatest yield per acre of any kind of mangel, and are suited to deep soils, especially clays and loams. They are divided into (1) **long red** and (2) **long yellow** varieties, according as the skin is red or yellow.

The long yellow kinds are somewhat superior in quality to the long red ones, but both are coarse and fibrous, and of lower feeding value than most of the varieties mentioned below.

Ox-horn Varieties.—These are very closely allied to the long red and long yellow varieties, but their 'roots' assume a twisted horn-like shape. The part below ground does not descend below the depth of the plough furrow: they are therefore suited to shallower soils; but their irregular growth makes it

difficult or impossible to cultivate between the rows. The quality is not good, but the yield is large.

Intermediate or 'Gatepost' Varieties.—These have large oval roots (*B*, Fig. 114), somewhat intermediate between the long and globe varieties. They may be either red, yellow, or orange in colour of skin, and are suited to comparatively shallow soils.

Tankard Varieties.—The typical shape of these resembles *C*, Fig. 114. Two kinds are grown, namely, Golden Tankard, with orange coloured skin, and flesh with yellow zones; and Crimson Tankard, in which the skin is crimson or rose colour, and the flesh with crimson rings.

All tankard varieties have small 'roots,' and give small crops, unless grown somewhat closely in the rows.

The nutritious quality of the Golden Tankard, however, surpasses that of all other varieties of mangel.

Globe Varieties.—In these the 'roots' are spherical or nearly so, and by far the larger part of each grows above ground (*D*, Fig. 114). They are especially suited to the light and shallower classes of soils, where they may be made to produce an excellent crop, which is readily lifted or pulled from the soil. Perhaps the commonest form is the Yellow Globe, the nutritive value of which ranks second to the Golden Tankard. Red and orange varieties are also grown.

CLIMATE AND SOIL.—The mangel requires a warm, dry climate, that of the south of England being much more suited to its growth than the north. The most satisfactory soils are deep clays and loams, especially for the long varieties, but lighter soils, except those of loose sandy character, produce good crops of Globes and Tankards.

SOWING.—The 'seed' is generally sown between the middle of April and the beginning of May in drills 27 inches apart for the Globe and Tankard, and 21 to 24 inches apart for the longer varieties. It requires a somewhat high temperature to germinate satisfactorily, and it should not be drilled at a greater

depth than $\frac{3}{4}$ of an inch below the surface, for, although the so-called 'seed' is of some considerable size, the true seed is small, and has little power to make its way upward if buried too deeply. The amount of 'seed' used is from 6 to 8 lbs. per acre. The young plants are subsequently 'singled' so as to leave from 10 to 14 inches between each plant in the row, the smaller distances being adapted for the long varieties, especially if smaller and relatively more nutritious 'roots' are desired.

YIELD.—The average yield of 'roots' per acre is about 18 to 25 tons.

COMPOSITION.—Cane-sugar is one of the chief ingredients in the mangel. The amount varies from 3 or 4 per cent. in the large long red varieties to about 7 or 8 per cent. in the Golden Tankard and well-grown Globes.

The water-content varies from 86 per cent. in the best kinds to 92 in the poorer varieties. Usually they are much superior in composition to turnips, but in damp, cold seasons large roots may be as watery as white turnips.

Mangels cannot be fed to stock immediately after being removed from the land in autumn, as they contain some ingredient which produces 'scouring' in animals; what the substance is which is responsible for this effect is not clear; possibly it is a nitrate or oxalate. Nitrates are present in considerable abundance in autumn, but these compounds gradually diminish in amount if the mangels are kept till spring. The injurious substance, whatever it is, disappears to a large extent on keeping, the yellow-skinned varieties are generally ready to feed to stock before the red ones.

The nitrogenous substances in mangels average about 1.2 per cent., of which a little less than half are albuminoids. Several distinct amides are generally present, especially when the 'roots' are not ripe. The fibre averages about .9 per cent.

5. Sugar-Beet.—The name sugar-beet is given to selected varieties of mangel which are specially grown for their sugar-content.

The mangel first selected for improvement was a **White Silesian** variety (Fig. 115, *A*), which may be considered as the parent of all the chief varieties now grown.

Sugar-beets are comparatively small, the best weighing about $1\frac{1}{2}$ to $2\frac{1}{2}$ lbs., and of conical or elongated pear shape. Unlike the ordinary mangels the sugar-beets have their thickened 'roots' entirely buried in the soil, those with large 'necks' above ground being less valuable in many ways and poorer in sugar.

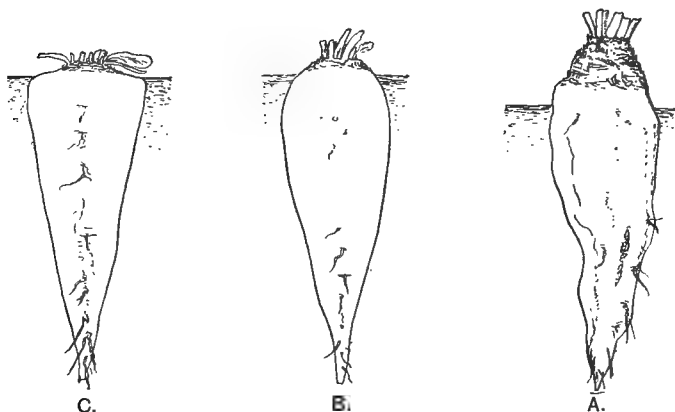

FIG. 115.—Chief forms of sugar-beet.
A, White Silesian Beet or Mangel.
B, Knauer's Imperial and Klein-Wanzlebener.
C, Vilmorin's Improved.

The 'roots' should not be 'fanged,' and in good varieties the skin is white, and the flesh firm and white, with a large number of close concentric rings of vascular bundles. Beets with upright leaves and long petioles are always less rich in sugar than those with leaves which lie close to the ground and have shorter petioles.

The chief forms are exhibited in the varieties mentioned below :—

Vilmorin's Improved.—The 'root' is conical in shape (Fig.

115, *C*), and the leaves spread out as a flattish rosette on the ground when ripe.

Knauer's Imperial (Fig. 115, *B*).—A pear-shaped variety, usually with white flesh sometimes inclined to a roseate hue. The leaves, which have reddish veins, grow more upright than in the former variety and have somewhat crenated and puckered margins.

Klein-Wanzlebener.—A variety resembling the preceding one but with more spindle-shaped root and green leaves.

CLIMATE AND SOIL.—Sugar-beet thrives best in a climate possessing a warm and moderately damp summer, and having somewhat dry, hot months of August and September, during which time the sugar is stored in the root in greatest abundance.

Climates such as are met with in Southern Europe are too dry and the North is too wet for satisfactory sugar production by sugar-beet. In wet climates the roots are poor in sugar.

Average seasons in the British Isles are probably too damp for successful cultivation of this crop, although fair yields of roots with good sugar-content have been grown for experimental purposes during the last two or three somewhat dry seasons.

The soil most suited to the crop is a medium loam of good depth containing a considerable proportion of lime.

Heavy wet clays or very dry sandy soils are not suitable. If farmyard dung is used as manure it is essential that it should be ploughed in during autumn or applied to a previous crop. The quality of the roots is much influenced by a good supply of potash salts especially the carbonate; phosphates are also beneficial and the yield is increased by an application of nitrate of soda or ammonium sulphate applied in the early stages of growth of the plant.

SOWING.—The seed is drilled or dibbled in rows about 14 or 15 inches apart and the plants are subsequently singled by hand when about a quarter of an inch thick, so as to stand 6 to 8

inches asunder in the row. As the young plants are very susceptible to frost the seed should not be sown before about the middle of April or the beginning of May. The amount of seed necessary to drill an acre is about 30 lbs. : it is usually soaked in water for 24 hours before sowing, and should not be buried more than an inch deep.

HARVESTING.—The vegetative period necessary for the satisfactory production of a 'ripe' root is from 140 to 150 days in England, so that if sown at the proper time the crop is usually ready to be harvested from about the middle to the end of September, at which time the roots are dug up with a narrow spade or a two-pronged fork.

YIELD.—The yield is usually from 12 to 16 tons per acre.

COMPOSITION.—The water-content of a sugar beet is about 82 per cent. The amount of cane sugar present averages 15 or 16 per cent. in good varieties; the woody fibre about 1.3 per cent.

Ex. 184.—Germinate some mangel 'seeds' in damp sand. Find out how the root escapes from the fruit.

Carefully extract some of the true seeds with a strong needle or a knife, and cut sections to show the curved cotyledons and endosperm.

Ex. 185.—Examine seedling mangel plants in various stages of development, paying special attention to the primary root, hypocotyl, and secondary roots.

Ex. 186.—Cut transverse and longitudinal sections of a full grown mangel 'root.' Note the distribution of the vascular tissue and soft parenchyma. Observe which parts are coloured pink, crimson, or yellow, and which are white.

Ex. 187.—Cut transverse sections and count the 'rings' in large and small mangel 'roots' from the same crop. Note if the difference in total diameter of the 'roots' is due to greater width of each ring or to a greater number of rings in the larger specimens.

Ex. 188.—Examine and describe the stem, leaves, and flower of a 'bolted' mangel or a normal second year plant.

Ex. 189.—Examine a number of commercial mangel 'seeds.' Observe the shrivelled tips of the perianths, and find out the number of true fruits in each so-called 'seed.'

Ex. 190.—The student should become acquainted with the chief characters of the common species of *Chenopodium* and *Atriplex*.

CHAPTER XXVII.

CRUCIFERÆ.

1. **General characters of the Order.**—Flowers (Fig. 116, *A*), regular, hypogynous. Calyx polysepalous, four sepals in two whorls, deciduous; corolla

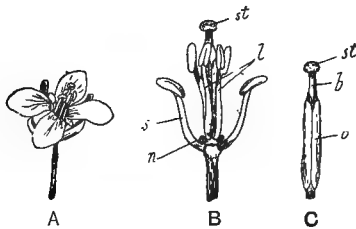

FIG. 116.—*A*, Flower of turnip. *B*, The same, after stripping off the calyx and corolla, showing the andrœcium and gynæcium. *s* Two short stamens; *l* four long stamens; *st* stigma of gynæcium; *n* nectary. *C*, Gynæcium. *o* Its ovary; *b* style; *st* stigma.

polypetalous, four petals in one whorl: andrœcium of six stamens in two whorls, *tetradynamous*, that is, four stamens with long filaments, and two with short ones. (Fig. 116, *B*). Gynæcium (Fig. 116, *C*) syncarpous, two carpels: the ovules are arranged on two parietal placentas; the ovary is sometimes unilocular,

but more frequently divided into two compartments by a 'false' partition, which is an outgrowth from the placentas.

Fruit, usually a dehiscent silique or silicula (see *Raphanus*, p. 385), seeds without endosperm or with only traces of it. When placed in water the cuticle of the testa of the seeds from the dehiscent fruits generally swells up into a slimy sticky substance, which fixes the seed to the ground, tends to store up water during germination, and also aids in the distribution of the seeds. Situated on the receptacle, generally at the base of each of the two short stamens, are greenish nectaries.

Pollination is chiefly brought about by insects. The anthers are so placed in regard to the stigmas and nectaries, that insects

frequently effect cross-fertilisation when searching for honey. Self-fertilisation is however common, and productive of good seed.

The Order comprises about 1200 species, mostly of herbaceous or slightly shrubby character; practically all are non-poisonous and extensively represented in temperate and cold regions.

The inflorescences are usually simple racemes without bracts or bracteoles.

Many plants belonging to the Cruciferæ, such as cabbage, kohlrabi, turnip, swede, rape, and white mustard, are very valuable to the farmer.

Acrid, pungent compounds are present in various parts of mustard, charlock, radish, and many other cruciferous plants.

Instead of starch being stored as reserve food-material for the young plants, the tissues of the embryos of nearly all the Cruciferæ contain considerable quantities of oil.

The seeds of several species belonging to the genus *Brassica* furnish oil which is sold under the name of Colza oil or Rape oil.

A number of plants, such as charlock, wild radish, shepherd's-purse, Jack-by-the-hedge, and hedge mustard, belonging to the order are common weeds of the farm, while others, such as the wallflower, stock, and candy-tuft, are ornamental plants of the garden.

So far as the farmer is concerned, the most important genus of the Cruciferæ is the genus *Brassica*, which includes the turnip, swede, rape, and the cabbage and its varieties: some botanists include black mustard, white mustard, and charlock in it, while others place these plants in a separate genus, *Sinapis*: the former plan is adopted here.

2. **Wild Cabbage** (*Brassica oleracea* L.).—This plant, which is the parent of all the cultivated forms, grows on the sea cliffs in the south of England and various parts of northern Europe. It is a biennial, or perennial with a stout erect stem from 1 to 2 feet high. The lower large, broad leaves, are obovate with lobed margins, smooth, and of ashy green hue. The upper

leaves are smaller and sessile. The flowers are pale yellow, often an inch in diameter, arranged in long racemes.

The siliques are smooth, about 2 or 3 inches long, and stand out from the main axis of the inflorescence.

3. **Cultivated Cabbage, and its varieties** (*Brassica oleracea* L.).—Few plants have given rise to so many fixed varieties or races as the cabbage. Almost every part of its structure, except the root and seeds, has been modified by man for his own use.

The seeds of all the varieties are so similar that they cannot be distinguished from each other with certainty (p. 636). The young seedlings also present great similarity, and have two notched cotyledons, similar to those of the turnip in Fig. 117; the first foliage-leaves are quite smooth and of glaucous tint.

In all the forms of cultivated cabbage the inflorescence, flowers, fruit, and seeds are similar to those of the wild cabbage mentioned above: it is in the growth of the vegetative parts and the young inflorescences that the most striking variations are seen.

All the cultivated forms are biennial and fall into several groups, namely:—

i. *Brassica oleracea* L., form *acephala*.

The terminal and axillary buds of the varieties in this group grow out into leafy shoots in the first season, and therefore give rise to an elongated stem and branches bearing a considerable number of green foliage-leaves for which these plants are grown. These varieties most nearly resemble the wild cabbage: representatives are **borecole**, **Scotch kail**, and **Thousand-headed kail**.

ii. *Brassica oleracea* L., form *gemmifera*.

This form resembles the preceding one in possessing an erect elongated stem, but the axillary buds upon it, instead of branching out immediately, become more or less compact and round. The plant is grown for these buds, which are usually about 1 or 2 inches in diameter. The chief representative is the **Brussels Sprout**.

iii. *Brassica oleracea* L., form *capitata*.

In this group the stem remains short and the terminal bud develops into a very large 'head' of closely overlapping smooth leaves. The so-called 'white' and 'red' (really green and purple) **Drumhead cabbages** are examples.

iv. *Brassica oleracea* L., form *subauda* or *bullata*.

This name is applied to what are known as **Savoy cabbages**. They are similar in structure to the *capitata* forms, but have puckered or wrinkled leaves.

v. *Brassica oleracea* L., form *gongylodes* or *caulo-rapa*.

In this form the stems above the cotyledons remain short and become very thick and fleshy. It is known as **Kohl-rabi** or turnip-rooted cabbage.

vi. *Brassica oleracea* L., form *botrytis*.

In this group the axis of the inflorescence and all its many branches are formed during the first year's growth, and become thickened and fleshy when young. The hardy forms are known as **Broccoli**, those more tender and liable to injury by frost are spoken of as **cauliflowers**.

Many of the varieties of cabbage are only grown in gardens. A few, however, are useful crops of the farm; the chief ones grown as food for stock are Thousand-headed kail, Drumhead and Savoy cabbages, and Kohl-rabi.

4. **Thousand-headed kail**.—This form of *Brassica oleracea* grows to a height of 3 or 4 feet, sending out leafy branches all along the strong woody stem, and these again branch until an extraordinarily large amount of succulent forage is produced. The leaves are dark green, with wavy, slightly crinkled margins.

Thousand-headed kail is very hardy and rarely suffers from even prolonged frosts. It is chiefly used as food for ewes and lambs in autumn and spring and generally consumed on the field where it is grown.

5. **Cabbage**.—The word cabbage is generally applied to all those varieties the leaves of whose terminal buds form a compact

round or oval head. They differ considerably in rapidity of growth, and may be classified into early and late varieties. Some of the early varieties reach maturity of 'head' in the early autumn of the same year in which they are sown, while the late varieties during the same period of growth are but half grown and comparatively immature.

They may also be classified according to the shape into (i) **Drumheads** with flattened spherical 'heads,' which take up lateral space and require to be planted some considerable distance apart; and (ii) **Ox-hearts** which have oval or bluntish cone-shaped 'heads.' The latter varieties take up less space and may be planted nearer together than the Drumheads.

The cabbages are fairly hardy, but the 'heads' contain a considerable amount of water (generally 89 per cent.), and do not stand wet weather or frost so well as the open Thousand-headed variety. Cabbages are largely grown for feeding dairy cattle and sheep, and are more nutritious than white turnips. They increase the flow of milk and in moderation are less liable to give a taint to it than turnips, especially if the outermost leaves are discarded.

Savoy cabbages are more hardy than those with smooth leaves, and are therefore more adapted for winter use than the latter varieties.

6. **Kohl-rabi** is a form of cabbage with a thickened turnip-like stem which stands quite above the ground although in good strains, often close to it.

The fleshy part is developed from the stem above the cotyledons, none of the hypocotyl or root being present in it: it thus differs from the turnip, mangel and carrot.

As Kohl-rabi suffers very little in the driest weather it is sometimes designated 'the bulb of dry summers.' It resembles the swede turnip in feeding-quality and yield, but stands frost better. The leaves as well as the stem are useful food for stock.

The varieties differ in the shape of the thickened stem, some being almost spherical while others are oval.

They vary also in colour, some being glaucous green and others a purplish tint.

Both early and late varieties are known.

CLIMATE AND SOIL.—All the varieties of cabbage produced on a farm are capable of growing in climates which are much too dry for the proper development of the turnip. They are also better adapted for growth on strong loams and clays than the latter plant.

SOWING.—In many cases the cabbage and its varieties are drilled or sown broadcast in small prepared seed-beds, upon sheltered ground. The young plants are subsequently transplanted out in the field when 6 or 8 inches high.

Most of the crops may, however, be drilled in rows in the field where they are to grow, the superabundant plants being thinned out and the remainder left to develop.

The seed may be sown at varying intervals of time in such a manner as to provide a succession of green food almost throughout the whole year. Usually in those cases where the crop is to be used during the autumn and early winter, the seeds are sown in beds in February, March and April, the young plants transplanted in June and July, and the crop ready for consumption from September to December. When drilled on the field where they are to grow June and July are the months for sowing, the crops being utilised from September to December.

Seeds of the hardier varieties may be sown in beds in August, the young plants transplanted in October and November, and the crop will be ready for consumption in the following spring and summer.

The seeds may also be drilled in August and September to produce a crop during the following spring and summer.

The rows of plants vary from 20 to 30 inches apart, according to the variety grown, and other circumstances.

Usually the plants are equidistant from each other, both in the row and from row to row.

The amount of seed when the plants are raised in a seed-bed is 1 lb. for each acre to be subsequently planted ; if drilled on the field direct 4 or 5 lbs. per acre are necessary.

YIELD.—An average crop of cabbages is about 30 tons, that of Kohl-rabi about 20 tons per acre.

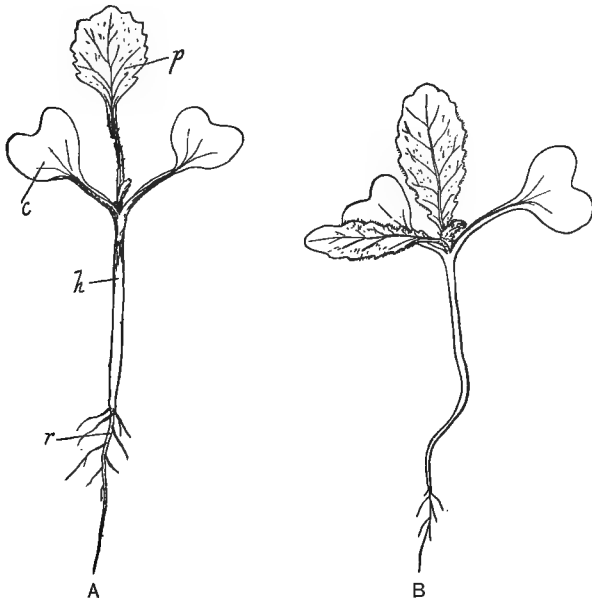

FIG. 117.—*A*, Seedling of turnip (*Brassica Rapa* L.). *r* Root; *h* hypocotyl; *c* cotyledon; *p* first foliage-leaf ('rough leaf'). *B*, Seedling of charlock (*Brassica Sinapis* Vis.).

COMPOSITION.—Kohl-rabi is richer in albuminoids and 'fibre' and poorer in carbohydrates than swedes. The average water-content is about 88, the digestible carbohydrates about 7, fibre 1.5, and albuminoids 2.3 per cent. respectively.

7. Turnip (*Brassica Rapa* L.).—This name is applied to a

biennial plant grown extensively for its thick fleshy so-called 'roots,' which are produced during the first season of growth and used as late summer, autumn and winter food for various kinds of stock.

SEED AND GERMINATION.—The seed is almost round, with a reddish purple testa, and contains an embryo which resembles that of white mustard in general form (Fig. 5). The seedling possesses two smooth notched cotyledons and a hypocotyl and root very distinct from each other. The first foliage-leaves are

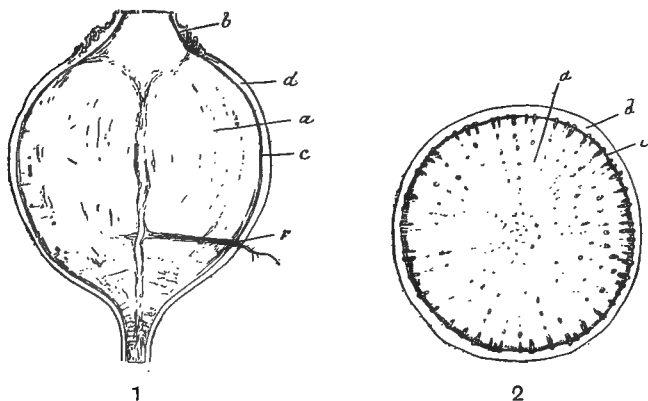

FIG. 118.—1. Longitudinal section of a turnip 'root.' 2. Transverse section of the same. *d* Bast and secondary cortex; *c* cambium-ring; *a* degenerate wood, forming main mass of the root; *r* normal secondary root, originally produced when the primary root was thin (almost all above this point is thickened hypocotyl); *b* old leaf-scars.

grass-green in colour, roundish with irregularly serrate margins and their surfaces have scattered hispid hairs upon them.

ROOT AND HYPOCOTYL.—A single tap root generally exists from which a number of thin secondary roots arise. The total root-system, although fairly extensive, does not descend to any great depth, but spreads horizontally in the upper layers of the soil.

During the first year, both the hypocotyl and primary root increase in length and thickness, the combined thickened

part, in popular parlance, being variously termed the 'turnip,' turnip 'bulb' or turnip 'root.' In all cases the amount of hypocotyl is considerable, but the relative proportion of this part of the plant to the true root is not the same in all varieties, and probably varies with the soil and cultivation which the plants receive.

The swollen fleshy 'root' of a turnip possesses essentially the same arrangement of tissues as is common in ordinary roots and stems. The relative proportion and composition of each tissue is, however, very different.

A transverse section (2, Fig. 118) of a turnip 'root' shows an outer layer about $\frac{1}{8}$ of an inch thick, chiefly bast (*d*); within is the wood (*a*) which forms the main mass of the 'turnip'; it is produced by the cambium (*c*). Almost the whole of the wood consists of thin-walled, unligified wood-parenchyma, imbedded in which appear radial lines of vessels in small isolated groups. Medullary rays are present, but these are not readily distinguished from the degenerate wood-parenchyma: they form but a comparatively small part of the fleshy 'root.'

LEAVES.—The stem upon which the leaves grow remains very short during the first year: the leaves consequently appear in a rosette-like bunch at the top of the so-called bulb. The first foliage leaves are roundish with irregularly serrate margins, those growing later being pinnatifid or pinnate with a large oval terminal lobe (lyrate). All produced during the first year's growth are grass-green and beset with rough harsh hairs.

In the second season the terminal bud in the centre of the rosette of radical leaves, develops into a strong erect stem with many branches. The leaves upon the latter are somewhat glaucous and smooth, the upper ones being ovate-lanceolate, sessile, with bases which partially clasp round the stem.

The ends of the branches and main stem terminate in inflorescences.

INFLORESCENCE AND FLOWERS.—The turnip inflorescence is a

raceme which when young resembles a corymb, the open flowers equalling or overtopping the buds which appears crowded together. As the flowers open, the axis of the inflorescence elongates, and the flowers then become separated from each other by longer intervals. The flowers are small, about $\frac{1}{2}$ an

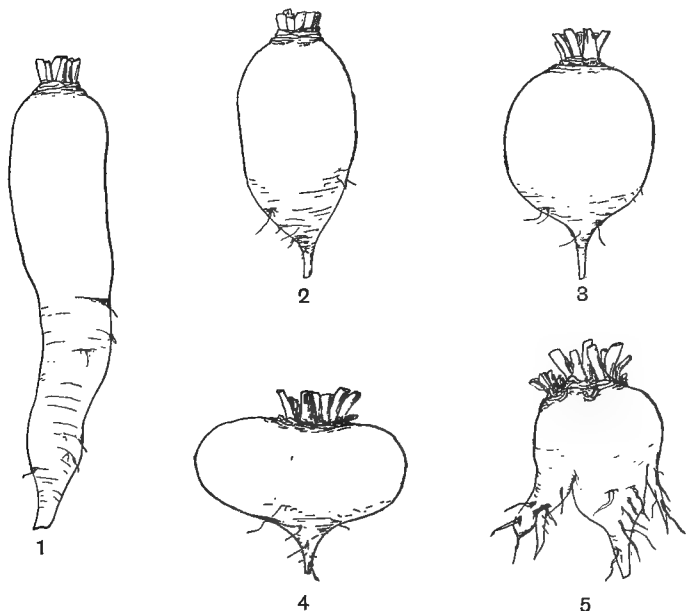

FIG. 119.—Chief forms of turnip 'roots.' 1. Long. 2. Tankard or spindle-shape. 3. Round or globe. 4. Flat variety. 5. A typical bad 'root,' many-necked 'top' and fang-like roots.

inch in diameter, of the ordinary cruciate type (Fig. 121), with almost erect calyces and bright yellow corollas.

FRUIT.—The fruit is a smooth elongated silique with a short seedless beak.

VARIETIES.—Turnips may be classified according to their shape into the following groups.

i. **Long varieties** in which the fleshy 'root' is three or more times as long as it is broad (1, Fig. 119).

ii. **Tankard or Spindle-shaped varieties** (2, Fig. 119), in which the *greatest* diameter of the 'root' is between 'top' and 'tail.'

iii. **Round or Globe varieties** in which the 'roots' are almost spherical (3, Fig. 119).

iv. **Flat varieties** in which the *shortest* diameter is between 'top' and 'tail' (4, Fig. 119).

Many intermediate forms are prevalent, but the above represent the chief most distinct groups, so far as shape is concerned.

Turnips may be also placed in groups according to the colour of the upper part of the 'root,' which is exposed to the light and air above ground and the colour of the 'flesh.'

A. **White-fleshed varieties.**

These are generally of low feeding-value, many of them with soft flesh, liable to be injured by frost.

Their growth is rapid, and a considerable amount of produce is yielded in a short time. They are chiefly adapted for feeding in autumn and early winter, and are conveniently divided into (1) 'white tops,' (2) 'green tops,' (3) 'purple or red tops,' and (4) 'greystones,' according to the colour of the upper part of the 'root.' The greystone variety has its upper part mottled with transverse green and purple streaks.

B. **Yellow-fleshed varieties.**

Many of these are supposed to be hybrids between the turnip and swede. Their leaves are rough and grass-green in colour like the turnip, but the flesh resembles that of the swede in colour and firmness. These varieties are more robust, of slower growth, and superior feeding value to the white-fleshed turnips: they are, moreover, less injured by frost and keep sound for a longer period during winter.

Yellow-fleshed varieties are conveniently divided into (1) 'yellow tops,' (2) 'green tops,' and (3) 'purple tops' according to the colour of the upper part of the 'root.'

8. **Swede Turnips** (*Brassica Napo-brassica* D.C. and *Brassica Rutabaga* L.).

These plants are grown for the same purpose as the turnip. They differ from the latter, however, in the following points:—

(1) The first foliage-leaves of the seedling swede are rough like those of the turnip, but glaucous in colour, never grass-green. The leaves developed later are smooth and glaucous.

(2) The swede has a distinct short stem or 'neck' on the upper part of the thickened 'root' with well-marked leaf-scars upon it (Fig. 120).

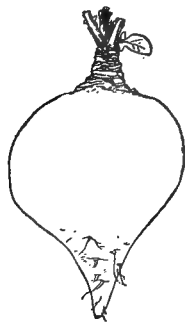

(3) The 'roots' are rarely so perfect in form and outline as those of the turnip; there are fewer distinct varieties of swedes.

(4) The 'flesh' of one form is white (*B. Napo-Brassica* D.C.), that of *B. Rutabaga* L. being yellow or reddish orange; it is firmer, more solid, and more nutritious than that of the turnip.

The 'roots' keep much better during winter, and are easily stored for use in spring.

FIG. 120.—Swede turnip 'root.' Observe the elongated 'neck,' and compare with Fig. 119.

(5) The flowers of the white-fleshed swede are large and bright canary yellow; those of the yellow-fleshed variety are buff yellow or pale orange colour.

(6) The seeds are usually larger and of darker colour than those of the turnip.

CLIMATE AND SOIL.—For perfect development, both common turnips and swede turnips require a somewhat damp, dull climate, the north of England producing much finer crops than the south. Where the air is dry the yield of 'roots' is small.

The best soils for their growth are open loams, the common turnips being grown on the lighter kinds, swedes upon the stiffer loams. Neither of them can be grown very satisfactorily upon stiff wet clays, nor on dry sands or gravels.

SOWING.—Turnips are drilled in rows on ridges where the rainfall is considerable, and on the flat in warm, dry climates.

The distance between rows varies from 18 to 25 in. for white and yellow turnips, and 20 to 27 in. for swedes.

Common turnips being of more rapid growth are usually sown later than swede turnips.

The sowing of the main crop of swede turnips usually takes place from the middle to the end of May in the north; the yellow-fleshed turnips are sown somewhat later, and the white turnips last of all, namely, from June 1st to 20th. In the south of England these crops are sown about a month later than in the north.

The amount of seed used is from 2 to 3½ lbs. per acre; the plants are singled so as to stand from 11 to 13 inches apart in the rows.

For feeding early in autumn small areas are often sown earlier than the dates mentioned above.

Turnips may also be sown in August in order to provide green leafy succulent food for sheep in spring.

YIELD.—The average crop of white turnips weighs from 20 to 25 tons, yellow-fleshed turnips about 20 tons, and swedes from 15 to 20 tons per acre.

COMPOSITION.—White turnips usually contain from 91 to 93 per cent. of water; swedes about 89 per cent.; although in well-grown crops of the latter the water-content is often as low as 87 per cent. A great deal of variation exists; even 'roots' growing near together in the same field sometimes vary widely in water-content, and the particular variety, or 'strain' of seed, manuring, width of row, soil, climate, and ripeness, all influence the composition.

The amount of soluble carbohydrates, most of which is sugar, averages about 5½ per cent. in well-matured white turnips and a little over 7 per cent. in swedes. The fat-content is usually the same in both, namely, .2 per cent., the albuminoids in white turnips average .5 per cent., in swedes about .7 per cent.; the fibre .7 and .8 per cent. respectively.

'Roots' of large size almost invariably contain more water, and are therefore poorer in dry matter than smaller ones. The difference is most marked in white-fleshed turnips, but swedes, and we may say all 'roots,' exhibit similar variation in composition.

It is instructive to note that in two 'root' crops whose water-content is 87 and 92 per cent. respectively, every hundred lbs. of the former contains 13 lbs. of dry substance, while 100 lbs. of the latter yield 8 lbs. of solid substance when completely dried: in other words, 20 tons of the former are equal in dry weight to more than 32 tons of the latter. Differences in water-content similar to these ordinarily exist between average crops of swedes and white turnips, and even the same variations in composition have been met with in two swede crops, one composed of somewhat small well-matured 'roots,' the other consisting of very large immature 'show roots.'

As the turnip 'root' matures the percentage of water in it decreases, and the percentage of carbohydrates, principally sugars, increases.

The dry substance of the 'root' also alters in composition as the ripening proceeds; in unripe roots much of the nitrogen exists in the form of amides, compounds which are of little nutrient value, whereas in mature roots the amides have largely disappeared, being transformed into useful albuminoids.

9. **A good turnip.**—The following points are important in determining the value of a turnip or swede.

(1) The yield should be high.

(2) The feeding-quality, so far as composition is concerned, should be good; roots of high specific gravity are generally more valuable in this respect than those of low specific gravity.

(3) Their resistance to frost is to be considered. It is to some extent dependent on inherent vital differences, and also to the manner of growth of the 'root'; varieties which grow mainly buried in the soil are usually more resistant to frost than those whose 'roots' are mainly above the surface of the soil.

(4) Varieties which stand well out of the ground are however more easily pulled up and more readily and completely consumed by sheep than those deeply buried.

(5) Turnips should have no 'neck' and that of the swede

should be thin. The 'skins' of the fleshy 'root' should be as thin, smooth, and tender as possible. Both the tap root and leafy top should be single and small. Turnips or swedes with several tops and fang-like roots, as in 5, Fig. 119, are generally of poor feeding-quality, and involve much waste in their consumption.

The upper part of the 'root' should be convex; when concave, as partially seen in 4, Fig. 119, rain-water is liable to be held in the depression and decay thereby encouraged.

10. **Rape, Cole, Coleseed** (*Brassica Napus* L.).—This plant is a biennial, grown in many places instead of a turnip crop, and as a 'catch crop' for its succulent leaves and stems which are utilised as food for sheep.

The seeds are dark purple or black, and the young plants have glaucous foliage-leaves which are sparsely covered with rough hairs. Both seeds and seedlings are identical in appearance with those of swede turnips, and not unfrequently rape seed has been sown in mistake for that of the swede, and the young plants hoed out as for a root crop; in such instances it is impossible to detect the error until the plants have grown some time, when the want of 'bulbing' propensity betrays them.

The root is slender; the stem which grows to a height of 2 feet or more is smooth, with many branches. The lower leaves are lyrate, the upper ones ovate-lanceolate, clasping the stem. The flowers are bright yellow, and therefore differ in colour from those of the swede.

Seed is sown at intervals, usually from May onward, in order to provide a succession of crops during the autumn and winter.

It is generally sufficiently advanced in three months from the time of sowing to provide a large bulk of green food.

The seed is sown broadcast, at the rate of 10 lbs. per acre, or more frequently drilled at the rate of 4 or 5 pounds per acre. In the latter case, the superabundant young plants are hoed out

and the remainder left a little nearer together than the 'roots' of a white turnip crop.

The green rape crop usually contains about 86 per cent. of water, 4 per cent. digestible carbohydrates, and 2 per cent. of albuminoids.

The seeds are very rich in oil, usually averaging about 42 per cent. of this constituent.

11. Oil-Yielding Rapes.—On the Continent several forms of plants belonging to the genus *Brassica* are grown for their seeds, from which oil is expressed or extracted, and the refuse sold as 'rape cake.' In this country the oil is sold indiscriminately as colza oil or rape oil.

One of these oil-yielding plants greatly resembles the swede except in its roots, which are not fleshy. Its flowers are pale yellow. This is the same plant as that grown in this country chiefly as a green fodder crop, and known as rape, cole, or coleseed. The winter variety, of which there are several named strains, is sown usually in August, and the seed harvested in the following June and July. This variety gives the largest yield of the best oil. There is also a summer variety of the same plant which is sown in April and harvested in September of the same year: it is not quite so rich in oil, and gives a poorer yield than the winter one.

Besides the above, an oil-yielding plant is grown which resembles the turnip, except in its want of a thick fleshy 'root.' The oil from its seeds is sold as rape or colza oil. There are also winter and summer varieties of this 'rape,' the first sown in August and September, and the second in May. They differ from the previously mentioned rape in ripening earlier. Moreover, they are smaller plants, give a smaller yield of oil, and are more suited to sandy soils; they are also hardier than the swede-like rape. None of these forms of turnip-like 'rape' are grown in this country.

12. The nomenclature and relationship of these forms of

Brassica to each other is not clear, as hybrids and crosses are frequent. Possibly all are derived from one species: some authorities are, however, disposed to notice two species with varieties, thus:—

Species 1. *Brassica campestris* L.

Oil-yielding summer variety :	form <i>annua</i> .	(a) Summer turnip-like Rape.
Do. winter do. :	form <i>oleifera</i> .	(b) Winter do. do.
Variety with thick fleshy 'root' :	form <i>rapifera</i>	} (c) Common White Turnip.
	= <i>B. Rapa</i> L.	

Species 2. *Brassica Napus* L.

Oil-yielding summer variety :	form <i>annua</i> .	(a) Summer Swede-like Rape.
Do. winter do. :	form <i>oleifera</i> .	(b) Winter do. do.
Variety with thick fleshy 'root' :	form <i>rapifera</i> :	Swede Turnip :
	<i>B. Napo-brassica</i> D.C.	i. white-fleshed.
	<i>B. Rutabaga</i> .	ii. yellow- do.

13. **Black, Brown, or Red Mustard** (*Brassica nigra* Koch. = *Sinapis nigra* L.).—An annual plant grown for its seeds. The latter are ground and the 'flour,' after removal of the dark-coloured testas, is used as a condiment, namely, ordinary table mustard.

The seeds contain oil which is sometimes extracted and used for burning in lamps, in the same manner as rape or colza oil.

The plant is a wild indigenous plant in this country, but most frequently met with under hedges and in waste places as an escape from cultivation. The seeds have the property of remaining in the ground for several years without germinating, and when a crop is once allowed to seed, some of the shed seed is certain to give rise to plants in many of the subsequent crops grown on the same land. It may thus become a troublesome pest of arable land.

SEED AND GERMINATION. — The seeds are oval with a reddish-brown coloured testa when well harvested, and the

seedling resembles that of a turnip plant with somewhat small cotyledons.

STEM AND LEAVES.—The stem grows to a height of 2 or 3 feet, and is branched and covered with rough hairs. The lower leaves are large and rough, lyrate, and of a light green colour: the upper leaves lanceolate and smooth.

INFLORESCENCE, FLOWER, AND FRUIT.—The inflorescence is a long raceme; the flowers are small, about $\frac{1}{3}$ to $\frac{1}{2}$ an inch across, have spreading narrow sepals and pale yellow petals, the broad parts of which are slightly notched.

The fruit, which grows upright, and closely adpressed to the stem, is a somewhat short smooth silique about $\frac{1}{2}$ to $\frac{3}{4}$ of an inch long with a short slender beak (5, Fig. 123); each valve of the silique has a single strong well-marked longitudinal nerve. When ripe the pods and seeds are of dark colour, hence the name Black Mustard.

The whole plant resembles charlock, but can readily be distinguished from the latter by the length, shape, position and nerves of its siliques.

Black mustard requires for its growth a deep, rich, fertile soil, on which it is generally sown broadcast, at the end of March or beginning of April. It is hoed and thinned in May and then left until September, when it is cut rather green and allowed to ripen in small carefully made stacks.

COMPOSITION.—The seeds of black mustard contain about 25 per cent. of a fixed oil, which is sometimes extracted from the 'dressings' obtained in the manufacture of table mustard, and used for adulterating or mixing with rape and other oils. The seeds when ground and mixed with water give rise to a somewhat volatile product known as 'mustard oil'; the latter does not, however, exist ready formed in the seed, but is produced by the action of an enzyme, *myrosin*, upon a glucoside known as *sinigrin* or potassium myronate, both of which are present in the seeds. In the presence of water the myrosin decomposes

the potassium myronate, splitting it into potassium hydrogen sulphate, sugar and allylthiocarbimid or '*mustard oil*.'

The decomposition may be represented thus :—

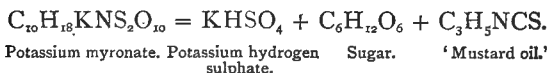

'Mustard oil' has an extremely pungent taste and smell ; it gives off vapour, small quantities of which bring tears to the eyes ; when the oil is applied to the skin, it immediately produces blisters.

14. **White Mustard** (*Brassica alba* Vis. = *Sinapis alba* L.).—An annual plant grown chiefly as food for sheep in this country, and for ploughing in as a green manure to enrich the ground in humus. Its seeds are also used for the manufacture of oil, and for the preparation of table mustard as in the last species. Young seedlings are used as a salad with cress.

Some botanists consider white mustard not a true native of the British Isles.

When grown for seed it does not occasion any trouble as a weed in subsequent crops after the manner of black mustard, as its seeds all germinate at once when conditions are favourable, and the young plants are then readily destroyed.

SEED AND GERMINATION.—The seeds are much larger than those of black mustard and pale yellow.

The seedling has notched cotyledons, and its first foliage-leaves are pinnatifid or pinnately lobed, as in Fig. 5, thus differing from turnip and black mustard.

STEM AND LEAVES.—The stem grows from 1 to 3 feet high, and is generally branched and covered with rough hairs.

All the leaves are bright green and rough ; they are lyrate-pinnatifid or pinnate, with irregular lobes. The terminal lobe of the leaf is usually small compared with those of the leaves of turnip and black mustard.

INFLORESCENCE, FLOWER AND FRUIT.—The inflorescence is a long raceme, the flowers small, about $\frac{1}{2}$ an inch across, with narrow spreading sepals and pale yellow petals. The fruit is a hisped silique, about $1\frac{1}{2}$ or 2 inches long, with a long, slightly curved sword-shaped beak; the valves of the silique have three nerves.

When ripe the siliques and seeds are of pale colour, hence the name white mustard in contrast to the black species with dark-coloured siliques and seeds.

Its leaves and siliques at once distinguish it from the other species of *Brassica* mentioned.

For sheep-feed it is usually sown broadcast any time from April to August, at the rate of 20 lbs. of seed per acre. Its chief merit is its very rapid growth, which makes it of service for catch-cropping after vetches, potatoes, and other similar crops, or where turnips have failed and the time for sowing a more useful crop has past. It is ready for folding with sheep from six to eight weeks after the seed is sown. For use as 'green manure' it is generally sown in July or August and ploughed in during October and November.

COMPOSITION.—The green plant in full bloom contains on an average about 83 per cent. of water, $7\frac{1}{2}$ per cent. of carbohydrates, 2 per cent. albuminoids, and 6 per cent. fibre.

The seeds contain $26\frac{1}{2}$ per cent. of a fixed oil similar to that in other cruciferous seeds; when extracted it is used for mixing with rape oil.

The seeds of white mustard when ground and stirred with cold water, have not the odour so characteristic of the black species; nevertheless the pungent taste is very similar in both species.

A glucoside, which is named *sinalbin*, is present in the seeds of white mustard, and also myrosin. When water is added to both, the myrosin decomposes the sinalbin into sugar, an acid salt of sinapin, and sinalbin mustard oil ($C_7H_7O \cdot NCS$).

The latter is somewhat less pungent than allyl mustard oil obtained from black mustard seeds and is not volatile at ordinary temperatures.

15. **Charlock** (*Brassica Sinapis* Vis. = *Sinapis arvensis* L.).—A native annual unfortunately often too common in corn fields.

SEED AND GERMINATION.—The seeds are dark brown similar in size to those of turnip, from which they cannot be readily distinguished when the two are mixed. When sown they germinate irregularly and often remain capable of growth for several years when deeply buried in the soil.

The seeds contain a considerable amount of oil and are sold by many farmers to oil-cake manufacturers, finally appearing as impurities in rape and other 'cakes.'

The seedling is somewhat like that of a turnip, but can be distinguished from the latter by the first foliage-leaves, which are a darker green colour and of longer and somewhat different shape (*B*, Fig. 117). It is more pungent in taste than a seedling turnip.

STEM AND LEAVES.—The stem is rough from 1 to 2 feet high and branched. The lower leaves are stalked, ovate, partially lyrate or lobed, the upper ones lanceolate, irregularly serrate, and sessile.

INFLORESCENCE, FLOWER AND FRUIT.—The inflorescence is a raceme. The flowers are larger than those of black mustard, being generally $\frac{1}{2}$ to $\frac{3}{4}$ of an inch across; they possess spreading narrow sepals, and pale yellow petals.

The fruit is a silique from 1 to 2 inches long, usually with rough deflexed hairs upon it, but occasionally smooth; the valves of the silique have three faint veins (*2*, Fig. 123).

The whole plant resembles that of black mustard, but has larger flowers and differently shaped siliques, which latter are spreading and not pressed to the stem.

16. TABLE OF THE CHIEF DISTINCTIONS BETWEEN THE
COMMON SPECIES OF BRASSICA.

A. Sepals erect or nearly so (Fig. 121).

i. Leaves of 1st year's plant glaucous (ashy grey).

a. All leaves smooth, flowers pale lemon yellow. **Cabbage.**

b. First leaves of seedling with a few stiff hairs, flowers buff, or pale yellow. **Swede and swede-like 'Rape.'**



FIG. 121.—Flower of cabbage, showing erect sepals, s.

ii. Leaves of 1st year's plant grass-green with stiff hairs, flowers bright yellow. **Turnip and turnip-like Rape.**



FIG. 122.—Flower of charlock, showing spreading sepals, s.

B. Sepals spreading (Fig. 122).

i. Siliques erect, closely pressed to main axis on which they grow : valve of silique with one nerve. **Black Mustard.**

ii. Siliques spreading, valve of silique with three nerves.

a. Silique with sword-like 'beak,' seeds pale yellow or straw-colour. **White Mustard.**

b. Silique with cylindrical straight beak, seeds dark-brown. **Charlock.**

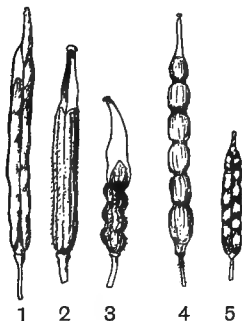

FIG. 123.—Siliques of: 1. Turnip (*Brassica Rapa* L.). 2. Charlock (*Brassica Sinapis* Vis.). 3. White Mustard (*Brassica alba* Vis.). 4. Wild Radish (*Raphanus Raphanistrum* L.). 5. Black Mustard (*Brassica nigra* Koch.).

17. **Wild Radish: Jointed Charlock** (*Raphanus Raphanistrum* L.). — An annual weed common and troublesome in cornfields in many districts although unknown in others.

The stems are from 1 to 2 feet high and covered with scattered rough hairs. The leaves are rough, coarsely serrate, and simply lyrate (with few pinnatifid segments and a large terminal lobe). It has racemose inflorescences. The flowers are about $\frac{3}{4}$ of an inch across with erect sepals, and usually pale straw-coloured petals often veined with purple lines; occasionally the petals are white or pale lilac tint.

The siliques, which are from 1 to 3 inches long, have long slender beaks and are constricted above and below each seed (4, Fig. 123) ; they are indehiscent, but separate at the 'joints' into barrel-shaped pieces, each containing a single seed.

The seeds are oval and reddish-brown in colour.

The whole plant somewhat resembles ordinary Charlock, but may be distinguished from the latter by its erect sepals, usually veined petals, and smooth 'jointed' siliques.

Ex. 191.—Examine seeds of cabbage, swede and turnip in bulk, and individually with a lens. Compare them with seeds of black mustard and charlock. Taste all of them separately in the above order and note any differences in flavour.

Ex. 192.—Grow seedlings of cabbage, swede turnip, black mustard, white mustard, and charlock. Note the shape of the cotyledons and first leaves of each.

Ex. 193.—Compare the external appearance of a full grown swede with that of a white turnip.

Ex. 194.—Carefully examine and describe the leaves, flowers and fruits of the crucifers mentioned in detail in the text, and draw up a table of differences, paying special attention to the calyx, the colour and form of the corolla, and the form of the siliques.

Ex. 195.—Watch the growth of the fleshy 'root' of a turnip or swede. Find out which part is hypocotyl and which true root. Make marks with Indian ink, $\frac{1}{8}$ of an inch apart, on the hypocotyl of young seedlings, and note their position from day to day.

Ex. 196.—Make careful observation on the development of a kohlrabi plant from the young seedling stage up to the time when the stem is 2 inches thick. Find out whether the part of the stem above or below the cotyledons thickens most.

Ex. 197.—Grow brussels sprouts, savoy, broccoli, and thousand-headed kail side by side and watch their development : make notes of the differences in length of stem and the development of the buds in the axils of the leaves upon it, in each kind of plant.

Ex. 198.—Examine the various forms of cabbage when the inflorescences are well developed and their flowers open.

Are the flowers of the different forms alike in all respects ?

Ex. 199.—Compare and contrast longitudinal and transverse sections of a turnip, a carrot and a mangel respectively.

Ex. 200.—Procure a small amount of seed of each of the chief kinds of turnips and swedes from various seedsmen. Sow short rows of each on the farm in order to become acquainted with the form and colours of the root, and the hardness and colour of the flesh. Note the differences in the size of the neck and tap root, and the amount of 'root' above and below ground.

Ex. 201.—Sow a few seeds of rape or cole and swede side by side in different rows or in different pots of earth and compare the seedlings before and after the foliage-leaves appear. How soon does the swede show that it differs from the rape plant?

Ex. 202.—Grind up the seeds of black mustard and mix with water: do the same with those of white mustard. Smell and taste both.

Ex. 203.—The student should become acquainted with such common crucifers as shepherd's-purse, Jack-by-the-hedge, and hedge mustard.

CHAPTER XXVIII.

LINACEÆ.

1. **General Characters of the Order.**—Herbs, shrubs, or trees. Leaves simple, entire, generally alternate and exstipulate, or with small stipules only.

Flowers regular, hypogynous. Calyx, inferior, four or five sepals, persistent. Corolla polypetalous, four or five petals twisted or imbricate in the bud, soon falling.

Andrœcium of four or five perfect stamens, often alternating with a similar number of teeth or abortive stamens, all united to a hypogynous ring.

Gynœcium, syncarpous, three to five carpels, the ovary having three to five loculi, each of which is sometimes partially divided by a false dissepiment.

One or two pendulous ovules in each loculus.

Fruit, a roundish capsule, splitting along the dissepiments.

Seeds eight or ten in each fruit, with a small amount of endosperm and a straight embryo.

The Linaceæ comprises a small Order of about 150 species.

The genus *Linum* includes about ninety species, some of which are cultivated in gardens on account of their brilliantly coloured flowers. The most important species belonging to the Order is Flax or Linseed (*Linum usitatissimum* L.).

2. **Flax or Linseed** (*Linum usitatissimum* L.).—Flax has been grown from time immemorial for the manufacture of linen, a

fabric which is woven from the bast fibres of the stem of the plant.

The plant is also grown for its seeds, which contain a large quantity of oil. The latter is extracted and sold under the name of linseed oil, the crushed seed after extraction of most of its oil being made up into oilcake and utilised by the farmer for feeding stock.

The original unextracted seed is sometimes employed as food for calves and other animals, and the fibre of the stem, in addition to its being used in the manufacture of linen, is also made into a tough and very durable paper.

SEED AND SEEDLING.—The seeds are oval and flattened, about 4 to 6 mm. long, of a yellowish brown colour and possessing a smooth shining surface. The epidermis of the coat of the seed is formed of cubical cells with very thick walls, consisting of a peculiar mucilaginous substance, which swells up into a slimy mass when put in water.

Within the seed coat is a small amount of endosperm and a large straight embryo. Germination takes place readily when fresh seed is sown, and the young plant sends its two elliptical cotyledons above ground.

ROOT.—The root-system of the plant is comparatively small, consisting of a weak tap-root and a few short lateral roots, none of which penetrate deeply into the soil.

STEM.—The stem is slender, and when the plants are grown closely together for the production of good fibre, rises to a height of 1 to 2 feet without branching, except in its upper part.

The internal arrangement of the structural elements is seen in Fig. 123A, where a portion of a transverse section of the stem is given. On the outside is a well-marked epidermis, beneath which comes the cortex, consisting of parenchymatous cells, some of which contain chloroplastids. Next is observed an interrupted ring of bast fibres, arranged

in larger or smaller bundles. Some of the larger bundles have from twenty to thirty fibres in each, and are very strong.

In a full-grown stem each fibre has a very thick cell-wall and small cell-cavity: it is pointed at each end, and varies in length from 4 to 66 mm.

The fibrous bast strands or 'flax' when isolated are a pale yellowish tint in the best kinds of plants, and possess a silky lustre.

When flax fibre is the object for which the plant is grown the stems are carefully pulled by hand before the seed is ripe, and laid on the ground for about a day, during which time they dry a little.

The following day the stems are tied into small straight sheaves, 4 to 8

inches in diameter, and the latter are then set up in stooks to dry more completely. In eight or ten days the plants are 'rippled,' that is, the seed capsules are removed by pulling the stems between the teeth of iron combs. The capsules are afterwards threshed and the seed is either kept for sowing, or, if unripe, utilised by the oil-crusher. After cutting off the roots, the stems are subjected to the process of 'retting' or rotting, the object of which is to loosen the tissues of the stem so that the bast fibres can be easily freed from the cortex, wood, and other parts of the stem.

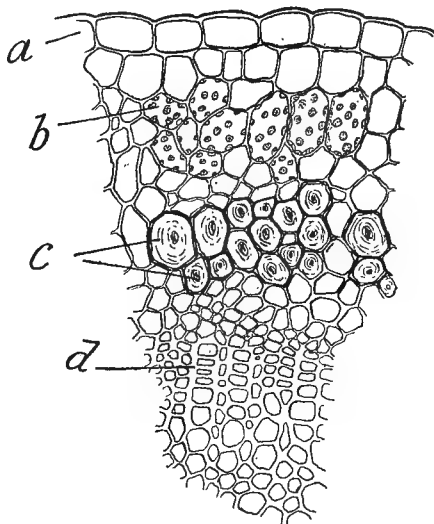

FIG. 123A.—Transverse section of portion of a Flax stem. *a*, epidermis; *b*, cortex; *c*, bast fibres ('flax'); *d*, wood or xylem of the stem.

Various methods of 'retting' are practised in different districts, one of the oldest and best being that adopted in the Courtrai district of Belgium.

The dry flax stems are there kept from the time of harvesting in one season until the middle of April or later in the following year. They are then tied into bundles and sunk in crates in the River Lys. After remaining under water seven or eight days the bundles are taken out and arranged in small stacks to dry.

When dry they are sunk a second time for ten or twelve days, and after being removed from the river and dried again, the 'retting' is complete.

During this process the middle lamella between the adjoining cells of the tissues forming the stem becomes more or less completely dissolved, and the component cells are loosened from each other. The middle lamella, according to Mangin, consists of calcium pectate, and its solution is brought about by the fermentative activity of two or three kinds of bacteria, most of which are anaërobic or nearly so, carrying on their work best in the presence of a small amount of oxygen only, under conditions which obtain below water. These organisms are most active at a temperature of 18° to 20° C.

After the retting is completed the dried flax stems are subjected to the processes of 'breaking' and 'scutching' in order to separate the brittle epidermal and woody parts from the more elastic tough fibres.

LEAVES.—The leaves are small, linear-lanceolate in shape, with smooth surfaces, and arranged alternately on the stems.

INFLORESCENCE AND FLOWERS.—The upper part of the single stems are branched in a corymbose manner, and the flowers are borne on these branches in many-flowered cymes.

The sepals are five in number, ovate, pointed and ciliate. The polypetalous corolla is twisted when in bud and consists of five blue or white delicate thin petals, which readily fall after a few days; these are connected to a hypogynous ring or disk on which are five glands probably representing abortive stamens opposite to the petals.

The flower possesses five stamens, and on the ovary are five long styles. The ovary is five-celled, the cells being

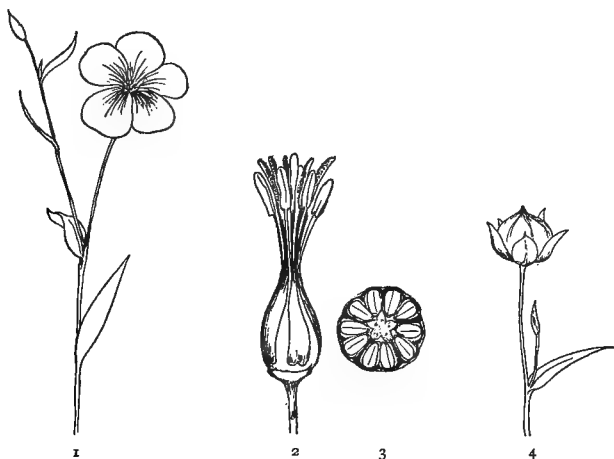

FIG. 123B.—1. Flower and portion of stem of Flax (*Linum usitatissimum* L.). 2. Gynæcium and androecium. 3. Transverse section of ovary. 4. Ripe capsule.

divided into two by spurious dissepiments, in each of which is a single ovule (Fig. 123B).

THE FRUIT is a capsule (Fig. 123B), which splits longitudinally when ripe and sets free the ten seeds within.

VARIETIES.—The typical form of *Linum usitatissimum* L., grown for flax production, is an annual with an upright solitary stem and capsules which remain closed when ripe: the partitions in the capsules are smooth. A variety (*L. humile*

Miller = *L. crepitans* Böning.), grown in some countries for oil seeds, has dwarfer, more branched stems and larger capsules, which open and set free their seeds when ripe; the dissepiments are hairy.

CLIMATE AND SOIL.—Flax succeeds best in a moderately damp and warm climate. The soil most adapted for its growth is a deep, well-drained, sandy loam, although it can be cultivated upon a variety of soils, so long as they are not too dry and are free from stagnant water.

On stiff clays, peaty soils, or soil containing much lime, flax produces fibre poor in quality.

SOWING.—As young flax plants are very easily destroyed by a sharp frost, the seed should not be sown until all likelihood of damage in this manner is past.

The middle of April is soon enough for most districts in which the crop is grown; but it is sometimes sown as early as March or as late as May. The earlier the better, for early seeding not only increases the yield and quality of the fibre, but there is also more time left for the drying and other processes connected with the preparation of the stem before 'retting'; the ground is shaded early in the season, and the moisture in the soil thereby preserved from loss by evaporation.

The amount of seed to be used for sowing varies according as the crop is to be grown for fibre alone, for fibre and unripe seed, or for seed only.

When the crop is cultivated for its fibre, or chiefly for the fibre with a certain amount of partially ripened seed, the plants should stand closely together, so as to induce the production of long thin unbranched stems; a thick seeding is therefore needed, and the amount in such cases should be not less than 3 bushels of seed, or about 160 to 170 lbs. per acre.

If a crop of ripe seed is desired, the plants should have plenty of room for healthy development, and from 70 to 100 lbs. of

seed per acre is enough, the smaller amount being used when the seed is drilled in rows 5 or 6 inches apart, the latter when it is broadcasted by hand.

The seed saved from a partially-ripened crop of flax grown mainly for the fibre, should be used for oil extraction and oilcake manufacture, and not for sowing for another fibre crop.

The best yield of flax, so far as fibre is concerned, is said by some to be obtained from seed which has been carefully dried and kept in tightly closed barrels which exclude moisture for two or three years, experiments having shown that seed stored in this way gives longer stems and finer bast than fresh seed; others consider that the highest yield of fibre is secured from the fully ripened seed, harvested from a crop raised from 'barrel' flax seed.

Flax seed is readily damaged by heating, especially when damp, and is liable to lose its germinating power very quickly unless care is exercised in its storage. It should have a germination capacity of 90 per cent. at least, and should be sown at a uniform depth on a clean, well-prepared seed bed.

HARVESTING AND YIELD.—The crop is harvested in different ways, according to the kind of produce required. Where the finest white silky flax is the object, the plants are pulled up soon after the fall of the petals of the flowers, at which time the stems are still green in the upper parts, although the lower half is yellow and has lost its leaves. The seeds in the young capsules are then whitish in colour. Where both seed for oil-crushing and flax are wanted, the crop is taken when the stem and capsules have turned yellow, the seeds being then brown and well formed. The flax produced is greater in bulk but is coarser in texture, and does not become so white when bleached as in the case of plants harvested earlier.

Where only seed for sowing is needed, it is essential that the plants be allowed to stand until dead ripe.

The yield of raw flax, that is, the dry stems after the retting process, varies from $\frac{3}{4}$ to $1\frac{1}{2}$ tons per acre. About 80 per cent. of this is removed in the breaking and scutching processes, about 20 per cent. (*i.e.* 3 to 6 cwt.) remaining as fine scutched flax.

The seed obtained from a crop grown for fibre should not be more than about 4 cwt. per acre; when the crop is grown for seed only, the amount produced varies from 8 to 11 cwt. per acre.

COMPOSITION.—The seeds from the ripe capsule contain from 31 to 39 per cent. of linseed oil and from 19 to 25 per cent. of nitrogenous substances, chiefly proteins in the form of large aleuron-grains; these reserve foods are stored both in the endosperm and in the cotyledons of the embryo.

The oil is used in the preparation of varnishes, oil-paint, and printers' ink, for the manufacture of soft-soap and oilcloth, and partially as food in some countries.

The nitrogen-free extract, consisting of the mucilage of the epidermis of the seed and hemicelluloses of the cell-walls of the embryo and endosperm, averages 22 per cent., the amount of water generally 12 per cent., the woody fibre 5 or 6, and the ash about 4.3 per cent. of the seed.

The residue of the seed, after extracting the oil, is made into linseed 'oilcake,' the composition of which varies very much according to the method adopted for extraction.

Linseed cake of fair average composition usually contains from 11 to 12 per cent. of water, 10 to 12 per cent. of oil, 28 or 29 per cent. of nitrogenous substances, 29 to 30 of carbohydrates, 9.5 to 11 of fibre, and 7.7 to 8.8 per cent. of ash.

CHAPTER XXIX.

ROSACEÆ.

1. **General characters of the Order.** — Flowers regular, and usually perigynous. Calyx gamosepalous, five sepals; in some genera an epicalyx is present. (See strawberry below.) Corolla polypetalous, five petals. Andrœcium, usually of many stamens. Gynœcium, apocarpous, sometimes more or less syncarpous, one or many carpels. Fruit various. Seeds endospermous.

The Order Rosaceæ comprises about 1000 species of herbs, shrubs, and trees. The leaves are generally compound, and possess stipules.

There is no plant of the Order of much importance to the farmer as a fodder crop, but all our most valuable edible fruits of the orchard and garden belong to it. The genera, the structure of whose fruits it is important to notice, are mentioned below.

2. Genus *Prunus*. **Plums and Cherries.**—The plants of this genus are shrubs or trees with simple leaves. The flowers are perigynous; the receptacle has the form of a hollow cup, around the edge of which are arranged five sepals, five petals, and fifteen to twenty stamens (Fig. 124.). The single carpel, which possesses a long terminal style and two ovules, is placed at the bottom of the hollow receptacle. After fertilisation the latter divides by a circular cut near its base at *f*, Fig. 124, and soon withers and falls off, carrying the calyx, corolla, and andrœcium with it. Sometimes the withered receptacle and its appendages remain for a time surrounding the growing carpel.

Eventually the single carpel which is left develops into a drupe (the fruit) (*B*, Fig. 124). The ovary wall (*p*) increases in thickness, and when ripe exhibits three layers of tissue of different texture, viz. : (1) an inner, hard, bony layer (*e*) next the seed termed the 'stone' of the fruit or *endocarp*, consisting of sclerenchymatous cells; (2) a soft parenchymatous layer (*m*)—the 'flesh' or *mesocarp*—with sweet cell-sap; and (3) an outer thin skin or *epicarp*.

During the early growth, increase in size of the fruit proceeds

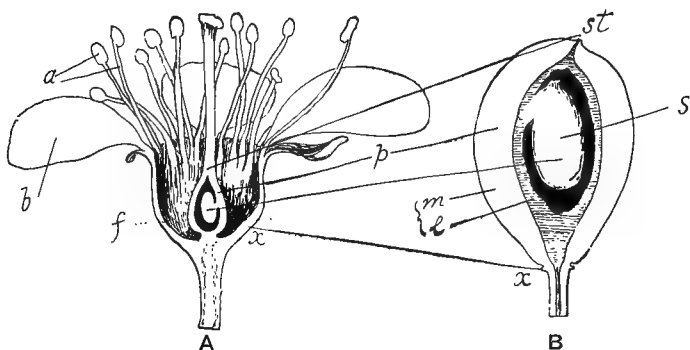

FIG. 124.—*A*, Vertical section of the flower of a plum. *x* Receptacle; *o* petal; *a* stamens; *p* ovary, inside which is seen an ovule. The part of the receptacle above the line *f* falls off after fertilisation.

B, Fruit (drupe) developed from the gynaecium of the flower *A*. *p* The pericarp, of which *e* is the endocarp or 'stone'; *m* the mesocarp or 'flesh'; *s* seed; *st* point where style has fallen off; *x* small remaining part of the receptacle.

rapidly up to what is known as the 'stoning period' when the endocarp is beginning to harden, at which time growth in diameter almost ceases. As soon as the 'stone' has become firm the fruit begins again to increase in diameter, the chief growth in thickness taking place in the mesocarp.

3. A glucoside, known as amygdalin, is present in the bark, leaves, and seeds of many species of this genus: it is a non-poisonous compound, but under the influence of the enzyme, *emulsin*, which is often associated with it, amygdalin decomposes

into benzaldehyde (oil of bitter almonds), sugar, and the very poisonous prussic acid.

4. The chief species of *Prunus* are the sloe, bullace, plum, cherry, apricot, almond, and peach.

They may be divided into two groups according to the way in which the leaves are packed on the bud.

SECTION I.—Leaves rolled in the bud.

Sloe or Black-thorn (*Prunus spinosa* L.).—A small shrub, with almost black bark, many spiny branches, and white protogynous flowers which appear in spring before the narrow lanceolate foliage leaves. The fruit is a small round drupe, about $\frac{1}{2}$ an inch in diameter, with a glaucous 'bloom' and smooth peduncle.

Bullace (*Prunus insititia* L.).—A shrubby tree with a few spiny branches and dark-brown bark. The young twigs are usually covered with a soft down, and the broader almost ovate leaves are also downy on the under surfaces. The flowers are white and usually appear with the leaves. The round fruits are black or yellow, about $\frac{3}{4}$ to 1 inch in diameter, with downy peduncles and glaucous bloom.

The damson is a form of bullace with oval fruits.

Wild Plum (*Prunus domestica* L.).—This is a small tree similar to the Bullace in the shape of its leaves and the colour of the bark. The branches do not possess spines and are devoid of downy hair. The fruits are oval or oblong, about 1 to $1\frac{1}{2}$ inches long, black, with smooth peduncles.

The wild plum is not a native of this country, although well-established in woods and hedges as an escape from cultivation.

The cultivated plums have arisen from the above and several other species most probably by cross fertilisation: the origin of many varieties is however unknown.

Apricot (*Prunus Armeniaca* L.).—An introduced tree originally derived from Mongolia and Turkestan (not Armenia as its name implies). The branches are smooth and the flowers appear

before the leaves. The fruit is yellow, round or oval, and has a hairy velvety surface.

SECTION II.—Leaves folded in the bud.

Wild Cherry : Dwarf Cherry (*Prunus Cerasus* L.).—A small shrubby tree, from 4 to 8 feet high, with slender branches. The leaves are dark green, smooth on both sides, and possess short petioles.

The inner scales of the flower-buds are leafy and the sepals of the flowers are serrated. The fruit is round and red, with soft, juicy, acid 'flesh.'

This species appears to be the parent of the Morello, Duke, and Kentish cherries.

Gean : 'Wild Cherry' (*Prunus Avium* L.).—A taller tree than the last, often 20 to 30 feet high, with erect, short, rigid branches. The leaves are pale green, somewhat hairy beneath, and with a long petiole; they hang down more than those of the dwarf cherry. None of the scales of the flower-buds are leafy, and the sepals of the flowers are entire. The fruit is heart-shaped, black or red, and has firm bitter flesh.

This species appears to be the parent from which the Heart and Bigarreau cherries have been derived.

Bird Cherry (*Prunus Padus* L.).—A tree from 10 to 20 feet high. It differs from the previously-mentioned cherries in having its flowers in loose pendulous racemes from 3 to 6 inches long. The fruits are round or ovoid and small, about $\frac{1}{4}$ of an inch in diameter, with a bitter taste.

The Almond (*Prunus Amygdalus* Hook. = *Amygdalus communis* L.) has a hairy fruit with a leathery tough mesocarp: when ripe the latter separates irregularly from the woody wrinkled 'stone' which contains the seed. Two races are known, namely, one with bitter the other with 'sweet' seeds.

The Peach (*Prunus Persica* Benth. et Hook. = *Amygdalus Persica* L.) very closely resembles the almond in all characters except those of the fruit. The latter is usually covered with

velvety hair, and has a soft juicy mesocarp; the nectarine, however, which is only a sport from the peach, has smooth-skinned fruits.

Ex. 204.—Examine the flowers of the plum, cherry, and sloe, cut longitudinal sections of the flowers, and note the form of the receptacle and the form and position of the various parts of the flowers, paying special attention to the gynæcium.

Ex. 205.—Watch the development of the ovary of a plum flower, when the latter begins to fade. What becomes of the receptacle?

Ex. 206.—Examine a half-grown plum or cherry. Observe the place where the style was placed on the ovary, and also the position of the ventral suture.

Cut sections both longitudinal and transverse of the ovary every week from the time the flower fades up to the time the fruit is ripe. Note especially the growth in thickness of the parts of pericarp, viz., the endocarp or 'stone,' and the mesocarp or 'flesh.'

Ex. 207.—Measure the diameter of three or four fruits every week and determine when the increase in the diameter is greatest.

Ex. 208.—Make a collection of stones of the different varieties of plums and cherries. In what ways do they differ from each other? Compare the stones of the peach, apricot, and nectarine.

5. Genus *Fragaria*. **Strawberries.**—This genus comprises three or four species of plants all with edible 'spurious fruits,' of which the wild strawberry or any of the garden varieties may be taken as an example.

The calyx of the flower is gamosepalous of five sepals. Outside the calyx, and alternating with it, is a whorl of five sepal-like members, constituting what is known as an *epicalyx*. Each sepal-like member of the epicalyx represents two united stipules belonging to the adjacent true sepals.

A vertical section of the strawberry flower is given in Fig. 125.

The receptacle is of peculiar form: it is a solid roundish or cone-shaped structure, round the base of which extends a flat rim. To the flattened rim is attached the corolla (*b*) of five petals, and the andrœcium of many stamens (*s*); the numerous small carpels constituting the gynæcium are inserted upon the

central raised part of the receptacle. Each carpel has a lateral style, and contains a single ovule. As the calyx, corolla, and andrœcium are inserted on the receptacle surrounding and free from the centrally placed gynœcium the flower is perigynous.

The flowers are protogynous, and cross-pollination is usually effected by insects. In some cultivated varieties the flowers possess no stamens; neither the fruits proper, nor the receptacles of such pistillate flowers develop unless pollen is brought from another flower.

After fertilisation the gynœcium develops into the fruit, which is composed of small one-seeded achenes, and the receptacle

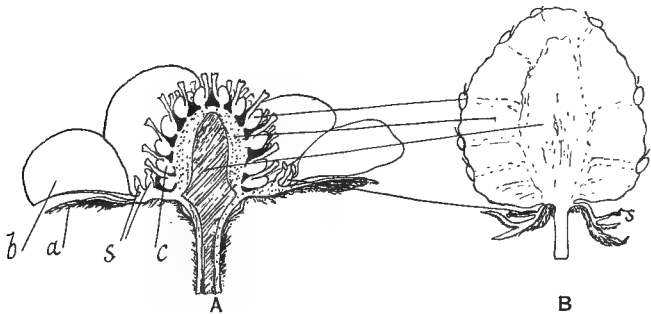

FIG. 125.—*A*, Vertical section of a strawberry flower. *a* Sepal; *b* petal; *s* stamens; *c* carpel.

B, Section of the 'spurious fruit' developed from the flower *A*: the corresponding parts of the flower and 'fruit' are connected by lines.

grows to a large size, becoming at the same time succulent. The succulent growth of the receptacle appears to depend on the fertilisation of the ovules within the carpels; should any of the carpels be injured and fertilisation be prevented, the part of the receptacle on which such carpels are situated does not develop, and the result is a deformed strawberry. The achenes, which at first are crowded together, become much separated from each other by the growth of the receptacle.

It is the receptacle or terminal part of the flower-stalk which

is the edible part of a strawberry, the true fruit (ripened gynæcium) being the achenes.

In some cultivated varieties the flowers possess no stamens ; neither the fruits proper nor their receptacles develop, unless pollen is brought to them from others, hence the necessity of planting kinds bearing staminate or bisexual flowers near them in order to secure a crop of 'fruit' of such varieties.

6. The common Cinquefoils (*Potentilla reptans* L., and *P. Tormentilla* Nesl.) and Silver Weed (*Potentilla anserina* L.) are weeds belonging to the Rosaceæ, with yellow flowers resembling the strawberry in structure ; their receptacles, however, do not become fleshy, and the fruit is a collection of closely arranged achenes.

To an unobservant eye the flowers of some of the *Potentillas* resemble those of the buttercup species of *Ranunculus* : they are, however, readily distinguished from the latter by the possession of an epicalyx and a comparatively large receptacle.

7. Belonging to the Rosaceæ is the genus *Rubus*, of which the **Raspberry** (*Rubus Idæus* L.) and **Blackberry** (*Rubus fruticosus* L.) may be taken as types for study of the flowers and fruit. The flowers of these plants generally resemble those of the strawberry in structure : no epicalyx is present however, and each carpel possesses two ovules instead of one. The flattened border of the receptacle on which the petals and stamens are inserted is broader in the raspberry and blackberry than in the strawberry, but the central lump on which the carpels are placed is very similar in all these flowers.

After fertilisation the central portion of the receptacle, unlike the strawberry, remains comparatively small, and does not become succulent ; the carpels, however, develop into small succulent drupes, which are red or yellow in the raspberry and black or deep purple in the blackberry.

Thus the part which is eaten in the raspberry is a true fruit, consisting of several one-seeded little drupes or *drupels*.

Ex. 209.—Examine the flower of a strawberry. Make sections to illustrate the shape and extent of the receptacle.

Ex. 210.—Watch the growth of a strawberry from day to day until the fruit is nearly ripe. Observe what becomes of the calyx, petals, and stamens.

Examine the form and content of the carpels and the achenes which develop from them.

Make a vertical section of the nearly ripe 'fruit.' Note the distribution of the vascular bundles in it.

Ex. 211.—Compare a raspberry or blackberry flower with that of a strawberry. Watch the growth of the fruit after the flower fades, noting the development of the little drupes from the carpels.

Examine the structure of a young carpel and compare it with that of a drupel.

8. The genus *Rosa* includes the wild **Dog-Rose** (*Rosa canina* L.) and several other indigenous species, as well as the many introduced species and their hybrids and crosses much cultivated as ornamental plants in the garden.

The flowers are markedly perigynous.

In the wild roses the calyx consists of five sepals; the corolla is polypetalous of five large petals, and the andrœcium possesses numerous stamens. The receptacle is deeply-hollowed out like that of the plum, but the upper part is constricted. The gynœcium is apocarpous, and consists of many free carpels inserted on the bottom and sides of the hollow urn-shaped receptacle: the style and stigmas of the carpels protrude through the narrow opening of the receptacle. After fertilisation the carpels develop into achenes with hard, bony pericarps, and the receptacle which surrounds them becomes somewhat fleshy and red.

The 'hip' of the rose is therefore a spurious fruit, which consists of a scarlet or red receptacle inclosing the true fruit (the achenes).

Ex. 212.—Cut a vertical section of the wild rose. Note the form of the receptacle, and compare it with that of a plum, cherry, or sloe.

Observe the number, shape, and structure of the carpels; also the position of the sepals, petals, and stamens of the flower.

What parts of the flower are still present in a ripe 'hip.'

Ex. 213.—Examine the structure of a double garden rose and compare it with that of a wild one.

9. Genus *Pyrus*. To this genus belong the **Pear** (*Pyrus communis* L.), **Apple** (*Pyrus Malus* L.), **Medlar** (*Pyrus germanica* Hook.), and several other species, such as **Mountain Ash** (*Pyrus Aucuparia* Gaert.), **Wild Service** (*Pyrus torminalis* Ehrh.), and **White Beam** (*Pyrus Aria* Sm.).

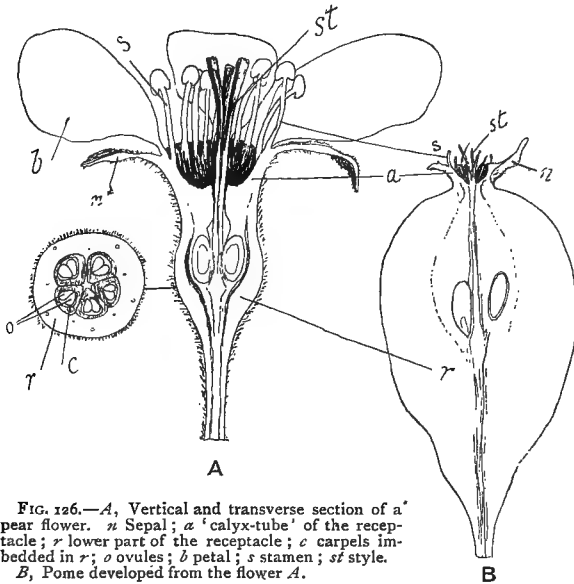

FIG. 126.—*A*, Vertical and transverse section of a pear flower. *n* Sepal; *a* 'calyx-tube' of the receptacle; *r* lower part of the receptacle; *c* carpels imbedded in *r*; *o* ovules; *b* petal; *s* stamen; *st* style.
B, Pome developed from the flower *A*.

The flower and fruit of the pear, illustrated in Fig. 126, may be taken as an example of the genus.

The receptacle of the flower is hollowed out, and the gynæcium, consisting of five carpels, is sunk in the hollow space.

In the plum (*cf.* Fig. 124) and rose, which also have similarly hollowed receptacles, the carpels are free from the sides of the

latter ; but in the pear the ovaries of the carpels are fused with the receptacle, and also united with each other except near their ventral sutures (see the middle of the transverse section, Fig. 126, *A*) and along the styles, which are free. The ovary is inferior and five-chambered : in each carpel are two ovules.

The upper part (*a*) of the receptacle is sometimes termed the *calyx-tube* of the flower ; to it is attached the calyx of five sepals, the corolla of five white petals, and the androecium of many stamens.

After fertilisation the petals fall off, the stamens and styles wither, and the rest of the flower develops into a peculiar 'false fruit' termed a *pome*.

At the upper part of the pome is seen the 'eye' of the 'fruit,' consisting of the so-called calyx-tube with the remains of the sepals (*n*) and stamens (*s*) attached to it : the withered styles (*st*) are also frequently visible. The carpels of the gynæcium which constitute the true fruit are fleshy, but their inner walls develop into a thin, tough, horny endocarp surrounding the seeds. The main bulk of the pear for which the 'fruit' is grown is the very large receptacle which envelops the gynæcium.

The flowers of the pear are protogynous and have white petals : the pome is top-shaped. Self-fertilisation is possible even without the visits of insects : cross-fertilisation is however most common in the chief rosaceous genera. Cross-fertilisation is necessary for the 'setting' and development of the 'fruit' of several varieties of pears : after pollination from the same flower or from plants of the same variety no fruits 'set,' hence the importance of planting several distinct varieties in an orchard of pears.

Most of the **cultivated Pears** appear to be hybrids and selected crosses between several species of *Pyrus*.

10. The **Apple** differs from the pear in possessing flowers with pink and white petals and styles which are united at their bases

within the calyx-tube: the pome moreover is somewhat spherical or conical with an indented base where it joins the peduncle.

11. The **Medlar** (*Pyrus germanica* Hook.) is sometimes placed in a separate genus and named *Mespilus germanica* L. Its 'fruit' is a roundish top-shaped pome to which are attached the five large leaf-like sepals. The receptacle is hollowed out as in the apple and pear, but it does not completely enclose the carpels; the latter are consequently exposed within the broad open calyx-tube. Each carpel, of which there are five, develops a hard bony wall which protects the single seed within it.

21. Allied to the medlar in structure of the fruit is the **White-thorn** or **Hawthorn** (*Crataegus Oxyacantha* L.), so valuable for hedges.

The 'fruit' when ripe is a scarlet round or ovoid pome, but the upper part of the receptacle or calyx-tube is more contracted than in the medlar and the sepals are small. The carpels are usually only one or two in number: they develop hard bony walls.

13. The **Quince** (*Cydonia vulgaris* Pers.) belongs to another genus of the Rosaceæ.

The 'fruit' or pome is hard and possesses a woolly surface when young but is smooth when ripe. It resembles the pear or apple in shape and structure, but within each of its five carpels are many seeds arranged in two rows. The sepals at the apex of the fruit are leaf-like.

The testa of the quince seeds abounds in gum which with water swells up into a mucilage.

Ex. 214.—Compare the flowers of the apple and pear. In what do they differ from each other?

Ex. 215.—Make longitudinal and transverse sections of the flowers of an apple and a pear. Observe the position and extent of the receptacle and the part of it termed the calyx-tube; in each note also the number of carpels and the ovules in the latter.

Ex. 216.—Examine a half-grown apple and pear: observe the calyx-tube. What part of the apple and pear flower is still visible in the fruit.

Cut longitudinal and transverse sections of an apple and a pear. Note the number and position of the seeds in each loculus within the 'fruits.'

Ex. 217.—Examine the structure of a hawthorn flower.

Watch the growth of the 'haws' after the flower fades: cut sections and examine the structure of young and old 'haws.' Compare a 'haw' with an apple.

Ex. 218.—Repeat Ex. 217, using a quince and medlar instead of the hawthorn.

14. Common weeds belonging to the Rosaceæ and possessing flowers and fruits somewhat different from any previously discussed are:—

Meadow Sweet (*Spiræa Ulmaria* L.); **Wood Avens** (*Geum urbanum* L.); **Agrimony** (*Agrimonia Eupatoria* L.), and species of **Burnet**.

The fruit of meadow sweet consists of five or six follicles each containing from two to six seeds; that of wood avens is composed of achenes which when ripe have long hooked styles. In agrimony the fruit consists of one or two achenes imbedded in a small woody receptacle.

Lesser Burnet (*Poterium Sanguisorba* L.).—A perennial herbaceous plant common on dry calcareous soils in various parts of the country. It grows to a height of 18 inches or 2 feet, and has a slightly angular stem bearing pinnate leaves, with from five to ten pairs of coarsely serrate leaflets. The flowers are small of reddish-green colour and arranged in dense heads at the end of long furrowed stalks. The upper flowers of the head are female with one or two carpels: the lower ones male or bisexual with twenty or thirty stamens. None of the flowers possess a corolla.

The fruit consists of one or two achenes enclosed in the four-winged receptacle. Lesser Burnet has been recommended for growth on dry calcareous soils, alone or in mixture with grasses and clovers, especially for sheep food.

By itself it is of little value as it is liable to become hard and woody, and is rejected by all kinds of stock unless the latter are

pressed by hunger. In mixtures even, we think, it has little or nothing to recommend it except for use upon very dry chalky ground where nothing better can be grown.

Its fruits constitute a common impurity of unmilled sainfoin 'seed,' and samples of the latter should always be examined for them.

Ex. 219.—The student should examine and become practically acquainted with Meadow Sweet, Wood Avens, Agrimony, Lesser Burnet and the common species of *Potentilla*.

CHAPTER XXX.

LEGUMINOSÆ.

1. THE Order Leguminosæ ranks next to the Compositæ in number of species, about seven thousand being recorded. The Order is divided into three Sub-orders, namely, *Cæsalpineæ*, *Mimoseæ*, and *Papilionaceæ*. The two former are almost entirely tropical and possess little of interest or importance for the farmer: the Papilionaceæ, however, includes some of the most important fodder crops known, and the seeds of several species are utilised as human food.

SUB-ORDER PAPILIONACEÆ.

2. **General characters of the Sub-Order.**—Flowers irregular, protandrous, medianly zygomorphic, slightly perigynous; calyx gamosepalous, five-partite; corolla, usually polypetalous, though in red clover and some other plants of this order the bases of the petals are united with each other and with the filaments of the stamens; the lower part of the corolla in such cases is tubular. The petals are irregular and five in number, the posterior one is large and conspicuous and is termed the 'standard' or *vexillum* of the corolla; besides these are two lateral petals known as the 'wings' or *alæ*, and two anterior petals more or less coherent by their margins and forming a boat-shaped structure called the 'keel' or *carina* in which the gynæcium and stamens are enclosed and protected. This form of corolla, from its fanciful resemblance to a butterfly, is termed *papilionaceous*, and is characteristic of the sub-order. The andrœ-

cium consists of ten slightly perigynous stamens, either all the filaments are united (*monadelphous*), or nine are united and the posterior or upper one free (*diadelphous*). The gynæcium is superior, of one carpel, and contains one or many ovules. Fruit generally a legume; seeds with a firm leathery testa, exdosperruous; the embryo possesses thick fleshy cotyledons.

The cotyledons of the bean, vetch, and pea remain permanently below ground, while others, such as the clover, sainfoin, and lucerne, come above the ground soon after germination commences.

The flowers of the Papilionaceæ are all specially adapted for insect pollination. The 'standard' acts as a conspicuous attractive banner. The 'wings' and 'keel' petals are often interlocked near their bases in such a manner that when an insect of sufficient weight alights on the 'wings' the latter are pressed downwards and these in turn depress the 'keel' petals; the stamens, style, and stigma are by this movement forced out at the apex of the 'keel,' and the pollen is brought into contact with the underneath part of the insect's body. The insect visiting another flower brings the pollen on its body into contact with the stigma of the flower which, on account of its length and position, is generally forced out first from the apex of the 'keel'; cross-pollination is thus effected.

Some plants, such as field and garden peas, sweet pea, common and hairy vetch, dwarf kidney-bean, hop-clover, and hop-trefoil, while undoubtedly possessing flowers specially adapted for insect-pollination are capable of self-pollination, and are fertile and able to produce seeds when insects are excluded. Others, such as red, white and crimson clovers, scarlet-runner bean, and broad bean are more or less sterile when insects are prevented from visiting the flowers.

All parts of the plants, and especially the seeds, contain considerable quantities of nitrogenous substances, upon which much of their feeding-value depends.

Through symbiosis with a bacterium which penetrates the roots, the Leguminosæ are able to thrive upon ground which is devoid of combined nitrogen: the nitrogen which they require for growth is obtained indirectly from the free nitrogen of the air (see p. 793).

Usually a cereal and especially wheat is taken after the growth of a leguminous crop.

Some species, such as vetches and lupins, are occasionally grown on poor, dry ground to be subsequently ploughed in as a 'green manure'; this practice largely increases the nitrogen-content of the soil and at the same time augments the stock of humus in the latter.

3. The genera most important from a farmer's point of view are the following:—

Pisum (peas), *Vicia* (vetches and common bean), *Trifolium* (the true clovers), *Medicago* (the medicks—lucerne and yellow trefoil), *Onobrychis* (sainfoin), *Anthyllis* (kidney-vetch), and *Lotus* (birds'-foot trefoil).

Some common plants of less importance belonging to other genera are Gorse or Whin (genus *Ulex*), Bokhara clover (genus *Melilotus*), Everlasting pea (genus *Lathyrus*), Lupins (genus *Lupinus*); and in gardens Scarlet Runner and Dwarf Kidney Beans of the genus *Phaseolus*.

4. **Peas** (genus *Pisum*).—The cultivated varieties of peas are usually supposed to belong to two species, namely: (1) the **Field Pea** (*Pisum arvense* L.), which is said to be found in a wild state in the south of Europe, and (2) the **Garden Pea** (*Pisum sativum* L.), which is not known wild, and may possibly be a modified form of the former species.

The **Garden Peas**, of which there are endless varieties, have white flowers, and seeds of uniform yellowish white or bluish green colour: they are also more delicate and suffer more readily from frost and drought than the field pea.

Some of the garden forms for human consumption are grown

on farms near large towns, and are a profitable crop on suitable lands under such circumstances.

The **Field Pea**, of which there are comparatively few varieties, is more hardy than the garden pea, and the flowers have purple or lavender coloured 'standards' and 'wings' of deeper purplish red; the colour of the seeds is greyish brown, dun-coloured, or grey speckled with fine spots.

SEED AND GERMINATION.—The seeds do not germinate freely below a temperature of 5° C.

The young seedling resembles that of the bean in general structure. It possesses a strong tap root, two cotyledons which remain permanently below ground, enclosed by the testa of the seed, and an epicotyl, which comes above ground in a curved form.

ROOT, STEM AND LEAVES.—The pea possesses a marked tap root and a number of branching secondary roots. The stems are round and too weak to stand erect without a support.

The leaves are pinnately compound with large leaf-like stipules, the leaflets, of which there are generally two or three pairs, are ovate, with mucronate tips. The end of the leaf possesses one or more opposite pairs of tendrils and a terminal one, all of which are modified leaflets (Fig. 33). The tendrils are sensitive to contact, and wind round any small support which they touch; by their aid the plant is enabled to support itself in a more or less erect position by clinging to neighbouring objects.

INFLORESCENCE, FLOWERS AND FRUIT.—The inflorescences are axillary racemes with few flowers, often only one or two. Each flower is perigynous; the calyx gamosepalous and five-lobed; the corolla papilionaceous (Fig. 127); the andrœcium is diadelphous consisting of ten stamens, one of which is free, the rest united by their filaments.

The gynœcium of the flower is superior and consists of a single carpel with many ovules; the stigma is placed at the end of the

curved style which bears a number of hairs on its concave side. The fruit is a typical legume (Fig. 37).

VARIETIES.—The following are the commoner varieties of field peas :—

Common Grey Field Pea.—A prolific late variety, suited to light chalky soils. The 'straw' is liable to be long and on good soils becomes 'laid' before the pods and seeds are ripe.

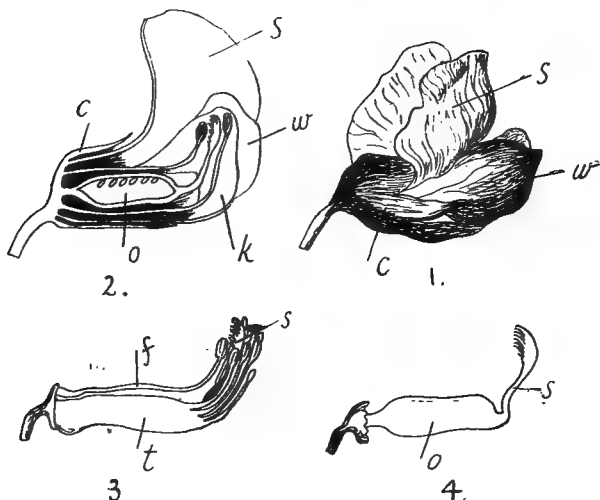

FIG. 127.—1. Flower of a field pea. 2. Section of same; *s* 'standard'; *w* 'wing,' and *k* 'keel' petals respectively. 3. Androecium; *t* united filaments of nine stamens; *f* filament of single free stamen; *s* stigma of gynæcium. 4. The gynæcium; *o* ovary, *s* style with hairy stigma.

The legumes are almost cylindrical, and contain from six to eight dun-grey or bluish-green self-coloured seeds.

This kind is sometimes grown in mixture with Scotch horse beans, which act as supports for the peas.

Early Grey Warwick.—This is a rapid grower, and adapted to late districts where the soil is in rich condition. It has dun-coloured seeds spotted with purple.

Partridge.—An early prolific variety of good quality, and suitable for growing in late districts.

The stems are soft, and usually about 4 feet long with broad leaflets. The pods often grow in pairs, each containing from five to seven roundish seeds of a pale brown colour beautifully speckled with small darker spots and lines.

Grey Maple.—This variety has speckled seeds like those of the Partridge variety, but larger; it is adapted to the better kinds of soil in districts with mild climate.

Grey Rouncival or Dutch Pea.—A very late field pea with very long 'straw' and large dun-coloured wrinkled seeds. The stems are often 7 or 8 feet long, and the pods generally grow in pairs and contain five or six seeds. This variety is only suited to light soils in early districts.

SOIL.—Peas give the most satisfactory yield of seeds upon soils of a medium or somewhat inferior character. In all cases it is necessary that the ground should contain a considerable proportion of lime. Upon good rich soils or those of a peaty and damp character the stems and leaves grow too long and become laid: the crop then yields few peas.

In cases where the ground is comparatively rich, but not stiff enough to yield a good crop of beans, a mixture of beans and peas at the rate of $1\frac{1}{2}$ bushels of the latter to $2\frac{1}{2}$ of the former often gives good results. The stiff erect bean stems act as supports for the luxuriant weak stems of the peas, and the latter are enabled to secure an adequate amount of light and air for seed production.

SOWING.—The seed is best sown in February or March in drills at a distance of 14 or 18 inches apart and 2 to 3 inches deep: the amount needed is 2 to 4 bushels per acre according to the size of the individual seeds. On very clean ground the seed is occasionally sown broadcast at the rate of 4 or 5 bushels per acre.

YIELD.—Peas are one of the most uncertain of farm crops, only one crop out of every three or four being satisfactory. The yield on the best soils adapted to the crop averages about 30 or 35 bushels of seed and about a ton of straw per acre, but on unsuitable soils in bad seasons the yield of seed may be practically nothing.

COMPOSITION.—Peas are slightly less nitrogenous than beans, but they contain more soluble carbohydrates and less 'fibre' than the latter.

Peas contain on an average 14 per cent. of water, 20 per cent. of albuminoids, about 54 per cent. of soluble carbohydrates, and $5\frac{1}{2}$ per cent. of 'fibre.'

Vetches (Genus *Vicia*.)

5. **Bean** (*Vicia Faba* L., or *Faba vulgaris* Moench).—A well-known annual plant whose seeds are excellent food for all kinds of stock on the farm. The stems and leaves ('haulm or straw') when well-harvested make fodder little inferior to good hay.

SEED AND GERMINATION.—The nature of the seed and seedling of a bean has been discussed in Chapter II.

ROOT, STEM AND LEAF.—The primary root is strongly developed. The stems, which stand erect, are unbranched, and from $2\frac{1}{2}$ to 5 feet high, according to the variety. They are 'fleshy' and stiff, four-sided and slightly winged.

Usually three stems spring from one seed, viz., the main stem, and two lateral ones developed from buds in the axils of the cotyledons.

The leaves are pinnately compound, with one, two or three pairs of elliptical entire leaflets.

INFLORESCENCE, FLOWER AND FRUITS.—The inflorescences are axillary racemes of two to six flowers. The flowers are of the common papilionaceous type; the petals are usually all white, with the exception of the wings, which have a large black spot upon them.

The fruit is a legume which, when young, is fleshy and has a thick velvety lining. After ripening the valves of the legume become tough and hard.

VARIETIES.—Several varieties of the bean, such as the **Long pods** and **Broad Windsor**, are cultivated mainly in gardens and cannot be noticed here. The following kinds are those most generally grown as farm crops:—

Scotch Horse Bean.—A very hardy, fairly prolific variety, with stems about 4 feet high. The pods contain on an average three seeds. Each seed is buff or pale brown in colour, and about

half an inch long, slightly flattened on the sides with a black hilum.

The Scotch horse bean grows best on strong, well-drained clays.

Tick Bean or English Horse Bean.—This variety, of which there are a large number of named strains, is closely related to the above.

Its seeds are not flattened on the sides but are almost cylindrical, rounded at the ends and slightly smaller than the Scotch horse bean.

The tick bean is very prolific and more suited to the climate of the south of England, where it grows upon lighter soils than those essential for a good crop of the Scotch horse bean.

Winter Bean.—A variety resembling the tick bean, which, on account of its hardy nature, can be sown in October to stand the winter. It is usually harvested in the following July or August.

Mazagan.—This is an early variety of fine quality, sometimes grown in gardens. When grown as a farm crop it requires moderately stiff land in good condition to obtain the best results.

The stems of the plant are slender, and 4 or 5 feet high. The pods are long and narrow, and generally contain four seeds, each of which is about three-quarters of an inch long, with flattened and slightly wrinkled sides.

SOIL.—The soils best suited to the growth of beans are well drained, clayey loams. On light soils the total produce is small, while on those rich in humus the plants grow tall and leafy, but yield few seeds.

SOWING.—With the exception of the winter variety beans are sown in February or March. The crop is cut in late autumn, when the stems are brown with a few small green patches upon them; the hilum should be black, and the seeds free from the funicles in the pod before cutting the crop.

The seed is sown in drills usually about 18 inches or 2 feet

apart ; the amount used is from 2 to 4 bushels, according to the size of the bean.

YIELD.—The average yield is about 30 bushels of seed and from 20 to 30 cwt. of 'straw.'

COMPOSITION.—Bean seeds contain 14 per cent. of water and about 23 per cent. of albuminoids, mainly in the form of fine aleuron-grains in the cells of the cotyledons of the embryo. The carbohydrates, the chief of which is starch, average 48 per cent. ; the fat, $1\frac{1}{2}$ per cent. ; and the fibre, 7 per cent.

6. Common Vetch or Tare (*Vicia sativa* L.).—An annual vetch with trailing or climbing stems and compound pinnate leaves. The primary stems branch extensively from the axils of the lower leaves, and the secondary and tertiary branches also branch freely.

The first few leaves of the seedling plant have one or two pairs of narrow leaflets and no tendrils ; those appearing later are, however, furnished with two or three terminal tendrils and six or seven pairs of leaflets, which are broader and oblong or obovate in form, with a stiff mucronate point.

The stipules are small and pointed, with a dark purple blotch in the centre.

The flowers, which are reddish purple, are borne singly or in pairs on very short stalks in the axils of the leaves.

The fruit is a more or less hairy legume, containing from four to ten smooth round seeds.

The cultivated vetch (*V. sativa* L.) is probably merely a form of *Vicia angustifolia* Roth., which is a common wild plant in dry soils throughout the country.

There are two races of the cultivated vetch or tare, namely, **Winter Vetches** and **Spring Vetches**.

The **Winter Vetch** is a hardy form, capable of enduring frost ; it has smoother, more cylindrical pods, with smaller seeds than the summer variety, and gives less bulk of stem and leaves.

This form is usually sown in September, October, or November, either alone or mixed with rye for early spring fodder.

The rye is not only nutritious but acts as a support for the vetches, and keeps the latter from trailing on the ground and rotting at the base of the stem.

The **Spring Variety** grows more rapidly and luxuriantly than the winter one, and is a more delicate plant. When used for green fodder it is sown either alone at the rate of 4 bushels per acre, or in mixture with oats or barley at the rate of $2\frac{1}{2}$ bushels of vetches to $1\frac{1}{2}$ bushels of the cereal.

Small areas are sown from February onwards at short intervals so as to provide a succession of crops during the summer.

It must be borne in mind that the spring variety is uncertain for autumn sowing, and that the true winter variety if sown repeatedly in spring produces seeds which give rise to somewhat delicate plants.

As the botanical morphological features present no points of constant difference by which the winter form may be distinguished from the spring one, the farmer is compelled to depend on the honesty of the vendor when purchasing either kind.

Vetches grown for hay should be cut when in bloom; at this stage of growth it is superior in nutritive value to good meadow hay; when grown for seed, the yield of which is always very uncertain, vetches may be sown alone or in mixture with beans whose stiff stems act as supports and enable the crop to obtain a better supply of the light and air necessary for healthy growth.

The seeds of the vetch have practically the same composition as those of the field bean.

Ex. 220.—Sow the seeds of bean, pea and vetch in garden soil or pots; dig up the seedling as soon as two full-grown leaves appear on the stems above ground, and examine the root system and the form and size of the leaves on the stem above the cotyledons.

Ex. 221.—Dig up completely a half-grown plant of bean, pea and vetch, and study the manner of branching in each.

Ex. 222.—Compare the flowers of the bean, pea and vetch, and note any points of difference between them. Compare their leaves also.

Ex. 223.—Make a collection of seeds of the different varieties of field bean, field pea, and vetch.

7. Vetchlings or Everlasting Peas (genus *Lathyrus*).—This is an extensive genus of climbing plants much resembling vetches, but with fewer leaflets and a flattened style. Eight or nine species are wild in this country, and are known as vetchlings or everlasting peas, although some of them are annuals. They are all eaten by cattle.

The commonest species is the meadow vetchling (*Lathyrus pratensis* L.), which is frequent in meadows and hedges. It grows 2 or 3 feet high, and has narrow lanceolate leaflets and racemes of bright yellow flowers.

The **Wood Vetchling** (*Lathyrus sylvestris* L.) grows in woods and thickets; it has winged stems, and often climbs to a height of 5 or 6 feet. The leaves possess tendrils and have one pair of large lanceolate leaflets from 3 to 6 inches long and half an inch broad.

Usually four or five flowers are present on each long peduncle: the 'standard' petal is rosy-pink, the 'wings' purple. This plant has been selected and cultivated on the continent as a perennial fodder crop, and is termed Wagner's Everlasting Pea (*L. sylvestris* L., form *Wagneri*). Like lucerne it withstands drought, and when once established gives very large yields of highly nutritious food.

The seed is at present expensive, and germinates very slowly in the open field.

Wagner's everlasting pea possesses few, if any, advantages over lucerne and other leguminous crops at present in use on the farm, and we see little need of its introduction.

Clovers (Genus *Trifolium*).

8. **Red or Purple Clover** (*Trifolium pratense* L.).—Red clover is the most extensively cultivated species of *Trifolium*, and ranks first among fodder plants for excellence of yield, nutritive value, and adaptability to various soils and climates. It is grown alone or in mixture with grasses for leys of short duration. Soils upon which a crop has been raised refuse to grow a second crop of remunerative size until a certain period has elapsed, usually not less than four years, often much more. Such soils are said to be 'clover-sick,' and although there is no doubt that the dying away of clover sown on ground exhibiting this peculiarity is due to several different causes, none of the latter are yet very clearly understood.

SEED AND GERMINATION.—The seeds absorb about their own weight of water, and germinate in two or three days. The seedling possesses a well-developed primary root and hypocotyl; the two elliptical cotyledons come above ground. The first foliage-leaf of all the clovers is different from the succeeding ones in being simple and rounded instead of compound and ternate as in those which arise later upon the plant.

ROOT AND STEM.—The primary root of red clover develops into a strong tap root with three lines of secondary roots which spread extensively through the soil. 'Nodules' are abundant upon the roots. When sown in spring with a cereal, the epicotyl of the young plant develops very little, but a great many buds and short branches arise in the axils of the closely-packed leaves, and by the contraction of the root the short stem and its buds and leaves are pulled down so that they lie close to the ground in the form of a rosette during autumn and winter. Usually in the following spring but sometimes in the autumn of the year in which the seed is sown, the buds grow out into ascending branches, each from 1 to 2 feet high, bearing leaves and terminating in dense flower-heads.

LEAF.—The leaves are stipulate and compound, with three ovate leaflets, each of which is bordered with hairs.

The stipules are membranous with greenish-purple veins and united to the petiole except at their tips which end in a fine point (1, Fig. 128).

INFLORESCENCE AND FLOWER.—The inflorescences are terminal, ovoid or spherical capitula about 1 or 1½ inches in

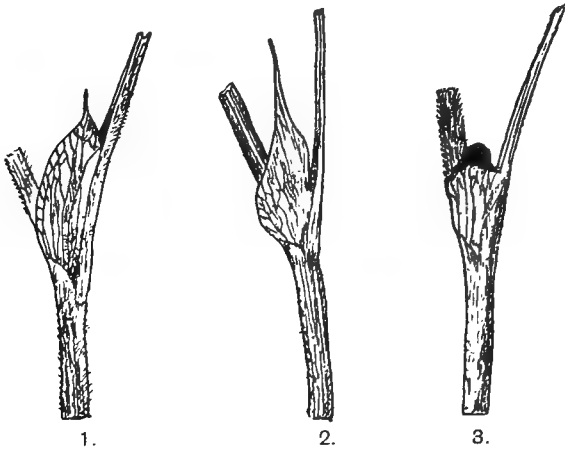

FIG. 128.—Stipules of the leaves of (1) red clover; (2) alsike clover; (3) crimson clover or 'Trifolium' (*T. incarnatum*) (all natural size.)

length and composed of many small flowers crowded together. Beneath each inflorescence are two leaves.

The flower is protandrous and has a gamosepalous calyx with five free teeth at its apex, the inferior one being longer than the rest.

The corolla is medianly zygomorphic and consists of a standard, wings, and keel; the petals, however, instead of being free as in the pea, are united at their bases to form a tube nearly half an inch long (1, Fig. 129).

The androecium is diadelphous; nine united stamens are fused with the corolla tube and the posterior one is free.

The single carpel of the gynæcium has a long style and a one-celled ovary containing two ovules.

The fruit of red clover, is a one-seeded capsule (Fig. 130) the upper part of which separates from the lower along an irregular transverse line (pyxidium).

VARIETIES.—**Red Clover** (*Trifolium pratense* L.) is a wild plant common in meadows and pastures throughout Europe. In a wild state it is variable in its habit of growth and durability, but usually lasts from three to four years. The seeds of this truly wild indigenous plant would no doubt be very useful in mixtures for leys and permanent pastures, but none are met with in commerce except in name.

The cultivation of the plant as a fodder crop was introduced into this country from the Continent in the early part of the seventeenth century, and from that time to the present its cultivation has spread extensively.

So far as our experience goes no seeds appear to be in commerce which have been derived from the wild plant within recent times, all those sold being the progeny of plants which have been under the influence of cultivation for long periods of time.

Among these samples obtainable from the seedsman are a considerable number of varieties varying in hardiness, yielding capacity, and slight botanical features; none of the differences,

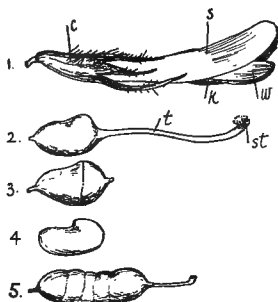

FIG. 129.—1. Flower of red clover. *c* Calyx; *s* 'standard'; *w* 'wings'; *k* 'keel' of the corolla. 2. Gynæcium of red clover. *t* Style. *st* Stigma. 3. Ripe fruit (pyxidium) containing the single seed 4. 5. Gynæcium of white clover (two and a half times the natural size.)



FIG. 130.—Fruit (pyxidium) of red clover; on the upper part a portion of the withered style is seen (enlarged.)

however, are sufficiently constant to warrant the special names given to the strains.

Attempts at discrimination by botanical characters, such as hairiness, smoothness, or solidity of stem, form of leaves, and capitula are misleading, as these features are extremely variable.

The term '**Ordinary Red**' or '**Broad Clover**' is in commerce applied to the forms which are of short duration and useful for short leys, while the name '**Cowgrass**' or '**Perennial Red Clover**' ('*Trifolium pratense perenne*') is given to the forms which last two years or more and which are somewhat hardier than the previous ones.

Although the forms which are used for particular purposes is a matter of no small importance, it is impossible to distinguish them with anything like accuracy and the farmer is therefore compelled to depend upon the reputation of the vendor of the seed (see pp. 615 and 616).

CLIMATE AND SOIL.—Red clover grows readily upon almost all soils except those which are very dry or which contain an excess of stagnant water. It thrives best, however, on somewhat heavy loams containing a fair proportion of lime.

It is sensitive to spring frosts, and varieties obtained from the warmer parts of Europe and America often die off completely during autumn and winter in England.

SOWING.—The seed is sown generally with a cereal crop in spring; the amount needed for a crop when used alone is 16 lbs. per acre, if the seed is pure and of good germinating capacity.

9. **Zig-Zag Clover**: **Marl-Grass**: **Meadow Clover** (*Trifolium medium* L.).—A perennial clover which grows most commonly upon dry banks and in dry elevated pastures. At first sight it may be mistaken for red clover, the flower-heads being of similar colour. The stem is, however, straggling and bent in a zig-zag manner at every node. The leaflets are narrower and longer than those of red clover, and the free part of the stipules is longer, more pointed, and narrow.

The flowers are a deeper purple colour and not so densely crowded together in the capitulum; the latter, moreover, is stalked, the first pair of opposite leaves being a short distance below the base of the flower-head instead of close to it as in red clover.

Seed of this species is not met with in commerce, and the plant is of little agricultural value.

10. **Alsike or Swedish Clover: Hybrid Clover** (*Trifolium hybridum* L.).—A perennial clover introduced into England from Sweden in 1834.

It is a distinct species and not a hybrid as its name seems to imply.

The stems are smooth, of upright habit, from 1 to 3 feet high.

The free part of the stipules of the leaves are drawn out to a long tapering point (2, Fig. 128), and have pale green veins.

The flower heads, which are round, arise on peduncles springing from the axils of leaves on the main stems.

The flowers are pale pink or white, resembling those of white clover; the fruit is an indehiscent pod, containing from one to three small seeds.

Alsike, of which there are no specially cultivated varieties, is a more permanent plant than red clover, often lasting five or six years on suitable soils. It is also much more hardy and better suited to stiff damp soils, where other species of clover would scarcely thrive at all.

Pure sowings are rarely made, but it is of great value in mixtures of grasses and clovers on all stiff moist soils, although the yield is not so good as that of the red species.

11. **White or Dutch Clover** (*Trifolium repens* L.), (Fig. 131).—A well-known perennial clover, common in all good pastures throughout the country. It differs in habit of growth from red clover and alsike. Like these species it has a well formed tap root, but the stems, which are smooth, creep over the surface or just beneath the soil, and from their nodes adventitious roots

are given off. The leaves have very long petioles and small ovate membranous-pointed stipules.

The round flower-heads are produced at the ends of long stalks, which arise in the axils of the leaves and grow upwards (Fig. 131).

The flowers are white or pinkish; when the corolla fades it turns brown, and the whole flower becomes deflexed.

The fruit is an elongated pod containing from four to six small seeds.

Fig. 132 illustrates the early stages of growth of a seedling, which may be taken as typical of all the cultivated clovers.



FIG. 131.—Portion of white clover plant, showing the 'creeping' habit of the stem. *r* Adventitious root.

Two varieties of white clover are met with in commerce, namely, (1) 'Wild White,' and (2) 'Cultivated White Clover.' The former is of smaller growth and more lasting than the latter.

White clover is more permanent than either red clover or alsike, and grows upon almost all soils; the yield however is comparatively small.

It is sometimes grown alone for sheep food, but its chief use is in mixtures for laying down pastures for grazing purposes.

12. **Crimson or Italian Clover:** *Trifolium* (*Trifolium incarnatum* L.).—An annual species, with erect hairy stems from 1 to 2 feet high. The stipules of the leaves are broad and the free part is rounded, often with a dark purple margin (3, Fig. 128). The flower-heads are terminal, and placed some distance above

the last leaf of the stem: they are oblong or cylindrical, with rich crimson flowers.

Early and late varieties are met with in commerce.



FIG. 132.—Seedling of White or Dutch Clover at different stages of growth. In 2 the first foliage leaf is seen to be simple; in 3 the ordinary trifoliate leaves have appeared.

A variety, *Trifolium Molinerii* Balb., with shorter stems and pale, almost white, flowers, is native in Cornwall, and is

probably the original form from which the cultivated crimson clover has been derived.

Crimson clover is tender and cannot be grown except in the warmer parts of this country. In the south of England it is grown generally as a catch-crop, the seed being sown on the stubbles in autumn, and the produce fed off or cut for hay in the following May and June.

13. **Yellow Suckling** (*Trifolium dubium* Sibth.).—An annual clover with ascending, or prostrate, wiry stems, sometimes a foot or 18 inches long, and small yellow flowers. The flower-heads are small, and formed of about a dozen flowers closely crowded together.

Trifolium filiforme L. is another species very nearly resembling *T. dubium* Sibth., but with only five or six flowers in each capitulum, and slender short stems not more than 5 or 6 inches long. Both the above are met with on dry, gravelly pastures, and although their seeds are in commerce under the name of yellow suckling clover, they are practically of little or no value to the farmer as the produce from these species is very scanty.

14. Another annual species, namely, **Hop-Clover**, sometimes termed **Hop-Trefoil** (*Trifolium procumbens* L.), is met with on dry, gravelly pastures. It resembles the above two species in general appearance, but the flower-heads look like miniature hops and possess about forty flowers of a tawny, yellow colour.

The three last species are often confused with black medick (*Medicago lupulina* L.), which they resemble in habit as well as in colour and size of flower-heads. Black medick can, however, be easily distinguished by its leaflets: these are obcordate as in the clovers, but the midrib is prolonged into a sharp (mucronate) point, while the yellow clover leaflets are without this projection.

Ex. 224.—Examine and compare the habit of growth in red, white, Alsike,

and crimson clovers. Note which are upright growers and which are creeping.

Make drawings of the stipules, and also note any differences of form and colour of the leaflets in each species.

Ex. 225.—Sow seeds of the above-mentioned clovers in garden soil or in pots in spring, and observe the form of the cotyledons, the relative size of the hypocotyl and root in the young seedlings. Watch the development of young plants up to the time of flowering, noting particularly the production of branches in each species.

Ex. 226.—Compare the flowers, fruits, and seeds of the chief clovers. Note the manner of dehiscence in the several pods, and the number of seeds in each.

Medicks (Genus *Medicago*.)

15. Black Medick : Nonsuch Clover : Hop-Trefoil, Yellow Trefoil (*Medicago lupulina* L.).—An annual or biennial plant wild on waste ground all over the country, especially in calcareous districts.

The stems are much branched, from 6 inches to 2 feet long ; the lower parts spread over the surface of the ground but do not develop adventitious roots ; the upper parts are ascending. The leaves are trifoliate and the leaflets have a projecting mid-rib which distinguishes the plant from the somewhat similar yellow suckling and hop-clover. The flowers are yellow in small compact oval flower-heads.

The fruit is a kidney-shaped, indehiscent black pod about an eighth of an inch across with a spirally curved tip ; it contains a single seed.

Black Medick is sometimes sown alone on poor calcareous soils and used for sheep and lamb food. In suitable districts where the soil is dry and inferior, a small amount is a useful addition to grass mixtures for short leys. Occasionally a small quantity is sown with sainfoin to increase the bulk of produce during the first year when the sainfoin is not fully established.

16. Lucerne or Purple Medick (*Medicago sativa* L.).—A perennial introduced plant with erect branched stems 1 to 3 feet high.

The primary root is strongly developed and forms a tap root which in old plants is often three-quarters of an inch in diameter: this and the secondary roots penetrate several feet into the earth on ground with an open subsoil. The leaves are trifoliate; each leaflet is obovate, dentate, with a notched tip and a projecting midrib (*f*, Fig. 133).

The flowers are usually purple, but sometimes yellow, in dense axillary racemes, the peduncles of which are longer than the leaves.

The fruit is a dehiscent legume coiled two or three times into a loose spiral: it contains several seeds.

Lucerne is one of the most valuable fodder plants for warm climates and succeeds well in the south of England on ground with an open subsoil. It suffers very little from drought when once established and gives two or three heavy cuts of fodder every season, the first of which is ready more than a fortnight earlier than red clover.

It is most frequently used green, but can be made into hay; in the latter case it must be cut before flowering or it becomes hard and woody, and special care must be taken to prevent loss of leaves in handling.

In the first season the young plants develop large root-systems and few stems and leaves above ground, consequently a small crop only is produced.

Instead of the part of the stem above the cotyledons remaining short for some time and its leaves forming a rosette on the surface of the ground as in red clover, the internodes of the epicotyl in lucerne elongate at once (3, Fig. 133), and the main stem grows erect with comparatively few branches in the first season. The crop therefore in the earlier stages of growth often looks thin and disappointing.

Vigorous branches, however, spring up later from the lower nodes of the stem and from the axils of the cotyledons (4, Fig. 133), especially after being cut once.

In the second and third years a stout rootstock is formed from which a large number of stems are sent up and the plants yield a heavy crop of nutritious fodder.

Under some circumstances a lucerne ley will last a very long

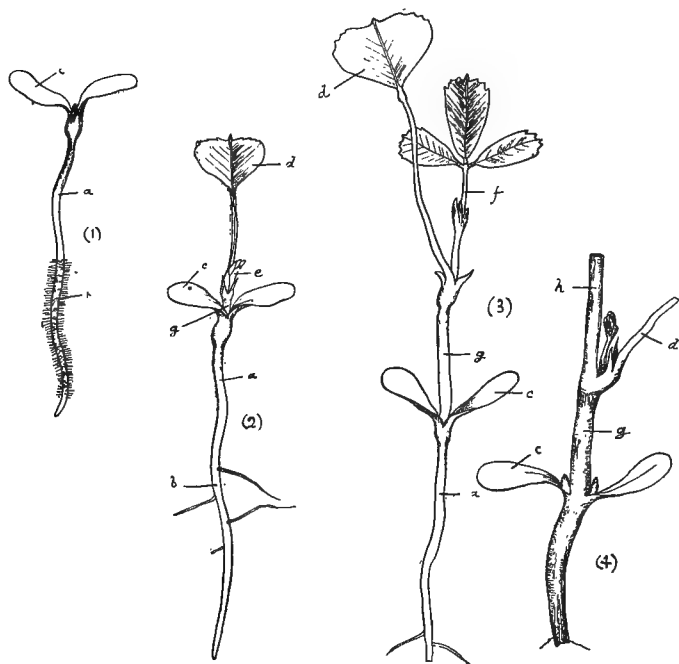

FIG. 133.—Four successive stages of development of Lucerne Seedling (*Medicago sativa* L.).—The first foliage-leaf (*d*) is simple, the second and all others trifoliate, as at *f*. *a* Hypocotyl; *b* root; *c* cotyledons; *d* first foliage-leaf; *e* plumule; *f* second foliage-leaf; *g* first internode of epicotyl. In 4 note the buds in the axils of the cotyledons.

time but it usually becomes overrun with weeds in six or seven years, after which time it is ploughed up.

Seed is sown from April to the end of June at the rate of 30 lbs. per acre in drills 6 or 8 inches apart to allow of the use of horse and hand hoes.

For this and all perennial crops whose growth is slow at first, the ground should be especially clean before sowing or weeds may ruin the crop before it is established.

Melilots (Genus *Melilotus*).

17. The melilots have upright stems with trifoliolate leaves, resembling those of lucerne. The flowers are small, yellow or white, arranged in one-sided axillary racemes.

The fruit is a round or oval legume, which is only partially dehiscent; it usually contains from one to four seeds.

White Melilot (*Melilotus alba* Desr.), which is a rather uncommon British wild plant, is sometimes introduced under the name of **Bokhara Clover**, and recommended as a forage crop. It is perennial, and produces a large bulk of leaves and stems, which have a fragrant odour like that of sweet vernal grass; owing to its bitter taste it is, however, disliked by cattle, and also has the objectionable feature of rapidly becoming hard and woody.

The seed is cheap, and possibly the plant may be found of service for ploughing-in as a green manure.

Another commoner species, namely, **Yellow Melilot** (*Melilotus officinalis* Willd.), grows 2 or 3 feet high, and possesses deep yellow flowers. It is an annual, and met with in corn fields.

Sainfoin (Genus *Onobrychis*).

18. **Sainfoin** (*Onobrychis sativa* Lam.).—A perennial plant, probably indigenous in the midlands and south of England on dry chalky soils.

The primary root is thick and fleshy, and penetrates to a depth even greater than lucerne roots in open dry subsoils.

The young plant forms a rosette of leaves close to the ground, and resembles red clover in its early habit of growth.

From the rhizome several almost erect stems are sent up, each of which is from 1 to 2 feet high, ribbed, and slightly downy.

The first foliage-leaves of the seedling are small and simple with long petioles; the second and third are trifoliolate, all the subsequent ones being pinnately compound with six to twelve pairs of opposite leaflets and a terminal one. The leaflets are narrow, obovate, and entire.

The inflorescences are axillary, compact racemes, the peduncles of which are long, slender, and erect. Each flower is about half an inch long, rosy-red, with darker pink veins, papilionaceous, the 'wing' petals very short.

The fruit is almost semi-circular in outline and about a quarter of an inch long, its pericarp covered with a coarse raised network of lines on which are spiny projections (Fig. 206); it is indehiscent, and contains a single olive brown seed, in shape like a small bean.

Sainfoin is a valuable fodder plant for growth on dry, barren calcareous soils.

It resists frost better than lucerne, but damp sub-soils are destructive of both plants.

It is extensively used as sheep food, and cut green for soiling cattle and horses. The produce makes excellent hay of very high nutritive value when cut just in flower.

Two cultivated varieties are met with, namely, (1) **The Old Common Sainfoin**, and (2) **Giant Sainfoin**.

The former variety is more lasting than the latter, a ley of it being generally useful during four to seven years. It gives only one cut per annum, after which the subsequent growth is grazed.

Its stems are shorter, and the flowering period a week or ten days later than the giant variety.

The giant sainfoin is a more rapid and luxuriant grower, and is usually kept down only one or two seasons, during which it yields two or more heavy crops per annum. If seed is required the plant is cut once and the second growth of the season reserved.

When seed of the Old Common variety is wanted the first growth of the year must be reserved for the purpose.

The seed is drilled in March or April, usually on a cereal crop at the rate of 4 bushels (100-110 lbs.) of 'seed in the husk,' or 50 lbs. of 'milled' (true) seed per acre.

The seed should be drilled about 1 inch deep in rows 9 to 12 inches apart.

Ex. 227.—Dig up and examine young seedling plants of Sainfoin, Lucerne, and Black Medick. Note the form and extent of the roots and branches of the plants.

Examine full-grown plants of each species, paying special attention to the structure and form of their flowers, fruits, and seeds.

Serradella (Genus *Ornithopus*).

19. To the genus *Ornithopus* belongs **Serradella** (*Ornithopus sativus* Brot.), a wild Portuguese and Spanish species, introduced to many parts of the Continent as a useful plant for growth upon dry sandy ground, and sometimes mentioned in this country. It is grown largely for ploughing-in as a 'green manure,' and is also utilised green as fodder or made into hay.

Serradella is a slender annual, about 12 or 18 inches high, with compound pinnate leaves and small pale rose-coloured flowers, of which from two to five grow together in a cluster at the end of long axillary peduncles.

The fruit is curved, and breaks up transversely into many one-seeded 'joints'; three or four fruits growing together resemble a bird's foot.

Kidney Vetch (Genus *Anthyllis*).

20. **Kidney Vetch** (*Anthyllis Vulneraria* L.).—An herbaceous perennial common in dry pastures and on banks in calcareous districts.

It possesses a strong underground branched rhizome, from which ascending stems arise from 8 to 18 inches in length. The latter are more or less softly hairy and bear few leaves.

During the first year the young plants possess a rosette of leaves close to the ground: these leaves are mostly simple and

ovate with long petioles. Subsequently branches are produced in the axils of the radical leaves, and upon them are borne pinnatifid or compound pinnate leaves, each with a large terminal lobe.

The inflorescences are dense heads of yellow flowers, the calyces of which are inflated and covered with long downy hairs. The andrœcium of the flower is monadelphous, the gynœcium stalked, containing two ovules.

The ripe fruit is a flattened legume and contains a single seed, one half of which is yellow, the other half bright pale green.

The kidney vetch is a useful plant sown alone for sheep food upon calcareous or marshy soils too poor to grow anything else. It is capable of resisting prolonged drought, and makes nutritious hay although it is scarcely suited to this purpose on account of the procumbent character of the stems, much of which escapes the scythe.

Seed is sown in spring in drills 12 or 14 inches apart, at the rate of 17 lbs. per acre.

In mixtures, either for long or short leys on dry ground, the kidney vetch is worthy of a place both on account of its nutritive quality and its permanence.

Bird's-foot Trefoils (Genus *Lotus*).

21. Common Bird's-foot Trefoil (*Lotus corniculatus* L.).—An herbaceous perennial common in dry pastures. From the short thick rhizome spreading decumbent stems arise, each of which is from 4 to 16 inches long. The leaves are pinnately compound with five leaflets; the lowest pair of the latter are separated considerably from the three upper ones, and resemble the stipules of a trifoliate leaf.

The flowers, five to ten in number, are arranged in umbel-like cymes at the end of long slender axillary peduncles.

The corolla of the flower is bright yellow, the 'standard' being frequently tinged with deep orange or red. The fruit is

a long slender legume purplish red in colour; within it are a number of small brown roundish-oval seeds, partially separated from each other by transverse false partitions.

Bird's-foot trefoil is a nutritious plant much liked in a young state by all kinds of stock. It is not very productive, but on account of its good quality and permanence is a leguminous plant worthy of inclusion in permanent grass mixtures for the lighter classes of soil. Unfortunately genuine seed is expensive and liable to be adulterated with its allied species, **Greater or Marsh Bird's-foot Trefoil** (*Lotus uliginosus* Schk. = *L. major* Sm.) (see p. 652), which is a native of damp meadows, and only of agricultural value for use on marshy ground.

Bird's-foot trefoil is a very variable plant in habit of growth, and size of stem, leaves, and flowers: some varieties are smooth while others are hairy.

Gorse (Genus *Ulex*).

22. **Gorse, Furze, or Whin** (*Ulex europæus* L.).—A perennial bushy shrub growing from 2 to 5 feet high, and frequent on heaths and dry commons throughout the country.

The first foliage-leaves appearing after the cotyledons are trifoliate like those of clover, but with smaller rounded leaflets. On the older parts of the plant the leaves are very narrow, about a quarter of an inch long, and end in short, soft spines; in their axils arise rigid furrowed branches which end in stiff spines.

The flower is solitary and axillary, with yellow corolla, a deeply two-cleft calyx: the androecium is monadelphous.

The fruit is a two-valved legume, slightly longer than the calyx, and containing two or three seeds.

A small variety of this plant, named *Ulex strictus* Mackay, is met with in parts of Ireland; it has soft, spiny branches, but does not come true from seed.

Two other British species of *Ulex* are known, but they are of no practical importance.

Common gorse is cultivated in some districts upon thin, apparently sterile sandy soils, and utilised as food for horses and cows in winter. It forms very nutritious fodder, and cows are said to give a better yield of milk when fed with gorse than when they are given good meadow hay; moreover, the milk is of rich quality.

Before being fed to stock, the stiff spiny branches of the plant are generally crushed between rollers or otherwise bruised and softened by special simple machinery.

The seed is drilled in rows 10 to 18 inches apart in April or May on clean ground at the rate of 10 to 15 lbs. per acre.

The young plants are slow in growth, and the first cut is taken in the second year. After being established the crop is cut chiefly in winter and spring when green food is scarce.

In some districts an annual cut is taken, while in others the crop is cut once every two years; in the latter case alternate rows are cut.

Dyer's Greenweed or **Woad-wax** (Genus *Genista*).

To this genus belongs Dyer's Greenweed (*Genista tinctoria* L.), a shrubby leguminous weed of stiff clay soils (p. 606).

Rest-harrow (Genus *Ononis*).

23. To this genus belongs **Rest-harrow** (*Ononis spinosa* L.), a shrubby weed common in many districts, and difficult to exterminate on account of its deeply-penetrating roots (see p. 604).

Lupins (Genus *Lupinus*).

24. The genus *Lupinus* includes a large number of species of herbaceous and half shrubby plants many of which are grown in gardens for their handsome spikes or heads of brightly-coloured flowers.

Several annual species are cultivated on the Continent as farm crops for 'green manuring,' the chief of these being **Yellow Lupin** (*Lupinus luteus* L.), and in lesser degree **Blue Lupin** (*L. angustifolius* L.) and **White Lupin** (*L. albus* L.).

All the species are exceptionally rich in nitrogenous constituents and grow on poor sandy soils, which they enrich enormously when ploughed in.

Many sandy districts on the Continent which were practically valueless have been very materially improved in fertility by the utilisation of these plants as 'green manure.'

Lupins contain a greater amount of digestible albuminoids than any other known crop, and besides their use as a manure are also used in a green state folded off by sheep; they are occasionally made into hay. The plants contain a variable proportion of a bitter alkaloid which makes them unpalatable to horses and cattle, and sheep at first appear to dislike the crop.

In addition to the bitter alkaloid, lupins under certain indefinite conditions of soil, manuring, and storage sometimes contain a poisonous compound named lupinotoxine, which rapidly produces fatal results in sheep when the latter are fed with even moderate amounts of the cut green fodder or hay. Of the various methods to render the lupin crop perfectly innocuous, heating with steam under pressure of one or two atmospheres has proved the most certain.

Lupins succeed best on dry sands or light sandy loams. On light calcareous ground they do not grow satisfactorily; even on sand resting on a chalky subsoil they often fail. Stagnant water in the subsoil or an excess of humus in the soil is also detrimental to their development.

In the early stages of growth the tap root develops extensively while the parts above ground grow very slowly.

25. **Yellow Lupin** (*Lupinus luteus* L.).—This species is the one most generally grown as a farm crop. It is an annual, with erect hairy stem from 2 to 3 feet high. The leaves are palmately compound with from seven to nine lanceolate leaflets.

The inflorescences are loose pyramidal heads consisting of several (five to twelve) whorls of bright yellow papilionaceous flowers.

The ripe legumes contain three or four seeds and are from $1\frac{1}{2}$ to 2 inches long; they appear swollen at the seeds, and the valves are woolly on the outside.

Each seed is roundish kidney-shaped about the size of a pea, of whitish colour flecked with black spots and small streaks.

The seeds are drilled in rows from 9 to 15 inches apart on a clean seed-bed in May or June; $1\frac{1}{2}$ to 2 bushels per acre are needed.

26. **Blue Lupin** (*Lupinus angustifolius* L.) is an annual with taller stems, more woody than those of the yellow species, and hence not so suitable for fodder; the leaflets are narrow and the flower spikes have fewer flowers and these are blue in colour. The seeds are rough, about the size of a small bean seed and generally buff coloured flecked with rusty spots.

The **White Lupin** (*Lupinus albus* L.) is a South European species grown extensively in warmer parts of France, Spain and Italy for green manuring and for its seeds, which are used as food after the bitterness has been removed from them by steeping in water; it requires a hot climate to ripen its seeds properly.

Ex. 228.—The student should examine all the leguminous plants mentioned which have not previously been dealt with in order to become practically acquainted with the peculiarities of each species. Make a point of watching their development as far as possible, and compare their flowers, fruits and seeds.

SUMMARY OF THE GENERIC CHARACTERS OF LEGUMINOUS FARM-PLANTS.

1. **Leaves pinnate, ending in tendrils** (Fig. 33), except in the bean the petiole of the leaf of which ends in a short bent point. Androecium diadelphous: legume two-valved, dehiscent.

a. Free end of staminal tube cut off at right angles to its length; style, threadlike. Genus *Vicia* (**Vetches and Bean**).

b. Free end of staminal tube cut off obliquely; style flattened.

(i) Style not grooved, Genus *Lathyrus* (**Everlasting Pea**).

(ii) Style grooved, Genus *Pisum* (**Garden and Field Pea**).

2. **Leaves pinnate, with two or more pairs of opposite and one single terminal leaflet.**

a. Androecium diadelphous.

Fruit indehiscent, but split transversely into one-seeded nut-like joints (a lomentum). Genus *Ornithopus* (**Serradella**).

Fruit a one-seeded nut. Genus *Onobrychis* (**Sainfoin**).

Fruit a long two-valved dehiscent legume.

Genus *Lotus* (**Bird's-foot Trefoil**).

- b.* Andrœcium monadelphous (in the single British species).
 Calyx inflated ; fruit a one-seeded nut.
 Genus *Anthyllis* (**Kidney-Vetch**).
3. **Leaves with three leaflets.**
u. Andrœcium diadelphous.
 (i) Flowers in a dense head.
 Faded corolla encloses the fruit. Genus *Trifolium* (**Clovers**).
 Faded corolla drops away from the fruit ; legumes curved or spirally
 twisted. Genus *Medicago* (**Lucerne and Yellow Trefoil**).
 (ii) Flowers in open elongated racemes.
 Fruit short, indehiscent, with one to three seeds.
 Genus *Melilotus* (**Mellot**).
- b.* Andrœcium monadelphous. Genus *Ononis* (**Rest Harrow**).
4. **Leaves simple.**
 (i) Leaves spinous.
 Calyx deeply two-lipped. Genus *Ulex* (**Gorse**).
 (ii) Leaves flat.
 Calyx shortly two-lipped. Genus *Genista* (**Dyer's Weed**).
5. **Leaves digitate with more than three leaflets.**
 Genus *Lupinus* (**Lupin**).

CHAPTER XXXI.

UMBELLIFERÆ.

1. **General characters of the Order.**—Inflorescence generally a compound umbel; flowers small, bisexual, usually regular and epigynous. The outer flowers of the compound umbel are often irregular and zygomorphic, the petals directed outwards being larger than those pointing inwards.

Calyx superior, often absent; when present it generally consists of five minute tooth-like projections. Corolla polypetalous, five petals, obcordate or obovate, usually curved inwards at the free tip, mostly white, yellow, or pink. Androecium of five stamens curved inwards in the young flower. Gynæcium inferior, syncarpous, two carpels; each carpel contains one pendulous ovule. The ovary bears on its summit a fleshy swollen nectary termed the *stylopodium* (*d*, Fig. 134). From the stylopodium arise two stigmas, which are often slightly curved outwards.

The line of union of the two carpels is known as the *commissure* (*c*, *D*, Fig. 134). Each carpel frequently bears on its surface nine more or less well-marked raised lines or ridges. Five of them are described as *primary ridges*; two of them, the *marginal* ones, are close to the commissure, the other three, *dorsal* ridges, being regularly placed on the back or dorsal part of the carpel (*D*, Fig. 134). Sometimes occupying the spaces intermediate between these five ridges are four *secondary ridges*, which are occasionally as prominent or more so than the primary ones; they are, however, often missing or but feebly developed.

The ridges may be continuous simple raised lines or may consist of lines of prickly, hairy, or knob-like projections.

In the wall of the ovary are longitudinal canals termed *vittæ*, which most frequently are present in the substance of the furrows between the primary ridges (*v*, Fig. 134), and when the fruit is ripe can often be seen as dark brown or black lines on the pericarp wall. They contain secretions of volatile oils, balsams, and gum-resins, which generally give to the fruit its peculiar odour and taste; the characteristic taste of caraway, coriander, and other similar fruits of the Umbelliferæ is due to essential oils in their *vittæ*

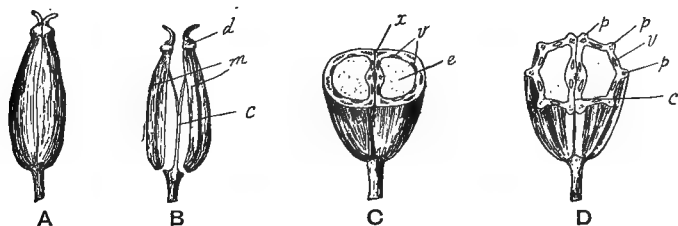

FIG. 134.—A, Fruit of Wild Chervil (*Chærophylum sylvestre* L.).
 B, The same later, showing the manner of splitting. *c* carpophore; *m* mericarps; *d* stylopodium.
 C, Transverse section of *A*. *x* Commissure; *v* vittæ; *e* endosperm of the seed.
 D, Transverse section of the ovary of Fennel (*Feniculum officinale* All.). *p* Primary ridges; *v* vittæ; *c* commissure.

The number and arrangement of the ridges and vittæ are best seen when the ovary is cut transversely.

The fruit is a schizocarp which divides into two mericarps; each of the latter is a closed carpel containing a single endospermous seed. When the fruit is ripe the mericarps separate from each other and remain suspended on a thin, usually divided, extension of the flower axis, termed the *carpophore* (*c*, *B*, Fig. 134).

The seed is endospermous and generally united with the inner wall of the pericarp. The endosperm contains a considerable proportion of oil and no starch. The embryo is small, embedded

in the endosperm in the part of the seed nearest to the apex of the fruit.

The flowers are generally pollinated by small insects, which easily obtain the exposed nectar secreted by the stylopodium. Protandrous dichogamy is common; the stamens often set free their pollen and wither up before the styles are developed.

2. The Umbelliferæ is an Order comprising about 1300 species of plants, generally herbaceous, and most largely represented in temperate regions.

The stems are frequently hollow. The leaves are alternate, their blades usually very much divided in a pinnate manner, and the petioles often very broad and inflated, forming a sheath which partially clasps the stem.

There is a great similarity among many of the species and genera of the Order, and only careful attention to details of the form of the fruit, its ridges and vittæ, and the presence or absence of involucre below the umbels and umbellules will enable a student accurately to distinguish the various species he may meet with.

A common characteristic of umbelliferous plants is the possession of secretory canals, which become filled with essential oils, balsams, or gum-resins. These canals are not only met with in the pericarp of the fruit but are frequently present in the stems, roots, and leaves, and it is from the substances secreted in these canals that many of the plants derive their strong aromatic odour and taste.

Many of the representatives of the Order, such as hemlock and cow-bane, contain poisonous alkaloids; the dangerous compounds are not present in any special canals or ducts, but are common in the cell-sap of all parts of the plants, but sometimes more especially present in their stems, leaves, or roots.

The only plants cultivated on the farm belonging to the Umbelliferæ are the **Carrot** (*Daucus Carota* L.) and **Parsnip** (*Peucedanum sativum* Benth.). Besides the above those common in

gardens also included in this order are **Celery** (*Apium graveolens* L.), **Parsley** (*Carum Petroselinum* Benth.), and **Caraway** (*Carum Carui* L.).

A number of species of Umbelliferæ are important on account of their poisonous qualities; the chief ones are mentioned later. A few are weeds of the farm, but practically none of these need serious attention.

3. **Wild Carrot** (*Daucus Carota* L.).—A well-known plant common in dry pastures and on roadsides throughout the country. It most frequently behaves as an annual, though it is occasionally biennial. With the exception of its root, which is comparatively thin and woody, it resembles the cultivated forms in stem, leaf, flower, and fruit.

The wild carrot affords one of the best examples of the possibility of rapid modification of plants by special selection and improved cultivation. M. Vilmorin raised passable garden varieties with thick fleshy 'roots' and of biennial habit in four generations from the wild species, and there is no doubt that all the *cultivated forms* of carrot have been derived from the same source.

4. Cultivated Carrot.

SEED AND GERMINATION.—The so-called carrot 'seed' used for raising a crop consists of the mericarps of the fruit (see below).

The young seedling possesses two long narrow cotyledons, a well-marked hypocotyl which at first grows above ground, and a slender primary tap root (1, Fig. 135). The hypocotyl and root are quite distinct from each other in colour and general appearance in the early stages of growth.

ROOT AND HYPOCOTYL.—Without going into the internal anatomy it is always possible in very young seedlings to distinguish these two parts of the plant.

The hypocotyl is free from roots, but the primary root bears a number of secondary ones chiefly in four longitudinal rows.

After a time it is noticed that in many cultivated forms, and especially those grown in gardens, the hypocotyl, which is at

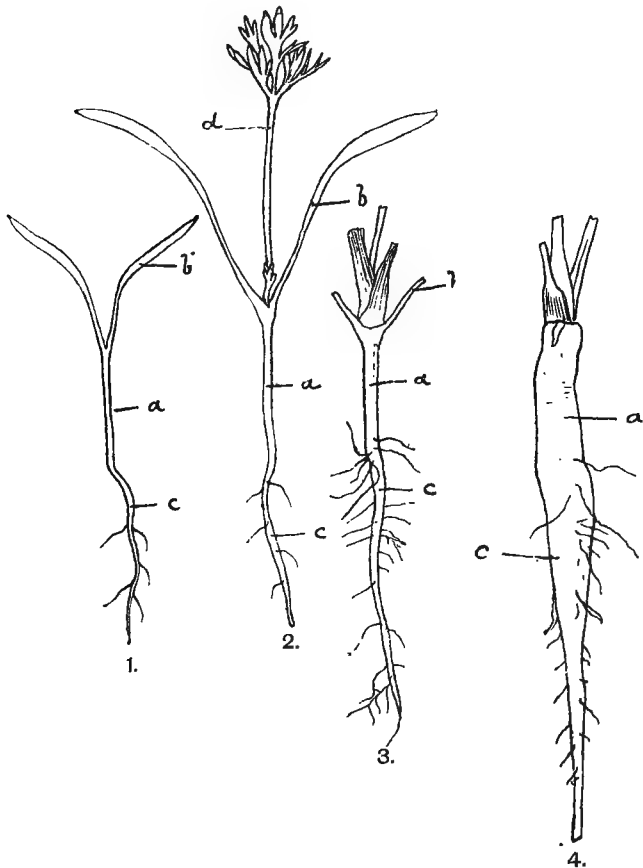

FIG. 135.—Carrot seedlings at four successive stages of growth. *a* Hypocotyl; *b* cotyledon; *c* root; *d* first foliage-leaf.

first above ground, becomes gradually drawn below the surface by the contraction of the root; the hypocotyl itself sometimes

contracts also and the cotyledons, which were originally some distance above the soil, now lie close upon it.

Soon thickening commences, both in the primary root and hypocotyl, and as adventitious roots make their appearance from the internal tissues of the latter, the distinction between the stem and the true primary root becomes rapidly obliterated so far as external appearances are concerned. In some field carrots a good deal of the hypocotyl continues to grow above ground, thus resembling mangels and turnips.

On good soils the primary root extends to a considerable depth, but only the upper portion of it becomes thickened; the lower part, which is left in the ground when the 'carrot' is pulled or dug up, is long, thin, and cord-like, and bears many fine branching rootlets.

As in the case of all fleshy farm 'roots,' except kohlrabi, the 'root' of the carrot, for which the plant is cultivated, consists of hypocotyl and root combined, the relative amount of each varying in different 'races' or 'strains' of the plant.

On the outside of the 'carrot' are seen delicate secondary roots which are arranged in four longitudinal rows; but on account of irregular growth the rows do not always remain straight.

The thickened fleshy 'root' of the carrot, like that of the turnip, presents the same general arrangement of tissues as is met with in ordinary typical dicotyledonous roots and stems: the differences consist in the abnormal development of the elements composing its tissues.

A transverse section of a carrot (2, Fig. 136) shows a layer consisting of parenchymatous bast and secondary cortex (*d*), which is wide in comparison with that of the turnip 'root,' and of red or scarlet hue in red varieties. In the centre is the 'core' of wood (*a*), generally yellowish or dull white in colour.

The relative proportion of wood to bast varies in different 'races' of carrots; the endeavour of the plant breeder is to obtain a relatively wide cylinder of bast (*d*) and a small core,

as it is in the former that the greatest amount of sugar and other nutrient materials is stored.

The wood in the first season of growth contains no fibres or fibrous cells, but consists mainly of thin walled unligified vessels and delicate wide-celled wood-parenchyma. Narrow medullary rays are visible. In the second season and in 'bolted' carrots which have run to seed in the first season, the wood last produced by the cambium-ring (*c*) becomes strongly lignified and fibrous by the time that flowering commences.

STEM AND LEAVES.—During the first season of growth the carrot stores up reserve food in its thickened root and hypocotyl; the epicotyledonary portion of the stem remains short until the second season, when the terminal

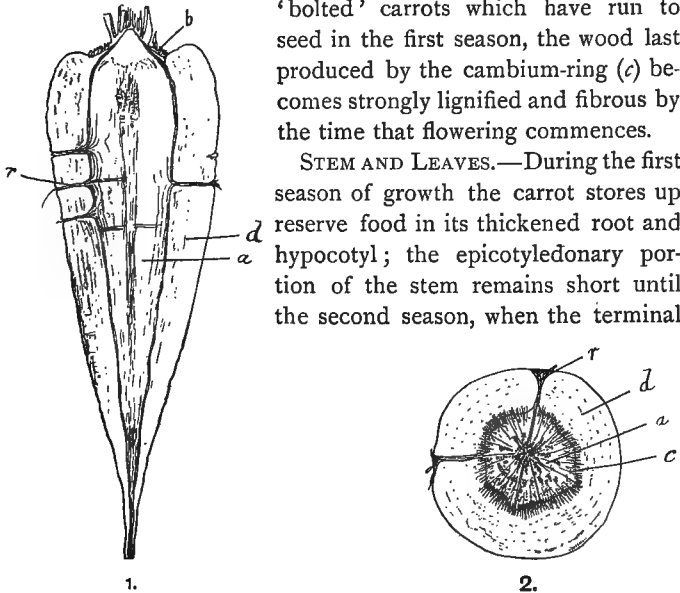

FIG. 136.—(1) Longitudinal; (2) transverse section of carrot 'root,' showing disposition of tissues. *d* Thin-walled parenchymatous bast and secondary cortex; *a* wood ('core'); *c* cambium-ring; *r* secondary root.

bud sends forth a furrowed, somewhat bristly, solid stem 2 or 3 feet high with spreading branches.

The radical leaves have long petioles; all are bipinnate with deeply pinnatisect leaflets, the ultimate segments being small and narrow.

INFLORESCENCE AND FLOWERS.—The inflorescence is a com-

pound umbel: the bracts of the involucre extend as far as or beyond the flowers, and are pinnatifid, the segments very narrow and acuminate. The umbellules have involucels of narrow, or pinnatifid bracteoles.

After flowering the outermost main branches of the compound umbel curve inwards, and the whole inflorescence then forms a hollow cup or nest-like structure.

The flowers (1, Fig. 137) are epigynous: the calyx superior, consisting of five short tooth-like sepals: the corolla is composed of five white incurved petals alternating with the sepals (the petals of the central flower of the umbel are often pink or reddish); the

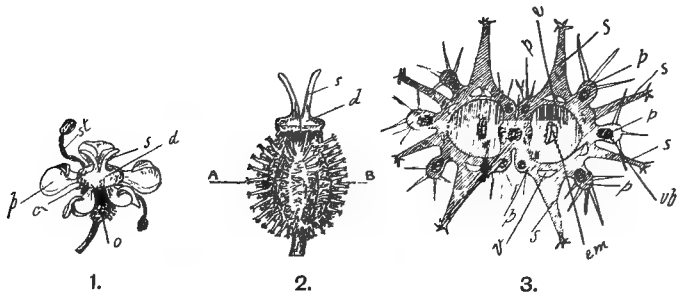

FIG. 137.—1. Flower of Carrot (*Daucus Carota* L.). *c* Minute sepal of calyx; *p* petal; *o* ovary; *st* withered stamen; *d* stylopodium; *s* style and stigma.
2. Fruit of Carrot. The ovary is covered with long spines and hairs. *d* Stylopodium; *s* style and stigma.
3. Transverse section (magnified) of ovary through line *A, B, d* (2). *p* Primary ridges; *s* secondary ridges; *v* vittæ; *vb* vascular bundles; *em* embryo of seed.

androecium possesses five stamens, which set free their pollen and fall away soon after the flower opens; the gynæcium is inferior and syncarpous, consisting of two united carpels; the upper part of the ovary has a white fleshy stylopodium which bears two curved stigmas.

The four secondary ridges on each carpel are more prominent than the primary ones, and bear ten or twelve long spinous projections, on the end of which are three or four slightly hooked

hairs : the five primary ridges (*p*, Fig. 137) bear long unicellular hairs.

THE FRUIT AND SEED.—The fruit is a schizocarp. Upon the two dry mericarps the spiny secondary ridges are conspicuous, of light brown tint. It is on account of these spiny projections that the mericarps cling together and prevent the 'seed' from being sown evenly without previous rubbing and mixing with sand or dry ashes.

Each mericarp contains a single endospermous seed, with a minute dicotyledonous embryo.

Within the wall of the pericarp in each secondary ridge is one, rarely two, vittæ (3, Fig. 137, *v*), containing an oil which gives the ripened mericarps a characteristic odour most easily recognised when the latter are rubbed vigorously in the hands.

VARIETIES.—Carrots vary much in the length, rapidity of growth, and colour of their 'roots.'

They also differ in their feeding-value, and the proportion of 'rind' to 'core.' Moreover, some varieties grow with a considerable proportion of their thickened 'root' (hypocotyl) above ground, while others have their 'roots' entirely buried in the ground.

Of all varieties the **White Belgian** gives the largest crop. The upper part of the 'root' is pale dull green, the lower part and flesh white. The 'roots' are of moderate length, very thick, and grow with the upper parts about 6 inches above the ground : from $\frac{2}{3}$ to $\frac{3}{4}$ of the white root is below ground. It is a hardy variety adapted to almost all soils. The feeding-quality is low compared with the red varieties.

Of slightly superior quality, but smaller yielding capacity, is the **Yellow Belgian**, with yellow flesh, but otherwise resembling the white variety.

Of red varieties the best cropper is **Red Altringham**. It possesses thick long roots ending somewhat abruptly : the upper part grows slightly above ground and is of greenish-purple

colour; the rind is pale orange-red, the rather small core is yellow. It needs good deep soil for proper growth and is superior in feeding value to the White Belgian variety.

For growth upon shallower soils the '**Scarlet Intermediate**' Varieties are best. They are very thick, usually only about two-thirds the length of the Red Altringham, and of excellent feeding-quality. Some of them are adapted for market-garden purposes.

Long Red Surrey is a variety with tapering roots of great length in proportion to their thickness; the rind is deep red, core yellowish. For field cultivation it is not so good as Altringham.

SOIL.—Stiff soils and those which are very shallow are unsuited to this crop.

The long varieties of carrots require a deep well-pulverised sandy loam: on shallow soils, especially where the subsoil is stony or imperfectly broken up, the deep-growing varieties lose their symmetrical shape and become irregular, 'fanged' or 'forked,' some of the secondary roots becoming thickened as well as the main primary root. To some extent the variety can be adapted to the character of the soil; a few of the short thick kinds sometimes produce a fair crop on comparatively shallow soil.

SOWING.—The 'seed' of the carrot germinates somewhat slowly, and the young plants on account of their small narrow leaves are liable to be smothered by annual weeds. To avoid this it is advisable to damp the 'seed' and allow it to remain in a small heap for seven or eight days until signs of germination are apparent before drilling. The 'seed' is best mixed and rubbed with dry sand or ashes previous to sowing. The crop is generally drilled in rows from 18 to 24 inches apart, on well-cleaned and finely pulverised soil. The superabundant young plants are subsequently hoed out, and the remainder singled and left about 6 or 7 inches apart. From the beginning to the end of April is the best time for sowing; earlier than this the temperature is too low

to promote vigorous growth of the carrot and the plants are liable to be smothered by annual weeds if germination and active growth is delayed.

The amount of good, new, well-cleaned seed necessary for one acre is 4 or 5 lbs.

YIELD.—The average yield varies from 10 to 20 tons per acre according to the variety grown.

The White Belgian variety occasionally gives a crop of 30 tons per acre.

COMPOSITION.—In a wild state the carrot stores up starch in its 'roots,' the cultivated forms however rarely or never store this carbohydrate in them, its place being taken by sugar.

The amount of water in White Belgian carrots is on an average about 88 per cent.; the red varieties contain from 86 to 87 per cent. The soluble carbohydrates, of which the greatest proportion is sugar, averages 9·2 per cent., the nitrogenous substances generally reach 1·2 per cent. of which a little more than half are albuminoids. The 'fibre' is rather high, namely 1·3 per cent.

With the exception of parsnips and potatoes, red carrots contain more nutritious dry matter per ton than any other root crop ordinarily grown as food for stock: the leaves or 'tops' are excellent, as well as the 'roots.'

Ex. 229.—Examine the commercial 'seeds' of the carrot. Note the secondary ridges of spines. How many ridges are there on each? Cut thin transverse sections of the mericarp and examine them for the vittæ.

Note the odour when the 'seeds' are rubbed in the hands.

Ex. 230.—Raise carrot seedlings in damp sand or sandy soil, and note the length and shape of the cotyledons, hypocotyl, and primary root. Observe the amount of hypocotyl above ground in a bed of seedling carrots in the garden and watch the withdrawal of the hypocotyl into the ground as the plants increase in age.

Ex. 231.—Carefully dig up a half-grown carrot, taking care to go deep enough to obtain the fine extension of the tap root, and also the secondary roots. Wash away the earth carefully and examine the extent, thickness, and position of the lateral roots.

Ex. 232.—Cut longitudinal and transverse sections of an old carrot. Note the colour, thickness and texture of the various parts. Observe that the lateral roots run through the orange parenchymatous bast and secondary cortex.

Ex. 233.—Examine the stem, branches, leaves, and inflorescences of a 'bolted carrot,' or the same parts in a wild carrot.

Ex. 234.—Examine and describe individual flowers of the compound umbel of a carrot. Observe the colour of the flower in the centre of each compound umbel.

Note the ovary and its two united carpels. Cut sections of young fruits and examine them with the microscope.

Ex. 235.—Obtain as many kinds of 'carrots' as possible. Note their colour, shape, length, and proportion of 'rind' to 'core' when cut across.

5. Parsnip (*Peucedanum sativum* Benth. = *Pastinaca sativa* L.).—A wild annual or biennial plant occurring on roadsides and waste places, especially on calcareous soils. Like the wild carrot this plant is very easily modified by cultivation, and all the field and garden parsnips have undoubtedly arisen from the common wild species.

The cultivated forms differ from the wild plant chiefly in the thickness of the root; the leaves and stems are generally less hairy than the wild parsnip, but in other respects there is no difference between the two.

SEED AND GERMINATION.—The 'seeds' sown for a crop are thin flat mericarps of the fruit, each of which contains a single true endospermous seed.

The seedling has two narrow cotyledons and its first foliage-leaves are cordate or palmately three-lobed with coarsely serrate margins.

ROOT AND HYPOCOTYL.—These parts of the plant resemble those of the carrot.

STEM AND LEAVES.—The flowering stem sent up in the second season of growth is stout, with deep longitudinal furrows. It is hollow and grows to a height of 2 or 3 feet.

The leaves are oblong, pinnate, with two to five pairs of leaflets each from 1 to 3 inches long, ovate, with deeply

serrate margins ; the terminal leaflet is three-lobed. The upper surfaces of the leaflets are smooth, the lower surfaces soft and hairy.

INFLORESCENCE AND FLOWERS.—The inflorescence is a compound umbel without bracts or bracteoles. The flowers are epigynous : calyx superior, of five very small teeth : corolla of five small, bright yellow incurved petals : andrœcium of five stamens : gynœcium syncarpous, of two carpels, dorsally compressed with a broad commissure : each carpel has five primary ridges, the two marginal ones forming wing-like projections.

FRUIT.—The fruit is a dorsally compressed schizocarp ; the mericarps are thin and flat, of oval or circular outline, six dark brown vittæ reaching not quite to the base, are visible on each, four on the dorsal, and two on the inner (commissure) side. The fruit has a divided carpophore. Within each mericarp is a single flat, endospermous olive-green seed.

VARIETIES.—There are comparatively few varieties of this 'root.' Those cultivated as food for cattle are generally long-rooted varieties resembling the long carrots in shape.

The only two common varieties are (1) the **Large Cattle Parsnip**, which has the upper part of the 'root' rounded or convex, and (2) the '**Hollow Crown**,' which has a slightly shorter and thicker depressed or concave 'top'.

A form met with in gardens having a relatively very short thick 'root' is known as the 'Turnip-rooted' parsnip.

SOIL, CULTIVATION AND SOWING.—Parsnips can be grown on soil usually too stiff for a good crop of carrots, but the cultivation and general management needed for the latter is appropriate for the parsnip.

The 'seed' is best sown in March, an earlier date than that adapted to the carrot, at the rate of about 6 or 7 lbs. per acre. Less seed would suffice if new, but commercial samples are usually very poor in germinating capacity and nearly always mixed with old dead seed.

The drills are drawn about 15 inches apart, and the plants eventually singled out to a distance of 6 or 7 inches asunder.

The average yield of 'roots' per acre is about 11 tons.

COMPOSITION.—The parsnip properly grown contains less water than the carrot, and is the most nutritious of ordinary 'root' crops. The amount of water appears to average about 83 per cent: starch is present in small quantity, but the chief useful carbohydrate is sugar.

Ex. 236.—Carry out experiments and observations upon the parsnip similar to those mentioned for the carrot on pp. 449, 450.

The poisonous Umbelliferæ, with which it is desirable that the student of agriculture should be acquainted, are the following:—

6. **Hemlock** (*Conium maculatum* L.).—A common biennial plant, generally 2 to 3 feet high, occurring in hedges, fields, and waste places in many parts of the country. The stem is smooth, hollow, of dull green colour with a thin grey bloom upon it, and spotted with small brownish-purple blotches. The leaves are large tripinnate, with lanceolate pinnatifid leaflets: they are of peculiar dark glossy-green tint. The compound umbels of white flowers possess both bracts and bracteoles.

The fruit is oval or round; each mericarp possesses five characteristic knotted primary ridges.

The whole plant has a foetid smell, and is excessively poisonous. Its dangerous qualities are due to the presence of several narcotic alkaloids which are met with in greatest abundance in the leaves, young shoots, and fully-developed green fruits; the chief of these poisonous compounds is conine.

7. **Water Hemlock** or **Cow-bane** (*Cicuta virosa* L.).—A somewhat uncommon tall perennial met with in ditches and by the side of rivers. The flowers are white and the stem from 3 to 4 feet high, thick and furrowed; its leaves are large, twice or thrice pinnate, the leaflets about 2 or 3 inches long and lanceolate, with serrate margins. Cows are sometimes poisoned by eating it, hence its name.

8. **Water Dropwort** (*Oenanthe crocata* L.).—A tall perennial resembling celery and sometimes mistaken for it with fatal results. It grows in situations similar to those suited to wild celery, namely, near rivers and ditches. The flowers are pale yellow, and the juice squeezed from the plant is yellow, and stains the skin.

9. **Fool's Parsley** (*Aethusa Cynapium* L.).—A common annual weed of cultivated ground, both gardens and fields. Its stem is slightly furrowed and generally about a foot high. The leaves are bipinnate, smooth and shining, of dark green colour, and when bruised have a strong stinking odour. The flowers are white, and the small umbels have involucels of three or four long, narrow, slender bracteoles which point outwards. By the smell and the conspicuous bracteoles the plant is readily distinguished from others of similar general appearance. It has occasionally been mistaken for parsley with bad effect, but rarely, if ever, led to fatal results.

Ex. 237.—The student should examine the roots, stems, leaves, inflorescences, and fruits of as many common wild umbellifers as possible. He should also become especially acquainted with the botanical characters of the poisonous species just mentioned.

CHAPTER XXXII.

SOLANACEÆ.

1. General Characters of the Order. Herbs or shrubs. Leaves usually alternate, exstipulate. Flowers generally regular, hypogynous. Calyx, inferior gamosepalous, 5-fid, persistent. Corolla hypogynous, gamopetalous, 5-lobed, usually campanulate or salver-shaped.

Androecium of 5 epipetalous stamens. Gynæcium syncarpous, 2 carpels; ovary usually 2-celled with many ovules on a thick axile placenta. Fruit a capsule or berry; seed endospermous.

An extensive Order of plants, chiefly found in the tropics and especially in South America. Poisonous alkaloids occur in many plants belonging to the Order.

The genus *Solanum*, from which the Order is named, embraces about 800 or 900 species, many of them ornamental plants. Only five or six species bear tubers, the chief being the common potato.

2. Potato (*Solanum tuberosum* L.).—Introduced into Europe in the sixteenth century, first to Italy and Spain, and independently into the British Isles a little later in the same century.

SEED AND SEEDLING.—The albuminous seed germinates readily and produces a young seedling with well-marked primary root and two ovate cotyledons (4, Fig. 138). The plumule develops into an upright stem with leaves, and from the axils of the cotyledons, whose petioles lengthen considerably, shoots arise which are positively geotropic (Fig. 140). These shoots soon find their way into the ground, and after the growth of two or three internodes their tips become tuberous through the deposition within

them of reserve foods, the chief of which is starch (Fig. 141). Similar tuber-bearing shoots may also arise from buds in the axils of the foliage leaves above the cotyledons.

The thin part of the underground rhizomes bear scale-like leaves, and these are also present on the young tubers, but eventually shrivel up before the latter are ripe. Usually only

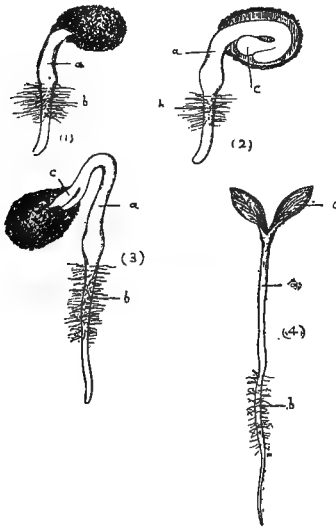

FIG. 138.

1. Potato seed germinating.
2. Section through the same, showing position of cotyledons and endosperm (shaded).
3. Seedling nearly free from seed-coat.
4. Seedling quite free (10 days' old); *a* hypocotyl; *b* root; *c* cotyledons.

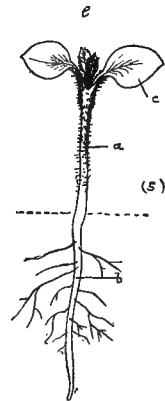

FIG. 139.

Potato seedling (16 days old), later stage of 4, in previous Fig., showing plumule *e*. The cotyledons *c* have become broader; *a* hypocotyl; *b* root. (Natural size.)

one tuber is developed at the end of a rhizome in seedling plants. Sometimes, however, lateral branches which bear tubers are produced from the axils of the scaly leaves of the rhizomes.

At the end of the growing season the stems and leaves above

ground and the thin parts of the underground stems die; the tubers remain dormant below during winter, and in the following spring germinate and send forth new shoots from their 'eyes.'

The tubers from a one-year-old plant are small, often not larger than a broad bean, and it is only after three or four years growth that they reach the size of ordinary potatoes.

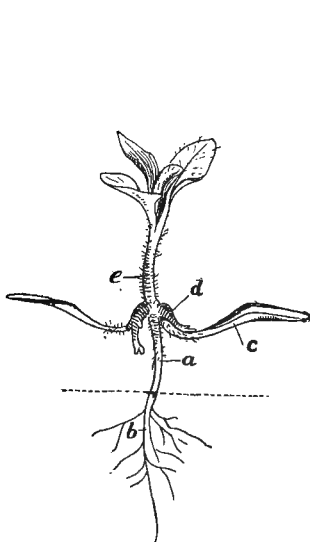

FIG. 140.

Potato seedling (26 days' old), later stage of Fig. 139. The Plumule *e* has developed considerably, and in the axils of the cotyledons two shoots *d* have been produced. *a* hypocotyl; *b* root; *c* cotyledons; *e* epicotyl; *x* ground-line (Natural size).

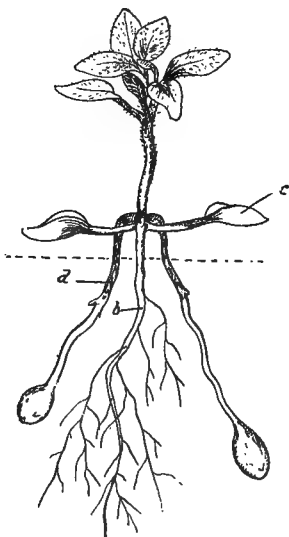

FIG. 141.

Potato seedling (10 weeks' old), later stage of Fig. 140. The shoots *d* have now pushed their way below ground and at their tips small tubers have formed. (Natural size.)

ROOT.—The roots of the potato plant extend themselves chiefly in the upper layers of the soil, and are fibrous and copiously branched. The primary root and its branches are distinct from the tuber-bearing rhizomes (Fig. 141), but from the nodes of all the stems below ground adventitious roots arise in

abundance. The extensive development of the latter depends upon the presence of moist air; in dry air they do not appear.

The tubers themselves never bear roots, and are, therefore, unlike the Jerusalem artichoke tubers in this respect.

STEM AND TUBER.—The stems are herbaceous; two forms are present upon the potato plant, namely, the upright stem above ground and the horizontal rhizome below.

Although their geotropic behaviour is not the same, they are essentially the same in structure; the rhizome can be changed into an ordinary shoot with green foliage-leaves by bringing it above ground.

The rhizome is usually not more than from 1 to 3 inches long in early varieties, and the tubers consequently appear heaped up round the stem when dug. Those giving heavier crops have longer and more branched rhizomes, while varieties with very long rhizomes usually give an unsatisfactory yield, although individual tubers may reach a large size.

Leafy stems resembling that from which Fig. 142 was drawn, and showing tuber development in the axils, are readily produced by allowing old tubers to germinate in spring in a darkened cellar kept somewhat damp. Moreover, if the potatoes are picked off below ground as fast as they form, the plant develops tubers in the axils of the leaves above ground.

The first internodes of the rhizome below ground are of considerable length; those produced later at its tip remain shorter, but increase in thickness rapidly, and form a tuber.

TUBER.—That the potatoes are thickened pieces of stems is seen from a study of their origin; the rhizomes, of which they are merely the ends, arise in a normal manner in the axils of leaves below the soil and although they occur under ground, they have no connection with the root-system of the plant.

A well-grown tuber usually shows at its base or 'heel' a piece of the withered rhizome, and on its surface many 'eyes' which

are arranged spirally. At the 'rose' end, or the morphological apex of the tuber, the 'eyes' are more crowded together than at

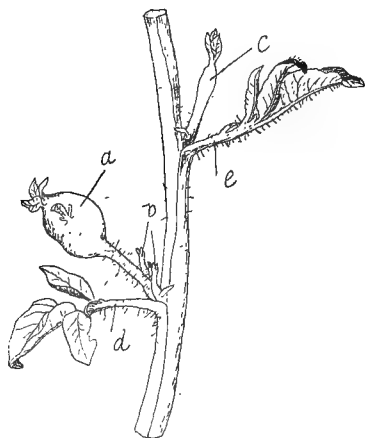

FIG. 142.—Leafy stem of potato, showing tuber growing in the axils of an ordinary leaf. *a* Tuber in axil of leaf *d*; *b* two more branches in same leaf-axil; *c* branch beginning to develop into a tuber in axil of leaf *e*.

its 'heel' or base, the older internodes being longer than the younger ones. Each 'eye' appears as a collection of buds lying more or less in a depression; the latter is the axil of a scaly leaf which was visible when the tuber was young, but now withered up and lost. The number of buds in each 'eye' may be as many as twenty, but three is the usual number.

In reality the 'eye' is a lateral branch with undeveloped internodes, the whole tuber being generally a richly branched shoot-system and

not a simple shoot.

Tubers are not always of the same form; three moderately distinct and fairly constant types are prevalent, namely, (1) 'round,' (2) 'oval,' and (3) 'kidney' shapes. The round type is somewhat spherical, and has fewer internodes and 'eyes' than (2) and (3), both of which are elongated. The kidney potatoes are thickest at the 'rose' end and taper towards the 'heel,' while the oval varieties are thickest in the middle and taper towards both ends. Those differences are sufficiently marked and constant to form a basis of classification of the varieties in cultivation.

In some instances the tubers are of very irregular shape. When long-continued dry weather checks vegetation, and is followed by rains, the partially-ripened tubers, instead of

increasing regularly in thickness when active growth begins again, grow out from the ends or about the lateral 'eyes.' The new growths may form irregular lumps or even smaller tubers on the older ones; this is known as super-tuberation or second growth, and is most common in kidney and oval varieties.

The anatomy of the tuber in its young state resembles that of the rhizome, to which it belongs, and like all similar stems possesses epidermis, cortex, and vascular cylinder with its cambium-ring and central medulla. The disposition of the tissues is readily seen in a young tuber (Fig. 143).

In a fully developed tuber the epidermis is replaced by periderm, the outer layer of which consists of cork-cells; the latter afford protection against excessive loss of water from the interior of the tuber. Beneath the

'skin' or periderm is the cortex, and in its outer cells the cell sap is frequently coloured, giving a characteristic tint to the different varieties of potatoes. The cambium in its growth produces much wood, and it is this tissue which forms the

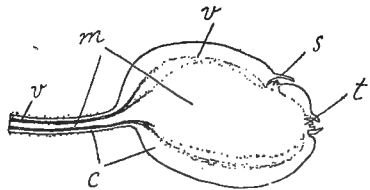

FIG. 143.—Longitudinal section of a young potato tuber. *c* cortex; *v* vascular bundle; *m* medulla; *s* scale leaf in the axil of which is a bud; *t* terminal bud.

main bulk of the tuber; instead of the wood, however, consisting of lignified tissue it is almost entirely made up of parenchymatous thin-walled cells, with only a few isolated groups of lignified elements, and cannot therefore be readily distinguished from the medulla and cortex.

The chief reserve-food stored in the tuber is starch, the largest amount being found in the innermost parts of the cortex, the degenerate wood-tissue, and part of the medulla. In thin slices of the potato the bast, cambium and centre of the medulla appear semi-translucent, and contain little or no starch.

GERMINATION OF THE TUBER.—Ripe potatoes cannot be

made to germinate before a certain time has elapsed. Some varieties need a rest of two months only, while others ripened in autumn do not show signs of growth before January or February, or even later.

The minimum temperature for germination is about 8° or 10° C., so that tubers planted very early make little or no growth.

The cause of the resting-period and the chemical changes which go on during that time are not clear. Respiration which is carried on at the expense of the starch can be recognised; at first it is slow, but increases rapidly towards the end of the resting-period.

When germination commences, the enzyme diastase is formed, whereby the starch is changed into sugar: the latter is transferred to the growing buds, where it is utilised in the formation of new cells. The first development of the shoots is carried on at the expense of the stores of reserve-food within the tuber.

Rarely do two buds on the same tuber develop equally strongly, the most vigorous being the terminal one, or the central bud in the 'eyes' near the apex of the tuber. The buds at the base of the tuber are weakest, and often remain dormant altogether. When tubers are cut for 'sets' so that each piece contains one 'eye,' those pieces from the 'rose' end always produce the most vigorous plants and the best yield. If the main shoot produced from the central bud of an 'eye' is broken off or otherwise destroyed, the lateral buds in the 'eye' grow out, but their shoots are never so strong or vigorous as the lost one.

The shoots produced from the growing buds of potatoes exposed to the light during germination have short internodes and scaly leaves, in the axils of which three lateral buds are usually visible. After planting the tuber, the tip of the main axis of each shoot grows upwards into the open air, where the unfolding leaves carry on 'assimilation.' The food manufac-

tured by the leaves passes down the stem, and from the middle bud in each leaf-axil below ground a thin rhizome develops, which, after reaching a variable length, generally forms a new tuber at its end (Fig. 144). When the old dead tuber has been exhausted of its store of food, it still contains water obtained

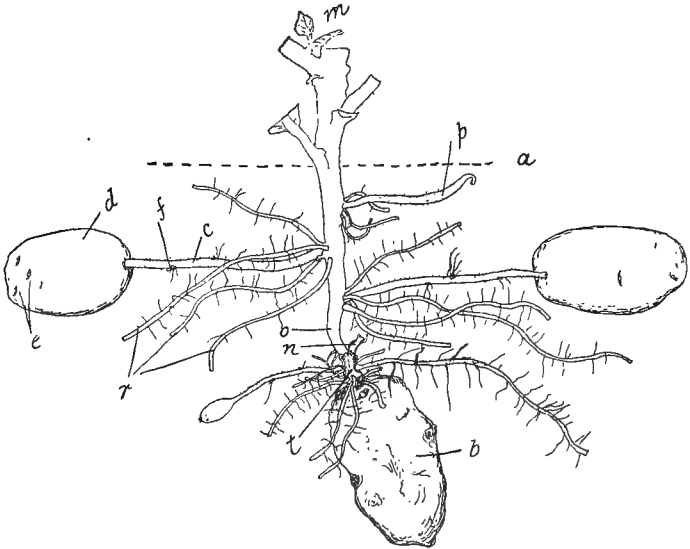

FIG. 144.—Potato plant raised from an old tuber, and showing the arrangement and nature of parts below ground. *a* ground line; *b* old tuber showing short, stiff stem *t* produced during germination in the light before being planted; *o* and *n* branches from *t*, the tip of *n* has been broken off; *o* stem which has come above ground, cut off at *m*; *c* rhizome, the end of which has developed into a tuber *d*, upon the latter are seen buds at *e*; *f* lateral bud on *c*; *p* a rhizome similar to *c*, but which has not yet formed a tuber; *r* roots (adventitious).

from the surrounding soil, and acts as a reservoir for the growing plant in the dry part of the season.

It must be observed that rhizomes only produce tubers when they are kept in the dark, hence the value of 'earthing up,' and the necessity of doing it at intervals so that newly-formed rhizomes resembling *p* in the above Fig. may be properly ex-

cluded from the light. Rhizomes exposed to light become ordinary green-leaved shoots.

Before planting tubers it is important to germinate them, if possible, in the light, in order to obtain from each awakening 'eye' a short, thick piece of stem with many nodes upon it, as it is from the axils of the leaves at the nodes that the rhizomes are produced which bear tubers. This practice influences the yield to a considerable extent, for if the tubers are allowed to start growth in the dark, either indoors or below ground, the shoots from the 'eyes' have longer internodes and fewer points for the production of tuber-bearing rhizomes underground; moreover, the leafy shoots sent above ground are weak when the latter method is adopted.

LEAF.—The leaves are compound, interruptedly pinnate, opposite pairs of small leaflets alternating with pairs of larger size.

FLOWER (Fig. 145).—The flowers are in cymes: calyx inferior, gamosepalous, five-partite; corolla hypogynous, gamopetalous, five-lobed, rotate, violet, lavender or white. Andrœcium epipetalous, five stamens, with yellow anthers dehiscing by pores at the tip. Gynœcium superior, syncarpous, 2 carpels, ovary bilocular.

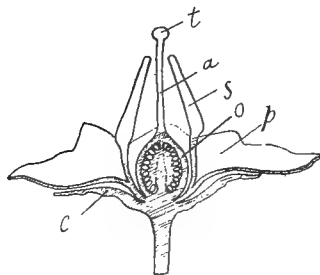

FIG. 145.—Section of potato flower. *c* calyx; *p* corolla; *s* stamen; *o* ovary; *a* style; *t* stigma of the gynœcium.

FRUIT.—The potato "apple" or fruit is a berry with many seeds attached to a thick axile placenta (*p*, Fig. 146.) Many varieties of the potato rarely produce flowers when cultivated in the ordinary way; even those which do so are often unable to ripen fruit and seeds. This is especially the case with varieties which yield large crops of tubers; the latter attract the food manufactured by the leaves, and little or none remains for the

development of the flowers and fruit. If flowers are needed for hybridising purposes, plucking off the early-formed tubers often produces the desired result.

VARIETIES.—Considerable attention has been paid to the improvement of the potato, and many varieties are in existence differing in yield, ripening period, shape, quality of tuber, and in many other points. They may be classified in several ways, but are usually placed in groups according to their time of ripening, their shape, or colour.

The **early varieties** are consumed in an unripe condition, and are adapted for forcing for early markets. To this class belong Ashleaf, Beauty of Hebron, Snowdrop, Early Regent, and others.

The **mid-season or second earlies** are dug green for the summer market, and may be left to mature with the later varieties. Sir John Llewellyn, Reading Russet, British Queen, and Windsor Castle belong to this class.

The **late or main-crop varieties** ripen in autumn, and often grow until cut down by frost. Abundance, Up-to-Date, Factor, Duchess of Cornwall, King Edward VII. may be mentioned as typical of this section.

It is of little use to attempt to raise new varieties by selection of tubers only, as these are merely divisions of the parent and cannot be expected to give rise to new offspring unless the tubers chosen happen to be true bud-variations or 'sports.' The latter are, however, of rare occurrence in the potato plant. Marked variations are obtained in seedling plants, and it is from these that selection is made in order to obtain new and improved varieties.

The chief points of a good variety are the following:—

- (a) Strong disease-resisting power.
- (b) Good cooking quality; when steamed or boiled, the tuber should break easily into a glistening floury condi-

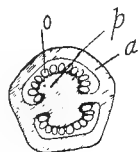

FIG. 146.—Transverse section of ovary of potato flower. *a* Wall of ovary; *b* placenta; *o* ovules.

tion without any appearance of clamminess or wetness, and should preserve a white colour even when cold.

- (c) The yield per acre should be high.
- (d) High starch-content is needed where the tubers are used for the manufacture of starch or in the distillery.
- (e) Shallow 'eyes,' and few of them, are looked for in the best quality, as those with deep depressions hold dirt, and necessitate considerable waste of substance when peeling is practised before cooking.
- (f) Good keeping quality.
- (g) Trueness to type of tuber should be aimed at. Whatever form the tuber takes—whether round, kidney, or oval—the crop should be as uniform as possible in this respect, and tendency to super-tuberation should be avoided.

CLIMATE AND SOIL.—The potato succeeds best in a warm and comparatively dry climate, and is unable to stand frost, exposure to a temperature of freezing point for a single night being sufficient to destroy the stems and leaves of a young crop.

The soils best suited to its growth are deep, sandy loams, lying upon porous subsoils; stiff clays and undrained peaty soils, with excessive amount of moisture present, are almost valueless for potato culture, unless well drained and cultivated, and even then the quality of the tubers produced upon such soils is unsatisfactory, although the yield is sometimes high.

SOWING.—New varieties are raised from true seeds, the resulting tubers being propagated for three or four years before a decision can be arrived at in regard to their usefulness.

The main crops of the farm and garden are raised by planting tubers ('sets'). Although large 'sets' almost invariably give the greatest yield of crop, for economical reasons tubers about the size of a hen's egg, and weighing about 3 or 3½ oz., are usually employed with good results. Small tubers produce weak plants. The best results are generally obtained by planting whole

tubers; but tubers may be cut into small pieces, each of which may be planted provided that it bears one or more 'eyes,' from which stems may arise.

From 12 to 18 cwt. of 'sets' are needed to plant an acre. Early varieties are planted in February and March, later ones in April, in drills from 24 to 27 inches apart, the tubers being placed about 15 inches asunder in the rows.

As far as possible the drills should run north and south, on somewhat stiff soils inclined to dampness; on drier soils east to west.

YIELD.—The average yield per acre is 7 or 8 tons.

COMPOSITION.—The most important ingredient in the tuber is starch, the amount of which varies from 10 to 26 per cent.; the best varieties usually contain about 18 to 22 per cent.

Sugar is absent from well-ripened tubers, and there is only a trace of fat in them.

The nitrogenous substances average a little over 2 per cent., of which about 1.2 are albuminoids, present in the protoplasm, in solution in the cell-sap, and also in the form of solid 'proteid-crystals.' The latter occur chiefly in the cells of the cortex.

The water-content averages about 75 per cent.

A poisonous substance solanin is present in nearly all parts of the plant, the young etiolated shoots of the tuber and the berries containing most.

Ex. 238.—Sow true seeds of potato plant in boxes or pots of earth, and examine at different stages of growth. Note the form of the cotyledons, the extent and position of the root, and the origin of branches which bear tubers.

Ex. 239.—Examine the arrangement of the 'eyes' on a large, long, coarse tuber, and note the relative number at the 'heel' and 'rose' end respectively.

Cut longitudinal and transverse sections of the tuber, so as to pass through one of its 'eyes,' and note the cortex, vascular part, and irregular outline of the medulla.

Ex. 240.—Examine several sprouted tubers which have been allowed to germinate in the dark on a stable or cellar floor without touching each other.

Note which 'eyes' have produced the strongest shoots, and the number of shoots from each 'eye.'

Ex. 241.—Carefully dig up a complete potato plant in June including the old tuber. Examine the roots and rhizomes bearing the young tubers, and note their position upon the plant. If very small tubers are present, look with a lens for the scale leaves near their 'eyes.'

Ex. 242.—Scrape away the earth from a young potato plant, and cut off all the tubers which are beginning to form, taking care not to injure the roots. Cover up the latter, and repeat the process at a later date. Watch the future development, and note the formation and structure of the tubers in the axils of the foliage-leaves.

Ex. 243.—Uncover an elongated underground rhizome of a potato plant which has just begun to form a small tuber at its tip, and allow it to grow above ground or on the surface of the soil where light can get at it. Observe the changes in its appearance from day to day for a fortnight.

Ex. 244.—Examine and make sections of the flower and fruit of a potato plant, and compare them with those of the tomato and woody nightshade.

3. Belonging to the genus *Solanum* are two wild indigenous plants, viz., Bitter-Sweet and Black Nightshade, both of which are poisonous and sometimes erroneously called Deadly Nightshade.

4. **Bitter-Sweet** (*Solanum Dulcamara* L.) is a shrubby perennial common in woods and hedges. The upper leaves are hastate, the lower ones cordate-ovate. The purple flowers resemble those of the potato but are smaller; the fruit is a red, ovoid berry.

5. **Black Nightshade** (*S. nigrum* L.), is a smaller plant, herbaceous and annual, with ovate leaves; most frequent in waste places. Its flowers are white, and the fruit a round, black berry.

Other plants occasionally met with belonging to different genera of the Solanaceæ are Deadly Nightshade and Henbane.

6. **Deadly Nightshade** (*Atropa Belladonna* L.) is an herbaceous perennial, about three feet high, met with about ruins and chalky waste places, but of comparatively rare occurrence. It possesses large broad, ovate leaves, and purple, drooping, bell-shaped flowers. The berries are a deep violet colour, and of sweetish taste. The whole plant contains hyoscyamine and atropine,

both of which are extremely poisonous alkaloids. The consumption of a few berries has led to fatal results.

7. **Henbane** (*Hyoscyamus niger* L.).—A hairy biennial, about two feet high, possessing a strong fetid odour, and growing on waste ground. The broad leaves are sessile and clasping, with pinnatifid margins; the flowers of greenish-yellow colour, veined with purple. The fruit is a two-celled capsule. The leaves and flowering shoots contain a poisonous alkaloid hyoscyamine, nearly related to atropine.

The tomato and tobacco plants also belong to this Order.

CHAPTER XXXIII.

COMPOSITÆ.

1. THE Compositæ is the most extensive Order, and comprises from 10,000 to 12,000 species, or roughly about one-tenth of all known seed-bearing plants.

A number of species, such as *Arnica montana* L., chamomile and wormwood, are of medicinal value; others, of which the artichoke and lettuce may be taken as examples, are useful food plants of the garden.

Plants belonging to the genera *Zinnia*, *Chrysanthemum*, *Dahlia*, *Aster*, *Gaillardia*, *Helianthus*, and others are largely grown as ornamental plants.

Not a single species, however, is grown as an ordinary farm crop in this country, though not a few, such as dandelion, thistle, groundsel, coltsfoot, mayweed, and ox-eye daisy are objectionable weeds (see pp. 592, 605).

2. **General characters of the Order.**—The most characteristic feature of the Order is the structure of the inflorescence: the latter is a *capitulum*, and consists of a number of small flowers collected into a compact head resembling a single large flower.

A common form of capitulum is seen in the ox-eye daisy (Fig. 147), the parts of which, with the dandelion described below, may be taken as typical of the commonest forms in the Compositæ. On its underside is a series of narrow scaly bracts termed *phyllaries*, arranged in whorls; the whole series of phyllaries is spoken of as the *involucre* of the capitulum.

In the centre of the capitulum are a number of small yellow flowers—the so-called *disk florets*—each of which has the

form shown at 2, Fig. 147. Each floret or small flower is regular and epigynous; the corolla gamopetalous and five-lobed; no calyx exists, or is only present in the form of a minute ring round the upper part of the ovary. The andrœcium consists of five stamens with filaments attached to the inside of the corolla (epipetalous); the anthers of the stamens are united together, and form a tube through which the style passes. (Stamens with united anthers and free filaments are described as *syngenesious*.)

The ovary is inferior and syncarpous, consisting of two united carpels; within it is a single erect anatropous ovule. The straight style has a divided tip.

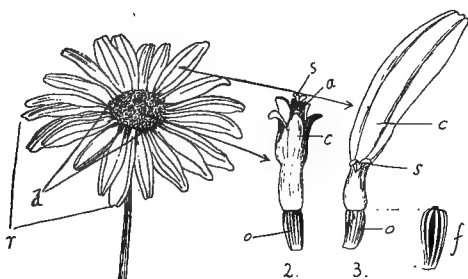

FIG. 147—1. Capitulum of Ox-eye Daisy (*Chrysanthemum Leucanthemum* L.). *r* The 'ray'; *d* the 'disk.' 2. 'Disk' floret (magnified). *o* The ovary; *c* tubular corolla; *a* anthers; *s* stigma. 3. 'Ray' floret (magnified). *o* Ovary; *s* stigma; *c* ligulate corolla, *f* fruit.

The fruit (*f*, Fig. 147) is one-seeded and indehiscent with a series of longitudinal ribs on its outer surface: it is a kind of nut or achene to which the special name *cypselæ* is given. The seed is without endosperm.

Besides the disk florets and surrounding them, there is a single ring of white flowers (*r*) resembling narrow strap-like petals. They form the 'ray' of the capitulum, and are termed *ray florets*. Each of the latter is a small unisexual (female) flower, and possesses a white corolla, the lower part of which is tubular, while the upper part is drawn out into a long narrow

structure, the tip of which is notched (3, Fig. 147). A corolla of this form is described as *ligulate*. The rest of the parts are similar to those of the disk florets.

Both the ray florets and the disk florets are sessile upon a short, thick button-shaped axis which is designated the *receptacle* of the capitulum, an unfortunate term likely to be confused with the receptacle of a flower, with which however it has nothing to do.

A large number of genera, the species of which have capitula composed of tubular florets only, or of tubular florets and an outer whorl of ligulate florets, are united to form a division of the Compositæ known as the TUBULIFLORÆ. Plants belonging to this series have watery juice in their stems and leaves.

Another group of genera, termed the LIGULIFLORÆ, is formed of those species whose capitula bear only ligulate flowers. Plants belonging to the Ligulifloræ, of which the dandelion and sow-thistle are examples, have milky juice (*latex*) in their stem and leaves.

A single flower from the capitulum of the dandelion is seen in Fig. 148. It is bisexual with a ligulate corolla formed of five petals shown by the five notches at its tip. The calyx is composed of silky hairs which encircle the upper part of the ovary. This ring of hairs grows most rapidly after fertilisation of the flowers when the fruit is ripening: it is termed the *pappus*, and acts as a parachute for the distribution of the fruit by the wind.

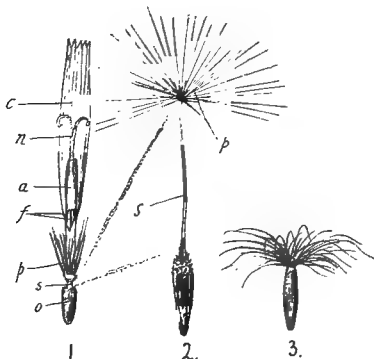

FIG. 148.—1. Single Floret of Dandelion (*Taraxacum officinale* Web). *o* Inferior ovary; *p* pappus (calyx); *a* anthers of stamens; *f* their filaments; *s* style and divided stigma; *c* ligulate corolla.

2. Fruit (cypsela) developed from 1. *s* Stalk of the pappus *p*.

3. Fruit (cypsela) of Groundsel (*Senecio vulgaris* L.) with sessile pappus.

In the dandelion the pappus is stalked, that is, situated at the end of the prolonged upper part or *beak* of the fruit (2, Fig. 148). In groundsel (3, Fig. 148) the pappus is sessile.

Ex. 245.—(1) Examine the inflorescences of ox-eye daisy, common daisy, sow-thistle, dandelion, groundsel, and any other common Compositæ. Note the form and extent of the involucre, the presence or absence of disk and ray florets.

(2) Cut vertical sections of the capitula and observe the form of the receptacles, whether flat, convex, concave, or conical. Note the presence or absence of small bristly or chaffy scales (bracteoles) on the receptacles near each flower.

(3) Examine the fruits of the above-mentioned plants. Note the presence or absence of a pappus; also the smoothness or roughness of the pericarp. Are the hairs of the pappus simple or branched?

3. Yarrow : Millefoil or Thousand-leaf (*Achillea Millefolium* L.) is a perennial plant belonging to the Compositæ, common in poor dry pastures, and possessing an extensive creeping root-stock. The stems are from 6 to 18 inches high, and furrowed. The leaves are 2 or 3 inches long, narrow, oblong, and much divided, the segments being very fine. The capitula, which are crowded together in a corymbose manner, are small, usually not more than $\frac{1}{8}$ or $\frac{1}{4}$ inch in diameter, with white or pinkish ray florets.

The fruits, commercially known as 'seeds,' are compressed, and have no pappus. Yarrow grows very early in spring, and possesses a strong aromatic odour when bruised. Sheep are fond of the young leaves, and generally keep the plants eaten down in pastures. But when it has developed its strong woody stem stock refuse it.

Yarrow is sometimes recommended for mixture with grass seeds when sowing down land for sheep pasture, but its use must be restricted to the narrowest limits, or it will soon disfigure and usurp the ground which should be allotted to better

plants. It should be left out of all grass mixtures where the produce is to be mown.

Ex. 246.—Dig up and examine a complete plant of yarrow in flower. Note the character of the rootstock, its tough stem and much divided leaves, and its corymbose collection of small capitula.

Carefully examine a single capitulum, noting the number and form of the ray and disk florets respectively.

Examine the fruits of yarrow.

CHAPTER XXXIV.

GRAMINEÆ. TRUE GRASSES.

1. **General characters of the Order.**—Herbs. Roots fibrous, chiefly adventitious. Stems cylindrical, hollow, with solid nodes. Leaves alternate with split leaf-sheath and ligule.

Inflorescence a spikelet, bearing chaffy bracts or glumes, which hide the flowers. Flower small, bisexual, hypogynous. Perianth missing, or consisting of two scales (lodicules). Androecium of three stamens with versatile anthers. Gynæcium a single carpel, with two feathery or brush-like stigmas; ovary with one seed. Fruit a caryopsis.

2. This is one of the most valuable and extensive Orders of plants, and comprises between 3000 and 4000 species. To it belong the cereals which supply the chief part of the food of the human race, and also the meadow and pasture grasses so important as food for the stock of the farm.

The general character of the roots, stems, leaves, and flowers of grasses are here dealt with, while in the subsequent chapters the cereals and those grasses of which it is essential that the agriculturist should possess a good knowledge are treated in greater detail.

ROOT.—The roots which emerge from the seeds of grasses on germination are few in number and short-lived, but an extensive system of adventitious, thin, fibrous roots develops later from all the underground nodes of the stems.

STEM.—The stems, which are termed *culms*, are cylindrical and usually hollow when full-grown, except at the nodes, where

they are solid: maize is exceptional in having stems solid throughout.

Branches arise only in the axils of the lowermost leaves. 'Tillering' is the term employed to designate this form of branching in grasses, and its nature is discussed on pages 482-485.

Generally the buds break through the base of the enclosing leaf-sheaths; the branches produced are designated *extravaginal* branches and grow more or less horizontally for a time, often underground, forming longer or shorter rhizomes, from which leaves and flowering stems are sent up. Grasses behaving in this manner soon cover considerable areas of the ground with a close turf. Couch-grass, smoothed-stalked meadow-grass, and florin are good examples.

Less frequently the branches are *intravaginal*, that is, they grow up between the leaf-sheath and the stem, emerging near the ligule, but ultimately, tearing the subtending leaf, as in 1, Fig. 153. Branching of this character leads to the formation of compact tufts, and grasses exhibiting this manner of growth are unable to cover the ground except in isolated patches. The cereals (see pp. 482 to 485), annual brome-grasses, meadow and sheep fescues, rye-grasses, and cocksfoot are examples.

The perennial rhizomes of grasses are usually sympodia (2, Fig. 22).

LEAF.—The leaf of a grass consists of two parts, the blade and the sheath. The *leaf-sheath* surrounds the stem like a tube split down one side, its free edges overlapping in some instances (g, Fig. 149). In cocksfoot, dodder-grass, and some of the meadow-grasses it is not split but forms a completely closed tube. It acts as a support for the stems while they are young and soft, and protects the tender growing points within from the injurious effects of frost and heat. Most grasses appear swollen at the nodes (d, Fig. 149); this is not usually due to thickening of the stem, but to the presence of a mass of soft tissue at the base of the leaf-sheath.

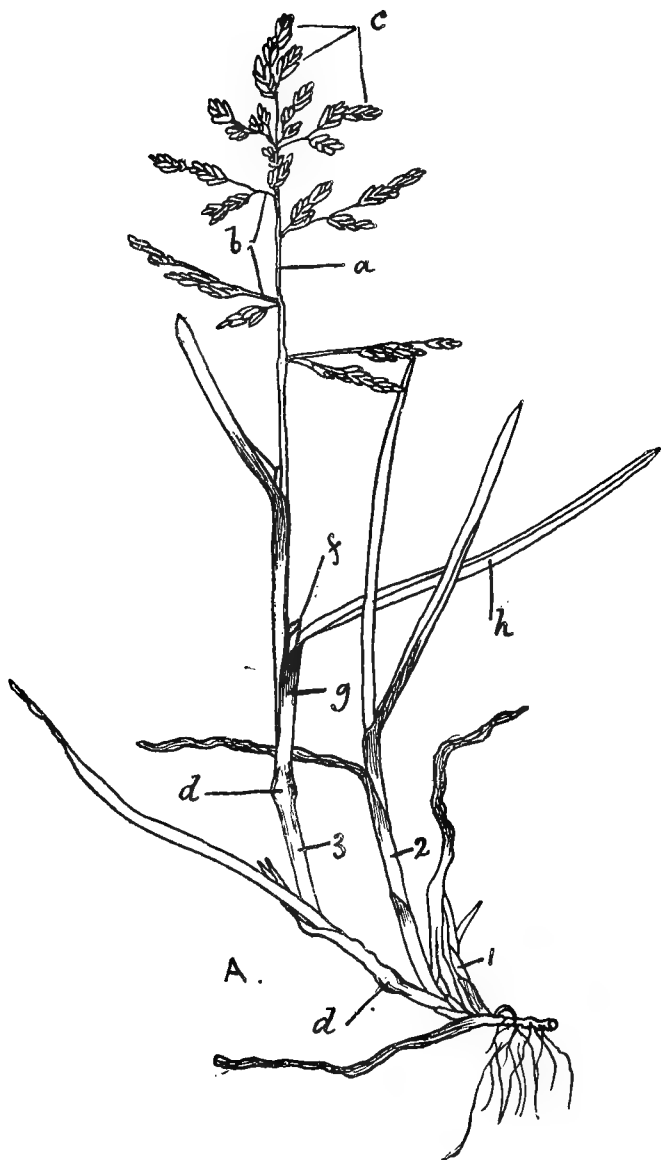

FIG. 149.—Annual meadow-grass. *d* Nodes; *g* leaf-sheath; *h* leaf-blade; *f* ligule; shoot 3 terminates in an inflorescence (an *open panicle*), of which *a* is the rachis; *b* branches of rachis; *c* spikelets.

The *leaf-blade* is generally long, narrow, and flat, but in grasses growing in dry places it is often folded and appears almost cylindrical (Fig. 183).

The first leaf of the embryo and those upon the underground rhizomes are almost always modified structures representing leaf-sheaths the blades of which remain undeveloped or rudimentary.

It is important to notice the arrangement of the leaves in the bud as it often affords a ready means of distinguishing nearly-allied species of grasses. Most frequently the leaves are rolled up from one side in a spiral form, and the young shoot appears round (Fig. 191), but in several grasses they are simply folded down the middle, the shoot then appearing flattened (Fig. 188).

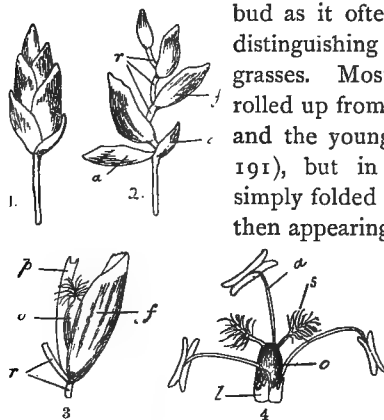

Fig. 150.—1. Spikelet from grass of Fig. 149.
2. The same slightly opened to show separate glumes and florets. *a* Empty glume; *f* flowering glume of second floret; *r* rachilla or axis of spikelet.
3. Single floret of 2. *f* Flowering glume; *p* palea; *o* ovary of gynæcium; *r* piece of rachilla.
4. The flower. *l* Lodicules; *o* ovary; *s* stigma; *a* stamen.

in claw-like projections which partially or entirely encircle the stem as in Figs. 154 and 189.

INFLORESCENCE.—In the figure of annual meadow-grass (Fig. 149), the branched upper part popularly termed the ‘flower’ is a complex inflorescence bearing flowers which are very small and completely hidden from view. The parts *c* are termed *spikelets*, and it is within these that the flowers are enclosed.

A single spikelet is illustrated in Fig. 150. On examination it is seen to consist of an axis *r*, the *rachilla*, upon which is

At the point where the blade joins the sheath the inside of the latter often protrudes as a tongue-like membranous structure (*f*, Fig. 149), termed the *ligule*.

The latter varies much in length in different species. Near the ligule the sides of the leaf sometimes terminate

arranged a series of sessile bracts in two alternate rows. These bracts are termed *glumes*, and in the axils of all except the two lowermost ones (*a a*) flowers are produced which on account of their small size are not seen. The glumes *a a* are termed the *empty glumes* of the spikelet, the others similar to *f* are the *flowering glumes*. Attached to the very minute stalk which each flower possesses is another bract, named the *pale* or *palea* seen at *p*. It lies opposite to the flowering glume, and between it and the latter the flower is enclosed more or less completely.

The empty glumes are usually two in number, but there is only one in rye-grass, and the spikelet of sweet vernal-grass possesses four. Sometimes they are small and narrow as in rye, or they may be large and completely enfold the rest of the spikelet as in oats.

The flowering glumes often differ from the empty ones in having 'beards' or bristle-shaped structures termed *awns*. In barley and 'bearded' wheats the awns are of great length, while in some instances they are merely short points at the tip of the glume.

Awns are said to be *terminal*, *dorsal*, or *basal* according to whether they arise from the tip, middle of the back, or the base of the glume.

The number of flowers in each spikelet varies considerably: in some species, as timothy grass and florin, only one is present, in Yorkshire fog two, while in meadow-grasses, fescues, and rye-grasses there are several.

All our grasses resemble each other in having their flowers in spikelets, the latter, however, do not constitute the whole inflorescence but are only parts of it. In wheat, rye-grass, and barley the spikelets are sessile upon opposite sides of a straight unbranched main axis, the *rachis*, the total inflorescence being termed a *spike*; in reality it is a spike of spikelets.

In the majority of grasses the rachis is much-branched and

the spikelets are borne at the ends of the branches as in Fig. 149. Such an inflorescence is termed a *panicle*.

When the branches of the panicle are long and the spikelets consequently separated from each other, the panicle is described as *spreading, open, or diffuse* (Figs. 174, 181, &c.).

When the branches of the panicle are very short, so that the spikelets lie close to the main axis as in foxtail and timothy grass (Figs. 172 and 173), a *false spike* or *spike-like panicle* is formed.

THE FLOWER.—As pointed out previously the glumes are bracts of the inflorescence and do not, of course, constitute a part of the flower. The latter (4, Fig. 150) consists of an andrœcium of three hypogynous stamens and a gynœcium of one carpel. At the base of the ovary on the side opposite to the pale, that is, on the side next to the flowering glume, there are two small transparent scales, the *lodicules, l*; they are usually considered rudiments of the perianth, but may possibly represent a second palea.

The filaments of the stamens are long and slender and attached to near the middle of the anthers; the latter are readily moved by the slightest breeze.

In sweet vernal-grass two stamens only are present.

The gynœcium consists of a single carpel with an ovary most frequently surmounted by two brush-like styles (*s*).

The grasses are cross-fertilised, though self-fertilisation is also frequent. At the time of flowering the base of the lodicules generally swell up and force the pale and flowering glume apart; the filaments of the stamens grow rapidly about the same time and push the anther out at the sides of the glumes; the pollen is then distributed by the wind and caught by the feathery stigmas.

In a short time (often not more than an hour or two) the lodicules lose their turgidity and shrivel, and the pale and flowering glume close up again shutting the ovary and stigmas from view.

THE FRUIT AND SEED.—The fruit of grasses is in most cases a *caryopsis* or a one-seeded form of nut, the seed of which has grown completely into union with its surrounding thin pericarp. The wheat grain discussed on p. 22 may be taken as typical of a *caryopsis* and its enclosed seed.

In young flowers the ovaries of the grasses are quite free from the glumes and may remain so even when the fruit is ripe as in the case of wheat, rye and oats; sometimes, however, during growth after fertilisation the *caryopsis* grows up to between the glumes and becomes united with the latter as in the case of ordinary barley.

In oats and many grasses the glumes so closely invest the *caryopsis* that the latter does not fall out from the glumes when the ripe panicles are shaken or thrashed; nevertheless, in these cases the *caryopsis* is free and easily separable from the glumes, which is not the case in barley and many other grasses.

The seed contains a large proportion of starchy endosperm, at the side of which the embryo is placed. In some grass seeds, and particularly those of certain varieties of cereal grains, such as Hard wheats, the endosperm is *flinty*, or hard and semi-transparent, while in others the endosperm, which is described as *mealy*, is opaque and chalky when cut across.

The different appearance of flinty and mealy endosperm is due to the fact that in the first the starch grains within the cells are embedded in a dense matrix of proteid material, while in the mealy endosperm the cells are not completely filled with reserve materials, but very minute air spaces exist between the starch-grains within the cells.

The embryo (Figs. 7 and 151) possesses one cotyledon (the scutellum), a short plumule, and in most cases a single primary root covered by the coleorrhiza. In the cereals and some other grasses secondary roots appear upon the very short hypocotyl of the embryo while the latter is still within the *caryopsis* and they make their exit at the same time as the primary root, when

germination commences; in most grasses, however, secondary roots first appear some time after the single primary root has grown out from the caryopsis.

Ex. 247.—Examine the roots of any grass. Observe as far as possible their origin, and note if they branch extensively.

Ex. 248.—Cut transverse and longitudinal sections of any well-developed grass stem at and between the nodes. Note if hollow or solid all through.

Examine the leaves of barley and oats and many common grasses. Note the split leaf-sheath, the flat or rolled blade, and the character of the ligule if present.

Ex. 249.—Make an examination of the inflorescences of a number of common grasses in order to understand the various parts, viz., the rachis, and the spikelet with its rachilla and bracts. Which are the empty glumes, flowering glumes, and palea in each spikelet?

Ex. 250.—Dissect out the flowers from any common grasses, noting the form and position of the stigma, the number of stamens, and the position, number and form of the lodicules in each.

Ex. 251.—Watch the unfolding of the total inflorescences of Yorkshire Fog, Tall Oat-Grass, and other grasses with panicles. What positions do the branches take before and after flowering?

Ex. 252.—Cut transverse sections of several grains of barley, oats, wheat, rye and maize. Note the ‘mealiness’ or ‘flintiness’ of the endosperm in each.

CHAPTER XXXV.

GRAMINEÆ (*continued*). **CEREALS.**

IN Europe perhaps the most familiar crops of the farm are wheat, barley, rye, and oats.

These crops, designated **Cereals**, are grown mainly for their fruits or grains which form the most important food of mankind and are also of great value as food for the stock of the farm.

Besides being utilised as bread-corn large quantities of the cereal grains are employed in the manufacture of starch, beer, whisky, gin, and other spirits.

Moreover, the cereals are frequently grown for green fodder and the straw in a ripe state is fed to stock, made use of as litter, or employed for thatching, and many similarly useful purposes.

The common cereals of the tropics are rice, maize, millet, and sorghum or dourra, but these, with the exception of maize, which is occasionally employed in a green state as horse and cattle fodder or made into silage, have no practical interest for the farmer of this country.

The cereals are grasses and therefore possess general characters described in the last chapter; they are, however, of such importance that further treatment of their peculiarities is needed.

FRUIT AND GERMINATION OF SEED.—(a) An account of the fruit and the germination of the embryo of wheat has previously been given (chap. ii.); the grain of rye is similar to this in almost all respects, but the roots of its embryo are generally four in number instead of three as in wheat.

(b) In barley the caryopsis or fruit is firmly united with the enclosing flowering glume and pale, and the plumule of the

embryo does not make its exit where the coleorhiza and roots emerge but grows on beneath the glume, and ultimately appears at the opposite end of the grain sometime after the roots have come forth (Fig. 151).

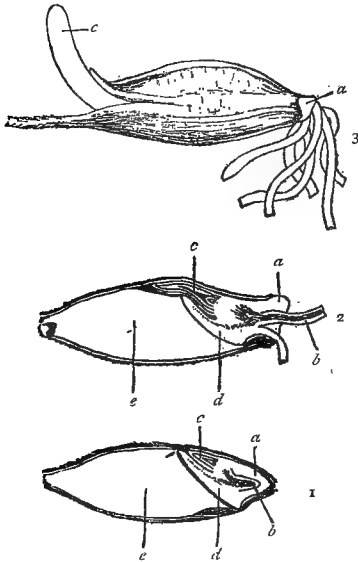

FIG. 151.—Barley grain showing embryo and its development during germination.

1. Longitudinal section of grain showing embryo at rest.

2. The same after germination has begun; the roots have made their exit from the grain, but the plumule *c* is still within it enclosed by the flowering glume.

3. Later stage of the germinated grain showing the plumule *c* outside the grain.

e Endosperm; *a* coleorhiza; *b* root; *c* plumule; *d* scutellum.

The number of roots visible on the embryo within the barley grain is generally five or six.

(*c*) In the oat the caryopsis is free from the glumes, but the latter more or less tightly surround it and on germination the plumule of the embryo behaves as in barley, and emerges from the grain at the end opposite to that at which the roots appear; the number of roots of the embryo is three.

ROOTS.—In the cereals, as in all grasses, the roots of the embryo within the seed grow out when germination commences: these may be termed '*seminal*' roots. They are of importance in the early life of the young plant, but subsequently die off and their work is undertaken by the so-called '*coronal*' roots which arise from the lower nodes of the stems as explained below (see Figs. 152 to 154).

'TILLERING.'—*A*, Fig. 152 gives the appearance of a young barley plant after a single green leaf has appeared above ground. At this stage it possesses a small bunch of roots which have come

from those which were easily seen in the embryo within the seed.

Soon afterwards more leaves show themselves, as at *B*, Fig. 152, and often about the same time the terminal bud, which was

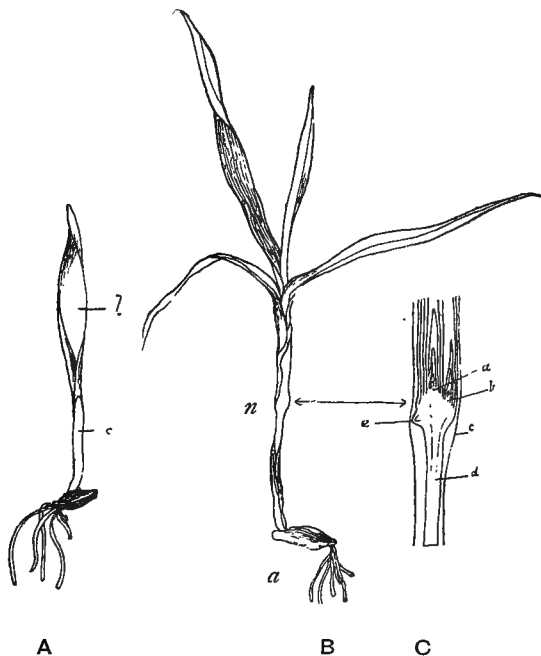

FIG. 152.—*A*, Young barley plant, showing 'seminal' roots. *c* First sheathing leaf; *l* blade of first green leaf.

B, Young barley plant, a later stage of *A*. *a* 'Seminal' roots; *n* first node of stem.

C, Longitudinal section of *B* at *n*. *c* Sheathing leaf; *d* stem; *a* terminal bud; *b* lateral bud (first 'tiller'); *e* adventitious root forming.

originally within the grain, is carried up to near the surface of the ground by the growth of the first internode, the second and succeeding internodes remaining undeveloped for some time. When the primary bud has reached this position rapid formation of lateral buds takes place in the axils of its leaves.

A longitudinal section of a portion of a plant in this early stage is seen at *C*, Fig. 152, where *a* is the terminal bud, and *b* a lateral bud just forming. In Fig. 153 a similar plant is shown in a further stage of development; the leaves of bud *b* have now come above ground.

A shoot may arise in this manner in the axil of each of the lower leaves on the primary stem, the internodes of the latter

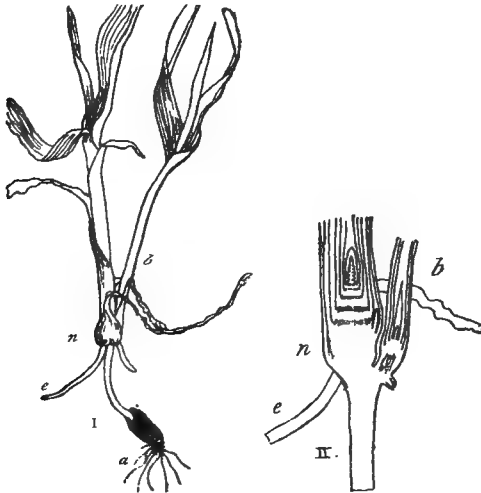

FIG. 153.—I. Young barley plant, a later stage of *B*, Fig. 152. The leaves from bud *b* in latter figure have now grown out and burst the enclosing leaf-sheath.

II. Longitudinal section of I. at first node *n*, showing the short stem within terminated by a minute ear. Besides the bud *b* a rudimentary one is seen in the axil of the lower leaf of the main stem. *e* Adventitious root; *n* first node.

remaining very short all the time (II., Fig. 153). The secondary stems may also develop in a similar fashion. It is thus seen that from a single grain the production of a large number of shoots is possible, and these breaking their way out from the enclosing leaf-sheaths appear finally as a tuft of stems, each of which may subsequently develop an ear of corn.

This formation of many shoots which spring from near the

surface of the soil is termed '*tillering*,' and is a common mode of branching met with in all the cereals, and in grasses generally.

No matter at what depth the seed is placed branching only takes place at the nodes near the surface of the ground. If placed deeply the first internode or two (*d*, *C*, Fig. 152, and *a*, Fig. 154) elongate considerably, and are noticed as a tough, wiry piece of stem when the plants are pulled up; in shallow sowing the internodes are short and scarcely visible.

The number of ear-bearing shoots produced from a single grain may, under some circumstances, be 100 or more; usually it is not more than five or six. Varieties of cereals grown largely for straw should tiller considerably; for production of grain of good quality two or three stems from each is sufficient. The ears of much-tillered plants ripen unevenly as the stems are necessarily not all of the same age, and those produced last are smaller and weaker than the primary stem and its first two or three branches.

The amount of '*tillering*' depends upon both internal and external causes. Some species of grass '*tiller*' more than others—wheat and barley, for example, more than oats; varieties of the same cereal also differ considerably in this respect.

Plants exposed to plenty of light '*tiller*' more extensively than those grown in shade. Thin-sowing promotes it by allowing more light to reach each plant. Moreover, in thin-sown crops more food-constituents are at disposal in the ground for each plant than when crowded together, and the plants '*tiller*' more in consequence.

On poor soils fewer stems arise from a single plant than on good soils, and early sowing gives more time for the formation and development of shoots, winter-sown wheat '*tillering*' more than that drilled in spring.

'SHOOTING' OF THE CORN.—The branches for some time after they are produced in the '*tillering*' process remain with undeveloped internodes; and it is only the blades of the leaves upon

each shoot that are seen above ground in spring, the actual stems being extremely short and quite close to the ground. A longitudinal section of the lower portion of the young plant at II., Fig. 153 shows the disposition of its parts.

It is seen that even in this stage the main stem is surmounted by a visible ear, and it will be readily understood that grazing the crop by running sheep over it, or mowing off the leaves in spring, does not injure either the stem or the ear, as the latter are placed so low down and are protected by the enveloping leaf-sheaths.

In the middle of June or thereabout the rapid extension of the internodes takes place and the corn is then said to *shoot*. The ear and lowest internode in the bud begin to grow first; the rest of the stem then develops in orderly succession from below upwards and forces the ear out of the uppermost leaf-sheath.

Germination, 'tillering,' and 'shooting' of spring-sown crops proceed more or less continuously without any distinct cessation of growth, but autumn-sown cereals grow little in winter.

'LODGING' OR 'LAYING' OF CROP.—It is noticed that after 'shooting' into ear

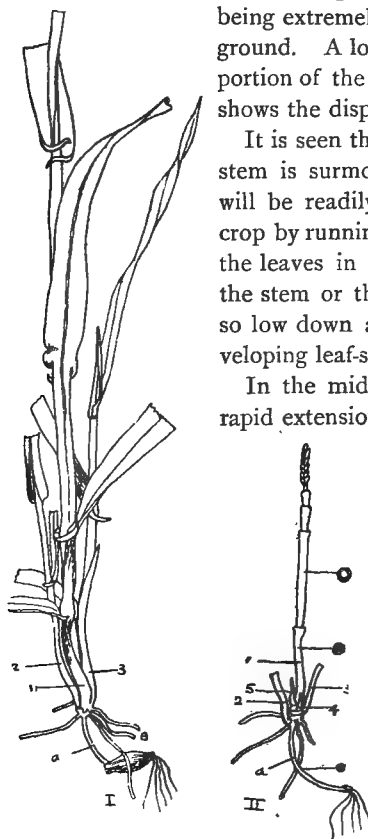

FIG. 154.—I. Barley plant 6 inches high, just commencing to 'shoot.' *a* Rhizomatous stem; 1, primary stem; 2 and 3, 'tillers'—lateral branches; 3 seminal roots; *a* adventitious roots.

II. Same barley plant with leaves removed to show primary stem and five branches—'tillers'—springing from its lower nodes; the primary stem has begun to 'shoot,' *i.e.* its nodes are lengthening rapidly; a small ear is visible at its tip.

corn crops very frequently become 'laid' or 'lodged.' The straw is weak and it is found that the second and third internodes near the ground are longer than usual and the cells beneath the epidermis and round the vascular bundles, upon which the stems depend for mechanical support, are longer and have thinner walls than those of straw which is not laid.

The weakness is not caused by a deficiency in the amount of silica in the cell walls as was formerly imagined, but is due to an inadequate supply of light to the young plants, the lower parts being etiolated by overcrowding.

Nitrogenous manures tend to the production of much leaf surface in all plants, and when used in excess on corn crops the plants shade each other and are liable to become laid in consequence.

Heavy rain and wind increase the evil, but the weakness may be such that the weight of the upper part of the straw is sufficient to make it fall without the aid of wind or rain.

It might be imagined that well-tillered crops, where many stems arise from each plant, would be specially subject to 'lodging.' This is, however, not usually the case; the 'tillering' process is dependent upon light, and the fact of its having gone on extensively is evidence that each plant has had an adequate exposure to light; shaded plants 'tiller' very little.

Thick-sowing or drilling in too close rows promote 'lodging,' for *from the first*—soon after germination—the plants shade each other.

FLOWERING AND FERTILISATION.—Most cereals open their flowers in the morning from four to seven o'clock and only when the temperature rises to about 75° F. At the time of flowering the flowering glume and pale are forced apart by the increased turgidity of the lodicules, and the anthers are pushed out by the rapid growth of the filaments of the stamens. At the same time much of the pollen is shed into the air, but in almost all cereals some of it falls on the feathery stigmas of the same flower, and

self-pollination results. In wheat, barley and oats self-pollination is followed by fertilisation and the production of fertile seeds, whereas in rye self-pollinated flowers are almost always sterile and considerable decrease of yield results to the crop when damp, dull weather prevails for a long time and prevents the proper opening of the flowers and distribution of the pollen.

In wheat the first flowers to open are those situated about one-third of the way from the apex of the ear, the rest follow in succession upwards and downwards from this point. Each flower remains open from a half to one hour, and the whole ear completes its flowering usually in eight or nine days.

In barley the complete period of flowering of the ear is shorter, and when the flowers open they remain expanded a longer time than those of wheat. Frequently, however, the flowers of barley never open at all and self-fertilisation is the rule. In fact all the cereals, except rye, are generally self-fertilised, although natural crosses among wheats and among oats have been observed occasionally. Hybrids between rye and wheat have been produced.

RIPENING.—A few hours after pollination the pollen-tube reaches the ovule, and fertilisation of the ovum is effected. The latter then gradually becomes an embryo and in the embryo-sac around it the formation of endosperm-tissue takes place.

Within the endosperm-tissue there is also a gradual accumulation and storage of proteids and carbohydrates.

Some of the proteids are laid down in the outermost layer of cells of the endosperm in the form of aleuron-grains, and it is important to note that the filling of the aleuron-layer of cells takes place before the central portions of the endosperm are completed. In the small and rapidly-ripened grains of cereals the percentage of proteids in comparison with the carbohydrate starch is therefore higher than in slowly-matured plump grains in which time has allowed of the extended accumulation of starch after the aleuron-layer has been laid down.

In barley for malting purposes, where the proportion of nitrogenous compounds should be as low as possible, it is essential that the crop should have time to accumulate carbohydrates in the grain in large amount or its value for malting is much reduced.

While the ear and grains are ripening, changes are going on in the roots, stem and leaves. There is a general movement of water from below upwards and at the same time a translation of useful plastic materials (sugars, amides and proteids) from the lower leaves and stem to the upper parts of the plant, these materials being finally utilised in the formation of the embryo and its store of starch and other reserve-foods in the neighbouring endosperm-tissue within the grain.

Death also takes place, gradually from below upwards, the roots dying off some time before the grains are ripe.

Although the ripening changes go on continuously it is useful to notice four stages, known respectively as (1) the *milk-ripe*, (2) the *yellow-ripe*, (3) *ripe*, and (4) the *dead-ripe* stages.

In the *milk-ripe* stage the endosperm tissue contains much water and when the grain is squeezed a white milky juice oozes out consisting of the watery cell-sap and numbers of starch grains. Although the lowermost leaves are dead the leaf-sheaths and the blade of the uppermost leaf are still green; the glumes are also green, so that the whole crop wears a green unripe tint.

In the *yellow-ripe* stage, on cutting across or breaking the grain, the endosperm is found to be somewhat tough and kneads like wax. The pericarp of the grain has lost its green colour and the straw has assumed a yellow tint, except at the upper nodes of the stem where the cells are still soft and sappy and contain green chloroplastids.

In the *ripe* stage, which in hot weather occurs three or four days after yellow ripeness, the straw is usually of lighter tint, and the nodes which die last are now dead, shrunken, and brown. The grain is harder and firmer.

If left longer the crop becomes *dead-ripe*, in which state the grain is brittle when cut across or broken, and the straw loses much of its brightness; if left on the field the straw also is liable to become greyish and dirty in appearance, and often so brittle that in certain varieties of cereals the ears may drop off whole, and much of the grain be lost in handling the crop.

For most cereals it appears to be best to cut the crop in the yellow-ripe stage when no trace of chlorophyll can be detected in any part of the pericarp of grains selected at random in several parts of the field.

Ex. 253.—Germinate grains of all the cereals on damp blotting-paper and carefully note the number of roots which make their appearance from the different kinds. Observe the way in which the plumule makes its exit from the grain. Extract the embryos complete and note the shape of the scutellum in each.

Does a *naked* caryopsis of oat or barley germinate similarly to that of wheat?

Ex. 254.—Carefully dig up young plants of any of the cereals and note the position and number of the ‘coronal’ and ‘seminal’ roots.

Ex. 255.—Make longitudinal sections of young ‘untillered’ plants and ‘tillered’ ones in early spring or winter. Examine with a lens or microscope and observe the number of axillary buds.

Ex. 256.—Make similar sections when the stems are 6 or 8 inches high, and note the presence and position of the young inflorescences or ‘ears’ within.

Ex. 257.—Examine an ear of wheat, barley, and oats just after it appears from the uppermost leaf-sheath. Note the character of the flowers. Make examination at intervals later in order to watch the growth of the caryopsis between the glumes. Which grains of the ear develop most rapidly?

Ex. 258.—Cut across grains at various intervals and observe the different changes which come over the grain and its contents during ripening.

Note the order of disappearance of greenness from the stems, nodes, leaf-sheaths, and leaf-blades. Endeavour to observe the (1) milk-ripe, (2) yellow-ripe, (3) ripe, and (4) dead-ripe stages, and how they pass one into the other.

CHAPTER XXXVI.

CULTIVATED AND WILD OATS (Genus *Avena*).

1. **Characters of the Genus.**—The inflorescences or 'ears' of oats are panicles, the branches of which in some races spread out widely, while in others the branches are more or less closely pressed to one side of the main axis.

The spikelets contain from two to six flowers; the empty glumes are membranous, unequal, many-nerved, and generally longer than the spikelet (Fig. 156). The flowering glume terminates in two more or less distinct projecting points, and is thick and firm with a bent, twisted dorsal awn; the awn of the flowering glume is missing from some of the finest cultivated oats. The empty glumes are always pale yellow or straw colour; but the flowering glumes may be white, yellow, dun, brown or black.



FIG. 155.—Spikelet of Wild Oat (*Avena fatua* L.).

The caryopses are spindle-shaped, furrowed on one side, free, hairy on the tip and sides, and firmly clasped by the flowering glume and pale, except in the naked oat, the fruit of which readily falls out from between the glumes when shaken or thrashed.

The following are the chief species and varieties met with on the farm:—

2. **Wild Oat** (*Avena fatua* L.).—A common weed with long

slender stems and large open spreading panicle. The spikelets generally contain three flowers, the flowering glumes of which bear a strong bent awn. The rachilla and base of the flowering glume are covered with long reddish-brown hairs (Fig. 155).

3. **Bristle-pointed Oat** (*Avena strigosa* Schreb.).—An annual weed often confused with the previous species, from which it differs in having one-sided panicles and fewer branches. The flowering glumes are, moreover, more deeply divided at the apex and the two segments prolonged into short bristles or awn-like projections; the rachilla and base of the flowering glume are smooth.

This species was formerly cultivated on poor exposed land in the northern parts of Scotland as a bread-corn, but is now most frequently seen as a weed among the superior cereals.

It is also sometimes cultivated as green fodder for cattle.

4. **Animated or Fly Oat** (*Avena sterilis* L.).—A species grown in gardens as a curiosity. The panicle is spreading and the 'grain' very much resembles that of the wild oat, except that it is much larger and has longer reddish-brown hairs on the flowering glume and rachilla. When the dry, strong twisted awn absorbs moisture it untwists and gives a creeping motion to the grain.

5. **Short Oat** (*Avena brevis* Roth.).—A species of oat with thin grass-like stems and bulky crop of leaves, sometimes grown for green fodder for cattle or to be made into hay.

The panicle is one-sided and the spikelets contain one or two flowers with awned flowering glumes. The 'oats' are plump, brownish and about a quarter of an inch long, with similarly short flowering glumes which are awned.

6. **Common Cultivated Oat**.—This cereal in the northern countries of Europe is an important bread-corn, but in the warmer and drier parts the grain is chiefly used as food for stock, especially horses. It is also grown as an early spring green crop.

The origin of the cultivated oats is unknown and none of the forms have been met with in a truly wild state.

Two races are recognised which are sometimes treated as distinct species, viz. :—

RACE I. **Common Oat** (*Avena sativa* L.) with open spreading panicles (Fig. 157), and

RACE II. **Tartarian Oats** (*Avena orientalis* Schreb.) with contracted one-sided panicles (Fig. 158).

The spikelets usually contain two or three flowers, the upper one of which is liable to produce either a small grain or none at all. The flowering glume of the lowest flower frequently bears a straight awn (Fig. 156) which when strong is a sign of degeneration of the stock or an evidence of the coarseness of the variety.

There is considerable diversity among the different varieties of cultivated oats in (1) the colour and thickness of the husk or flowering glume; (2) the form of the grain; (3) the period of ripening; (4) the length of the straw, and (5) the tendency to shed the grain when ripe.

For meal the grain should be somewhat short and plump, with a thin, clean white husk: the varieties with long grains are best adapted for feeding stock, and the colour of the husk is of little importance. In some districts black oats are preferred apparently with no sufficient reason, except that in such localities the black varieties are the most productive and the most familiar.

The early varieties give a larger yield of grain, but less straw than the late varieties. These oats, which are easily shed when ripe, have thin husks as a rule and are of better quality for the manufacture of oatmeal.

Late varieties possess longer grains, more adapted for feeding stock, with thickish husk and a comparatively small proportion

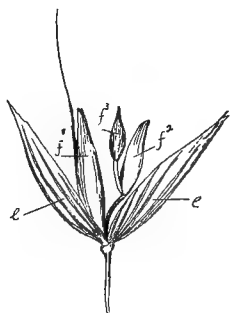

FIG. 156.—Spikelet of common cultivated oat containing three flowers. *e* Empty glumes; *f*¹, *f*², *f*³ three flowers.

of 'kernel.' They produce, however, a larger bulk of superior straw, are hardier and more suited to inferior soils than the finer early varieties. On good soils too much straw is produced and the crop is liable to become 'laid.'

RACE I. **Common Oat** (*Avena sativa* L.). .

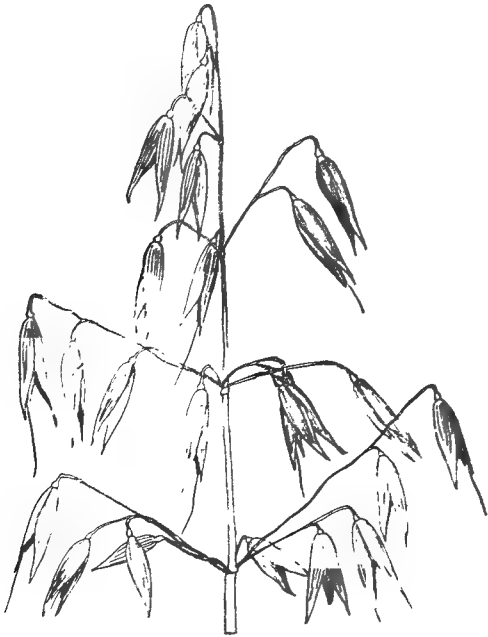

FIG. 157.—Panicle of Common Oat (*Avena sativa* L.).

The following are a few of the commoner varieties of this race usually met with in this country.

(i.) **Potato Oat.**—An early and prolific variety with a somewhat compact ear and pale yellow straw of medium length. The grain is white, short and plump, and of excellent quality for millers; its flowering glumes rarely bear awns unless the stock is degenerating.

It is liable to shed its seeds when too ripe, and is best suited to good soils in a favourable climate.

Early Hamilton appears to be an improved earlier form of the potato oat with superior straw and said to be more productive.

(ii.) **Sandy Oat.**—A tall, stiff-strawed early oat with small grain, the colour of which is white with a reddish tinge. It is inferior in quality of grain, but is much less liable to shed the latter in a gale than the potato oat. It is suited to all classes of soils.

(iii.) **Hopetoun.**—An early variety with a large spreading panicle and tall straw. The grain is large, and has a thickish husk of pale yellowish brown colour. It is a variety suited to moderately dry climates and light land.

(iv.) **Abundance.**—A white, late variety, much grown at the present time: the straw is tall and leaves broad with a bluish green hue. Grain white, plump and large, with a thick husk. It is very similar, if not the same, as Newmarket, Giant Eliza, and Ligowo oats.

(v.) **Winter Dun or Grey Oat.**—This variety is sown in the southern parts of this country in autumn, and fed off green with sheep in spring, after which it is sometimes left for seed.

Though not unfrequently killed by severe frost it may be considered hardy, and gives a fair yield of grain. The husk of the grain is dark at the base, brown in the middle, and pale brown at the tip, somewhat resembling that of a degenerate black oat.

Several varieties of common oat having longish thin grains, with reddish, bluish, and black husks respectively are met with; some of them are prolific but of poor quality, and scarcely deserving of cultivation even as food for stock.

RACE II. **Tartarian Oat** (*Avena orientalis* Schreb.) (Fig. 158).—The varieties belonging to this race have one-sided panicles, as explained previously, and spikelets, whose empty glumes are slightly longer than those of the common oat.

The grains are long, often of low bushel-weight, and wanting

in plumpness; the straw is stiff and reedy, and inferior in feeding value to that of the previous race.

Their productiveness, however, is superior to that of the common oats, and especially is this the case upon soils in warm climates unsuited to the growth of the latter race.

In the south of England, where as much straw and grain as possible is the object without much regard to quality, these varieties are very extensively cultivated.

Tartarian oats are adapted for cultivation on marshy and peaty soils, heavily dunged hop-gardens, and, in fact, on all soils in which a considerable amount of humus is present.

The following are two common varieties:—

(i.) **White Tartarian Oat.**—A late variety, with very tall stiff straw, and grain the husk of which is dull white with a long awn. It requires a good soil for satisfactory growth.

(ii.) **Black Tartarian Oat.**—One of the most extensively cultivated black oats, earlier and more liable to shed its grain than the white Tartarian oat. The straw is of medium length, the grain black with paler tips, and plumper than the white variety; the awns on the flowering glumes are not so stout as on the latter kind.

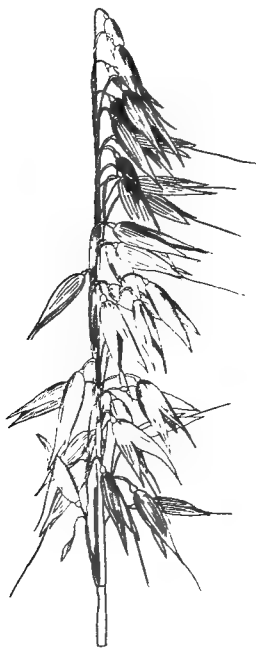

FIG. 158.—Panicle of Tartarian Oat (*Avena orientalis* Schreb.).

Both kinds of Tartarian oats are grown for horses, sheep, and stock generally, but the black variety sometimes yields good meal.

CLIMATE AND SOIL.—Oats require a cool, moist climate; the north and west of the British Isles therefore grow better samples

than the south and east. In a dry climate, unless the soil is retentive of water, the oat develops a long thin grain, and a thick husk, which often bears a strong awn; the branches of the panicles become dry and apparently hinder the translocation of materials necessary for the formation of a plump grain.

This cereal may, however, be grown upon almost all classes of soil.

SOWING.—With the exception of the winter dun oat and one or two similar varieties, oats are sown in spring. In the south of England they are generally drilled or broad-casted in January or February, while in the north the crop is sown in March and April.

When drilled 3 to 4 bushels of seed per acre are used, according to the size of the grain, the tillering power, and the locality. Up to 6 bushels per acre are broadcasted.

YIELD.—The yield of grain per acre varies from 40 to 80 bushels or more; the straw weighs from 25 to 40 cwts. per acre.

COMPOSITION.—Oats have more 'fibre' than any of the other cereals, reaching on an average 10 per cent. of the grain. The soluble carbohydrates average 57 per cent.; the fat-content is over 5 per cent., an amount much higher than any other cereal except maize. The albuminoids average about $11\frac{1}{2}$ per cent.

Ex. 259.—Examine the spikelets of any common oat. Note the number of flowers in each, the form and extent of the empty and flowering glumes, and the form of the naked caryopsis.

Which flowering glumes have awns?

Ex. 260.—Compare the inflorescences of Tartarian and Common Oats, and also the grains and flowering glumes of each.

Ex. 261.—Examine and compare the spikelet and grain of a wild oat with that of any of the cultivated forms.

CHAPTER XXXVII.

CULTIVATED BARLEYS (Genus *Hordeum*).

1. **Characters of the Genus.**—The inflorescences or ‘ears’ are spike-like and consist of many groups of three single-flowered spikelets (Fig. 159) arranged from top to bottom of an elongated rachis.

Each spikelet appears practically sessile on the rachis; but a triplet of single-flowered spikelets really represents a primary branch with two opposite lateral branches each bearing one flower. The rachilla on which the spikelet grows laterally is prolonged and appears as a small bristle-like structure, readily seen with a lens, lying within the ‘furrow’ of a barley grain as in Fig. 163.

The groups of spikelets are arranged alternately at notches on opposite sides of the rachis, so that the whole ear appears to have six longitudinal rows of flowers.

The empty glumes (*e*, Fig. 159) are very narrow and stand side by side in front of the flowering glume. The latter is broad and possesses a long awn which acts as a transpiring organ. The longest awns are usually attached to the largest

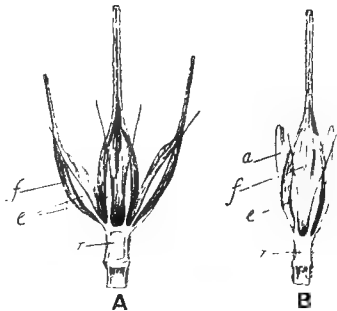

FIG. 159.—*A*, Piece of rachis of six-rowed barley showing a triplet of single-flowered spikelets. *r* Rachis of the ear; *e* empty glume; *f* flowering glume.

B, Piece of rachis of a two-rowed barley showing a triplet of single-flowered spikelets, the central flower fertile, the two lateral flowers (*a*) imperfect. *r* Rachis of the ear; *e* empty glume; *f* flowering glume; *a* imperfect (male) flower.

and best developed grains ; when the awn is cut off or destroyed the grain is long and thin when ripe. Usually the flowering glume is pale yellow, but in some varieties it is black or deep purple.

The fruit or caryopsis in the commoner varieties of cultivated barleys is adherent to the flowering glume and pale, and on being thrashed does not separate from the latter.

Varieties termed naked barleys, however, exist, in which the caryopsis is free from the glumes and falls out of the ear as readily or more so than a grain of wheat.

2. **Cultivated Barley** (*Hordeum sativum* Pers.).—The cultivated forms of barley are all considered to belong to one species, which has been named *Hordeum sativum* ; by the best authorities this is looked upon as having been originally derived from a two-rowed species *Hordeum spontaneum* Koch., which is met with wild in Western Asia.

The cultivated varieties fall into the three undermentioned races, which have sometimes been treated as distinct species :—

RACE I. **Six-rowed Barley** (*Hordeum sativum hexastichon* = *H. hexastichon* L.) (*A*, Fig. 160).—In the six-rowed barleys all the flowers of each triplet of spikelets on both sides of the rachis are fertile and produce ripe fruits, hence the ear possesses six longitudinal rows of grain : moreover, the rows are arranged at equal distances from each other all round the rachis.

This race has short erect ears, short straw, and coarse thin grain. It is hardy and gives a good yield, but is rarely met with, as the very poor quality of its grain debars it from being of any use to the farmer in this country.

RACE II. **Bere : Bigg : Four-rowed Barley** (*Hordeum sativum vulgare* = *Hordeum vulgare* L.) (*B*, Fig. 160).—In this race all the flowers of each triplet are fertile and the ear is possessed of six rows of grain as in the previous race ; the rows, however, are not arranged regularly at equal distances round the rachis. The central fruits of each triplet form two regular rows on opposite



FIG. 160.—A Six-rowed barley (*Hordeum sativum hexastichon* or *Hordeum hexastichon* L.).
B, Bere: four-rowed barley (*Hordeum sativum vulgare* or *Hordeum vulgare* L.).
C, Himalayan barley (*Hordeum Egiceras* Royle).

sides of the rachis, but the lateral spikelets of each triplet which in the six-rowed race form four straight single regular rows, in this race form two irregular double rows, hence the whole ear appears irregularly four-rowed, especially in its upper part.

Bere, of which there are one or two improved varieties, has erect ears about $2\frac{1}{2}$ inches long, and usually contains from forty to fifty grains in each. The grains are thinner and longer than those of the two-rowed race, and the awns are stiff and adhere so firmly to the flowering glume that they are difficult to remove when thrashed.

Bere is mostly grown in the northern parts of this country as a spring-sown crop, and used as food for stock and the production of whisky. Varieties of this and the six-rowed barleys are also sown in autumn to be fed off in spring as a green fodder crop.

On account of its rapid growth and power of giving a moderately good crop on poor soils, bere is the most suitable cereal for the northern parts of Europe where the summers are of short duration; in such localities it forms the chief bread-stuff.

Formerly this race of barley was used in the preparation of malt and beer, and to a slight extent this is still the case; the proteid-content of the grain is, however, frequently too high and the starch-content too low for the preparation of a good malt, and the two-rowed races on account of their superiority in these respects have now almost entirely superseded bere for malting purposes. Moreover, on good soil the yield of the two-rowed varieties is equal to, if not superior to, that of bere.

To this race belong **Naked Barley** (*Hordeum caeleste* L.) and **Himalayan Barley** (*Hordeum trifurcatum* Jacq. = *H. Aegiceras* Royle.) (C, Fig. 160). In both of these the caryopses are quite free from the glumes, and fall out as readily, or more so, than those of wheat. Himalayan barley is peculiar in having three-pronged awns which are shorter than the grain, and bend back in the form of small horns; it is sometimes termed Nepal wheat,

the brown free caryopses somewhat resembling rather large pointed wheat grains.

RACE III. **Two-rowed Barley** (*Hordeum sativum distichon* = *Hordeum distichon* L.) (Fig. 161).—In the two-rowed race only the middle spikelet of each triplet is fertile, the lateral spikelets being barren (male-flowered); the ear, therefore, possesses only two longitudinal rows of grain.

This race is the one most commonly grown in the British Isles and on the Continent, and comprises a considerable number of sub-races and varieties among which are the finest malting barleys. When not sufficiently good either in composition or colour to be used for malting, the grain is a valuable food for stock.

Several fairly distinct sub-races of Two-rowed Barley are met with of which the following are the chief:—

SUB-RACE I. **Peacock, Battledore, Sprat, or Fan Barley**, formerly described as a species, viz., *Hordeum Zeocriton* L. The straw is stiff and the ears erect and short, about $2\frac{1}{2}$ inches long, broad at the base and narrow at the tip (*A*, Fig. 161). Except the lower ones of the spike, the grains are thin and of poor quality, with long spreading awns. The whole ear has a fanciful resemblance to an outspread peacock's tail or fan, hence the name peacock, fan, and battledore barley applied to it. It is of little agricultural importance.

SUB-RACE II. **Broad Erect-eared Barleys** (*Hordeum distichon erectum*).—In this sub-race the ears are erect and broad, with plump grains closely packed on the rachis (*B*, Fig. 161). The straw is stiff, and on this account barleys belonging to this sub-race are useful for growing on somewhat heavily-manured soils where the danger of 'lodging' is great for the finer Chevalier variety.

The grain, although of excellent form and size, usually possesses a higher proteid-content than is suitable for the production of the best malt; nevertheless in exhibitions of malting-barley

varieties belonging to this division of the two-rowed race have not unfrequently taken very high places.

Examples of varieties belonging to this sub-race are, **Imperial**, **Webb's Beardless**, and **Goldthorpe**.

The ear of Webb's Beardless loses many of its awns when ripe.

SUB-RACE III. Narrow Bent-eared Barleys (*Hordeum distichon nutans*).—In these barleys the ripe ears bend over on one side and hang down so as to become almost parallel with the stem.

The ears are narrower and longer than those of the previous sub-race, the smaller width across the ear being due to the fact that the grains are placed farther apart on the rachis and jut out from the latter at a smaller angle than the grains on an erect-eared variety (C, Fig. 161).

To this sub-race belongs the **Chevalier** variety raised by the Rev. Dr Chevalier of Debenham, Suffolk, in 1819.

Chevalier barley and the various selections from it are superior to all others for malting purposes; they are, however, somewhat delicate and liable to lodge on highly-manured soils.

Many other varieties included among nodding-eared barleys are met with, all of which produce useful malting samples when carefully managed: common representatives are **Old Common**, **Nottingham long-ear**, and others with seedsmen's special names attached. The grains of these varieties are generally darker in colour than Chevalier barley and possess thicker glumes and pericarp.

3. **Distinguishing features of barley grains belonging to different races and sub-races.**—One of the essential conditions for the production of a good malting sample of barley is that the seed sown should be as far as possible of the same variety, so that the ripening of the crop and the composition of the grain should be uniform. As it is not difficult to distinguish the grains of the chief races and sub-races from each other, farmers should make a point of becoming acquainted with their peculiarities, especially

of those belonging to the erect-eared and bent-eared two-rowed barleys in order to be able to examine samples before purchasing for seed purposes.

The following are the chief points of difference of the common races of barley :—

(i) The grains of the six-rowed race are elongated, not plump, with thick glumes ; generally a considerable portion of the base of the awn is visible on the flowering glume.

The grains of bere are larger and plumper than those of the

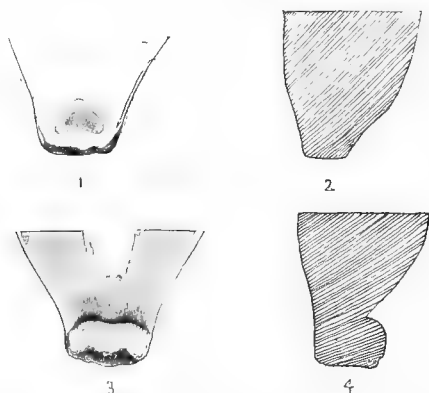

FIG. 162.— 1. Base of grain of *bent-eared* two-rowed barleys (Chevalier, Old Common, &c.). 2. Diagrammatic longitudinal section of 1 showing the sloping base. 3. Base of grain of *erect-eared* two-rowed barleys (Goldthorpe and Imperial). 4. Diagrammatic longitudinal section of 3.

typical six-rowed sub-race, but in other respects the two are similar.

In six-rowed barley and bere the two lateral grains of each triplet growing at a notch of the rachis are twisted, so that the two halves of each grain when viewed on the furrow-side are seen to be dissimilar in size and form ; the presence of these lop-sided grains in a sample is evidence of their origin.

The middle grains of each triplet are symmetrical on both

sides of the furrow line and very closely resemble the grains of the two-rowed races.

(ii) The broad erect-eared barleys, such as Goldthorpe, Imperial, Webb's Beardless, and Jewel, are easily recognised by the presence of a small deep *transverse* furrow across the base of the grain, below which is also a distinct rounded lump (4, Fig. 162).

The rachilla lying in the longitudinal furrow at the back of the grain is short and usually bears a number of long thin straight hairs (3, Fig. 163): in some varieties of this class, however, the rachilla is woolly, like 1, Fig. 163.

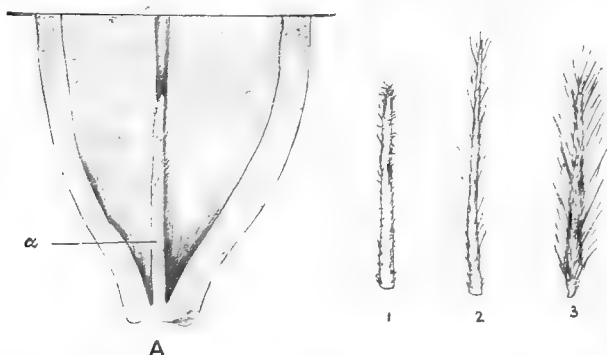

FIG. 163.—A, Base of barley grain showing the portion of the rachilla α . 1 and 2, Rachilla of narrow bent-eared barleys; 1 of Chevalier variety; 2 of Old Common, Nottingham long-eared, and many so-called 'Prolific' varieties. 3, Rachilla of most broad erect-eared barleys, e.g. Goldthorpe and Imperial varieties; some have rachilla like 1.

(iii) The narrow bent-eared barleys have neither transverse furrow nor lump at the base of the grain, but slope off as at 2, Fig. 162. Those belonging to the Chevalier stock have a rachilla which is covered with *short* wavy wool-like hairs (1, Fig. 163).

The rachilla of the Old Common, Nottingham long-ear, and so called 'Prolific' but inferior malting barleys is longer and the straight hairs shorter than on the rachilla of the erect-eared barleys (2, Fig. 163).

4. **Characters of a good malting barley.**—The following points are of importance in estimating the suitability of barleys for malting purposes; the features of greatest weight are only obtain-

able by chemical analysis, but some of the external and readily observable characters mentioned below frequently indicate the value of samples.

a. Composition.—In the malting process the starch of the grain is changed into soluble compounds—dextrin and maltose—which are extracted by means of water and ultimately fermented. The amount of starch should therefore be high in order to obtain a rich extract; the best samples contain from 62 to 64 per cent. of starch.

The proteid-content of barley varies from $6\frac{1}{2}$ to over 17 per cent.; it should be as low as possible, as it is found that barleys with a high percentage of proteids give turbid worts, and the keeping quality of the beer prepared from them is reduced.

In the best samples the proteids usually average not more than 9 per cent.: medium samples contain $10\frac{1}{2}$ or 11 per cent., while poor ones frequently contain 12 per cent.

The amount of water in the grain is important, as it is found that the drier barleys germinate more quickly and evenly than the damper samples. Moreover those with a high water-content sooner lose their germinating capacity and are more liable to be injured and overrun by saprophytic fungi (moulds) than drier ones. The amount of water present in the grain depends upon the ripeness when cut, the method of harvesting, subsequent sweating in the stack, and upon other conditions. Good samples contain an average of 14 per cent.

b. Germination Capacity and Germination Energy.—The quicker the germination the more even the malt and the better the yield of extract. In good samples 96 per cent. of the grains germinate in seventy-two hours when kept at a temperature of 18° to 20°C .; if the percentage is as low as 85 in this time the sample should be rejected.

c. Plumpness and Weight.—The grains should be short and thick and of uniform shape, and the sample should be free from broken grains or those with injured skins. The bushel-weight of

good barleys is 56 lbs.; samples exhibited in the Brewers' Exhibition usually vary from 53 to 60 lbs. One hundred grains should weigh between 4 and 5 grams; in the erect-eared barleys the latter weight is sometimes exceeded.

d. Mealiness.—When cut across the grains should show a snow-white surface, but rarely do we find samples perfect in this respect, most of them containing a larger or smaller number of flinty grains.

e. 'Skin.'—The proportion of 'skin' or husk (glumes and pericarp) to the rest of the grain is subject to much variation; in some cases the percentage of husk is as low as 8 per cent., while in others it is as high as 16. In thin-skinned samples the grains show a series of delicate transverse lines or puckers due to loss of water and slight shrinkage of the internal contents during ripening. Thick-skinned grains show no such lines.

f. Colour.—The sample should be pale yellow or a pale clean straw colour and uniform all over the grain. A stained or discoloured appearance is often associated with inferior and damaged samples; grains, therefore, with brown bases, or which are grey or of dark tint are to be avoided. The brown tips of the grains are frequently caused by dark coloured fungi, but occasionally it is the natural tint of the barley, and may in such cases be no indication of inferiority of sample.

Barleys exposed to heavy dews and rain are generally darker in colour than well-harvested crops.

g. Smell.—Samples which have been soaked with rain during stacking often give evidence of the injury by its musty smell.

h. Freedom from broken or cut grains.—Great care should be taken when thrashing malting-barley to have the machine properly set, so that the awns are not cut off too short nor the grains cut in two. Closely cut grains often have the embryo so damaged that the latter will not germinate, and cut grains are liable to become mouldy when damped and placed on the malting-floor.

SOIL AND CLIMATE.—The northern parts of the country are usually too wet for the production of mealy grains, but in the eastern and south-eastern counties of England the best malting barleys of the world are grown. In hot, dry continental climates the grain is usually 'thin' and flinty.

Barley grows most satisfactorily upon light soils; sandy and calcareous loams free from excess of nitrogenous manures are best.

SOWING.—'Seed' should be drilled as early as possible in February or March in order to give the plant plenty of time for 'assimilation' previous to the building up of a well-nourished grain.

In some favourable districts barley may be sown in January but the greater amount is sown in early March.

The amount drilled is from 2 to 3 bushels per acre, the larger quantity being used on thin soils.

YIELD.—The average yield is 32 bushels per acre; as much as 60 bushels are occasionally obtained.

COMPOSITION.—Barley grains contain on an average 14 per cent. of water, 66 per cent. of soluble carbohydrates, $10\frac{1}{2}$ per cent. of proteids, and 5 per cent. of 'fibre.'

Ex. 262.—Examine an ear of six-rowed, four-rowed, and two-rowed barley respectively.

Observe the arrangement of the spikelets on the rachis and the number and character of the flowers—whether unisexual or bisexual in each.

Ex. 263.—Observe at intervals the growth of the caryopsis between the glumes of a barley floret from the time just after the ear emerges from the leaf-sheath up to the time when the grain is ripe. Is the caryopsis always united with the glumes?

Ex. 264.—Cut off the awns from some ears of barley when very young and compare their growth with those of uninjured ears growing near them.

Ex. 265.—The student should examine and thoroughly master the details of the grains of different races and sub-races of barley.

Note the base of the grain, the rachilla, and also the lodicules of the flower which are easily dissected from soaked grains.

CHAPTER XXXVIII.

CULTIVATED RYE (Genus *Secale*).

1. **Characters of the Genus.**—The inflorescences or 'ears' are spike-like (Fig. 164), resembling those of wheat in general structure. The rachis bears two opposite rows of sessile spikelets.



FIG. 164. 'Ear' of Rye (*Secale cereale* L.).

A single spikelet is placed at each notch of the rachis, and consists of three flowers, two of which generally produce grain, the third being in most cases rudimentary.

The empty glumes are very narrow and the flowering glumes broad, keeled from the base, and terminated by a long awn; the keel of the glume is fringed with stiff hairs.

The caryopsis is free from the glumes, narrower and longer than a wheat grain, and usually of brownish-olive or greyish-brown tint.

2. **Cultivated Rye.**—Only one species, namely, **Common Rye** (*Secale cereale* L.), is cultivated. It appears to be of more recent origin than the other common cereals, and is considered to have arisen from *Secale montanum* Guss., a species met with wild in various elevated districts of southern and eastern Europe and western Asia.

The latter species differs from common rye in



FIG. 165.—Spikelet of Common Rye. e Empty glume; f flowering glume; r rachis of the 'ear.'

being perennial instead of annual, and in the possession of shorter ears and smaller grains.

On the continent, especially in Germany, Russia, Norway, Sweden, and Denmark, rye forms the principal bread-corn, the flour of which is made into black-bread. In this country its use as a bread-corn is very limited; it is, however, extensively grown as green fodder for sheep and cows, for use in early spring and summer, and is also cut green for 'soiling' horses in the stable.

When grown for corn the straw, which is longer than that of wheat, is practically useless for fodder, but on account of its stiff, tough character it is well adapted for thatching and litter.

No well-marked races of rye are met with, and the number of constant varieties is small. The latter are characterised only by differences in yield, tillering power, and hardiness, their morphological peculiarities being so slight that they furnish no certain means of distinguishing one variety from another.

The commonest and most useful varieties are those of hardy constitution, termed **Winter Ryes**; in contrast with these are a few **Summer Ryes**, which are earlier, less productive, and sown in spring.

One small-grained variety known as **St John's Day** or **Midsummer Rye**, possesses extraordinary tillering power, and appears to be somewhat more nearly allied to the wild species *Secale montanum* Guss., than the ordinary forms. It is usually sown at the end of June or beginning of July, and may be fed off with sheep or cut green in the autumn and following spring, after which, if left, it will frequently give a good yield of grain.

CLIMATE AND SOIL.—Rye is one of the hardiest of cereals, and is capable of withstanding the severe frost of a continental winter.

It grows well upon almost all light soils, but especially so upon such as are sandy; stiff clays and damp soils rich in humus are unsuited to its requirements.

SOWING.—For corn production the winter rye is drilled at the

rate of 2 to 3 bushels per acre, usually in September or October, as early as possible, as tillering goes on chiefly in autumn and not much in spring.

Summer rye is sown generally in March and April.

When sown for green spring food more seed is sown, usually from 3 to 4 bushels per acre.

YIELD.—The average yield is from 25 to 30 bushels of corn, and from 30 to 40 cwts. of straw per acre.

COMPOSITION.—Rye has practically the same composition as wheat.

Ex. 266.—Examine the various parts of an ear of rye, and compare them with those of an ear of wheat.

CHAPTER XXXIX.

CULTIVATED WHEATS (Genus *Triticum*).

1. **Characters of the Genus.**—The inflorescences or 'ears' are spike-like, with two rows of sessile spikelets placed singly at each notch of the rachis.

The spikelets (Fig. 166) possess from two to five flowers, one or more of the upper ones are always abortive; usually not more than two or three are fertile and produce ripe fruits.

The lower spikelets of the 'ear' are often sterile even in the best selected varieties.

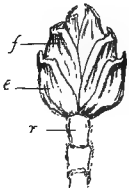

FIG. 166.—Spikelet of common Wheat. *e* Empty glume; *f* flowering glume; *r* rachis of the 'ear.'

The empty glumes (Fig. 166, *e*) are broad, thus differing from rye, and usually have but a short awn or blunt apex; the flowering glumes possess a long or short blunt awn.

The fruit (caryopsis), which is free from the glumes, has a deep furrow on the back and a hairy tip; the colour of the 'grain' may be white, yellow, red, brown, or violet.

2. **A good wheat grain** should be plump, with a smooth, thin, well-filled skin. For the purposes of the baker it should be somewhat translucent or semi-glassy when cut across: samples containing many translucent grains are known on the market as 'strong wheats.'

The grains in a sample should also be of uniform colour, size, and shape.

For sowing the germination capacity should not be less than 98 per cent. and the weight of 100 grains not less than 4 grams. The grains should have a hairy tip and the embryo at

its base should be prominently visible through the pericarp; if, on examination with a lens, the hairs at the tip appear few and much broken, the sample has most likely been subjected to rough treatment in order to give it an artificially bright appearance.

The pericarp of fresh good grain is bright; in old seed it is dull; the sample should have neither musty smell nor bad taste.

3. **Cultivated Wheats.**—With the exception, perhaps, of one-grained wheat, none of the true wheats have been met with in a wild state and their origin is unknown.

Whether the hundreds of forms in cultivation are the product of a single species or of several is also not certain.

Three species are, however, generally recognised by the leading authorities, namely:—

SPECIES I. **One-grained Wheat** (*Triticum monococcum* L.).

SPECIES II. **Polish Wheat** (*Triticum Polonicum* L.).

SPECIES III. *Triticum sativum* Lam. of which there are three races as given below and an almost endless number of varieties and sub-varieties.

SPECIES I. **One-grained Wheat** or **Small Spelt** (*Triticum monococcum* L.).—This species is of pale grass-green colour when unripe and possesses a flat, short, compact ear at first sight resembling two-rowed barley (A, Fig 167). The spikelets have two flowers one of which is abortive the other produces a single ripe grain. The flowering glume of the fertile flower bears a long awn and the straw is stiff and almost solid.

The grain is free from the glumes but does not fall out when the ear is thrashed; the rachis of the ear is brittle and behaves on thrashing as the spelts mentioned below.

One-grained wheat is sometimes cultivated on poor soils in the mountainous districts of Spain, Switzerland, and Eastern Europe but is of little practical importance.

The yield is from 25 to 35 bushels of spelt grain per acre.



A

B

C

D

FIG. 167.—A, One-grained Wheat or Small Spelt Wheat (*Triticum monococcum* L.).
B, Two-grained Spelt, or 'Starch Wheat' (*Triticum sativum dicoccum* or *T. dicoccum* Schrk.).
C, Common Beardless Red Spelt (*Triticum sativum Spelta* or *T. Spelta* L.).
D, Polish Wheat (*Triticum Polonicum* L.).

SPECIES II. Polish Wheat (*Triticum Polonicum* L.) (*D*, Fig. 167).—This species has long ears of glaucous tint when unripe and is readily distinguished from all others by its empty glumes, which are often an inch long and enclose all the flowers in the spikelet.

The flowering glumes are awned and each spikelet contains four flowers, only two of which are usually fertile.

The 'grain' is $\frac{3}{8}$ of an inch long and narrow, of reddish colour, flinty, hard and transparent.

The straw is almost solid.

It is chiefly grown in Spain, Italy, and Eastern Europe.

The yield is too small and the plant too tender for cultivation in this country.

SPECIES III. *Triticum sativum* Lam.—To this species belong three fairly distinct races of wheats, namely:—

RACE I. Ordinary Spelt Wheats [Dinkel in Germany] (*T. sativum Spelta* = *Triticum Spelta* L.).—The varieties of this race have ears with spikelets placed rather widely apart (*C*, Fig. 167); the glumes may be white, red, or other colours, smooth or velvety, and in some varieties the flowering glumes are awned, while in others they are without awns.

The spikelets ripen two or three grains, which are triangular in section.

This race of wheat was the commonly cultivated grain of the earliest times, and is still cultivated on poor soils in Switzerland, S. Germany, and Spain. The yield is from 35 to 50 bushels spelt grain per acre.

RACE II. Two-grained Spelt Wheats: 'Starch Wheat' [Emmer in Germany] (*T. sativum dicoccum* = *Triticum dicoccum* Schr. = *T. amyleum*).—This race differs from the previous one in the possession of denser ears; the spikelets are much closer together on the rachis (*B*, Fig. 167); each spikelet ripens only two grains, and the flowering glumes always have long awns.

Two-grained spelt is grown in certain parts of southern Europe and is sown only in spring; its grain is utilised chiefly for the manufacture of starch.

In both the above races (I. and II.) the grain is free, but so closely invested by the firm glumes that it does not fall out when the ear is thrashed. The rachis of the ear is very brittle, and when thrashed breaks up at each notch where the spikelets are inserted; the produce after thrashing, therefore, consists of more or less complete spikelets to which are attached short pieces of the rachis.

RACE III. *T. sativum tenax*.—This race differs from the above by the possession of a rachis which does not break at the notches when thrashed, and the grains readily fall out from between the glumes when the ear is ripe.

Included in it are all the most important varieties of wheat.

It is divided into four sub-races, each of which is sometimes treated as a separate species as follows:—

SUB-RACE, *A.* **Hard or Flint Wheat** (frequently known as *Triticum durum* Desf.).

SUB-RACE, *B.* **Turgid or Rivet Wheat** (*Triticum turgidum* L.).

SUB-RACE, *C.* **Dwarf Wheat** (*Triticum compactum* Host.).

SUB-RACE, *D.* **Common Wheat** (known as *Triticum vulgare* Vill.).

SUB-RACE, *A.* **Hard or Flint Wheat** (*Triticum durum* Desf.) (Fig. 168, *C.*).—This name is applied to a large number of spring-sown wheats chiefly cultivated in the Mediterranean regions and Asia Minor. All the varieties have hard, flinty, somewhat pointed grains and glumes sharply keeled to the base; the flowering glume always has a long awn, and the straw is stiff, generally solid or filled with pith. The grain is very rich in gluten, and utilised extensively for making macaroni.

SUB-RACE, *B.* **Turgid or Rivet Wheat** (*Triticum turgidum* L.) (Fig. 168, *B.*).—The rivet wheats on the Continent are frequently termed 'English Wheats,' although in England they are not very



A B C
FIG. 168.—A, Dwarf Wheat (*Triticum compactum* Host.). Lateral view of the 'Ear' showing
the compact arrangement of the spikelets
B, Turgid or Rivet Wheat (*Triticum turgidum* L.).
C, Hard or Flint Wheat (*Triticum durum* L.).

much grown. They resemble the hard wheats in the possession of sharply-keeled glumes, but the grain, which is red, is short and thick, with a blunt, flattish apex.

The ears are large and four-sided with the spikelets closely packed on the rachis, and the straw very tall, stiff, often solid in the upper internodes, and not at all liable to lodge.

The glumes of most varieties are covered with violet-velvety hairs, and the flowering glume possesses a long awn which often falls off when the grain is ripe.

The turgid wheats, of which there are two or three British varieties, are very late in ripening and only suited to stiff clay soils in the south of England, where they give very large yields of coarse grain and long rigid straw of little use except for litter and thatching purposes.

The grain is exceptionally rich in starch and poor in gluten; the flour is somewhat dark-coloured and unsuitable for bread-baking except when mixed with that from more glutinous varieties of wheats.

SUB-RACE, *C. Dwarf Wheat* (*Triticum compactum* Host.) (Fig. 168, *A*).—The dwarf wheats have very short, stiff straw and exceedingly dense short ears which are rarely over two inches long; the empty glumes are keeled in the upper half and rounded in the lower half.

They are chiefly grown in parts of Germany, Switzerland, Chili and Turkestan; but a wheat known as Piper's Thickset, formerly cultivated in England on account of its heavy yield, appears to have belonged to this race. The awned forms are known as 'Hedgehog Wheats.'

The grains of all the varieties are small and of moderate quality only.

SUB-RACE, *D. Common Wheat* (*Triticum vulgare* Vill.).—To the sub-race of common wheat belong all the most important varieties in cultivation in the great wheat-growing districts of Europe, Australia, and America.

shape, size and habit of their vegetative organs, are nevertheless very similar in the construction and form of their flowers. Species possessing such close resemblances in the structure and arrangement of their reproductive organs are grouped together and are spoken of as a *genus*.

The scientific or botanical name of a plant consists of two Latin words, the first of which indicates the genus and the second the species to which the plant belongs. For example, the true clovers constitute the genus *Trifolium*, the species red clover being named *Trifolium pratense*, while Alsike clover is known as *Trifolium hybridum*. Similarly the various species of buttercups collectively form the genus *Ranunculus*, two common species of the genus being *Ranunculus repens* (creeping crowfoot) and *Ranunculus bulbosus* (bulbous buttercup).

As the same species has sometimes been named differently by different botanists and the same name has not uncommonly been used for two or more distinct species, to prevent confusion it is customary in systematic works to add to the name of the plant the full or abbreviated name of the botanist who gave the plant its name and described it.

For example, the name *Bellis perennis* Linn. or *Bellis perennis* L., indicates that Linnæus gave the name and it also implies that the plant denoted is the particular species which Linnæus described under this name.

Just as species are grouped into genera, so are genera resembling each other grouped into **Orders** or **Families**.

Orders possessing similar characters form **Classes**, and classes having common distinctive characters are finally grouped together into **Divisions**.

Where some of the representatives of a Genus, Order, Class or Division possess characters which mark them off more or less distinctly from the rest of the group to which they belong, it is sometimes useful to subdivide these groups into Sub-genera, Sub-orders, Sub-classes and Sub-divisions.

3. The following are the chief Divisions of the Vegetable Kingdom :—

- Division I. **Myxomycetes.**
- „ II. **Thallophyta.**
- „ III. **Bryophyta.**
- „ IV. **Pteridophyta.**
- „ V. **Spermaphyta.**

The plants included in the first four divisions are often spoken of as **Flowerless plants** or **Cryptogams**. Among them reproduction is carried on chiefly by means of minute one-celled bodies termed *spores*, which are set free from the parent plant and afterwards germinate and give rise to new plants.

The Spermaphytes (Division V.) were formerly designated **Flowering plants** or **Phanerogams**. In these, reproduction is carried on chiefly by means of seeds, each of which contains an embryo-plant.

Division I.—The **Myxomycetes** are commonly known as *slime-fungi*. In a vegetative state the bodies of these organisms consist of naked masses of protoplasm termed *plasmodia*, and are capable of creeping about in a manner similar to the movement of an ordinary amœba. The Myxomycetes are devoid of chlorophyll, and almost entirely saprophytic, that is, they feed mainly upon decaying organic remains, many species being common upon rotten wood and dead leaves. In several respects they greatly resemble the lowest forms of the animal kingdom, and are by some authorities included in the latter and spoken of as Mycetozoa, or *fungus-animals*: their method of reproduction by means of spores is, however, similar to that prevalent among certain Fungi.

One organism generally included in this division and described in chapter I., is parasitic, and the cause of the disease known as ‘Finger-and-toe’ or ‘club-root’ among turnips and cabbages.

Division II.—The **Thallophytes** are plants, such as sea-weeds,

The leaves are broad and deep bluish-green in colour ; the straw is of medium length, and the grain large, very white, and of good quality. It is suited to medium soils and does not succeed well on clays.

(ii) **Hunter's White**.—A winter variety with somewhat loose ears, which taper upwards and are slightly awned at the tip (*B*, Fig. 169). The spikelets are also narrow as in Talavera wheat, but the immature plant is not such a dark-green colour as the latter variety. The grain is flinty, large, dull white, with a pale brownish tinge. This is a hardy variety which gives the best results on medium and inferior wheat soils ; on good land it produces too much straw and is liable to become laid.

(iii) **Chiddam**.—A winter variety with tall straw and ears of the type of Hunter's White. The grain is white and rather starchy. Chiddam White is a wheat suited to chalky and sandy loams in the warm parts of the south of England.

A form known as Main's Stand-up appears to be closely allied to this variety.

A variety with *red* glumes and white grain is also met with under the name of Chiddam.

(iv) **Fenton**.—A winter variety with short irregular stiff straw and slightly denser ear than Hunter's White. The grain is pale white. It is a variety suited to rich soils.

(v) **White Victoria**.—A winter wheat with long dense ears and broad spikelets (*C*, Fig. 169).

The straw is long and the grain very white, and of excellent quality.

(vi) **Hardcastle**.—A variety resembling White Victoria with tall straw, but slightly shorter ears.

The variety known as Trump grown on calcareous soils in the south of England appears to be the same as Hardcastle.

(vii) **Squarehead**.—A winter variety with very densely packed ears, (*D*, Fig. 169), which are rarely more than $2\frac{1}{2}$ to $2\frac{3}{4}$ inches long ; the spikelets are broad.



FIG. 170.—Bearded Common Wheat (*Triticum vulgare* Vill.).

This wheat is little subject to rust and gives good yields of paleish red grain. It has short, stiff straw and can be grown on rich soils without fear of 'lodging.' On account of its weak tillering power it requires to be sown rather thickly.

b. Ear white, glumes covered with white velvety hairs.

(i) **Rough Chaff white, White Velvet-eared, or Old Hoary White Wheat.**—A winter variety only suited to dry climates, and therefore more largely grown in Kent and Sussex than in the northern counties. In damp climates the hairs on the glumes hold water, and the latter is specially liable to induce sprouting or germination of the grain in the ear.

Varieties with open and denser ears are known ; the commonest form has compact ears and short, stiff straw.

The grain is white and semi-transparent, of excellent quality. It is best adapted to rich soils.

c. Ears red, glumes smooth.

(i) **Lammas.**—A winter variety, somewhat tender and only suited to mild climates such as the south of England, where it is grown on rather inferior soils. The straw is long and the ears lax and tapering, of the type of Hunter's White (*B*, Fig. 169) ; the spikelets are narrow and the glumes of a dark-red colour, especially near their tips. The grain is red and of good quality.

A variety known as Red Kent is probably identical with this.

(ii) **Hopetoun.**—A variety with long straw and resembling Hunter's White (*B*, Fig. 169) in form of ear. The grain is white and flinty, and yields flour of good quality.

It is a somewhat tender variety.

(iii) **Spalding or Spalding's Prolific.**—A winter variety, with long loose ears, not tapering much at the tip, and tall, stiff straw. It is one of the most productive wheats and has reddish-yellow grains of fair quality.

(iv) **Golden Drop.**—A prolific variety with dense ears resembling *C*, Fig. 169. The straw is stout and of medium length, the grain plump, pale-red, and of fine quality.

A 'White Golden Drop' is also met with possessing dull white or light red ears and brownish-yellow grain.

(v) **Browick**.—A variety with short very dense ears resembling those of Squarehead, but possessing red glumes and grain of moderate quality only. It is especially suited to damp, heavy land, where it is often very productive.

(vi) **Squarehead's Master**.—A red chaff Squarehead variety with short very stiff straw. Well adapted for cultivation on land in good condition where it yields very large crops. The grain is of very fair quality.

d. Ears red, glumes with velvety hairs.

Varieties with these peculiarities of ear are comparatively few and practically unknown in this country.

SECTION II. **Bearded varieties**.—In these the flowering glumes have long awns as in Fig. 170. Some of them are hardy, but most are tender wheats only suitable for spring sowing, and not much grown in England.

They are usually grouped similarly to the beardless varieties mentioned above.

(i) **Sheriff's White Bearded**.—A winter variety sometimes sown in spring. It has white ears and yields white grain of medium quality.

(ii) **Reading April**.—A rapid-growing variety, capable of ripening grain even when sown as late as April in certain favourable localities. It has long, lax ears of reddish colour. The spikelets often contain four grains, which are light red and of fair quality.

This variety is apparently a slightly improved form of the Old Fern Wheat.

In all spring sown varieties the yield is inferior to those sown in autumn.

CLIMATE AND SOIL.—For its full development wheat requires a warm, somewhat dry, climate.

In hilly districts the plants are small and the yield scanty,

while in wet localities the straw is abundant, but the grain poor in amount and quality also.

Varieties are met with capable of giving good yields upon almost all soils except those of the lightest class or stiff, wet clays; the soils, however, best suited to growth of the most valuable wheats are stiff clay loams.

SOWING.—Winter wheats are sown in autumn, from September to December, in this country most frequently in October; the spring varieties from January to March, most usually in February.

The seed is drilled in rows from 7 to 10 inches apart, the amount used varying from $1\frac{1}{2}$ to 3 bushels per acre.

YIELD.—The average yield in this country is about $28\frac{1}{2}$ bushels, but 60 bushels or more per acre are sometimes obtained; a yield of 40 bushels is usually considered a good crop.

COMPOSITION.—The composition of the wheat grain varies much with the climate, soil, manuring, and variety of the plant. The 'soluble carbohydrates,' mainly starch, average about $66\frac{1}{2}$ per cent.; the albuminoids, $11\frac{1}{2}$; the 'fibre,' 3; the fat, $1\frac{1}{2}$; the water-content usually about 14 per cent.

The albuminoids in some grains are as low as 8 per cent., while in others they may be as high as 24 per cent.; the flinty grains are usually richer in this class of substances than the mealy ones of the same variety of wheat.

Ex. 267.—Examine the spikelets of a ripe ear of common wheat, and note the number of flowers which have produced well-formed grains, and the number of abortive flowers.

Ex. 268.—If possible obtain specimens of the various species, races, and varieties of wheat. Note the shape and colour of the caryopsis, the presence or absence of an awn and keel on the empty and flowering glumes, and the stiffness, solidity, or hollowness of the internodes of the straw of each.

Ex. 269.—The student should also make a point of examining the general form of the ears of different common named-varieties of wheat. Measure how many spikelets are arranged on 2 inches of rachis in each ear. Note also the colour of the chaff and grain in each.

RECOGNITION OF YOUNG CEREALS BY THEIR LEAVES.

(Examine with a good lens.)

A. Young leaf-sheaths without hairs.

- (1) **Barley.** Base of leaf-blade with two *large* clasping claw-like projections as in Fig. 189.

The leaf-blades are very broad with eighteen to twenty-four veins, and rolled to the right.

- (2) **Oat.** Base of leaf-blade without projections as in Fig. 190.

The leaf-blades are not so broad as those of barley and are a darker green colour; they are generally rolled to the left and have eleven to thirteen veins.

B. Young leaf-sheaths hairy.

- (3) **Wheat.** Young leaf-sheath densely covered with short hairs. The leaf-blades have claw-like projections intermediate in size between those of barley and rye; they are rolled to the right and have eleven to thirteen veins.

Close to the claw-like projections at the base of the blade are a few long bristly hairs.

- (4) **Rye.** Young leaf-sheaths covered with short hairs among which are a number of sparsely-scattered long ones easily perceived with the naked eye.

The first leaf-sheath which comes above ground is a purplish-red colour; the blade is rolled to the right and has eleven to thirteen veins. The claw-like projections are smaller than those of wheat and the accompanying bristly hairs are shorter and fewer in number.

CHAPTER XL.

COMMON GRASSES OF THE FARM.

1. THE Order of Grasses includes a total of over 3000 species, of which about 130 or 140 are represented in the British Flora. Many of the species indigenous to this country are comparatively rare and without any practical importance to the farmer. The chief grasses, however, which are met with in most of the best pastures and meadows are described below, and a brief mention is also made of those which require attention on account of their deleterious nature as weeds or because of their general distribution.



Genus *Anthoxanthum*.

Panicle spike-like ; spikelets one-flowered, flowers protogynous ; four empty glumes, two lowest unequal, smooth, both others covered with chestnut or dark brown hairs ; one of them also bears a long bent, twisted dorsal awn, the other a short, straight awn ; flowering glume and pale, awnless, short ; stamens two.

FIG. 171.
A, Spike-like panicle of Sweet Vernal-Grass, natural size. B, Base of leaf-blade and ligule. C, Spikelet (twice natural size).

Sweet Vernal-Grass (*Anthoxanthum odoratum* L.).—A fibrous-rooted perennial, growing about a foot high, and usually present in pastures and meadows upon all kinds of soils. It is one of the earliest grasses, often commencing to grow rapidly in February and March, reaching the flowering stage before the

end of April. The leaves are hairy, broad and flat, somewhat rapidly tapering to a fine long point. The whole plant, especially when dry, emits a fragrant characteristic perfume, due to a small amount of coumarin in it ; this pleasant odour it imparts to hay, in which it is present, and on this account is frequently but erroneously considered a useful pasture grass. We consider the inclusion of this grass in mixtures as a serious mistake from the farmer's point of view, and would strongly recommend the agriculturist to completely discontinue its use. The yield is insignificant, and it is refused by almost all kinds of stock when anything better is to be obtained: moreover, the price of the seed is always high, and specially liable to be inferior in quality and purity. Its place, so far as earliness is concerned, can profitably be taken on most soils by the far superior grass, foxtail.

Puel's Vernal-Grass (*A. Puelii* Lec. et Lam.) resembles the former species but its panicle is not so dense and the stems and leaves more slender and narrower. It is moreover an annual, and has but a faint odour. It is a useless weed introduced by 'seeds' used for the adulteration of those of sweet vernal-grass (see p. 661).

Genus *Alopecurus*.

Panicles cylindrical and spike-like, spikelets one-flowered, compressed, flower protogynous ; empty glumes without awns, fringed with hairs on the keel and generally more or less united at their bases ; flowering glume with a bent dorsal awn, no pale present.

Meadow Foxtail (*Alopecurus pratensis* L.).

—A slightly creeping perennial grass growing best upon damp and stiffish soils. When sown on dry soils soon dies out. It is

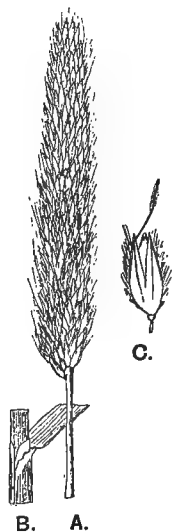

FIG. 172.—A, Spike-like panicle of Meadow Foxtail (natural size).
B, Base of leaf-blade and ligule.
C, Spikelet (twice natural size).

one of the best permanent meadow and pasture grasses and characterised by early and abundant growth. Although it grows well after being cut, it is best suited for grazing land as its flowers are shed and its leaves often withered before the time for cutting grass for hay.

For leys of less than three years' duration it cannot be recommended as it is of slow maturation and does not produce its full yield before the third or fourth year after sowing the seed.

The empty glumes are united about $\frac{1}{4}$ or $\frac{1}{3}$ of their length.

Slender Foxtail: Black-Grass (*A. agrestis* L.).—An annual resembling the last but distinguished from it by its roughish stems and its empty glumes which are united about half their length. The empty glumes are not so hairy and feel harsher than those of meadow foxtail, and the flowers are not produced and ripened till late in summer and autumn. It is a troublesome pest on arable ground and is also present in small quantity in pastures and meadows and by waysides in the south of England. Stock refuse it.

Floating Foxtail (*A. geniculatus* L.) is another useless species of this genus common in wet places and near the edges of pools in damp meadows. Its panicle is more slender than meadow foxtail and its stem is decumbent and bent at the nodes.

Genus *Phleum*.

Panicles cylindrical and spike-like: spikelets one-flowered, compressed: empty glumes with short stiff point or awn: flowering glume awnless.

Timothy: Catstail (*Phleum pratense* L.).—A perennial growing generally in tufts and often mistaken for meadow foxtail. Apart from differences in structure it is, however, a much later grass, and rarely flowers until the spikelets of foxtail have fallen from the rachis. Timothy is among the most useful grasses and can be sown alone or in mixture for leys and permanent pasture. It is one of the best grasses for heavy clays and produces a large

bulk of especially heavy hay of high nutritive value. On thin dry soils, the lower nodes of its stems became thickened and the whole plant is then of little value.

As it grows hard and fibrous when allowed to ripen its seed it should be cut before the spikes are out of the leaf-sheaths. Unlike foxtail it yields little aftermath. As the seed is especially cheap and the yield and nutritive value good, it should form a constituent of all leys on land which is at all stiff.

Genus *Ammophila* (*Psamma*).

Panicles spike-like, spikelets large, one-flowered, compressed: empty glumes two, narrow, awnless, equal or exceeding the flowering glume in length; flowering glume with silky hairs at the base and a very short awn.

Marram-Grass : Mat-Grass (*Ammophila arundinacea* Host.).—A perennial grass which grows on dry sandy sea-shores. Its stems and leaves are strong, rigid, and somewhat glaucous, the former from 2 to 3 feet high; panicles generally 3 to 4 inches long, cylindrical.

It possesses an extensive system of rhizomes which spread through loose sands in all directions, and bind them into more or less solid banks capable of resisting the action of the waves. By its action the sea is prevented from encroaching upon the land, and for this service it is specially protected by Act of Parliament.

Genus *Agrostis*.

Panicle spreading; spikelets one-flowered, very small; empty glumes two, unequal, larger than the flowering glume, awnless; flowering glume either awnless, or with a slender dorsal awn.

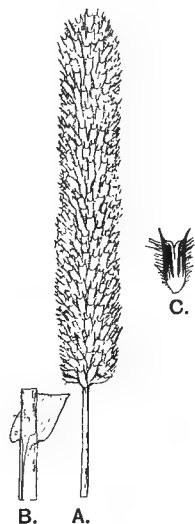

FIG. 173.—A, Spike-like panicle of Timothy or Catstail (natural size).
B, Base of leaf-blade and ligule.
C, Spikelet (twice natural size).

An extensive genus; practically all the species belonging to it are useless to the farmer.



FIG. 174.—A, Panicle of Fiorin or Marsh Bent-Grass (natural size.)

B, Spikelet (twice natural size).

Fiorin : Marsh Bent - Grass (*Agrostis alba* L.).—A perennial, from 6 inches to 2 feet high, of very variable appearance and habit; met with upon almost all soils. On drier arable lands it is as troublesome a pest as true 'couch,' with which it is often confused, and in pastures where it often abounds, and takes the place of good grasses, it should be treated as a weed.

A variety with trailing stems and rhizomes, which take root at the nodes, is the plant generally referred to as Fiorin, and named *Agrostis stolonifera* Koch. On reclaimed bogland, wet meadows, near river banks, and on moist soils generally, this variety grows luxuriantly and crowds out almost all other competitors. A special feature of this grass is

its late autumn growth and power of remaining green until the following spring. Under some circumstances it may possibly be worthy of cultivation, but stock refuse it when they can obtain anything better, and in consideration of the fact that the commercial seed of this variety is rarely, if ever, true to name, it is best avoided altogether by the farmer.

Fine Bent-Grass : Purple Bent : Black Couch (*A. vulgaris* L.).—A perennial almost indistinguishable from the preceding species. It is equally useless. Both plants frequently have purple and reddish stems and leaf-sheaths. Purple bent usually

has a short blunt ligule, and the panicle is open when the fruit is ripe, while Fiorin possesses a long acute ligule, and the branches of the panicle close up to the main axis when the fruit is ripe.

Brown Bent-Grass (*A. canina* L.) is another common useless species which grows upon wet peaty ground. Its flowering glume differs from the other species mentioned in having a long slender dorsal awn.

Genus *Holcus*.

Panicle spreading ; spikelets two-flowered, upper one male, with awned flowering glume, lower one bisexual, with awnless flowering glume ; empty glumes keeled.

Yorkshire Fog: Woolly Soft-Grass (*Holcus lanatus* L.).—An extremely common grass about a foot or 18 inches high, with soft woolly hairs on its leaf-sheaths, blades, and spikelets. It has a tufted habit ; the awn of the flowering glume of the male flower is bent like a fish-hook, and scarcely visible above the empty glumes.

Creeping Soft - Grass (*H. mollis* L.) is similar in general appearance, but more locally distributed in the country than the preceding species. In some districts it is common, especially on sandy soils and by the side of shady woods and hedges. It differs from the above by having somewhat extensive rhizomes, and the awn of the flowering glume of the male flower is nearly straight.



FIG. 175.—A, Panicle of Yorkshire Fog (natural size).
B, Spikelet (twice natural size).

Almost all hairy grasses are refused by stock, and both these species are no exceptions to the rule. They produce a large amount of 'seed' and often rapidly overrun leys.

In Holland and the eastern counties of England on damp, somewhat marshy land Yorkshire fog is less hairy than on drier soils, and is eaten freely by stock: under these conditions the grass is more palatable, and animals thrive upon it.

Genus *Arrhenatherum*.

Panicle spreading: spikelets two-flowered, the lower flower male, with a flowering glume possessing a strong bent, twisted basal awn; the upper flower is bisexual, with a short dorsal awn on its flowering glume.

Tall Oat-Grass: French Rye-Grass (*Arrhenatherum avenaceum* Beauv.: sometimes named *Avena elatior* L.).—A fibrous-rooted perennial grass, growing usually about 3 feet high, and especially common in hedges upon light soils. Its spikelets partially resemble those of a small common oat.

Though not always placed in the first class of fodder grasses, it yields a large bulk of fairly nutritive produce on marly soils, and begins to grow early in spring. It stands cutting well, and in some districts will give two good crops of hay in one season.

The plant has a bitter taste, and when grown alone stock seem to dislike it at first.

It rapidly attains maturity, often producing a fair crop the same season as it is sown, but does not last more than three or four years.

It is sometimes utilised instead of Italian rye-grass in leys of longer duration than one year.

A 'bulbous-rooted' variety, in which the lower nodes are greatly thickened, is common in some localities, and is sometimes known as 'Onion couch.'

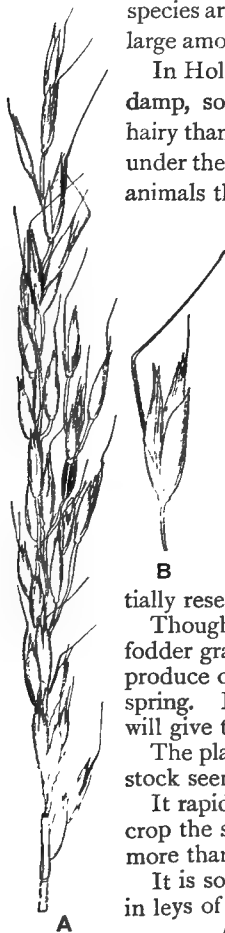

FIG. 176.—A, Particle of Tall Oat-Grass, unexpanded (natural size). B, Spikelet (twice natural size).

This form when established on arable land is a troublesome pest, only satisfactorily eradicated by hand-picking.

Genus *Deschampsia* (*Aira*).

Panicle spreading ; spikelets with two flowers and a rudimentary third ; empty glumes keeled, unequal, blunt ; flowering glume with a dorsal awn.

Wavy Hair-Grass (*Deschampsia flexuosa* Trin. = *Aira flexuosa* L.).—A perennial grass, growing about 12 to 18 inches high, with very narrow, almost solid, leaves: common on dry sandy heaths and pastures.

The branches of the rachis are often wavy or flexuous, hence the name.

The spikelets are purplish or brownish green in colour, and have a shining silky appearance.

This grass is of no agricultural value, but its 'seeds' are often substituted for those of golden oat-grass or used in adulterating the latter (see p. 665).

Tufted Hair-Grass: 'Tussock' Grass; 'Haddock' Grass (*D. cæspitosa* Beauv.

= *Aira cæspitosa* L.).—A

perennial resembling the latter in colour of spikelets and several other particulars. Its leaves are, however, flat, and of leathery texture; the awn of the flowering glume is shorter than that of the preceding species, and scarcely exceeds the length of the empty glumes.

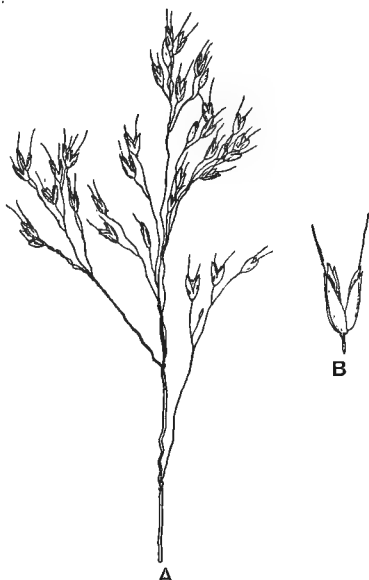

FIG. 177.—A, Panicle of Wavy Hair-Grass (natural size).
B, Spikelet (twice natural size).

It grows in dense tufts, popularly termed 'hassocks' or 'tussocks,' which appear to be raised slightly above the level of the ground. The most luxuriant development is seen when tufted hair-grass grows in wet meadows and woods, but its unsightly tufts of coarse, useless herbage are common on drier meadows and pastures.

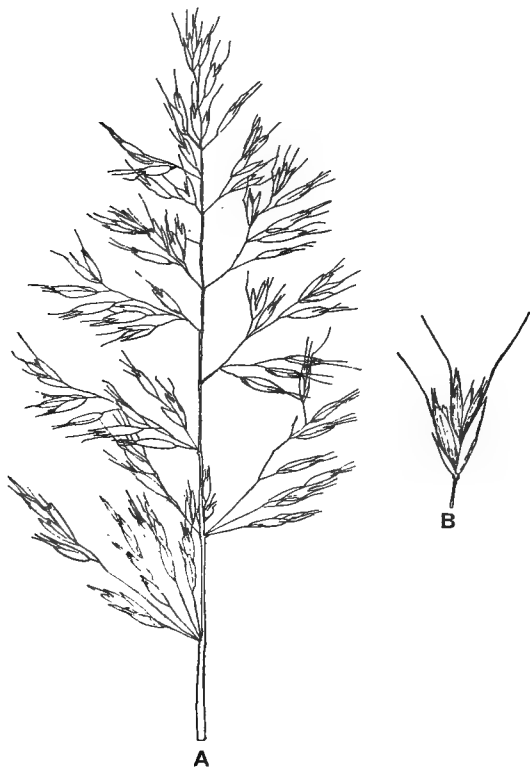

FIG. 178.—A, Panicle of Golden Oat-Grass (natural size). B, Spikelet (twice natural size).

Genus *Trisetum*.

Panicle spreading; spikelets two- or three-flowered; empty glumes unequal and keeled; flowering glumes with a somewhat

hairy base, two awn-like tips, and a long, bent, twisted dorsal awn.

Yellow or Golden Oat-Grass (*Trisetum flavescens* Beauv. = *Avena flavescens* L.).—A somewhat creeping perennial grass, which grows from 1 to 2 feet high; met with upon almost all soils, but especially prevalent on those of calcareous nature. The spikelets are shining and of yellowish colour.

It is a useful grass, and is liked by all kinds of stock, but the yield is somewhat small.

The 'seed' is high in price, usually of poor germinating capacity, and frequently adulterated with worthless wavy hair-grass (see p. 665).

Genus *Avena*.

Panicle spreading; spikelets with two or more flowers; empty glumes, thin, membranous, equalling or exceeding the flowering glumes in length; flowering glumes stouter, rounded on the back, with a long, bent, twisted dorsal awn.

Cultivated Oat (*Avena sativa* L.).—(See p. 492.)

Wild Oat (*Avena fatua* L.).—An annual with a large spreading panicle, probably the origin of the cultivated oat, but differing from the latter in the possession of a tuft of reddish yellow hairs at the base of the flowering glume.

It is a troublesome weed among corn crops when once established.

Bristle-Pointed Oat (*Avena strigosa* L.) is an annual much resembling the common cultivated oat, but with smaller spikelets. It is distinguished from the latter by its flowering glume being divided, and the tips of the two parts prolonged into awn-like points or bristles; between these lies the dorsal awn, and the whole glume appears to possess three awns.

It is met with among corn crops, but is rarer than the wild oat.

Two species of *Avena*, namely, **Narrow-leaved Oat-Grass** (*Avena pratensis* L.) and **Downy Oat-Grass** (*Avena pubescens* Huds.), are perennial grasses growing from 1 to 2 feet high, and common in dry pastures, the former especially on calcareous soils. Neither of them, however, is of any agricultural value, their produce being small and generally passed over by stock.

Genus *Cynosurus*.

Panicles spike-like, dense, one-sided: spikelets of two forms, one completely sterile consisting of several bristle-like empty glumes arranged alternately on opposite sides of a short rachilla, the other fertile with three to five flowers; flowering glumes of the latter leathery, three-nerved, with a stiff rigid point.

Crested Dogstail (*Cynosurus cristatus* L.).—A perennial grass abundant in meadows and pastures throughout the country, perhaps especially so on the drier upland sheep walks. We have, however, seen it in a few damp meadows in exceptional quantity.

After flowering the stems become tough and wiry: it is therefore not very well adapted for mowing, but is one of the best pasture grasses. The short and abundant leaves, when fresh and young, are very nutritious and greedily eaten by all kinds of stock.

The formation of the objectionable and unsightly wiry flowering stems can be avoided by judicious early depasturing of fields in which the grass is abundant.

It is not very early, and only begins to give its full yield two or three years after

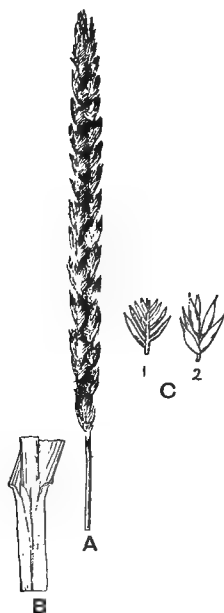

FIG. 179.—A, Spike-like panicle of Crested Dogstail (natural size).

B, Base of leaf-blade and ligule.

C, (1) Sterile spikelet; (2) fertile spikelet (both twice natural size).

sowing, so cannot profitably be used in short leys. It should, however, be included in all mixtures for permanent pastures and included in leys of five or six years' duration. It is a good lawn grass.

Genus *Dactylis*.

Panicle of dense clusters of spikelets all arranged on one side: spikelets with three to five flowers: empty glumes with a short rigid point, keeled; flowering glume with a short almost terminal awn.

Cocksfoot : Orchard-Grass (*Dactylis glomerata* L.). — One of the commonest of all grasses perennial, with a strongly-tufted habit of growth. Its leaf-sheaths are flattened and blades large and flat. It is met with upon all soils, and ranks in the first class of forage grasses on account of its heavy yielding power, high nutritive quality, and power of rapid growth after being cut. Cocksfoot is one of the first grasses to spring up after a field is mown. It is, however, not well adapted for meadows for hay as its unsightly tufts become coarse and woody if allowed to grow until the remainder of the grasses are ready to cut.

Pastures in which Cocksfoot is abundant should be kept well grazed. It is slow to mature, and should not be used for leys of shorter duration than three or four years; but in mixtures for longer leys and permanent pasture it should always be included in moderate amount.

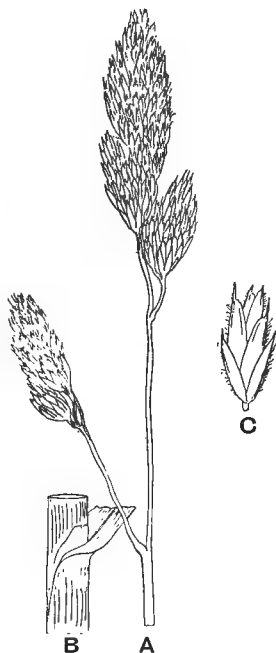

FIG. 180.—A, Panicle of Cocksfoot (natural size).
B, Base of leaf-blade and ligule.
C, Spikelet (twice natural size).

Genus *Poa*.

Panicles spreading; spikelets compressed, with two to six flowers; rachilla often with woolly tangled hairs; empty glumes shorter than the flowering glumes; flowering glume keeled the whole length, awnless.

Annual Meadow-Grass (*Poa annua* L.).—A very common grass on all soils, and especially noticeable when on waste ground. It is annual, and met with in flower during almost every month in the year. Stems about 6 to 12 inches long often lying close to the ground. It possesses little agricultural value, although stock eat the early growth with avidity.

Smooth-stalked Meadow-Grass (*Poa pratensis* L.).—A

common perennial grass with well-developed rhizomes and smooth stems above ground from 12 to 15 inches high. The ligules of the leaves are short and blunt. It is an excellent bottom grass and especially suited to the lighter and medium soils. This meadow grass commences to grow early in spring, but produces only a moderate aftermath when cut for hay.

Rough-stalked Meadow-Grass

(*Poa trivialis* L.).—A common

perennial much resembling the preceding species. It has, however, no long rhizomes; the stems are somewhat rough, and its ligules are long and pointed.

Its leaves are also narrower than those of smooth-stalked meadow-grass, nevertheless it is one of

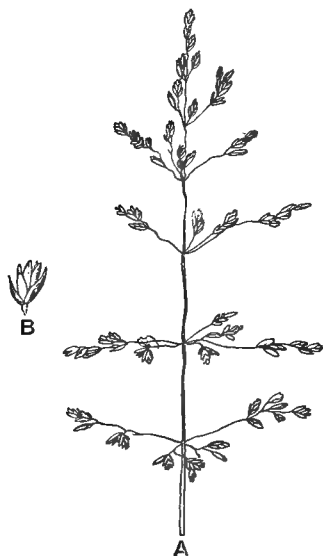

FIG. 181.—A, Panicle of Rough-stalked Meadow-Grass (natural size).
B, Spikelet (twice natural size).

the best 'bottom' grasses and is to be preferred before all others

for sowing on the stiffer and damper class of soils in sheltered situations. It is less hardy than smooth-stalked meadow-grass, suffering more readily from frost and drought, and does not start growth so soon in spring.

Wood Meadow-Grass (*Poa nemoralis* L.).—A perennial grass resembling the two previous species, but of more slender growth, and generally confined to shady places and woods. It has very narrow leaves and a very short ligule. Although it will endure a certain amount of drought when grown in the open meadow, its practical agricultural value is small.

Late Meadow-Grass (*Poa serotina* Ehrh.) is not a native British species, but its seeds are sometimes sold in place of Wood Meadow-Grass. It is a somewhat coarse kind of *Poa* which yields a good late crop of grass.

Genus *Festuca*.

Panicles usually spreading; spikelets with three or more flowers; empty glumes unequal, shorter than the flowering glume; lower half of the flowering glume rounded on the back, upper part often keeled, awned from the tip or with a short, stiff point; styles terminal on the ovary.

Meadow Fescue (*Festuca pratensis* L.).—A perennial broad, flat-leaved grass growing from 2 to 3 feet high, and common in damp meadows. Although somewhat tufted in habit it tends to cover the ground very evenly. It is among the earliest of grasses to start growth in spring, often rivalling meadow foxtail in this respect. It yields a large amount of nutritious fodder and

grows rapidly after mowing or depasturing with stock.

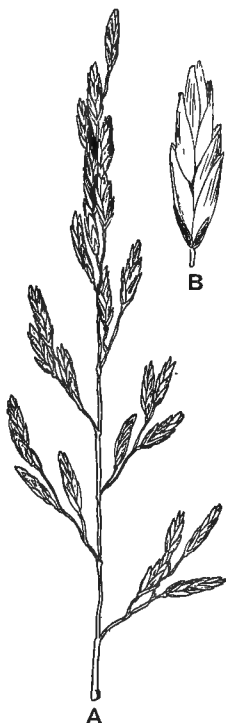

FIG. 182.—A, Panicle of Meadow Fescue (natural size).
B, Spikelet (twice natural size).

Meadow fescue produces its full yield only after three years growth from the seed and is therefore most suited for the longer leys and permanent pasture.

Tall Fescue (*Festuca elatior* L.) resembles the last species but is more tufted in habit and its leaves, stems, and other parts are larger and of coarser texture. It is met with on river banks and in wet places generally, where it frequently grows to a height of 4 or 5 feet. Although it is eaten by all kinds of stock its coarseness unfits it for use in leys and permanent pasture. Possibly meadow fescue is merely a subspecies of this plant.

Festuca arundinacea Schreb., which grows near the sea coast in many parts of the country, is a large form of tall fescue with rough leaf-sheaths.

Sheep's Fescue (*Festuca ovina* L.).—A small perennial grass, usually not more than a few inches high and growing in tufts, with narrow, almost solid, bristle-like leaves and smooth leaf-sheaths. It grows well on dry soils, and is one of the chief constituents of upland sheep pastures.

Hard Fescue (*Festuca duriuscula* L.) resembles the last species, but has narrow, flat leaves, downy leaf-sheaths, a more open panicle, and does not grow in such dense tufts. It is also of larger growth than sheep's fescue.

Both these grasses are constituents of the best sheep pastures on the higher ground of this country, and are almost unaffected by the driest weather. Their produce is small but nutritious and more succulent than the general appearance of the leaves indicates. Hard fescue may be used with advantage, in moderate amount, as a 'bottom' grass in all mixtures for permanent pasture in dry situations.

Red Fescue (*Festuca rubra* L.) is a perennial grass very nearly



FIG. 183.—C, Panicle of Sheep's Fescue (natural size).
B, Base of leaf-blade and piece of stem.
A, Piece of leaf showing its cross-section and manner of folding.

related to the last two species. It possesses narrow, flat leaves, pale red spikelets, and creeping rhizomes.

The limits of the last three species of *Festuca* are ill-defined, as a large number of varieties exist which are intermediate in character between them.

Little or no attempt is made by seedsmen to supply 'seeds' of these species true to name, and for practical purposes there is no necessity to do so.

Genus *Bromus*.

Panicles spreading : spikelets large with five or more flowers : empty glumes, unequal, acute : flowering glume generally with a divided tip and an awn which arises just below the tip. Styles lateral on the ovary.

An extensive genus of coarse, harsh or hairy-leaved grasses, the species of which are nearly all useless or of small importance as forage plants.

Awnless Brome-Grass : Hungarian Forage-Grass (*Bromus inermis* Leyss.).—A tall perennial grass with long rhizomes and smooth leaves sometimes over half an inch broad. It is grown extensively in Hungary, alone or in mixture with lucerne, on dry soils where it gives very large yield of grass, which if cut early makes fairly nutritious hay.

It grows slowly in spring, but two cuts are often secured on the Continent in one season when the plant is thoroughly established.

Our experience with it in this country has not been successful even on the looser soils, for which it has been specially recommended.

Schrader's Brome-Grass (*Bromus Schraderi* Kunth.).—A perennial grass with harsh broad leaves, recommended sometimes on account of its productiveness on thin soils.

After several years' trial we cannot advise its being grown by the British farmer, as it rapidly becomes coarse, grows in massive

tufts, and is liable to die off in winter and become patchy in the second or third year after sowing.

Soft Brome - Grass (*Bromus mollis* L.).—An annual or

biennial grass very common on dry roadsides and waste places and growing about a foot high. It has thin broad leaves, the sheaths and blades of which are soft and downy; the spikelets are also covered with soft hairs.

This species and the nearly allied ones **Smooth Brome-Grass** (*B. racemosus* L.); **Field Brome-Grass** (*B. arvensis* L.), and **Eye-like Brome - Grass** (*B. secalinus* L.) are all troublesome weeds of pastures, leys and corn-crops.

Genus *Brachypodium*.

Panicles spike-like, the cylindrical spikelets have very short stalks, and are arranged on opposite sides of the rachis. Each spikelet possesses five or more flowers: empty glumes

two: flowering glume with



FIG. 184.—A, Panicle of Soft Brome-Grass (natural size).

B, Spikelet (twice natural size).

a short terminal awn. A small genus of harsh perennial useless grasses. There are two British species, namely:—

False Brome-Grass (*Brachypodium pinnatum* Beauv.), Fig. 256, and **Slender False Brome-Grass** (*Brachypodium sylvaticum* R. and S.). The former species has an erect panicle and is common on open downs and poor pastures in chalky districts: it is known as 'Tor grass' in Kent. The latter species has a drooping inflorescence, and is met with in woods and on hedge-banks.

Genus *Nardus*.

Inflorescence a spike: spikelets one-flowered arranged one at each notch of the rachis, and on one side of the latter: no empty glumes: flowering glume narrow with a short awn.

Mat-Grass (*Nardus stricta* L.).—A small stiff perennial grass 6 or 8 inches high. Common on dry heaths and moors. Its stems and leaves are wiry and rejected by sheep.

Genus *Hordeum*.

Inflorescence a spike: spikelets one-flowered arranged three together at each notch of the rachis and alternately on opposite sides of the latter. All three spikelets at each notch may be bisexual or only the central one, the lateral spikelets being in the latter case male or neuter: empty glumes two, very narrow, awned, placed partially in front of the spikelet. Flowering glume with a long terminal awn.

Cultivated Barley (*Hordeum sativum* Pers.).—(See p. 500.)

Meadow Barley (*Hordeum pratense* Huds.).—A perennial species common in wet or damp meadows near riversides where it grows about 18 inches high.

It possesses a slender stem and narrow flat leaves. Meadow barley grows early in spring and may be considered a useful pasture grass when not allowed to flower. In hay, however,



B. A.
 FIG. 185.—
 A, Spike of
 Mat-Grass
 (*Nardus*
stricta L.)
 (natural
 size).
 B, Base of
 leaf-blade
 and ligule.

the awns of the spikelets are irritating and injurious to stock.

Wall Barley (*Hordeum murinum* L.).—An annual much resembling meadow barley, but met with on dry waste ground and about footpaths and roadsides near walls.

It is not so tall as meadow barley, and is of no agricultural value.

Genus *Lolium*.

Inflorescence a spike ; one spikelet at each notch of the rachis ; the spikelets are many-flowered, and are inserted so that they stand in the median line of the rachis, that is, the plane passing through the middle of the glumes passes through the rachis also.

The terminal spikelet has two empty glumes, the lateral spikelets only one (the outer empty glume); flowering glume awned or awnless.

Perennial Rye-Grass : Ray Grass (*Lolium perenne* L.).—A perennial common in all the best pastures and meadows throughout the country, and used probably more extensively than any other grass in mixtures for leys and permanent pastures.

The leaves are folded in the bud.

It grows most luxuriantly on soils which are loamy or stiffish in character. On dry soils the produce is small and of little value.

Perennial rye-grass is a variable plant, and many varieties are met with differing chiefly in yield, fineness of leaf, density of spike, and durability.



FIG. 186.—A, Spike of Perennial Rye-Grass (natural size).
C, Base of leaf-blade and ligule.
B, Spikelet of Italian Rye-Grass.
D, Spikelet of Perennial Rye-Grass (twice natural size).

No systematic attempt appears to be made now to obtain pure seed of any of these varieties, although formerly such attempts were made with success.

The names Pacey's rye-grass, Devonshire Eaver, fine-leaved rye-grass, and others at present used in commerce, do not represent different varieties of plants, but are merely names attached to 'seeds' of a certain size or weight. 'Seeds' passing through a small sieve usually give rise to young plants with fine thin leaves.

Often all 'seeds' above a certain weight per bushel have the term 'Pacey' added; such samples are generally superior to those of lower weight, and a somewhat higher price is charged for them.

Perennial rye-grass grows somewhat in tufts, and gives a good yield of fairly early produce. Its nutritive value is only moderate, and the aftermath or second cut is not often large.

Upon dry soils its duration is short, usually two or three years; but on land suited to its requirements it is for all practical purposes a lasting grass, even when not allowed to produce seed and become self-sown.

For leys of short duration it is excellent, but should be used sparingly in permanent mixtures.

Its lavish use by the seedsman in expensive 'mixtures,' which should have been cheaper, and the partial abuse of it by the farmer himself in employing it in excessive amount for purposes to which it is unsuited, have tended to the depreciation of the grass in some quarters. Nevertheless, its rapid growth, good yield, fair nutritive value, hardiness, power of forming an excellent 'bottom' on almost all classes of soil, and other features, place it in the front rank of all grasses when judiciously used.

Italian Rye-Grass (*Lolium italicum* A. Br.) is not met with in a wild state, and is no doubt a cultivated form of perennial rye-grass. Its leaves are rolled in the bud, and the flower-

ing glumes are awned. This grass is of short duration usually, not more than over two years, but like perennial rye-grass becomes readily self-sown.

It is one of the most rapidly growing grasses, producing heavy crops in the same season in which it is sown, is superior in feeding quality to the previous species, and very extensively used for one or two years' ley. For permanent pasture mixtures it should be left out altogether, or employed in very small amount.

Darnel (*Lolium temulentum* L.).—An annual grass met with as a weed among corn crops. It resembles the above-mentioned rye-grasses, but its spikelets have fewer flowers, and the empty glume generally exceeds the spikelet in length. The flowering glume is mostly awned as in Italian rye-grass. In certain plants the fruits are infected with the mycelium of a fungus, and are said to be poisonous.

Genus *Secale*.

Inflorescence a spike without a terminal spikelet: spikelets somewhat compressed, two- or three-flowered, transverse to rachis, that is, the edges of the glumes next to the rachis: one spikelet at each notch of the latter. Empty glumes very narrow, flowering glumes keeled to the base, and with a long terminal awn; keel with a fringe of strong hairs.

Rye (*Secale cereale* L.).—(See p. 511.)

Genus *Triticum*.

Annual grasses. Inflorescence a spike with a terminal spikelet: spikelets inflated, two to five flowers, transverse to the rachis, that is, the edges of the glumes next to the latter: empty glumes with an awn or strong tip: flowering glume with one or more long or short awns.

Wheats (see p. 515).

Genus *Agropyrum*.

Perennial grasses (sometimes included in the genus *Triticum*). Inflorescence a spike: spikelets somewhat compressed, three- or more-flowered, transverse to the rachis, that is, the edges of the glumes towards the latter (opposite in arrangement to *Lolium*): empty glumes shorter and narrower than the flowering glumes: flowering glumes stiff, with or without a terminal awn.

Couch: Quitch: Twitch: Whickens: Creeping Wheat-Grass (*Agropyrum repens* Beauv.).—A perennial grass with long creeping rhizomes, and well-known as one of the most troublesome weeds of arable ground. The leaves are flat, smooth, and somewhat ashy green in colour. The inflorescences (spikes) are 2 or 3 inches long, and most frequently observed on specimens growing in hedges and on waste ground, the plants occurring on arable ground being rarely allowed to flower.

The flowering glumes end in a stiff acute point which is sometimes prolonged into a short awn. Stock readily eat the young leaves of couch-grass.

Bearded Wheat-Grass (*Agropyrum caninum* L.).—A perennial grass of tufted habit, without long rhizomes, and usually found in moist woods and on banks and damp waste ground. It also differs from the preceding species in possessing rough awns on its flowering glumes.

Bearded Wheat-Grass is useful in producing a fairly large supply of early leaves, which are greedily eaten by all kinds of stock.



FIG. 187.—A, Spike of Couch-Grass (natural size).
B, Base of leaf-blade and ligule.
C, Spikelet (twice natural size).

SUMMARY OF GENERIC CHARACTERS OF THE COMMON FARM GRASS. S.

A. Inflorescence a panicle : in some cases the stalks (pedicels) of the spikelets are very short, and the panicle is spike-like.

1. Spikelets with only one perfect flower.

a. Empty glumes four ; panicle spike-like. *Anthoxanthum.*

b. Empty glumes two.

(i) Panicle spike-like (Fig. 172). (See p. 531.) *Alopecurus.*

(See p. 532.) *Phleum.*

(See p. 533.) *Ammophila.*

(ii) Panicle spreading (Fig. 174). *Agrostis.*

2. Spikelets with two or more flowers.

a. Empty glumes equal to or longer than the flowering glume, often hiding from view the rest of the spikelet.

The flowering glume generally awned ; awn dorsal, twisted and bent (*B*, Fig. 176), except in *Aira* and *Deschampsia*.

(i) Spikelets with two flowers ; upper one male, lower one bisexual. *Holcus.*

(ii) Spikelets with two flowers ; lower one male, upper one bisexual. *Arrhenatherum.*

(iii) Spikelets with two or more bisexual flowers.

(See p. 537.) *Deschampsid.*

(See p. 538.) *Trisetum.*

(See p. 539.) *Avena.*

b. Empty glumes shorter than the flowering glumes, the rest of the spikelet generally visible (*B*, Fig. 182).

When the flowering glume is awned, the awn is terminal and generally straight (Fig. 184).

(i) Panicle spike-like (Fig. 179). *Cynosurus.*

(ii) Panicle of dense clusters of spikelets (Fig. 180). *Dactylis.*

(iii) Panicle spreading (Fig. 181).

* Flowering glume compressed with a keel along its whole length ; no awns. *Poa.*

** Flowering glumes rounded on the back, and upper part only keeled ; sometimes awned.

(See p. 543.) *Festuca.*

(See p. 545.) *Bromus.*

B. Inflorescence a spike (Fig. 186) : the spikelets sessile, arranged directly in notches on the single main axis.

1. Spikelets one-flowered.

a. One spikelet at each notch (Fig. 185). *Nardus.*

b. Three spikelets at each notch (Fig. 159). *Hordeum.*

2. Spikelets with two or more flowers.

a. One spikelet at each notch.

- (i) Glumes with their *backs* towards the notch of rachis (Fig. 186). *Lolium.*
- (ii) Glumes with their *edges* towards the notch of rachis (Fig. 187).
- Empty glumes narrow, subulate. *Secale.*
- Empty glumes broad. (See p. 550.) *Triticum.*
- (See p. 551.) *Agropyrum.*
- b.* Two or three spikelets at each notch. *Elymus.*

RECOGNITION OF THE CHIEF MEADOW AND PASTURE GRASSES BY THEIR LEAVES.

GROUP I.

LEAVES FOLDED IN THE BUD (Fig. 188): THE SHOOT APPEARS FLATTENED.

This feature is readily determined by cutting across the shoot with a sharp knife and examining with a pocket lens.

The following grasses belong to this group:—

- | | |
|----------------------|----------------------|
| Perennial Rye-Grass. | Crested Dogtail. |
| The Meadow-Grasses. | Sheep's Fescue. |
| Cocksfoot. | Hard and Red Fescue. |

1. Base of leaf with claw-like appendages which clasp the stem more or less (Figs. 186 and 189).

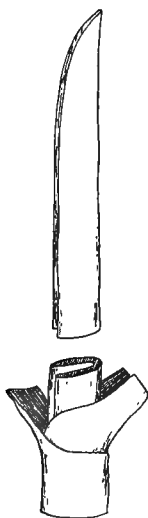

FIG. 188



FIG. 189.



FIG. 190.

Perennial Rye-Grass (*Lolium perenne* L.). This grass is not hairy, and its lower leaf-sheaths just below ground are pink. The ligule is extremely short, and the upper surface of the leaf-blade possesses well-marked longitudinal ribs.

The latter are seen best when a leaf is cut across with a sharp knife and the section examined with a lens.

2. Base of leaf without claws (Fig. 190).

a. Leaf-sheaths below ground bright yellow.

Crested Dogstail (*Cynosurus cristatus* L.). The grass is not hairy; its leaves are thick and firm, generally concave or not quite flat, with prominent longitudinal ribs on the upper surfaces of the blades.

The leaves are firmer than those of Perennial rye-grass, and sometimes slightly rolled so that the shoot is rounder.

b. Leaf-sheaths not yellow.

(i) Leaves almost cylindrical or bristle-like (Fig. 183).

Sheep's Fescue (*Festuca ovina* L.) and the allied Hard and Red fescues. The latter forms have leaves which are flatter or not so closely folded as those of the typical sheep's fescue.

All have strong longitudinal ribs on the upper surface.

(ii) Leaves flat, without prominent longitudinal ribs.

* Leaves narrow; two white longitudinal lines are seen—one on each side of the mid-rib—when the leaf is held up to the light and examined with a lens.

Meadow-Grasses or Poas.

Rough-Stalked Meadow-Grasses (*Poa trivialis* L.). Ligule acute; tufted habit; generally with an acute keel to the leaf-sheath.

Smooth-Stalked Meadow-Grass (*Poa pratensis* L.). Ligule short; rhizomes below ground. The leaves are thicker and a darker green colour in this species than in the previous one.

** Leaves broad, without the white longitudinal lines.

Cocksfoot (*Dactylis glomerata* L.). Prominent keel to the leaf-sheath; the under surface of the blade is duller than that of rough-stalked meadow-grass, which is sometimes confused with this species.

GROUP II.

LEAVES ROLLED IN THE BUD (Fig. 191): THE SHOOT IS CYLINDRICAL.

The following grasses are included in this group:—

Italian Rye-Grass.	Sweet Vernal-Grass.
Meadow Fescue.	Yorkshire Fog.
Tall Oat-Grass.	Couch.
Yellow Oat-Grass.	Fiorin.
Timothy or Catstail.	Soft Brome-Grass.
Foxtail.	

1. Base of leaf with claw-like appendages (Fig. 189).

a. Leaf-sheaths pink below ground, smooth and shining.

Italian Rye-Grass (*Lolium italicum* A. Br.). Margin of the leaf-blades smooth; the blade with indistinct veins when held up to the light.

Meadow Fescue (*Festuca pratensis* Huds.). Margin of the leaf-blade rough (test with the tongue); the veins of the leaf-blade appears as white lines when held up to the light.

b. Leaf-sheaths not pink: leaf-sheaths often with a few scattered hairs.

Couch (*Agropyrum repens* Beauv.). Distinguished also from the two preceding species by its well-marked rhizomes.

2. Base of leaf-sheath without claw-like appendages (Fig. 190).

a. Leaf-sheaths hairy.

(i) Leaf-sheath white with pink veins.

Yorkshire Fog (*Holcus lanatus* L.).

(ii) Leaf-sheaths without pink veins.

Soft Brome-Grass (*Bromus mollis* L.).

Leaf-sheath keeled and entire; the blades are thin, dry, and very soft.

Sweet Vernal - Grass (*Anthoxanthum odoratum* L.). Leaf-sheath not keeled.

The grass has a characteristic odour and bitter taste; base of leaf-blade rounded with a fringe of long hairs.

Yellow Oat-Grass (*Trisetum flavescens* Beauv.). Leaf-sheath not keeled.

b. Leaf-sheaths smooth (sometimes sparsely hairy in Tall Oat-Grass).

(i) Old leaf-sheaths below ground, dark maroon.

Foxtail (*Alopecurus pratensis* L.). Rhizomes present. Ligule not so long as it is broad, and hairy on the back.

(ii) Old leaf-sheaths pale.

Timothy (*Phleum pratense* L.). Tufted habit of growth without long rhizomes. Ligule longer than broad and without hairs on the back. Ribs on blade low and flat.

Florin (*Agrostis alba* L.). Has well-developed rhizomes. Ligule long and hairy on the back. Blade rough on both sides, with prominent ribs.

Tall Oat-Grass (*Arrhenatherum avenaceum* Beauv.). Short rhizomes. Ribs on blade low and flat.

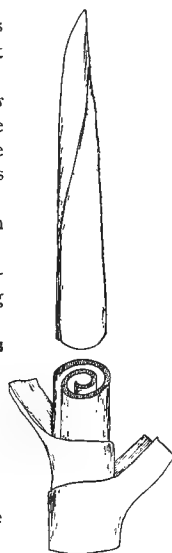

FIG. 191.

CHAPTER XLI.

GRASSES AND CLOVERS FOR TEMPORARY AND PERMANENT PASTURES.

1. THE seeds of the grasses and clovers are very extensively mixed and sown for the purpose of forming temporary and permanent pastures. The constitution of these mixtures, both in regard to the choice of the species of plants to be used and the amount of seed of each species to be sown, is at present a matter upon which there exists great difference of opinion. Nevertheless there are certain general principles for guidance in the choice of grasses and clovers for particular purposes, which it is useful to point out.

No rational, satisfactory, or economic use can be made of any species of grass or clover unless its character in regard to the following points is understood :—

(i) *Durability*.—Some grasses, such as Italian rye-grass, are annual, and die off after seeding once ; while others, such as meadow foxtail and cocksfoot, are perennial. No hard and fast line exists among plants in regard to their duration (see p. 5), as the time during which they live is dependent on climate, soil, and the treatment which they receive : for present purposes, however, they may be divided into (a) those which are *short-lived* and suitable only for one, two, or three years' duration, and (b) those which are *permanent* and adapted for use in pastures to be kept down for longer periods.

(ii) *Rapidity of growth after sowing*.—Many grasses reach their highest state of development in the first or second year. This is generally true of the less permanent plants, such as the rye-grasses, tall oat-grass and red clover. Others, such as cocks-

foot, meadow foxtail, meadow fescue and all the more lasting grasses, do not attain their maximum of growth until the third or fourth year after sowing.

(iii) *Tufted and creeping 'habit.'*—Some grasses grow in more or less isolated tufts, and are incapable of forming a compact turf when sown alone; while others, such as meadow foxtail and smooth-stalked meadow-grass, have underground stems or rhizomes similar to those of couch grass, which spread in various directions and send up green leafy shoots over considerable areas. In order to obtain an even and uniform 'sole' of turf, it is essential that mixtures should contain an adequate proportion of *both* classes.

(iv) *Height.*—The grasses and other plants used for mixtures vary considerably in stature: the tall-growing kinds of special use in leys for mowing are designated '*top-grasses*,' while the shorter kinds are termed '*bottom-grasses*' and are employed to form 'bottom' in meadows and pastures.

Although no hard line of demarcation exists between '*top-grasses*' and '*bottom-grasses*,' the following classification represents the general character of the common grasses and clovers in this respect. Some of the plants mentioned, such as perennial ryegrass and rough-stalked meadow-grass, may reasonably be included in both divisions:—

(a) *Top-grasses.*

Italian Rye-grass.
Cocksfoot.
Tall Oat-grass.
Timothy.
Meadow Foxtail.
Rough-Stalked Meadow-grass.
Red Clover.
Alsike Clover.

(b) *Bottom-grasses.*

Golden Oat-grass.
Crested Dogstail.
Perennial Rye-grass.
Smooth-Stalked Meadow-grass
Sheep's Fescue.
Hard Fescue.
Fiorin.
Sweet Vernal-grass.
White Clover.
Kidney-Vetch.
Bird's-Foot Trefoil.
Black Medick.

(v) *Earliness and lateness of growth.*—Sweet vernal-grass, meadow-foxtail, cocksfoot, meadow fescue, and tall oat-grass commence to grow in early spring, while timothy and fiorin are much later in the production of their leafy shoots.

(vi) *Power of growth after being cut,* or the yield of aftermath to be obtained from a grass is a matter for careful consideration.

(vii) *Quality and yield of produce.*—The feeding quality of the grasses and other plants depends upon their specific nature to a considerable extent, but it also varies with their age, the particular stage of their development, and soil upon which the plants are grown, as well as upon several other conditions. For all practical purposes in the choice of the different common grasses mentioned below as suitable for leys, we must at present rest content to treat them as of equal value in this respect.

(viii) *Adaptability to certain soils and climates.*—All the best grasses, such as are adapted for use in the formation of leys and permanent pastures, and capable of yielding valuable fodder, grow readily upon all classes of soils. Some however, such as timothy, rough-stalked meadow-grass and alsike clover, grow most satisfactorily upon the stiffer, damper soils, while tall oat-grass, hard fescue, kidney-vetch, and others are adapted to drier soils.

For the best results with grasses their soil-requirements must be considered.

2. Grasses and Clovers for Leys of One, Two, or Three Years' Duration.

In these leys which are to be kept down for a short time only, the grasses and clovers must fulfil the following requirements:—

(i) They should have the power of growing rapidly and should reach their maximum state of development within the time during which the 'ley' is to be utilised.

(ii) They should yield a large bulk of produce ; and

(iii) Should be of good feeding-quality.

Moreover, the necessary seeds should be cheap as the outlay for them occurs often.

As the 'leys' are to be ploughed up at the expiration of two or three years, the question of their durability or permanence beyond this period is of no importance.

The grasses and clovers most nearly satisfying the above conditions are:—

Red Clover.	Italian Rye-grass.
Alsike.	Perennial Rye-grass.
White Clover.	Timothy.
Black Medick.	Tall Oat-grass.

Usually only one, two, or three of the above species are employed in each mixture. Which individuals should be selected depends upon the character of the soil, the manner in which the produce is to be used, and the duration of the 'ley.'

Red clover, black medick, and Italian rye-grass are practically annual and therefore only useful for one or two year leys. The other plants are more durable and used when the leys are left down three years.

Black medick is chiefly employed on the somewhat inferior, dry, calcareous soils; Timothy and Alsike are adapted to the stiffer soils, the latter clover taking the place of red clover where clover-sickness is feared.

For grazing with sheep, white clover is usually a prominent constituent of the ley.

The following examples may be taken as illustrations of the species to be employed, and the proportions of each to be used, in the formation of mixtures for short leys.

As the clovers grow freely, produce large bulk, and are more nutritious than the grasses, the proportion of ground covered by them should range between 50 and 100 per cent., the greater amounts being taken on good soils free from 'clover-sickness.'

On poor soils, or those on which the clovers do not grow satisfactorily, the proportion of grasses should be increased so as to cover the ground more or less up to 50 per cent. of the whole.

(a) *Mixture for one year on good medium soil.*

	Percentage of ground covered.	
	(i)	(ii)
Red Clover . . .	80	or 90
Italian Rye-grass . . .	20	or 10

(b) *Mixture for two or three years on good medium soil.*

	Percentage of ground covered.
Red Clover . . .	80
Timothy . . .	10
Italian Rye-grass . . .	10

(c) *Mixture for two or three years on heavy damp soils.*

	Percentage of ground covered.	
	(i)	or (ii)
Red Clover . . .	35	
Alsike . . .	45	70
Timothy . . .	15	25
Perennial Rye-grass . . .	5	5

(d) *Mixture for one year's sheep pasture.*

	Percentage of ground covered.
White Clover . . .	66
Black Medick . . .	34

(e) *Mixture for two or three years' sheep pasture.*

	Percentage of ground covered.
White Clover . . .	80
Perennial Rye-grass . . .	20

3. Grasses and clovers for temporary pastures lasting from three to six years : Grasses and clovers for permanent pasture.

Mixtures for the longer leys and for permanent pasture have a great deal in common, so that their composition may be discussed together. Failure to establish a satisfactory long ley or a permanent pasture may be due to the employment of bad seed, wrong manuring, imperfect mowing or grazing, and other causes, some of them beyond human control. Want of success is, however, sometimes the outcome of the wrong choice of plants for the ley, and to avoid failure on this account requires very careful consideration, both in regard to the choice of the species of plants to be used, and in the determination of the amount of ground to be covered by each.

It is obvious that the plants previously mentioned as suitable for leys of one, two, or three years' duration are by themselves quite unsuited for the longer leys and permanent pasture, inasmuch as in the third or fourth year they die out almost completely, and the ground, under such circumstances, either becomes bare or is rapidly overspread by weeds which take the place of the disappearing grasses and clovers.

In order to impart durability some of the permanent grasses must be introduced into the 'leys.'

Permanence is, however, not the only point to consider. It is desirable that from the beginning to the end of the ley there should be an uniform yield of produce, and not a high yield during the first year or two, followed by a dearth in the later years, or *vice versa*. This can only be attained by carefully balancing the rapid-growing, short-lived plants with the more permanent species, which are slow in growth, and do not give their full yield until they are well established.

When too great a number of rapid-growing, short-lived grasses are introduced the yield at first is very heavy, but the small, slow-growing, permanent plants are weakened almost beyond

recovery, or totally destroyed by being overshadowed by their strong-growing neighbours. On the other hand, if too large a proportion of permanent grasses are employed, the yield of produce during the first few years is very materially reduced.

For leys of from three to six years' duration the best authorities consider that the ground should not be covered to a greater extent than 30 or 40 per cent. by the clovers, the smaller proportion being used in those leys which are intended to last longest. If a larger proportion is used, the pastures in a few years become thin and patchy owing to the dying-off of the clovers, none of which are permanent, except the white species.

The rest of the ground, namely, 60 to 70 per cent., is covered by grasses, one-half of which should belong to the short-lived, the other to the more permanent species; if a larger amount of short-lived grasses is sown the pasture becomes patchy in the later years.

For permanent pastures the amount of clovers sown should be such as will cover not more than 20 per cent. of the ground, the remaining 80 per cent. being taken up by grasses, of which between 50 and 60 per cent. should be permanent.

The following tables indicate the general composition of these two classes of mixtures:—

(a) *For leys of three to six years' duration.*

				Percentage of ground covered.
Clovers	.	.	.	30 or 40
Grasses	{	Short-lived	.	35 or 30
		Permanent	.	35 or 30

(b) *For permanent pasture.*

				Percentage of ground covered.
Clovers	.	.	.	20
Grasses	{	Short-lived	.	30 or 20
		Permanent	.	50 or 60

The plants available for long leys and permanent pastures are :—

CLOVERS.

(i)	(ii)
<i>Short-lived.</i>	<i>Permanent.</i>
Red Clover.	White Clover.
Alsike Clover.	Bird's-Foot Trefoil.
Black Medick.	

GRASSES.

(i)	(ii)
<i>Short-lived.</i>	<i>Permanent.</i>
Italian Rye-grass.	Rough-stalked Meadow-grass.
Perennial Rye-grass.	Smooth-stalked Meadow-grass.
Timothy.	Cocksfoot.
Tall Oat-grass.	Meadow Fescue.
	Meadow Foxtail.
	Crested Dogtail.
	Golden Oat-grass.
	Sheep's Fescue.
	Hard Fescue.

Which of these species, and how many of them should be selected for any particular ley, will depend upon the soil, the duration of the ley, and the purpose which the latter is intended to serve. If for mowing chiefly, about two-thirds of the ground allotted to the grasses in the above tables, (a) and (b), should be given to 'top-grasses'; whereas if the pasture is intended mainly for grazing, the 'top-grasses' may be conveniently reduced to one-half.

On light soils the amount of 'bottom-grasses' should be slightly increased in order to keep the moisture on the land, but in damp soils they should be decreased.

As a rule, the larger the number of species in a mixture the better, because when one grass fails on account of the dampness

or dryness of the season or soil, another species often succeeds. Moreover, no single plant will continue to grow and provide food for stock from spring to autumn ; but by judicious selection of a number of different species according to the earliness or lateness of their growth, a continuous production of forage can be obtained during many months of the year.

In addition to the principles previously indicated for guidance in the choice of species, the agriculturist should determine the species of grasses which grow in the best meadows and pastures on similar soils in the neighbourhood, and give prominence to these in any mixture he intends to use, especially where the pastures are to be permanent.

It is very necessary, however, to point out that the practices of sowing sweepings of the hay-loft, or seeds obtained from a specially-saved crop of hay from the best meadows of the farm, are both very unreliable, although in some cases they have led to good results. Neither of these methods provides seeds of all the good plants of the meadow. Investigations we have carried out in regard to the composition of such home-produced mixtures have invariably shown that the latter contain the seeds of only a small number of species of grasses—just those which were ripe at the time the hay was cut—and frequently a number of common weed seeds ; all the early grasses are missed, as their seeds have been shed, and the seeds of the best late grasses are rarely obtained, as the meadow is usually mown before they are ripe.

The following prescriptions are not intended to be slavishly copied, but may be taken as illustrative of the principles laid down. The farmer should use his own judgment in regard to the amount and nature of each plant used, bearing in mind their particular individual qualities in regard to durability, habit of growth, adaptability to special soils, and other points mentioned at the beginning of the chapter (see also Chapter xl.).

A.—Mixtures for Temporary Pasture of four to six years' duration on good average loams.

In such mixtures as these the amount of ground covered by Italian rye-grass should not be more than 5 per cent., perennial rye-grass not more than 10 per cent., and the red clover not more than 25 per cent. respectively, as none of these plants last six years as a rule.

		Percentage of ground covered by each species.	
Clovers	{	Red Clover	15
		Alsike Clover 33 %	8
		White Clover	10
Short-lived Grasses	{	Italian Rye-grass	5
		Perennial Rye-grass 33 %	10
		Timothy	18
Permanent Grasses	{	Cocksfoot	10
		Meadow Fescue	10
		Meadow Foxtail 34 %	3
		Smooth-stalked Meadow-grass	7
		Crested Dogtail	4
		100	

On heavier soils the Alsike clover, perennial rye-grass, Timothy and meadow foxtail should be increased and the other plants decreased correspondingly. Rough-stalked meadow-grass should be added.

On dry soils the Timothy and meadow foxtail should be decreased, and tall oat-grass and golden oat-grass should be added to the mixture.

For six year leys the amount of space allotted to red clover should be reduced, and a corresponding area given to the Alsike and white clovers.

B.—Mixtures for Permanent Pasture.

In mixtures for permanent pastures, Italian rye-grass should be

left out altogether; perennial rye-grass should be allotted not more than 5 per cent., red clover not more than 10 per cent., and timothy not more than 15 per cent. of the total area. Moreover, on account of the tufted coarse habit, cocksfoot should not be allowed to usurp more than 15 per cent. of the ground, and especially so if the pasture is to be mown.

Typical Mixture of this class for use on good average loams.

		Percentage of ground covered by each species.	
Clovers	{	Red Clover	5
		Alsike 20%	8
		White Clover	7
Short-lived Grasses	{	Perennial Rye-grass 20%	5
		Timothy	15
		Cocksfoot	10
		Meadow Fescue	20
		Meadow Foxtail	8
Permanent Grasses	{	Smooth-stalked Meadow- Grass 60%	7
		Rough-Stalked Meadow- Grass	5
		Crested Dogstail	5
		Hard Fescue	5
		<hr style="width: 100%;"/>	100

On heavy soils the meadow foxtail, and rough-stalked meadow-grass should be increased, and the hard fescue and smooth-stalked meadow-grass decreased.

On light soils, tall oat-grass, golden oat-grass, bird's-foot trefoil, and kidney-vetch should be added, and the timothy, rough-stalked meadow-grass, alsike clover, and red clover decreased. Meadow foxtail should be left out altogether on dry soils.

4. **Weight of Seed to be used.**—After deciding upon the

species of plants to be employed for a particular 'ley,' and the amount or area of the ground to be covered by each, it is necessary to calculate the *weight* of seed required to cover the ground to the desired extent before the actual sowing can be carried out. This can readily be done if the weight of seed of each species necessary to sow an acre completely, is known; for suppose it has been ascertained that 20 lbs. of cocksfoot seed is sufficient to sow a complete acre, to sow say 15 per cent. of this area will require $\frac{15}{100}$ ths of 20 lbs., that is, 3 lbs. of seed.

Below is a table giving the number of pounds of seed of each species of grass and clover necessary to sow one acre, the sample of seeds assumed to be absolutely pure and of 100 per cent. germination capacity.

The table is based on the assumption that 5,000,000 of the larger grass and clover seeds are sufficient to sow an acre, that is about 115 per square foot; but in the case of the smaller seeds such as sheep's fescue, timothy, the meadow-grasses, Alsike and white clovers, it is assumed that 10,000,000 are needed to cover an acre (about 230 per square foot) sufficiently.

Where the seeds are not pure and the germination capacity is less than 100 per cent., the number of lbs. required to give the necessary 5 or 10 million plants will be greater than that given in Column III. of the above table. The correction for purity is, however, easily made by multiplying the number of lbs. indicated in column III. of the table by 100, and dividing by the percentage purity of the particular commercial sample used; the correction for germination capacity is made in a similar manner, by multiplying by 100 and dividing by the figure representing the percentage germination capacity of the sample. Thus, if the sample of Alsike clover we are using is of 98 per cent. purity and 95 per cent. germination capacity, the number of lbs. necessary to sow an acre will be not 17 lbs. as the table states, but $17 \times \frac{100}{98} \times \frac{100}{95} = 18\frac{1}{4}$ lbs.

Many authorities consider it necessary to add 50 per cent. to the weights calculated from column III. of the table when

permanent mixtures are being formed, to allow for imperfections in the seed-bed, season, and other causes which tend to prevent proper germination, and kill off seedlings before they are established. Column IV. gives the weights to be used in such cases. While we consider that an addition of seeds beyond those deduced from these figures sometimes pays for the increased outlay, especially when laying down permanent pasture, we are convinced, from practical experiment and observation, that the quantity of seed recommended by most seedsmen is much greater than necessary where good seed is employed.

I.	II. Approximate number of well-grown seeds in a pound.	III. Number of pounds of pure seed, (100 per cent. germinating capacity) to sow an acre.	IV. 50 per cent. added to figures of column III.
Sweet Vernal-grass (<i>Anthoxanthum odoratum</i> L.)	750,000	13	19½
Meadow Foxtail (<i>Alopecurus pratensis</i> L.)	800,000	12½	19
Timothy (<i>Phleum pratense</i> L.)	850,000	12	18
Tall Oat-grass (<i>Arrhenatherum avenaceum</i> Beauv.)	160,000	31	46½
Golden Oat-grass (<i>Trisetum flavescens</i> Beauv.)	1,500,000	6	9
Crested Dogstail (<i>Cynosurus cristatus</i> L.)	900,000	11	16½
Cocksfoot (<i>Dactylis glomerata</i> L.)	500,000	20	30
Smooth-stalked Meadow-grass (<i>Poa pratensis</i> L.)	1,600,000	6	9
Rough-stalked Meadow-grass (<i>Poa trivialis</i> L.)	2,000,000	5	7½
Wood Meadow-grass (<i>Poa nemoralis</i> L.)	2,000,000	5	7½
Meadow Fescue (<i>Festuca pratensis</i> L.)	220,000	23	34½
Sheep's Fescue (<i>Festuca ovina</i> L.)	600,000	17	25½
Hard Fescue (<i>Festuca duriuscula</i> L.)	550,000	18	27
Perennial Rye-grass (<i>Lolium perenne</i> L.)	180,000	28	42
Italian Rye-grass (<i>Lolium italicum</i> A. Br.)	240,000	21	31½
Red Clover (<i>Trifolium pratense</i> L.)	220,000	23	34½
Alsike Clover (<i>Trifolium hybridum</i> L.)	600,000	17	25½
White Clover (<i>Trifolium repens</i> L.)	650,000	15	22½
Black Medick (<i>Medicago lupulina</i> L.)	300,000	17	25½
Kidney-Vetch (<i>Anthyllis Vulneraria</i> L.)	180,000	28	42
Bird's-Foot Trefoil (<i>Lotus corniculatus</i> L.)	400,000	13	19½

The *weight* of seeds needed for the permanent pasture mixture on page 546 is as under :—

		Percentage of ground covered by each species.	Weight of pure seed 100 per cent. germination capacity required per acre.		
			(i) Deduced from column III. of table on page 548.	(ii) Deduced from column IV. of table on page 548.	
			lbs. ozs.	lbs. ozs.	
Clovers	Red Clover	20 %	5	1 2	1 11
	Alsike Clover		8	1 6	2 1
	White Clover		7	1 0	1 8
Short-lived Grasses	Perennial Rye-grass	20 %	5	1 6	2 1
	Timothy		15	1 13	2 11
Permanent Grasses	Cocksfoot	60 %	10	2 0	3 0
	Meadow Fescue		20	4 10	6 15
	Meadow Foxtail		8	1 0	1 8
	Smooth-stalked Meadow-grass		7	0 7	0 10
	Rough-stalked Meadow-grass		5	0 4	0 6
	Crested Dogstail		5	0 9	0 13
	Hard Fescue		5	0 14	1 5
		100	16 7	24 9	

5. While it is of the first importance to start with a well-selected and well-proportioned mixture of grasses, it must be remembered that the sowing and after management of permanent pastures need the most careful consideration. It is exceptionally easy to ruin a good piece of grass by neglect of manuring, by stocking the grasses with sheep in the first season of growth, or by understocking or overstocking the land when well-established, and in many other ways.

The art of grazing, in which is involved the careful observation of the growth of the various grasses, and judgment in judiciously shifting and mixing the stock at different seasons,

is one which is only mastered thoroughly, after much experience and thought.

Probably the safest method of establishing grasses for permanent pasture is to mow the first season after sowing, stock with young cattle the second and third, allowing sheep to graze upon it only after the autumn of the third season or later.

PART V

WEEDS OF THE FARM.

CHAPTER XLII.

WEEDS : GENERAL.

1. **ALTHOUGH** it is difficult in a few words to explain what a weed is, so far as the farmer is concerned it may be described as any plant whose growth interferes with that of the crop to which the soil for the time being is devoted. The idea of uselessness is always present in the mind when weeds are being spoken of. The plants themselves, however, may be those which are ordinarily grown on a farm, but the fact of their occurrence where they are not needed condemns them. Very often shed seeds of oats and black mustard make their appearance in a crop to its detriment, and tubers from a crop of potatoes or artichokes left in the ground may occasion trouble, and require to be treated as weeds in the following year. Useful fodder grasses may overrun and reduce the value of a clover, sainfoin, or lucerne ley.

Cultivated plants out of place have been named *relative weeds*, in contrast with those plants which possess no apparent value to the farmer and are injurious to all crops among which they occur. The latter are termed *absolute weeds*, and to this group belong thistles, bindweed, docks, poppy, and a very large number of native wild plants, which, although in Nature's great collection of living things no doubt perform some useful work, are nevertheless, from the farmer's special point of view, practically without any appreciable value.

2. **Their injurious effects.**—There are a great many ways in

which weeds are harmful, the chief among which are stated below.

a. All weeds take up space which should be occupied by useful plants, and in this way generally reduce the yield which the farmer expects to obtain from his crop. They moreover throw the crop into shade, as well as prevent the access of adequate heat and fresh air for its satisfactory growth. This is sometimes seen even among cereals, where annual weeds are abundant. The effect is that the crop becomes etiolated, the stems of the plants are drawn up and weak, and liable to fall over or "lodge" at a later date. The tillering of cereals, which is dependent to some extent upon the access of light to the young plant, is also checked.

The injurious effects due to the prevention of proper access of air, heat, and light by weeds is, however, seen most markedly where they compete with the slow-growing root crops—carrots, mangolds, and swedes—and with some of the most valuable leguminous fodder plants, such as lucerne and sainfoin. In the latter and many other useful plants germination is slow and protracted, and the seedlings during early life make little progress in stem and leaf development. In a foul seed-bed the plants are rapidly smothered by weeds, and the crops are liable to suffer a check which they may never properly survive.

In the case of rapid-growing crops, such as rape or vetches, where the leafage of the plants is considerable, weeds are kept in abeyance to some extent.

The amount of damage done depends upon the habit or manner of growth of the weeds. Some of them, like groundsel, shepherd's-purse, charlock, and poppy, grow upright, straight from the soil. Others creep more on the surface, and with their stems and broad leaves effectually occupy considerable areas which should belong to the crop. To the latter class belong plantains, docks, buttercups of various kinds, and it only requires a glance at a single plant of dove's-foot cranesbill in a

white clover ley, or a well-developed plantain on a lawn, to appreciate the extent of damage done by plants of this character.

Weeds such as small bindweed (*Convolvulus arvensis*, L.) and black bindweed (*Polygonum Convolvulus*, L.) wind round and climb up the stems of any plants in their neighbourhood in order to place their leaves in a favourable position in regard to light and air. In doing so they often press the leaves of the plants supporting them closely to the stem, and thus prevent the proper development of the crop. Corn crops are often seriously damaged in this manner, and not infrequently osiers and raspberry canes are injured in the same way.

Many weeds use various crops as supports, but do not wind round them as the bindweeds do. Some of them, such as tares, climb by means of tendrils, while others, cleavers for example, are covered with stiff-hooked hairs, which enable them to climb and expose their heads to the light. The weaker-stemmed crops, such as cereals, are often pulled to the ground by the weight of those climbing and winding weeds.

b. Weeds not only screen off light and air, but they utilise and consequently deprive the crop of various important manurial constituents which would find their way into it if the weeds were not present. The analyses of weeds of various kinds often show a specially high percentage of potash and phosphates, and there is little doubt that with their extensive root-system they collect a considerable proportion of the manures which are applied to the soil but not intended for their benefit. Perhaps this robbery of fertilising constituents is of little practical moment, but plants of all kinds take up very considerable amounts of water from the soil and transpire it into the air; the ground thus becomes comparatively dry. Where weeds are present they compete for the water-supply of the soil, and reduce the amount available for the crop. In this manner they are responsible for the stunted character and reduced yield of crops overrun by them.

The reduction of yield due to the presence of weeds may reach 50 per cent.

Ex. 270.—Select a foul piece of ground two yards square and prepare a seed-bed. Divide it into two equal halves and sow about 500 grains of barley or wheat in drills 8 inches wide. When the plants are well above ground make both halves alike in the number of plants which are upon each. Allow weeds to grow on one half and carefully pick out all weeds by hand from the other. When ripe count the number of stems and weigh both grain and straw on each small plot, and observe the improved yield where the weeds have not been allowed to compete with the crop.

Similar experiments should be carried out with potatoes, carrots, mangolds, and turnips.

c. In spite of hoeing and weeding, a large variety of weeds are harvested with the cereals, and their seeds become mixed with the grain when the crops are thrashed. The presence of weed seeds in samples of all kinds reduces their market value, as the purchaser naturally objects to pay for what he does not require, and he often lays stress upon the slightest impurity and magnifies it in order to obtain a reduction in price. The miller buying cereals considers not only the actual bulk of impurity as a feature to be avoided, but has to bear in mind, in the case of wheat samples, the injurious effect which weed seeds frequently have on the colour of the flour. The testa and pericarp of many impurities are black, or nearly so, and, when ground with the wheat, darken the colour of the flour obtained. Those specially avoided by the miller on this account are seeds of corn-cockle, wild and cultivated tares, and black bindweed.

Moreover, the contents of some seeds, such as tares, melilot and crow-garlic, communicate to flour an objectionable taste or an offensive odour.

The farmer purchasing for seeding purposes has to keep in view the possible danger of spreading over his field various weeds which the samples may contain, and the price he is prepared to pay for the latter is very low when foreign seeds are present in them.

In the chapter on "Farm Seeds," the chief impurities of commercial samples of the seeds of grasses, clover and fodder plants are noticed. The seeds sometimes occurring in samples of the cereals which need special mention, in addition to those just alluded to, are charlock, wild oat, cleavers, shepherd's-needle, various species of annual brome-grasses and darnel.

In the present high state of perfection of cleaning and dressing machinery, samples of the cereal grains should be absolutely pure, but this is unfortunately not always the case.

d. A few weeds are parasitic upon crops of the farm; that is, instead of obtaining their food-constituents from the soil and air, they take it either wholly or in part from the plants to which they are attached. Those of the commonest occurrence are dodders, broom-rapes (p. 599), and mistletoe.

Mistletoe (*Viscum album* L.) is a parasite which lives upon various kinds of trees, deriving some of its plastic food and all its water-supply and mineral food-constituents from them. By means of its green leaves it is capable of utilising the carbon dioxide of the air and producing carbohydrates, but it no doubt obtains some carbohydrates and other foods needful for its life from its host. The plants enfeeble the branches of the trees, and are indirectly injurious by allowing the entrance of insects and fungi at the swollen cankered places, which are often produced where they take root. Mistletoe is met with upon many kinds of trees, but it grows most vigorously upon poplar and apple, and it is in orchards of the latter that most damage is done by the parasite. The male and female organs are borne upon separate plants—that is, it is dioecious, some plants producing male flowers only, while others give rise to female flowers, which ultimately develop semi-transparent white berries, each containing a single seed.

The seeds, which are ripe in November and December, are distributed by birds, especially thrushes. They germinate in

April or May, and frequently contain more than one embryo. The root arising from the embryo easily penetrates the bark of an apple tree, and dissolves its way down to the young wood. After a year or two lateral roots arise on the primary root, and run between the wood and bark parallel to the surface of the branch. They are readily seen as soft bright green strands when the bark is removed. From the upper side of these lateral roots adventitious buds arise and push their way outwards, ultimately becoming young mistletoe plants, while on the lower side short roots or sinkers are sent down to the young wood to absorb water and mineral substances, which have been taken up from the soil by the roots of the apple tree. Growth is at first very slow, a three-year-old plant being only an inch or so high. After the fourth year, when the root-system is established, the mistletoe grows more vigorously.

To eradicate and diminish the attack on the trees all the berry-bearing (female) plants should be cut out of the branches while still young, as it is then easy to remove the plants completely, as the roots are not strongly developed.

Breaking or cutting off the stem is of no use, as it only stimulates the formation of more adventitious buds on the roots, and these come above the bark as a fresh crop of shoots. Where the parasite is strongly established nothing but sawing off the branch will eradicate it.

Yellow Rattle (*Rhinanthus Crista-galli* L.), Eyebright (*Euphrasia officinalis* L.), and Red Rattle (*Pedicularis sylvatica* L.) met with in meadows, and Lousewort (*Pedicularis palustris* L.) occurring on marshy ground, are common parasites, which live partially upon substances obtained by means of haustoria from the roots of other plants.

e. Another but indirect way in which weeds cause injury is by harbouring and feeding insect-pests of various kinds. For example, the turnip-flea feeds upon charlock and other cruciferous weeds, and skips from these to the turnip crop. The bean-

aphis is often present on docks and sow-thistle before it attacks the bean crop.

Weeds also serve as hosts for destructive parasitic fungi. Rust, smut and mildew live upon various grasses, such as couch, Yorkshire fog, and brome-grasses, and are transferred from these to useful crops.

f. Many weeds, *e.g.* meadow-saffron and cowbane or water-hemlock, are poisonous to stock, while others, such as ramsons, if consumed by cattle, communicate the offensive odour and taste of garlic to milk, butter and cheese.

3. **Duration of Weeds.**—The natural length of life which weeds possess is of importance, and although, as explained elsewhere, there is not always a hard and fast line of separation between annuals, biennials and perennials, the classification of weeds into these three groups is useful. The *annuals* complete their life from seed to seed in one single growing-period. Germinating in spring the seeds produce young plants which feed and grow, and ultimately sometime during the summer or autumn give rise to flowers and seeds. By the time, or soon after, the seeds are ripe the plants die, and all that is left of them in winter is their offspring in the form of seeds.

Although each individual annual weed possesses a short length of life, namely, one year or less, it usually has extraordinary power of seed production. A single poppy plant frequently bears more than twenty flowers, and each of these may produce two or three hundred seeds. Similar enormous increase is met with in groundsel, sow-thistle, campion, charlock, and practically all annuals. The total number of plants which a single specimen of these weeds is responsible for is often several hundred, and it is, therefore, readily understood how rapidly annuals overrun the ground.

The root-system of annuals is not often very deep, but it branches out in all directions near the surface of the soil; the shoots are usually furnished with many leaves, and developing

quickly, tend to smother all slow-growing crops. The ordinary methods of multiplication of annuals is by means of seeds only, and allowing them to run to seed on the land is the chief source of their continuation.

Biennial weeds take two growing seasons to complete their life. The seed placed in the ground in spring germinates, and during the first summer produces a plant with a fleshy tap root and contracted stem. The leaves on the latter lie close to the ground during the first season, and prepare a considerable quantity of food which is stored up in the tap root. The plant rests during the succeeding winter, and in the following spring the terminal and latent buds of the short stem develop at the expense of the stored food, and produce elongated shoots which bear leaves and flowers. After ripening the seeds, the whole plant dies away.

Wild parsnip, carrot, burdock, some species of thistle, and other plants are included in this class.

A large number of weeds are *perennial*. Such plants last many years, and during their lifetime may give rise to several generations of plants. Like annuals and biennials they are capable of multiplication by means of seeds, and very often possess the power of vegetative reproduction as well.

An example is seen in creeping buttercups, which, besides producing seeds, sends out runners which grow along the surface of the ground and take root at their tips. When rooted the terminal bud of each runner becomes an independent plant, capable of growth even when the connection with the parent is severed. A repetition of the process follows in the newly-established offspring and the plant thus rapidly spreads over land without the special aid of seeds. A similar method of vegetative reproduction is carried on in some instances by means of stems which grow underneath the ground and elongate and take root there. Perhaps the most familiar weeds of this class are couch, wild mint, and lesser bindweed. On

the underground stems buds arise in the axils of small scaly leaves, and break their way upwards through the soil, ultimately producing stems with leaves and flowers upon them. Each node with its bud and roots may become a separate plant when the intervening pieces of stem are cut or decay.

4. **Habit of Growth of Weeds.**—Weeds display considerable variety in their manner of growth, and careful observation of their peculiarities in this respect is of great importance, as these points must be taken into account in devising effective methods of extermination.

A large number have straight stems which rise up vertically from the ground and may be termed *erect weeds*. They usually have few leaves near the surface of the ground and many of them are annuals.

Another series are met with whose stems are too weak to stand upright, and consequently trail along the ground, at the same time branching out in all directions and covering up large areas of the surface with their leaves. Their root-system is well defined, and their stems do not take root at the nodes but merely lie flat on the ground. Such are spoken of as *prostrate weeds*. Very good examples are seen in chickweed, field madder, knotgrass and broad-leaved toad-flax. These, like the erect weeds, are generally annuals, and are readily destroyed by prevention of seeding and use of tillage implements.

Nearly allied to these so far as concerns their habit of covering the ground with stems and leaves are *creeping weeds*, and weeds with *short contracted stems*; the former have stolons or runners which take root at their tips or nodes, and the latter short stems with rosettes of leaves spread out on the surface of the ground. Typical examples of creeping weeds are creeping crowfoot and silver-weed, while the broad-leaved plantain, daisy and dandelion are representative of weeds with contracted stems. These are mostly biennials or perennials, and occasion much trouble to eradicate when well established.

Rhizomatous weeds possess creeping underground stems or rhizomes, from which arise shoots which come above ground. They are perennials and among the worst weeds of the farm. Well-known examples are couch-grass, corn-thistle, lesser bindweed and coltsfoot. Some weeds, such as lesser bindweed and climbing buckwheat, have weak stems, but are able to wind round and raise themselves by means of supports. They are termed *twining weeds*, and frequently do damage to corn and other crops by twining round them in such a manner as to prevent the proper development and exposure of their leaves to the light and air. Of somewhat similar habit are *climbing weeds*: these possess weak stems, but are furnished with hooks or tendrils, by means of which they cling to plants in their neighbourhood. Examples are seen in cleavers and wild tares. As there are no practicable means of suppressing these plants when they are fully attached to crops, they must be attacked in the early stages of development. Weeds with strong tap roots descending vertically, or *deep-rooted weeds*, constitute another fairly distinct group, representatives of which are wild carrot, ragwort, burdock, and some species of dock and thistle. Most biennials are of this nature.

5. **How Weeds are Spread.**—(a) Most weeds obtain a hold on the land by being sown in the form of seeds. All weeds are capable of producing seeds if allowed to do so, although those of annual or biennial duration are worst in this respect. The seeds may fall to the ground close to where they are grown; nearly all plants, however, have means of distributing their seeds to some distance from where they are ripened. In some instances the seeds are shot out with considerable force by means of peculiar mechanical arrangements of the parts of the seed-cases. A very large number are carried about by the wind. Small seeds, such as those of poppy, are light enough to be blown away, and many which are round roll along the ground easily; others, such as those of dandelion, groundsel

and thistle, are rendered buoyant by a ring of downy hairs (the pappus) attached to the fruits containing them. They are readily wafted long distances even by a gentle breeze. A few thistles allowed to flower and seed are soon able to stock a parish with their progeny. Seeds of grasses are often carried about by the wind.

A few weeds, such as cleavers and burdock, have hooks upon their fruits, which cling to the bodies of animals, and especially to the wool of sheep. They subsequently become disentangled and rubbed off in other localities than those in which they are grown. The hairy seeds of grasses are not unfrequently distributed over the land in the same manner.

(*b*) Besides these natural methods of weed distribution, a large number are spread over the farm by the use of impure seed. Imperfectly cleaned samples of barley, wheat, and oats are sometimes responsible for the introduction of wild oats, cleavers, charlock, and other obnoxious plants to what was previously clean land. Samples of smaller seeds, such as those of grasses and clovers, very often contain a large number of weed seeds, the chief of which are given in the chapters on "Farm Seeds."

(*c*) Another fertile source of mischief is the use of impure farm-yard and stable dung. Weeds are frequently thrown on the manure heap under the impression that the heat of fermentation and the chemical changes going on in it will destróy the germinating power of any seeds which may be present. Many weed-seeds are killed by this treatment, but a large number remain quite uninjured, and when dung containing the latter is spread on the land, weeds spring up in abundance. It must be remembered also that many plants pulled out of the ground in an immature state are capable of ripening their seed without any contact with the soil. This is particularly the case with biennials and perennials which contain rich stores of food in their thick tap roots and stems. If these are cast upon the manure heap,

numbers of their offspring are ultimately carried back to the land.

The litter used in the yards and stables often contain weeds and their seeds, which become mixed with dung. Moreover many seeds and fruits possess hard protective testas and pericarps which enable them to pass through the digestive tract of animals without injury. Dung often contains seeds of this character derived from the impure oats, hay, and other materials fed to the stock producing it.

6. **Extermination of Weeds.**—To combat weeds successfully, it is necessary to study their life-history and habit of growth ; their power of reproduction, whether by seeds or by bulbs, stolons, rhizomes, roots, and other vegetative parts ; their means of dispersal over the land ; the structure and growth of their roots and stems, and the soil most suited to their development. The more the farmer studies them, the better able is he to find out their weaknesses, and to arrange his plans for their destruction accordingly.

Weeds differ from each other considerably, and to some extent require special individual treatment : no single method of attacking them can be devised which is applicable to all cases, and the particular system of farming adopted has to be considered in carrying out any scheme for their extermination. There are, however, certain principles which are capable of being almost universally applied.

(a) Weeds should be prevented from producing seeds, and this can only be accomplished by completely destroying the plants before flowering takes place. The younger the weeds, the more easily are they subdued, and the sooner work is begun the better is the result. It is not infrequent to see ground weeded too late, and the operation having to be repeated all over again, because of seeds having been allowed to fall to the ground before the first weeding was done. Many annuals bear seeds after a few weeks' growth, and some plants, such as coltsfoot, produce flowers and

seeds before the leaves appear, and are often overlooked until the mischief is done. The prevention of seeding by cutting off the inflorescence or flower-bearing axis is not always a total destruction, as explained below. It must also be pointed out that some plants, thistles especially, are able to perfect their seed on a cut stem after it has been severed from the root, if this is not done until the flowering is well advanced, the nutritive material necessary for the ripening of the seed being already in the stem.

The prevention of the seeding of weeds should not be confined to those found in the cultivated land: it is equally important to keep weeds down on roadsides, near hedges, and on waste ground. It is very frequently noticed that the smaller the area of the fields—and consequently the more hedges—the larger the number of weeds on the fields; and this is chiefly due to the fact that weeds in the hedges are often neglected.

(*b*) Every effort should be made to avoid the sowing of weed seeds inadvertently. The use of pure seed is a matter of great importance; in fact, everything that is placed upon the land should be free from admixture with weed seeds. Special attention should be paid to the manure-heap, composts of all kinds, and the disposal of screenings, sweepings from hay-lofts, and other refuse likely to contain weeds, should receive careful consideration.

If weeds from hedges and arable ground are placed on manure or compost heaps to rot, it is more satisfactory to apply such manure to grass land rather than to arable ground, as in the former case the seedlings are rapidly crowded out by the established pasture plants with which they must compete. Many weeds are rarely or never seen except on arable ground, and it would appear that certain conditions necessary for their existence are not present in ordinary pasture.

Destruction by fire, however, is the most perfect method of disposing of weeds, and should be adopted wherever possible,

or where there is any doubt about their complete destruction by other means.

(c) Seeds already shed by weeds may be attacked in two ways :

(i) They may be encouraged to grow by carefully preparing a seed-bed suitable to their germination, and, when the plants are up a few inches high, destroy them with the plough, grubber, hoe, or harrow. This treatment gets rid of immense numbers of plants, especially annuals and perennials.

(ii) The seeds may be buried deeply with the plough, so that they are unable to obtain sufficient air for their proper germination. Under these circumstances many seeds soon lose their vitality, and those which do germinate are either unable to produce sufficient length of stem to reach the surface of the soil, or do so with a struggle and remain in an exhausted state.

One of the chief drawbacks to the latter practice is the fact that many seeds thus buried remain in a dormant state for several years, and germinate freely whenever they happen to be brought to the surface by subsequent deep cultivation. Seeds of charlock, black mustard, and brome-grasses, clover-dodder, poppy, and several other plants are liable to cause trouble in a future crop if buried in this manner.

(d) Besides the prevention of seeding and dispersal of seeds over the land, the weeds which are already in existence and which actually occupy the land must be dealt with. The following methods of destruction are of general application :—

(i) *Burial*.—Burial by the plough is sufficient to destroy most annual weeds and seedling biennials and perennials.

Established plants of the two latter classes, however, must be attacked in a different manner, as they suffer little by being covered by the soil, their stores of nutriment enabling them to push forth buds which soon develop new shoots above ground.

(ii) *Cutting*.—Cutting with various implements, such as the plough, hoe, scythe and spud, when carried out properly, kills all weeds. As indiscriminate mutilation of plants, however, is

often worse than useless, it is necessary to explain the effect of cutting various plants in different ways. When the stem of any plant is mown or chopped off above the cotyledons, the plant for the time being is prevented from flowering and seeding, and the cut-off portion usually withers and dies rapidly when exposed to the drying action of the sun and air. The portion of stem still attached to the growing root, however, suffers little, and the dormant buds in the axils of the cotyledons and lower leaves of the plant receive water and nutrient materials from the uninjured root and piece of stem which stimulate them to grow. Thus cutting off the stem of a plant frequently results in the subsequent appearance of *many* stems to take the place of the *one* removed, their vigour and number depending on the species of plant, its age, and other points.

An annual plant cut in spring in the above manner soon after germination is very much weakened, and a repetition later as soon as the lateral buds have developed into stems exhausts the plant and generally kills it.

Biennials in their first year of growth have a shortened stem, and cannot usually be mown with a scythe; if cut, however, with other implements above the cotyledons when still young, they are as readily weakened as annuals. In late summer or autumn, after one season's growth, biennials and perennials have their short stem and root stored with food, and at that period of their life are very little injured by cutting above the cotyledons. They subsequently send up several vigorous shoots instead of one.

Repeated cutting, however, ultimately kills all plants—annuals, biennials and perennials alike—by depriving them of their organs of 'assimilation,' and thus preventing them from making good their loss. Stored food becomes used up by the repeated development of buds into stems and leaves, and if the latter are removed as fast as they are formed, no further

manufacture of food is possible, and the root and piece of stem die of starvation.

Mowing or cutting should commence in spring as soon as young shoots appear, and should be repeated whenever fresh shoots show themselves. It is useless to wait till summer or autumn; the plants by that time have expanded their leaves, and already prepared and stored a large amount of food in their fleshy tap root and root-stock, or in their seeds.

If instead of cutting above the cotyledons, annuals and biennials are cut below them, across the hypocotyl or across the root, the severed parts die almost immediately. The formation of buds upon the roots of such plants rarely takes place. Most species of thistle, cut below the "black knot" or cotyledonous portion of the stem, as well as wild carrots, parsnip and other plants, are thus readily exterminated, whereas cutting above this point only increases the number of their shoots.

With perennial plants it is usually different, as the underground parts of these plants are often stems with buds upon them and not roots. Once cutting these, either above or below ground, is therefore useless, and even where the true root can be severed from the stem the plants are not always destroyed, as the *roots* of certain perennial weeds, notably docks and dandelions, readily give rise to adventitious buds.

Ex. 271.—In summer dig up a dock root and cut it into pieces about an inch long, and plant them in the ground or in a pot filled with garden soil. Do the same with a young carrot or parsnip root, and observe the difference between the pieces when dug up after a fortnight's growth.

The cutting of weeds on arable land is generally accomplished by means of the plough, hoe, cultivators and other implements, and these can be made to exterminate annuals and biennials, but perennials, such as couch, bindweed, coltsfoot, nettles and docks, whose stems and buds are usually below ground, cannot be destroyed by them. To merely cut such plants in this manner only makes matters worse, as each piece of stem with its

bud is furnished with roots and develops into a separate plant, and the movement of the implement distributes them over the field.

Ex. 272.—Repeat Ex. 271, with portions of the underground parts of couch grass, mint, and stinging nettle.

On pasture and meadow the cutting is done with the scythe and spud. Much can be accomplished by a judicious and thoughtful application of these implements, and many kinds of obstinate perennial weeds can be abolished by their aid.

Depasturing with certain kinds of stock is a means of keeping weeds in check. Close feeding with sheep is practically equivalent to cutting the plants, and many *Compositæ*, such as yarrow and ragwort, are kept down or destroyed in this manner as well as a large number of other weeds.

(iii) *Total Removal of the Plants.*—The most complete eradication of weeds is brought about by the actual removal of each plant as a whole.

Annuals and biennials are usually destroyed by the methods previously mentioned, and it is only necessary to resort to total removal of these plants in special cases—for example, charlock and thistle in a cereal crop—where seeding must be prevented at all cost in order to prevent future trouble, and where cutting with the scythe or hoe is not feasible. Perennials, however, must always be completely removed out of the ground if complete freedom from their presence is required.

They may be taken out of the ground by various means, hand pulling, digging up with spade and fork, and loosening with plough, hoe, or similar implements, followed by subsequent collection with harrows, are the methods usually adopted.

(e) The draining of land always makes an alteration in the character of the vegetation upon it.

Undrained marshy land or ground, with a superabundance of stagnant water in it, has its own particular flora, among which sedges, rushes, equisetums or horsetails, and other useless plants

are prominent members. Such weeds, by their peculiar anatomy and physiological powers, are adapted to live in acid and water-logged soils with poor aeration and abundant supply of water. A removal of the latter conditions makes the ground unfit for their growth. All British cultivated farm plants require thoroughly aerated soil and an absence of stagnant water for their satisfactory cultivation; draining of wet arable land makes a vast improvement in the yield of the crops to be obtained from it, and exterminates many troublesome weeds such as those mentioned above.

The draining of marshy pastures and damp meadows removes from them many weeds which cannot practically be annihilated in any other way.

(f) The application of manures and various other substances to the ground makes a difference in the vegetation of a field.

Nitrate of soda, for example, stimulates leafy growth of the grasses, and the latter then choke out many plants which are not so much influenced by it. A dressing of lime often improves the growth of the leguminous portion of the flora of a meadow or pasture, and checks many useless plants. Many mineral manures are employed to reduce weeds; those acting most beneficially for the purpose are common salt, lime, gypsum, superphosphate of lime and basic slag.

It is almost impossible to apply any substance to the surface of grass land without making some alteration in the component vegetation, and it is important that careful observations should be made upon this subject by farmers.

Ex. 273.—Separate plots of old pasture land, about $\frac{1}{8}$ of an acre in area should be manured with 3 cwt. nitrate of soda, 6 cwt. superphosphate of lime, 10 cwt. basic slag, and 1 ton of lime per acre respectively, and the effect upon the nature of the herbage noted. Comparison to be made with a similar plot untreated.

Note the prevalence of coarse or fine grasses, clover, and other plants.

CHAPTER XLIII.

WEEDS : SPECIAL.

It is not necessary or possible in a general text-book to give an account of all the weeds met with in this country ; to do so would be to write a flora of the British Isles, as almost any plant may become a weed in localities where its favourable development is secured, and occasionally plants prove troublesome which are usually rare or very locally distributed. A few of the more widely distributed weeds of very common occurrence on nearly all farms are however sufficiently important to need special mention. For more detailed descriptions of the plants the student is referred to Babington's, Bentham's, or Hooker's Floras of the British Isles. Although some weeds infest arable ground and pasture alike, many are confined almost exclusively to one or other of these two classes of land, and it is convenient and useful to arrange them accordingly.

I. Weeds of Arable Ground.

RANUNCULACEÆ.—**Creeping Crowfoot** (*Ranunculus repens* L.).—A fibrous-rooted perennial “buttercup” with strong leafy stolons or runners ; leaves three lobed, the segments toothed or lobed also. The flower stalk is furrowed and calyx erect and hairy. The fruit is a collection of achenes, each similar to Fig. 226. It is introduced in seeds, especially clover and ryegrass samples, and spreads rapidly by means of its runners.

Corn Crowfoot (*R. arvensis* L.).—An erect annual of corn fields, with pale yellow flowers. The achenes are large and covered with hooked spines, and are often met with as an im-

purity in samples of unmilled sainfoin seed and badly cleaned cereals.

PAPAVERACEÆ.—Poppies.—Very common annuals with deep tap roots, pinnatifid leaves and scarlet flowers.

There are three or four common species in corn-fields distinguished as follows:—

(i) *With smooth seed-capsules.*

Common Red Poppy (*Papaver Rhæas* L.).—The flower stalks have spreading hairs on them, the seed capsule is smooth, and about as long as it is broad.

Long Smooth-headed Poppy (*P. dubium* L.).—The hairs on the flower stalk are pressed closely to it; the capsule is smooth, but two or three times as long as it is broad.

(ii) *With rough seed-capsules.*

Round Rough-headed Poppy (*P. hybridum* L.).—The flowers are 1 to 2 inches in diameter, with a black spot at the base of each petal. The capsule is roundish or ovoid with spreading bristles.

Long Rough-headed Poppy (*P. Argemone* L.).—The seed capsule is similar to that of *P. dubium*, but rough with hispid bristles. This species has small pale red flowers, the petals of which are marked with a black spot at the base.

The seeds are small and many of them liable to lie dormant in the soil for several years, springing up whenever the season is favourable. On this account poppies are difficult to abolish completely when once allowed to seed. Damp wet weather in spring helps the germination of the seeds, although the plants flourish best in hot seasons. Good dressings of manures aid the crops to choke them; constant hoeing, the use of pure seed-corn, and judicious fallowing of the land diminish their numbers.

FUMARIACEÆ.—Common Fumitory (*Fumaria officinalis* L.).

—An annual plant, growing about a foot to eighteen inches high, with much divided leaves and raceme of rose-coloured irregular flowers. Very common in corn crops on light sandy soils all over the country.

CRUCIFERÆ.—Charlock, Kedlock, Kilk, Wild Mustard (*Brassica Sinapis* Vis. = *Sinapis arvensis* L.).—The name charlock is given to a number of different plants, often indiscriminately to all weeds having yellow cruciate flowers similar to those of white mustard; even the latter plant is sometimes not recognised when it appears in another crop, and is promptly named charlock.

Charlock and its allies are troublesome weeds on light soils, and especially calcareous loams. Though an annual like poppy its eradication is very difficult if once allowed to seed, which happens on overcropped land, the proper cleaning of which is neglected.

If the ground is seeded with it, harrow and roll when dry to pulverise the soil and thus encourage it to germinate. When an inch or two high the plants may be hoed up and the ground prepared for a second crop, which should be treated in the same manner.

Numbers of young plants are destroyed by the constant use of harrows and hoes, and the growth of crops, such as roots and potatoes, which allows the ground to be cleaned for a longer period than when corn crops are grown, is to be specially considered.

The weed should never be allowed to seed in corn crops, but should be pulled up by hand before the seed ripens, as if left till the corn is cut much of it is shed and the ground thus kept supplied with the pest. Cutting or pulling off the flowers by hand or machinery when they are seen above the young crop is not an effective method of destruction, since many of the lower branches of the inflorescences are often missed and these produce sufficient seed to keep the weed on the farm.

Spraying with a 2 per cent. solution of copper sulphate, or a $7\frac{1}{2}$ per cent. of ferrous sulphate, is said to destroy charlock among young cereal crops without injuring the latter. The spray should be applied at the rate of 30 or 40 gallons per acre in

May or June, when the charlock plants are small. The crop should be dry at the time of application, and for success no rain should fall for at least twenty-four hours afterwards.

Shepherd's-Purse (*Capsella Bursa-pastoris* Moench.).—An erect annual with tap root and a rosette of spreading pinnatifid leaves close to the ground. The upright branched stem bears racemes of small white flowers, and triangular or obcordate flat "pods." Common on all light cultivated land and waysides; often attacked with white rust fungus (*Cystopus candidus*).

Wild Radish, Jointed Charlock, Runch (*Raphanus Raphanistrum* L.).—Similar in habit to charlock (see page 384) and to be dealt with in the same manner.

CARYOPHYLLACEÆ.—**Bladder Campion: White Bottle** (*Silene inflata* Sm.).—An erect perennial, recognised by its white flowers and bladder-like calyx; the latter has a fine network of violet veins. The stem is two or three feet high, smooth, and the whole plant ashy grey in colour.

White Campion (*Lychnis vespertina* Sib.).—An erect biennial (?) with conspicuous white flowers scented in the evening. The upper parts of the plant near the joints and flowers have sticky hairs upon them.

Red Campion (*Lychnis diurna* Sib.).—Perennial: very similar to the last, but possesses pink flowers.

The campions have opposite leaves, and their seeds, in shape like a curled up hedgehog (3, Fig. 199), are very often present in samples of clovers and Timothy grass seeds (see page 646). They thus are liable to appear in the clover and grass leys as well as in corn.

Corn Cockle (*Agrostemma Githago* L. = *Lychnis Githago* Scop.).—An annual reaching a height of 3 or 4 feet in corn, with long, narrow opposite leaves; the flowers, over an inch in diameter, have broad pale purple corollas and the sepals of the calyx are narrow and longer than the corolla. The capsule is large, and contains about forty rough, black seeds; the latter, which

resembles 3, Fig. 199, in shape, are about the size of wheat grains and difficult to separate from them when wheat and cockle are thrashed together. The black testa discolours flour, and the contents of the seed are poisonous.

The use of pure seed and good tillage diminish it.

Chickweed.—Several plants are known by this name, the commonest one on arable ground and in hop gardens being common chickweed (*Stellaria media* Vill.), characterised by having a single line of hairs running along the stem between each pair of leaves. All are annuals with short procumbent stems and small white, star-like flowers covering the ground. They are abundant seeders, even at low temperatures, but more unsightly than of serious import to the farmer.

Corn Spurrey (*Spergula arvensis* L.).—An annual from 6 to 12 inches high, with small white flowers. The slender leaves are cylindrical, almost like stems, from 1 to 2 inches long, and in whorls at the swollen nodes of the stem. The whole plant is covered with clammy hairs. It grows chiefly on sandy, stony ground, and from its rapid growth, if seeds are abundant in the soil has a serious smothering effect on all spring and summer sown crops. It is best got rid of by preparing a fine tilth in which the seeds germinate, and subsequently destroying the young plants by means of the harrow.

RUBIACEÆ—Cleavers, Cliver, Hariff, Goose-grass (*Galium Aparine* L.). An annual with weak straggling stems, 3 to 4 feet long, covered with small hooked prickles, which enable it to cling to and use neighbouring plants as supports. The narrow leaves are arranged in whorls of six or eight together. The fruit, which is covered with hooks, is very hard and double, each half being round and containing one seed, and the plant is commonly met with in hedges, and is one of the most objectionable weeds among corn crops on lightish loams and deep open soils. It is rarely seen on heavy land.

Ordinary methods for the destruction of annuals should be

adopted with this weed, and especial care should be taken to prevent its introduction in seed-corn and stable or yard dung. In some of the worst cases we have seen the weed was brought to the farm by dung containing the seeds.

COMPOSITÆ—Coltsfoot (*Tussilago Farfara* L.)—A perennial with thick stems growing horizontally at considerable depths under ground. In early spring—March and April—stems bearing scaly bracts come above ground, and carry at their tips a yellow head of flowers resembling a large yellow daisy. The leaves in shape are like the sole of a colt's foot, with downy undersurfaces. They appear after the flowers, sometimes not until the latter have ripened their seeds and the wind dispersed them. This weed is chiefly met with on damp stiff clays or moist chalky clays. Seeding should be prevented, and the habit of flowering before the leaves appear needs special attention, as it is the reverse of what usually happens.

The leaves of the established plants should be cut off as soon as they appear, and the process repeated several times with any fresh ones which arrive later. In this way the plant may be exhausted in one or two seasons.

Draining is an efficient remedy, and digging up the plant, taking care not to leave any pieces in the ground, exterminates it, although the latter process is almost impracticable when it is thoroughly established, as the depth to which it penetrates is often 2 or 3 feet.

Stinking Mayweed, Stinking Chamomile (*Anthemis Cotula* L.)—An annual plant with daisy-like heads at the ends of long furrowed stalks. Among the flowers on the receptacle are scaly leaves. It grows about 18 inches high, and possesses finely divided, bipinnatifid, smooth leaves, which give out a fetid smell, especially when bruised. Both this weed and the next occur in corn fields and waste places, and may become troublesome if allowed to seed freely.

Scentless Mayweed (*Matricaria inodora* L.) much resembles

the last in general appearance, but possesses only a slight odour, and the receptacle is without scales.

Corn Marigold (*Chrysanthemum segetum* L.).—An annual growing about a foot or eighteen inches high, with yellow flower heads resembling the single common marigold of gardens, about $1\frac{1}{2}$ or 2 inches across. The upper deeply serrated or lobed leaves partially clasp the stem, the lower ones have petioles, and are pinnatifid. The stem and leaves are smooth, and have an ashy-grey surface.

The thin flat "seeds" blow about from field to field, and are apt to lie dormant for some time, as charlock seeds do. Clean seed-corn and hand-weeding, coupled with ordinary tillage, reduces it.

Groundsel (*Senecio vulgaris* L.).—A very common annual on cultivated and waste ground. From 6 to 12 inches high, its stems are furrowed and bear half-clasping pinnatifid leaves. Its flower heads are composed of a number of small yellow flowers which ripen quickly and are distributed by the wind. Each plant keeps on flowering during several months of the year, and it is usual in spring and summer to find heads in all stages of development upon the same plant.

Cornflower, Corn Bluebottle, Hurt-sickle (*Centaurea Cyanus* L.).—An annual or biennial, now frequently grown as an ornamental plant in gardens, from 1 to 3 feet high, with entire narrow, lanceolate leaves, which are cottony beneath. When old the stems are hard. The flower heads have an outer spreading ring of bright blue flowers, and ultimately produce oval fruits which are crowned with a ring of short orange-coloured bristly hairs.

Creeping Thistle, Corn-thistle (*Cnicus arvensis* Hoffm.).—A perennial with a deeply-seated underground stem, which grows horizontally and sends out shoots upwards into the air. The latter are from 2 to 4 feet high, and bear leaves which are lanceolate, very spinous, and wavy at the edges. The stem has

no broad wings running down from the leaves ; flower heads oval with light purple flowers.

The fruits, sometimes named "seeds," contain a single seed, and are surmounted by a number of silky hairs (thistle-down), as at 3, Fig. 148. It appears to grow on all soils, but is most difficult to eradicate from those of very loose nature.

Sow - thistle, Milk - thistle (*Sonchus oleraceus* L.).—An annual with tap root and erect branched stem bearing pinnatifid toothed clasping leaves. The flower heads have yellow flowers and smooth involucre. Another very similar species is *Sonchus asper* Hoffm.

Corn Sow-thistle (*Sonchus arvensis* L.).—A perennial with creeping underground stem. The shoots above ground grow 3 to 4 feet high. The flower heads are yellow, but larger than the preceding species, and their involucre are hairy.

These three thistles are common on arable land and waste ground, and like all others are rapidly spread by means of their feathery-tipped fruits, which are specially adapted to be blown about by the wind. Two of them are perennials, and are also propagated by means of their underground stems.

Seed production should be prevented. If cutting off the stems is adopted for this purpose, it is essential that it should be done before flowering if possible, as when left till later the shoots are often able to ripen their seeds when severed from the root.

It is very important to bear in mind that the remedies employed to prevent the seeding of thistles should be applied to them not only on cultivated land, but on all waste land as far as possible, as it is from the latter source that most of the continuous supply of young plants infesting good ground is derived. Hand-pulling or cutting below the hypocotyl is an efficient remedy in the case of the annual species. In order to exterminate the perennials absolutely, the complete underground stem must be destroyed. They are, however, checked by hand-pulling, but as they cannot be completely removed in this manner, the pieces

of stem left in the ground shoot again, and the work must be repeated until they are weakened and finally exhausted altogether. Hand-pulling is most effective after rain, as the plants come up easier and more completely then. In corn crops the practice should be carried out in May, and again later in the season to avoid missing the seedlings, which might be overlooked when very young.

Nipplewort (*Lapsana communis* L.).—An annual plant with milky juice and branched stems bearing numbers of small dandelion-like yellow heads of flowers. The lower leaves are thin lyrate-pinnatifid, the upper ones entire. The fruits are pale brownish-yellow (6, Fig. 199), and often occur as an impurity in clover seeds. It is common on cultivated and waste ground.

CONVOLVULACEÆ. — **Bindweed, Bearbine** (*Convolvulus arvensis* L.).—A perennial with a creeping underground stem, which descends considerable depths in light soils. The thin stems appearing above ground twine spirally round neighbouring plants. The leaves resemble an arrow head in form (sagittate or hastate). The flowers are bell or trumpet shaped, about an inch in diameter, white and pink.

It is one of the worst pests of agriculture, and on light sandy ground seriously damages corn crops when present in abundance. The seeds which are poisonous to stock are produced in roundish capsules, four seeds in each. It is practically impossible to prevent their formation and ripening when the plants are established and the stems wound round those of the crop.

The weed, however, is chiefly spread by its rhizomes, which sometimes descend so deeply as to be outside the reach of ordinary tillage implements. Deep-ploughing and collecting with harrows is useful, and forking out the weeds when they occur in small patches can also be adopted with success. Continuous use of the hoe as soon as the shoots appear above the surface cripples the plants, and with perseverance the pest may thus be destroyed or at any rate kept in abeyance.

Clover-Dodder (*Cuscuta Trifolii* Bab.) is a formidable enemy when once established. It is met with chiefly upon red clover and lucerne, and, except for a very short time after germination, the plant has no connection with the soil. The seed which is figured on page 647 gives rise to a white thread-like seedling without leaves of any kind. It is unable to utilise ordinary manurial ingredients of the soil, and unless it meets with a clover plant, it dies in a short time. Should a clover plant be in the immediate neighbourhood, the thin seedling winds round its stem, and at points of contact protrudes roots or haustoria (suckers) which penetrate into it. After making one or two complete ring-like turns round the stem, the dodder extends its growing point, branching at the same time, and coiling itself round its victim in new positions. It spreads from plant to plant outwards in all directions, so that considerable patches become infested by it.

Its very thin stems resemble a tangled mass of coarse, reddish-yellow horse hair, and as the plant is without leaves and possesses no chloroplasts, it is unable to make use of the carbon dioxide of the air, and is compelled to depend upon ready-made food obtained from other sources. These it absorbs by means of its roots or suckers from the clover plant, and large crops may be completely destroyed by the parasite.

Dodder is an annual even when growing upon perennial plants, and produces small white bell-shaped flowers in compact clusters. The fruit is a two-celled capsule usually containing four seeds, which fall to the ground when ripe, and germinate very late in the following spring. In wet seasons the seeds seem to germinate best.

It is important that seeds of clovers containing dodder should never be sown. Continental samples often contain this impurity, but it is easily removed by proper sieves, and a guarantee that samples are free from it should be obtained from the seedsman. As soon as it is observed in a field, measures should be taken to

destroy it at once, and it should not be allowed to ripen its seed. Attempts to get rid of the pest by watering with a 5 per cent. solution of ferrous sulphate or by the application of various manures are unsatisfactory. Sometimes it is possible to cut off all the clover stems without destroying the crown of the plant attacked, but for complete extermination the infected plants should be dug out, carefully carried away, and burnt. It must also be borne in mind that small pieces left on the field may become attached to new plants, and the infection spread again.

Flax-Dodder (*Cuscuta Epilinum* Weihe) and Greater Dodder (*C. europæa* L.) occurring upon hops, nettles, vetches, beans, and other herbaceous plants, resemble clover-dodder in their manner of growth and life-history.

Other species of Dodder, such as *C. racemosa* Mart., *C. Gronovii* Willd., and *C. chilensis* K., are introduced into Europe with lucerne red clover and other leguminous seeds from North and South America. Except in the warm southern climates, they do little damage to the crops.

OROBANCHACEÆ—Broom-rape.—There are several species of Broom-rapes or Robbers of Broom met with in this country. Like the dodders they are all strictly parasitic, but attach themselves by means of haustoria to the *roots* of their hosts. The larger broom-rape (*Orobanche major* L.) lives upon shrubby leguminous plants, especially broom and gorse; the smaller broom-rape (*O. minor* Sutt.), however, is the farmer's special bane, as it feeds upon and destroys red clover. The seeds are extremely small and light, several hundred being produced from a single flower. When shed from their capsules they are easily blown about. The seedlings are thread-like, similar to those of dodder, but instead of curving upwards they penetrate the soil, although they are unable to obtain nourishment from it. It appears that only special plants can afford nourishment to the broom-rapes. If a seedling of the lesser broom-rape does not meet with a clover plant in the soil, it soon dies. On contact with the roots of red

clover, however, it attaches itself by means of a sucker, and at its free end develops a swollen and knotty tuber-like stem upon which a bud is produced. From the latter arises ultimately a thick, fleshy stem, which grows upwards through the soil, appearing above it like a pale brownish-red asparagus shoot from 6 to 18 inches in length. Upon the sides of the stem are rudimentary pointed scale-leaves, and at its summit a spike of dingy, reddish flowers which have irregular two-lipped corollas.

When once established it is difficult to eradicate before doing considerable injury to the crop, and nothing short of ploughing up the clover will exterminate the pest entirely. The seeds are very small and easily screened from clover seeds, so that all samples of the latter should be quite free from them. This unfortunately is not always the case, and only last year we saw the bad effects of sowing impure samples purchased without guarantee. If only a small patch is seen, it should be dug out and burnt. The pest should on no account be allowed to ripen its seeds.

CHENOPODIACEÆ. — **Goose-foot, Fat Hen, Meld-weed** (*Chenopodium album* L.). — An erect annual with ovate-rhomboidal lower leaves irregularly cut at the edges into blunt teeth; the upper ones are lanceolate and entire. The whole plant appears as if covered with whitish meal, each mealy particle being in reality a hair with a large round cell at its tip. The flowers are green and very small in spike-like racemes, and the seeds are black and glossy, resembling a flattened bun in shape.

This weed is very abundant on good well-manured land, and is liable to overrun root crops in particular. The seeds often lie dormant in the soil for some time, and come up when unexpected. Hoeing and hand-pulling to prevent the plants running to seed is necessary.

Spreading Orache, Fat Hen (*Atriplex hastata* L.). — An annual somewhat resembling the preceding plant, but it is generally procumbent, and the flowers are unisexual—male and

female separate. The lower leaves are more triangular than those of *C. album*, and the seeds are generally rough.

POLYGONACEÆ.—The Curled Dock (*Rumex crispus* L.) and another species (*Rumex obtusifolius* L.) occur on arable land introduced often as impurities in the clover and grass seeds used for leys. Although they flower and seed readily enough if allowed to do so, they are not spread by the wind, as their fruits do not possess any special hairy or downy appendages for this purpose, such as is met with among thistles and groundsel. The brown shining fruits are triangular (2, Fig. 199), resembling those of buckwheat, and contain one seed.

These weeds are perennial, with a strongly developed fleshy tap root, on the top of which is the bud from which arises the stem with its flowers. They are among the few plants whose roots have the power of producing adventitious buds. When cut up each piece of dock root is capable of sending forth a shoot, and thus behaves like a rhizome. Cutting below the hypocotyl, which is sufficient to destroy most biennial and perennial plants, is consequently of no avail with the docks. The latter must be pulled up and removed completely, or the roots ploughed up and the pieces carefully collected and taken off the land.

They should be prevented from seeding, and every precaution taken to secure pure seeds of the clovers and grasses sown on the farm, as these frequently contain dock seeds.

Black Bindweed, Bearbine, Climbing Buckwheat (*Polygonum Convolvulus* L.).—An annual with a fibrous root and angular twining stems: it is often confused with the more objectionable small Bindweed (p. 595), which it resembles in general habit of growth and shape of its leaves. Where the latter join the stem there are tubular membranous stipules which serve to distinguish the two plants. The flowers are very small and greenish, in clusters of four or five together, and quite unlike those of small Bindweed. The triangular fruits are dark brown or black, each containing a single seed.

This weed is common on stiff land, and is reproduced by means of seeds which are not unfrequently met with in samples of cereal grains.

GRAMINEÆ.—**Wild Oat** (*Avena fatua* L.).—A common annual with an erect spreading panicle like the ordinary cultivated oat (*Avena sativa* L.).

The flowering glume is bifid, and has a rough bent and twisted awn; the short stalk of the grain and the base of the flowering glume is covered with rich brown hairs which distinguish it from the common oat (Fig. 155)

It is met with among all the cereals, and sheds its grain before the corn crop is ready. May be exterminated by the growth of a clean root crop, and the use of seed corn quite free from it.

Brome-grasses (see p. 543).—Several annual and biennial species of those grasses are troublesome weeds in corn and grass leys generally, and are commonly distributed over the farm in impure grass seeds and cereal grains. The seeds (Fig. 221) ripen early, and when shed many remain in the ground several years without germinating. If fed in tail corn or poor hay they pass through the digestive organs of animals uninjured, and are thus often introduced into dung.

Couch, Quitch, Twitch, Scutch.—These names are applied to several grasses which have well-developed spreading rhizomes. The most common and most to be dreaded are Couch proper (*Agropyrum repens* Beauv. = *Triticum repens* L.), Bent-grass (*Agrostis vulgaris* With.), and marsh Bent or Fiorin (*Agrostis alba* L.).

The inflorescence of couch is a spike somewhat resembling an ear of wheat in structure, and is only met with on plants which are allowed to grow unmolested in hedges and waste ground. On cultivated land it is rarely allowed to flower.

The inflorescence of the two Bent-grasses are delicate, much-branched panicles; and therefore very different from those of

T. repens. Couch, moreover, has practically no ligule, and the base of the leaf blade is eared similar to that of Fig. 189. The Bents possess no eared base to the leaves, thus resembling Fig. 190, and both of them have well-marked ligules.

All these grasses are perennials and chiefly propagated by their rhizomes, which in light soils spread very rapidly and extensively in all directions. They send up leafy stems from the nodes, and these enter into competition with whatever crop is being grown.

To exterminate these weeds they must be removed as completely as possible, and to do this requires judgment and discretion in the use of implements.

Each piece of stem is capable of independent existence, so that if cut up by the plough, by harrowing when the ground is wet, or other means, the pest is multiplied and spread.

In a bad case, after ploughing in autumn or spring, the application of a heavy drag harrow brings out all the larger pieces. If the ground breaks up easily the soil may be loosened from the weed by the roller, and a light harrow then used. After being collected together, the whole should be burnt.

Before ploughing it is often a good plan to fork out all the worst patches.

EQUISETACEÆ.—**Field Horse-tail, Toad-pipe** (*Equisetum arvense* L.).—A perennial cryptogamic plant with extensive deep-lying rhizomes. Instead of seeds, the plant produces spores in a club-shaped head, and these are spread by the wind in early spring. The spore-bearing stems are short, straight, unbranched, and apparently without leaves. They come up in April, and are followed later by the taller barren stems. Upon the latter, straight branches arise in whorls, and, like the main stem, are grooved. The whole plant is rich in silica, and harsh to the touch.

It is met with on damp, wet ground, and can only live under soil conditions which prevail on such land. Drainage by com-

pletely altering the character of the soil exterminates the plant. On arable ground it can be checked by destroying the stems by ploughing and cutting, but no ordinary tillage can possibly eradicate it altogether, as the rhizomes lie too deep to be touched by farm implements.

II. Weeds of Pastures.

A very large variety of indigenous plants occurring naturally in meadows and pastures must be considered weeds. They are very various in their degrees of uselessness, some being injurious or poisonous to stock, while others are refused by animals, and of such a chemical composition as to possess little or no nutritive value. Some, again, may yield a certain amount of food to animals consuming them, but their place might frequently be taken by plants of greater feeding-value if the pasture or meadow were properly managed.

Only a few of common occurrence can be enumerated, but it should be the aim of all farmers to make a more extended study of the botanical composition of their pastures whenever opportunity offers, with a view to distinguish the various plants growing upon it, and to find methods, if possible, by means of which the valuable plants may be increased and the inferior ones checked.

The means at command to exterminate or check weeds in pastures and meadows are briefly :—

(i) Cutting with machine, scythe, or spud two or three times a year. This prevents many weeds from forming seeds, and also hinders and weakens the development of numbers of them.

(ii) Hand pulling and complete digging up.

(iii) Working with harrows, drags, and similar implements helps the decomposition of humus by allowing air and water to penetrate more freely, thus altering the acidity and other characters of the soil: the change acts unfavourably upon some weeds and reduces their vigour.

(iv) Drainage.

(v) The application of manures and other substances.

(vi) Close feeding with stock.

RANUNCULACEÆ.—**Upright Crowfoot** (*Ranunculus acris* L.).—A perennial buttercup with short thick underground stem and fibrous roots, or occasionally with an oblique rhizome, but without runners. The flower stalks are cylindrical, and the calyx is hairy and spreading.

Creeping Crowfoot (*R. repens* L.).—See p. 587.

Bulbous Crowfoot (*R. bulbosus* L.).—A perennial with a swollen bulb-like stem without runners; the flower stalks are smooth and furrowed, and the hairy calyx is reflexed back to touch the flower stalk.

These plants are known as buttercups, and are not eaten by stock in a fresh state, except perhaps in small quantities. They all contain acrid poisonous juices, especially virulent at the time of flowering, but when dried in hay they lose their injurious properties, and are then readily eaten by farm animals. The seeds of the two first-mentioned species occur in impure samples of rye-grasses (Fig. 226), and are introduced to the farm in grass and clover leys.

CRUCIFERÆ.—**Cuckoo Flower, Lady's - Smock, Bitter Cresses** (*Cardamine pratensis* L.).—An erect-growing perennial with pinnate leaves and lilac flowers, whose four petals are arranged in the form of a cross.

The plant flowers in early spring, and is prevalent in moist, undrained meadows.

CARYOPHYLLACEÆ.—Most of the Campions mentioned on page 590 occur in meadows.

LEGUMINOSÆ.—**Rest Harrow : Cammock** (*Ononis spinosa* L.).—A very variable shrubby perennial, with pink vetch-like flowers and small ovate pods containing two or three seeds.

It is common in certain localities on poor neglected lands of a dry, sandy or gravelly nature, as well as on cold clays. *O. spinosa* proper grows erect and possesses strong spines,

its dry leafless shoots resembling those of the gooseberry in winter.

A stoloniferous sub-species, known as *Ononis repens* L., has creeping stems and is without spines or nearly so. The whole plant is sticky and emits a disagreeable odour.

All forms of the plant are indicative of poverty of soil, and only improved cultivation and manuring will eradicate them.

Dyers' Greenweed : Woad-wax (*Genista tinctoria* L.), is a low shrubby perennial plant with striate stems about a foot or 18 inches high and narrow lanceolate leaves. It bears clusters of yellow papilionaceous flowers.

The plant is a pest in pastures and meadows, especially on stiff clays. A dressing of basic slag tends to check it, but it can only be effectually removed by constant cutting, digging, or pulling it out by hand.

ROSACEÆ.—Silver Weed (*Potentilla Anserina* L.).—A perennial weed with stoloniferous stems, and characteristic large interruptedly pinnate leaves. There are several pairs of leaflets with deeply serrate margins, and these are covered with fine silvery, silky white hairs, especially abundant on their lower surfaces. The flowers somewhat resemble those of buttercups.

Very common on roadsides and in damp fields.

UMBELLIFERÆ. — Wild Carrot, Birds' Nest (*Daucus Carota* L.).—A biennial with strong, hard tap root and pinnately decomposed leaves. The flowers are white, some purple, in compound umbels; the outer small umbellules curve over the inner ones, the whole inflorescence forming a cup or nest-shaped structure.

Most frequent in dry, chalky pastures and roadsides.

RUBIACEÆ.—Lady's Bedstraw, Yellow Bedstraw (*Galium verum* L.).—An erect perennial with slightly woody stems and whorls of six or eight very narrow, somewhat round leaves, which curl backwards. It bears a large number of small yellow flowers

in dense panicles. The fruit consists of two roundish, smooth, black carpels with a single seed in each.

The plant is met with in dry sandy and chalky meadows, and is said to curdle milk like rennet when placed in it.

COMPOSITÆ.—**Common Daisy** (*Bellis perennis* L.).—A well-known perennial with rosettes of spatulate leaves close to the ground on a short prostrate rhizome. The roots are fibrous.

If not very carefully done spudding tends to propagate the weed, as the branches of the short rhizome break off and become separate plants.

On closely-cut lawns and poor fields it is often abundant; on good ground the taller plants cut off the necessary light and air for its growth, and smother it. The most efficient plan of reducing it is to encourage grasses to grow by mowing seldom and by good manuring.

Ox-eye Daisy (*Chrysanthemum Leucanthemum* L.).—A perennial with erect simple or branched stems bearing a large solitary flower head, resembling the common daisy, but about $1\frac{1}{2}$ or 2 inches in diameter. The leaves are spatulate or oblong with pinnatifid margins.

The fruits or 'seeds' are ribbed (5, Fig. 199), and are a common impurity of grass seeds.

It is most frequently present on ground in poor condition: a good dressing of manure usually greatly diminishes its strength.

Butter-bur (*Petasites vulgaris* Desf.).—A perennial with extensive underground stout rhizomes. The leaves somewhat resemble those of rhubarb, and occasionally reach a diameter of 2 or 3 feet. They are covered with whitish cobweb-like down on the under surfaces. The flower heads are arranged in a cylindrical spike-like panicle, and, like those of coltsfoot, appear in spring before the leaves; the flowers are pinkish, the male and female ones generally in different heads.

Frequent in damp wet meadows, and near watercourses.

Ragwort, Ragweed (*Senecio Jacobæa* L.).—An erect perennial with stout, fleshy tap root and smooth stems, growing 2 to 4 feet high ; not cottony, or only slightly so. The leaves are pinnatifid or irregularly lobed, giving a ragged appearance to the plant. The flower-heads resemble small yellow daisies, and are massed together in a corymbose manner. The fruits blow about like those of groundsel and thistle.

Abundant in dry pastures and on waste ground when allowed to seed.

In a young state it is readily eaten by sheep, and by close feeding in early summer, before the stem becomes hard, it is kept in check and rarely seen.

When its stems have been allowed to grow up, hand-pulling after rain exterminates it.

Knapweed, Hardhead (*Centaurea nigra* L.).—An erect perennial with tough, hard, grooved stems ; the leaves are lanceolate entire, with rough stiff hairs over them. The flowers are purple and in terminal heads, which are black and hard. They somewhat resemble those of a small thistle, but are not prickly.

The plant is common in meadows and old pastures ; when in abundance it must be hand-pulled to eradicate it. Even this procedure, if done carelessly or in dry weather, is apt to leave pieces of rootstock in the ground which grow again.

Spear Thistle (*Cnicus lanceolatus* Hoffm.).—A biennial with a strong branching root and stout erect winged stems. The pinnatifid leaves join the wings of the stem and are from six inches to a foot long with long spines upon them ; they are cottony beneath. The flower heads grow at the end of the branches singly and are purple with stiff long spines on the involucre.

Cutting the first-year plants with a spud, and mowing the second-year plants before the flowers develop and ripen their seeds, exterminates this and the succeeding species.

Marsh Thistle (*Cnicus palustris* Hoffm.).—A biennial with winged upright stems, somewhat slender, 2 to 4 feet high, covered

with many fine spines. The leaves are pinnatifid, narrow and decurrent on the stem. The flower heads are small darkish purple. The whole plant has a dark purplish-green appearance. The roots are many and fibrous, spreading out just below the surface of the ground. This thistle is very widely distributed on damp pastures and marshy land throughout the country.

Dwarf Thistle, Stemless Thistle, Ground Thistle (*Cnicus acaulis* Hoffm.).—A perennial with a rosette of spiny pinnatifid leaves close to the ground; occasionally the stem grows from 3 to 6 inches high, but it is usually almost wanting. The flower heads, which are crimson, are practically stemless also, and grow singly in the centre of the rosette of leaves.

It is a frequent troublesome weed in dry calcareous pastures.

Some of the species of the thistles mentioned under the head of "Weeds of Arable Land" occur in pastures and meadows also. For methods of attacking them and descriptions, see page 594.

Cats'-ear (*Hypochaeris radicata* L.).—A perennial with rough wavy-pinnatifid leaves, spreading close to the ground as in dandelion; the stem bearing the flower heads is smooth, branched and rises about a foot high. The flower heads are yellow, and 1 or 1½ inches across, and their receptacles have small chaffy scales upon them.

Rough Hawkbit (*Leontodon hispidus* L.).—A biennial (? perennial), with leaves similar to the last. The stem bearing the flower head is, however, simple, not branched, and is rough like the leaves. There are no scales among the flowers on the receptacle.

Autumnal Hawkbit (*Leontodon autumnalis* L.).—A perennial, with leaves generally resembling the last two species in shape, but they are smooth.

The last three species of plants are common in meadows and pastures. The flower heads are similar to those of the dandelion, and like the latter weed their fruits have a stalk surmounted with a feathery crown of hairs, and are spread by means of the wind.

SCROPHULARIACEÆ.—**Yellow Rattle** (*Rhinanthus Crista-Galli* L.).—An erect annual, with stems from 6 to 18 inches high, bearing oblong-lanceolate serrate leaves opposite to each other. The flowers are irregular, with two-lipped yellow corollas and flattened bladder-like calyx. The seeds, which ripen early, are thin and flat with a membranous wing round them, and readily blown about by the wind. When ripe, they rattle or rustle in their seed case if shaken. The plant is frequent in dampish pastures and meadows, and is partially parasitic on the roots of other plants. It is not liked by stock either in dry or fresh state, although close depasturing with sheep seems to reduce it. Top-dressings of salt tend to destroy it.

LABIATÆ.—**Self-heal** (*Prunella vulgaris* L.).—A perennial, growing 6 or 8 inches high, with a square stem and creeping root stock. The leaves are entire and ovate. The flowers are purple or blueish, two-lipped and arranged in dense whorled cylindrical heads or spikes. The 'seeds' (Fig. 203) occur as impurities in clover, and therefore frequently occur in leys on cultivated ground as well as naturally in damp pastures and meadows.

POLYGONACEÆ.—**Sheep's Sorrel** (*Rumex Acetosella* L.).—A small perennial dock, usually from 6 to 10 inches high, with a branched creeping root stock. The lower leaves are hastate: the male and female flowers are upon separate plants. The fruit is a small triangular nut (2, Fig. 199) and occurs very often as an impurity in clover and grass seeds.

The whole plant is reddish in autumn, and has an acid taste at all times, due to the presence of acid oxalates.

It is abundant in dry pastures, and although not in itself a serious pest it is indicative of poor land.

Liberal dressings of manures and composts reduce it, and applications of lime or manures such as basic slag containing lime, are specially useful where it is prevalent.

URTICACEÆ.—**Larger Stinging Nettle** (*Urtica dioica* L.).--

A perennial with a creeping underground stem or rhizome. The leafy stems grow from 2 to 3 feet high, the leaves being opposite and heart-shaped, with coarse teeth, and the whole plant covered with stinging hairs. The small green flowers are arranged in knotted spikes in the axils of the leaves.

These nettles grow most luxuriantly on good land, and are difficult to extirpate in such situations. Mowing as soon as the shoots spring up in early summer, and continued later, exhausts them in time, although the most efficient method of extermination is to dig up the rhizomes completely.

LILIACEÆ.—Belonging to this Order is **Meadow Saffron** (*Colchicum autumnale* L.), a poisonous plant, sometimes abundant in certain districts in the rich moist meadows bordering rivers. The corm of the plant is about the size of a small tulip bulb. From it one or more pale purplish-pink flowers resembling crocuses are sent up in early autumn. The flowers fade in a few days and nothing more is seen of the plant until spring, when broad, upright, flat leaves, 6 to 10 inches long, are sent above ground. At the same time an oblong seed-vessel is lifted up.

Cattle are not unfrequently poisoned through eating the leaves of meadow saffron, which together with the flowers, seeds and corms, contain the alkaloid colchicine.

The plant is most virulent in a green state, or when slightly withered, but even when dry contains enough of the poisonous compound to be injurious. Experiment has shown that from 3 to 5 lbs. of green leaves and seed-vessels are necessary to act fatally upon a cow; the poison, however, appears to be cumulative and a small quantity eaten each day with other food for a few days may lead to fatal results.

Meadow saffron can be readily exterminated by pulling off the leaves by hand, as soon as they appear in spring. The destruction of the leaves should be repeated for one or two seasons, and if this practice is carefully and systematically carried out there is no need to dig up the corms.

The pulled leaves should be safely buried: the sooner the better, for cases have occurred where cattle have been poisoned by breaking into fields and eating collected leaves which had been left in heaps unburied for a night.

JUNCACEÆ.—To this Order belong Rushes represented by two genera, namely, *Juncus* and *Luzula*.

The commoner plants belonging to the genus *Juncus* are known as true rushes and are mostly smooth perennials. Generally abundant on wet undrained land, they have creeping rhizomes at very considerable depths below the surface of the ground. Even when the surface appears somewhat dry the presence of rushes indicate very wet soil, possibly 3 or 4 feet down, in which the creeping stems are growing.

In some species the round pithy stems which come above ground are utilised for thatching and are almost devoid of leaves.

The flowers are regular and starlike, brown or greenish in colour.

The three most common rushes of this class are *Juncus effusus* L., *J. conglomeratus* L., and *J. glaucus* Sibth.

They may be considerably diminished by constant mowing, but the only satisfactory means of complete extermination is thorough drainage.

The genus *Luzula* comprises the plants known as wood rushes; they are perennial plants with small brown starlike flowers like the foregoing, but have flat grasslike leaves, generally fringed with long white hairs, and are most frequent on dry soils. The commonest species is *Luzula campestris* L., often abundant in pastures and meadows. All the rushes are of poor feeding-value and unpalatable to stock.

CYPERACEÆ.—This Natural Order includes a large genus of plants known as sedges or *Carices*. They are perennial plants, with leaves resembling those of the grasses except that the leaf-sheaths are closed instead of split as in the latter. Their stems

are solid, usually angular, and, like the leaves, possessed of sharp cutting edges. They grow upon all classes of soils, from the wettest to the driest, each kind of ground having its own peculiar species. The flowers are arranged in spikelets similar to those of grasses, which they somewhat resemble. Some with glaucous leaves are known among farmers as 'carnation grasses.' Their nutritive value is small, and being commonly rejected by stock must be considered as weeds to be exterminated from pastures and meadows by draining, mowing and liberal use of manures.

EQUISETACEÆ.—Horse-tails (see page 603) are common weeds in damp pastures. Stock refuse them. If accidentally consumed in grass or hay the plants are liable to have dangerous effects.

Ex. 274.—The student should make a collection of the chief arable and pasture weeds found in his district.

He should pay special attention to the kind of soil and condition of the land—whether highly cultivated or neglected—on which they occur.

The complete plant—root, stem, leaves, flowers and fruit—should be collected in order to show the habit and general appearance of the weed.

The specimens are readily dried by first placing them between several thicknesses of blotting paper, and then laying the whole under a heavy flat-bottomed box or heavily-weighted board to press them flat.

After remaining a day thus, the paper should be changed, fresh dry papers being substituted for the old ones: after thus changing once or twice the plants will be found completely dry and ready for mounting on suitable sheets of white cardboard or thick paper.

PART VI.

FARM SEEDS.



CHAPTER XLIV.

FARM 'SEEDS': GENERAL.

1. THE term 'seed' is used ordinarily for anything which is *sown* with the object of obtaining a crop, and, in this sense we use it here, bearing in mind that many of the parts of plants used for this purpose, are not seeds in the true botanical sense of the word as explained elsewhere.

Few things required by the farmer are of greater importance than good seed, and yet it is not uncommon to find little attention paid to its selection and purchase. Bad seed leads to disappointment in many ways besides the deficient crop which often results from its use: it is frequently the indirect cause of trouble in introducing weeds, which overrun the crop and leave the ground in a foul condition; parasitic plants are also often present, and these are accountable for many of the diseases of farm crops. The expense of preparation of the land is the same, whether good or bad seed is used, and the cultivation and management of the crop, whether large or small, is nearly the same; it is, therefore, important that the best seed obtainable should be sown, as the difference in primary cost between this and seed which is doubtful, is small compared with the difference in the final results obtained from using them. The difference between the very best seed and inferior samples often amounts to little more than a shilling or two per acre, but the use of the latter may often make a difference of pounds

on the wrong side of the balance sheet at the end of the year.

'The best seed obtainable is never too good,' is a maxim which should always be uppermost in the mind when sowing is under consideration, and the danger of being penny-wise and pound-foolish should be avoided. Cheap seed is not *necessarily* bad, but it *practically* always is so, and the purchase of undoubtedly good seed at a slightly higher price than ordinary rates, is an extra expense which is always repaid in the improved crop obtained.

It must, however, be understood that high price is no guide to certainty in the matter of obtaining good seed, and, by itself, should have no place in determining the purchase of samples. Although the quality of seeds in the market has undergone great improvement during the last twenty years, good seed is still always high in price, and will remain so on account of its comparative scarcity. The temptation to purchase cheap samples of doubtful character instead of those of unquestionably high intrinsic value at a higher figure, is a very common one, and requires the most careful consideration.

There are many points to consider in the determination of the quality of seeds, and it is to these that we now turn our attention.

In some cases a rough estimate of the value of a seed may be obtained by an examination of its shape, colour, and smell, but although features of this class are always to be carefully noted, in themselves they are quite insufficient to determine the usefulness of a given sample. This method of examination, namely, the observance of various external characters of the seed, is the one most frequently employed by the farmer, but only in certain special cases where he has had large experience and constant use of the seed, and especially if his experience has been gained during frequent cultivation of the crop for seed, is this method at all efficient. It is, however, never by itself completely satisfactory, and may often lead to serious mistakes. With an

unfamiliar crop external observation of the character of the seed is frequently misleading, and at all times we must be aware of the fact that it is possible for a seed to be made to *appear* what it is not in reality.

It is necessary, therefore, to consider the various methods of testing and examining seeds, which give a certain and correct estimate of their value.

A perfect sample is one in which each individual seed present is capable of giving rise to a strong and healthy plant of the kind we desire, when placed under conditions suitable to germination. Such samples are rarely met with, and can scarcely be expected, except in special instances of hand-picked garden seeds, harvested under favourable conditions on a small scale and carefully stored. Commercial farm seeds are nearly always deficient in some of the following particulars, each of which in itself must be carefully studied and definitely tested, as far as it is possible to do so.

(i) Purity of sample.

(ii) Germination capacity.

(iii) Speed of germination.

(iv) Weight.

(v) Various minor characters such as form, colour, brightness and smell, which are often useful indications of quality where the more important points previously given cannot be readily determined.

2. **Purity.**—Everything in the sample which is not the genuine seed is an impurity. Even with the best appliances and cleaning machinery used by seedsmen, it is not possible to supply absolutely pure seed. With the larger kinds, such as the cereals, peas and beans, there is little difficulty in separating impurities which may be present at harvesting, but in the case of the smaller seeds, and especially those of clovers and grasses, there is greater trouble in ridding them of foreign seeds, and imperfectly cleaned samples of these are consequently not unfrequent.

The presence of impurities decreases the value of a sample in

so far as the purchaser pays for what he does not require. If the sample contains 6 per cent. of foreign matter in every 100 lbs., he pays for 6 lbs. of something which is not the true seed he intends to use. In some instances this may not be of much importance, for example, where one kind of grass seed is mixed with another of equal value, both pecuniarily and from an agricultural point of view. By far the larger number of impurities however are either useless, as husks, chaff, and bits of straw and dirt, or worse than useless as in the case of weed seeds. The latter point is worthy of greater attention than is usually given to it by farmers, as a small percentage of deleterious seeds often means a considerable number of weeds per acre. This is most easily seen when we consider the grasses where the number of seeds sown is usually very large. For example, 40 lbs. of grass seeds sown for permanent pasture, will contain more than 15 million seeds capable of germination; if only 1 per cent. of these is a weed, it means the possibility of between 30 and 40 such plants on each square yard of the ground.

In examining samples, therefore, it is not merely necessary to determine the amount of impurity present, but its nature is of importance—whether it be inorganic, such as sand and dirt, or organic material in the form of living seeds. The determination of the species of foreign seeds present in a sample requires, in some cases, special care and experience but all the more commonly occurring and easily recognised impurities will be mentioned when dealing with the character of each variety of seed separately. It is important to point out in this connection that impurities may be natural, that is, the foreign seed present may be there on account of the impossibility of ever obtaining a perfectly clean piece of ground on which to grow the crop for seed, or because of accidental mixing when the seeds are hand collected, as in the case of certain grass seeds. There are, however, samples met with in which the impurities present cannot well be anything but definite adulterations—additions of seeds of

very inferior quality often closely resembling the genuine ones.

Occasionally seeds which are similar may be substituted for each other either partially or completely, *e.g.*, perennial rye-grass for meadow fescue, or wavy hair-grass for yellow oat-grass, but this kind of fraud can readily be detected without much trouble.

There is, however, another form of deception which no examination of the seed alone will avoid, and that is the substitution of one variety of a species of plant for another. The article supplied may be in a sense true to name and yet be inferior so far as its usefulness is concerned. For example, red clover seed is at present raised in various quarters of the globe, and the strains from the different localities are not by any means all equally suited to our own climate. South European seed is more tender and liable to die off in autumn than seed raised say in Suffolk. Both samples of such seed would undoubtedly be red clover, but the substitution of one for the other would lead to serious results for the farmer. Not only does this apply to red clover but to many other kinds of plants.

Nearly all the plants of the farm and garden are species which have undergone considerable modification and 'improvement' at the hand of man; few of them are like the wild plants from which they were originally taken. We thus have a number of varieties possessing characters which make them more or less useful to us. Many of these have been raised to their present high standard of excellence by the skill and care of industrious men. The substitution of one of these specially raised strains of seed for another of inferior quality is a similar form of deception to that above mentioned. There are for instance a considerable number of different varieties of turnips on the market; some of them are of excellent quality in every respect, others inferior. It is quite impossible to distinguish them by any process of examination of the seeds, and yet the matter is of the utmost importance, as the substitution of one for another may frequently

mean the difference between a paying crop and one which is grown at a loss. Even when the seed supplied is guaranteed to be that of a particular strain, say 'Nonsuch,' it is to be noted that it may have degenerated or altered considerably since its first issue by the raiser (see p. 317).

Nothing short of actual trial of the seed on the land will determine differences of this character, and it is therefore necessary to trust to the reputation of the vendor.

The apparatus needed to determine the purity of samples are: (1) a good chemical balance; (2) a small spoon or spatula; (3) a series of sieves of different-sized meshes; (4) three or four porcelain dishes and a dozen watch glasses of different sizes; (5) two or three sheets of black and white cardboard or stiff paper; and (6) a good pocket lens or microscope with low powers.

Ex. 275.—Determine the purity of the sample of red clover seed. Weigh out about 20 grams of the seed and carefully sift it through the sieves to separate any impurities present which differ in size from the clover seeds. Place these on one side in a porcelain dish. Spread the rest of the sample on a sheet of cardboard and examine it with the naked eye and the lens for impurities which escape the screens. Any which are obtained must be added to the impurities in the porcelain dish and then carefully weighed on a watch glass. From the weight of the sample taken, and the weight of the impurities in it, the percentage purity can be calculated thus:—

	Grams.
Weight of seed taken =	16.72
Weight of impurity obtained =	0.54
	16.18
	Pure seed = 16.18

The percentage of pure seed, or the amount by weight in 100 lbs. of the sample is

$$\frac{16.18 \times 100}{16.72} = 96.7\%$$

that is to say in 100 lbs weight of seed purchased there is over three lbs of useless material.

Examine the nature of the impurity obtained, and determine whether it is inert material such as dead husks, chaff, and dirt, or seeds of weeds. A record should be made of the number of weed seeds present.

3. **Germination Capacity.**—Purity by itself is not sufficient guarantee of the value of a sample, as the seeds may be all dead or very much weakened. After determining the purity, it is therefore necessary to proceed further with the examination in order to ascertain how many of the seeds are capable of growth.

Certain external conditions are necessary before the embryo in the seed will begin to manifest signs of active life. These are an adequate supply of water, presence of air, and a suitable temperature. The embryo or young plant inside the seed however must be alive, or growth cannot take place, and it is very necessary to test seeds from this point of view. No amount of experience in the examination of the external characters can decide if seeds are living or dead. As will be pointed out later, the colour, brightness, and similar features of seeds are in certain instances indicative of germinating power, but the only satisfactory method of ascertaining their capability of growth is to actually test the samples by placing them under conditions suitable for germination.

Before we explain how to carry out this kind of test, it may be useful to mention that poor germination capacity may be due to various causes. When normally produced by the parent, the embryo or young plant in a completely ripened seed is a living structure. It may remain dormant inside the seed for a considerable period and yet be capable of developing into active life when suitable conditions are fulfilled. Nevertheless, embryos gradually die, and the time taken to lose life completely, although a point still in dispute, is, so far as practical purposes are concerned, comparatively short. Samples of wheat, for instance, are usually found to be completely dead in considerably less than ten years, the number of seeds capable of germination when kept even three years, is very small compared with the first season after harvesting the crop. Age, therefore, is productive of weak germination capacity, and old seed should always be

avoided if good results are to be expected. Some seeds, however, maintain their power of growth several years without deterioration.

The time during which seeds will maintain their power of germination, in an unimpaired condition, depends upon many circumstances, storage and ripeness in particular. There is much diversity of opinion upon this point, and the experiments recorded vary considerably in their results on account of the almost certain want of uniformity of quality of seed to begin with in the different series of experiments.

For practical purposes, however, the following table, compiled from various sources, indicates the time beyond which it is inadvisable to use the seeds mentioned :

Wheat .	2 years.	Mustard	3 to 4 years.
Oats .	2 „	Mangold	3 years.
Barley .	1 to 2 years.	Carrot .	3 „
Rye .	1 to 2 „	Cabbage	3 to 4 years.
Maize .	1 to 2 „	Kale .	3 to 4 „
Peas .	4 to 5 „	Kohlrabi	3 to 4 „
Beans .	4 to 5 „	Clovers	2 or 3 „
Buckwheat	2 years.	Sainfoin	1 or 2 „
Turnip .	3 to 4 years.	Lucerne	3 or 4 „
Swede .	3 to 4 „	most grasses	2 or 3 „

Formerly useful species of *Brassica*, as turnips and swedes, were much adulterated with dead seed of charlock and useless weed seeds of similar size and colour. Care was taken to kill the weed seeds by exposure to heat, in order that the fraud might not be detected by the appearance of wrong kinds of plants in the field.

At the present time old seed is frequently mixed with new, and is a cause of the weak and poor quality of many samples met with in commerce.

Poor germinating capacity may also be due to imperfect development of the embryo during ripening, mechanical injury

in thrashing, and too high a temperature and excess of moisture in the store room.

No matter what the cause may be, the death of the seed or its weakness can readily be tested, and no seed should ever be sown without this being done. It is also advisable for the farmer to have some guarantee from the vendor in respect of the germination capacity, and refuse to purchase from those who will not give it.

The germination test is applied to the pure seed separated in the previous examination, not to the sample in its original mixed condition. The following is a simple method which can be used for many kinds of seeds:—

Moisten a piece of thick blotting paper with water without making it dripping wet, fold it once and place it upon an ordinary plate. Take two lots of about 200 seeds each, distribute them fairly evenly on the blotting paper, and cover them with another sheet of similar paper. This done the whole should then be covered with another plate turned upside down, or a sheet of glass, in order to prevent too rapid evaporation of the water, and placed in a warm room. For each particular kind of seed there is a definite temperature at which germination goes on best, and in special instances to secure accurate results it is necessary to be able to control the heat supplied to seeds. A temperature, however, of about 18° C. (62° F.) is suitable to most ordinary seeds, with the exception of barley, which germinates best when kept slightly lower than this, viz., at 16° C. (57° F.—58° F.).

During the trial remove the upper plate at least once or twice every day to allow the carbon dioxide gas produced to diffuse away and fresh air to get at the seeds. Take away the germinated ones as soon as the embryo shows itself, and make a note of it.

The time during which to carry on the experiment varies with the kind of seed.

10 days being the time usually allowed for most seeds, such as Cereals, Clovers, Peas, and Turnips.

14 days are needed for the Umbelliferæ, *e.g.*, Carrot and Parsnip, and for Mangel, Rye-Grasses, and Timothy (*Phleum*).

21 days for all the grasses except those mentioned above, and the Meadow-Grasses (*Poa*) and Fiorin (*Agrostis*) for which 28 days are needed.

Instead of using damp blotting-paper as a seed-bed, various other substances may be employed, such as folds of flannel, damp sand and ordinary garden soil. Sawdust is not satisfactory, as substances are often present in it which check germination and destroy the radicle and other parts of the embryo as soon as they make their appearance from the seed. For small seeds blotting paper is sufficient, flannel being more suitable for the larger ones. Sowing in pots of sand and earth is generally unsatisfactory, as the seeds cannot be observed during their development. Some seeds are, however, best germinated in sand, especially mangel with its rough, irregular husk, as only in this way can an even supply of water to the seed be maintained; the sand penetrates into the crevices all round, and water is carried to the seed regularly by capillary action.

For grasses and similar small seeds, thin slabs of porous earthenware, placed in shallow tins containing water, are often used with more satisfactory results than when paper is employed. Sufficient water penetrates through the porous slabs to supply all that is required by the seeds. Sometimes porous flower-pot saucers arranged in the same manner are utilised with excellent results. These have the advantage of cheapness, and like the slabs, are easily cleaned by washing in boiling water. Where sand is used as the seed bed they are especially useful.

Many and varied are the contrivances which have been designed for purposes of testing the germination of seeds; the above examples are, however, sufficient for ordinary work. It is necessary that the supply of water, air, and suitable tempera-

ture should be tolerably even, and in the more elaborate apparatus used at seed testing stations these factors are under control, and the results obtained are consequently more accurate. Attention to the amount of moisture supplied to the seeds is very important, and too much is often given by beginners. Large seeds, such as beans, peas, and vetches, require considerable amounts; crucifers, cabbage, turnip, and mustard much less, while least of all is needed by the grasses and smaller seeds. Usually a steady temperature and even supply of moisture are best for germination, but the seeds of mangels and carrots and nearly all grasses are benefited by irregularities as the embryos become free from their coats more quickly when dryness and dampness succeed each other. Whether this is due to mechanical splitting of the walls of the fruits or to some influence upon the respiration and other physiological processes of the seed is not certain. In laboratories where the temperature is under control, sixteen hours at 18° C. followed by eight hours at 28° C. alternately, is found best for mangel seed.

Every day during the time previously specified as necessary for the test, the seeds which show active signs of life are counted and removed. At the end of the trial the number of living seeds compared with those which are inactive is known, and from this the percentage or number of living seeds in every 100 can be calculated, and the germination capacity is usually stated in this manner. For instance, in the sample of red clover previously mentioned and examined for purity, out of every 250 separated true seeds 240 only were capable of growth; the germination capacity was therefore $\frac{240 \times 100}{250} = 96$ per cent.

From the result of the purity examination and that of the germination capacity taken together, the total percentage of living useful seeds in the sample as originally purchased can be calculated. The figures obtained, namely 97 per cent. purity and germination capacity of 96 per cent., mean that in

every 100 lbs. of the seed 97 only are true to name, and of these true seeds only 96 in every 100 will germinate. The number of lbs. of useful seed in every 100 of such a sample is found by multiplying the purity percentage by the germination capacity percentage and dividing by 100. In this case it is $\frac{97 \times 96}{100} = 93$.

In other words, although in every 100 lbs. of the sample as purchased there are 97 lbs. of true seed, only 93 lbs. of the latter will germinate. The numbers obtained by multiplying the percentage purity by the germination capacity and dividing by 100, are directly proportional to the seed which is capable of germination, and indicate the percentage of seeds of real value to the farmer. Moreover these numbers are valuable in that they enable us to compare the relative cheapness or dearness of seed.

Two samples of perennial rye-grass, A and B respectively, were offered by different firms at 2¼d. per lb. The purity of A was found to be 96 per cent., and germination capacity 98 per cent.; B's purity was 99 per cent. and germination capacity 92 per cent. The real value of A or the percentage number of true rye-grass seeds capable of germination is $\frac{96 \times 98}{100} = 94$; that of B is

$\frac{99 \times 92}{100} = 91$. Hence A is the more useful and the cheaper seed as in 100 lbs. of it there are 94 lbs. capable of growth, whereas in the purer sample B, only 91 lbs. in every 100 are of any value.

On comparing the real values of seeds as obtained by examination of their purity and germination capacity, it will very often be found that samples offered at a cheap rate per lb., are in reality more expensive than those quoted at higher prices. For example, two samples of meadow foxtail grass, which we will name A and B, are offered at 1s. 5d. and 1s. 8d. per lb. respectively. The

purity of A is found to be only 78 per cent., and its germination capacity 70 per cent. Its percentage real value is, therefore,

$$\frac{78 \times 70}{100} = 54.6. \quad \text{B is of 90 per cent. purity, and 85 per cent.}$$

germination capacity; its real value is $\frac{90 \times 85}{100} = 76.5$. The

prices should be in the proportion of 54.6 to 76.5. This is not the case, however, for assuming that 1s. 8d. per lb. is a correct price to pay for such a sample as B, the price of A should be

less, viz.: 1s. 8d. $\times \frac{54.6}{76.5} =$ 1s. 2d. per lb. To buy the seed at

1s. 5d. per lb. would be a mistake from a pecuniary point of view. Moreover the seeds which are capable of growing in samples of poor germination capacity, frequently give rise to weak plants which often perish altogether.

The quantity of seed to use to sow an acre of ground depends on the real value as calculated above, and the mere statement that so many lbs. to an acre is essential for a good crop is useless, unless we know the quality of the seed to be employed, from these two points of view, namely its purity and germination capacity. One lb. of pure seed with a germination capacity of 96 per cent. is equal to 3 lbs. of pure seed of which only 32 per cent. is capable of growth.

Very often this is overlooked, especially when dealing with the sowing of grass seeds for permanent and temporary pastures, and the inattention frequently causes trouble. If it were not for the fact that far greater amounts of seed are generally sown than is necessary, the bad effects would be more marked.

4. **Speed of Germination or 'Germination Energy.'**—It will be found on examining seeds daily during their germination, that samples of the same kind of seed of different origin frequently differ considerably in the speed with which they develop, even when the external conditions as regards air, moisture, and warmth are kept the same. These variations are due to inherent

peculiarities of the embryo plants in the seeds, the nature of the seed coat, age, ripeness, and other causes.

Well-ripened seeds usually germinate more rapidly than those imperfectly ripened, but the reverse is the case in some instances, especially if the trials are made soon after harvesting the seed. Immature seeds, however, produce weak plants, and if kept lose their germinating power sooner than well-grown ones.

The results of germination tests are tabulated thus :—

SPECIES.	No. of Seeds.	NO. GERMINATED.										Total.	Total + $\frac{1}{2}$ Hard Seeds.	Germination capacity per cent.
		DAYS—												
		1.	2.	3.	4.	5.	6.	7.	8.	9.	10.			
Dutch Clover Sample I.	200	6	69	60	20	9	5	7	3	0	0	179	186	93
Dutch Clover Sample II.	200	2	104	43	10	4	0	3	6	4	0	176	184	92

From the observations upon the above mentioned samples, it is seen that although the total number of seeds capable of growth in each is much the same, the speed of development is slower in the second than in the first. We must always be careful to distinguish between the mere capacity for germination and the rate of its progress, as what we desire in seeds generally is rapidity and uniformity of speed, in order that the young plants may become attached to the soil as soon as possible. Apart from the constitutional weakness which slow development generally indicates, in the early stages of growth plants are delicate in any case, and anything checking their progress at that time gives opportunity for attack of insects and fungi, and unfavourable conditions of soil and weather often destroy lingering plants of this description.

In estimating the energy of germination, it is usual to note the number of seeds which germinate in a few days or a week, as under :—

Cereals, Turnips, Cabbage, and other Cruciferæ	in 2 days.
The Clovers, Lucerne, and other small Leguminous Seeds in 3 days.
Timothy Grass in 4 days.
Tall Oat-grass, Rye-grasses, and Meadow Fescue	in 5 days.
Meadow Fox-tail, Mangel, and Carrot in 6 days.
The Smaller Fescues, Cock's-foot and Meadow-Grasses in 7 days.

The various species of plants differ considerably in respect of the time which their seeds take to germinate, some do not begin growth for many months even under the most favourable circumstances, while in others the radicles of the embryos make their appearance in a few hours. In most instances this is due to the specific nature of the plants, but seeds may remain dormant on account of the chemical nature and structure of the seed coats preventing the proper access of water into the interior of the seed. This latter defect is common among the Leguminosæ (clovers, lucerne, &c.) and such seeds are known as 'hard seeds.' They are recognised during the germination test by their want of power to 'swell' like the rest of the sample. As they are capable of germination they are not absolutely valueless, and in testing samples of the Leguminosæ, one-half or one-third of the number present are generally counted as if they had germinated, and are added to the number of those which are found to develop in the ten days usually allowed. In good years, when seeds have been thoroughly ripened, the percentage of hard seeds goes up, and they may be taken as a partial indication of good quality of the sample. Various processes of improving the germinating power of hard seeds by friction are in use among seedsmen. (See p. 641).

Ex. 276.—Test the germination capacity and germination energy of samples of the chief common farm seeds, especially those of turnips clovers, cereals, and common grass seeds.

5. **Weight.**—The weighing of seeds is usually employed with a view of determining the comparative values of samples of the same species, and under certain circumstances it is an important means of distinguishing the good from the bad.

We may consider the weight of seeds from three distinct points of view, viz. : (a) Weight of *unit volume* of the seed as compared with the weight of the same volume of water or its *specific gravity*. (b) Weight of a definite *number* of seeds, as 100 or a 1000 ; sometimes spoken of as the '*absolute weight*.' (c) Weight of a certain definite *measure* or bulk of the seeds, usually that of a bushel or pint which we designate its *volume-weight*.

(a.) **Specific Gravity.**—The determination of the specific gravity of seeds is chiefly of theoretical interest, and there is no room for its discussion here. The method, however, of testing seeds by throwing them into water and observing those which sink or swim is concerned to some extent with their specific gravity, so that mention of it is not out of place.

The specific gravity of seeds depends chiefly on their chemical composition and the presence or absence of air-spaces inside the seed, under the testa, between the cotyledons or in the endo-perm tissue. As the chief constituents of seeds (*e.g.*, starch, cellulose, sugar, albuminoid material), are with the exception of fats and oils, heavier than water, most seeds ought to sink if no air-spaces are present in them and they could be readily wetted. Seeds, however, vary enormously in regard to the air they contain ; moreover, to those whose surfaces are hairy, rough and uneven, air-bubbles become frequently attached and enable somewhat heavy seeds to float when thrown into water. Some seeds which readily sink after harvesting often lose water by slow evaporation when they are kept, and become lighter and capable of floating owing to the penetration of air to fill up the spaces left. In these cases, *e.g.*, beans and peas, the test may help us to decide which is old seed, but applied to

seeds with waxy or hairy surfaces, or those with loose husks round them, as sainfoin and grasses, it is a useless and misleading method.

(b) '**Absolute Weight.**'—By this is meant the weight of a certain number of seeds, usually 100 or 1000; from it the average weight of a single seed of the sample can be calculated. It is found that so long as we compare the same kind of seeds, the absolute weight is directly proportional to their size, except in the case of abnormally large or very small ones. By weighing say 100 grains of barley from two different samples, we can readily determine which is the larger in size of grain.

It is well known that the size of seeds is not the same for all plants. Usually those which produce a small number of seeds from one flower, as the pea and bean, have larger seeds than those which give rise to many, as the poppy. Seeds of the same species of plant are however not always of uniform size, variation often occurring even in the same pod or ear.

Alterations in size are often associated with differences in the position of the seed or fruit upon the plant. In the ears of wheat, barley and rye, the heaviest grains are met with in the spikelets, at a point about half way from the base of the ear, sometimes a little below this point or a little above it according to the variety of wheat or barley examined. Not only do the grains increase in weight from the base to the middle of the ear and then decrease to the tip, but a similar relation in size to position on the inflorescence is seen on examining the spikelets, the second flower in each nearly always producing the heaviest grain.

In the Leguminosæ, peas and beans, the largest seeds are found near the middle of the pods and not at the ends. Besides the position of the seed on the plant influencing its size and therefore its weight, climatic conditions and manures are concerned in modifying the size of seeds. Although in all cases it is not possible in our present state of knowledge to explain the causes

of these differences in anything more than a vague manner, there is no doubt that the larger seeds are more highly nourished during their development and contain more reserve food for their embryos than the smaller ones. In wheat the flowers in the middle of the ear open first and are therefore sooner in beginning their development; fruits in this position are also found to ripen last, so that the total time for storage of reserve food in them is longer than in the case of those growing at any other part of the ear, and we should expect them to be larger in consequence of the increased nutrition.

Climate influences the amount of 'assimilation' which can be carried on by the plant, and therefore the size of the seed to some extent is dependent upon it.

Apart from theoretical considerations, it has been shown by a large number of experimenters that, leaving out the very large ones as exceptional and to some extent probably diseased, the larger the seed the more vigorous the embryo plant, and the more food it possesses for its early development. The larger root which it generally has, enables it to become more easily established in the ground, and it is better able to carry on 'assimilation' on account of its superior leaf surface than a plant from a smaller seed.

The vitality of plants raised from small seeds is not so great as from larger ones; they are more liable to succumb to adverse conditions of climate and soil. It has been shown that the amount of produce given by the use of large seeds, is greater than that obtained when smaller ones are employed; moreover the quality, so far as size is concerned, is generally transmitted from parent to offspring, large seeds giving large, and small seeds giving small plants.

The respective weight of 100 or 1000 seeds taken from two separate samples, is an accurate guide to the relative difference in the average size of the seeds in each, and is of very great importance, as it will be found to be the most reliable and easy

method of comparing the values of samples for purposes of producing vigorous and healthy crops, provided, of course, that the germination capacity is known.

This test can be employed with advantage in the examination of all kinds of true seeds as peas, turnip, and clover, but its special use is, perhaps, best seen and appreciated when applied to fruits, that is to seed vessels with their contents, such as sainfoin in the husk, and for the 'seeds' of grasses. The ordinary methods of examination as to brightness and colour, give little or no indication of the value of the sample in the latter cases, as the husks and chaff may be present and well developed, and yet the seeds and fruits inside may be shrivelled and useless, without giving any external indication of their condition. The difference in weight, however, between chaff and husk with and without their normal contents is very striking, and the presence of 'deaf' seeds in a sample at once reveals itself in the low absolute weight obtained from it when compared with that from a good one.

It is obviously very inadvisable to purchase seeds of grasses except by weight per bushel. Buying by volume or by bushel without reference to weight is frequently done, but is not prudent, as it may turn out that little else but chaff has been bought in some instances. Ordinary commercial Rye-grass seed for example varies in weight between 15 and 28 lbs. per bushel; the first would contain a large proportion of chaff and immature seeds, whilst the latter would consist mainly of good seeds. No difference in external appearance might be noticeable, but the weight of 1000 seeds from each would readily reveal which is the better sample, and this test on account of its importance and simplicity should never be omitted in examination of all kinds of seeds.

(c) **Volume-Weight.**—The volume-weight in the form of weight per bushel has been employed from the earliest times and is still almost universally adopted for the purpose of com-

paring the value of samples of seeds and especially those of the cereals. It was, no doubt, originally employed to determine relative usefulness so far as grinding for production of meal is concerned, and for this it is with certain restrictions adapted, if the comparison is confined to samples of the same variety of grain. It is obvious that the heavier the bushel-weight the more substance there is present in a bushel of it than in that of a lighter sample, and it would consequently give more whole-meal when ground. Where the amount or the mass of the substance of a seed is of importance, apart from its quality, bushel-weight is of use in comparing the value of different samples. If, however, two different kinds of grain are compared by this plan, say a coarse red wheat with a fine white one, the respective bushel-weights of the samples would not necessarily indicate their comparative value, as a heavy red sample might not be so valuable as a lighter white one, on account of the quality of the contents of the grain not being the same in both cases for the miller and baker. Besides, considerations would arise in respect of variations in the proportion of bran to flour yielded by each of them, which would make the comparisons of different varieties of grain by this method still more untrustworthy. For the estimation of the relative value or quality of samples of seeds for use in the raising of crops, the volume-weight is in itself of little value. It is generally assumed that the heavier the bushel-weight of a seed, the better it is for all purposes, but this is not absolutely so.

Volume-weight or weight per bushel depends on a number of different peculiarities of seeds, the chief of them being the following :—

(i) The kind of seed ; peas, for example, differ from turnip seed ; (ii) the nature and specific gravity of the materials composing them.

The relative proportions and amounts of starch, fat, cellulose, and other substances in the seeds have the greatest in-

fluence on bushel weight. That the composition should largely modify it is obvious if we imagine the seeds when measured to fill up the measure completely without any air-spaces being left between them ; then the weight obtained would be due to differences in the specific gravity of the substances met with in the seeds. If in one, starch preponderated, and in another, fat was the chief constituent, the former would give a heavier bushel-weight under these circumstances than the latter, as the specific gravity of starch is about 1.5, while that of fat is only 0.9. Flinty grains of the same kind of cereals, have usually a heavier bushel-weight than mealy ones, even when the sizes of the grains are alike.

The amount of water in the seed alters the weight, the less water the greater it is, so that seeds just harvested are often of less weight per bushel than when they have been kept some time. Unripe samples also are generally lighter than those which are allowed plenty of time to ripen.

(iii) The bushel-weight is also dependent on the amount of space left unfilled between the seeds or the way in which they are packed in the measure when it is full.

The chief characters which determine this, are the size, shape and nature of the surface of the seeds. Large seeds of the same shape pack differently from smaller ones. Round seeds, like peas or mustard seeds, lie closer together than long spindle-shaped grains like oats. Moreover, varieties with polished surfaces slide over each other more easily and arrange themselves more closely than those with rough, hairy, or corrugated exteriors.

The amount of chaff and other impurities and the manner in which the bushel is filled, alters the weight. If the measure is filled by slowly shovelling the seed into it, the weight will often be found very different from that obtained when the seeds are thrown in as rapidly as possible.

The general opinion that the bushel-weight is always proportional to the size of the seed is incorrect.

With wheat, rye and barley, it generally does increase regularly with an increase of size of the grain. Among oats, however, no such proportion is met with ; it often goes up with a decrease in their size ; but with some varieties it varies like wheat and barley. With long kinds, the bushel-weight goes up with the size of the grain, but among the more stumpy, short varieties of oats, this relationship is frequently reversed.

Medium-sized peas and beans, have usually a higher bushel-weight than either large or small ones, and occasionally the bushel-weight is the same even when the sizes are very different from each other.

Between the chemical constitution, shape, size, and other peculiarities of seeds and their volume-weight, no fixed relationship appears to hold, so that it is not of much service in determining quality of the seed for sowing purposes.

6. Form, Colour, Brightness and Smell.—It is only by a careful examination of seeds in regard to purity, germination capacity and ‘absolute weight,’ that their real value can be accurately determined, yet there are characteristics, such as shape, colour, brightness and smell, which are very useful in helping us to judge samples, and observations in reference to them should be made.

(a) **Form.**—Seeds which are imperfectly ripened, or which have suffered some check during their development, often show evidence of the imperfection in their shape. They are shrivelled, have more or less puckered coats, and differ in length, breadth and thickness from those seeds which are well developed. Such is seen in corn ripened too quickly by excessive dryness, and where plants have been injured by being ‘laid’ by the wind or have suffered from the attacks of insects and parasitic fungi.

Well-ripened seeds exhibit plumpness and rotundity of form, and these features may be generally taken to indicate that the embryo with its endosperm tightly fills up the entire space enclosed by the seed coat.

The transverse section of a good barley grain (Fig. 192) is more oval than that of a poor one (Fig. 193), the angles corresponding to the nerves of the flowering glume are less marked, and the grain obviously contains more substance for the development of the young plant. Especially does this hold good of the seeds of most leguminous and cruciferous plants, such as peas, clover, turnips and cabbage. The good samples, however, cannot be separated from the bad, by plumpness of form in the case of seeds or fruits enclosed in hard coats, such as buckwheat, sainfoin and nuts of all kinds, for

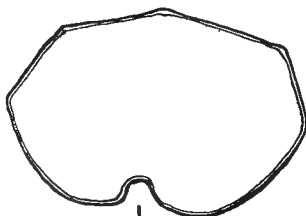

FIG. 192.—Transverse section of good barley grain.

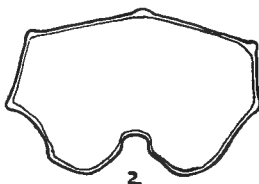

FIG. 193.—Same of poor one from 'tail.'

the husk or covering is often normally developed in samples with shrivelled and imperfectly-formed contents.

(b) **Colour.**—All seeds of plants in a young condition are of a pale greenish tint, but as they ripen some other well-marked and characteristic colour is gradually produced. In mature samples all the seeds are usually of uniform colour. In some, however, this is not the case, seeds of various tints being met with even when they are the produce of the same species of plant and all equally well ripened. Red clover is an example, and in the same pod of peas seeds of two colours are sometimes present. The question whether in these and similar cases the variations in colour are correlated with differences in germinating capacity has not been satisfactorily investigated.

All well-matured and healthy seeds, however, exhibit a colour which can be considered as the normal one, and commercial samples showing any deviation from this should be regarded with suspicion.

The chief causes of alterations in the colour are dampness, age, and harvesting when unripe. Nearly all immature samples show a tinge of green; this is particularly the case with the various species of clover, lucerne, black medick, and pale seeds generally. Those of the cruciferous plants as cabbage, turnip, and swede, which are naturally a very dark brown or black, show a paler brown or reddish tinge when unripe. The purple colour of red clover seed changes to a foxy red tint when they are old, and yellowish seeds, such as lucerne and black medick, become brownish after being kept; dark coloured ones of the crucifers changing to a dirty grey.

The pale yellow colour of barley is rapidly darkened on exposure to heavy dew or rain, and moisture in any form is a frequent cause of altered colour of seeds.

We see, therefore, that the examination of the tint of samples of seeds may often reveal defects in them, but it is to be remembered that various processes of dyeing and bleaching discoloured seeds have been employed by fraudulent persons in order to restore the colour and put them on the market as fresh samples, or to use them in mixtures.

(c) **Brightness.**—Fresh new seeds of some species of plants have a very smooth, glossy epidermis or skin, and appear polished. Clovers have this natural brightness in high degree, while some of the nearly related leguminous plants, *e.g.*, lucerne and black medick, show very little of this peculiarity. As an indication of quality it is only of limited application, but in seeds which are naturally bright, a dull appearance is a sign of age, bad harvesting, or injurious storage. Oil is sometimes used in order to impart brightness to old and bad seeds; very little indeed is needed to put a completely deceptive appearance on them, and suspicious cases should be tested. If much oil has been employed, shaking the seeds with water often reveals it as on standing it floats in drops on the surface of the water. A more accurate method is to place the seeds in a flask con-

taining absolute alcohol, and gently warm over a Bunsen flame. The alcohol dissolves the oil, and on pouring it into another vessel of distilled water the oil separates in the form of fine drops, giving a milky appearance to the liquids. When no oil is present the water and alcohol remain quite clear.

(*d*) **Smell.**—Some seeds when fresh have a characteristic smell which is lost when they are old. The Umbelliferæ generally have oil-canals in the wall of the fruits, and the odour is tolerably well-marked in fresh samples, becoming fainter or disappearing altogether on being kept. Carrots and parsnips are examples of this family. New oats have an earthy smell which is absent in older grain. Not only is smell a guide to the freshness of seeds, but musty samples injured by dampness and the growth of mould are easily detected by their odour.

From the foregoing account, it is apparent that no reliance can be placed on one character only in assessing the quality of seed, so far as its capacity for producing a healthy and vigorous crop is concerned. Especially is this true of external peculiarities, which, in many instances, can be so readily altered, that judgment based upon these alone is very unsafe. The usefulness of a sample of seed depends on the number of robust plants which can be obtained from it; this is governed by its purity, germination capacity, and weight of its component seeds, and it is upon an investigation of these characters that confidence should be placed by all who are anxious to reduce failure and its consequent expense to a minimum.

CHAPTER XLV.

FARM 'SEEDS': SPECIAL.

AFTER discussing the characteristics of seeds in general, it is important to mention the peculiarities of the chief farm seeds in greater detail, dealing with their size, form, purity, germination capacity and other features, which are useful in enabling us to recognise the seeds, and to separate good samples from bad or doubtful ones. They will be mentioned under their Natural Order. For further information in regard to the structure of the flower, fruit and other parts of the plants mentioned, the student is referred to Part IV.

CRUCIFERÆ.—The chief cultivated plants belonging to this Order met with on a farm, are the cabbage and its varieties, swede, turnip, rape and black and white mustard. In all of them true seeds are sown for a crop.

Cabbage (*Brassica oleracea* L.).—This plant is one which has given rise to a large number of varieties, those with which we are more immediately concerned being the drumhead cabbage, thousand-headed kale and kohlrabi. Other modifications, such as brussels sprouts, cauliflowers and savoy, are usually confined to garden husbandry.

FORM AND SIZE.—The seeds of the cabbage and all its varieties are round or oval in shape, the position of the radicle of the embryos and edges of its cotyledons being indicated on the outside of the seed coat by two shallow furrows with a raised part between them. The size is very variable, seeds of all diameters between 1·2 to 2·7 mm. being met with even in the same sample, and no certain distinction either of form or size can be drawn between the different varieties.

COLOUR, BRIGHTNESS AND SMELL.—All the varieties are a dirty chocolate brown with a greyish tinge; the surface is dull, and in these two particulars they differ sufficiently to enable us to distinguish them from the otherwise similar seeds of turnip and swede. They possess no smell, and the taste is mild and oily. The natural dull and grey tinge is suggestive of mouldiness to the unaccustomed eye, but the want of musty smell and the absence of the hyphæ of fungi, when examined with the microscope, enable us to decide in doubtful cases. Seeds which are mouldy and grey are often oiled to brighten them a little, and treated with charcoal powder to get rid of the musty smell; in cases where the seed looks bright, the test for oil should be made.

PURITY.—There is rarely any fault to find with samples in respect of this point. The chief impurities are dirt and pieces of the walls of the fruits. Samples, however, are not unfrequent in which the screening off of shrivelled and imperfect seed might have been carried further with advantage. The purity of good samples of all the varieties should be 98 per cent.

GERMINATION CAPACITY.—Samples above 90 per cent. are usually good; if lower than this they are either poorly developed, old, or have been mixed with dead seeds.

WEIGHT.—The size of the seeds of the different varieties is so irregular that no satisfactory standard weight can be given. The weight of 1000 seeds has been found to vary between 2·60 and 6·1 gr., a good average one being about 3·5 gr. Bushel-weight, 50·56 lbs.

Swede Turnip (*B. Rutabaga* D.C.).—A variety of this plant is known as Colza or winter-rape, the seeds of which differ in no way from those of the swede turnip.

FORM AND SIZE.—They are similar to the seeds of cabbage in these particulars, an uniform diameter of about 2 mm. to 2·2 mm. being a desirable one. The surface of the seed appears covered with irregular meshes between which minute dots are seen.

COLOUR, BRIGHTNESS AND SMELL.—The colour of the seeds

of the swede is different from that of the cabbage, being a deep purple, almost black. Only in old seed is a grey tinge observable. Good swede seed, moreover, has a bright appearance. Samples with many seeds of a pale purplish red tint are unripe. No smell is noticeable, and the taste is oily with a slight bitterness.

PURITY.—Similar to cabbage.

GERMINATION CAPACITY.—This should be from 90 to 95 per cent. in good samples.

WEIGHT.—1000 seeds should weigh from 3 to 3.5 grams. Bushel-weight, 50-56 lbs.

Turnip (*Brassica Rapa* L.). — There are a considerable number of varieties of turnips; as in the case of the swede, an oil-yielding non-bulbing variety is known.

FORM AND SIZE.—No constant difference is met with among the seeds of the separate varieties, all of which very closely resemble the swede. They are usually, however, slightly smaller than the latter.

COLOUR, BRIGHTNESS AND SMELL.—The brightness is the same as the swede, but the colour of a sample when seen in bulk is paler, more purplish-red seeds being present than in the former kind of seed. The surface markings are similar to the swede but slightly coarser. Smell and taste like the swede.

The **PURITY** and **GERMINATION CAPACITY** may be taken to be the same as the swede. 1000 good seeds weigh about 2.5 grams, the weight of a bushel is usually 50 lbs.

Black or Brown Mustard (*Brassica nigra* Koch.).

FORM AND SIZE.—The seeds are round or oval, and smaller than those of turnip or swede, the diameter varying from 1 to 1.5 mm. The surface of the seeds is marked with irregular hexagonal pits, much more distinct and larger than those on the turnip and swede; they appear as fine dots when examined with a pocket lens.

COLOUR, BRIGHTNESS AND SMELL.—The colour is like that of

the paler seeds of turnip—namely a brownish-red or dirty-claret tint. The seed has no smell, but when rubbed in a mortar with water, a pungent odour of mustard-oil is given off. Brightness similar to swede and turnip.

PURITY.—Usually good, but occasionally it is found mixed with swede, turnip and charlock seed.

GERMINATION CAPACITY.—Should be 85 per cent.

WEIGHT.—1000 seeds weigh about 1·5 to 2 gr.

White Mustard (*Brassica alba* Boiss.).

FORM AND SIZE.—The seeds of white mustard are rounder and considerably larger than those of black mustard, having an average diameter of about 2·3 mm.

COLOUR, TASTE AND SMELL.—The colour is a pale yellow or yellowish white with a greenish tinge occasionally. Like black mustard the seeds have a biting taste, but when rubbed with water they do not give off any pungent odour. The surfaces are not so rough as those of black mustard, the markings being very much finer.

PURITY.—Should be at least 98 per cent.

GERMINATION CAPACITY.—In good samples this is usually over 95 per cent.

WEIGHT.—1000 seeds weigh nearly 6 gr. Bushel-weight, 50·56 lbs.

Charlock (*Brassica Sinapis* Vis.).—The seeds are similar in size to those of turnip, only a little darker and browner. Their surfaces are, however, smoother in texture, but none of these characters are sufficient to distinguish them when mixed with turnip or swede seeds. Charlock seeds, however, have a pungent biting taste resembling that of black and white mustard.

LINACEÆ.—Flax or Linseed (*Linum usitatissimum* L.).

FORM AND SIZE.—The seed is oval, from 4 to 6 mm. long and 2 to 3 mm. broad, flattened on the side and pointed at one end.

COLOUR AND BRIGHTNESS.—The coat of fresh good seed is smooth and shining, of a brown colour. Old seed is darker in tint; imperfectly formed, unripe samples, which should be avoided for sowing purposes, are yellow or greenish, with a somewhat dull surface.

Samples in which the seeds cling to each other are generally damp and unsatisfactory, and often have a musty odour.

PURITY.—Commercial flax-seed often contains impurities, the chief of which are lumps of earth and certain weed seeds, especially *Camelina dentata* Pers., *Polygonum lapathifolium* L., Black Bindweed (*Polygonum Convolvulus* L.), Bearbine or Bindweed (*Convolvulus arvensis* L.), Knawels (*Scleranthus annuus* L. and *S. perennis* L.), and Flax Dodder (*Cuscuta Epilinum* Weihe).

GERMINATION CAPACITY.—For fresh seed this should be from 95 to 99 per cent.; good stored older seed should not be lower than about 90 per cent.

WEIGHT.—The absolute weight is very variable. In some samples of Russian origin 1000 seeds weigh as much as 7·5 grams or more. Average good seed weighs 4·3 to 4·5 per 1000.

LEGUMINOSÆ.—This Order includes a number of valuable plants, some of which are grown for their seeds, as beans and peas, while others, such as vetches, the clovers, lucerne and sainfoin are used mainly as forage crops, either cultivated separately or in mixtures with grasses.

The seeds vary very much in size, as we see when we compare the Windsor bean with some of the clovers.

The testa or seed-coat is generally leathery in texture, tough and hard when dry, and nearly always bright and smooth. While some of the seeds of this order are of uniform colour, as many beans and peas, they often exhibit two or more colours, shading more or less into each other, as in

red clover and kidney vetch; others are peculiarly marked with streaks, dots, and marbled lines as in lupins, partridge peas, and scarlet runner beans. The structure of the testa is much the same in the whole Order, that of the pea is given in cross section in Fig. 194.

The outermost layer (*a*) consists of epidermal cells which are thick-walled and largest in the direction of the radius of the seed. In consequence of the hardness and shape of the cells composing it, this is known as the hard or palisade layer. The cells generally contain colouring matter, and cross their walls, running parallel with the outside of the seed, are one or more lines where the light is strongly refracted. Beneath the palisade layer is another, (*b*) consisting of smaller cells shaped like an hour-glass. These layers (*a*) and (*b*) are met with in practically all seeds of the Leguminosæ.

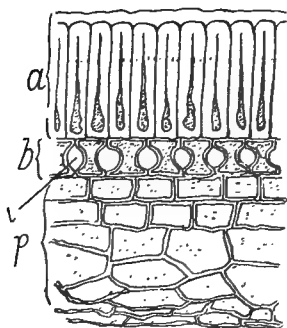

FIG. 194.—Transverse section of the seed-coat of a pea.

a Palisade-like layer of epidermal cells; *b* hour-glass-shaped cells; *i* intercellular space; *p* thin-walled parenchymatous cells which swell up when the seeds are soaked in water. (Enlarged 170 diameters.)

Immediately below are two or more layers consisting of parenchymatous cells, the longest diameter of which is parallel to the surface of the seed. When dry they are more or less pressed together, but on soaking in water they swell to a considerable size.

If a number of seeds of red clover are placed in water for a few hours, it will usually be found that some of them, instead of absorbing water and swelling considerably like the rest, remain the same size and shape as they were when put in. These are called 'hard seeds,' and the peculiar resist-

ance to the penetration of water depends on the nature of the 'hard layer' of the testa. Formerly it was supposed that the thickness of this layer and waxy substances within it prevented access of water into the interior of the seed. This, however, is not the case, the defect being due to the great amount of ash-ingredients, especially silica and lime, which it contains. The coat of 'hard seeds' is capable of resisting acids and boiling water, but even very slight friction — a few scratches with a needle — is sufficient to enable the seed to absorb water readily. In order to improve the germination capacity of the hard seeds in samples, the latter are shaken up in a sack with sharp sand. Friction inside cylinders lined with thin layers of cement, in which is embedded sharp sand, is also adopted for the same purpose.

The number of 'hard seeds' in a sample is dependent on the nature of the seed to some extent, the wild vetches having usually from 50 to 90 per cent. Season and climate also influence it.

Lucerne or Purple Medick ; Alfalfa (*Medicago sativa* L.).— True seeds are sown for a crop.

FORM AND SIZE.—The seeds of Lucerne are very irregular in form, some of them being kidney-shaped, and of variable length; others are more or less oval, with an irregular angular outline (see Fig. 195). The radicle is more than half the length of the seed, and its position is generally seen on the outside. The seeds are often wanting in plumpness. When placed on edge

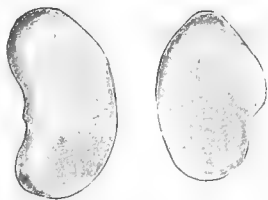

FIG. 195.—Two commonest forms of lucerne seeds.¹

¹ All the figures of seeds in this chapter, except Fig. 206, are drawn ten times the natural size.

and viewed in front of the micropyle, the seed has a bent appearance, the radicle not lying in the same plane as the cotyledons, but usually curved a little to one side.

The length of a seed varies from 2.5 to 3 mm.; width about 1.5 mm.; and thickness a little over 1 mm.

COLOUR AND BRIGHTNESS.—The colour is a pale buff-yellow in fresh seeds; when old they darken to a yellowish brown. The surface is much duller than that of any similar seeds of allied plants.

PURITY.—The purity of lucerne should be high, about 96-98 per cent. The most commonly occurring impurity, and one which is to be specially looked for, is Trefoil (*Medicago lupulina* L.), the seeds of which in colour and size resemble those of lucerne (see Fig. 196), but are only about one quarter the price.

'Bokhara Clover' (*Melilotus albus* Desr. and *Medicago maculata* Willd.) seeds occur in some adulterated samples. The former seed gives a smell of new-mown hay to the sample, due to a small amount of coumarin present in it. The latter is a larger seed, with a darker micropyle than lucerne, and the radicle reaches only about half the length of the seed. Seeds of clover dodder (*Cuscuta trifolii* Bab.) and the larger *Cuscuta racemosa* are also met with.

GERMINATION CAPACITY.—In the finest samples this is about 98 per cent., and anything lower than 90 per cent. should be avoided. The number of hard seeds averages about 10 per cent.

WEIGHT.—1000 seeds should weigh 2 grams. Bushel-weight 64 lbs.

Yellow Trefoil, 'Nonsuch' Clover, or Black Medick (*Medicago lupulina* L.).—The true seeds are sown, but usually the black fruits with characteristic curved lines upon them, and containing one seed, are present in samples.

FORM AND SIZE.—These seeds are usually smaller than those of lucerne, and can be separated from the latter by means of the

clover sieves. Length, 1·5 to 2·2 mm.; breadth, 1·3 mm.; width, 1 mm. In form they resemble a broad bean (Fig. 191), and are never kidney-shaped like lucerne seeds. They are also more regular and plumper than the latter. Where the radicle ends just near the micropyle is a well-marked projection, which is very characteristic of this species, and readily betrays its presence when used for purposes of adulteration. On viewing the seed on edge, as mentioned under lucerne, the radicle is seen to be situated symmetrically between the cotyledons.



FIG. 196.—Seed of Yellow trefoil.

COLOUR AND BRIGHTNESS.—The colour is pale buff or greenish yellow, and the seeds are considerably brighter than those of lucerne.

PURITY.—There is rarely any fault to be found with samples in respect of purity.

The **GERMINATION CAPACITY** should be at least 90 to 95 per cent., the hard seeds averaging about 10 per cent.

WEIGHT.—A bushel weighs 66 lbs.; 1000 seeds about 1·6 grams.

'**Trifolium,**' **Crimson or Italian Clover** (*Trifolium incarnatum* L.).—Two or three varieties of this plant are in the market, differing in the colour of the flowers and in their ripening period. The seeds of all are alike, except those of the white flowered variety, which are sometimes rather paler than the others.

FORM AND SIZE.—The seeds are almost perfectly oval, the outline of the radicle of the embryo being scarcely visible on the outside. In size they are considerably larger than any of the commoner clovers, being 2·5 to 3 mm. long, 2 mm. wide, and about 1·5 mm. thick.

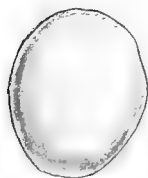

FIG. 197.—Seed of Crimson Clover.

COLOUR AND BRIGHTNESS.—In good, new seed the surface is a rich, reddish yellow; but old samples are of a darker tint. The hilum is almost white, with a ring of deep red round it. New seed has a bright, glossy appearance, and only very old specimens are at all dull.

The PURITY AND GERMINATION CAPACITY are nearly always good, and should reach 90 to 95 per cent.

WEIGHT.—1000 well-grown seeds weigh about 3·5 grams; bushel-weight, 65 lbs.

Red or Purple Clover (*Trifolium pratense* L.).—Numbers of varieties or sub-varieties of this plant exist. They differ chiefly in their permanence, some being practically annual plants, others lasting three or four years. In power of resisting frost, dampness, and other adverse climatic conditions, varieties differ considerably, and although, as pointed out elsewhere, the importance of selecting those suited to the climate can scarcely be over-estimated, it is impossible to distinguish them by their seeds.

For the British Isles, seeds raised in this country are undoubtedly the best. Good samples, however, come from the interior of Germany, north of France, and New Zealand. Seeds from the south of Europe and southern States of North America are liable to produce tender plants, which are unable to survive the winter.

Canadian seed is sometimes hardy, but cannot always be relied upon.

Foreign seed is no doubt mixed with English, and the total bulk sold as English. Unfortunately this kind of fraud and even complete substitution of foreign samples for English cannot ordinarily be detected by any examination of the seed. Sometimes the presence of foreign weed seeds is good evidence of the fraud.



FIG. 103.—Seed of Red Clover

FORM AND SIZE.—The seeds of red clover are oval, with a nose-like projection at one side, which is caused by the radicle of the embryo within the seed. They are tolerably uniform in shape; the length varies from about 1·5 to 2·2 mm.; the width across the broadest part is 1 to 1·5 mm, and thickness about 1 mm.

COLOUR AND BRIGHTNESS.—In good samples the colour is

rarely uniform all over a seed. The broadest end is a rich purple, which shades off into a flesh-colour, or yellowish grey at the opposite end. Along with the seeds which exhibit these two colours, there are usually in all samples some which are of a fairly uniform yellow tint all over. Those samples, however, which possess the greatest number of purple seeds are the best.

Unripe ones are not so rich a purple, more yellow seeds are present, and there is a slight tinge of green about them. The presence of pods with the seed still in them is also indicative of immaturity.

When the seeds are kept, the purple colour changes considerably, becoming lighter and redder. Even with seeds two or three years old, stored under the most favourable conditions, a buff-red tinge is noticeable. Unfavourable weather at harvesting alters the colour similarly; but in such instances the reddish seeds are only met with here and there in the sample. The same irregularity of colour is seen also in samples consisting of old and new seed mixed. Good red clover seeds always have very bright, shining surfaces.

PURITY.—This should be 98 per cent. in good samples, but it is often lower than this, as many weed seeds if grown with the crop cannot easily be separated from the clover on account of their similarity in size. A very large number of impurities have been met with in samples, those of most common occurrence and which should be avoided are: Yellow Trefoil (*Medicago lupulina* L.); narrow-leaved plantain (*Plantago lanceolata* L.); several species of Dock, such as *Rumex Acetosella* L., and *R. obtusifolius* L.; Field Chamomile (*Anthemis arvensis* L.); Ox-eye daisy (*Chrysanthemum leucanthemum* L.); White and Red Campion (*Lychnis vespertina* Sibth. and *L. diurna* Sibth.); Nipplewort (*Lapsana communis* L.); Dove's-foot cranesbill (*Geranium dissectum* L.); Clover dodder (*Cuscuta Trifolii* Bab.), and Broom-rape (*Orobanche minor* Sutt.) The yellow seeds of Trefoil are not difficult to recognise from the

figure and description previously given (Fig. 196). The seeds of narrow-leaved plantain cannot be separated unless this is done before those of the clover are removed from the pods, as the size of the two is nearly the same. They are smooth, brown, elongated seeds somewhat resembling a date 'stone' with a dark furrow down one side (1, Fig. 199). Dock seeds are three-sided

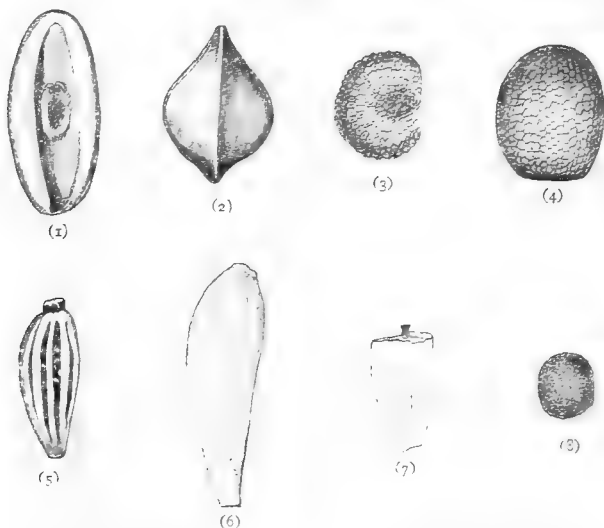

FIG. 199.—Common impurities met with in samples of Red Clover and other seeds.

- | | |
|-----------------------------|----------------------|
| (1) Narrow-leaved Plantain. | (5) Ox-eye Daisy. |
| (2) Species of Dock. | (6) Nipplewort. |
| (3) White Campion. | (7) Field Chamomile. |
| (4) Dove's foot Cranesbill. | (8) Clover Dodder. |

and shining, shaped like those of buckwheat and of a chestnut colour: those of white campion being kidney-shaped, ashy grey in tint, and ornamented with carved lines of regularly-arranged rounded projections (3, Fig. 199). Dove's-foot cranesbill seeds are chocolate-brown pitted and marked all over with hexagonal lines (4, Fig. 199).

The ox-eye daisy, nipplewort, and field chamomile are also

given in Fig. 199. The seeds of clover dodder (8, Fig. 199) are considerably smaller than red clover and almost round or oval, with irregular angles on the sides where the seeds have pressed upon each other in their fruit-capsules. They are grey or brown with rough dotted surfaces, and may be mistaken for pieces of dry earth. When pressed with a knife blade, however, they do not crumble as the latter do.

Small quantities of lucerne, alsike and white clover seeds may be present occasionally, but these impurities are not of much importance.

GERMINATION CAPACITY.—This should be 90 to 95 per cent., but in wet years it is somewhat lower. The average number of 'hard seeds' is about 8 per cent.

WEIGHT.—The weight of 1000 seeds varies between 1.1 and 2.1 grams; all samples above 2 grams are of exceptionally good quality; those equalling from 1.8 to 2 grams are very good, any samples which only reach 1.5 grams per 1000 seeds are poor and contain many shrivelled and weakly-developed embryos. A bushel weighs 65 lbs.

Alsike or Swedish Clover (*Trifolium hybridum* L.).

FORM AND SIZE.—The seeds of alsike are heart-shaped, the radicle jutting out prominently and reaching more than half the length of the seed (Fig. 200). Good samples should be plump; in size they are smaller than red clover, the length from the base of the radicle to the tip of the cotyledon being from 1 to 1.3 mm., the breadth across the cotyledon and radicle nearly the same, and thickness about $\frac{3}{4}$ to 1 mm.



Fig. 200.—
Seed of Alsike
Clover.

COLOUR AND BRIGHTNESS.—The colour is variable; the best samples have a preponderance of seeds with a dark olive tint marbled with slightly brighter patches. Some are pale sap green flecked with darker spots. Uniformly pale green seeds are also met with in small amount. Only immature samples show a yellowish green tint, and old seeds or those injured by

dampness are reddish. When the colour has become altered, dyeing the seeds is occasionally practised. Sometimes this can be detected by placing them on damp blotting paper and observing if a green stain is produced. Fast dyes, however, may be used, and only test of germination capacity will decide whether the seed is old and dyed or fresh.

New seeds are smooth and bright.

PURITY.—This should be 96.98 per cent. but is often considerably lower than this. Many of the weeds met with in red clover samples are found in alsike. The larger seeds, however, should not be present as they are readily screened off. The impurities to be looked for are the small dock



FIG. 201.—
Seed of
round-leaved
cranesbill.

(*Rumex Acetosella* L.), field chamomile, ox-eye daisy, narrow-leaved plantain, soft round-leaved cranesbill (*Geranium molle* L.); the seeds of which are egg-shaped, somewhat pointed, and reddish brown in colour, with smooth surfaces.

Field pansy (*Viola tricolor* L.); this seed is met with in red clover but more frequently in alsike, as its size is nearer the latter; the colour is yellowish-brown, and a light coloured, shrivelled projection (caruncle) is seen at its base (Fig. 202).



Self-heal (*Prunella vulgaris* L.) is another impurity whose seeds are egg-shaped with a white triangular projection at the narrow end; their colour is a rich chestnut-brown with two deeper lines running round them (Fig. 203).



FIG. 203.—Seed
of Self-heal.

FIG. 202.—
Seed of
Field
Pansy.

Dodder occurs frequently in this clover as it is almost impossible to separate it by sifting on account of the size of the two seeds being much the same.

The grey flattened seeds of Yarrow (*Achillea millefolium* L.) are met with occasionally.

GERMINATION CAPACITY.—This is usually not so good as in

red clover : about 90 per cent. should be expected. Hard seeds average 9 per cent.

WEIGHT.—The weight of 1000 seeds varies considerably ; a minimum of 0.446 gram and maximum of 0.8 gram are recorded. In a good sample it should be about 0.68 gram. The bushel-weight is 66 lbs.

Dutch or White Clover (*Trifolium repens* L.).— There appear to be two varieties of this plant in the market, the Wild White and Ordinary White Clover. The former is more permanent than the latter, but the seeds cannot be distinguished from each other.

FORM AND SIZE.—Like alsike, white clover seeds are heart-shaped. The radicle, which is not quite so straight as in alsike, generally reaches nearly the length of the cotyledons and projects outwards (Fig. 204). The size is variable, but usually very slightly smaller than alsike. A common defect is want of plumpness, some of the seeds appearing flat and thin through imperfect development and pressure in the pod.



FIG. 204.—
Seed of
white clover.

COLOUR AND BRIGHTNESS.—The colour of well-ripened fresh seeds is a pale golden yellow. Yellowish-brown seeds are common also, as well as some of a bright canary tint. Immature specimens incline to a greenish-yellow hue. Old seed changes to a darker colour, eventually becoming brick-red. The fraudulent application of sulphur fumes—sulphur dioxide gas—in order to restore the colour of aged specimens, is sometimes adopted. Seeds subjected to this process usually show an acid reaction when shaken up with distilled water and tested with litmus paper.

PURITY.—This should be about 98 per cent., the impurities being the same as those met with in alsike and red clover. Sometimes adulteration with seeds of yellow suckling clover (see below) is practised.

GERMINATION CAPACITY.—In the finest samples 95 to 98 per cent. will germinate, but the average number of hard seeds is somewhat higher than in the two previously mentioned clovers, namely, about 13 per cent.

WEIGHT.—1000 seeds should weigh the same as alsike, namely, 0.68 gram; the bushel-weight is 66 lbs.

Yellow Suckling Clover (*Trifolium dubium* Sibth.).

FORM AND SIZE.—These seeds are smaller than white and alsike clover, and very different from them in shape.



FIG. 205.—

Seed of
Yellow
Suckling
Clover.

They are of an elongated oval form, and the radicle, so prominent in most of the clovers mentioned, is scarcely visible (Fig. 205).

COLOUR AND BRIGHTNESS.—The colour of some seeds is pale greenish yellow; others yellowish olive and dark olive. They have a very bright shining surface.

The few samples we have examined have always been very impure, and germination capacity poor.

WEIGHT.—1000 seeds weigh about 0.4 gram.

Kidney-Vetch or Lady's-Fingers (*Anthyllis Vulneraria* L.).

FORM AND SIZE.—These seeds are oval, resembling those of crimson clover in form, but slightly narrower at the ends and not so thick. In size they are a little larger than red clover, namely, about 2.5 mm. long, 1.8 to 2 mm. broad, and 1.1 mm. thick.

COLOUR AND BRIGHTNESS.—The colour of one half of the seed is green, the other being a light yellow or greenish white. In old seed the green colour becomes greenish olive, while the lighter yellow part changes to a reddish buff tint. Surface smooth.

THE PURITY is generally good, but we have often found samples mixed with old red clover seed, and weeds associated with the latter.

GERMINATION CAPACITY should be about 97 per cent.

WEIGHT.—1000 well matured seeds weigh about 3 grams. The bushel-weight is 64 lbs.

Bird's-foot Trefoil (*Lotus corniculatus* L.).

FORM AND SIZE.—The seeds of this plant are very plump and a rounded kidney-shape, somewhat resembling a short red clover seed, with a not very prominent radicle. Sometimes specimens are almost spherical. Length, from 1·7 to 2 mm.; breadth, 1·5 mm.; and thickness, 1·1 mm.

COLOUR AND BRIGHTNESS.—The surface is very bright vandyke-brown in colour, with a few dark spots.

PURITY.—Usually of high purity, but occasionally the allied species, Marsh Bird's-foot Trefoil (*Lotus uliginosus* Schk.), which produces seed more freely and costs very much less, is substituted for it. The seeds of *Lotus uliginosus* Schk. are much smaller, only about half the size of the Bird's-foot Trefoil, and of a greenish hue.

GERMINATION CAPACITY.—Should be 95 per cent.

WEIGHT.—1000 seeds from a good sample weigh about 1·1 grams. Bushel-weight, 66 lbs.

Sainfoin ; Esparsette (*Onobrychis sativa* Lamk.).—Two or three varieties are known, differing in their duration and time of flowering, but their seeds are indistinguishable. Both true seeds, and the fruits with a single seed in them, are sown for the production of a crop, the latter being most generally employed.

FORM AND SIZE.—The seed resembles a small, broad bean in shape, about 4·5 mm. long, 3 mm. broad, and 2 mm. thick. In outline the *fruit or pod* is almost straight along one side, and rounded on the other. The surface is rough, with a

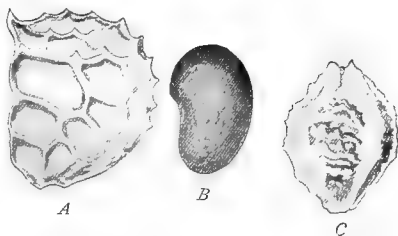

FIG. 206.

A.—Fruit ('unmilled seed') of Sainfoin.

B.—True-seed ('milled seed') of Sainfoin.

C.—Fruit of Burnet; a common impurity of 'un-milled Sainfoin seed. (All four times natural size.)

coarse, raised network, on which are spiny projections (*A*, Fig. 206).

COLOUR AND BRIGHTNESS.—The seeds are yellowish to greenish-brown, and fairly bright. When dark-brown or black, they are either old or injured by rain and dampness. The colour of the pod in good ripe samples is brown; very pale yellow and greenish ones being defective and unripe.

PURITY.—Seed freed from the husk should be absolutely pure. Samples in the husk, and especially those of foreign origin, are usually found to contain two or three per cent. of weed seeds, the worst being the Burnets (*Poterium Sanguisorba* L. and *P. muricatum* Spach.). The fruits of these plants are smaller than those of Sainfoin, four-sided, and winged with rough corrugations between the wings (*C*, Fig. 206.)

The rough fruits of Corn Crowfoot (*Ranunculus arvensis* L.) are also met with, as well as the one-seeded 'joints' of the fruits of Wild Radish or Jointed Charlock (*Raphanus Raphanistrum* L.).

GERMINATION CAPACITY.—For 'milled' or free seed this should be 90 per cent.; but for seed in the husk it is rarely so high as this, as the pods with shrivelled contents are often the same size as those with well-developed seeds, and cannot easily be separated from them. Good samples in the husk should, however, have a germination capacity of 75 or 80 per cent.

WEIGHT.—The 'absolute' weight is of special importance in estimating the quality of seeds of Sainfoin in the husk; 1000 pods in good samples weigh 20 grams; 1000 true seeds about 16 grams.

UMBELLIFERÆ.—The only plants we need mention belonging to this Order are the Carrot and Parsnip.

The complete fruit consists of two parts, which, when ripe, separate from each other. These halves, or mericarps, as they are called, each contain a single seed, closely united with the walls of the fruit. The parts which are sown for a crop are the mericarps.

As explained on page 441, the walls of the mericarps usually have ridges or raised lines on them, and in the substance of the wall of the fruit are hollow tubular spaces containing oils of peculiar flavour and odour. For further information in regard to the structure of the parts of the fruit of umbelliferous plants, the student is referred to chapter xxxi.

Carrot (*Daucus Carota* L.).

FORM AND SIZE.—The 'seeds' (mericarps) are oblong or oval; almost flat on one side; on the other are four prominent rows of spiny ridges, with five much smaller ones between them. The length is about 2.5 to 3 mm.; breadth, 1.5 mm.; and thickness, 1.3 mm.

COLOUR AND SMELL.—The colour is a greenish-grey, the spines being rather lighter. Fresh samples have a distinct and peculiar odour, somewhat like aniseed; when kept it becomes gradually fainter, and in old seed entirely disappears. Seeds badly stored frequently have a musty smell.

PURITY.—This is nearly always high, but samples sometimes are badly cleaned, and contain large amounts of broken pieces of fruit stalks and imperfectly developed mericarps.

GERMINATION CAPACITY.—This is usually low, 60 to 70 may be considered a very satisfactory percentage.

WEIGHT.—The absolute weight is a very useful guide to the quality of seed of this plant. 1000 mericarps in good samples weigh about 1.3 grams.

Parsnip (*Pastinaca sativa* L.).

FORM AND SIZE.—The mericarps are thin and broadly oval in shape, about 6 to 8 mm. long, and 5 mm. broad: on the outside three raised ribs are visible.

COLOUR AND SMELL.—The outside is a straw colour or greyish yellow, with four dark oil-canals, the inside is darker, inclining to a brown tint, with two oil-canals which reach almost from one end to the other. Fresh seed has a peculiar aromatic smell which disappears with age.

PURITY AND GERMINATION CAPACITY.—The former is usually high, averaging about 97 per cent., but the latter is always very poor, frequently not more than 30 per cent.

WEIGHT.—1000 grains should weigh from 3·6 to 4 grams.

CHENOPODIACEÆ.—To this Order belong the mangel and its allied varieties, garden and sugar beet. In these plants the flowers grow together in clusters at intervals on long spikes, as indicated in Fig. 113. Each flower produces a single seed. As they ripen the fruits become united together, more or less firmly, in masses of from one to seven, and it is these collections of fruits which are sown for a crop. In estimating size, weight, and germination capacity of samples this peculiarity must be specially borne in mind.

Mangel (*Beta vulgaris* L.).

FORM AND SIZE.—These characters are very variable, depending upon the number of fruits united together, large clusters having from four to seven, the small ones one to three. It has been found that the best results are obtained from those of medium size, in which there are three or four seeds.

The **PURITY** is generally good, no weeds being present. Samples should however be clean and free from pieces of stems and leaves, which is not always the case.

GERMINATION CAPACITY.—Although, as previously mentioned, three or four seeds are usually present in each cluster of a sample they rarely are all equally well developed. 100 'seed clusters' of a good sample usually give over 180 plants; those of average merit about 130 or 140.

WEIGHT.—The weight of 1000 'seed-clusters' depends upon the number of flowers which have grown together. 100 should weigh about 3 grams, not much more and not much less, as the medium-sized clusters give the most favourable results.

POLYGONACEÆ.—Many weeds belong to this Order, such as docks and knot-grass, but the only plant of importance we need mention here is buckwheat.

Buckwheat (*Polygonum Fagopyrum* L.). The fruits are sown for a crop.

FORM AND SIZE.—They are oval, pointed at each end and triangular in section, resembling those of the dock (2, Fig. 199). They contain one seed each and, at the base, the five-partite calyx is generally seen. Length 5·6 mm., width across the widest part of one side of the fruit is about 3 mm.

COLOUR AND BRIGHTNESS.—The colour is dark brown with a greyish tinge, and the surface smooth and shining. In old samples the seeds tend to split along the edges.

The **PURITY** is generally high and the **GERMINATION CAPACITY** in good samples about 85 per cent.

GRAMINEÆ.—This Order comprises all the true grasses, and although we are here only concerned with their ‘seeds’ it is only by means of a thorough and extended knowledge of the habits and peculiarities of their growth that the best use can be made of them in leys and temporary and permanent pastures. For information upon these points the student is referred to chapters xl. and xli.

The flowers of the grasses are very minute structures, which lie between two chaffy leaves or glumes, one of which, usually the larger—is called the *flowering glume*, the other, the *pale*. When the fruit (caryopsis) is produced from the flower it is of course present between these two chaffy glumes, and may either be (1) quite free from them as in wheat, where the fruit or grain readily falls out of its glumes when the ear is thrashed or rubbed in the hand, or (2) quite free from the glumes and capable of being separated from them by means of the finger nails, yet enclosed so closely by them that the fruit does not fall out on thrashing, as in oats, or (3) as in barley where the fruit is grown into union with its enclosing glumes, and cannot be separated from them except by special means.

Most of the ‘grass seeds’ used by the farmer are similar in structure to oats, none of them being sold in the form of naked

fruits, like wheat. In samples of some kinds of grass seeds, such as Timothy, with very thin, loose glumes, naked fruits may occasionally be present in considerable numbers. The only part of any use is the properly ripened fruit. In immature samples, and those which have been badly handled, and the true fruit shaken out and lost, the farmer buys nothing more than useless chaff. As the only parts to be seen are the chaffy glumes, the appearance of a sample can be of little service in guiding us in the purchase of good seed, and the necessity of studying the weight per bushel, and buying by weight rather than by bushel without reference to weight, cannot be too much insisted upon if reliable results are required. Light samples invariably have a large proportion of empty chaff in them.

A useful way of determining how much of a sample is merely chaff is to place a number of the seeds between two sheets of

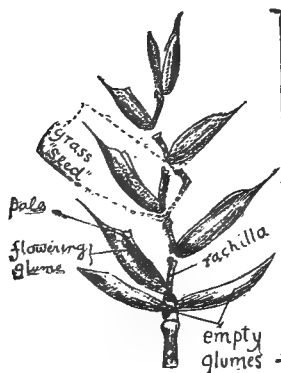

glass and hold them up to the light: the grains, if present, can then be seen within the semi-transparent glumes, and the percentage of 'deaf-seeds' readily counted.

The flowers or fruits of the grasses are enclosed, as stated above, between the flowering glume and pale, and these compound structures are arranged in two rows on the side of a short stalk or axis, called the rachilla, the whole forming a small spike of flowers or fruits.

FIG. 207. — Spikelet of a grass, showing its various parts, and usual manner of separation when ripe.

At the base of each spikelet are usually two empty glumes, which enclose more or less completely the rest of the spikelet.

When the grasses are thrashed for their 'seeds,' those spikelets, which consist of several flowers, generally break up, as indicated

in Fig. 207 ; a piece of rachilla, with flowering glume and pale attached, constituting the 'seed' of commerce.

In other instances the complete individual spikelets, with their empty glumes, fall off, and are sold as 'seed.' This is especially the case where only one or two flowers are present upon each spikelet, as in Foxtail and Yorkshire Fog.

In examining grass seeds, special attention should be directed to the presence or absence of awns, and the point from which they arise—whether they are continuations of the tip of the flowering glume, like those of barley, or arise on the back at a point some distance from the tip, as in oats, or from near the base of the glume.

The shape of the piece of rachilla—whether flat or round in section—and the way it juts out from, or lies close to, the pale, are also important features, as well as the number of veins and the presence or absence of hairs upon the flowering glume and pale.

The student is advised to become acquainted with the detailed account of the structure of the inflorescence and flowers of grasses given in chapter xxxiv.

Many of the distinguishing characters of the different grasses are very minute, and easily overlooked with the unaided eye. Nearly all kinds are, however, readily and accurately recognised by means of a pocket lens or low-power microscope. Careful work and a little experience makes the task of distinguishing fraudulent substitution of one kind of seed by a similar one of inferior value not a very difficult one. Purchasers are particularly warned to avoid buying *mixtures* of grass seeds. To unravel the contents of such, and determine the value of each of the constituents is difficult, and to purchase these mixed samples is to encourage fraud. Seedsmen can, without any trouble, supply all seeds pure and unmixed, as they themselves rarely purchase such mixtures ; and to refuse to supply them unmixed and without guarantee should mean to the farmer that the quality is

unreliable. Some of the best firms, in order to avoid even the appearance of doubt which might attach to their samples, will not supply mixed seeds unless specially required to do so, and this is as it should be.

The impurities met with in grass seeds are frequently much the same as those present in clover samples. The particular kinds and the amount depend upon the origin of the seed. A large quantity is obtained by women and children, who carry on hand-collection from wild grasses growing in meadows, lanes, woods, and commons abroad. This method, coupled as it is with packing in sacks often in damp weather, and other imperfect management, is productive of bad samples generally. Often little discrimination is made in the species collected, or their maturity, and worthless material and weeds thus find their way to the market.

Sometimes crops of 'seeds' are harvested from temporary leys. Where only two or three species of plants are grown together, such as one or two grasses and a clover or two, it is often easy to separate the different seeds from each other on account of differences in their form and size. The impurities present in samples obtained in this way are those usually met with in red and white clover.

Large quantities are also obtained from the cultivation of grasses for the definite object of seed only. Usually they are grown in drilled rows, and carefully tended and managed. Good pure seeds can be obtained in this manner. Ten or fifteen years ago samples of grass seeds were about as bad as they could be, full of impurities of all kinds, and a great deal of fraud was practised in mixing seeds of inferior kinds with the better sorts which they resembled. Sometimes complete substitution of good grasses by useless ones was carried on. Now, samples are of much better quality, and the best seedsmen will guarantee absolute purity, together with high germination capacity. It is, however, very necessary for the farmer to become more generally

acquainted with the peculiarities of seeds of all kinds, as it is want of information and apathy which very often makes low standards prevalent.

If in the purchase of all kinds of seeds the following points were insisted upon, and guarantees obtained in respect of them, there would be much less failure than there is at present, and the farmer would be more likely to obtain honest value for his expenditure.

(a.) Never buy mixed seeds.

(b.) Always buy by weight, or weight per bushel.

(c.) Insist upon having guarantees in respect of purity and germination capacity.

There are firms who will give no guarantee of any kind : they are manifestly unfair in thus refusing what is an honest and reasonable demand, and seeing that there are houses which are willing to supply seeds on the above basis, doubtful firms should be strenuously avoided. Similar difficulty in regard to guarantees for purity and composition of another important item of the farm, namely, artificial manure, has been partially mastered, and the necessity of checking purchases by analysis is beginning to be understood by the farmer in the case of manures and feeding-stuffs. It is in respect of seeds that the same principle requires application in order to prevent disappointment and loss.

Cereals.—For the characters of the different cereal grains see chapters xxxvi. to xxxix. Samples of these grains should be practically free from all impurities, and should have a germination capacity of at least 90 per cent.

Sweet Vernal-Grass (*Anthoxanthum odoratum* L.)

FORM, SIZE, AND COLOUR.—The spikelets of this grass have only one fertile flower, and the commercial seeds consist of two empty glumes, between which are the minute flowering glume and pale enclosing the caryopsis. The empty glumes are a rich, chestnut-brown colour, with whitish tips. The surface of these outer glumes is covered with fine, brown, silky hairs, and

from the back of each springs a twisted awn. One of the awns is larger than the other and bent (Fig. 208). The caryopsis is brown, shining, and unfurrowed.

PURITY.—Pure samples are very rare, those usually met with being more or less mixed with the useless allied annual grass, *Anthoxanthum Puelii* Lecoq and Lam. The latter has darker coloured glumes, with pale, light fawn-coloured hair, which gives a lighter appearance to the sample when seen in bulk; true Sweet Vernal-Grass being considerably darker. The awns of *A. Puelii* are also longer and more slender, and the hair not so silky as in the true seed.

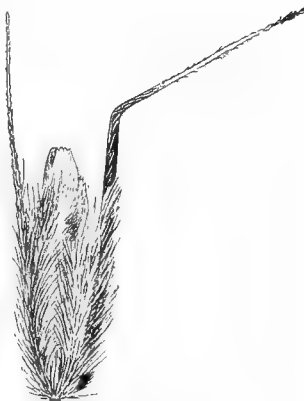

FIG. 208.—Seed of Sweet Vernal-Grass.



FIG. 209.—Seed of Meadow Foxtail.

GERMINATION CAPACITY AND WEIGHT.—When ripe the caryopses or fruits fall out of the glumes with the greatest ease; even with careful handling a great many are lost. The germination capacity of commercial samples is therefore usually very low. The best samples have a germination capacity of 70 to 75 per cent., but those with 50 per cent. of seeds capable of germination may be passed as good. The weight of 1000 seeds should be from '5 to '6 gram., the bushel-weight being 14 or 15 lbs.

Meadow Foxtail (*Alopecurus pratensis* L.) (Fig. 209).

FORM, SIZE, AND COLOUR.—The 'seeds' consist of flattened one-flowered spikelets, the empty glumes of which are fringed along the keel with long silky hairs and united to each other by their edges from a

point a little below the middle of the spikelet to its base. The flowering glume possesses a long bent dorsal awn, and surrounds the yellow flattened caryopsis, which nearly always has upon it the remains of a conspicuous stigma. The length of spikelet is about 6 or 7 mm., and 2.5 to 3 mm. broad. The colour of seeds in good samples is greyish-brown on one side, lighter on the other; the very pale silvery specimens, which look so well, are usually unripe and poor in quality.

PURITY.—Few grasses are so liable to wilful adulteration as this, the seeds chiefly used for this purpose being those of Yorkshire Fog (*Holcus lanatus* L. and *H. mollis* L.), Black Bent or Slender Foxtail (*Alopecurus agrestis* L.), and Perennial Rye-grass (*Lolium perenne* L.) Yorkshire Fog seeds consist of complete *two*-flowered spikelets which are broader and not so long as Foxtail (Fig. 210), and of a paler and more uniform colour. The empty glumes are more hairy, and reveal the two small florets when opened. The lower floret only is fertile, and has a shining porcelain-like appearance. The upper one possesses an awn which is bent like a fish-hook in *H. lanatus* and straighter in *H. mollis*.

Slender Foxtail seeds are similar in shape to those of Meadow Foxtail, but readily distinguished by their slightly larger size and almost entire absence of hairs on the keel. They are harsher to the touch, and do not cling to each other like the true seeds.

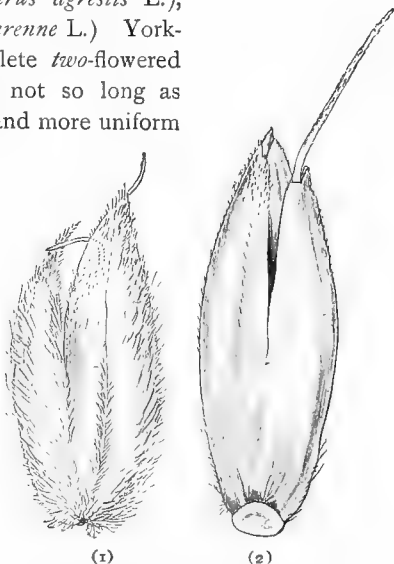

FIG. 210.—Two common adulterants of Meadow Foxtail.

(1) Yorkshire Fog.

(2) Slender Foxtail.

The empty glumes are united to a point near the middle of the seed, measured from the base (Fig. 210).

Rye-grass seeds, which are added to give weight to the sample, are not at all similar to Foxtail, as is seen by reference to Fig. 225, and description on page 672.

Seeds of *Alopecurus arundinaceus* Poir. and *A. geniculatus* L. which are similar to Meadow Foxtail but with more open empty glumes are sometimes met with in adulterated samples.

GERMINATION CAPACITY.—The spikelets when ripe easily fall away from the plant, and to avoid this much seed is gathered in an unripe condition. The germination capacity of such samples is very poor. The florets are, moreover, subject to the attacks of fungi and small insects which also reduces the quality in this respect.

The very best samples sometimes reach a germination capacity of 85 per cent., but often it is not more than 60, and sometimes as low as 10.

Samples containing 60 per cent. of seed capable of germination may be considered good.

WEIGHT.—An examination of the weight of 1000 seeds is of the greatest importance in determining the usefulness of samples. Where it does not amount to more than 65 grams., the parcel should be rejected as containing a large proportion of empty chaff.

1000 perfect seeds weigh about 1 gram.; a bushel about 12lbs.

Timothy or Catstail (*Phleum pratense* L.).

FORM, SIZE, AND COLOUR.—The seed consists of the flowering glume and pale with the caryopsis, the whole being oval in form (Fig. 211); from 2 to 2.5 mm. long and .75 broad. Both glumes are very thin and transparent, with a characteristic silvery-white lustre. Old or badly harvested seed is often discoloured and dull.



FIG. 211—
Seed of
Timothy
or Catstail.

When allowed to ripen thoroughly, many of the caryopses fall out of their glumes, and a considerable proportion of these naked fruits is sometimes met with. In such samples the caryopses are plump and of a

pale-brown colour. The presence of dark-brown naked fruits should be looked upon with suspicion as the seed is likely to have suffered from damp weather in harvesting, and where dulness and discolouration of the glumes is present as well, it is very necessary to test the germination capacity of the sample.

PURITY.—There is no difficulty in obtaining absolutely pure seed. Weed seeds, if met with at all, are easily seen in contrast with the silvery-white colour of the genuine ones. The impurities of most frequent occurrence are those usually met with in the clovers, viz.: Docks (*Rumex obtusifolius* L. and *R. Acetosella* L.); Wild Pansy (*Viola tricolor* L.); Narrow and Broad-leaved Plantains (*Plantago lanceolata* L. and *P. major* L.); and Self-heal (*Prunella vulgaris* L.).

The GERMINATION CAPACITY should not be less than 90 per cent., and bushel-weight 50 lbs.

1000 seeds should weigh '4 gram., a little more if the number of naked fruits is large.

Fiorin (*Agrostis alba* L. var. *stolonifera*).

FORM, SIZE, AND COLOUR.—The flowering glume, which is about 1·8 to 2 mm. long and '5 mm. broad, is thin and transparent, with five nerves, slightly notched at the tip, and not awned; the pale is only half the length of the flowering glume, and the fruit yellowish in colour.

Very often complete spikelets are present in the samples, the empty glumes of which are narrow and acute, often pale violet in colour; the larger of the two glumes has minute teeth along the whole length of its keel.

PURITY.—No reliance whatever can be placed upon commercial samples of this seed. True seed is very rare, Fine Bent-grass (*Agrostis vulgaris* L.) being generally substituted for it. The latter is very similar to Fiorin but smaller, the



FIG. 212—
Seed of
Fiorin.

flowering glume more transparent and three nerved, occasionally with a slender bent arm.

The larger of the empty glumes of the spikelet is toothed only at its upper part.

In damp situations Fiorin is *said* to be of use, but it is very doubtful if it possesses any agricultural value at all, and is best avoided.

The GERMINATION CAPACITY should not be less than 55 to 60 per cent.

Yellow or Golden Oat-Grass (*Trisetum flavescens* Beauv. = *Avena flavescens* L.

FORM, SIZE, AND COLOUR.—The flowering glume is divided at its tip, the halves being prolonged into two short awns. A twisted and bent awn arises at a point not quite half way down



FIG. 213.—Seed of Yellow Oat-Grass.

the back of the glume, the base of the latter being fringed with a few short hairs; the rachilla bears many long white hairs upon it. The length of the seed is about 4.5 mm., of a pale-brownish straw colour.

PURITY.—The seed is almost entirely hand-collected and is usually very impure. It is difficult to clean, and samples are adulterated with the useless Wavy Hair-grass (*Aira flexuosa* L.) which resembles it (Fig. 214). The impurity is readily detected by its darker colour and the position of the awn very which arises near the base of the flowering glume; the rachilla lies closer to the pale than in Golden Oat-Grass, is much shorter, and the hairs upon it not so long; the hairs at the base of the seed are, however, more prominent in the Wavy Hair-grass.

The GERMINATION CAPACITY is always low as there is a difficulty in clearing away the empty chaff; in the best samples

it should be 70 per cent., but those containing 50 per cent. of living seeds may be considered good.

WEIGHT.—1000 good seeds weigh about .48 gram., the bushel-weight being 12 lbs.

Tall Oat-Grass: French Rye-Grass.—(*Arrhenatherum avenaceum* Beauv. = *Avena elatior* L.).

FORM, SIZE AND COLOUR.—The commercial seeds of this grass consist of complete spikelets without the empty glumes. Two florets are present in each, the lower one is male only and has a flowering glume with a strong twisted and bent awn which arises a little above the fringed base of the seed: the upper floret is fertile and produces a pale brown caryopsis, hairy at the tip, its flowering glume has a straight more slender and shorter awn which grows from a point near the apex.

The whole 'seed' is nearly the size and colour of a small ordinary white oat, about 8 mm. long and 1.5 mm. broad. The larger awn is dark brown with a spiral band of paler tint around it.

PURITY.—This is generally good and should be at least 98 per cent.

The GERMINATION CAPACITY of good samples reaches 80 per cent., and the weight of 1000 seeds should be not much less than 3.5 grams.

Bushel-weight 14 lbs.

Crested Dogstail (*Cynosurus cristatus* L.).

FORM, SIZE, AND COLOUR.—The flowering glume of the seed is strong and opaque, drawn out at its tip to a rigid point which is slightly curved on one side. Its upper part is keeled and covered with short stiff whitish bristles, the lower part being smoother. The colour varies from orange yellow to deep rich brown; length about 4 mm., breadth .9 mm. The rachilla is short with a broad flattened top.



FIG. 214.—Seed of Wavy Hair-Grass, an adulterant of Yellow Oat-Grass samples.



FIG. 215.—Seed of Crested Dogstail.

PURITY. Samples of this seed should be perfectly pure. They are, however, often adulterated with the smaller fescues (see page 671), and Purple Melick grass (*Molinia caerulea* Moench.). Seeds of the latter are larger, more swollen near the base; their flowering glumes are smooth, three-nerved, not awned and purplish in colour especially at the tip (Fig. 216). The rachilla is longer than in crested dogstail.



Fig 216.—
Seed of
Purple
Melick
Grass.

The caryopses of Yorkshire fog enclosed in the smooth silvery-white flowering glume and pale is a frequent and very objectionable impurity.

The GERMINATION CAPACITY in the very finest samples is about 95 per cent., with a bushel-weight of 37 lbs: samples containing 65 to 70 per cent. of living seeds may be considered good. 1000 seeds should weigh 48 gram.

Cock's-foot (*Dactylis glomerata* L.).

FORM, SIZE, AND COLOUR. The flowering glume of this seed has a well-marked keel with strong hairs upon it, and a stiff rough awn which is slightly curved arises just below its tip. (Fig. 217). The whole seed is pale yellowish white, somewhat flattened on one side and about 5 mm long without the awn.



Fig 217.—
Seed of
Cock's-foot.

PURITY.—The best seedsmen supply it of 100 per cent. purity, but samples are often adulterated with the low priced Perennial Rye-Grass, Fescues and Purple Melick Grass (*Molinia caerulea* Moench.). Yorkshire Fog (*Holcus lanatus* L.), Soft Brome-Grass (*Bromus mollis* L.) and Dock seeds are deleterious impurities to be specially looked for.

Pieces of spikelets consisting of two or three seeds are found in samples which have been harvested unripe.

GERMINATION CAPACITY.—In the finest quality this is 95 per cent. but samples containing 75 to 80 per cent. of living seeds may be considered good.

WEIGHT.—The bushel-weight of the best seed is 22 lbs.; 1000 seeds should weigh from 0.9 to 1.0 gram.

Smooth-stalked Meadow-Grass (*Poa pratensis* L.).

FORM, SIZE AND COLOUR.—The pale brown flowering glume is acute not awned, but with a well-marked keel and four prominent ribs or veins. The lower halves of the keel and marginal ribs are distinctly hairy, and at the base of the seed is a tuft of white woolly hairs, (Fig. 218).

The length of the seed varies between 2.5 and 4 mm.

PURITY.—This is the cheapest of the three or four species of *Poa* in the market and the seeds are produced in abundance and easily procured pure. It is sometimes, however, adulterated with Tufted Hair-Grass (*Aira caespitosa* L.) which has a circle of hairs at the base of its seed, not woolly but resembling those in Fig. 214, the seeds of the impurity are also shining and white, and the flowering glume usually possesses a short awn inserted at a point a little below the middle.

The **GERMINATION CAPACITY** of the best samples is about 75 per cent., and a bushel weighs 32 lbs. Samples containing 60 per cent. of living seeds may be considered good.

1000 seeds should weigh not less than .25 gram.

Rough-stalked Meadow-Grass (*Poa trivialis* L.):—

FORM, SIZE AND COLOUR.—This seed is very similar to the preceding one, but is more slender and acute (Fig. 219). The hairs on the keel are not quite so prominent, and there are none at all on the marginal ribs. The woolly hairs at the base are variable in quantity in both seeds, so that little reliance can be placed upon them as a distinguishing



Fig. 218.—Seed of Smooth-stalked Meadow-Grass.



FIG. 219.—Seed of Rough-stalked Meadow-Grass.

feature. Usually, however, they are not so abundant in this seed, and pure natural samples do not cling together so much as those of *Poa pratensis*.

PURITY.—The smaller seeds of samples of *Poa pratensis* are often screened off from the larger ones, and these fraudulently substituted for the more expensive *Poa trivialis*. Various means are adopted to rub off the hairs from the base and marginal ribs to make the resemblance more complete, and in such machined samples it is necessary to employ a higher magnifying power than that of a pocket lens in their examination. The seeds of *Aira caespitosa* and *Molinia caerulea* are occasional impurities.

The **GERMINATION CAPACITY** should be the same as that of the preceding species, and Bushel-weight 30 lbs.

Wood Meadow-Grass (*Poa nemoralis* L.)—The seeds of this species are very variable, and cannot be distinguished from those of *Poa pratensis* L.

Pure samples can sometimes be obtained with a Germination capacity of 80 per cent., and Bushel-weight of 24 lbs.

Meadow Fescue (*Festuca pratensis* Huds.) :—



FIG. 220.—Seed of Meadow Fescue.

FORM, SIZE AND COLOUR.—The flowering glume of the seed is rounded on the lower part of the back, and has five indistinct veins, the middle one or keel being more prominent near the tip with a few rough, short hairs upon it. The free end of the glume is thin, bluntish, and occasionally split or notched. Sometimes a short awn arises just below this point. The rachilla

which does not lie very close to the pale is cylindrical, with a flattened projecting top (Fig. 220). The length of the seed is about 7 mm., and breadth 1.5 to 1.77 mm.

PURITY.—Samples may be obtained quite pure, but it is advisable to examine all purchases for Perennial Rye-grass, which is extensively used for adulterating this species. Both seeds are

very similar in size and shape, but the rachilla of Rye-grass is flat and oval or triangular in section, it also lies closer to the pale, and has no flat projecting top. (See Fig. 225.)

Seeds of the pernicious weeds, Soft Brome-Grass (*Bromus mollis* L.) (Fig. 221) and Rye-like Brome-Grass (*Bromus secalinus* L.), are not uncommon impurities of bad samples. Both these are about twice the size of Meadow Fescue seeds, and have long awns arising from between the bifid membranous tip of the flowering glume. *B. mollis* is a flatter seed than *B. secalinus*, and hairy. In other respects they resemble each other.

The GERMINATION CAPACITY should not be less than 90 to 95 per cent.

The WEIGHT per bushel of a good sample is 30lbs., and 1000 seeds should weigh 2·3 grams.

Tall Fescue (*Festuca elatior* L.).—Probably Meadow Fescue and Tall Fescue are the same species of plant, but the latter is characterised by larger and more luxuriant growth. Its seeds are coarser in appearance, somewhat longer and not quite so broad as those of Meadow Fescue; the flowering glume is more frequently awned. The seed is about double the price of Meadow Fescue, and always contains a small percentage of impurities, chiefly Rye-grass and Cock's-foot.

Another form of this grass which grows near the sea coast is

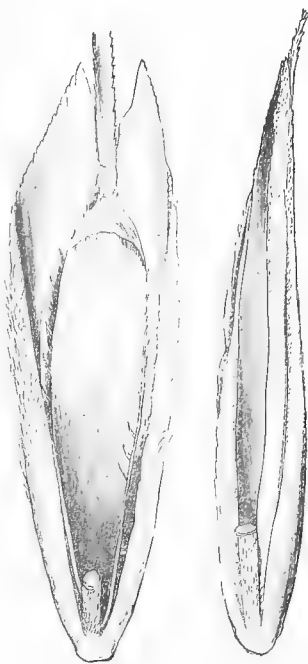

FIG. 221.—Seed of Soft Brome-Grass.

FIG. 222.—Seed of *Festuca arundinacea* Schreb.

Festuca arundinacea Schreb. (Fig. 222). It is sometimes sold as *F. elatior*, but is of little or no agricultural value on account of its coarse reedy character. The seeds have a short awn and are practically identical in appearance with those of ordinary Tall Fescue, with the exception of colour which is generally paler.

Sheep's Fescue (*Festuca ovina* L.).

Hard Fescue (*F. duriuscula* L.).

Red Fescue (*F. rubra* L.).

These are very variable grasses, often considered as varieties or sub-species of *Festuca ovina* L. Little or no attempt is made to collect definite samples of each; and as supplied by the seedsman, they are usually all derived from the same parcel by screening. The smaller seeds without awns are sent out as *F. ovina* (*tenuifolia*), (Fig. 223), the larger ones with tapering awns being supplied as *F. duriuscula* (Fig. 224). The typical seed of *F. duriuscula* has a pale brown flowering glume, which tapers off gradually into a rough awn about one-sixth the length of the whole seed. The lower part is smooth, but on the upper part a few short hairs are present, especially on the mid-rib. The rachilla is cylindrical, with a projecting flat top and juts out from the pale. Seeds of *F. rubra* are somewhat broader than those of *F. duriuscula*, and the awn appears to arise more abruptly from the flowering glume.



FIG. 223. —
Seed of
Sheep's
Fescue.



FIG. 224.—
Seed
of Hard
Fescue.

The chief impurities met with in these smaller Fescues are seeds of Sorrel (*Rumex acetosella* L) (2, Fig. 199), Soft Brome-grass (Fig. 221), and Purple Melick grasses (Fig. 216), which have been described previously.

THE GERMINATION CAPACITY of good samples is usually about 70 to 80 per cent.

The bushel-weight of Hard Fescue is 23 lbs., and that of Sheep's Fescue about 28 lbs.

Perennial Rye-grass; Eaver; Pacey's Rye-grass (*Lolium perenne* L.).—Formerly considerable attention was paid to the selection of varieties of this grass, and special strains, varying in habit of growth, yield, and duration, were obtainable under different names, such as Stickney's, Russell's, and Pacey's Rye-grass. At present they exist only in name, those with other names than Perennial Rye-grass being merely samples of heavier weight, for which a higher price is charged.

At present the fancy names for the heavier weighted samples are 'Devonshire Evergreen,' 'Eaver' and 'Pacey's.' The 'fine-leaved Rye-grass' for lawns is simply the smallest seeds sifted out of the bulk.

FORM AND SIZE.—The seed is about 7 mm. long and 1.5 mm. broad. Its flowering glume has no awn, and is without hairs; rounded on the back with a membranous blunt top. The rachilla lies close to the pale, and is flattened, oval or triangular in section, narrow at the base, and gradually widening out towards the summit.

PURITY.—Samples should be quite pure. Those of low bushel weight are imperfectly cleaned, and always contain weeds, the commonest ones being Yorkshire Fog (*Holcus lanatus* L.) (Fig. 210), Soft Brome-grass (*Bromus mollis* L.) (Fig. 221), species of Crowfoot or Buttercup (*Ranunculus acris* L.,

and *R. repens* L.) (Fig. 226), Narrow-leaved Plantain (*Plantago lanceolata* L.) (Fig. 199), and Black Medick or Trefoil (*Medicago*

lupulina L.) in the husk.

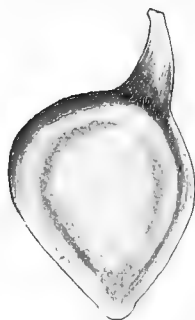

FIG. 226.—Achene of Creeping Crowfoot (*Ranunculus repens* L.).



FIG. 225.—Seed of Perennial Rye-grass

The GERMINATION CAPACITY should not be less than 90 per cent.

WEIGHT.—The best samples weigh 28 lbs. per bushel or more, and none should be used less than 25 lbs. 1000 seeds should weigh 2 grams.

Italian Rye-grass (*Lolium italicum* A. Br.).

FORM AND SIZE.—The seed of this grass resembles that of perennial rye-grass, but the flowering glume has a well-developed awn, and is usually more divided and jagged at the tip (Fig. 228).

PURITY.—This should be 100 per cent.; but, as in the former species, samples are often very imperfectly cleaned, and contain similar weed seeds, together with those of Ox-eye Daisy (*Chrysanthemum leucanthemum* L.), Nipplewort (*Lapsana communis* L.), several species of Dock (*Rumex*), and Forget-me-not (*Myosotis*) (Fig. 227), as well as species of

Brome-grass (*Bromus mollis* L., and *B. secalinus* L.), and Hair-grass or Squirrel-tail Fescue (*Festuca sciuroides* Roth.). The latter is a dark, slender seed, with a long, delicate awn.



FIG. 227.—Seed of Parti-coloured Forget-me-not (*Myosotis versicolor* Reichb.).

The GERMINATION CAPACITY should not be lower than 85 to 90 per cent.

The bushel-weight of good, clean samples is about 23 lbs, and 1000 seeds should weigh 2 grams.



FIG. 228.—Seed of Italian Rye-grass.

Ex. 277. (i) The student should examine samples of all farm seeds obtainable, so as to become thoroughly familiar with their form, colour, and other external peculiarities. He should also become practically acquainted with all the common impurities mentioned and figured in this chapter.

(ii) A collection of the seeds of the common weeds of the farm should be made and kept for reference.

(iii) Students at colleges and schools should determine the weight of 1000 seeds from various different commercial samples of farm seeds.

To do this weigh out 1, 2, 5 or 10 grams. of the seed: then count the number of seeds obtained, and from the result calculate the weight of 1000.

PART VII.

FUNGI, CONSIDERED CHIEFLY IN RELATION TO SOME COMMON DISEASES OF PLANTS.

CHAPTER XLVI.

FUNGI: GENERAL.

1. MANY plants are rendered unhealthy through inadequate supply of air to their roots, excessive dampness, or great dryness of the soil, too high or too low a temperature of the surrounding atmosphere, and other similar unsuitable conditions of soil and climate. Insects are also responsible for the destruction of numbers of plants, but perhaps the most extensive and insidious diseases of farm and garden crops are due to the attacks of a class of lowly-organised plants known as fungi.

2. The fungi, of which more than 40,000 species have been described, constitute a sub-division of the Thallophytes (see p. 322), and are all characterised by a complete absence of chlorophyll.

3. **Hypha and Mycelium.**—The body of a fungus is composed of long, thin filaments termed *hyphæ*. Each hypha is a transparent, tube-like structure, the wall of which usually contains a larger or smaller amount of chitin, a substance commonly met with in the animal kingdom; only in a few instances is cellulose present in the cell-membranes of fungi.

Lining the hyphæ or filling them is a colourless cytoplasm, in which are numerous small nuclei and often many large

irregular vacuoles ; minute oil-drops are also frequently abundant in the protoplasm, but starch-grains are never present.

Continuous growth goes on at the tip of each hypha and a similar method of elongation is carried on by its branches. Among the higher fungi the hyphæ are always *septate*, that is, divided into larger or shorter cells by transverse partitions or

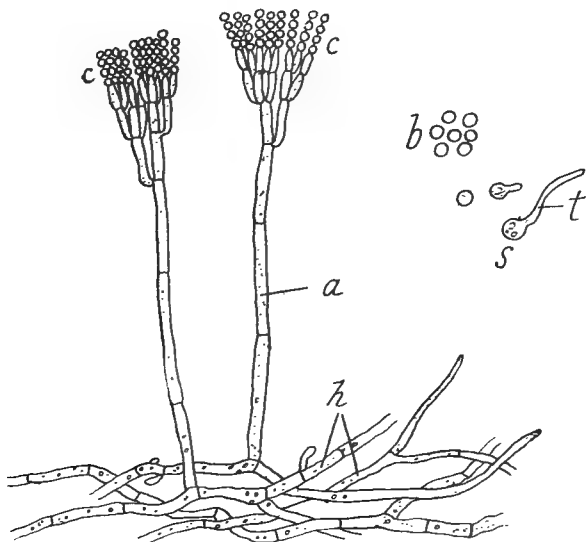

FIG. 229.—A common 'mould,' *Penicillium crustaceum* L. *h* hyphæ forming part of its mycelium : *a* erect hypha bearing conidia *c* in chains, *b* detached conidia, at *s* germination of a conidium has taken place, *t* germ-tube, the beginning of a new mycelium. (Enlarged 500 diameters.)

septate (Fig. 229), but in the lower forms the hyphæ are *non-septate* or without transverse dividing-walls.

4. The whole body or thallus of a fungus may be divided into two parts, namely, (1) a vegetative portion termed its *mycelium*, or *spawn*, chiefly concerned with the nutrition of the plant, and (2) a more or less specialised portion, which bears the organs of reproduction.

The mycelium in practically all cases, at first consists of a loosely interlacing collection of hyphæ which absorbs nutriment from the substance upon or within which it grows. When its component hyphæ are abundant, the mycelium resembles a loose tangled mass of soft and delicate, white, cotton-like threads, and in many fungi remains in this form even when it spreads over an area of several square feet. Such mycelia are commonly observed among dead leaves, in manure heaps, on decaying wood, damp walls and rotten organic matter generally. Frequently the hyphæ forming the mycelium become closely woven together into long, string-like strands, or flat, spreading sheets, resembling soft felt or even tough leather.

Among certain species of the higher fungi, the mycelium after vigorous active growth forms compact, firm masses of irregular spherical, cylindrical, or other shapes, varying in size from a pin's head to a doubled fist or larger. These hard mycelia are termed *sclerotia*, and are generally black or purple on the outside, and grey or whitish within. The hyphæ composing them are compactly united with each other and divided by so many transverse septa, that sections through them resemble those through parenchymatous tissue of the higher plants. Fungus tissues of this character are described as *pseudo-parenchymatous*. Sclerotia contain a store of nutriment and, after their formation, undergo a period of rest of several months: when produced in late summer or autumn they usually remain dormant during the following winter, and in the succeeding spring and summer germinate and give rise to reproductive organs.

5. **Reproduction.**—As in the rest of the Thallophytes, fungi are reproduced by means of *spores*, each of which is a single cell set free by the mother-plant and capable of giving rise to a new plant like its parent.

Great variation exists both in the form and the mode of origin of spores. The commonest spores are spherical or oval, but in certain species they are club-shaped, spindle-shaped, or even

thread-like. In many instances the spore possesses a double cell-wall; the outer membrane, termed the *epispore*, is often thick and ornamented, while the inner one is usually transparent and thin. In regard to their mode of origin two types of spores are recognisable, namely:—

(i) Those which are the result of a fertilisation-process, or *sexually-produced spores*; and

(ii) those which originate *asexually*.

The latter are most prevalent among all kinds of fungi, and only in the lowest forms or the *Phycomycetes* (p. 686) are sexually-produced spores met with, unless the spores of some *Ascomycetes* belong to this group. One form of sexually-produced spore originating after a conjugation process is termed a *zygospore* (p. 686), and is characteristic of one sub-class of the lower fungi; the other, typical of the second sub-class of the *Phycomycetes*, is known as an *oospore* (*s*, Fig. 233), and is described on page 692.

Of asexually-produced spores three types may be recognised, namely:—

(i) *Endospores*,

(ii) *Conidia*,

(iii) *Oidia and chlamydospores*.

(i) *Endospores* are spores which arise by division of the protoplasm *within* a mother-cell; the wall of the latter acts as a case for the spores and is termed a *sporangium*, the special hypha at the end of which the sporangium is borne being designated a *sporangiophore*.

The endospores of some of the lower fungi are naked pieces of protoplasm furnished with vibratile cilia which enable them to swim freely in water as soon as they are liberated by the rupture of the sporangium (*s*, Fig. 230); such motile spores are termed *zoospores* or *swarmspores*. Most endospores, however, are non-motile cells with a distinct cell-wall (Fig. 230).

Sporangia are chiefly spherical or oval in form, though they

may be cylindrical or club-shaped. One important and specialised type of sporangium containing a definite limited number of spores is termed an *ascus* (*C*, Fig. 255).

(ii) A *conidium* (*c* and *b*, Fig. 229) is a simple cell of very variable form and dimensions, cut off or abstricted from the top of a hypha, the latter being termed the *conidiophore* (*a*, Fig. 229).

It would appear from comparative study that a conidium represents a degenerate one-spored sporangium, the spore case and the spore within it having become a single structure.

Frequently as soon as one conidium has been formed, others are produced behind it in succession from the same hypha; thus chains of them may arise.

All conidia are at first single cells, but they sometimes become multicellular by the formation of dividing-walls (Figs. 236 and 237), and in such cases each new cell subsequently behaves as a separate spore.

A special form of conidiophore characteristic of a large group of the higher fungi is termed a *basidium*, the conidia borne upon it being known as *basidiospores* (*s*, Fig. 252).

(iii) Among fungi of many different orders the hyphæ forming the mycelium often become divided by transverse walls into a large number of short segments, each of which is capable of germinating and giving rise to a new plant; these segments, which may remain united in chains, or become free from each other, are known as *oidia*.

Between *oidia* and *chlamydospores* no strict line of demarcation can be laid down. The latter, however, are generally thick-walled, usually brown or dark-coloured spores, frequently intercalated or produced at irregular intermediate points along a hypha, but sometimes occurring at the apex of the latter. On germination, they often give rise to short hyphæ, bearing either sporangia or conidia (Figs. 240, 242 and 243).

6. In the simplest fungi the spores are borne directly on the mycelium, but in a great many species there exists a special

spore-bearing region more or less highly differentiated from the vegetative portion of the plant.

In the potato-disease fungus, and others of the same class, the *sporophore* or spore-bearing organ of the plant is a simple or slightly branched hypha ; but in the mushroom, toadstools, and a large number of fungi it is a complicated and conspicuous structure (*A*, Fig. 252), and is the only part of the fungus ordinarily noticed, the mycelium from which it springs and upon which it depends being often of slender character, and hidden from view within the substratum on which the plant feeds.

7. A few species of fungi are *monomorphic*, that is, they produce but one form of spore ; the majority, however, are *pleomorphic*, or capable of giving rise to several distinct forms of spores, either at the same time or successively, upon the same mycelium.

This latter peculiarity has often been the source of confusion, for before the life-history had been fully investigated, the several different forms which a species assumed in the course of its development were frequently mistaken for so many isolated and distinct species.

At the present time thousands of so-called species of fungi are nothing more than incompletely known 'forms.'

8. **Germination of Spores.**—With an adequate temperature and a suitable supply of water many spores, especially ordinary endospores and most conidia, germinate in a few hours ; others, such as oospores, zygospores, and many chlamydospores, which are conveniently termed *resting-spores*, do not commence growth until a certain time has elapsed after their formation by the parent plant.

In some instances spores require to be in contact with acid or alkaline substrata, or placed under other special conditions, before they will grow.

The most frequent mode of germination common to most endospores, conidia and oidia consists in the emission of one or

more delicate, hyphal filaments or *germ-tubes* (*t*, Fig. 225), which, if properly nourished, develop at once into mycelia.

Where the spore possesses a double wall, the inner or thin cell-membrane forms the germ-tube: the latter often makes its exit through pores or thin places in the outer firm coat of the spore.

In some conidia, especially when placed in nutrient solutions, the cell-wall bulges out at one or more points, the outgrowths grow larger and larger until they equal the parent cell in size and form. Each daughter-cell behaves in the same manner, and although the various generations of cells may remain for a time connected in the form of chains, they ultimately become free from one another. Such cell-multiplication (Figs. 240 and 253) is termed *sprouting* or *budding*; it is frequent in many different orders of fungi, and very characteristic of the true yeasts (*Saccharomyces*).

As previously mentioned, chlamydo-spores on germination produce a more or less simple and short hypha, termed a *promycelium*, which does not develop further vegetatively, but often gives rise to spores at once.

7. Mode of Life: Saprophytes and Parasites.—On account of the absence of chlorophyll and chloroplasts, fungi are unable to manufacture the complex carbon compounds necessary for their nutrition from carbon dioxide and water; they are therefore compelled to obtain these compounds ready made from other sources.

Those species which derive their food from the organic compounds of dead plants and animals are spoken of as *saprophytes*. Although many saprophytes feed upon and induce, what is termed decay and putrefaction in jam, cheese, bread, and other foods, and also cause 'dry-rot' and other injuries to timber, as a class they perform useful work in clearing the surface of the earth of dead bodies of animals and plants which would, otherwise, rapidly accumulate to an objectionable extent. Moreover,

they decompose organic bodies, breaking them down into simple compounds which ultimately become available for the nutrition of green plants.

The fungi which feed upon the tissues of living plants or animals are termed *parasites*, the plants or animals attacked by the latter being designated their *hosts* or feeders; it is to the activity of this class that serious diseases of farm and garden crops are due.

While mushrooms, most common 'moulds' and many familiar fungi are entirely saprophytic, others, such as the 'rust' fungi, are entirely parasitic in habit and incapable of carrying on an existence except when nourished by a living host. No strict line of division can, however, be made among fungi in respect of the sources of their food, for certain species which usually behave as saprophytes may become parasitic especially when well-nourished: moreover, many parasites are capable of existing as saprophytes for a considerable period.

8. Parasites, such as hop-mould and vine-mildew, which develop their mycelium on the external surface of their host-plants, are spoken of as *epiphytic*, while those whose mycelia ramify through the tissues of their victims are termed *endophytic*; examples of the latter are the fungi causing 'damping-off,' potato disease, and the 'rusts' of cereals and other plants. The mycelia of endophytic species are either *intercellular* or *intracellular* according as the hyphæ permeate the intercellular spaces only, or actually penetrate the cells of the tissues in which they grow.

The food needed by epiphytic parasites is usually absorbed from the superficial cells of the host-plant by means of short processes known as *haustoria* or 'suckers' which are produced at irregular intervals on their hyphæ and penetrate into the subjacent cells; similar haustoria are also found on the hyphæ of some endophytic parasites, while in others of the latter class transference of nutrient materials is carried on by osmosis directly to the whole mycelium.

9. The chief agent in the distribution of the infecting spores is the wind, but in a few cases insects carry on the work. The entrance of fungi into plants is effected in various ways. In the 'rusts' the germ-tube of the summer-spores chiefly penetrates through the stomata, but in many of the worst parasites the germ-tubes and hyphæ of the mycelium secrete an enzyme which dissolves the cell-walls of the host.

Several destructive fungi, such as those causing 'canker' of fruit-trees and of larch, find an entrance into their victims through wounds, cracks, and abrasions of the bark produced by frost, gun-shots, unskilful pruning, and other mechanical means. Nutrient substances exude from such wounds and afford an excellent medium for the active growth of fungi, and the walls of the exposed cell are more easily penetrated than those forming the normal outer covering of the plant. Some parasitic fungi confine their attacks to a single host-species, while others are able to destroy many different species of plants. Apart from specific differences of the attacking fungi, peculiar and little understood conditions of the host and its surroundings determine, to a considerable extent whether or no it shall be invaded by a particular parasite. Superabundant moisture, excessive dryness, imperfect access of light and air to the plants, and other external conditions of soil and atmosphere, tend to check their healthy growth and render them susceptible to attack.

Certain internal conditions of the plants influence the attack of parasites. The experiments of Miyoshi have shown that the hyphæ of fungi are able to exert considerable mechanical pressure upon the membranes of the epidermis, when attracted by chemical substances within the cells of the leaf. Moreover, the hyphæ of fungi may be induced to grow towards and penetrate into the tissues of plants by injecting the latter with sugars and other substances which exert an attractive stimulus upon the hyphæ.

This *chemiotaxis* or stimulating action of certain chemical

compounds upon the direction of growth, not only influences the hyphæ of parasitic species but the hyphæ of *Penicillium glaucum*, and other saprophytic fungi may be similarly induced to grow into tissues they would not ordinarily penetrate when these tissues are specially charged with excess of certain nutritive substances. Large amounts of water, sugar, and several other compounds within the cells of the host make such a plant very liable to the attack of fungi.

Parts of plants which are young and whose external cell-walls have not yet become cuticularised are often specially liable to be invaded by fungi, whereas older portions of the same plant possessing a well-developed cuticle or a layer of cork-cells escape infection.

The extent and character of the damage done to the host plants by parasitic fungi is very variable. In many instances the cells of the tissues permeated by the fungus are killed and disorganised. In such cases the amount of the injury depends upon the extent of development of the mycelium; where the latter is confined to the immediate neighbourhood in which the fungus makes an entrance, the injury is very localised and amounts to little more than a discoloured spot on the leaf or other member of the affected plant; when the mycelium spreads extensively the damage to the tissues of the host is correspondingly great.

Instead of destroying the cells of their host, some parasites have a stimulating effect upon the tissues with which they are in contact, and the organ attacked, and parts near it grow more rapidly and become larger than similar parts of the plant which are free from the fungus. The increased size of such deformed parts is most generally due to energetic cell-multiplication induced in them.

Abnormally enlarged tissues are said to be *hypertrophied*, the whole malformation, whatever form it assumes, being known as a *fungus-gall*.

10. General advice to be followed when dealing with plant-

diseases.—Although various specific remedies are given in the chapters dealing with individual plant-diseases, it is advisable to bear in mind the following points which are applicable to all diseases induced by parasitic fungi.

(a) Remember that the diseases are spread silently and invisibly by means of spores of very minute size which are readily carried about by the wind, by insects, and on the hands, boots, and clothes of labourers in the field and garden, as well as by implements used for cultivating the ground.

(b) Never allow refuse from a diseased crop to remain in the field or garden longer than is absolutely necessary; wherever possible collect it and burn it at once.

(c) Never throw diseased leaves, stems, roots, or tubers upon manure heaps, for many injurious fungi remain dormant through winter in such places without damage to their vitality, and are liable to spread disease among crops again when the manure containing them is subsequently applied to the soil. Moreover, many parasitic fungi are capable of living an active saprophytic existence on manure heaps, and become parasitic again on plants when opportunity offers.

(d) Take active steps to check the development of disease as soon as it is first noticed; early action always saves much future trouble. The timely removal of a diseased specimen from its neighbours often saves the latter from infection.

(e) Keep down all weeds as far as possible, for many fungi live upon and spread from these to useful crops.

(f) After severe attacks of disease it is advisable to change the cropping of the ground, selecting totally distinct genera of plants to follow each other whenever possible: many fungi live only on one species of cultivated crop.

(g) Avoid overcrowding of plants, and endeavour to promote their healthy growth by careful tillage, drainage and thorough supply of fresh air to all parts of the plants. Plants weakened by excessive or inadequate supplies of manure, heat and water, often fall an easy prey to fungi.

CHAPTER XLVII.

FUNGI (*continued*).

Classification.—Various systems of classification have been proposed for the fungi; none of them, however, can be considered final, as large numbers of species or forms are very imperfectly known and their relationships are consequently obscure. The following divisions are adopted by Engler and others:

EUMYCETES (True Fungi)

Section A.—**Lower Fungi.**

Class I.—**Phycomycetes.**

Sub-class i. *Zygomycetes.*

Sub-class ii. *Oomycetes.*

Section B.—**Higher Fungi.**

Class II.—**Basidiomycetes.**

Sub-class i. *Hemibasidii.*

Sub-class ii. *Eubasidii.*

Class III.—**Ascomycetes.**

Sub-class i. *Hemiasci.*

Sub-class ii. *Euasci.*

In the *Lower Fungi* the mycelium, which is often much branched, is generally unicellular, the hypha being unseptate, except in the old growths and the reproductive parts of the plants. Both sexual and asexual reproduction occur in the group.

The *Higher Fungi* possess a multicellular mycelium, each hypha composing the latter being divided by transverse septa into longer or shorter cells (Fig. 229). Definite sexual repro-

duction appears to be wanting among the higher fungi (excepting perhaps some of the Ascomycetes), only asexual propagation being known with certainty.

PHYCOMYCETES.

Sub-class i. **Zygomycetes.**

In the Zygomycetes, *conjugation* (a fertilisation-process between two similar branches of the mycelium) takes place, and results in the formation of a thick-walled resting-spore termed a *zygospore*.

Asexual reproduction is carried on by means of non-motile endospores which arise within sporangia occurring at the ends of erect hyphæ (*s*, Fig. 230), and in some species by means of conidia also.

A small number of fungi belonging to this sub-class of the Phycomycetes are parasitic upon plants and insects, the greater portion of the Zygomycetes, however, are saprophytes. One of the commonest species, namely *Mucor Mucedo* L., occurs as a 'mould' in all parts of the world upon damp bread, jam, and other organic substances, especially those containing starch and sugar. Its mycelium ramifies in all directions through the substratum on which the fungus feeds and grows, and from it are sent up into the air numbers of erect, transparent hypha, bearing at their tips single spherical sporangia in which are numbers of oval spores (Fig. 230).

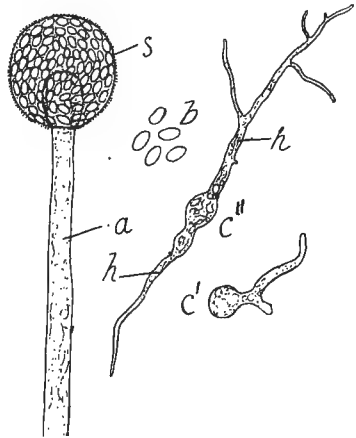

FIG. 230.—*a* Sporangiophore of *Mucor Mucedo* L. at the apex of which is a sporangium (*s*) with endospores; *b* free endospores; *c*ⁱ and *c*ⁱⁱ two successive stages of germinating endospores; *h* hypha (enlarged 300 diameters).

Certain species of *Mucor* which appear incapable of attacking uninjured ripe fruits, frequently obtain an entrance into the latter by wounds and bruises, and then cause rottenness and decay. As a damp and warm atmosphere favours the development of these destructive fungi, it is important to store fruit in cool dry places. Every effort should also be made to prevent bruising, and in order to minimise the risk of a 'mouldy' specimen spreading the infection to its neighbours, fruit of high value should be wrapped singly in tissue-paper before being packed or stored.

Ex. 278.—Soak a slice of bread in water and place it under a bell jar on wet blotting-paper; leave until mouldy. Various species of fungi make their appearance. Look especially for *Mucor Mucedo*, known by its round sporangia, which look like small pin-heads on the ends of thin white stalks.

When obtained, take up with fine pointed forceps a very small portion of the bread with mould on it, and transfer to a drop of water on a slide. Cover with cover-slip, and examine the hyphæ in the substance of the bread and the erect hyphæ bearing the sporangia.

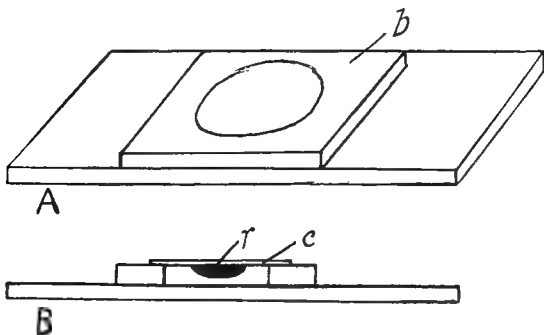

FIG. 231.—Moist chamber for observing the germination and growth of spores in hanging-drops. *b*, cardboard with circular hole punched in it, resting on ordinary glass slide. *B*, section of *A* with cover-slip (*c*) and hanging-drop (*r*) in position.

The sporangia, with ripe spores in them, burst immediately when placed in water.

Examine the oval spores with a high power.

To see the spores within the sporangia, take the hyphæ bearing them with

forceps and mount in alcohol on a slide : then examine quickly with a high power.

Ex. 279.—In order to observe the germination of these and other spores and watch their subsequent development for a time, a moist chamber, prepared as follows, is necessary :—

Place fifteen or sixteen pieces of blotting-paper on one another and punch out, or cut out, a round or square hole slightly less than the size of a three-quarter inch cover-slip. Cut the blotting-paper afterwards so as to fit on a slide, as in *A*, Fig. 231.

A piece of stout cardboard, cut in a similar manner, may be used instead of blotting-paper.

In the centre of a cover-slip place a small drop of water, or a drop of a very dilute extract of French plums which has been boiled. Shake or otherwise transfer the spore to be germinated into the drop of water, and then place the cover-slip over the hole in the cardboard with the drop hanging downwards, as in *B*, Fig. 231.

Keep the whole on damp blotting-paper under a bell-jar.

The spores can be readily examined from day to day, even with a high power, through the glass of the cover-slip without moving or disturbing the latter

CHAPTER XLVIII.

FUNGI (*continued*).

PHYCOMYCETES.

Sub-class ii.—Oomycetes.

1. IN this sub-class the mycelium resembles that of the Zygomycetes in being formed of non-septate hyphæ, but sexual reproduction is carried on by oospores, which are generally formed as the result of a fertilisation act between more highly differentiated reproductive organs, namely, between an oogonium and an antheridium, as described below in the account of the fungus causing the 'damping-off' of seedlings.

Asexual reproduction takes place by means of conidia, and also by means of motile zoospores, which are produced within sporangia of various forms. On account of their power of rapid movement in water the zoospores are specially adapted for distribution in dew and water generally. Dampness of soil and atmosphere greatly encourage the vigorous development of almost all species belonging to the Oomycetes, a fact which must be borne in mind when attempts are made to curtail their ravages.

Unlike the Zygomycetes, the Oomycetes are chiefly parasitic in habit, and the group includes some of the most destructive species of fungi which are known.

The genera worthy of especial mention are *Pythium*, *Phytophthora*, *Plasmopara*, *Peronospora*, *Bremia* and *Cystopus*.

2. The fungus causing the disease known as 'damping-off' may be studied as a type of the genus *Pythium* belonging to the Oomycetes.

'Damping-off.'

SYMPTOMS.—When certain kinds of seeds are sown thickly and kept very moist the young plants, especially in shaded places, turn yellow, and begin to die off in patches as soon as they appear above ground. Each affected seedling, when examined in an early stage of the disease, is seen to possess a weak, thin, and somewhat shrivelled place on the stem near the surface of the soil. On account of this weak point the upper part of the plant bends, or topples over, in a characteristic manner (*B*, Fig. 232).

It is noticed that soon after one seedling is attacked, others near it become similarly affected, and the disease spreads outwards in all directions until all the plants in the seed-bed are reduced to a rotten mass,

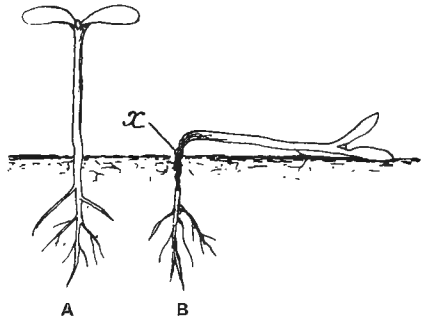

FIG. 232.—*A*, Normal healthy seedling. *B*, seedling which has 'damped-off'; *x* thin, shrivelled portion of its hypocotyl (natural size).

on which small patches of white 'mould' may be seen.

A new batch of seedlings raised on soil which has already carried a crop of diseased plants, almost always becomes attacked, and experience teaches that the cause of the infection remains active in such soil for many months.

Cruciferous plants, such as mustard and cress, are especially liable to 'damp-off,' and the disease is sometimes prevalent on spurrey, maize, mangel and clovers.

Some seedlings, such as peas, barley, poppy, potato and others appear to be exempt from the disease.

CAUSE.—The disease is caused by the fungus *Pythium de Baryanum* Hesse. The mycelium of the parasite is readily observed within the tissues of a seedling which has damped-off;

it consists of generally non-septate, branched hyphæ, which derive their nourishment from the cell-contents of the plant through which they ramify. For a short time the fungus is confined within the body of the diseased seedling, but after

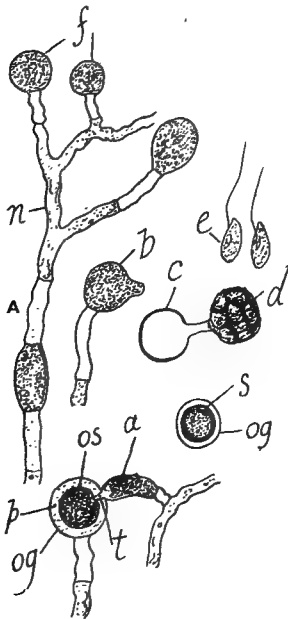

FIG. 233.—A, a portion of the mycelium of *Pythium de Baryanum*; *n* hypha; *f* conidia; *b* conidium beginning to germinate; *c* sporangium with zoospores in bladder-like germinated portion *d*; *e* zoospores; *og* oogonium; *p* periplasm; *os* oosphere; *a* antheridium; *t* fertilising-tube; *s* ripe oospore in the oogonium *og*. (All enlarged about 130 diameters.)

extending itself through all parts of the latter, the hyphæ grow out into the surrounding moist air and are able to reach across short distances to healthy neighbouring plants, which they immediately penetrate; in this manner the disease can spread from plant to plant. Moreover, the toppling over of the affected seedlings brings the fungus into contact with adjacent plants, and aids the distribution of the disease.

After a few hours the tips of the hyphæ give rise to the following reproductive organs:—

- (1) conidia.
- (2) sporangia.
- (3) oospores.

Each conidium is a round or slightly oval spore (*f*, Fig. 233), which, on germination, gives rise to a hyphal filament, or germ-tube, capable of penetrating seedlings and giving rise to a new mycelium.

A sporangium is similar to a conidium in form and size, but when placed in water its wall bulges out and forms a bladder-like process into which the contents of the sporangium are transferred; the protoplasm then divides into a number of zoospores, or swarmspores, which are subsequently

set free by the rupture of the enclosing bladder (*d*, Fig. 233).

Each zoospore is a small naked piece of protoplasm possessing two hair-like *cilia* (*e*, Fig. 233) by the movement of which it is able to move about in drops of water. After swimming for a short time the zoospore loses its cilia, rounds itself off, and then develops a delicate germ-tube capable of penetrating into the tissues of plants where it soon grows into a new mycelium.

These asexually-produced conidia, and sporangia arise in great numbers, and by their immediate germination are capable of spreading the fungus at a rapid rate.

In addition to the above asexual methods of propagation, a process of sexual reproduction occurs in this species of fungus. The female reproductive organ, termed an *oogonium*, is spherical (*og*, Fig. 233), and resembles a conidium or sporangium in shape. A certain portion of the protoplasm within it collects in the centre and becomes surrounded by a delicate membrane; this is the *ovum*, *egg-cell*, or *oosphere* of the oogonium, the rest of the protoplasm within the latter being termed the *periplasm* (*p*, Fig. 233). The male reproductive organ or *antheridium* (*a*) is a long, somewhat large cell cut off from the end of a lateral hypha arising near the oogonium. After coming in contact with the latter, the antheridium develops a delicate *fertilisation-tube* (*t*) which forces its way through the wall of the oogonium and, finally, reaches the ovum. A small portion of the protoplasm of the antheridium is then transferred to the ovum, after which act the latter develops a thick, external, brown, smooth coat at the expense of the surrounding periplasm: the fertilised ovum is then termed an *oospore* (*s*). The oospore is set free from the enclosing oogonium and, after a resting-period of several months has elapsed, it germinates and produces a germ-tube which penetrates into any seedling with which it comes in contact.

Although thick-walled conidia may remain dormant in the ground for some time and then germinate and reproduce the

fungus, infection of seedlings grown on soil which has previously carried a diseased crop, is mainly due to the oospores which are produced in thousands and remain on, or just below, the surface of the soil after the dead plants have completely decayed.

Pythium de Baryanum is not only a parasite but it is able to carry on its existence as a saprophyte.

PREVENTION AND REMEDY.—(a) Sow thinly and avoid excessive dampness of the seed-bed.

Usually much more water is given to seedlings growing indoors than is necessary for their vigorous growth. The fungus is specially invigorated by moist conditions and its hyphæ more readily penetrate plants containing superabundance of water.

(b) Avoid shade for the seed-bed and provide for the circulation of air among the seedlings.

(c) Carefully take up with a certain amount of the surrounding soil and burn all plants as soon as the disease is observed. In this way the spread of infection to the remaining plants may often be averted, whereas if the fungus has become established in the seed-bed it is almost impossible to curtail its ravages.

(d) Soil upon which 'damping-off' has previously been noticed should not be used as a seed-bed; in cases where this practice cannot be carried out, burning refuse on the surface of the land tends to destroy the fungus and its oospores.

(e) Deep-ploughing so as to bury the upper layers of the soil containing the oospores is beneficial.

Ex. 280.—Sow seeds of cress thickly in a box or flower-pot containing garden soil, and when the young plants are up, water them often. In this way specimens which are 'damping-off' may generally be obtained.

Or, procure 'damped-off' specimens of young seedlings of other plants from a gardener.

(a) Take up some of them and carefully wash away the adhering soil. Observe with a lens the shrivelled part of the stem where the seedlings bend over.

(b) Cut off a short piece of the stem including the shrivelled portion and mount in water on a glass slide. Examine with a low power, and look for the transparent hyphæ of *Pythium* on the surface of the stem.

(c) Place a similar piece of stem to that used in (b) in water on a glass slide: split it longitudinally with needles and tease out the parts. Cover with a cover-glass and press the latter firmly down on the slide, then examine with a high power. Observe the branched hyphæ, occasionally septate, among the cells of the stem issues. Are they inter- or intracellular hyphæ?

(d) In some cases, round conidia, sporangia, and oogonia will be noticeable.

(e) To obtain conidia, sporangia, and oogonia for examination place a diseased seedling in water in a watch-glass, and leave the whole under a bell-jar for a few days.

Oospores may also be found among the withered tissues of seedlings which have 'damped-off' and been allowed to remain until the whole plant has turned brown.

3. The genus *Phytophthora* of the Oomycetes is very closely allied to *Pythium*. The inter- and intra-cellular mycelia of the various species vegetate within, and speedily kill the tissues of their hosts, but the conidiophores and sporangiophores are exposed to the open air through the stomata of the infected plants. (Fig. 234). Conidia and zoospores are produced, the latter possessing two cilia each.

In one species, namely *Phytophthora omnivora* de Bary, spherical fertilised oospores occur, while in *P. infestans* oospores are said by some authorities to be absent.

P. omnivora is very destructive to seedling conifers, beech, and other trees, and must be combated by methods similar to those employed for *Pythium de Baryanum*.

P. infestans causes very extensive disease to the potato crop: its life-history, and the character of its mycelium and asexual reproductive organs are described below.

4. **Potato Diseases.**—It is important to point out that the potato plant is subject to several distinct ailments, one of which is still unfortunately styled 'the potato disease' as if there were no other. Although some of the fungi destructive to the potato

crop do not belong to the Oomycetes it has been found convenient and useful to mention them in this chapter.

(i) '**The Potato Disease,**' '**Late Blight,**' '**Phytophthora Blight.'**

SYMPTOMS.—This disease, which is met with wherever the potato is grown, usually makes its appearance in the British Isles about the end of July, and is first observed upon the leaves of the plant. The latter lose their green colour, and become spotted with yellowish patches which soon die and turn dark brown or almost black. In dry weather the dead patches increase very little, but in damp, foggy weather they spread over the leaflets on which they occur at an exceedingly rapid rate. After destroying the leaves, the disease attacks the stem and in severe cases the whole of the plant above ground is reduced in a few hours to a damp, shrivelled, and blackish mass of plant-debris, with a peculiar and characteristic foul odour.

Around the margin of each dead spot on the under surface of a diseased leaf there is a more or less distinct border of white or greyish 'mildew,' sometimes resembling fine flour, and most readily seen when the lower side of the leaf is viewed in a slanting direction. The presence of a whitish rim round each dead patch is highly characteristic of this disease, and enables us to distinguish it from others which kill the leaves, and from the natural withering and death of these organs at the end of the growing season.

As the growth of the tubers is dependent on the supply of materials manufactured by the leaves of the plant, an early destruction of the latter results in a diminished crop of potatoes. Moreover, when the leaves and stems above ground are severely attacked, the substance of the tubers, especially just beneath the skin, is frequently affected with brown dead patches. The amount of tissue thus injured varies considerably; in some cases only small spots are met with, while in others the whole tuber rots.

Although it has often been customary to associate most tuber destruction with the same cause as that which destroys the leaves and stems, it is certain that this view is in many cases incorrect if not in all.

CAUSE.—The fungus causing the disease is known as *Phytophthora infestans* de Bary. The silky bloom seen around the dead patches on the underside of the leaves consists of the branched hyphæ of the parasite. The unseptate mycelium permeates the tissues of the leaf and feeds upon the substances therein. In dry weather it vegetates within the leaf and does not produce reproductive organs, but in damp weather the mycelium gives rise to branched hyphæ which make their exit chiefly through the stomata of the leaves (Fig. 234). Upon the tips of these hyphæ, sporangia, and conidia are borne singly, which, after reaching their adult size, drop off or are pushed aside by the growth of a portion of the hypha immediately below them. Each sporangium is of oval form with a colourless membrane (c, Fig. 235); when kept in water for an hour or two the protoplasm within divides into 5 or 10 zoospores which escape from the apex of the sporangium (D, Fig. 235). The zoospores (z) are provided with two cilia by means of which they are able to swim about in rain-drops or dew-drops on the leaves of the plants. After swimming for a few minutes they lose their cilia, round themselves off (a), and soon develop a thin germ-tube (t) which penetrates into any potato-leaf on which they may occur; once inside the tissues of the leaf, the germ-tube develops into a new mycelium.

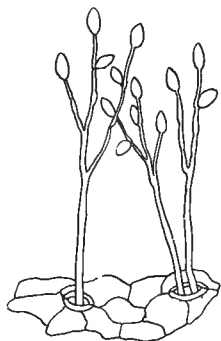

FIG. 234.—Hyphæ of *Phytophthora infestans* emerging through stomata of a potato leaf and bearing sporangia and conidia. (Enlarged about 100 diameters.)

The conidia are in all respects similar to the sporangium in shape and size, but they produce germ-tubes directly (C, Fig. 235).

It is by means of the zoospores and conidia that the potato plants are infected, and as these are produced in countless numbers, even by a single diseased plant, there is little wonder that the disorder spreads with great rapidity through a crop, when circumstances favour the production and germination of the spores. The latter are so light that their transport from plant to plant by even gentle breezes is easy; the beating of rain and planting so close that the leaves of neighbouring plants touch each

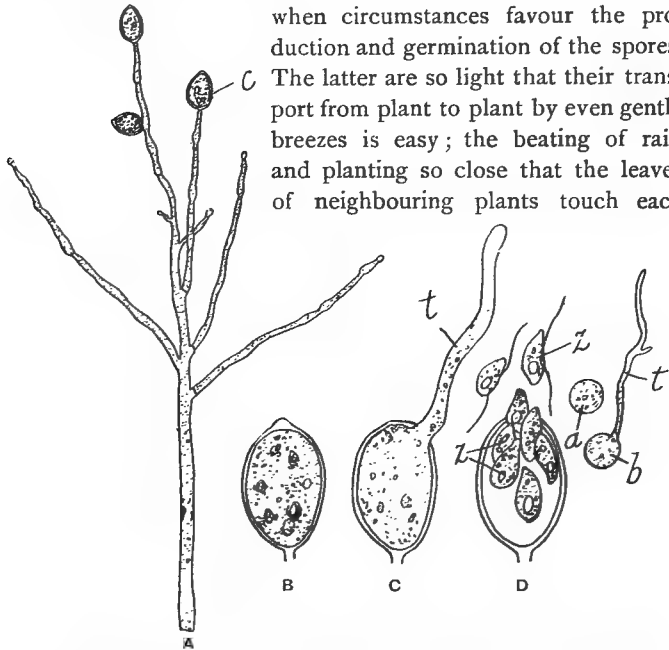

FIG. 235.—A, Conidiophore of *Phytophthora infestans* (enlarged about 200 diameters). B, Single conidium or sporangium. C, Conidium germinating; *t* 'germ-tube.' D, sporangium setting free its zoospores *z*; *a* zoospore at rest, later stage of *z*; *b* zoospore germinating, later stage of *a*; *t* germ-tube. (B, C and D, enlarged about 650 diameters.)

other, also aid in the distribution of the disease.

While the manner of rapid reproduction and distribution of the fungus and its destructive effects upon the stems and leaves of the potato plant are well understood, the amount of direct damage done to the tuber by *Phytophthora infestans* and the way in which it reaches the tuber is still a matter of uncertainty.

In the most frequent and ordinary attacks of the parasite, the stems and leaves of the crop are more or less injured, while the tubers show but insignificant traces of any form of disease.

Attempts to produce on healthy potatoes dead patches similar to those on tubers dug from the ground, by infection with spores of *Phytophthora* rarely, if ever, succeed, and we are of the opinion that the view that such well-known dead patches are directly due to this fungus has not been satisfactorily proven.

There is, however, little doubt that *Phytophthora infestans* is occasionally to be found in the tubers of diseased crops, and in such cases two views are held in regard to its mode of access, namely:—

(i) By growth of the mycelium down through the stem and along the rhizomes which bear the tubers; or

(ii) By spores which fall from the diseased leaves, and are carried by rain or other agents down to the tubers which they infect. Probably both opinions are correct in part.

How the fungus passes the winter and commences its ravages in the following summer is a much-debated question. The conidia and zoospores are short-lived, and the active mycelium appears to be met with almost entirely in the living tissues of the leaves and stems. As soon as the latter are killed the mycelium is much diminished or disappears altogether from those parts; nevertheless, how far the fungus can carry on existence as a saprophyte is not clear. It is generally assumed that the mycelium hibernates in the dormant tubers during winter, and after planting the tubers the following summer the hyphæ of the fungus grow into the new young shoots of potato, and finally make their way upward into the leaves above ground. From such diseased plants the parasite spreads to the surrounding crop by means of spores in the manner previously described.

Several workers at the subject nevertheless maintain that from disease-spotted tubers either healthy plants arise or none

at all. Some observers are of opinion that the fungus produces *oospores* similarly to the allied species *Phytophthora omnivora*, and that it is by means of these sexually-produced resting-spores that the fungus is reproduced in summer, the resting-spores having remained dormant during the preceding winter in the debris of old tubers and diseased haulm: other authorities hold that oospores are not produced by *Phytophthora infestans*. The evidence for and against the existence of sexually-produced spores is so conflicting that we consider no sound conclusion can at present be drawn in favour of either view.

Phytophthora infestans attacks and destroys the leaves of the tomato, petunia, bitter-sweet, and other members of the Solanaceæ.

PREVENTION AND REMEDY.—(a) It is a commonly observed fact that the several varieties of the potato are not all affected equally by the fungus: careful endeavour should therefore be made to determine which varieties are least subject to the disease in years when the malady is prevalent, and those only should be cultivated. As far as possible careful trial of new varieties is advisable, with a view of meeting with kinds highly resistant to the disease.

(b) Wherever feasible, collect and burn all the haulm and rotten tubers from the infested crop, and never allow diseased refuse to be thrown on the manure heap. This advice is based on the assumption that the fungus is capable of existing in some form through the winter in such refuse, and is liable to spread the disease in the following summer.

(c) Avoid using for 'seed' apparently sound tubers from a badly diseased crop; for according to some authorities it is within such tubers that the mycelium hibernates and spreads the disease in the following summer as explained above.

(d) 'Moulding-up' or covering the tubers with a considerable layer of soil is said to diminish the attacks on the tubers

by preventing the spores from being washed or otherwise carried down to them. When this is practised the rows of potatoes should be wider apart than usual, to allow of plenty of loose earth to be hoed up to make the ridges. Bending the haulm of a diseased crop into the furrow on one side is also advised, with a view of allowing the spores to fall on that part of the surface of the soil beneath which there are no tubers.

(e) When the haulm has been much affected by the fungus, remove it from the ground before digging up the tubers: this is said to partially diminish subsequent rotting in the store-shed or clamp.

(f) Be careful in the use of highly-nitrogenous manures, for crops grown with excess of these are more susceptible to virulent attacks than when manured with potash salts and phosphates.

(g) As the fungus is specially aided in its development and distribution by moist surroundings, drainage and the addition of substances which will diminish the moisture of damp soils, or which will allow the rapid percolation of water through the ground, are advisable.

(h) When properly carried out spraying the leaves of the crop with 'Bordeaux mixture' is the most efficient means at present known for diminishing the *Phytophthora* disease.

The mixture consists of copper sulphate and lime. Various amounts of these constituents are employed, but a common useful formula is:—

Copper sulphate	.	12 lbs.
Quicklime	.	8 lbs.
Water	.	100 gallons.

prepared as follows:—

Powder the copper sulphate, and then dissolve it in a moderate quantity of hot water in an *earthenware* or *wooden* vessel. When quite dissolved add 60 or 70 gallons of *cold* water to the solution.

Next, thoroughly slake the requisite amount of *newly-burnt quicklime* in another vessel, keeping it well stirred during the slaking process. When *quite cold*, stir the lime-water again and filter it through coarse sacking into the vessel containing the copper sulphate, and make up the bulk to 100 gallons by adding more water if necessary.

As copper sulphate by itself is injurious to plants, it is important that none of it should exist in a free state in the liquid after its preparation, which is sometimes the case when old quicklime is used. If a little of the mixture gives a brown or chocolate colour when tested with potassium ferrocyanide solution, more fresh lime-mixture should be added.

Although an excess of lime is not injurious to the plants in any way, yet neutral solutions are found to adhere to the leaves much better than either basic or acid mixtures. When a great excess of lime is used the resulting mixture is almost valueless.

As the mixture has little practical effect on the disease when once established in a crop, it is very necessary to spray before the actual appearance of the 'blight,' and in wet seasons the application should be repeated at intervals of two or three weeks, as occasion may suggest.

'Bordeaux mixture,' although not a very powerful fungicide, hinders the germination and growth of the spores, and thus prevents the spread of the disease.

Besides acting directly as a check on the fungus, it has a markedly beneficial stimulating effect on the potato plant. The leaves of the latter when sprayed become firmer, transpire more, and remain green, and carry on their work longer, than those of plants which are unsprayed. Similar extraordinary reaction to 'Bordeaux mixture' is observable in the vine, pear and other plants. In the case of the potato, the increased activity of the tissues of the leaves, and the longer time which they continue their work after spraying, results in a greater manufacture of

starch and other plastic reserve-materials and a consequent increase in the yield of tubers.

It is well to point out that in one or two cases where spraying has been continued till a somewhat late period, the plants have been so slow in ripening that the farmer has not been able to dig his crop soon enough to secure an early market. This experience is, however, exceptional and can easily be avoided.

Ex. 281.—Examine the dead patches on the leaves of potatoes in July, August and September for *Phytophthora infestans*. It appears as a greyish-white mould round the margins of the dead patches.

Observe the progress of the diseased spot from day to day, noticing the colour-changes of the leaf.

Ex. 282.—Place a piece of diseased leaf, with the underside upwards, on a slide and examine the fungus with a low power.

Ex. 283.—Cut transverse sections of the leaf through the edge of diseased spot on a leaf and mount in water. Note the sparsely branch conidiophores and the mycelium within the leaf-tissues. The conidia break off so easily that few or none will be observable in sections prepared in this manner.

Ex. 284.—To obtain a luxuriant growth of the *Phytophthora* place five or six leaves showing the first symptoms of disease one upon another on a plate under a bell-jar. Sprinkle the leaves with water and allow them to remain for twenty-four hours. The fungus may then be seen as a downy film on almost all the leaves.

Tear off a small portion of the lower epidermis of a leaf where the parasite is abundant and mount in water. Examine with a high power and examine portions of the conidiophores and conidia. Observe the swollen parts of the conidiophore where conidia have dropped off.

If no conidia are found attached to the conidiophores, tear off a similar piece of epidermis and transfer immediately to absolute alcohol or strong methylated spirit. Leave the preparation in this for thirty seconds, and then carefully transfer successively to 50 and 25 per cent. alcohol, and finally to water. Examine with a $\frac{1}{8}$ -inch objective.

(ii) *Macrosporium* Disease: 'Early Blight.'

A disease of the potato leaf frequently spoken of as 'Early Blight' is very common in some parts of America and possibly more common in this country than has been imagined. It is caused

by the fungus, *Macrosporium Solani* Ell. et Mart., only conidial forms of which are known. The conidia and hyphæ bearing them are brown. Each of the former when fully developed is

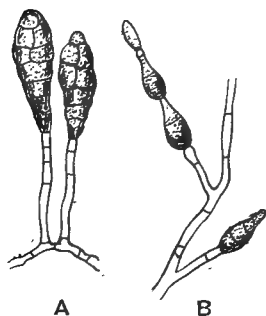

FIG. 236.—A, Portion of hyphæ and conidiophores of a species of *Macrosporium*, showing two compound conidia. B, the same of a species of *Alternaria* (enlarged 250 diameters).

somewhat spindle-shaped and formed of several cells as at A, Fig. 236. The mycelium is colourless and penetrates into the tissues of the leaves upon which it usually causes small greyish-brown patches, which are much slower in development and paler in colour than those due to *Phytophthora infestans*. The disease often occurs early in the season when the plants are not more than 5 or 6

inches high, especially in dry weather and in dry situations. In severe cases, where the leaves or large areas on them are killed at an early stage

of growth, the crop of tubers is necessarily small but is always sound. A fungus, designated *Alternaria Solani* by Sorauer, and very nearly related to the above *Macrosporium* if not identical with it, has been observed to cause a leaf-disease of the potato plant in many parts of Germany similar in all respects to the American 'Early Blight.'

Both these species belong to an imperfectly known group of fungi which are mainly saprophytes, but which appear to be capable of attacking plants when the latter have been previously weakened or injured by excessive heat, dryness of soil and atmosphere, and depredations of insects. The application of Bordeaux mixture is found to be very beneficial in such attacks.

Ex. 285.—Examine dead patches on the surfaces of potato leaves with a low power and search for *Macrosporium* or *Alternaria Solani*. If found, the

spot should be wetted and 'gently' scraped with the point of a pen-knife : transfer the small portions scraped off into water and examine with a low power. If present, the dark-coloured multicellular conidia are readily observed.

(iii) Diseases of the potato tuber.

The fungi previously mentioned mainly destroy the leaves and stems of the potato plant, and although it is possible that under certain circumstances *Phytophthora infestans* does direct damage to the tubers, the most extensive destruction of the tubers is chiefly due to other causes, many of which are at present imperfectly understood.

(1) 'Wet-rot.'—In damp, warm seasons the tubers under ground often suffer from what is termed 'wet-rot,' and the same or a similar malady is very frequently observed among potatoes stored in 'pies,' clamps and sheds. Moreover, the sound tubers of early Ashleaf varieties, on the leaves of which no *Phytophthora* has been observed, become affected with this sickness if left in the ground for a time in such seasons.

The disease begins with the formation of dead patches immediately beneath the skin of the potato, and the whole interior is soon altered into a brown, watery and slimy pap, often distended with gases. It is observed that the cell-walls of the tissues are disunited, and the cell-contents, except the starch-grains, changed and fermented by the activity of a number of different species of bacteria. Recent work appears to indicate that some of these bacteria present are capable of attacking sound tubers and are primarily responsible for the disease, although much of the putrefaction is due to saprophytic bacteria and fungi which obtain access to the tissues, after the latter are killed by parasitic species.

The fungus *Rhizoctonia Solani* Kühn. with a purple violet

mycelium is parasitic upon potato tubers; it appears to injure the latter and prepare an entrance for bacteria of various kinds which subsequently give rise to a 'wet-rot': other parasitic fungi no doubt aid the production of 'wet-rot' in a similar manner.

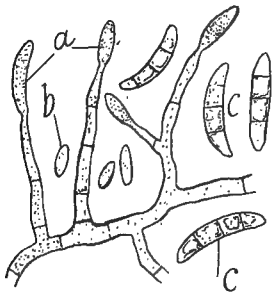

FIG. 237.—A portion of the mycelium of *Fusarium Solani*. *a* Conidia *in situ*; *b* detached simple conidium; *c* fully developed compound conidia (enlarged about 300 diameters).

(2) **Fusarium disease: 'Dry-rot.'**—

Just as there are several forms of 'wet-rot' disease, so are there several 'dry-rots.' One form of the latter prevalent in many districts is due to the fungus *Fusarium Solani* Sacc. (= *Fusisporium Solani* Mart.) which is probably an ascomycete, but only known in a conidial state. The hyphæ are septate and branched, and the conidia at first single, oblong or oval cells, which when fully developed become somewhat crescent-shaped and divided into three or four cells by transverse septa (Fig. 237).

The fungus can live a saprophytic life in the soil, but is also capable of behaving as a parasite, attacking and damaging the roots, stems, and tubers below ground in the late summer. Usually, however, the effects of the fungus are not manifest in the tubers until these have been stored some time, the disease making its appearance just after Christmas. The tubers shrink and the skin becomes wrinkled; the contents within are changed into a more or less hard, grey, crumbling mass, sometimes resembling dry gritty chalk.

The fungus is usually conspicuous on the outside of diseased tubers in the form of small white spots of 'mould.' It most frequently makes an entrance through small wounds or cracks on the surface, but is able to attack sound tubers when brought in contact with them. The hyphæ penetrate and kill the cells, after which the cell-walls and protoplasm become brown and

partially consumed; the starch, however, remains untouched, and the crumbling substance within the tuber so characteristic of the disease consists of starch-grains mixed with the unused residue of the cell-walls and protoplasm of the tissues.

In many instances the fungus is accompanied by bacteria, and the appearance of the disease is then considerably altered, so much so that the 'dry-rot' may become a 'wet-rot.'

In order to prevent the disease from spreading, clamps or 'pies' should be opened and all infected tubers taken out and destroyed by fire.

(3) Brown spots, which do not increase on keeping, and which are irregularly distributed in the substance of the otherwise sound tuber, are frequently observable. No parasitic organism is ever present in such spots, and the cause is unknown.

Ex. 286.—Look over stored potato tubers in winter or early spring and examine any white moulds which may be present upon them.

Transfer the moulds into water, or into strong alcohol for a few seconds, and then into weaker solutions, as described in **Ex. 284**.

Fusarium Solani is commonly met with.

When found, notice the character of the interior of the tuber, whether hard or soft, wet or dry.

Transfer with a knife-point *Fusarium* spots to the cut surfaces and uninjured surfaces of potato tubers. Place the latter on a plate under a bell-jar and keep slightly moist. Examine the growth day by day for a fortnight.

Ex. 286a.—Cut sections of pieces of the exuberant tissue of Potato-wart disease and make drawings of the sporocysts of *Synchytrium endobioticum*. Note the colour and thickness of the wall and the spores within.

(4) 'Scab.'—This term is applied to various irregular forms of rusty rough excrescences on the tubers of the potato. At the points where the 'scabs' exist there is an abnormal production of cork-tissue which generally commences from the lenticels of the periderm. In certain cases the malady is confined to the surface, while in others it penetrates some distance into the substance of the tuber.

Rusty scabbed areas on the potato tuber may be produced by various agents.

(i) One form in which small irregular corky patches are

present is attributed to the fungus *Oospora scabies* Thaxter, known only in the conidial state. The hyphæ are very short and slender, and give rise to chains of small oval conidia; the scabs are somewhat greyish in appearance when the fungus is abundant.

Closely resembling this is a scab, said by Roze to be due to the attack of a *Micrococcus*.

(ii) Another form in which there is a development of corky tissue in somewhat larger patches is brought about by the parasitic action of *Spongospora scabies* Mass., an organism belonging to the Myxomycetes or slime-fungi.

(iii) In some cases the trouble appears to arise from the application of lime, ashes, or alkaline dung to the soil.

(iv) The millipedes *Julus pulchellus* and *J. terrestris* take advantage of any damaged area on the skin of the potato, and increase the wound by eating deeper into the healthy part: a scabbed appearance results.

'Scabby' potatoes should not be used for sets, and ground on which 'scabbed' crops have been raised should not be planted with potatoes for some time.

Where the disease is prevalent, dressing the tubers before planting with dilute solutions of corrosive sublimate (mercuric chloride) has been found very beneficial.

One ounce of corrosive sublimate should be dissolved in two gallons of hot water in a *barrel* or other *wooden vessel*, and allowed to stand all night. In the morning add eight gallons of water, so as to make up the whole solution to ten gallons. Then place the 'seed' tubers to be treated in a coarse sack and suspend or soak the whole for an hour and a half in the liquid. After drying, the potatoes may be planted. The same solution may be used a number of times.

Corrosive sublimate is a most powerful poison, and great care is needed when dealing with the pure substance or strong solutions of it.

Soaking the 'seed' tubers for an hour in weak Bordeaux mixture (p. 700) is said to be a useful method of diminishing the disease.

(5) **Potato 'Wart.'**—This disease, sometimes erroneously termed 'Black Scab,' was first noticed in Hungary in 1896, and since then has become very prevalent in many parts of England during the last five or six years, and has occurred in Scotland and Ireland.

It is characterised by irregular warty or coralloid protuberances, which grow from the eyes of the tubers and from buds on the rhizomes below ground. The warts may be less than a small pea in size, or as large or larger than the tuber on which they grow.

The diseased abnormal growths are due to the attack of a parasite, *Synchytrium endobioticum* (Schilb.) Percl., which belongs to the Chytridiaceæ, a group of organisms usually included among the lower fungi.

In a section cut through a piece of the warty tissue in autumn the parasite is seen in the form of round sporangia or sporocysts within the thin parenchymatous cells of the tissue. Each sporocyst has a thick brown coat, on the outside of which are irregular thickenings. Within is a thin transparent lining containing hundreds of minute zoospores (Fig. 237A, 1).

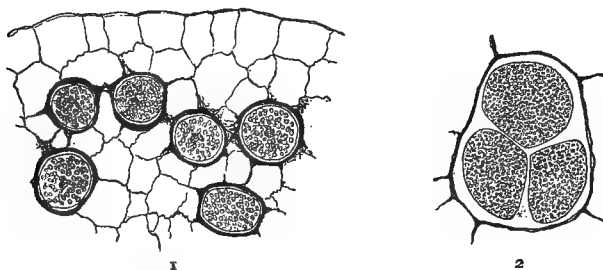

FIG. 237A.—1. Section through piece of 'warty' tissue of potato showing thick-walled sporangia of *Synchytrium endobioticum*. 2. Sorus of three summer sporangia.

In spring the outer coat of the sporocyst cracks and the motile zoospores are set free through the opening. They are able to swim about in drops of water, but after an hour or less they become amoeboid (Fig. 237B), and when brought in contact with the delicate tissue in the eye of a young tuber they penetrate into the interior of the cells, where they grow and feed upon the cell contents. The invaded cell for a time grows in size with increasing growth of the parasite, but is finally destroyed and the material within it largely consumed. The surrounding cells are stimulated; rapid division and growth occurs among them, and a wart is soon produced.

The protoplasm of the parasite, after reaching a certain stage of growth, secretes a thick covering for itself and divides into a large number of zoospores, which may escape during the summer and carry on infection in other parts of the potato on which they are grown. Similar sporocysts when produced late in the season remain dormant during the winter. In the early part of the growing season the protoplasm of the parasite often divides into two to five portions, round each of which a thin wall is secreted (Fig. 237A, 2).

These portions become sporangia, inside which are developed hundreds of small zoospores slightly smaller in size than those present in the thick-walled sporocysts. Such sporangia germinate during the summer and the escaping zoospores spread the disease.

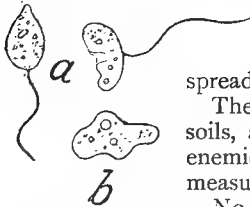

FIG. 237B.—Zoospores of *Synchytrium endobioticum*. a, motile; b, amoeboid.

The disease is most prevalent on light sandy soils, and is likely to become one of the worst enemies of the potato grower unless stringent measures are taken to stamp it out.

No effective remedies are known, and when once established in a field or garden it is difficult to deal with the pest.

The sporocysts or the parasite in some form may remain in uncropped soil for two or three years and be able to infect potatoes planted there after that period has elapsed. Where the disease has occurred, the land should not be cropped with potatoes for five or six years, and tubers coming from infected districts should not be used for seed.

5. The fungi belonging to the genera *Plasmopara*, *Bremia* and *Peronospora* attack and destroy the tissues of plants in a similar manner to *Phytophthora infestans*. The distinguishing morphological characters of the genera cannot be here discussed; it may, however, be noted that the hyphæ bearing the asexual reproductive organs are variously branched, and make their exit in tufts through the stomata of their hosts; they are produced in such abundance that the affected parts appear covered with patches of white 'mildew.'

Button-shaped and branched haustoria are met with on the intercellular mycelia of these fungi. The conidia and sporangia, by means of which the fungi are rapidly reproduced, are oval or

round. All produce resting oospores which are developed within the tissues of the host, and set free when the latter decays; some of the oospores arise without a definite fertilisation act.

Plasmopara viticola Berk. causes the 'downy or false mildew' on the vine, a disease far more destructive, and quite different from, the 'true vine-mildew,' mentioned on p. 757. The fungus attacks the leaves, young shoots and berries of the vine, causing these parts to turn brown and fall off.

Bremia Lactuæ Regel. is a parasite frequently met with upon various species of Compositæ and especially destructive to forced lettuce.

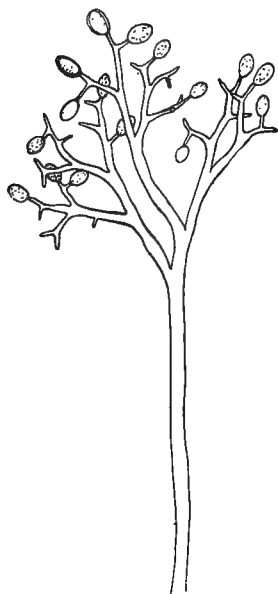

FIG. 238.—Conidiophore of *Peronospora Viciae* Berk. (Enlarged 100 diameters.)

Peronospora Trifoliorum de Bary, on clover; *P. Viciae* Berk., on vetches, peas and beans (Fig. 238); *P. parasitica* Pers., on crucifers; and *P. Schleideni* Ung., on onions, are all common, very injurious fungi belonging to the Oomycetes.¹

Spraying with Bordeaux mixture, or other solutions of copper salts, is the most efficient method of directly checking the ravages of these pests.

In several species the oospores are usually produced in autumn and remain dormant until the following spring. As these reproductive bodies enable the fungi to pass from one year to another, it is important to pay special attention to the disposal of refuse containing them. Wherever feasible, the burning of all diseased plant-debris should be practised.

The genus *Albugo* (= *Cystopus*) differs from those of the

Oomycetes previously mentioned, in that its conidia and sporangia are arranged in chains (Fig. 239), instead of singly at the ends of the reproductive hyphæ. Conidia, zoospores and oospores are also produced.

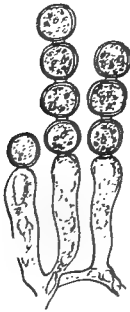

FIG. 239.—Conidiophores of *Cystopus candidus* Pers., with chains of conidia. (Enlarged 200 diameters.)

The commonest species, *Albugo candida* Kuntz. (= *Cystopus candidus* Pers.), attacks cruciferous plants all over the world, and is especially abundant on the leaves, stems and fruit of shepherds' purse, which it deforms.

The conidia and sporangia are produced in great numbers beneath the epidermis of the infected plants, causing white porcelain-like patches on the various parts attacked, hence the name 'White Rust' applied to this disease. After a time the epidermis is ruptured and the spores escape and become distributed by the wind and rain. It appears that the parasite can only effect a successful entrance into shepherds' purse through the cotyledons, so that old plants are not infected by the spores.

The Oospores, which have a thick warted or wrinkled coat, are not formed by the fungus when parasitic on shepherds' purse, but appear in abundance on other cruciferous hosts.

Ex. 287.—The student should be made practically acquainted with the form of the conidiophores, conidia, and oospores of *Bremia lactuca*, and the common species of *Peronospora* on Leguminosæ, Cruciferæ, and onions.

Ex. 288.—Examine specimens of 'white rust' (*Albugo*) on shepherds' purse. Observe the deformities produced and the smoothness of the white patches. Cut sections through a white spot on the stem and examine in water with a high power. Make drawings of the conidia and mycelium in the stem tissues.

CHAPTER XLIX.

FUNGI (*continued*).

BASIDIOMYCETES.

1. THE **Basidiomycetes** are an extensive class of the Higher Fungi, the species of which are very variable in size and shape, but all characterised by the production of a more or less distinct form of conidiophore, termed a *basidium*, upon which are borne a small and often very definite number of simple conidia designated *basidiospores*.

Sexual reproduction is quite unknown, and endospores within sporangia are also absent.

Two sub-classes are recognised, namely, (1) the **Hemibasidii**, to which belong the 'smut'-fungi so destructive to cereals; and (2), the **Eubasidii**, which includes the parasitic 'rust'-fungi and also a vast group of higher forms, mainly saprophytic, of which the mushroom, toadstools, and puff-ball fungi are examples.

Sub-class 1.—**Hemibasidii**.

2. The **Hemibasidii** are typical parasites which chiefly attack flowering plants and especially the cereals and grasses. Their mycelia are usually very slender at first, but after a time certain portions, or the whole of their hyphæ, swell and become divided up in the production of vast numbers of dark-coloured chlamydo-spores which in some species are only produced within the tissues of the host at very definite points, such as the ovaries, nodes of the stem, and certain limited areas of the leaves.

The chlamydo-spores very frequently rupture the tissues in which they are produced, and appear on the outside as a black powder resembling soot.

They are resting-spores which usually lie dormant during winter and germinate in spring; they can, however, germinate after being kept for several years, and are capable of withstanding considerable variations of temperature without injury. The short hypha arising from the chlamydospore is frequently termed a *promycelium*: Brefeld and others regard it as a basidium-like conidiophore and term it a *hemibasidium*; it differs from the typical basidium of the Eubasidii in that it produces a variable and irregular number of conidia instead of a small definite number.

Although in some species the promycelium penetrates and infects the host-plant directly, in the majority of cases it produces conidia (sometimes termed *sporidia*) whose germ-tubes enter the tissues of young plants.

The **Hemibasidii** are divided into two orders or families, namely :—

(1) The *Ustilaginaceæ*.

(2) The *Tilletiaceæ*.

In the former family the conidiophore is divided transversely into 3 or 4 cells (Fig. 240), and its conidia are borne laterally, while in the Tilletiaceæ the conidiophore is undivided and bears conidia in a whorl at its apex (Fig. 244).

(1) *Ustilaginaceæ*.

3. As examples of the Ustilaginaceæ, the 'smut'-fungi so common on the cereals may be studied.

(i) 'Smut' of Oats.

SYMPTOMS.—In looking over an unripe field of oats in June or July ears are seen in which the grains are replaced by a loose brownish or dark olive-coloured powder resembling soot. The powder is easily blown or washed away, and after this has happened nothing remains of the ear but the rachis and its branches, the chaffy glumes and the grain being totally destroyed.

The disease attacks the ears only, and previous to their escape from the uppermost leaf-sheath, the whole plant appears to be

healthy, the straw very rarely showing any evidence of 'smut.' It is generally observed that when one ear is destroyed, all the others produced by the same plant are similarly injured.

'Smut' is known in some localities as 'dust-brand,' and 'chimney-sweeper,' and in former times frequently destroyed from 30 to 50 per cent. of the oat crop on some farms.

CAUSE.—The 'smut' or sooty powder is composed of thousands of chlamydo-spores of the fungus *Ustilago avenae* Jens.

Each chlamydo-spore (Fig. 240) is round or oval in form and possesses a thick, dark, olive-brown outer coat which is slightly rough, and a thin transparent inner one.

When placed in water, after resting through winter the spores readily germinate and each gives rise to a short

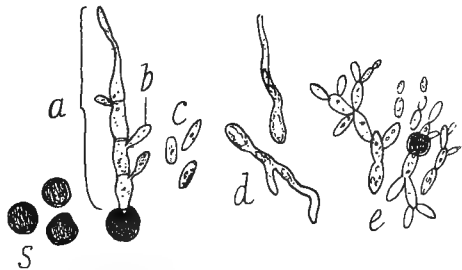

FIG. 240.—*S* Chlamydo-spores of oat-smut, *Ustilago avenae* Jens.; *a* conidiophore with conidia *b*; *c* detached conidia; *d* conidia germinating in water; *e* 'budding' of the conidia as seen when the latter are grown in nutrient solutions (enlarged about 500 diameters).

hypha, or conidiophore which is often termed a *promycelium*. The latter is divided into cells by four or five transverse septa, and from it are produced small transparent conidia, one from each cell as at *b*, Fig. 240. When these fall off others are produced from the same cells of the promycelium. In ordinary water the conidia give rise to delicate germ-tubes (*d*), but in water from dung-heaps and in solutions of nutrient materials generally, they multiply rapidly for a time by 'budding' (*e*); after the superabundant food is diminished, each conidium formed in the 'budding' process may develop a germ-tube.

Although the chlamydo-spores from diseased ears are blown on to the leaves of surrounding healthy plants, they do not spread

disease in the crop. It is found, however, that the germ-tube of the conidia penetrates into extremely young plants, and that this infection takes place in the soil. In the ordinary course of things the grains and the 'smut' spores adhering to them from the previous season are sown together in the spring. Both the grain and the chlamydospores germinate about the same time, and the germ-tubes of the conidia produced from the latter, penetrate into the first leaf-sheath of the oat plants while these are but a few hours old.

Once inside a young plant, the germ-tube grows and branches, extending itself from cell to cell until it reaches the growing point, and as the latter shoots upward the mycelium of the fungus steadily advances with it: at the same time there is little or no external evidence of the presence of the parasite within the tissues of the infected plant. The older hyphæ in the lower parts of the plants soon die away, their protoplasm being continuously transferred to the advancing hyphæ so that at any particular moment the mycelium of the fungus is only discoverable in the youngest upper portions of the oat stem. When the ear is developing the fungus enters the ovary of the flower and feeds upon the plastic materials which would ordinarily be stored in the endosperm tissue for the benefit of the embryo. In consequence of the increased nutrition the mycelium develops extensively, permeates all parts of the flower and destroys almost each hypha, finally completely dividing into a number of separate chlamydospores which burst through the remaining epidermal tissue of the glumes and grain. Brefeld's recent researches have shown that the oat plant may also be infected through the open flowers. The 'smut' spores blow about at the time of flowering, germinate on the stigmas, and penetrate into the ovary below. After gaining an entrance in this way, the fungus remains dormant in the grain until the latter is sown in spring, when it invades the young awakening embryo.

'Smuts' of Wheat, Barley and Rye.—Formerly all 'smut'-fungi on these cereals and on oats were considered as one species. Small morphological differences are, however, observable between the 'smuts' from the different cereals, and it is also found impos-

sible to infect one kind of cereal with the 'smut' spores obtained from another species.

(ii) **Wheat-'Smut'** (*Ustilago Tritici* Jens.).

The fungus destroys the walls of the ovary and the glumes, and the chlamydospores are blown away from the plant before harvest. Each chlamydospore is round or oval, olive-brown, with a slightly rough outer coat, and on germination produces a promycelium which does not bear conidia.

Brefeld states that the entry of 'smut'-fungi into wheat takes place through the flowers chiefly and rarely, if at all, through the young plants, as in oats.

(iii) **Barley-'Smuts.'**

Two species of *Ustilago* are met with upon barley, namely, **Naked or Loose 'Smut'** (*U. nuda* Jens. = *U. Hordei* Brefeld) and **Covered 'Smut'** (*U. Jensenii* Rostr. = *U. Hordei* Pers.). The former, which is the more common in this country, destroys the ear and its chlamydospores are blown away before harvest (A, Fig. 241). The chlamydospores of this species produce a promycelium which bears no conidia (II, Fig. 242) and cannot be distinguished from those of *U. Tritici* except by infection experiments.



FIG. 241.—A, Naked smut of barley (*Ustilago nuda* Jens.); B, covered smut of barley (*Ustilago Jensenii* Rostr.) (natural size).

The chlamydospores of the covered 'smut' do not break out from the glumes of the barley ear but remain within the latter until the crop is harvested (*B*, Fig. 241). They are smoother than those

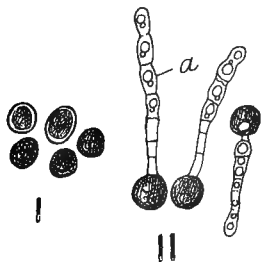

FIG. 242.—I Chlamydospores of naked smut of barley; II the same germinating (enlarged about 500 diameters).

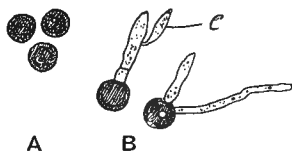

FIG. 243.—A, Chlamydospores of covered smut of barley; B, the same germinating (enlarged about 500 diameters).

of *U. nuda* and their promycelia give rise to conidia (*B*, Fig. 243). The fungi appear to infect barley through the flowers chiefly, as in wheat.

(iv) **Rye-'Smut'** (*U. Secalis* Rabenh.) is a rare species.

PREVENTION AND REMEDY FOR 'SMUT' FUNGI.—(a) On small plots it is possible to pluck off and burn all affected ears before the chlamydospores are sufficiently ripe to be carried about by the wind.

(b) The chlamydospores of the smut-fungi which adhere to the seed-corn and spread the disease may be killed by soaking the grain for five minutes in water at a temperature of 55° C. (131° F.). The grain enclosed in a coarse sack should first be steeped in a tub of water kept at 48° or 50° C. (121 F.) in order to warm it before finally transferring it to the hot water. After remaining for five minutes in the water at 55° C. it must be taken out and plunged into cold water. The grain may then be spread out on a floor to dry before sowing.

This process if properly carried out does not materially injure the germinating capacity of the grain. It is especially useful and effective for prevention of smut in oats, and is also applicable to wheat, rye, and barley. The embryo of barley is however

more easily injured than that of the other cereals mentioned, and a temperature not higher than 53° C. (or 126° F.) should be employed when dealing with this grain.

(c) i. Dissolve one pound of copper sulphate in five quarts of boiling water in a wooden bucket or copper pan, and when cool pour the solution over 4 bushels of grain spread on the barn floor. Shovel the grain about in order that the solution may wet all the grains; then allow the whole to dry before sowing.

Or, ii. Dissolve half-a-pound of copper sulphate in ten gallons of water and place the solution in a wooden vessel; soak the seed-corn in this for 12 to 16 hours, taking care that the surface of the solution is at least three inches above the grain in the vessel. Then remove the grain and spread it out to dry for 24 hours before sowing.

Both the above methods of 'pickling' or 'dressing' the seed-corn leaves each grain covered with a thin film of copper sulphate: and although the latter is incapable of killing the chlamydo-spores themselves it protects the grain, for the promycelia and conidia produced by the spores are destroyed when they come in contact with it.

By sowing untreated and treated portions of the same sample of grain side by side in the same soil, it may readily be proved that 'pickling' with solutions of copper salts destroys the germinating power of a considerable amount of the 'seed' grain, the proportion killed depending on the strength of the solution, the time during which it acts and the nature of the grain itself.

If Brefeld's researches are correct, 'pickling,' which aims at the destruction of spores on the outside of the grain, can be of little use for diminishing smut in barley and wheat where the fungus is in the seed itself and the young plants immune to external attacks. In these two cereals seed grain must, as far as possible, be obtained from healthy crops.

'Pickling' processes, however, are said by many to reduce smut in wheat, rye, and oats, and is believed to be effective against the attacks of 'covered' smut (*U. Jensenii* Rostr.) in barley: it does not, however, diminish the 'naked' smut (*U. nuda* Jens.) in barley so satisfactorily. According to some authorities the chlamydo-spores of the latter species of smut are blown at the time of flowering in between the glumes, and are thus securely protected from the direct action of any poisonous compound which only wets the outside of the grain.

(d) Another method which is destructive to the 'smut' and which does not so seriously diminish the germinating capacity of the grain is the following:—

Soak the grain for 12 to 16 hours in a $\frac{1}{2}$ per cent. solution ($\frac{1}{2}$ lb. in 10 gallons) of copper sulphate. Then run off the solution of copper sulphate and pour over the grain a solution of milk of lime made by adding 7 lbs. of good quicklime to 10 gallons of water. Stir the grain in the lime-water for five minutes, after which remove it and spread it out to dry before sowing.

(e) Soaking the seed in a .2 per cent. solution of formalin for two hours is recommended as a cheap and efficient remedy for many of the smuts of cereals.

Ex. 289.—Examine the smutted ears of the common cereals, wheat, barley, and oats.

As soon as one diseased ear is noticed, examine the others growing from 'tillers' of the same plant.

If some of the ears are still in the leaf-sheath, open the latter and see if these young ears are already smutted.

In which part of the ear, the lower or upper half, is the smut first observable?

Ex. 290.—Examine in water with a high power the chlamydo-spores of the various species of smut. Draw a single spore of each.

Ex. 291.—Keep some smutted ears of the different cereals through winter, and in spring place some of the chlamydo-spores of each in separate drops of water on glass slides.

Put these all under a bell-jar on damp blotting-paper. Examine with a low power every twelve hours.

When the spores have germinated, place over the drop of water a thin cover-slip and examine with a high power. Make drawings, and contrast and compare the conidiophores and conidia developed from each species of chlamydo-spore.

Ex. 292.—Dip 50 grains of wheat in water, and then thoroughly dust them

with smut-spores obtained from wheat-ears. Sow these grains, and near them sow 50 more grains from an ordinary sample of wheat. Allow them to grow, and note which is most smutted.

Ex. 293.—Sow small sample of grain dressed in the various ways mentioned in 'Prevention and Remedies for Smut,' pp. 717 to 719, and observe the behaviour of each as regards germinating capacity and rapidity of germination.

4. Many other species of the genus *Ustilago* are met with on grasses, sedges, various Compositæ, Polygonaceæ, and other plants.

Maize smut, *Ustilago Maydis* D.C., gives rise to large deformations on the ears, leaves, and stems of the maize plant. The malformations are at first white, and are subsequently filled with millions of dark-coloured chlamydo-spores, which have a finely spinous or warted epispore.

(2) *Tilletiaceæ.*

5. As an example of the Tilletiaceæ or second family of the Hemibasidii, the 'bunt' of wheat may be studied.

'**Bunt**' or **Stinking-smut of Wheat.**—Wheat plants affected with this disease are in their early stages of growth generally a darker bluish-green colour and more robust and luxuriant in appearance than healthy plants. When the ear is ripe it remains stiff and erect; the bunted grains within it are found to be plumper and shorter than normal grains, and filled with a black, somewhat oily powder, which possesses a disagreeable odour of stale herrings. The glumes of the ears look white and bleached, and on account of the thickness of the grains within them they are pushed apart more than the glumes of healthy ears.

'Bunted' grains communicate their dark colour and very objectionable odour to flour when they are ground in a sample of wheat.

The black powder within the grains are the chlamydo-spores of the fungus *Tilletia Tritici* Bjerk. (= *Tilletia caries* Tul.). Each chlamydo-spore is spherical, and three or four times the diameter of a spore of *Ustilago Tritici*. The exospore is brown, and covered with irregular, net-like thickenings (*a*, Fig. 244). On germina-

tion the exospore splits and a conidiophore or promycelium is produced which differs from that of the Ustilaginaceæ in being undivided, and its conidia instead of being laterally developed arise in a whorl at the apex of the conidiophore (*b*, Fig. 244). When growing in water the conidiophore often becomes divided by cross septa, but the protoplasm is continually transferred to the apical cell. The conidia, which only make their appearance when the conidiophore is exposed to damp air, are narrow and thread-like, and are usually from six to eight in number; they sometimes become joined together in pairs as at *e*, Fig. 244.

After falling from the conidiophore, or even before this happens, these primary conidia, when kept in damp air, ger-

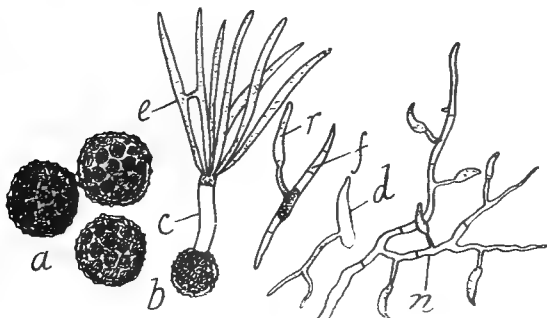

FIG. 244.—*a* Chlamydospores of Bunt (*Tilletia tritici* Bjer.) (enlarged about 500 diameters); *b* germinated chlamydospores; *c* conidiophores; *e* conidia, two of which are united; *f* germinated conidium producing a secondary conidium *r*; *d* secondary conidium germinating; *n* mycelium produced from primary conidium (enlarged about 300 diameters).

minate and give rise to a thin, short hypha on which single conidia of the second order (*r*) are produced, and these may furnish conidia of the third order. The secondary and tertiary conidia are slightly crescent or sickle-shaped and of very variable size.

When grown as a saprophyte the conidia may produce a mycelium (*n*) from which numbers of secondary and tertiary

sickle-shaped conidia are set free; moreover the formation of chlamydospores from a saprophytically nourished mycelium has been observed.

All the forms of conidia may give rise to germ-tubes which are able to penetrate into the nodes and leaf-sheaths of very young wheat plants, after which the growth and general behaviour of the mycelium in the host is similar to that of the various species of *Ustilago* in wheat, barley and oats.

Another species, namely *Tilletia lævis* Kühn., is met with upon wheat; it resembles *T. Tritici* in all points except that its epispore is smooth.

The remedies previously mentioned as suitable for the prevention of 'smut' in cereals are also beneficial for the reduction of 'bunt.' 'Pickling' with copper sulphate gives excellent results and should never be neglected.

Ex. 294.—Examine the 'bunted' grains of wheat; notice the swollen form of the grains and the odour of the black contents.

Are all the grains in an ear 'bunted.' Observe the openness of the glumes in a 'bunted' ear.

Ex. 295.—Examine in water with a high power the chlamydospores of 'bunt.'

Observe the difference between the coat of a ripe spore and that of an unripe one.

Contrast the size of these spores and the chlamydospores of 'smut.'

Ex. 296.—Germinate the chlamydospores of 'bunt' as follows:—Slightly crack some bunted grains of wheat so that the chlamydospores are exposed to view; then dip the grains in rain or well water and place them on damp blotting-paper on a plate, covering the whole with a bell-jar. Examine daily until a fine white mould is visible on the grains; transfer with the point of a knife or with fine forceps some of the filmy mould to a drop of water on a slide and view with a high power. Make drawings of the conidiophores and the long sickle-shaped conidia.

Sub-class 2.—Eubasidii.

6. In the second sub-class of the Basidiomycetes or the **Eubasidii** the conidiophore bears a definite limited number of

spores, most commonly four, though two, six or eight are produced in some species. Such a conidiophore is spoken of as a typical *basidium*, and its conidia, termed *basidiospores*, arise on delicate projections designated *sterigmata* (Figs. 247 and 252).

Two *series* of the **Eubasidii** are recognised, namely :—

- (i) the *Protobasidiomycetes*
- and (ii) the *Autobasidiomycetes*.

In the former the basidia are divided transversely or longitudinally by septa into four cells, while the latter fungi have unicellular basidia.

Series A.—*Protobasidiomycetes*.

To the *Protobasidiomycetes* belongs an important group known as 'Rust'-fungi, or *Uredineæ*. The latter are all endophytic parasites with delicate septate mycelia, generally confined to small localised areas within the leaves and stems of their host-plants. The basidia always originate from certain forms of chlamydospores, which are termed *teleutospores*. Many species of 'rust'-fungi are highly pleomorphic and possess several other forms of spores to which special names are given. Moreover, in some instances the parasite spends part of its life on one kind of host-plant and subsequently completes its existence upon another different host-species. Fungi in which this change of hosts is observed are said to be *heterœcious*, the term *autœcious* being applied to those which spend their whole life upon one victim.

7. '**Rust**' and '**Mildew**' of Wheat.—One of the commonest species which is strikingly polymorphic and at the same time a good type of a heterœcious fungus causes 'rust' and 'mildew' on wheat. The annual loss due to this parasite in wheat-growing countries amounts to several millions of pounds sterling.

SYMPTOMS.—In early summer a wheat crop suffering from this disease rapidly loses its green colour, becoming much yellower in a few days. Soon after this is observed, a close examination reveals reddish-orange elongated spots on the lower leaves and stems of the plants. With a pocket lens the spots are seen to be cracks or slits in the epidermis of the plant from which an orange-coloured powder is shed (*A*, Fig. 245).

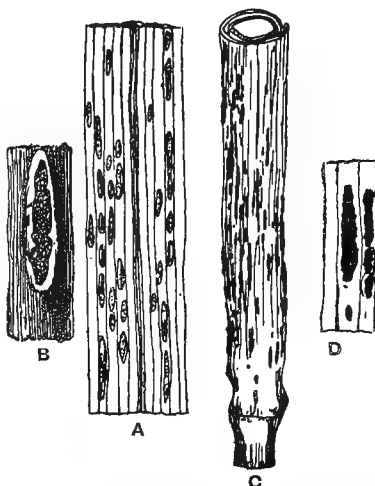

FIG. 245.—*A*, 'Rust' spots on wheat leaf (twice natural size); *B*, a single 'rust' spot more highly magnified; *C*, 'mildew' spots on leaf-sheath of wheat (twice natural size); *D*, two 'mildew' spots more highly magnified.

Frequently towards the end of the summer the orange or 'rusted' spots change into or are replaced by darker ones (*C*, Fig. 245) which are often prominent on the stems and leaf-sheaths; the crop is then said to be 'mildewed.' Formerly 'rust' and 'mildew' were believed to be distinct from each other; they are, however, now known to be caused by one and the same fungus.

'Mildewed' straw has not the shining golden colour so characteristic of healthy, well-ripened wheat stems, but is greyish-brown and dirty in appearance as well as brittle and rotten.

When 'rust' and 'mildew' are extensively developed on a wheat crop, the yield of grain is much reduced, and the individual grains are often shrivelled and small in size.

CAUSE.—'Rust' and 'mildew' are caused by the fungus *Puccinia graminis* Pers. The yellow dust is composed of

great numbers of chlamydospores which are shed off from the mycelium of the parasite living within the tissues of the wheat leaf.

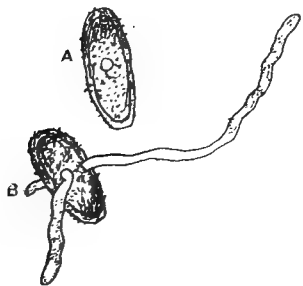

FIG. 246.—A, Uredospore of *Puccinia graminis* Pers.; B, uredospore germinating. (Enlarged 420 diameters.)

The chlamydospores are the summer spores of the fungus and are termed *uredospores*. They are single cells of oval form (A, Fig. 246). The outer coat of each spore is thick, and when mature is covered with very short fine spines; in it are four thin places or *germ-pores*, situated at even intervals around its smallest circumference. The inner wall of the spore is thin, and the spore-contents are coloured with

drops of a yellow or orange oily substance.

When placed in water as soon as ripe they germinate in a few hours; germ-tubes make their appearance from one or more of the *germ-pores* and develop to a considerable length (B, Fig. 246). If the process takes place in a wheat leaf, the hypha grows along the surface for a time and finally enters into the leaf through an open stoma or penetrates directly through the epidermal cells. The hyphal filament develops in the intercellular spaces of the soft parenchyma between the veins of the leaf, and a compact septate mycelium is soon produced which is confined to a small localised area within the tissues of the host. Upon the mycelium arises a dense bundle of short vertical hyphæ bearing a crop of uredospores; the latter as they grow burst through the epidermis and form a 'rust' spot or *sorus* on the outside of the leaf.

The mycelium continues to produce uredospores during a period of eight or ten days, and as each spore when carried by the wind or by insects to a wheat plant is capable of producing a new spot of rust, it is readily understood how

rapidly the fungus may spread in a crowded crop of plants when conditions for the distribution and germination of the spores are suitable.

This form of reproduction is carried on throughout a good part of the summer, and accounts for much of the extensive distribution of 'rust' in wheat, although it is important to note that, according to Eriksson's investigation, the uredospores from any individual infected plant only spread the disease a comparatively few yards around their point of production in a field.

Although certain varieties and species of 'rust' to be mentioned hereafter attack other cereals and grasses, the form under present consideration lives *as a 'rust'* upon wheat alone, so that there is no danger of the disease being carried to neighbouring crops of oats, rye, barley or grasses from an infected field of wheat.

Towards the end of the wheat's growing-season, the production of uredospores ceases, and as they do not retain their power of germination more than a few months it would appear that the fungus does not usually live through the winter in this form, though it is possible that in some districts at any rate the uredospores infect autumn-sown wheat, and the fungus remains upon the latter in an inconspicuous condition until the following spring, when it develops and spreads as 'rust' through the crop.

The mycelium in the tissues of the host, after producing uredospores for a considerable time, begins to give rise in July and onward to another form of chlamyospores of dark colour. The 'rust' spots in consequence change from orange to black, especially on the leaf-sheaths and stems of the straw, after which the crop is said to be 'mildewed.'

This new form of chlamyospore is designated a *teleutospore*, a name meaning *final* spore, and given to it in consequence of the fact that it is developed at the end of the season.

The teleutospores grow at the apex of vertical brown hyphæ, which are arranged in dense clumps or *sori* (*A*, Fig. 247). Each teleutospore consists of two cells superimposed, as in Fig. 247. The outer wall of the compound spore is a deep chestnut-brown colour and very thick, especially at the apex. Lining each of the two component cells is a delicate membrane. A germ-pore is present at the apex of the uppermost cell, and another exists at the side of the lower cell close to the transverse septum.

The teleutospores remain dormant during winter, and cannot be made to germinate until the following spring. Even at the latter period only those germinate which have been exposed to the ordinary changing climatic conditions of winter.

Teleutospores from straw protected in stacks or barns rarely grow.

When germination

takes place, a hypha, which develops into a basidium, arises from the germ-pore of each cell of the teleutospore (*C*, Fig. 247); the upper part of the basidium (*a*) is usually divided into four cells, and each of the latter produces a delicate *sterigma* (*s*), on the

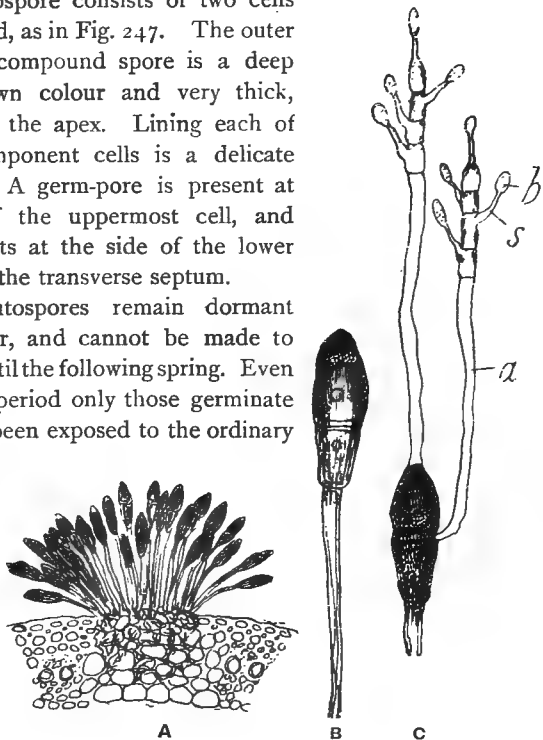

FIG. 247.—*A*, Transverse section through a sorus of teleutospores of *Puccinia graminis* Pers., on a wheat stem (enlarged 80 diameters); *B*, a single teleutospore (enlarged 450 diameters); *C*, germinated teleutospore: *a* conidiophore; *s* sterigma; *b* basidiospore.

end of which a single small transparent conidium or *basidio spore* (*b*) is abstricted.

It is still an open question whether these basidiospores can infect wheat plants; it is usually assumed that they cannot do so, and with one exception experiments to test the matter have yielded negative results. However, when placed upon the leaf of a barberry bush (*Berberis vulgaris* L.) they germinate and produce a delicate hyphal filament, which penetrates into the leaf and develops a mycelium there. Upon this mycelium are produced extremely minute oval *conidia* (formerly termed *spermatia*) and chlamydo-spores, which are known as *æcidiospores*.

The conidia arises in chains on the ends of delicate hyphæ within a pear-shaped structure, the so-called *spermogonium*, which is formed of closely interwoven hyphæ, usually situated beneath the upper epidermis of the barberry leaf (compare *B*, Fig. 248). Although they can be made to germinate in solutions of sugar or honey, the small conidia appear to be functionless under natural conditions and the part which they play in the life-history of the fungus is unknown.

The *æcidiospores* are produced in yellow cup-like structures or *æcidia*, which grow in clusters upon swollen patches on the lower surface of the barberry leaf (compare *A*, Fig. 248). When mature each *æcidium* resembles a cup with an irregularly torn margin which is bent outwards. At the base within the cup are numerous short hyphæ very closely packed together; above these and filling the cup are the *æcidiospores* arranged in the form of long chains (*B*, Fig. 248), each spore being at first separated from the next by a short temporary intermediate cell. The *æcidiospores* ultimately become free from each other and are distributed by the wind and rain. They are roundish single cells with orange-yellow contents, and a colourless, almost smooth episore in which are several germ-pores. Their vitality lasts but a few days. When placed on a barberry leaf and allowed to germinate, they do not penetrate the leaf or re-

produce the fungus there. However, if they are carried by the wind or other means to the leaves of wheat plants, each æcidiospore produces one or two germ-tubes which enter through the stomata of the wheat leaves and give rise to a mycelium from which *uredospores* are produced.

We thus observe that during its life-cycle the fungus bears three different forms of chlamydospores, namely, æcidiospores on the barberry in spring, uredospores on wheat in summer, and teleutospores in late summer also on wheat. The two former

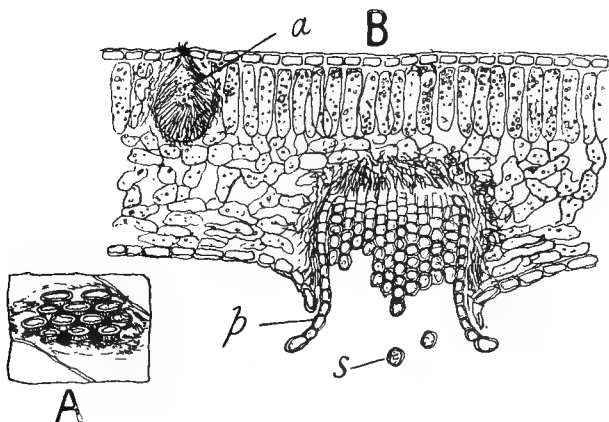

FIG. 248.—A, Æcidia or 'cluster-cups' of *Puccinia coronata* Corda. on a leaf of black alder (*Rhamnus Frangula* L.) (10 times natural).

B, Transverse section through a leaf of black alder infected with *P. coronata*: a spermogonium of the fungus; β peridium of the æcidium or cluster-cup; s free æcidiospore. (Enlarged 60 diameters.)

kinds of spore are single cells and germinate immediately with the formation of a simple hyphæ, while the latter are bicellular resting-spores which only germinate after hibernating several months, and then produce basidia bearing basidiospores instead of simple vegetative hyphæ. Before any relationship between them was known, the three stages of the fungus were referred to as three distinct species belonging to the genera *Æcidium*, *Uredo*, and *Puccinia* respectively.

In certain districts the parasite undoubtedly uses the barberry as a second host, nevertheless the latter is not necessary for the continuous propagation of the fungus since in Australia the æcidiospore stage is not met with. Even in this country the absence of barberry bushes from certain localities does not appear to diminish the prevalence of 'rust' from such districts. Moreover, where the barberry is common our experience leads us to conclude that the æcidium-stage of the parasite is much rarer than it is generally assumed to be and in no sort of proportion to 'rust' attack. As previously stated, it is still an open question whether the basidiospores are able to infect a wheat plant and give rise to 'rust.'

Eriksson obtained 'rusted' plants in six to eight weeks from cereal grains which were sown in sterilised soil and carefully protected from any possible outside infection. He therefore concludes that the fungus is transmitted from the 'rusted' parent to the grain as a 'plasm,' which lives a latent life in the cells of the embryo and young plant until just before the eruption of 'rust' spots, at which time it develops an ordinary mycelium.

This view, if fully established, would account for much of the extensive early appearance of 'rust' in cereal crops which is otherwise difficult to explain.

The fungus *Puccinia graminis* Pers., not only occurs upon wheat but upon other cereals and grasses as well, and is divided by Eriksson and Henning into six different 'specialised forms' or 'biological varieties.' All have their æcidiospores on *Berberis vulgaris*, or on species of *Mahonia*; their uredospores and teleutospores are met with on the cereals and grasses as follows:—

- Var. i. *tritici* on wheat only.
- „ ii. *secalis* on rye, barley, and couch grass (*Agropyrum repens*).
- „ iii. *avenae* on oat, meadow foxtail, tall oat-grass and cocks foot.

- Var. iv. *airæ* on *Aira caespitosa*.
 „ v. *agrostidis* on *Agrostis alba* and *A. canina*.
 „ vi. *poæ* on *Poa compressa* and *P. pratensis*.

These varieties cannot be distinguished from each other morphologically; they are, however, biologically distinct in so far that the uredospores of one variety cannot infect host-species different from those on which they are commonly found.

Thus, the uredospores of var. iii. cannot produce 'rust' on wheat or barley, neither can the uredospores of the variety on wheat produce the disease on oats or barley.

Ex. 297.—Examine the 'rusted' leaves of wheat *in spring* and also later *in summer* with a pocket lens. Make a sketch of the form and length of the spore-beds or *sori*. Note the colour of the sori and the leaf-tissue round them.

Ex. 298.—Scrape off some of the uredospores of the above with the point of a sharp pen-knife and transfer to water on a glass slide. Examine the spores with a high power. Observe their form, the colour and markings on the cell-walls, and the colour of contents.

Ex. 299.—Cut transverse sections of a fresh leaf through a youngish 'rust' sorus. Examine with a high power. Note and sketch the stalk or *pedicels* of the uredospores and the mycelium in the soft tissue of the leaf.

Ex. 300.—Brush or scrape off some of the loose uredospores from a leaf into a drop of water on a glass slide. Place the latter on damp blotting-paper under a bell-jar and examine with a low power every twelve hours until germination takes place.

Examine the germinated spores with a high power. Observe the length and origin of the germ-tube. Note the colour of the contents of the latter.

Ex. 301.—Cut transverse sections of the stem or leaf-sheath through a black teleutospore sorus. Examine the section in water with a low and also with a high power. Observe the length of the pedicels of the teleutospores and the form, colour, and thickness of the cell-walls of the latter.

Ex. 302.—In autumn procure straw with teleutospore-sori visible; tie in a bundle and leave out of doors all the winter. In March or April cut off small portions of the stem with teleutospores on them and place these pieces in water in a watch-glass. Keep the whole under a bell-jar and examine every twelve hours until germination takes place. A film-like mould is seen with a pocket lens when germination has occurred. Mount in water on a

glass slide and examine with a high power; draw the basidia and basidiospores.

Ex. 303.—Examine barberry bushes in May and June for æcidia of *Puccinia graminis*. If found, make drawings of the parts as seen with a pocket lens.

Cut transverse sections through the leaf so as to pass through one or more æcidia. Mount in water and observe with a high power the structure of the single layer of cells forming the cup, the rows and shapes of the spores.

Ex. 304.—Shake out some of the spores from a fresh æcidium into a dish of water on a glass slide and place the latter on wet blotting-paper under a bell-jar. Examine every twelve hours for germinated spores; draw the latter.

Ex. 305.—In section from Ex. 303, note the presence of spermogonia on the upper side of the leaf. Examine with a $\frac{1}{8}$ or $\frac{1}{2}$ inch objective and draw the various parts seen.

Ex. 306.—Where barberry bushes are uncommon or non-existent the æcidia of other species of the Uredineæ should be utilised for a study of the structure of this stage in their life-history.

They should be looked for in spring and early summer on species of buttercup (*Ranunculus*), moschatel (*Adoxa moschatellina*), species of dock (*Rumex*), wild violets, coltsfoot (*Tussilago Farfara*), and stinging nettle (*Urtica dioica*).

8. Other species of Puccinia which attack cereals.—In addition to summer 'rust' or black 'rust' (*Puccinia graminis* Pers.), the following distinct species of 'rust'-fungi are met with upon cereals.

(a) **Golden or Spring 'Rust'** (*Puccinia glumarum* Schm.)—This species in the uredo-stage forms small cadmium-yellow sori which are situated on elongated pale yellow patches upon the leaves of the infected cereals. It is often alarmingly conspicuous in spring, and in certain cases is liable to attack the glumes and injure the grain later in the season. Most commonly, however, it does little damage to the crop, and disappears without forming many teleutospores.

The uredospores are roundish and possess eight or ten germ-pores which are difficult to observe except when the spores germinate.

The teleutospores, which are arranged in long fine streaks on the leaf-sheaths, haulm and chaff, have short stalks and germinate in the autumn of the year during which they are produced. The cells of each individual teleutospore are usually superposed unsymmetrically, the upper one being frequently flattened at the top (A, Fig. 249).



FIG. 249.—A, Teleutospore of *Puccinia glumarum* Schm.; B, teleutospore of *Puccinia coronata* Corda.; C, teleutospore of *Puccinia simplex* Körn. (Enlarged about 350 diameters.)

Æcidiospores are unknown. Five 'biological varieties' are recognised, namely (i) var. *tritici* on wheat; (ii) var. *hordei* on barley; (iii) var. *secalis* on rye; (iv) var. *agropyri* on *Agropyrum repens*; (v) var. *elymi* on *Elymus arenarius*.

(b) **Brown 'rust'** (*Puccinia dispersa* Eriks. et Henn.).—The æcidiospores of this species are produced in Autumn on Bugloss (*Anchusa officinalis* L.) and Alkanet (*Anchusa arvensis* Bieb.)

The uredo-sori are a pale brown or raw sienna tint and distributed irregularly all over the leaves of the host-cereal; they are not usually seen until a short time before harvest. The teleutospores, which resemble those of *P. glumarum*, are commonly most prevalent on the under side of the leaves, and remain largely covered by the epidermis of the latter. Four biological varieties of the fungus are known, namely on (i) wheat, (ii) rye, (iii) couch-grass and (iv) brome-grasses.

(c) *Puccinia simplex* Körn.—This species, which attacks barley only, is of little practical importance as the damage it causes is usually slight. Its uredo-sori are very small, lemon yellow in colour and distributed irregularly on the infected leaf. The teleutospores are generally *one-celled* (C, Fig. 249).

(d) **Crown 'rusts.'**—Two species of crown 'rusts' are known, namely *Puccinia coronifera* Kleb., and *P. coronata* Corda. The upper cells of the teleutospores in both species are surmounted

by a ring or crown of blunt teeth (*B*, Fig. 249), hence the name crown 'rust.'

P. coronifera attacks oats only among cereals, but biological modifications occur on foxtail, rye-grass, tall fescue, Yorkshire fog, and other grasses. The uredo-sori are small, of orange colour, and chiefly present on the upper surface of the oat leaf.

The æcidiospores are produced on Buckthorn (*Rhamnus catharticus*, L.).

P. coronata does not occur on cereals, but is common on couch-grass, Yorkshire fog, Fiorin and other grasses. Its æcidia (Fig. 248) are formed on Black Alder (*Rhamnus Frangula* L.).

PREVENTION AND REMEDIES.—At present no satisfactory method is known for the prevention of the enormous annual loss of cereal grains due to the attacks of 'rust'-fungi. Neither spraying the crop nor pickling the seed-grain have hitherto proved of any practical value in combating the parasites. The following means for reducing the prevalence of rusts among cereal crops are, however, worthy of careful consideration.

(a) Avoid the excessive use of nitrogenous manures, for experience shows that 'rust' is always liable to be severe in a crop grown with heavy dressings of dung and nitrate of soda. A judicious application of phosphates is especially necessary to counteract the prejudicial effects of nitrogenous manures when the latter have been applied in superabundance.

(b) As dampness of soil and atmosphere favour the development of rust, good drainage should be secured as far as possible.

(c) The plants barberry, alkanet, bugloss and buckthorn, upon which the æcidiospores of the different species of *Puccinia* are produced, should be eradicated, although the effect of this practice in many instances appears to be slight.

(d) Cereals sown early in spring are found to suffer less from 'rust' than those sown later.

(e) Cultivate those races and varieties of cereals which are found by experience to have 'rust'-resisting powers.

Races of wheat with upright, narrow leaves and a strong epidermis upon which there is a marked waxy 'bloom,' are generally less easily infected with 'rust' than those with broad, soft, green leaves.

Varieties with densely packed ears are usually resistant, though this is not always the case.

Nursery, Trump, and Squarehead wheats are highly resistant to the disease, while Horsford's Winter Pearl, Hoary White, are almost always 'ruste.'

9. About 700 species of *Puccinia* are recorded on a very great variety of plants. Some of them possess all the spore-forms as in *Puccinia graminis*, while many produce teleutospores and uredospores, or teleutospores only. *Æcidium*-forms are also not uncommon, the teleutospore-forms of which are hitherto unknown. Few species, however, except those mentioned are of practical importance so far as the farmer is concerned. A number attack garden plants, the worst perhaps being the following species, all of which are autœcious.

(a) *P. Malvacearum* Mont., which attacks hollyhocks and species of *Malva*. Only teleutospores are produced by the fungus and they germinate as soon as ripe.

(b) *P. Hieracii* Mart., common on many wild Compositæ, such as thistles, hawkweeds, and very destructive to chrysanthemums. This species produces teleutospores, uredospores, and spermatogonia. Hitherto, only the uredo-stage has been observed upon cultivated Chrysanthemums. The 'rust' attacks the young cuttings soon after they have rooted, and appears very extensively upon the older plants in late summer and autumn, especially after being brought indoors.

The disease may be kept in check or completely overcome by spraying with Bordeaux mixture once or twice a week through the summer. The cuttings and old stools of the plants should

be sprayed. Repeated spraying with 'liver of sulphur' wash made by dissolving 1 oz. of 'liver of sulphur' in 10 gallons of water, to which is added enough soft soap to make a lather, is equally effectual. The wash blackens white paint.

Repeated spraying with carbolised soft-soap, such as is used for destroying insect-pests, has proved a good remedy.

(c) *P. Asparagi* D. C., which is a pernicious pest of asparagus beds. The æcidia occur in spring on the young shoots, the uredospores and teleutospores making their appearance later on the fully developed stems and branches.

(d) *P. Pruni* Pers., very abundant on the under surface of the leaves of plums in some seasons. Teleutospores and uredospores only known.

Ex. 307.—The student should be made practically acquainted with the form of the sori and the various chlamydospores of *Puccinia glumarum*, *P. dispersa*, *P. coronata* and *P. coronifera*, which attack the common cereals. Their æcidia should also be looked for and examined on their particular host-plants.

Ex. 308.—The uredospores and teleutospores of *Puccinia Pruni*, *P. Hieracii*, and teleutospores of *P. Malvacearum* should be examined.

Puccinia Arenaria Schum., is sometimes met with in gardens on sweet-williams and chickweed; as the teleutospores of this species germinate as soon as ripe they are convenient for the study of the basidia and basidiospores of *Puccinia* where *P. graminis* cannot be managed.

P. Malvacearum on hollyhock and wild species of mallow is also useful for a similar purpose.

10. Belonging to the 'rust'-fungi is another genus, namely *Uromyces*, which requires consideration. Many of the fungi of this genus possess the same number of spore-forms as those belonging to the genus *Puccinia*, their teleutospores are, however, always unicellular.

The following autœcious species do considerable damage to farm crops.

(a) *Uromyces Fabæ* Pers. This 'rust' attacks the leaves and

stems of beans and vetches, the uredospore and teleutospore-sori being round or oval of chestnut-brown colour.

(b) *Uromyces Betae* Pers., is a common parasite on garden and sugar beet, mangel, and wild sea-beet. The *Æcidiospores* are rarely met with except on the

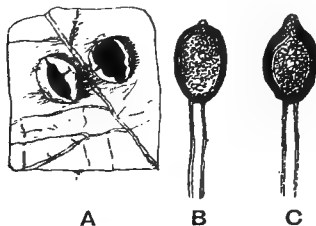

FIG. 250.—A, Uredospore-sori of mangel rust (*Uromyces Betae* Pers.) (enlarged about 6 diameters); B, teleutospore of mangel rust; C, teleutospore of bean rust (*Uromyces Fabae* Pers.). (B and C enlarged 320 diameters.)

petioles and young leaves of 'seed'-beets in spring, but uredospores and teleutospores are freely produced in summer on the ordinary mangel crop, their respective sori being roundish and of brown colour (Fig. 250).

A heteroecious species, namely *Uromyces Pisi* Pers., is a frequent pest of the pea crop. Its *æcidiospores* are produced on the spurge, *Euphorbia Cyparissias* L.

Ex. 309.—Examine the sori of *Uromyces Betae* and *U. Fabae* with a pocket lens; make drawings. Scrape off with a penknife uredospores and teleutospores of each; mount in water and examine with high power. Observe that both uredospore and teleutospore are unicellular; note the differences in the surface and thickness of the cell walls of the respective spores.

Series B.—*Autobasidiomycetes*.

11. The *Autobasidiomycetes* or second series of the *Eubasidii* are characterised by their undivided unicellular basidia which are club-shaped or cylindrical. Each basidium generally bears at its apex four slender sterigmata on the end of which single basidiospores are produced.

More than 10,000 species of fungi are included in this series. Most of them display considerable complexity of organisation, and by far the larger number, such as mushrooms, toadstools, and puff-balls are saprophytes, although a few are destructive parasites of forest trees.

The **Common Mushroom** (*Agaricus campestris* L. = *Psalliota*

campestris Fr.) is a widely distributed species of this series, and the only one we are able to notice here.

The mycelium, or vegetative portion of the fungus, when very young, is composed of simple filamentous hyphæ, which resemble a loosely-tangled felt of fine white wool. It is known among

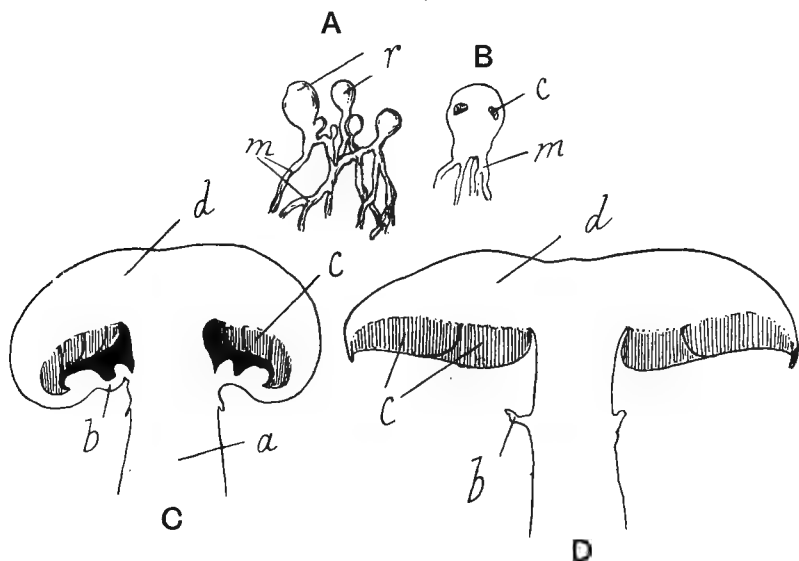

FIG. 251.—A, Portion of the mycelium *m* of the common mushroom (*Agaricus campestris* L.), with young 'mushrooms' *r*.

B, Longitudinal section of young mushroom: *m* mycelium; *c* points where lamellæ are developed.

C, Longitudinal section of a half-grown mushroom: *a* stipe; *b* the veil (*velum partiale*); *d* fleshy part of pileus; *c* lamellæ or gills.

D, An older stage of C. (All about natural size.)

gardeners and others as 'spawn,' and is found permeating the bed or ground where the 'mushrooms' grow. After spreading for a time in this form, the hyphæ become united into branched cylindrical strands of variable thickness and length.

Upon this cord-like 'spawn' arises the part known popularly

as 'the mushroom,' which is a complicated fructification or sporophore of the fungus. In the earliest stages the sporophores are small oval tubercles (*r*, Fig. 251) of closely-woven hyphæ, in which very little differentiation of parts is observable.

The mature sporophore, however, consists of a stalk or

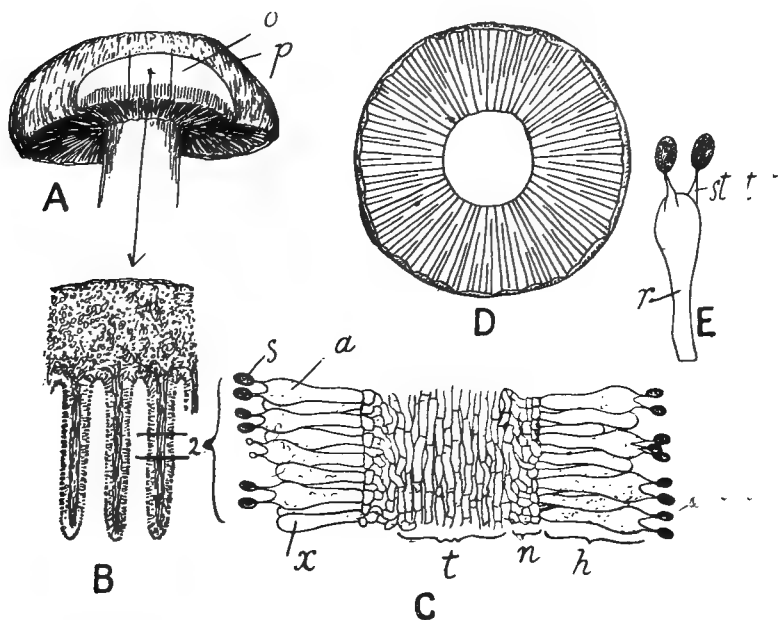

FIG. 252.—A, Sporophore of the common mushroom: at *o* a slice has been cut from the pileus (slightly reduced).

B, Portion of the pileus and lamellæ cut across in A (enlarged 30 diameters).

C, Transverse section of portion of the lamella from 2 (enlarged 450 diameters): *t* trama; *n* sub-hymenial layer; *h* hymenium; *a* a basidium with two basidiospores *s*; *x* a paraphysis.

D, View of underside of the mushroom pileus, showing arrangement of the lamellæ.

E, A single basidium: *st* sterigma bearing basidiospore at its apex.

stipe (*a*) thickened at the base, and an umbrella-like expansion, which is designated the cap or *pileus* (*d*).

Exposed on the lower surface of the pileus are a large number of thin, dark brownish-purple plates, known as gills or *lamellæ* (*c*),

which are arranged in a radiating manner from the centre of the pileus, the oldest of them extending from the edges of the latter to the stem, while younger ones reach only part of the way.

Attached to the stipe at a point a little more than half-way from its base is an encircling frill or *annulus*, the remains of the *veil* (*velum parziale*, *b*), which, in the early stages of development of the sporophore, was stretched in the form of a delicate membrane from the stipe to the outer edge of the pileus and completely enclosed the young lamellæ.

It is upon the lamellæ that the basidia and their spores are borne. A thin, tangential slice through the 'mushroom,' as in Fig. 252, cuts the lamellæ transversely (see *A* and *B*). A portion of one of the latter is shown highly magnified at *C*: the central substance (*t*) is known as the *trama*, and is composed of long, somewhat loosely-woven hyphæ, which diverge to the right and left, and become divided into shorter segments in the part (*n*) termed the *sub-hymenial layer*. From the ends of the short cells forming this layer the club-shaped *basidia* arise, each of which bears two to four oval and prominent purple *basidiospores*, carried singly at the tips of the same number of *sterigmata*.

The basidia are packed closely side by side, and intermixed with smaller sterile cells (*x*) the *paraphyses*, the whole spore-bearing surface (*h*) of the lamella being spoken of as the *hymenium*.

Several wild varieties of the mushroom are met with in pastures and woods.

The cultivated form (var. *hortensis*) is very variable and somewhat distinct from these. It is at present propagated chiefly from pieces of mycelium or 'spawn,' which are contained in the compressed blocks of richly-manured compost sold by seedsmen as 'mushroom spawn.' The conditions necessary for the germination of mushroom spores are not yet clearly understood. They can be encouraged to germinate to some extent in solutions containing magnesium phosphite, magnesium

potassium ammonium phosphate, but the presence of the actively-growing mycelium acts most energetically as a germination stimulus. The reproduction of the fungus from its spores has been successfully carried out by Repin and others in France recently, and their methods for the production of 'virgin spawn' have already been of great value to the mushroom-growing industry.

Ex. 310.—Sketch the parts of a full-grown mushroom.

Pull off the pileus from the stalk and place it with the gills downwards on a sheet of white paper: leave it all night and examine the paper in the morning. The spores fall off and leave a sort of picture of the arrangement of the gills.

Ex. 311.—Compare the parts of a half-grown 'button' mushroom with those of a full-grown specimen, noting specially the colour of the gills and the form of the *annulus* and *velum parziale* in each.

Ex. 312.—Place small pieces of the pileus and stipe of a mushroom in 1 per cent. chromic acid for twelve hours; transfer them first into a mixture of equal parts methylated spirit and water, and then into ordinary strong methylated spirit, leaving them in each solution two hours.

(a) Cut longitudinal and transverse sections of the stipe, mount in glycerine, and examine under low and high powers; sketch the form of the hyphæ in each.

(b) Cut sections of the pileus and gills as in Fig. 252. Examine first with a low and then with high powers. Note and sketch the trama, sub-hymenial layer and hymenium of a gill. Observe and sketch the paraphyses and basidia with their sterigmata and basidiospores.

Ex. 313.—Procure a 'brick' of 'mushroom spawn' from a seedsman, break it and note the fine filaments of mycelium penetrating it. Tease out with needles and examine with low and high powers portions of the mycelium in water. Observe and sketch a portion of a hypha with its transverse septa.

If a mushroom-bed can be examined, observe that the young mushrooms arise from the mycelium in the bed.

CHAPTER L.

FUNGI (*continued*).

ASCOMYCETES.

1. THE **Ascomycetes** constitute a class of the Higher Fungi, including more than 10,000 species. They all have septate hyphæ and their main distinguishing feature is the possession of a sporangium of definite shape and containing a limited and definite number of spores. The sporangium is termed an *ascus*, and is generally club-shaped or oval in form.

When the ascus is young it contains a single nucleus embedded in finely granular protoplasm. This nucleus subsequently divides first into two, then into four, and finally into eight nuclei: the latter afterwards surround themselves with small portions of protoplasm and a cell-wall, and become non-motile spores, each of which is termed an *ascospore*.

An ascus generally contains eight ascospores, although in some species two, four, or a larger number are present.

The ripe spores are often ejected from the ruptured apex of the ascus with considerable force.

In the simplest representatives of the class, the asci are exposed and situated directly on the mycelium, but in the higher forms, which are the most numerous, the asci are enclosed in fruit bodies or *ascocarps* composed of closely interwoven septate hyphæ often resembling a parenchymatous tissue of polygonal cells.

Usually preceding the formation of ascospores, the fungi are very extensively reproduced by means of conidia. Many species are pleomorphic, producing several distinct types of conidia

either at the same time or in irregular succession from the same mycelium. A very large and heterogeneous collection of fungi, classified in systematic works as '*Fungi imperfecti*,' appear to be conidial forms of imperfectly known Ascomycetes, the ascospores of which are either absent altogether or which have not yet been recognised.

2. The **True Yeasts** are by several authorities included in the Ascomycetes and united into an order or family, the *Saccharomycetaceæ*. The commonest and best known species is **Beer-yeast** (*Saccharomyces cerevisiæ* Meyen). No true hyphæ or mycelium is produced, the plants in a vegetative state consisting of single oval cells, which, under some conditions of nutrition may become considerably elongated and partially resemble a hyphal filament.

Each oval yeast-cell has a distinct cell-wall, and is filled

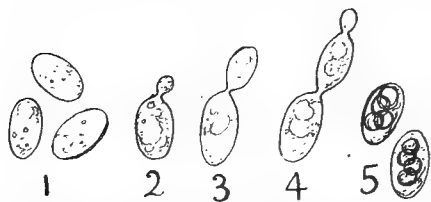

FIG. 253.—1. Cells of common beer-yeast (*Saccharomyces cerevisiæ* Meyen); 2, 3, and 4, successive stages of 'budding' process of multiplication; 5, cells containing endospores (all enlarged about 750 diameters).

with granular protoplasm in which are visible larger or smaller vacuoles (Fig. 253). Multiplication takes place by the process of *budding* or *sprouting* (see p. 680), and especially is this

the case when the cells are well nourished in solutions of saccharine substances, such as malt-extract. When the cells are poorly nourished and grown at a temperature of about 30° C. on moistened slabs of plaster of paris, the protoplasm within each of them divides and forms from two to four endospores: the whole cell thus becomes transformed into a sporangium, which is considered a simple form of ascus (5, Fig. 253).

Many conidia of fungi are capable of 'budding' in a manner similar to the true yeast-fungi and may greatly resemble the

latter in form and physiological action. They do not, however, form endospores.

Several cultivated varieties of *Saccharomyces cerevisiæ* are recognised; all of them when grown in solutions of certain sugars are capable of breaking down these compounds into alcohol and carbon dioxide gas, together with small amounts of glycerin, succinic acid and other substances. Their fermentative power is due to an enzyme, termed *zymase*, which has been extracted from the yeast-cells by subjecting them to very great pressure.

In the manufacture of beer two different varieties or races of *S. cerevisiæ* are utilised, namely, (1) *top-fermentation* yeast and (2) *bottom-fermentation* yeast. The former, which is practically the only race employed in the breweries and distilleries of this country, carries on a rapid and vigorous fermentation at a temperature of 12-24° C; the 'sprout-cells' remain united for some time in branched chains and are lifted up to the surface of the liquid in which they are growing by the carbon dioxide liberated.

The latter or bottom-fermentation yeast is employed chiefly on the Continent in the manufacture of lager beer. Fermentation with this race is very slow, and goes on at a low temperature, namely, at 5-10° C; the 'sprout-cells' usually separate from each other immediately after their production, and accumulate on the bottom of the vessel in which the fermentation is going on.

About forty more or less distinct species of *Saccharomyces* exist.

S. ellipsoideus Reess, is a wild species of yeast common on the exterior of various fruits and brings about the production of wine from grape juice. It also sets up fermentation in watery juices of cherries, plums, and other fruits.

Many of the undesirable fermentations set up in beer, wine and other alcoholic beverages which result in the production of compounds having an unpleasant taste or odour, are brought about by wild species of *Saccharomyces*.

Ex. 314.—Obtain a small piece of German yeast from a baker. Break it in

pieces and stir it up in water in a tea-cup. Allow the yeast to settle and pour off the water. Mount in water a drop of the creamy yeast left at the bottom of the cup, and examine with a high power.

Draw a single cell and observe its cell-wall, protoplasm, and vacuoles.

Ex. 315.—Half fill a small teacup with water and dissolve in it a teaspoonful of sugar, put in a piece of German yeast about the size of a broad-bean and stand the whole in a warm place. When the yeast begins to accumulate on the surface of the water, take a very minute portion and mount it in water. Examine with a high power and sketch the budding or sprouting cells.

Ex. 316.—Smear some of the creamy yeast from Ex. 314 on the cut surface of a slice of potato, take and place the latter on damp blotting-paper under a bell-jar.

Keep in a warm place for a week, after which scrape off daily a little of the yeast and mount in water. Examine with an $\frac{1}{8}$ objective for ascospores.

Ex. 317.—Make similar observations upon ordinary brewer's yeast if the latter is conveniently available.

3. **Mildews.**—The term mildew in popular language is applied to almost any kind of spotty discoloration brought about by fungi, no matter what species the latter may be. Thus we hear of mildews on leather, linen, paper, and food as well as on various plants, such as the cereals, potatoes, roses, and other plants, and in all these instances the spots are due to minute fungi, many of which belong to totally distinct classes.

Among botanists, however, the mildews proper constitute a well-marked family of ascomycetous fungi, namely the *Erysiphaceæ*. These are all strict parasites with white, cobweb-like mycelia which spread over the surface of the leaves of their hosts and send short haustoria into the tissues of the latter.

Rapid reproduction during summer is carried on by short-lived, but quickly-germinating conidia, which grow in chains from short, simple, erect conidiophores borne on the mycelium (Fig. 254). During active vegetative growth of the fungus and extensive formation of its conidia, the affected parts of the host-plant appear as if covered by a mealy or chalky powder. In autumn small black points arise on the mycelium; these are ascocarps or *perithecia* containing one or more asci with eight spores,

which usually remain dormant during winter and germinate in the following spring, when they are set free by the bursting of the enclosing ascus and perithecium.

The conidial-forms of these fungi were formerly regarded as species of the genus *Oidium*; and in cases where the ascocarps are unknown, this generic name is still adopted.

Many of the Erysiphaceæ are common injurious parasites of farm and garden crops. The chief genera worthy of mention are *Sphaerotheca*, *Erysiphe*, and *Uncinula*.

(i) In *Sphaerotheca* the perithecium is spherical and contains one ascus only; the hyphal *appendages* to the perithecium are simple (*h*, Fig. 255). To this genus belongs the destructive parasite known in hop-growing districts as ‘hop-mould.’

‘ Hop-Mould.’

SYMPTOMS.—In the earliest stages the mould is seen as small, light-coloured patches, chiefly upon the upper surface of the leaves. If the nights are cold and damp and the hop plants in a backward or weakened condition the patches soon increase in size, generally regularly from a centre, so that the spots are approximately circular. As the patches increase to about one-eighth of an inch across they become whiter in colour and have a dusty or floury appearance. Fresh spots show themselves on the younger leaves, and in bad cases the malady spreads from the lower leaves, where it is generally first seen, to those higher on the plant and even to the tender shoots and young hops.

In all cases the plants suffer in health, but it is only when the tender shoots and young growth is attacked that serious damage is done. The young hops and tips of the laterals on the bine then lose their soft, succulent character and become deformed; the parts attacked dry up and development is stopped.

Often the white patches of mould do not spread; the spots lose their dusty appearance and vanish, leaving behind always a small yellow or brown dead place upon the leaf attacked.

More frequently, however, if the mould is allowed to remain unchecked and the weather is unfavourable to the growth of the hop plant, the patches, especially on the lower surface of the leaves and on the young hops, become covered with extremely small, dark, rusty-brown specks, and the white, dusty character of the spot gradually disappears.

The time at which mould is first observed varies with the season. Gardens once seriously attacked and neglected are always specially liable to an annual recurrence of the disease, unless measures are taken to get rid of the trouble by methods described below.

CAUSE.—The disease is caused by the fungus *Sphaerotheca*

Castagnei Lev., whose white mycelium forms a 'mould-spot' on the surface of the hop-leaves. In the early stages of development the slender hyphæ of the mycelium spread over the surface of the leaf and send down short *haustoria* or 'suckers' into the epidermal cells. The haustoria serve to fix the parasite to its host, and at the same time they absorb from the hop-plant the nutriment necessary for the growth of the

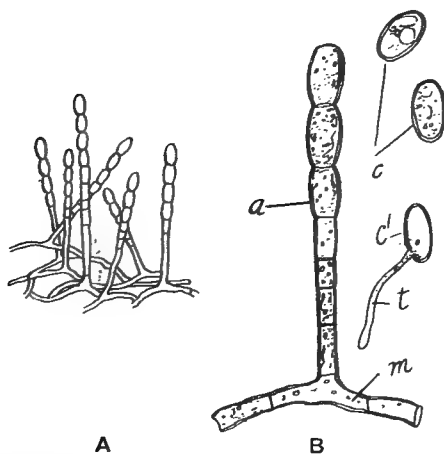

FIG. 254.—A, Mycelium and erect conidiophores of 'Hop-mould' (*Sphaerotheca Castagnei* Lev.). (Enlarged 100 diameters).

B Portion of mycelium *m* of same fungus with conidiophore (*a*) from the apex of which conidia (*c*) have been abjected; *c*¹ germinating conidium; *t* germ-tube. (Enlarged about 400 diameters).

fungus.

Not long after the hyphæ are established on a leaf, erect

branches grow up from them, each of which gives rise to a chain of oval conidia (Fig. 254). The latter become free from each other and give the mould-spot a mealy appearance.

Many of the conidia are carried by the wind to neighbouring plants where they germinate in a few hours and produce germ-tubes which penetrate into the epidermal cells of the leaves, and subsequently give rise to new mycelia thereon. As thousands of conidia are produced by a single mycelium, and each of them is capable of producing a new mould-spot when climatic conditions are favourable for their distribution and germination, it will readily be understood how quickly and silently the disease can extend through a hop-garden. It is in this manner that the parasite is propagated during summer.

The mycelium and its conidia are short-lived and cannot exist through winter. In late summer and autumn or earlier, if the affected leaves are weak, the fungus produces on its mycelium small round closed ascocarps, designated *perithecia*, which are often visible to the naked eye as minute black points where a mould-spot has been. These are dark brown in colour and formed of a network of cells, some of which grow out into long unbranched and hair-like *appendages* (*h*, Fig. 255).

According to some authorities they are the result of a fertilisation process between two crossing hyphæ.

Within and protected by the outer brown wall of the perithecium is a single transparent oval sporangium or *ascus* containing eight *ascospores*. The latter are oval and similar in size to the conidia, but instead of germinating as soon as they are produced, they rest during winter in their asci and perithecia, after falling to the ground with the dead leaves and affected hop-strobiles. In bad attacks where the vines have lain or where diseased leaves and strobiles have fallen, the surface of the soil is strewn with large numbers of ripe perithecia. In the following spring the asci absorb water and burst their walls and those of the enclosing perithecium, the ascospores

being at the same time forcibly ejected into the air and carried to the young vines and leaves growing near the ground. We thus see why it is that 'hop-mould generally commences close to the ground and spreads upwards, and why there are 'mouldy places' in gardens where the disease begins almost every year.

PREVENTION AND REMEDY.—(a) Although the complete destruction of 'hop-mould' is unattainable, every effort should be made to diminish its prevalence by burning all badly affected vines and leaves. This practice should especially be carried out

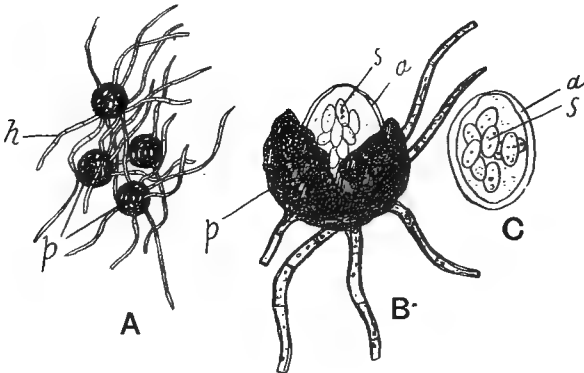

FIG. 255.—A, Perithecia (*p*) with appendages (*h*) of hop-mould (enlarged 12 diameters).

B, A single perithecium which has been burst; *a* ascus; *s* ascospores (enlarged 80 diameters).

C, A single free ascus (*a*) with ascospores (*s*) within (enlarged 90 diameters).

in cases after a bad attack where the hops have been not worth picking on account of 'mouldiness.' The vines should on no account be left lying about, as the spore cases are produced in thousands and fall upon the ground only to remain a certain source of infection for succeeding years.

The application of gypsum to the soil is said to be beneficial in such circumstances, but no trustworthy experiments upon

this matter have been carried out. Possibly lime might help to destroy the spore-cases.

(b) Certain varieties of hops seem to be specially liable to suffer from this trouble, but apart from possible inherent differences in the plants, more careful manuring should be adopted in order to produce a healthy growth. Excessive amounts of highly nitrogenous manures make the leaves more readily attackable by ‘mould.’ Anything which reduces the vitality of the hop—such as cold and damp nights, long continued drought, or wet weather and want of proper amount of sunshine and fresh air—indirectly aids ‘mould’ in its ravages.

It is generally in ‘housed-in’ parts, where the air is still and damp and where light does not easily penetrate, that the worst effects are seen. Systems of training hops should aim at reducing these drawbacks to a minimum.

Early trimming of the lower part of the bine diminishes the likelihood of attack from the soil and also allows of better air circulation.

(c) The ‘hop-mould’ fungus not only lives upon hops but also upon many wild plants—groundsel, dandelion, strawberry, avens, meadow-sweet, and many others. There is little doubt that it is from such sources outside the garden that many attacks of the parasite are begun, especially those which are observed to strike the outskirts or upper parts of a garden first. Weedy railway banks adjoining hop gardens, where trains pass frequently, are often subject to ‘mould,’ which appears to be due to the repeated movement of air laden with spores blown from the fungus growing upon weeds in the neighbourhood.

Hedges should be kept as clean and as free from weeds as possible, and an application of wash to dirty hedges when spraying the garden is well worth the trouble and expense, both for ‘mould’ and vermin of various kinds.

(d) The fungus lives and develops almost entirely upon the *outside* of the leaf, and on this account it would appear more easy to deal with it by means of washes and external applications of powdered substances than those cases like the potato-disease, where the growth of the fungus goes on chiefly *inside* the leaf.

The application by hand or bellows, or specially constructed machinery (sulphurators), of finely powdered sulphur to the affected leaf is a remedy for mildews of various kinds which has been employed for about half a century.

Mechanically powdered sulphur, *i.e.* roll-brimstone reduced to a finely pulverized state, by hand or machinery, often acts better than that form known as 'flowers of sulphur' obtained by condensation of its vapour or by precipitation processes. In any case the substance acts in two ways: (1) as a fungicide—that is a definite destroyer of the 'mould'; and (2) as a protection against further attacks and spreading, as spores will not germinate upon a sulphured leaf. It is chiefly in the second capacity, namely, a protector, that sulphur is so beneficial, and on this account every endeavour should be made to distribute it upon the youngest growth. As a direct fungicide it possesses little effect, and even for this small benefit it must be repeated frequently where 'mould' is bad.

The best results with sulphur are observed when the temperature is above 78° F., and it is, therefore, usually applied with success on clear bright hot days, usually in the middle of the day or early morning, when the leaves are partially damp with dew. In cold weather it is nearly useless, and in wet days the sulphur is soon washed off the leaf.

The general explanation of its action is that the sulphur becomes oxidised with the ultimate formation of sulphurous acid, and this latter substance is credited with the destroying effect upon the fungus. Sulphurous acid, however, in exceedingly minute quantities has a deleterious influence upon the hop-leaf itself.

Some experiments have indicated the formation of sulphuretted hydrogen.

The fact that sulphur acts most beneficially on hot days, and that the odour of a sulphured garden is not like that of either sulphur dioxide or sulphuretted hydrogen, but resembles that of roll-brimstone itself, suggests that sulphur vapour may be the active agent.

The possibility that the action is a mechanical one must also be borne in mind. Some authorities state almost any fine powder will do, that road-scrappings, brick-dust, chalk, and ordinary flour work as well as sulphur.

However, until we have more definite investigation of the action of sulphur powder upon the mycelium of the fungus, all explanations are little more than assumptions, and we are not likely to find a satisfactory or consistent and reliable method of applying sulphur to the best advantage.

(e) Under the assumption that sulphur has some specific action upon the fungus, various soluble compounds containing the ingredient are employed, chiefly the sulphides of sodium, calcium, and potassium ('liver of sulphur'). These substances are, undoubtedly, of considerable use in checking and destroying 'moulds' of all kinds. They are readily soluble in water, and are generally applied in the ordinary washes of soft soap and quassia at the rate of one and a half or two lbs. per 100 gallons of wash.

A wash of this description, followed by an application of powdered sulphur, is perhaps the most effective and safe means known at present for an attack of 'mould.'

The alkaline sulphides in solution do not keep well, unless air is excluded from the vessels in which they are kept. Without going into details it may be said that practically all 'mould' washes have, as a basis, one or more of the above sulphides in conjunction with substances like soap and glycerine, which tend to keep the wash upon the leaf till it has done its work, and which also prevent too rapid oxidation of the active ingredient.

Many other substances, notably preparations of copper (Bordeaux mixture, 'Fostite,' talc and finely-powdered copper sulphate) have a more certain effect in destroying 'mould,' but the application to hops is scarcely feasible on account of their somewhat poisonous properties.

Ex. 318.—Examine with a low power a mildew-spot on a hop-leaf. Observe the chains of conidia. Pull off a piece of epidermis with the fungus on it. Mount in water and examine with a high power. Draw the mycelium and erect conidiophores. Observe the colourless vacuolated contents of the hyphæ and conidia.

Ex. 319.—Cut transverse sections of a leaf through a mould-spot and examine with a high power. Note the bladder-shaped haustoria in the epidermal cells of the leaf.

Ex. 320.—Examine the underside of mouldy hop-leaves with a lens. Specimens are often most easily obtained from mouldy plants growing undisturbed in hedges. Note the groups of small, round, dark-brown perithecia. Take off some of the latter with fine forceps or needles and mount in water. Examine with a low power and make drawings of the perithecia and their filamentous appendages.

Examine the same with a high power. Press firmly on the cover-slip with the end of a lead pencil or other blunt piece of wood so as to rupture the brown wall of the perithecium. Note the transparent single ascus and the spores within it, also the thinner part of the apical wall of the ascus.

Rose-mildew (*Sphærotheca pannosa* Wallr.) is a species very common on cultivated roses. Its mycelium appears as a greyish-white film on the leaves, young shoots, and flower-buds of the plants, the parts attacked usually becoming more or less puckered and otherwise deformed.

The conidia and perithecia are similar in form and structure to those of *S. Castagnei*.

The same fungus is met with on the peach and apricot.

(ii) In the genus *Erysiphe* the conidia are similar to those of *Sphærotheca*, but the perithecia are somewhat flattened and contain several asci instead of one only.

Grass-mildew (*Erysiphe graminis* D. C.) is not unfrequently responsible for considerable injury to cereal crops and grasses

generally. The mycelium forms brownish-white irregular spots on the sheaths and blades of the lower leaves of young crops. It is most prevalent in summer among rankly-growing plants.

The conidia are produced in long chains on short conidiophores, the fungus in this stage of development being formerly known as *Oidium monilioides* Lk. The perithecia are brown, somewhat flattened, and contain from six to twenty asci in each, which set free their ascospores in spring after remaining dormant on dead leaves and straw during winter.

Pea-mildew (*Erysiphe Martii* Lev.) is a common species which attacks peas and other leguminous plants, especially in dry seasons. Its mycelium frequently spreads over both sides of the leaves of the host-plant, and damages the latter so much that pod-production is reduced, or stopped altogether. The fungus is most abundant on late varieties of peas.

The perithecia, which have colourless appendages, are dark-brown, and contain four to eight asci.

Various other species of *Erysiphe* are met with on Compositæ, Umbelliferæ, and Boraginaceæ.

(iii) The genus *Uncinula* has perithecia containing several asci, as in the genus *Erysiphe*; the appendages, however, are branched in a fork-like manner and always curved at their tips.

Vine-mildew (*Uncinula spiralis* Berk. and Curt.). The conidial form of this fungus was first noticed in England in 1845, and was first named *Oidium Tuckeri* by Berkeley: until quite recently the corresponding ascocarp or perithecium was not recognised. The oval conidia arise in short chains, only two or three being produced by each conidiophore.

The mycelium forms grey spots on the vine leaves, and after a time the affected parts of the latter die and shrivel. The fungus also attacks the young grapes and often kills them before they are larger than peas.

In many cases small portions of the surface of the berries are destroyed, and the fruits become deformed and cracked, after which decay, due to the entrance of saprophytic organisms, sets in.

(iv) Various injurious *Oidium*-forms are met with, which appear to belong to the *Erysiphaceæ*, but which cannot be assigned to any definite genus, because their perithecia are unknown. To this class belongs *Oidium Balsamii* Mont., so common in some seasons upon turnips, swedes, rape, and other cultivated species of *Brassica*.

The mycelium spreads over the whole plant, and the barrel-shaped conidia are sometimes produced in such quantities that the clothes and boots of persons walking through a field of diseased turnips or rape become chalky-white with the spores.

Badly-affected cruciferous plants give off a putrid odour, and in several cases we have known sheep poisoned by feeding on such diseased crops.

PREVENTION AND REMEDIES FOR MILDEWS.—The methods described under ‘Hop-mould,’ pp. 749-753, are applicable to all mildews. Every care should be taken to effectually dispose of the dead refuse which contains the perithecia of these fungi. Burning where possible is the best plan for destroying the diseased stems and leaves.

‘Bordeaux mixture’ and washes containing sulphur, either as such or in the form of sulphides of alkaline metals, are highly beneficial in cases of mildew attacks.

Ex. 321.—Make observations similar to those of Exs. 318 to 320 on rose, pea, grass, vine, and chrysanthemum mildews; pay special attention to the form and size of the conidia, the number of these on each conidiophore, and the form, size, and contents of their perithecia and asci.

4. ‘Ergot.’—An important parasite belonging to the *Hypocreaceæ*, another family of the *Ascomycetes*, is the ergot fungus, which attacks the ovaries of grasses and cereals.

SYMPTOMS.—In the ears of rye, wheat, and many pasture grasses dark purple-coloured bodies known as 'ergots' are found occupying the place of some of the grains. In rye and several grasses these structures are much larger than the natural grains and stand out from the glumes of the inflorescences in a conspicuous manner (*e*, Fig. 256), while in wheat and many smaller grasses the ergots are not larger than the grains which they displace.

Each ergot is solid and often slightly curved with a furrowed surface; although black or deep purple on the outside, it is white within, and waxy or oily in character, especially in fresh specimens.

The substance of the ergot contains several poisonous compounds, and continued use of bread made from the flour obtained from ergoted samples of wheat and rye has led to dangerous illness in human beings. Since the introduction of improved methods of screening and cleaning samples of grain, ergotism is of rare occurrence.

Abortion among cattle has been attributed to the consumption of ergoted grasses, but from carefully conducted experiments to test the matter there appears to be no ground for such belief, although serious poisoning effects resulting in numbness, paralysis, and gangrene of the extremities are rapidly produced when animals are fed with considerable quantities of ergoted hay.

CAUSE.—The 'ergot' is the compacted dormant mycelium of a fungus, *Claviceps purpurea* Tul., and is termed a *sclerotium*. The hyphæ composing it are so closely united and divided in



FIG. 256.—Inflorescence of False Brome grass (*Brachypodium pinnatum* Beauv.), with ergots *e* (natural size).

such short segments that sections of it resemble a parenchymatous tissue of the higher plants.

After being kept through winter and moistened, the ergot germinates and sends up several fleshy-pink stalks at the end of which are round heads or *stromata* (*s*, Fig. 257).

Imbedded within the substance of the latter are a large number of flask-shaped *perithecia* (*n*, Fig. 257), the narrow ends of which have a small opening outwards. From the base of the interior of the perithecia long club-shaped *asci* arise in which are eight filamentous *ascospores*.

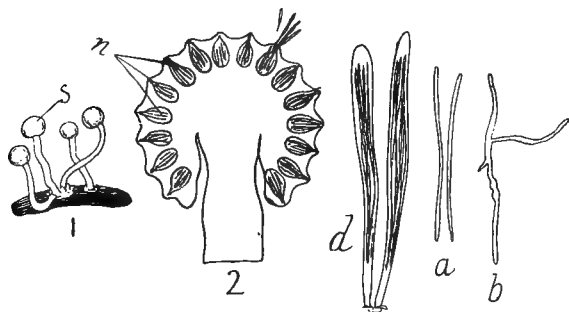

FIG. 257.—1. Ergot sclerotium germinated; *s* stromata (natural size).
2. Vertical section through a stroma; *n* perithecia (enlarged 15 diameters).
d Asci from perithecia; *a* ascospores; *b* germinating ascospore (enlarged about 380 diameters).

The ascospores are ripe about the time when grasses and cereals are in flower and are shot out of their asci and through the openings of the perithecia into the air. They are readily blown about by slight breezes, and after alighting on the flower of a grass they germinate and penetrate into the base of the ovary. The germ-tube feeds on the substances within the latter and soon grows into a white closely-woven mycelium on the outside of which are produced a number of short hyphæ bearing single small oval *conidia*.

At this stage of development of the fungus, a sweet, slightly milky juice, popularly spoken of as ‘honey-dew,’ is secreted, and the conidia float in it. Insects attracted by the sweet liquid unconsciously carry these reproductive bodies from flower to flower where they germinate and produce new mycelia similar to those produced by the ascospores. It is by means of these insect-carried conidia that the fungus is propagated throughout the summer. Before the life-history of the parasite was fully known, the conidial stage was looked upon as a distinct species belonging to the genus *Sphacelia*.

While the conidia are being produced the mycelium continues to grow and form a compact, elongated mass of hyphæ, which pushes aside the withered ovary, or carries the latter on its apex. After a time the formation of conidia ceases and the fully-grown mycelium becomes gradually transformed into the firm, dark-coloured ergot, which, when mature, falls to the ground and remains dormant during the winter.

PREVENTION AND REMEDY.—(a) Draining tends to diminish attacks of ergot, and deep ploughing to bury the fallen ergot is beneficial.

(b) Meadows should be cut when the grasses are in bloom before the fungus has time to complete the formation of a mature sclerotium.

(c) Small patches of grasses in pastures are sometimes found to be much infested with ergots; in such cases the tops of the grasses should be cut off with a scythe and then raked together and burnt.

(d) Samples of cereal grains or grass ‘seeds’ containing ergots should not be sown.

Ex. 322.—Examine the dry inflorescences of grasses in rough pastures in late summer and autumn for specimens of ergots. The latter are often common and conspicuous on rye-grass, cocksfoot, and species of *Brachy-*

podium growing near roadsides and by the sides of footpaths through pastures.

Cut transverse sections of an ergot and note the colour of the interior; mount in water and examine with a high power.

Ex. 323.—For the form and contents of the perithecia and asci in the Hypocreaceæ, transverse sections of those of *Epichloë typhina* are usually more conveniently obtained than those of *Claviceps*. The fungus is frequent in many places as a muff-like white or yellowish band round the base of the leaf-sheaths of cocksfoot (*Dactylis*) and Timothy (*Phleum*) grasses.

CHAPTER LI.

‘ CLUB-ROOT ’ DISEASE.

SYMPTOMS.—This disease, which is variously known as ‘club-root,’ ‘finger-and-toe,’ ‘anbury’ and ‘canker,’ attacks many species of cruciferous plants, and is especially destructive to the cultivated species of *Brassica*, such as turnips, swedes and cabbages. It is worthy of note that certain races of these plants are more subject to the disease than others; cauliflowers and Brussels sprouts, for example, are very liable to it, while the kails are capable of resisting its ravages to a considerable extent.

The disease appears to make greatest progress in summer; the earlier spring vegetables in gardens often escape altogether, or suffer very little from it.

Infected young plants show irregular thickening and knob-like swellings on their roots. The diseased parts, when cut across, are solid and of greyish colour, mottled with small, white, opaque patches. As the plants increase in age, the swellings become larger and larger, often reaching the size of a man’s fist (Fig. 258). The upper parts of the plant develop very slowly; cauliflowers and cabbages attacked by the disease make little or no ‘head,’ all the nutriment prepared in the few expanded leaves of the plant being used up in the growth of the swollen roots.

The ‘clubbed’ parts after a time turn brown and decay; in dry soils the rotten portions become brittle and fall into powder or small fragments; while in damp, stiff soils the decayed mass is semi-liquid, and emits an offensive odour.

Although the plants produce adventitious roots when the natural roots are destroyed, these new roots soon become in-

fectured with the disease, and on pulling up a diseased plant, a mere blunt, woody stump is often found to be all that remains underground.

The roots of healthy plants in dry soils are frequently unable to keep pace with the loss of water by transpiration in bright,

hot weather, and the leaves consequently become limp; during the night transpiration is much reduced, and the roots soon make good the loss of water, the leaves in the morning exhibiting their ordinary fresh appearance. In 'clubbed' plants, however, the root-system is more or less permanently injured, and the leaves, after withering in the daytime, do not regain their normal turgid condition during the night.

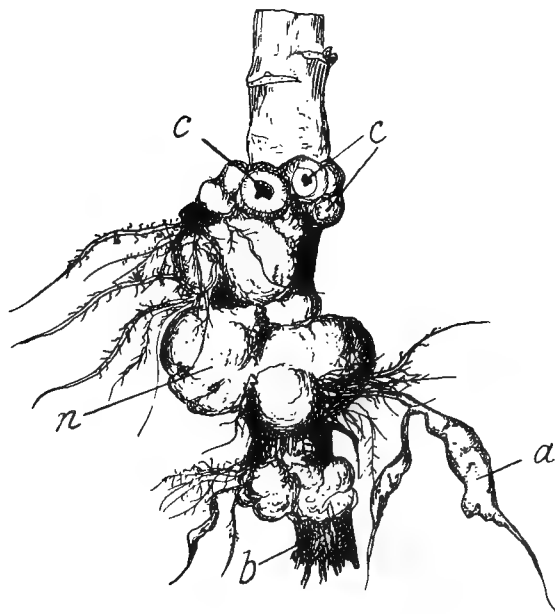

FIG. 258.—'Clubbed' root of cabbage: *a* young clubbed adventitious root; *n* older clubbed part; *c* insect-galls, two cut across to show hollow interior; *b* decayed stump of old root (half natural size).

Some of the rounded thickenings or *galls*, about the size of a pea or marble (*c*, Fig. 258), met with upon the lower parts of the stems of cabbages and on the outside of turnip and swede 'roots,' are caused by the larvæ of a weevil (*Ceutorhynchus sulcicollis*), and are in no way connected with 'club-root' disease, although both

true 'clubbing' and insect-galls are frequently observed upon the same plant. The latter are, however, usually found above, or only just below, the surface of the ground and on the *stems* of the plants, whereas 'clubbing' attacks the *roots*, generally some distance below ground. Moreover when young the insect-galls are hollow, and contain whitish grubs or larvæ, which are readily observed when the former are cut across with a knife.

The insect-galls are practically harmless, and do not induce the total decay of the roots, as in the case of true 'clubbing.' 'Clubbed' parts are solid when young, and very rarely if ever contain larvæ of insects.

Wallflowers, candytuft and other cruciferous garden plants are affected by the disease, but the latter does not attack carrots, mangolds, or parsnips, although fanged, irregular-rooted specimens of these plants, due to degenerate stock or imperfect cultivation of the soil sometimes resemble plants suffering from this disease.

CAUSE.—'Club-root' is caused by an organism named *Plasmodiophora Brassicæ* Wor., which is usually classed with the *Myxomycetes* or slime-fungi.

On examining a section of a young diseased but undecayed root with the microscope, many large cells are noticed, filled with a frothy, turbid, and somewhat brownish protoplasm distributed irregularly among the smaller cells of the cortex and medullary-ray parenchyma of the cabbage root (*n*, Fig. 259). Each such piece of protoplasm represents the vegetative body or *plasmodium* of a single organism.

The plasmodium feeds and grows at the expense of the cell-contents and food manufactured by the cabbage plant, and after a time divides into a very large number of transparent, round, thick walled spores (*r*, Fig. 259), which, when decay of the diseased parts takes place, are set free into the ground in millions.

When a spore germinates a small opening appears in its wall, through which the protoplasm within makes its exit.

When quite free the naked piece of protoplasm swims about for a few hours by means of a thin flagellum (*c*), and finally becomes a creeping amœba-like organism, termed a *myxamœba* (*d*).

How long the spores can remain in the soil without germinating, and whether the myxamœbæ can live as saprophytes in the

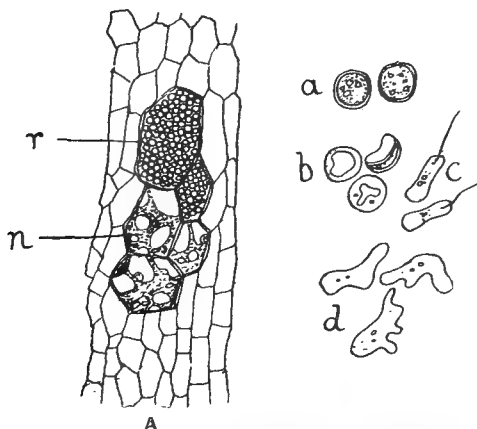

FIG. 259.—A Transverse section of a portion of the clubbed tissue of a cabbage root; *n* plasmodium; *r* fully developed spores (enlarged 80 diameters); *a* two ripe spores; *b* empty spore membranes; *c* 'swarm-spores,' or naked protoplasmic contents soon after exit from *b* (enlarged 950 diameters); *d* myxamœbæ, later stage of *c*.

ground are unsettled points. The myxamœbæ, however, readily find their way into the roots of cabbages, turnips and other cruciferous plants growing in their vicinity, most probably by way of the root-hairs. After they have entered the root they creep from cell to cell, feed on the contents of the latter, and

ultimately grow into the large plasmodia mentioned above; possibly in some instances several myxamœbæ coalesce to form a single large plasmodium.

PREVENTION AND REMEDY.—(*a*) Plants which are to be subsequently transplanted should not be raised upon ground which has previously carried a diseased crop, and seedlings showing signs of clubbing should be burnt.

All plants which after transplanting are found to be diseased should be taken up completely before the affected parts decay; if left until rotten, the ground becomes infected with myriads of

spores, and destruction of the stumps or remaining parts of the plants is only half a remedy.

(*b*) It is important to recognise that all diseased decayed refuse from ‘clubbed’ crops constitute a possible source of infection, and require to be dealt with accordingly. Whenever practicable, refuse of this character should be burnt; if thrown away, it should be placed in some situation where it is not likely to be transferred subsequently to cultivated soil, and on no account should it be put on the manure heap.

Diseased plants should not be given to pigs, for we have met with one or two cases where ground previously free from the disease has been rendered almost useless for the growth of cruciferous crops by the application of manure from pig-styes into which clubbed plants had been thrown.

(*c*) It appears that the spores of the organism may remain in the soil dormant though still capable of germination for at least two or three years, or the myxamœbæ are able to live as saprophytes for that length of time, for it has been found that healthy plants become infected when transplanted into soil which, two or three years previously, had carried a diseased crop. It is, therefore, advisable to avoid cropping with cruciferous plants for two or three seasons after a bad attack. Crops, such as grain of all kinds, mangels, potatoes, strawberries, and others not belonging to the Cruciferae, may be grown without fear of their being injured.

(*d*) ‘Clubbing’ is rarely or never met with on soils rich in lime, unless plants already suffering from the disease are transplanted thereon. On the other hand, upon sandy and clay soils which are deficient in this element, ‘clubbing’ is very often severe.

The application of a good dressing (3 or 4 tons per acre) of unslacked or recently slacked lime reduces the disease very considerably and frequently destroys it altogether: the lime should be worked into the soil some time before the latter is cropped.

Gas lime has little or no effect upon *Plasmodiophora*. An acid condition of the ground or the application of acid manures, such as superphosphate of lime, encourages the organism, while alkaline compounds diminish its power of attack.

Ex. 324.—Dig up a 'clubbed' cabbage and note the form and position of the thickened parts. Cut across the undecayed thickened parts of a small secondary root and examine with a pocket lens. Observe the small white opaque spots : are they more abundant in the centre or near the outside?

Compare the colour of the interior of a large swelling which has begun to decay.

Ex. 325.—Cut across the knob-like thickenings at the upper part of the diseased root of a cabbage or the small round lumps on the outside of a turnip 'bulb.' If hollow, look for white larvæ of insects.

Ex. 326.—Examine thin sections of 'clubbed' parts of a cabbage root in water with a $\frac{1}{2}$ inch and then with $\frac{1}{8}$ or $\frac{1}{4}$ inch objective. Make sketches of the plasmodia and spores *in situ*.

Ex. 327.—Where 'clubbing' is prevalent, make a note of the kind of soil on which the plants are growing—whether stiff clays, light sands, loams, or chalky soils. Take small samples of each soil, place them in evaporating dishes and pour hydrochloric acid over each ; note the amount of effervescence produced in each case.

PART VIII.
BACTERIA.

CHAPTER LII.

BACTERIA: THEIR MORPHOLOGY AND REPRODUCTION.

1. THE Bacteria are a group or class of organisms included in the Thallophytes, and sometimes designated *Schizomycetes* or splitting-fungi. They appear, however, to exhibit little or no relationship to the true fungi, except that, like the latter, they are devoid of chlorophyll.

The body of each individual bacterium is of the simplest character, consisting of a single cell, which is most frequently either spherical, rod-shaped, or bent in the shape of a spiral or bow (Fig. 260).



FIG. 260.—Forms of bacterial cells: 1. Coccus; 2. bacillus; 3. vibrio; 4. spirillum.

When spherical, the bacterium is termed a *coccus* (1), if rod-shaped or cylindrical and more than twice as long as broad it is known as a *bacillus* (2), while the term *bacterium* is not only employed in a general sense to denote any organism belonging to the Schizomycetes, but is also used in a restricted sense for a rod-shaped organism, which is shorter than a bacillus.

The form of bacterium known as a *vibrio* (3) is bent like a bow, that shaped like a cork-screw being spoken of as a *spirillum* (4).

Besides these normal forms, all bacteria when subjected for some time to conditions unfavourable to their nutrition, assume irregular shapes, such degenerate or malformed cells being designated *involution-forms*.

Although variable in size, the bacteria are among the smallest of living things known, the largest coccus being less than a ten-thousandth of an inch in diameter.

The cell-wall is a firm thin membrane, most frequently com-

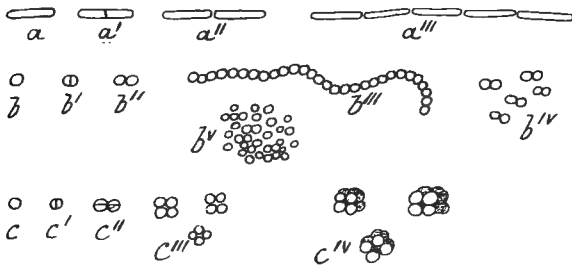

FIG. 261.—Diagrammatic representation of the methods of vegetative reproduction among common bacteria.

a A bacillus successively dividing at *a'*, *a''*, and *a'''*.

b A coccus giving rise to chains, *b'''* (*Streptococci*), pairs, *b'v* (*Diplococci*), and irregular groups, *b''v* (*Staphylococci*).

c A coccus giving rise by division in two directions to *c'''* (*Micrococci*) and by division in three directions to *c'v* (*Sarcinæ*).

posed of an albuminoid substance — not cellulose — and the protoplast within appears to be devoid of a definite nucleus.

In some instances the outer layer of the cell-wall absorbs water and swells like mucilage; in such cases large numbers of individual bacteria often become joined together and form irregular gelatinous masses, known as *zooglyca*.

Many bacteria have hair-like *flagella* or *cilia* (6, Fig. 262) attached to the exterior of the cell-wall, by means of which they are able to swim freely in water and other liquids.

2. **Vegetative Reproduction.**—The method of vegetative reproduction, which is so characteristic of the whole group of

bacteria and which has given rise to the name splitting-fungi, consists of a simple division of each cell into two similar halves, each of which afterwards grows to an adult state and then repeats the process (Fig. 261).

In the cylindrical and spiral forms division takes place almost always in one direction only, namely, across the cell, that is at right angles to its long axis (*a*). The new individuals produced may separate from each other as soon as the division is completed, or they may remain attached to each other in larger or smaller numbers: in the latter case long threads are produced.

In the round or coccus forms, division takes place in one, two, or three directions (*b* and *c*), so that if the individual cells remain united with each other after their formation, threads, plates or cubical masses are produced. Those coccus forms which divide in one direction only and remain attached to each other in longer or shorter chains (*bⁱⁱⁱ*, Fig. 261), are usually included in the genus *Streptococcus*, those occurring in cubical masses (*c^{iv}*, Fig. 261) constitute the genus *Sarcina*, while the genus *Micrococcus* embraces the forms which divide in two directions (*cⁱⁱ*, Fig. 261).

The rate at which vegetative reproduction proceeds naturally depends upon the temperature, nutrition, and other conditions to which the organism is subjected, but under the most favourable circumstances many bacteria divide once or twice in an hour, so that a single specimen multiplying at the latter rate, for even a day, would give rise to several millions of new individuals. Unchecked growth of this kind rarely goes on for any great length of time, for species are often antagonistic to each other, food runs short, or the products of their activity accumulate and prevent further development.

3. Reproduction by means of Spores.—Besides the vegetative method of multiplication described above, many species of bacteria form *spores* within their cells which are capable of germinating and producing new organisms.

The spores are usually produced under conditions which are unfavourable to the vegetative development of the bacteria, such as want of food and water, unsuitable temperature, excess or deficiency of air, and other adverse circumstances. In their formation, the protoplasm shrinks away from the cell-wall and surrounds itself with a more resistant and firmer membrane, after which the old cell-wall disappears by solution or breaks up and sets free the spore. One spore only is usually produced at the end or in the middle of each single

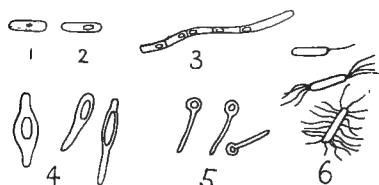

FIG. 262.—1. Bacterium showing beginning of spore formation, completed in 2. 3. Chain of bacterial cells in each of which spores have been produced. 4. Forms of *Clostridium* cells with spores. 5. Drumstick-shaped bacteria with spores at one end. 6. Bacteria with cilia.

as in the tetanus bacillus (5, Fig. 262).

The spores are capable of resisting without injury high temperatures, and solutions of disinfectants which would kill the bacteria in a vegetative state; moreover, like the seeds of higher plants, they often retain their vitality for many years.

When placed under favourable conditions of temperature and in suitable solutions the spores germinate. At first water is absorbed and the spore enlarges and loses its brilliant appearance: sometimes the whole spore became gradually transformed into a new vegetative cell (1, 2, Fig. 263), while in other cases its membrane opens at the end or near the middle as at 5, Fig. 263, and the protoplasm surrounded by a thin cell-wall makes its exit in the form of a more or less elongated rod which soon commences vegetative division.

Some of the vegetative cells of certain bacteria are capable of

bacterial cell, and appears as a round or oval body, with highly refractive cell-contents. In some instances the mother-cell at the time of spore-formation undergoes a change of form, becoming spindle-shaped as in *Clostridium* (4, Fig. 262) or shaped like a drum-stick

entering into a state of rest for a time, after which they may resume active growth: such resting-cells are frequently termed *arthrospores*.

4. Although there is little doubt that a large number of distinct species of bacteria exist, the classification of these organisms into species and genera is rendered difficult on account of their minute dimensions and the simplicity of their organisa-

tion; besides, their form, which has been taken as a basis of classification, is subject to variation, for example a species occurring usually in the form of a bacillus may under some conditions appear as a coccus. Moreover, the attempts to define the limits of each species by taking into consideration its power of producing spores, the presence or absence of cilia and other variable characters of the organism have not yet led to any complete or satisfactory system of classification. The names which at present are most commonly in use for what are supposed to be distinct species are double as in the case of higher plants; the first or generic name indicates the form which the bacterium most frequently assumes, while the second or specific name often denotes some physiological or other peculiarity: for example, the organism which is met with in the form of a bacillus, and is the cause of the disease tetanus or lockjaw, is named *Bacillus tetani*: another occurring in the form of a coccus and capable of producing lactic acid from sugar is known as *Micrococcus acidi lactici*.

5. On account of their small size and consequent lightness, bacteria are readily blown about by the wind and carried in streams of water to all parts of the earth. Wherever decay and putrefaction of organic substances are going on, they are present in especial abundance and are met with in enormous numbers in the air, in the upper regions of the soil, on our clothes and

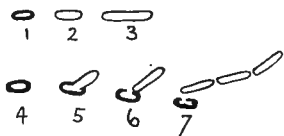

FIG. 267.—1, 2 and 3. Diagrammatic representation of the successive stages of germination of a bacterium spore. 4, 5, 6 and 7. Another common method of germination of a bacterium spore.

skin, in all our food-stuffs, in the alimentary canal of animals, and all over the globe wherever dust can find a lodging-place. They are, however, absent from the tissues of healthy animals and plants; moreover, in the air on high mountains, and in water from springs and deep wells which has been filtered through great depths of soil and rock, their numbers are few.

6. For the development and multiplication of bacteria certain external conditions are needful, the chief of which are given below.

(a) *Darkness*.—While a few bacteria appear to need a certain intensity of light to enable them to carry on their functions, by far the larger number of species require darkness for their proper development, being checked in their growth even by diffuse daylight and entirely destroyed by exposure for a few hours or days to direct sunlight.

(b) *Water*.—For the continuance of active life in all kinds of organisms water is necessary, but the spores of bacteria are able to withstand dessication for a long time, in some cases for several years. In the vegetative state, however, dryness checks the vitality of these organisms, and if continued for a few weeks results in their death.

(c) *Heat*.—The temperature most suited to growth varies with each species of bacterium. Some met with in the soil are able to multiply at freezing-point, while the tubercle bacillus does not grow below a temperature of 30° C. and thrives best when kept about 37° C. One species, *Bacillus thermophilus*, which has been obtained from soil, sewage and other sources, develops extensively at 70° C., a temperature which is sufficient to coagulate egg-albumin and cause the death of all animal cells.

The temperatures most favourable for the growth of a number of common species lie between 25° and 35° C. As the freezing-point is approached division ceases but the organisms are capable of enduring very low temperatures without losing their

vitality. At higher temperatures, for example between 42° - 50° C., growth ceases, and when kept at 55° or 60° C. for ten or twenty minutes, the vegetative cells of most common species of bacteria are killed. The spores, however, in some cases resist the action of boiling water for three hours or more, and have been found capable of development after exposure for an hour to a dry heat of 130° C.

(d) *Oxygen*.—A large number of bacteria are dependent upon the presence of free oxygen in the atmosphere, and such species are spoken of as *aërobic*. There are, however, many, such as the butyric acid bacteria and the tetanus bacillus, whose vital activity is checked altogether when they are exposed to this gas in a free state; these are said to be *anaërobic*. Between the *obligate* aërobic species which die unless well supplied with air, and the *obligate* anaërobic types whose development is arrested by traces of oxygen, a number of species exist which are more or less indifferent to the presence or absence of oxygen: those, such as the lactic-acid bacteria, the species causing putrefaction, and the cholera bacillus, which are usually aërobic but which can still maintain a certain degree of activity when the amount of free oxygen is much reduced, are described as *facultative* anaërobic bacteria, while those generally anaërobic but capable of growth when surrounded by free oxygen are spoken of as *facultative* aërobic species.

(e) *Food*.—Food is necessary for all living organisms, and the elements composing it are practically the same for bacteria as for green plants (see p. 168). The phosphorus, sulphur, and various essential metallic elements are readily obtained from phosphates and sulphates of potassium, calcium, magnesium and iron.

A few species of bacteria are able to obtain the carbon they need from carbon dioxide, but most of them require organic compounds for the supply of this element. As sources for their necessary nitrogen certain bacteria are able to utilise the free

nitrogen of the air or nitrates and ammonium salts. The majority, however, can only make use of the nitrogen of complex organic compounds such as albuminoids and amides.

Milk, beef-broth, beer-worts and decoctions of various fruits are liquid media largely employed in the artificial nutrition of bacteria. Solid jelly-like media are essential for the separation and growth of certain species; most of them consist of beef-broth, solutions of peptone, sugar or other substances to which is added a certain amount of gelatine or agar-agar.

7. Just as in a natural pasture, wood, or meadow, it is usual to find a number of distinct species of plants growing together, so it is usual in any decomposing organic substance or wherever bacteria are met with to find a mixture of species present. Moreover, as it is possible to cultivate in a field or garden one species of green plant by itself, so is it possible to grow in nutrient solutions one species of bacterium free from admixture with all others, in which latter case the growth is termed a *pure culture*.

Into the details of the pure cultivation, or the separation and growth of individual species of bacteria we cannot here enter: it may, however, be mentioned that it is only by pure cultivation that a correct knowledge is obtained of the physiological powers of these organisms.

8. **Sterilisation: Pasteurisation.**—In the cases of those bacteria which give rise to diseases or to objectionable fermentations such as the souring of milk, the putrefaction of flesh, and other chemical changes described in the following chapter, methods must be adopted to check their activity or to destroy them altogether.

Milk, beer, flesh and all substances from which all living organisms have been removed or destroyed are said to be *sterile* and will keep indefinitely if, after the process of sterilisation the further access of bacteria is prevented.

A large number of methods of *sterilisation* are in daily use, the

chief of which are based upon the destructive action of high temperatures, or upon the poisonous nature of certain chemical compounds.

(a) By maintaining a low temperature, food-stuffs may be kept for an indefinite time without change. In a frozen state meat and milk are transported from one part of the world to another without damage, and it is well known that fruit, jam, milk, bread, and flesh 'keep' best in cool, dry situations. In such cases the low temperature merely checks the development of the bacteria present for a time, and does not destroy them; a sterile condition, therefore, is not produced by processes of this kind, and when the temperature is raised the organisms begin their work with unabated vigour.

(b) The keeping qualities of substances are greatly increased by roasting, baking, boiling, or steaming, for most bacteria are killed by these processes. The most certain and complete sterility is obtained by the application of heat. A temperature of 150° C. maintained for an hour is sufficient to destroy all forms of bacteria, their spores included. Even the boiling of liquids, such as water, milk, and broth, at 100° C. kills all bacteria contained in them if continued long enough, but certain spores resist this temperature for several hours. Usually it is only needful to keep most common liquids at 100° C. for fifteen or twenty minutes to destroy all bacteria in a vegetative condition and a great many of their spores also.

By repeated heating on three or four successive days, during which intervals the spores are allowed to germinate, it is possible to completely sterilise a liquid without going above a temperature of 100° C.

'*Pasteurisation*' or heating for twenty minutes at 70° C., followed by rapid cooling, is a process sufficient to kill almost all objectionable bacteria occurring in milk and other liquids, without materially altering the taste or composition of the latter. It does not, however, destroy the spores of these organisms, and

is consequently only useful in preserving foods for a limited time, and for the destruction of sporeless species of bacteria.

(c) The vitality and work of bacteria are checked or destroyed by various chemical substances; those compounds which completely annihilate bacteria are termed *disinfectants*, while the substances which merely retard the growth of these organisms are known as *antiseptics*. No hard line of separation, however, can be drawn between these two classes, for the effect of any chemical compound depends upon the strength of its solution and the time it is allowed to act. Moreover, what would be sufficient to destroy or impede the growth of one species of bacterium would not be effective on another species.

The best disinfectants are mercuric chloride (0.2 per cent. solution), sulphur dioxide and chlorine gases, phenol (10 per cent. solution), and formaldehyde: in weaker solutions the above are antiseptics only, to which may be added salicylic acid, boric acid, milk of lime and alcohol.

(d) Although those filters in use for domestic purposes are generally worse than useless, it is possible to remove all bacteria from liquids by filtration through specially prepared apparatus.

(e) Bright sunlight is destructive to bacteria and their spores.

CHAPTER LIII.

BACTERIA: THEIR WORK.

1. THE food which is needed for the nutrition of nearly all bacteria is either derived by the latter from dead organic substances or from living organisms. Those bacteria which feed upon dead organic matter are termed *saprophytes*, those which live upon the organic compounds within the tissues of living animals or plants being designated *parasites*. Many parasitic bacteria are the cause of infectious diseases of which tuberculosis, diphtheria, and typhoid fever are typical examples. Perhaps the saprophytic species claim the greatest share of the farmer's attention, for they are the special agents concerned in the processes of putrefaction and decay by which the dead bodies of animals and plants are ultimately converted into simple substances such as ammonia, nitrates, carbon dioxide and water, which are of paramount importance in the nutrition of green plants. Moreover, to this class of bacteria we owe a number of useful, as well as baneful, chemical changes such as occur in the souring of milk and beer, the ripening of cheese, the nitrification of manures, and many other familiar decompositions which organic substances undergo.

These chemical changes are usually included under the term *fermentation* and are connected in some unexplained manner with the vitality and multiplication of certain bacteria, for they do not take place unless these specific organisms are present and in a living condition. Most of these fermentations are complicated physiological processes which cannot at present be expressed by chemical equations although the

attempt to do so is frequently made. The products of fermentation are variable in amount and kind, according to the substances fermented, the species of bacteria carrying on the work, and external conditions such as temperature and absence or presence of oxygen. In most instances, however, there is in each case a characteristic production of one or two compounds from which the fermentations are ordinarily named; thus it is customary to speak of lactic fermentations, butyric fermentations, and marsh-gas fermentations, in which cases lactic acid, butyric acid, and marsh-gas are the *chief products* of the respective processes.

The organisms to which the fermentations are due are known as *organised ferments* to distinguish them from *enzymes* or *unorganised ferments*, the latter, as indicated in chapter xviii., being soluble organic but lifeless substances secreted by plants and animals, and capable of inducing hydrolysis and other changes in various chemical compounds. Enzymes are manufactured by many species of bacteria, and to these bodies are due some of the special powers of fermentation possessed by the organisms in question; nevertheless, it is not at present possible to explain all the phenomena of bacterial fermentations by the action of enzymes.

2. In order that advantage may be taken of the processes which are useful to mankind, it is important to study the nature of the species of bacteria to which they are due, and the conditions under which the particular organisms carry on their work most satisfactorily.

About many of these processes little is yet accurately known; the most important of those which are best understood are described in the present chapter.

3. **Lactic Fermentations.**—When milk is left exposed to the air in a warm room for a few hours it develops a sour taste. Investigations show that the latter is caused by the presence of lactic acid which has been produced from a portion of the milk-

sugar originally present in the milk. This apparently spontaneous chemical change is the result of the vital activity of bacteria which obtain access to the milk after it is drawn from the cow, for if special precautions are taken to prevent their admittance or to destroy them by heat and other means after they have entered, the milk remains unchanged for an indefinite period.

A large number of species of *Micrococcus*, *Bacterium*, and *Streptococcus* have been isolated from milk and other substances which are capable of inducing the above chemical change. Some of them are comparatively rare. The organism most commonly and widely distributed, and which is usually the cause of the souring of milk, is *Streptococcus lacticus* Kruse, or *S. Guntheri* L. and N.—a short somewhat anaërobic bacterium or oval coccus mostly occurring united in pairs. It breaks down the milk-sugar into optically inactive lactic acid, carbon dioxide gas, and small amounts of acetic acid, and other substances. Unless precautions are taken to neutralise the lactic acid with carbonate of lime or some similar compound, only a small portion of the sugar is decomposed, the fermentative activity of the bacilli being checked when the free acid formed reaches about .8 per cent.

The amount of acid produced in the case of this organism is sufficient to precipitate the casein of the milk in irregular coagulated lumps, so that not only is the milk rendered sour, but it is curdled as well.

To the farmer whose object is the sale of fresh milk the lactic bacteria are objectionable organisms. Their activity is greatest at about 30° or 35° C., but below this temperature they can in a few hours render milk unsaleable. To avoid their multiplication and injurious effects milk should be cooled as soon as possible after milking, and kept at a low temperature. Moreover, the milk-cans and the vessels in which it is stored should be thoroughly cleaned and scalded with boiling water before use in order to destroy these and any other bacteria present.

To the producer of butter the lactic bacteria are useful for they

play an important part in the 'ripening' process to which cream is subjected in this country before being churned. The development of a small amount of lactic acid in the cream increases the yield of butter which can be practically obtained from it by churning, and doubtless influences the flavour of the butter also.

In order to secure the presence of the lactic organisms upon which the required degree of acidity depends, it is generally customary to add to the 'sweet' cream a small quantity of sour milk, buttermilk from a previous churning, or a pure-culture of the lactic bacteria.

Besides milk-sugar, other sugars such as maltose, cane-sugar, and glucose, are transformed partially into lactic acid by various species of bacteria, and the development of sourness in beer, wine and other liquids is sometimes due to the formation of this acid from the soluble carbohydrates present.

4. **Butyric Fermentations.**—Fermentations which result in the production of butyric acid are common, and a considerable number of bacteria capable of inducing the formation of this acid in various media have been studied by different workers. Much of the investigation has been of a disconnected and untrustworthy character, and the relationships and powers of the various species or forms of the organisms dealt with by the many workers in this field of research is still somewhat uncertain.

From the recent investigations of Schattenfroh and Grassberger it would appear that the various forms described by Prazmowski, Gruber, Beyerinck, Klecki, and others, may be reduced to two chief species or races belonging to the genus *Granulobacillus*.

One species is non-motile, the other motile: the non-motile forms liquefy gelatine, while the motile ones do not.

Both species and their forms are common in milk and

cheese, in meals of various cereals, and in soil and dung of farm animals.

The organisms capable of causing butyric fermentation are long, cylindrical bacilli, which become spindle-shaped (4, Fig. 262) when spore-formation is completed. They are all anaërobic and furnish some of the best examples of this class of bacteria.

Within their cell-walls, or in the protoplasm, is stored up a substance which resembles starch in that it becomes a violet or purple colour when treated with a solution of iodine.

The spores of all these organisms are highly resistant to heat, and will sometimes retain their germinating power after being subjected to the action of steam for an hour and a half.

When grown under anaërobic conditions in nutrient media containing dextrose, cane-sugar, starch, or maltose, all the species produce butyric acid, as well as lactic acid and considerable amounts of the gases carbon dioxide and hydrogen. Milk-sugar in certain cases is fermented with the production of butyric acid alone, but with this exception, when carbohydrates are fermented by these organisms, the production of butyric acid is always accompanied by the formation of lactic acid, and in some instances a larger amount of lactic acid is produced than butyric.

In ordinary fermentation of milk, the anaërobic conditions necessary for the growth of any butyric organisms it may contain are only attained after the aërobic lactic bacteria have exhausted the liquid of free oxygen and given rise to lactic acid. When calcium carbonate is added to milk undergoing lactic fermentation, the calcium lactate formed is afterwards readily changed by the butyric organisms present into calcium butyrate with the simultaneous production of considerable quantities of carbon dioxide and hydrogen.

In addition to the production of butyric acid from the action of these organisms upon carbohydrates and lactates, it is probable that this acid is sometimes produced in the fermentative decomposition of proteids by various species of bacteria.

Butter which has developed the peculiar aroma and flavour termed 'rancidity' contains butyric acid as well as other compounds possessing a disagreeable odour.

5. **Acetic Fermentations.**—The surface of beer and wines containing not more than 14 per cent. of alcohol when exposed to the air for a few days becomes covered with a thin tough whitish skin or filmy scum and the liquids turn sour. The film on examination is found to be a bacterial zooglœa (p. 770), the individual organisms forming it being united together by the swollen gelatinous external portions of their cell-membranes. The sourness is due to the activity of the bacteria which produce acetic acid from the alcohol originally present in the liquids, the oxygen necessary for the chemical change involved in the process being derived from the air. The fermentation does not always cease with the production of acetic acid, for as soon as all the alcohol has disappeared the organisms attack the acetic acid, which has been formed and oxidise it to carbon dioxide and water.

Acetic fermentation is the basis of the manufacture of vinegar from fermented malt-liquors or fermented grape-juice, and the gelatinous zooglœa is sometimes spoken of as the 'mother of vinegar,' or the 'vinegar-plant.' The bacteria constituting these 'vinegar-plants' are not always the same, several distinct species being recognised. Most of them carry on their work vigorously at 27° C.: those best known are *Bacterium aceti*, *B. Pasteurianum*, *B. Kutzianum* of Hansen, *Bacterium aceti* and *Bacterium xylinum* of Brown, and *B. oxydans* and *B. acetosum* of Henneberg. The three former species are ex-

tremely polymorphic, each being capable of assuming the shape of short rods, long rods, and irregularly distended involution forms.

The cementing gelatinous portion of the zoogloea in *Bacterium xylinum* consists of cellulose, and the organism can form this substance from the sugars dextrose and levulose.

6. Fermentation of Cellulose.—A large portion of the cellulose contained in the tissues of plants disappears in the passage through the alimentary canal of cows, horses, sheep, and other herbivorous animals. Formerly it was thought that the dissolution and destruction of the cellulose under these circumstances was due to the action of enzymes concerned in the ordinary process of digestion: it is now known, however, that a great part of the decomposition is brought about by bacteria present in the first stomach and intestines of these animals. The cellulose is split up chiefly into carbon dioxide and methane or marsh-gas (CH_4), but small quantities of hydrogen, acetic, butyric and other acids are produced at the same time. The fermentation can be carried on outside the body of the animal when nutrient solutions containing cellulose are inoculated with a small portion of the contents of a herbivorous animal's colon.

The process also goes on in dung-heaps, the necessary condition for the most vigorous activity of the bacteria concerned in it being an adequate degree of moisture, absence of air, and a temperature between 40° and 50° C.

The same or a similiar type of fermentation takes place in silage, and also among the plant-debris present on all soils and in the mud of swamps and stagnant ponds: much of the marsh-gas and carbon dioxide produced rises in conspicuous bubbles when the mud at the bottom of a stagnant pool is stirred up with a stick.

The particular species of bacteria concerned in the marsh-gas fermentation of cellulose are not yet known with any degree of certainty. Some of them appear to be allied to the butyric bacteria. Omelianski isolated from river mud and horse dung an anaërobic slightly curved bacillus which fermented cellulose with the production of methane and carbon dioxide.

7. Fermentation of Urea.—By far the largest part of the waste nitrogen which leaves the body of an animal passes out in the form of urea or carbamide, $\text{CO}(\text{NH}_2)_2$, dissolved in urine. The latter on keeping a few hours, gradually becomes more and more alkaline and develops an ammoniacal odour, the urea in it being hydrolysed into ammonium carbonate according to the following reaction :—



As the carbonates of ammonia are volatile and readily suffer partial decomposition into carbon dioxide and ammonia, considerable loss of nitrogen takes place from a manure heap in which this fermentation is going on : the loss begins in the stable, and to prevent it either wholly or in part, the use of absorbent peat litter in the stalls or the addition of superphosphate of lime to the manure are useful.

The change of urea into ammonium carbonate is brought about by a number of distinct species of bacteria which are found abundantly distributed in soils, drainage and river water, manure heaps and sewage.

Some of the organisms are bacilli, others cocci or sarcinæ ; a small amount of free acid stops the development of all of them.

According to Miquel the hydrolysis of urea is not effected directly by the bacteria themselves, but by an enzyme, *urease*, which they secrete ; the enzyme has been obtained pure by

filtration and found to induce the formation of carbonate of ammonia from urea without the presence of bacteria.

The ammoniacal fermentation of urea is of great importance, for the latter substance, although it contains nitrogen, is of no use as a source of this element for the nutrition of green plants; the ammonium carbonate produced is, however, useful in itself in slight degree, and readily undergoes oxidation in the process of nitrification (p. 789) in the ground, becoming thereby transformed into nitrates, from which compounds green plants easily obtain all the nitrogen they need.

8. **Putrefaction.**—A considerable portion of the bodies of all living animals and plants consists of complex nitrogenous compounds, notably proteins. Unless special precautions are taken to preserve them by cooking, embalming, or other means, these bodies, after death, are attacked by various species of bacteria, and the proteins and other substances are thereby decomposed step by step into simpler compounds, several of which have a disgusting odour.

The term *putrefaction* is applied to these changes of nitrogenous organic compounds, which are accompanied with the evolution of foul-smelling products.

In a great many instances the first step in the decomposition of the proteins is the production of soluble albumoses and peptones from them by the action of enzymes secreted by the bacteria. Subsequently the peptones are split up into amido-compounds, such as leucine and tyrosine, and these are in turn broken down into still simpler bodies, the chief final products of putrefaction being free nitrogen and hydrogen, ammonia, carbon dioxide, sulphuretted hydrogen, methane, and other gases, which escape into the surrounding air and soil.

Not only do these changes take place in dead bodies of animals and plants, but also in all products derived from them and containing proteins, such as fæcal matter, milk, cheese, and all cooked flesh and tinned meats.

In addition to the compounds mentioned above as intermediate between proteins and the simple gaseous end-products of putrefaction, a great many other intermediate ones are met with, namely, butyric and lactic acids, various organic bases, as well as phenol, skatol, and indol, the two latter being the compounds to which the characteristic odour of fæces is due.

Certain basic nitrogenous bodies resembling the vegetable alkaloids, and known as *ptomaines*, are commonly produced in the decomposition of meat, fish, and other albuminous substances by bacteria. A number of the ptomaines which have been isolated are innocuous; others are, however, intensely poisonous, and are the cause of the fatal effects following the consumption of 'high' game, imperfectly sterilised tinned meats, stale fish, decomposing cheese, meat pies, sausages, and other putrefying foods.

The amount and kind of the compounds produced in the process of putrefaction depends upon the nature of the bacteria causing it, and especially upon the free or restricted access of oxygen to the substance undergoing change. Under anaërobic conditions the foul-smelling compounds accumulate, whereas when abundance of oxygen is present, and aërobic bacteria allowed full play, a rapid oxidation of the sulphuretted hydrogen, ammonia, and other offensive bodies takes place as soon as they are formed, so that a foetid odour is scarcely noticeable under these circumstances; this inodorous process of decomposition is generally spoken of as *decay*.

The commonest species of putrefactive bacteria are *Proteus vulgaris*, *P. mirabilis*, and *P. Zenkeri* of Hauser, all of which, with others, were formerly known under the collective name *Bacterium termo*: they are all very minute organisms, possessing extraordinary motile powers.

Another putrefactive species present in the alimentary canal of almost all the higher animals is *Bacterium coli commune*.

9. **Nitrification.**—It has long been known that when dung, urine, flesh of animals, tissues of plants, or any substance containing organic nitrogenous compounds are spread over and dug into the soil, the compounds become oxidised and the whole or a great portion of the nitrogen ultimately takes the form of a nitrate, chiefly nitrate of calcium or potassium. Compounds of ammonia are likewise oxidised to nitrates under similar circumstances.

This production of nitrates is termed *nitrification*, and was formerly considered a simple chemical process. It does not, however, take place in soil which has been sterilised, and is now ascertained to be the result of the vital activity of certain species of bacteria.

Apparently in every case of the nitrification of complex organic substances the formation of ammonium compounds by the uro-bacteria and putrefactive organisms always precedes the production of nitrates and it is upon the ammonium salts thus produced that the special nitrifying bacteria exercise their powers.

Moreover, the formation of nitrates takes place in two distinct stages, namely, first the partial oxidation of the ammonium compounds into *nitrites*, after which the nitrites are further oxidised into *nitrates*. No single bacterium appears to be alone capable of effecting both these changes, the two steps of the work being carried out by two different types of bacteria.

The special organism which completes the first part of the nitrification process in all European soils is *Nitrosomonas europæa* Win., a very minute motile bacterium. Slightly different species of the same genus carry out the work in Asiatic and African soils, while in South American and Australian soils the nitrite-forming organisms are cocci.

The second part of the process, namely, the formation of nitrates from nitrites, is brought about by pear-shaped non-motile bacteria included in the genus *Nitrobacter*: they are all ex-

cessively minute and rank as the smallest of all living organisms. None of them are capable of attacking ammonia or its salts.

The rate of production of nitrites and the conversion of the latter into nitrates in the soil appear to be equal, for free nitrites cannot be detected in soils in which nitrification is going on.

Both types of nitrifying bacteria are present in manure heaps, in sewage, river-water, and in all soils, especially near the surface. In order that their work may proceed rapidly, an adequate supply of oxygen and water are necessary as well as a suitable temperature and the presence of alkaline salts, preferably the carbonates of calcium, magnesium or potassium : darkness is also essential to nitrification.

In excessively dry soils or those which are insufficiently drained, and therefore imperfectly supplied with air, the process is stopped : in winter, and whenever the temperature falls below 5° or 6° C., the organisms cease to work.

The presence of very small amounts of easily oxidisable organic compounds is detrimental to the growth and activity of both types of nitrifying organisms, the nitrite-forming bacteria being more sensitive in this respect than the nitrate-forming species. On this account the nitrification process does not begin until all the organic material has been fermented by other species of bacteria.

The nitrate-forming bacteria are excessively sensitive to ammonia, five parts of the latter in one million of the nutrient medium being sufficient to check their growth and work.

With the exception of nitrate of soda, practically all nitrogenous manures, such as sulphate of ammonia, dung, rape-dust, wool and fur-waste, bone-meal, fish-meal, and guano, must first be nitrified before they can be of service to crops. It is the business of the farmer to promote the change by judicious addition of lime where this substance is deficient in the soil, and

also by good tillage and drainage so as to provide a suitable and thorough supply of air.

The nitrifying bacteria are remarkable in being organisms which can build up the protoplasm and other constituents of their bodies entirely from inorganic compounds even in the dark.

The carbon essential for their nutrition is derived from the carbon dioxide of the air or from bicarbonates, not from neutral carbonates, for the organisms refuse to develop in solutions containing the latter compounds unless free carbon dioxide is present also. Instead of utilising the energy of the sun's rays to enable them to dissociate the carbon dioxide, as is the case with green plants, they obtain the energy necessary for the work from the oxidation of ammonium compounds and nitrites.

It is thus seen that the nitrification process which is of such beneficial importance to the human race is not mere gratuitous philanthropy on the part of the bacteria, but is carried on by the latter for the maintenance of their own existence.

Ex. 328.—Make up a solution as follows:—

Water,	1 Litre.
Ammonium Chloride,	·08 Gram.
Potassium Phosphate,	·04 „
Magnesium Sulphate,	·02 „
Calcium Carbonate,	·05 „
Sodium Potassium Tartrate,	·08 „

Place 100 c.c. of the solution in small glass flasks and add about ·1 gram of ordinary arable soil to each. After plugging the mouth of each flask with cotton-wool place them in a dark cupboard in a warm room.

Withdraw 5 c.c. from each flask every three or four days and test half of each 5 c.c. :—(1) for ammonia with Nessler's solution; (2) for nitrites or nitrates, by adding first a drop of diphenylamine sulphate in sulphuric acid and then two or three c.c. of strong sulphuric acid: the development of a violet-blue colour shows the presence of nitrites or nitrates.

10. **Denitrification.**—A large number of different species of bacteria have been isolated from the soil, air, well-water, dung, and other sources, which are capable of destroying nitrates by a process of reduction. In some instances the reduction, or *denitrification* as it is termed, results in the formation of nitrites which remain in the medium in which the process is going on: in others, the gases, nitric and nitrous oxides, or even free nitrogen, are produced, in all of which cases there is a loss of nitrogen into the surrounding air.

The particular amount and character of the denitrification depends upon the species of bacteria involved in the process, and also upon the presence of easily oxidisable organic matter: without the latter the reduction cannot proceed.

Many of these bacteria only carry on their work under anaërobic conditions, hence denitrification is often energetic in water-logged soils from which air is excluded: some species are, however, able to reduce nitrates even in the presence of oxygen.

After nitrification has taken place in the soil of ordinary arable land, there is no fear of loss of nitrogen through denitrification, for the nitrates are not produced in the former process until the organic material has been oxidised and the conditions for denitrification have passed away.

Several observers have noticed that the addition of very large amounts of fresh dung to soils already containing nitrate of soda has diminished the yield of produce below that obtained from similar soil to which dung has not been applied. The decrease in the crop is doubtless due to the denitrification of the nitrate, and the consequent loss of nutrient nitrogen. Some authorities assume that the peculiar action of the dung in such cases is mainly due to its containing very large numbers of the denitrifying organisms, others maintain that the deleterious effect of the dung is owing to the oxidisable organic matter derived from the straw and undigested vegetable tissue

within it. The latter view appears to be more in harmony with the known experimental evidence.

Well-rotted dung applied to soils containing nitrate has little denitrifying effect, and this result we should expect, for the oxidisable compounds in such dung have already been changed in the early fermentation processes which it has undergone. These peculiarities of dung are worthy of thought and consideration although the amounts of farmyard manure applied in ordinary practice is too small to have any serious denitrifying effect, even if used quite fresh: possibly in horticultural practice if one hundred tons or more per acre were employed it might be advisable to apply it in a well-rotted condition. There is, however, such a loss of nitrogen by the fermentation processes previously mentioned from mixed urine and dung when kept, that it is undoubtedly best from an economical point of view to feed animals on the land wherever practicable.

II. Fixation of Free Nitrogen.—(i) By *Clostridium Pasteurianum* Win. It has frequently been determined that the total amount of combined nitrogen in bare uncropped soils increases to a slight extent, even under conditions which preclude the possibility of the addition of ammoniacal or other nitrogenous compounds from the air. The result has been found to be due to the growth and multiplication within the soil of minute living organisms which possess the power of absorbing the free nitrogen of the air and building it up into complex organic nitrogenous compounds. At first the lower forms of algæ were supposed to be capable of thus 'fixing' and utilising free nitrogen, but it has been demonstrated that these organisms are incapable of doing so. A bacterium possessing this remarkable power has, however, been isolated from the soil and is known as *Clostridium Pasteurianum* Win. It occurs in the form of rods which become spindle-shaped or swollen in the middle when spore-formation takes place, and is strictly anaërobic. In the soil the removal of oxygen for the pro-

duction of anaërobic conditions is effected by aërobic species of bacteria. When grown in solutions containing sugar it produces butyric and other acids, and in the ground apparently derives the carbon necessary for its nutrition from some carbohydrate.

(ii) *By species of Azotobacter.*—From the soil a number of organisms have been isolated more recently, which are capable of assimilating or 'fixing' the free nitrogen of the air in appreciable amounts.

The first representatives of the group were obtained by Beijerinck in 1901 from soil and canal water. These he included in the genus *Azotobacter*, naming the two species which he examined in detail, *Azotobacter chroococcum* and *A. agilis* respectively.

Since the date mentioned other closely allied organisms with similar powers have been found in the soil in all parts of the world.

The Azotobacteria vary considerably in size and shape according to the stage of their growth and development, but are usually met with as short, thick, oval rods. In young cultures they are motile, and are strongly aërobic, needing an unrestricted supply of fresh air for vigorous growth and the exercise of their nitrogen-fixing functions.

They are present in the upper layers of all soils except those of a sour nature, and are also abundant in river and well water.

A good supply of phosphates, lime, and potash, as well as an adequate amount of easily oxidisable organic and carbon compounds, are essential for nitrogen fixation by Azotobacteria, and they thrive best where nitrogen compounds are absent or present in small amounts only.

The energy needed to bring the free nitrogen into chemical combination is derived from the combustion of organic-carbon compounds of the soil: the process is most efficiently carried on at temperatures between 25° and 30° C.

These organisms are able to add considerable amounts of

nitrogen in the form of protein of their bodies to the soil, and after death the complex nitrogen compounds are broken down in the nitrification process, being finally rendered available for the nutrition of crops which may be grown upon the soil. Such indirect transference of free atmospheric nitrogen to crops which are themselves unable to make direct use of it is of the greatest importance to plant cultivation, and it may be expected that in the comparatively near future greater practical use will be made of these nitrogen-fixing bacteria.

(iii) *By other organisms: Alinit.*—A bacterium said to have the power of fixing the free nitrogen of the air has been isolated from the soil by Herr Caron of Ellenbach.

The organism, assumed to be a new species, was named *Bacillus Ellenbachensis* α , and pure cultures mixed with some indifferent material were put on the market and sold under the name *alinit*.

The inventor asserted that by using these organisms he was enabled to obtain a considerable increase of yield of the common cereal crops, an increase comparable to that produced by a dressing of a nitrogenous manure.

For use the alinit is first mixed with a considerable amount of water, and the seed grain is then soaked in it. It is suggested that the organisms multiply in the soil when sown with the grain, and by their activity free nitrogen of the air is fixed and ultimately handed on to the growing cereal crop. The organisms thus appear to behave towards cereals much as the nodule-organisms behave towards leguminous plants, in both cases free nitrogen of the air being fixed and handed on to the crops in an assimilable form.

Stoklasa, who has investigated the nature and properties of the bacterium present in alinit, considers that the organism is identical with *Bacillus megatherium* De Bary. He maintains that it is able to assimilate free nitrogen when living in soil containing little or no combined nitrogen if a suitable supply

of pentosans or allied carbohydrates are present. Besides possessing the power of utilising the free nitrogen of the air in the manner indicated, this worker is of the opinion that the good effect of the use of the organism is partially due to its power of rendering soluble, and available to a cereal crop, some of the insoluble nitrogenous compounds present in the humus and similar decaying vegetable tissues present in the soil.

Many experiments have been carried out with a view of testing the practical utility of alinit in the cultivation of cereal crops. The evidence in favour of its usefulness is very conflicting: some authorities state that it is of no practical value

in any circumstances, while others, holding that it gives no good results upon poor sandy soils, consider that it is advantageous when employed for the growth of cereal crops upon soil rich in humus.

(iv) *By leguminous plants living in symbiosis with Pseudomonas radiculicola* Beijk.

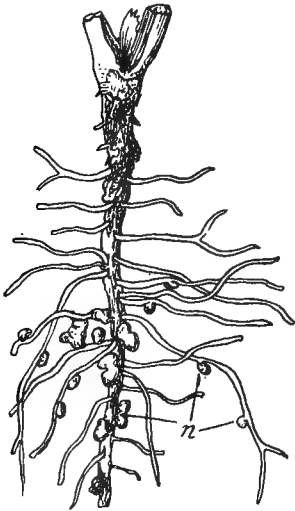

FIG. 264.—Root of Broad Bean (*Vicia Faba* L.) with nodules, *n*. (The figure was drawn from a self-sown specimen, dug up in a garden in November.)

If a well-developed bean plant is carefully dug up from the field or garden and the soil washed away, a number of irregularly oval or globular excrescences will be noticed upon its roots (Fig. 264). The structures are termed *nodules* or *tubercles*. Each is pinkish in colour, and in the early stages of growth of the bean plant are solid and plump; later they shrivel, and finally, when the bean has ripened

its seed, they decay or become brittle and break up into fragments, which are left in the ground with the remains of the bean's roots.

A transverse section of a nodule (*A*, Fig. 265) shows a thin layer of cortical tissue, a ring of small vascular bundles, and a large more or less central mass of parenchymatous tissue, each cell of which contains numbers of bacteria belonging to an aërobic species now known as *Pseudomonas radiciicola* Beijk. (= *Rhizobium leguminosarum* Frank).

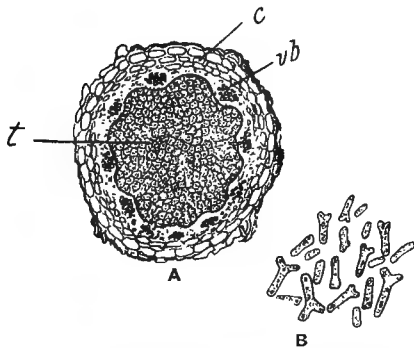

FIG. 265.—*A*, Transverse section of a nodule from the bean root, depicted in the previous Fig. 264; *c* cortical parenchyma; *vb* small vascular bundle; *t* bacteroidal tissue (enlarged about 15 diameters). *B*, Isolated bacteroids from cell of tissue *t* (enlarged 680 diameters).

The bacteria, which must not be confused with nitrifying and other organisms, are present in almost all soils, and are especially abundant in those which have previously borne crops of leguminous plants. From the soil they make their way through the epidermis into the cortex of the roots of leguminous plants, and there induce the formation of exuberant parenchyma, the cells

of which they soon fill by their rapid vegetative reproduction.

At first the bacteria are very minute short rods, but after living for a time in the roots of the infected plants, they increase in size and undergo a species of degeneration, most of them becoming somewhat Y-shaped (*B*, Fig. 265), or otherwise changed in form; these degenerate- or involution-forms are usually spoken of as *bacteroids*.

Not only do the roots of the bean possess nodules inhabited by these organisms, but the roots of all species of leguminous plants belonging to the sub-order Papilionaceæ have them.

The bacteria from the roots of clover, peas, vetches, sainfoin, and many other species of Leguminosæ have been separately

isolated and cultivated on artificial media ; probably only one species exists, but slight variations in form are noticeable, and it is found that considerable differences exist among them in regard to their power of producing nodules. The most luxuriant and rapid production of nodules on any particular plant is always best obtained when the bacteria employed for inoculation of its roots have been derived from nodules on the same species of plant ; nevertheless, in some instances the organisms from one species of plant are able to give rise to abundant nodule growth on other nearly-related species, although they are usually without effect on plants widely distinct. For example, the nodule-bacteria derived from peas produce the best nodule growth on pea plants ; they are, however, able to induce the formation of these excrescences on most species of *Vicia* (vetches) and *Phaseolus* (runner and dwarf beans), but are without effect when applied to the roots of clovers, kidney-vetch, or lupins.

Many details in regard to the work of these organisms are still obscure ; nevertheless their significance in the nutrition of leguminous plants is clear, for it may readily be shown that without their aid the latter, like all other green plants, must have the nitrogen necessary for growth supplied in a combined form (as nitrates chiefly), whereas when associated with the nodule-bacteria leguminous plants are, in some direct or indirect manner, able to make use of the free nitrogen of the air.

Leguminous seedlings, raised in sterilised sand to which has been supplied all necessary food-constituents except nitrogen in a combined form, soon cease to grow and die of nitrogen-hunger exactly as all other non-leguminous green plants : they are unable to make use of the store of free nitrogen in the air surrounding them, and such plants never possess nodules nor do they increase in nitrogen content beyond that contained in the seed. However, if to the sterilised sand is added a turbid watery extract of soil, on which similar leguminous plants have

been grown and which contains the nodule-bacteria, the plants do not die, but grow luxuriantly and increase in nitrogen-content to a very great degree. At the same time an extensive development of nodules is observable on their roots.

By growing nodule-bearing plants in closed vessels and analysing the composition of the enclosed air both before and after growth Schloesing and Laurent showed that the amount of free nitrogen which disappeared from the air corresponded with the amount gained by the plants.

Although there is no doubt about the fact that without the nodule-bacteria leguminous plants cannot utilise free nitrogen, the manner in which the combination of plant plus bacteria effects the nitrogen-fixation is still a matter of some uncertainty.

Mazé and Golding have shown that the nodule-bacteria in pure cultures apart from leguminous plants, are able to fix and utilise free nitrogen of the atmosphere to a certain extent, and it is most probable that leguminous plants growing in association with the nodule-bacteria obtain their abundance of nitrogen not from the air direct, but as it were second-hand from the bacteria.

No increase of nitrogen is observable actually in the soil on which the plants are growing, and there appears to be no evidence for the supposition that the nitrogen is first fixed in the soil and subsequently taken up by the roots of the leguminous plant.

The explanation which appears to agree most with known facts is that the nitrogen is fixed by the nodule-bacteria in the tissues of the nodule, and that the nitrogenous compounds produced are subsequently absorbed and utilised by the leguminous plant.

The amount of combined nitrogen present in the nodules is found to increase gradually from the time they first appear up to the time when they are plump and their hypertrophied tissue completely filled with bacteroids.

In the annual Leguminosæ, such as peas and lupins, the greatest development of bacteroids is usually met with about the time when the plants reach the flowering stage. From this point onwards analysis shows that the nitrogen-content of the nodule decreases rapidly and the bacteroids diminish in numbers ; most of the latter become dissolved and their component nitrogenous compounds leave the nodule by way of the small vascular strands (*vb*, Fig. 265) which are organically connected with the main vascular strands of the root on which the nodule is produced.

At the time when the seeds of the leguminous plants are ripe the bacteroidal tissue of the nodules is empty and shrivelled.

Although by far the larger number of bacteria produced in the nodules undergo degeneration and absorption, a few remain unaltered and are set free in the soil when the roots and nodules become disorganised. To these residual organisms is attributed the infection of leguminous crops subsequently grown on such soil.

When one organism lives upon another and both render each other mutual service, the relationship is spoken of as *symbiotic*.

The combined life of nodule bacteria and leguminous plant is a case of *symbiosis*, for the carbon and some of the other elements which the bacteria need for their development are supplied in the form of sugar and other compounds by the green plant, and in return for these the latter obtains a supply of nitrogen from the bacteria.

The practical utilisation of the powers of these nodule-bacteria is a matter of considerable importance to the farmer. A profitable leguminous crop can be obtained on soils devoid of nitrogen provided that the requisite mineral constituents of plant food-materials and the suitable nodule-bacteria are present ; moreover, soils after yielding such a crop are found to be largely enriched by the combined nitrogen contained in the roots left after the produce is removed, and this nitrogen is readily yielded to subsequent crops such as the cereals which specially

need this element, but which are incapable of utilising it in the free state in which it exists in the atmosphere.

On poor, sandy, and gravelly soils, good crops of lupins, serradella, and other leguminous plants may be grown with kainit and phosphatic manures alone, and such soils are at the same time so much enriched with nitrogen that they are capable of yielding remunerative crops of cereals, potatoes, and other non-leguminous plants.

The amount of nitrogen-fixation which takes place when nodule-bearing Leguminosæ are grown on soils rich in nitrates or other forms of combined nitrogen is not clearly known: the nodules are generally smaller in size under such circumstances, and although in many cases their number is larger on plants grown in rich soil than on those produced on poor ground it is by no means certain that a large number of nodules is necessarily associated with great nitrogen-fixation under these conditions.

Perhaps the greatest use can be made of these nitrogen-accumulating leguminous plants upon ground exhausted of nitrogen and poor light soils generally, but what plants to grow, how long to leave them down, whether they should be wholly or partially ploughed in, or utilised for feeding purposes, and many other points must be left to the future for decision. However, seeing that the cost of nitrogen in a combined state suitable for the nutrition of all our non-leguminous crops is very considerable—generally not less than 4d. to 6d. per lb.—it is essential that the farmer should consider the means here at his disposal of obtaining it for nothing.

There is little doubt that in the ordinary cropping practices we do not at present take all the advantage we might of this source of nitrogen, yet much investigation and experiment are needed before the economic aspects of the question can be fully understood.

On land which has not previously carried any kind of legu-

minous crop it has been found beneficial before attempting to grow a particular species of the Leguminosæ, to provide that the proper race of nodule-organisms for infection of its roots shall be present in the ground before the seed is sown. This may be effected by spreading over and gently working into the ground soil which has been obtained from a field which has recently carried a good crop of the plant to be grown.

Under the names '*Nitragin*' and '*Nitrobacterine*' are sold pure cultures on nutrient gelatine of the various races of nodule-bacteria which are intended to be used for mixing with the seeds of the different leguminous plants before sowing, especially when crops are to be raised on poor virgin soils or on those which have not borne a similar leguminous crop for a great number of years. Instead of applying the cultures to the seed, they may be mixed with a small amount of soil and then subsequently spread over the land.

Very extensive trials have been made of the effect of '*nitragin*' and '*nitrobacterine*' inoculation, but in only a small proportion of them have the results of its use been distinctly favourable in producing a well-marked increase of crop over non-inoculated sowings.

Where no difference has been observable between the inoculated and non-inoculated plots on the same soil, it is generally found that the roots of the plants on the untreated ground are well supplied with nodules; apparently the nodule-organisms have been already present in sufficient number in the soil, and the further addition of more by the use of pure cultures has been superfluous.

On virgin ground an application of soil from a field which has previously borne a leguminous crop rarely fails to produce a good effect, but the use of these artificial cultures in such cases has not been attended with like success.

More investigation is required in regard to the vitality, conditions of growth on different media, time and method of

application to the seed and soil, and the influence of dryness and sunlight upon them, before the organisms of 'nitragin' cultures can be successfully utilised in farm practice.

Ex. 329.—Carefully dig up various leguminous plants just before flowering and examine the colour, form, and number of the nodules on the roots of each.

Ex. 330.—Examine the nodules on the roots of the bean, pea, or vetch at different short intervals from the time they first appear on the seedling to the time when the plant bears perfectly ripe seeds. Note the difference in size and the external and internal colour of the nodules at each stage.

Ex. 331.—Cut transverse sections of plump nodules of the bean and note the position of the various tissues with a low power (*cf.* *A*, Fig. 265).

Ex. 332.—Cut across a well-developed nodule of a bean and scrape off a minute portion of the exposed bacteroidal tissue with the point of a knife; place the scraped portion in a very small drop of water on a glass slide and stir it about, so that the bacteroids are distributed in the water; put on a cover-slip and examine with a one-eighth objective.

Ex. 333.—Make three sand-cultures of peas, adding all necessary plant food-constituents except nitrogen; water one of them (*A*) always with distilled water; another (*B*), first with a thoroughly boiled extract of garden soil on which peas have been grown, and subsequently with distilled water; and the third (*C*), first with a similar extract of garden soil which has not been boiled, and afterwards with distilled water.

Watch and make notes on the growth of each, and when six or seven weeks' old, take out the roots of all the plants from the sand and observe which bear nodules.

Ex. 334.—Make water-cultures of peas or beans, similar to the (*A*) and (*C*) sand-cultures of Ex. 333. Instead of adding extract of soil to (*C*), bruise a number of well-developed pea or bean nodules, and add them to the water in the experimental jar when several lateral roots of the plants are half an inch or more long; also place some of the bruised nodules in contact with the young roots.

Watch and make notes on the subsequent growth of the plants, and the presence or absence of nodules on each.

12. Bacteria and diseases of animals.—The bacteria previously discussed have been those which live a saprophytic life, deriving their food from dead organic matter, and at the same time bringing about extensive chemical changes in it. A number of species, however, gain an entrance into the bodies of animals where they feed upon the substances of the tissues, and

give rise to characteristic diseases : such bacteria are spoken of as *pathogenic*.

Before a particular organism can be considered as the cause of a specific disease, it must be found in the blood, lymph, or tissues of all animals suffering from the disease in question ; moreover, the organism must be isolated and cultivated outside the animal body, and the introduction of such pure cultures into healthy animals must give rise to the same disease.

The manner in which bacteria cause disease is not in every case quite clear. It is, however, known that in some cases the bacteria, during their growth in the body of the animal attacked, produce certain substances which act as poisons, and it is to the direct action of the latter that the diseases are due.

These poisons are generally designated *toxins* ; some of them are elaborated by the bacteria when the latter are cultivated in artificial media outside the body, and may be obtained from the culture by filtration and other means. It is found that such toxins, quite free from bacteria, when injected into the system of an animal immediately produce the symptoms of the disease.

In a text-book of the present capacity we cannot do more than merely mention two diseases due to the attack of parasitic bacteria, namely, anthrax and tuberculosis, both of which are prevalent among farm animals.

The organism, which causes anthrax or 'splenic fever' among sheep and cattle, is *Bacillus anthracis*. It is one of the best known bacteria, of comparatively large size, and easily detected in the blood of all parts of animals which have died from the disease.

Infection, or the introduction of the bacillus into the body of any susceptible animal such as a horse, cow, sheep, pig, or goat is usually followed by death in two or three days.

On the farm the bacillus is taken in by stock from water and grass which have been contaminated by blood and other discharges from diseased animals.

To prevent infection from them, the carcasses of animals dead from anthrax should be buried deeply in lime : no attempt should be made to flay or open such carcasses, and it is important to point out that great care and cleanliness is necessary in handling and in dealing with discharges from them, for the bacilli on gaining an entrance into the blood of man through wounds produce disease which is generally fatal in a few days. The handling of products such as dried skins, wool and horse hair, derived from animals which have died from anthrax, is a dangerous operation ; the spores of the bacilli are liable to be inhaled into the lungs, where they germinate and ultimately give rise to the form of anthrax commonly known as 'wool-sorter's disease.'

Tuberculosis in cattle, pigs and other farm animals, as well as in man is due to *Bacillus tuberculosis* Koch. The disease is commonly produced by inhalation of the bacilli or their spores from the air, and by feeding on materials contaminated with the organisms.

The milk from cows whose udders are tuberculous frequently contains the bacilli, and when consumed by children leads to lingering disease and death. Every effort should therefore be made to pasteurize or sterilize cow's milk before feeding it to infants, for the latter are especially susceptible to the attacks of this bacillus.

13. Diseases of plants caused by Bacteria.—During the last few years a number of ailments of plants have been attributed to the agency of bacteria, but in only a few cases has any satisfactory proof been forthcoming for the belief that bacteria alone are the direct cause of these diseases.

In many cases of plant-disease where the tissues are found to be undergoing decay and in which bacteria are present, the trouble is primarily due to other causes, such as insect attack, the attacks of parasitic fungi, or the action of frost, heat, and adverse soil conditions. The production of wounds and the death of the plant-tissues by these means allow of the entrance of bacteria

and provide the latter with dead organic material upon which they can live and carry on various processes of putrefaction and decay.

It must be noticed, however, that even in these complicated cases it is quite possible that the bacteria may be the *chief* cause of the destructive effects observable upon the plants, although their entrance can only be made after injuries previously inflicted by other agents.

There is little doubt that a considerable number of common ailments of plants are of this nature, but recently it has been convincingly shown by Erwin T. Smith, H. L. Russell and others that some species of bacteria can effect an entrance into the tissues of plants through normal channels, and are able directly to set up disease in the infected plant.

14. '**Black Rot**' of Cabbages.—One of the best examples of bacterial plant diseases is that known as the 'Brown Rot' or 'Black Rot' of the cabbage. The disease is not uncommon in this country and is sometimes met with upon turnips, swedes, kale, cauliflower and other cruciferous plants.

In the first stages of the disease the affected cabbages show pale yellowish-green patches near the edges of the leaves or around holes or places torn or eaten by insects. The patches turn brown afterwards, and on holding the leaf up to the light the veins in the diseased parts are a dark brown colour. The leaf wilts and shrinks, becoming tough somewhat like parchment.

Plants badly affected become stunted, lose their leaves, and may die altogether. In such cases the dark colour of the vascular tissues of the leaves is continued from the leaf into the stem, and on cutting across the latter the wood of the vascular cylinder is stained a brown or blackish tint.

Infected cabbages form no heads or only very small ones, and the roots of turnips develop very poorly.

The disease is caused by a bacterium named *Pseudomonas campestris* Pammel. It is a yellow, rod-shaped, motile organism

with a single cilium. The bacterium frequently enters through the water-pores which are present on the teeth at the edges of the leaves, and most easily gain admittance in damp, warm weather when drops of water are excreted by these pores and stand like dew-drops along the leaf-margins.

Slugs and the larvæ of insects carry them from the soil, and from one infected plant to another, the bacteria eventually entering into the vascular tissues exposed at the parts gnawed and bitten by these pests.

The bacteria live and multiply in the alkaline solutions present in the vessels or tracheæ of the vascular bundles, and do not invade the parenchymatous tissue of the leaf. The vessels become blocked with a brown substance which prevents the proper conduction of water, hence the withering of the diseased leaves.

It is advisable to remove and burn diseased plants as soon as these are noticed, and on ground where the trouble has been prevalent cruciferous plants should not be grown for some time.

An organism named *Pseudomonas destructans* has been described recently by Potter, and to it is ascribed a 'white rot' of turnips. The leaves of the infected plants turn yellow and droop, and the interior of the 'root' in 2 or 3 weeks becomes pulpy and rotten.

The bacterium softens the cell-walls and secretes an enzyme which dissolves the middle lamella of the cells of the turnip 'root.' The protoplasm separates from the cell-walls and turns brown, possibly as the result of the toxic action of oxalic acid which is produced by the bacterium.

The organism appears to gain an entrance into the tissues of the turnip through wounds.

15. Another disease directly caused by a bacillus is prevalent among melons and cucumbers and other species of Cucurbitaceæ. The leaves of affected plants droop and change from a bright to a dull green colour.

When the stems are cut across, a white milky slime, which can be drawn into long threads, exudes from the exposed ends of the vascular bundles.

The specific bacterium which causes the disease is *Bacillus tracheiphilus* E. F. Smith. It is a short bacillus often met with in pairs. The organism obtains an entrance into the leaves and works its way into the stem along the vessels of the wood of the vascular bundles.

It may finally permeate the other tissues of the stem, and cause a shrivelling of this part of the plant.

16. A further example of a plant disease of bacterial origin is the 'Brown rot' of the potato and tomato caused by *Bacillus solanacearum* E. F. Smith. At first the leaves of affected plants droop: subsequently the stems become brown and the tubers may eventually be damaged. In this case also the stems show discoloured vascular bundles, and a yellowish white liquid containing myriads of bacteria oozes out of the ends of the bundles when the stems are cut across.

INDEX

ABIES, 134.
 Absorption of carbon dioxide, 209.
 — of food materials, 33, 202.
 — of oxygen, 234.
 — of water, 33, 182.
 Abundance oat, 497.
Acer, 62, 136.
 Acetic fermentations, 784.
 Achene, 97.
Achillea, 473.
 Achlamydoeus, 83.
 Acids, organic, 164.
Aconitum, 326.
 Acorn, 73, 96.
 Acropetal succession, 26, 36.
 Actinomorphic, 80.
 Acuminate, 71.
 Acute, 71.
 Acyclic flower, 80.
 Adipocelluloses, 161.
 Adventitious buds, 51.
 — roots, 28 (Figs. 10, 21), 53.
 Aecidium, 731, 732 (Fig. 248).
 Aecidiospore, 731 (Fig. 248).
 Aerobic, 775.
 — respiration, 233.
Aesculus, 62.
Aethusa, 455.
Agaricus, 740 (Figs. 251, 252).
 Age of seeds, 11.
 — fruit-spurs, 50.
 Agrimony, 102, 408.
Agropyrum, 551, 553.
Agrostemma, 592.
Agrostis, 533, 552, 667.
Aira, 537.
 Alæ, 410.
Albugo, 714.
 Albuminoids, 165.
 Albuminous seeds, 18 (Fig. 101).
 Albumum, 127.
Alchemilla, 189.
 Alder, 64.
 Aleuron-grains, 166 (Fig. 81).
 Aleuron-layer, 166 (Fig. 81), 229, 306.
 Alfalfa, 429, 645.

Alinit, 795.
 Alkaloids, 167.
 Allelomorphs, 294.
 All-good, 351.
Allium, 328.
 Almond, 99, 490.
Alnus, 64.
Alopecurus, 531, 552, 664.
 Alsike Clover, 425, 651 (Figs. 128, 200).
Alternaria, 706 (Fig. 236).
 Alternate, 75.
 Altringham carrot, 449.
 Aluminium, 168.
Amaryllidaceæ, 163, 329.
 Amides, 167, 217, 219, 231.
 Amido-compounds, 219, 224.
 Ammoniacal fermentation, 786, 787.
Ammophila, 533, 552.
 Amylose, 158.
 Amygdalin, 230, 398.
Amygdalus, 400.
 Anabolism, 217.
 Anaërobic, 775.
 — respiration, 238.
 Anatomy, 104.
 Anatropous ovule, 272 (Fig. 98).
 Anbury, 763 (Fig. 258).
 Androecium, 79, 84.
Anemone, 82, 326.
 Anemophilous, 281.
 Angiosperms, 324, 325.
 Angular interval, 75.
 Animals, 1.
 Animated Oat, 494.
 Annuals, 4, 223, 577.
 Annual rings, 123.
 Annular thickening, 110 (Fig. 51).
 Annulus, 743.
Anthemis, 594.
 Anther, 84 (Fig. 36).
 Antheridium, 695.
 Anther-lobe, 84 (Fig. 36).
Anthoxanthum, 530, 552, 663.
 Anthrax, 804.
Anthyllis, 434, 440.
 Antipodal cells, 273 (Fig. 99).

- Antirrhinum*, 327.
 Antiseptics, 778.
 Apex of leaf, 71.
 Apheliotropic, 253.
Apium, 444.
 Apocarpous, 86.
 Apogotropic, 255.
 Apple, 30, 39 (Fig. 19), 40, 66, 82, 95, 96, 100, 103, 128, 155, 161, 260, 262, 263, 268, 378, 280, 306, 310, 405.
 Apricot, 49, 66, 99, 399.
 April wheat, 527.
Aquilegia, 326.
Arctium, 102.
Arnica, 470.
Arrhenatherum, 536, 552, 669.
 Arthrospores, 773.
 Artichoke, 56, 163, 223, 229, 470.
 Artificial pollination, 299.
Arum, 74, 90.
 Arum-lily, 189.
 Ascent of water, 198, 199.
 Ascocarp, 745, 751.
 Ascomycetes, 688, 745.
 Ascospore, 745, 751 (Figs. 225, 257).
 Ascus, 681, 745, 751 (Figs. 225, 257).
 Ash, 18, 44, 61, 71, 81, 83, 192, 124, 128, 135 (Figs. 57, 65), 305.
 Ash of Plants, 153, 204.
 Asparagine, 168, 218, 219, 224, 231.
 Asparagus, 167, 176 (Figs. 69), 739.
 Aspen, 66.
 Assimilation, 208, 210, 234.
Aster, 470.
 Atavism, 317.
Atriplex, 176, 351.
Atropa, 468.
 Atropine, 468.
 Autobasidiomycetes, 726, 740.
 Autococious, 726.
 Autumn-wood, 124 (Fig. 64).
Avena, 493, 539, 552, 668.
 Avens, 408.
 Awn, 479.
 Awnless Brome-grass, 545.
 Axil, 38.
 Axile, placentation, 87 (Fig. 38).
 Axillary buds, 38.
 Axis, primary, 10, 40.
 — secondary, 40.
 Azalea, 225.
Azotobacter, 794.
 BACILLUS, 769 (Fig. 260).
 — anthracis, 804.
 Bacteria, 324, 769, 803.
 Bacteria, conditions of development, 774.
 — forms of, 769 (Fig. 260).
 — reproduction of, 770, 771 (Fig. 262).
 — work of, 779.
 Bacterial Diseases of Animals, 803.
 — Plants, 805.
 Bacterium, 769.
 Bacteroids, 797 (Fig. 265).
 Balsams, 101, 189.
 Banana, 278.
 Barberry, 65, 74, 731.
 Bark, 129.
 Barley (Figs. 10, 70, 71, 159-163, 192, 193), 276, 279, 317, 500-511.
 Basidiomycetes, 688, 715.
 Basidiospore, 715, 726, 743 (Fig. 252).
 Basidium, 726, 743 (Fig. 252).
 Bast (Figs. 54, 55), 117, 119.
 Bast-parenchyma, 120.
 Bast-vessel, 119-120.
 Bates' Hop, 343.
 Battledore barley, 504 (Fig. 161).
 Bay-leaved willow, 65.
 Bean, common, 7 (Figs. 1-4, 9, 11, 74), 18, 72, 276, 280, 303, 309, 416.
 — dwarf, 284.
 — rust of, 739.
 — varieties of, 416-7.
 Bearbine, 597, 601.
 Bearded wheats, 527 (Fig. 170).
 Bedstraw, 606.
 Beech, 63, 96, 128, 136 (Fig. 68), 212, 225, 226.
 Beet, 108, 176, 212, 311, 351.
 — rust of, 740.
 Begonia, 51, 259, 287.
 Belgian carrots, 449.
Bellis, 322, 607.
 Bent-eared barley, 506 (Fig. 161).
 Bent-grasses, 534, 535.
 Benzaldehyde, 231, 399.
Berberis, 65, 731.
 Bere, 501 (Fig. 160).
 Berry, 99 (Fig. 46).
Beta, 350, 351.
 Betaine, 167.
Betula, 63.
 Biennials, 4, 223, 578.
 Bigarreau cherry, 49, 67, 264, 400.
 Bigeneric hybrids, 287.
 Bigg, 501.
 Bindweed, 53, 326, 573, 597, 601.
 Biological varieties, 733.
 Biology, 1.
 Birch, 63, 187.

- Bird-cherry, 67, 400.
 Bird's-foot trefoil, 100, 435, 655.
 Bird's-nest, 606.
 Bird's-nest orchis, 170, 208, 225.
 Bisexual, 87.
 Bitter-cress, 101, 605.
 Bitter-sweet, 468.
 Black Alder, 64, 737.
 Black Bent, 665.
 Blackberry, 53, 65, 287, 403.
 Black-bindweed, 326, 573, 601.
 Black currant (Figs. 19, 56, 59), 49, 64.
 — grass, 532.
 — medick, 429.
 — ——— seed of 646.
 — mustard, 381, 386 (Fig. 123).
 — ——— seed of 641.
 — nightshade, 468.
 — poplar, 66.
 — rot of cabbage, 806.
 — thorn, 66, 399.
 Blade of leaf, 68, 69.
 Bleeding of plants, 186.
 Bloom on plants, 114.
 Blue Lupin, 437, 439.
 Bokhara Clover, 432, 646.
 Boraginaceæ, 327.
 Borage, 327.
Borago, 327.
 Bordeaux mixture, 703.
 Bordered pits, 110 (Fig. 50).
 Borecole, 367.
 Botany, 1.
 Bottom-grasses, 557.
 Box, 295.
Brachypodium, 546 (Fig. 256).
 Bract, 73, 89.
 Bracteole, 73, 89.
 Bramling hop, 341.
 Branching of Roots, 26.
 — of stems, 40.
Brassica, 366, 386.
Bremia, 713.
 Bristle-pointed oat, 494, 539.
 Broad clover, 424.
 Broccoli, 368.
 Brome-grasses, 545, 555, 602 (Figs. 184, 221).
 Bromine, 168.
Bromus, 545, 552.
 Broom, 284.
 Broom-rape, 171, 208, 599, 630.
 Browick wheat, 527.
 Brown mustard, 381.
 — rot of cabbage, 806, 808.
 — rust, 736.
 Brown mustard, seed of, 641.
Brunella, 327.
 Brussels sprouts, 367.
 Bryophytes, 324.
 Buckthorn, 54, 61, 737.
 Buckwheat, 326, 659.
 Budding, 259, 262 (Figs. 93, 94).
 Budding of fungi, 683, 746 (Fig. 253).
 Buds, 34, 37 (Figs. 12, 13).
 — adventitious, 51.
 — arrangement, 76.
 — dormant, 50.
 — kinds of, 39, 50, 51.
 Bud-scales, 37 (Figs. 12, 13, 14).
 Bud-scale scars, 37, 73 (Figs. 16, 19).
 Bud-varieties, 304, 305.
 Bulb, 57 (Figs. 24, 25).
 — imbricated, 60.
 — tunicated, 60.
 Bulbous crowfoot, 605.
 Bullace, 67, 399.
 Bulrush, 328.
 Bundles vascular, 113 (Figs. 53-55, 70-71).
 — closed, 137.
 — collateral, 117.
 — common, 117.
 — open, 117.
 — structure of, 117-120, 137, 141, 142.
 Bundle-sheath (endodermis), 116, 141, 145.
 Bunt, 723 (Fig. 244).
 Burdock, 102.
 Burnet, 408, 656 (Fig. 206).
 Bushel-weight of seeds, 632, 635.
 Buss' Hop, 344.
 Butter-bur, 607.
 Buttercup (Fig. 34), 81, 83, 86, 87, 97, 282, 322, 326.
 Butyric fermentations, 782.
 CABBAGE, 98, 114, 176, 185, 212, 309, 366-368, 386 (Fig. 121).
 — seed of, 639.
 Caducous, 83.
 Caesalpiniæ, 410.
Calceolaria, 280.
 Calcium, 175.
 Calcium oxalate (Fig. 80), 164, 174.
 Callus, 51, 132 (Fig. 61).
 Calyptragen, 150.
 Calyx, 78 (Figs. 34, 35), 83.
 Calyx-tube, 406 (Fig. 126).
 Cambium, 117 (Figs. 54, 55), 119.
 Cambium-ring, 120.
 Cammock, 605.

- Campanulacæ, 163.
 Campion, 326, 592 (Fig. 199), 649.
 Campylotropous ovule, 272.
 Candytuft, 91.
 Cane-sugar, 155, 220, 223, 229.
 Cannabacæ, 325, 332, 349.
Cannabis, 332.
 Canterbury Bell, 83.
 Canterbury Whitebine hop, 342.
 Capitulum, 91, 470 (Fig. 147).
Capsella, 592.
 Capsule, 98.
 Caraway, 444.
 Carbon, 171.
 Carbon dioxide, 208.
 — absorption of, 209.
 — evolution of, 233, 239.
 — fixation, 208, 210, 234.
 Carbohydrates, 155, 210, 211, 221.
Cardamine, 100.
Carex, 328, 612.
 Carices, 612.
 Carina, 410.
 Carnations, 268, 284, 305, 326.
 Carnation-grass, 613.
 Carotin, 212.
 Carpel, 79 (Fig. 34).
 Carpellary, 87.
Carpinus, 63, 136.
 Carpophore, 442.
 Carrot, 27, 69, 82, 92, 97, 102, 161,
 230, 280, 312, 443 (Figs. 135-137).
 — seed, 657.
 — varieties of, 449.
Carum, 444.
 Caryophyllacæ, 326, 592.
 Caryopsis, 97, 481.
Castanea, 62.
 Castor-oil, 231.
 Catabolism, 217.
 Catkin, 90.
 Cat's ear, 609.
 Cat's tail, 532, 666 (Figs. 173, 211).
 Cattle parsnip, 453.
 Cauliflower, 368.
 Celery, 69, 444.
 Cell, 105 (Figs. 48, 49).
 — division, 110 (Fig. 52).
 — nucleus, 107.
 — plasm, 107.
 — sap, 106, 108.
 — wall, 105, 106.
 Cellulose, 106, 159, 160,
 — fermentation of, 785.
Centaurea, 595, 608.
 Centaury, 93.
 Cereals, 287, 307, 314, 483-529.
 Chalaza, 271 (Figs. 98, 99, 101).
 Chamomile, 470, 594, 649 (Fig. 199).
 Charlock, 36, 81, 87, 385, 591 (Figs.
 117, 122, 123).
 — jointed, 386, 592, 656.
 — seed of, 642.
 Chemical composition of plants, 152-
 176.
 Chemiotaxis, 685.
 Chenopodiaceæ, 326, 350-363, 600.
Chenopodium, 351, 600.
 Cherry, 30, 39, 67, 99, 103, 155, 264,
 267, 397, 400.
 Chestnut, Horse, 62, 71, 96.
 — Spanish, 62, 96.
 Chevalier barley, 506 (Figs. 161-163).
 Chickweed, 4, 81, 87, 326, 593.
 Chicory, 162.
 Chiddam wheat, 524.
 Chlamydospore, 680.
 Chlorine, 169, 175.
 Chlorophyll, 108, 212, 213.
 Chlorophyll-granules, 108.
 Chloroplast, 107, 212.
 Choripetalæ, 325.
 Chromatophore, 107.
 Chromoplast, 107, 108.
Chrysanthemum, 268, 305, 470, 593,
 607.
 Chrysanthemum rust, 738.
Cicuta, 454.
 Cilium, 695, 770 (Fig. 262).
 Cinquefoil, 403.
 Clarke, James, 308.
 Classes, 322.
 Classification, 320.
Claviceps, 759.
 Cleavers, 74, 102, 593.
 Cleistogamous, 279.
 Climbing buckwheat, 601.
 Climbing plants, 53.
 Cliver, 593.
 Close-fertilisation, 279.
 Closed vascular bundles, 137, 144.
Clostridium, 772, 793 (Fig. 262).
 Clover, 27, 71, 282, 322, 421.
 Clover-dodder, 598, 649 (Fig. 199).
 Club-root, 763 (Fig. 258).
 Cluster-cup (Fig. 248).
Cnicus, 595, 608, 609.
 Cobb's hop, 341.
 Coccus, 769 (Fig. 260).
 Cocksfoot, 541, 553, 670 (Figs. 180,
 217).
Colchicum, 610.

- Cole, 379.
 Coleorhiza (Figs. 7, 151), 22.
 Colgate hop, 343.
 Collateral bundle, 117.
 Collenchyma, 115.
 Coltsfoot, 594.
 Columbine, 97 (Fig. 43), 326.
 Colza, 231, 380.
 Comfrey, 327.
 Commisure, 441 (Fig. 134).
 Common bundle, 117.
 Common oat, 494, 496.
 Companion-cell, 119, 120.
 Complete flower, 81.
 Compositæ, 83, 85, 91, 96, 101, 163,
 280, 287, 327, 470-474, 594, 607.
 Compound inflorescences, 90, 91.
 — leaf, 71.
 — spike, 92.
 — umbel, 92.
 Conical Root, 27.
 Conidiophore, 681.
 Conidium, 681 (Fig. 229).
 Coniferæ, 225.
 Coniferous trees, 72.
 Conifers, 77, 259.
 Conine, 167, 454.
Conium, 454.
 Conjugation, 689.
 Connective, 84 (Fig. 36).
 Continuity of protoplasm, 110.
Convallaria, 328.
Convolvulus, 597.
 Cooper's white hop, 342.
 Copper, 168.
 Copper-beech, 212.
 Cordate, 70.
 Cork, 129.
 Cork-cambium, 129.
 Cork-oak, 129.
 Corm (Fig. 23), 56.
 Corn bluebottle, 595.
 — cockle, 592.
 — crowfoot, 589, 637.
 — flower, 595.
 — marigold, 595.
 — sow-thistle, 596.
 — spurrey, 593.
 — thistle, 595.
 Cornel, wild, 61.
Cornus, 61.
 Corolla, 79, 83.
 Coronal roots, 484.
 Correlated variation, 316.
 Cortex, 113, 115 (Figs. 53, 54), 141.
Corylus, 63.
 Corymb, 91 (Fig. 39).
 Cotton, 102, 163, 224.
 Cotton-grass, 328.
 Cotyledons, 9 (Figs. 2, 5, 6), 72.
 Couch-grass, 73, 551 (Fig. 187), 602.
 Couch, black, 534.
 Cowbane, 454, 577.
 Cowgrass, 424.
 Cowslip, 91, 281.
 Crab, 66, 263.
 Crack Willow, 65.
 Cranesbill, 101 (Figs. 199, 201), 649,
 650.
Cratægus, 66, 407.
 Creeping crowfoot, 589 (Figs. 21, 223),
 605, 675.
 Crenate, 70.
 Crested dogstail, 540, 554, 669 (Figs.
 179, 215).
 Crimson clover, 426 (Fig. 128).
 Crimson clover, seed of, 647 (Fig. 197).
 Crocus, 56 (Fig. 23), 251, 329.
 Cross breeds, 286.
 Cross-fertilisation, 279.
 Cross-pollination, 279, 299, 301.
 Crowfoot, 29, 589, 605 (Figs. 21, 223).
 Crown-grafting, 266 (Fig. 96).
 Crown rusts, 736 (Fig. 249).
 Cruciferæ, 87, 288, 326, 365-368, 591,
 605, 639.
 Cryptogams, 323.
 Crystalloid, 167.
 Crystals, 164 (Fig. 80).
 Cuckoo flower, 605.
 Cucumber, 87, 96, 99, 186, 278, 807.
 Culm, 475.
 Cupuliferæ, 225.
 Currants, 29 (Fig. 19), 64, 69, 91, 99,
 161, 260, 262.
Cuscuta, 178, 598, 599.
 Cuticle, 114.
 Cutin, 161.
 Cutocelluloses, 161.
 Cutose, 114.
 Cutting, 259 (Fig. 91).
 Cyclic, 80.
Cydonia, 407.
 Cymes, 92, 93.
 Cymose branching, 41 (Fig. 15).
 Cymose inflorescences, 92, 93 (Fig. 42).
Cynosurus, 541, 552.
 Cyperacæ, 328, 612.
 Cypselæ, 96, 471 (Figs. 147, 148).
Cystopus, 713 (Fig. 239).
 Cytase, 229.
 Cyttoplasm, 107.

- DACTYLIS*, 541, 552.
 Daffodil, 329.
 Dahlia, 29, 162, 268, 470.
 Daisy, 70, 85, 91, 280, 607.
 — ox-eye (Figs. 147, 199), 607.
 Damping-off, 693 (Fig. 232).
 Damson, 399.
 Dandelion, 85, 91, 101 (Fig. 148).
 Darnel, 550.
 Dates, 99, 229.
Daucus, 312, 444.
 Deadly nightshade, 468.
 Dead-nettle, 280 (Fig. 102), 327.
 Decay, 788.
 Deferred shoots, 50.
 Definite, 41 (Figs. 15, 22).
 Definite inflorescences, 89, 92, 93.
 Definitive nucleus, 273 (Fig. 99).
 Degeneration of varieties, 317.
 Dehiscent fruits, 97.
 Denitrification, 792.
 Dentate, 70.
 Derivative hybrids, 289.
 Dermatogen, 149 (Figs. 76, 77, 100).
Deschampsia 537, 552.
 Dextrin, 158, 228.
 Dextrose, 155.
 Diadelphous, 85, 411.
 Diageotropism, 255.
 Diaheliotropism, 254.
Dianthus, 287, 326.
 Diarch, 142.
 Diastase, 156, 158, 220, 228.
 Dichasium, 93.
 Dichogamous, 280.
 Diclinous, 87.
 Dicotyledons, 18, 69, 81, 325.
Digitalis, 287, 327.
 Dinkel, 518.
 Dicecious, 87, 88.
 Diplococci (Fig. 261).
 Diseases of animals, 803.
 Disinfectants, 778.
 Disk floret, 470 (Fig. 147).
 Dissepiments, 86 (Fig. 38).
 Dispersal of seeds, 100.
 Divergence, 75.
 Division of cells, 110 (Fig. 52).
 Divisions, 322.
 Docks, 51, 102, 281, 326, 601, 650, 667 (Fig. 199).
 Dodder, 171, 208, 598.
 Dog-rose, 65, 404.
 Dogstail, crested, 540, 553, 669 (Figs. 179, 215).
 Dogwood, 61.
 Dominant character, 290.
 Dormant buds, 50.
 Dorsal suture, 85 (Fig. 37).
 Double fertilisation, 274.
 — flowers, 80, 288.
 Dove's-foot cranesbill, 572 (Fig. 199), 649.
 Drumhead cabbage, 368, 369.
 Drupe, 99 (Fig. 124).
 Drupels, 99, 403.
 Dry-rot of potatoes, 708.
 Duke cherry, 264, 400.
 Dun oat, 497.
 Duramen, 127.
 Duration of grasses, 556.
 — of plants, 5.
 — of weeds, 577.
 Durmast oak, 66.
 Dutch clover, 425, 653.
 Dutch pea, 415.
 Dwarf cherry, 67, 264, 400.
 — thistle, 609.
 — wheat, 519-521 (Fig. 168).
 Dyers' Greenweed, 437, 606.
 EAR, 515.
 Early Hobbs' hops, 341.
 Eaver, 549, 675.
 Egg-apparatus, 273.
 Egg-cell, 273 (Figs. 99, 100, 101).
 Elder, 62.
 Elements, essential, 169, 171.
 — in plants, 168.
 Elliptical, 70.
 Elm, 41, 63, 97, 102, 124, 128 (Fig. 66), 136.
Elymus, 553.
 Emarginate, 71.
 Emasculation, 301.
 Embryo, 9, 274-277 (Figs. 2, 5, 100, 101).
 — -cell, 275 (Fig. 100).
 — -sac, 271 (Figs. 98, 99, 101).
 Emmer, 518.
 Emulsin, 231, 398.
 Endocarp, 99, 398 (Fig. 124).
 Endodermis, 116 (Figs. 54, 60, 72), 141.
 Endogenous, 27.
 Endophytic, 684.
 Endosperm, 18, 278.
 Endospermous, 18 (Fig. 101).
 Endospore, 680 (Fig. 230).
 English oak, 60.
 — wheat, 519.
 Entire, 70.

- Entomophilous, 281.
 Enzymes, 227, 780.
 Ephemerals, 4.
 Epicalyx, 401.
 Epicarp, 99, 398 (Fig. 124).
 Epicotyl, 10 (Figs. 4, 11).
 Epidermis, 113, 114 (Figs. 53, 54, 59).
 Epigeal cotyledons, 18.
 Epigynous, 82 (Fig. 35).
Epilobium, 102.
 Epipetalous, 85.
 Epispore, 680.
 Epithelium, 228.
Equisetum, 603, 613.
 Erect-eared barleys, 504 (Fig. 161).
 Ergot, 758 (Figs. 256, 257).
 Ericaceæ, 225.
Eriophorum, 328.
 Erysiphaceæ, 748.
Erysiphe, 756.
Erythræa, 93.
 Esparsette, 655.
 Essential elements, 169, 171.
 Essential oils, 164.
 Essential parts of flower, 84.
 Etiolated plants, 246.
 Euasci, 688.
 Eubasidii, 688, 715, 725, 726.
 Eumycetes, 688.
Euonymus, 61.
Euphorbia, 93.
Euphrasia, 225, 327, 576.
 Evergreen, 76.
 Everlasting pea, 420.
 Exalbuminous, 18 (Fig. 101).
 Exendospermous, 18 (Fig. 101).
 Exine, 270 (Fig. 97).
 Exocarp, 99.
 Exstipulate, 68.
 Extent of roots, 30-32.
 Extravaginal shoots, 476.
 Exudation-pressure, 186-189.
 Eyebright, 225, 327, 576.
- FACULTATIVE, 775.**
Fagus, 63, 136.
 Fall of leaf, 76.
 False main-axis, 41 (Fig. 15).
 False (spurious) fruits, 96.
 False Brome-grasses, 547 (Fig. 256).
 Family, 322.
 Fan barley, 504.
 Farinose, 158.
 Farm seeds, 614-676.
 Farm weeds, 571-613.
 Farnham whitebine hop, 342.
- Fascicular cambium (Fig. 54).
 Fat-enzyme, 231.
 Fat hen, 351, 600.
 Fats, 163, 224.
 Female flower, 87.
 Fenton wheat, 524.
 Fermentation, 779.
 — acetic, 784.
 — butyric, 782.
 — lactic, 780.
 — of cellulose, 785.
 — of urea, 786.
 Ferments, 227, 780.
 Ferns, 324.
 Fertilisation, 269, 273, 274.
 — cross-, 279.
 — self-, 279.
 — tube, 695.
 Fescues, 543 (Figs. 182, 220, 222-224),
 553, 554, 672-674.
Festuca, 543, 552.
 Fibres, 119.
 Fibrils, 30.
 Fibrous cells, 119.
 Fibrous root, 28.
 Field pea, 413, 414.
 Fig, 96.
 Filament, 84.
 Filbert, 73.
 Finger-and-toe, 763 (Fig. 258).
 Fiorin, 534 (Figs. 174, 212), 555, 667).
 Fixation of varieties, 305-309.
 Fixation of free nitrogen, 793-803.
 Fixed oils, 163, 224.
 Flagella, 770.
 Flax, 163, 224, 389.
 Flax fibre, 391.
 Flax seed, 642.
 Flint wheat, 519 (Fig. 168).
 Flinty endosperm, 481.
 Floating foxtail, 532.
 Floral leaves, 73, 80.
 Flower, 78-88.
 Flowering plants, 323.
 Flowerless plants, 323.
 Fly oat, 494.
 Foliage leaf, 37, 38 (Figs. 5, 12, 13, 14,
 75), 68, 144.
 Follicle, 97.
 Food of plants, 201.
 Food-materials, 202.
 — absorption of, 202-207.
 Fool's parsley, 455.
 Forget-me-not, 93, 327 (Fig. 227).
 Formaldehyde, 210.
 Formative region, 240.

- Formative tissue, 111.
 Four-rowed barley, 501 (Fig. 160).
 Foxglove, 89, 284, 327.
 Foxtail, floating, 532.
 — meadow, 280, 531, 555, 664 (Figs. 172, 209).
 — slender, 532, 665 (Fig. 210).
Fragaria, 287, 401.
Fraxinus, 135.
 Free central, 87.
 Free stocks, 264.
 Freezing, effects of, 244.
 French rye-grass, 536, 669.
 Fructose, 155.
 Fruit, 95, 278.
 Fruit-buds, 39.
 — spurs, 44, 49 (Figs. 17, 19, 20).
 — sugar, 155.
Fuchsia, 189.
 Fuggle's Hop, 343.
 Fumaricæ, 590.
Fumaria, 590.
 Fumitory, 590.
 Functions, 152.
 Fundamental tissue, 113.
 Fungi, 677.
 Fungi imperfecti, 746.
 Fungus-gall, 686.
 Funicle, 7, 272 (Figs. 1, 98, 99, 101).
 Furze, 436.
Fusarium, 708 (Fig. 237).
 Fusiform root, 28.
Fusisporium, 708.
- GAILLARDIA*, 470.
Galanthus, 329.
 Gall, fungus-, 686.
 — insect-, 764.
Galium, 102, 593.
 Gametes, 269, 292.
 Gamopetalous, 83.
 Gamosepalous, 83.
 Garlic, 328.
 Gean, 67, 264, 400.
 Generative cell, 270 (Fig. 97).
Genista, 437, 440.
 Genus, 321.
 Genus-hybrids, 287.
 Geotropism, 255.
Geranium, 93, 100, 649, 652.
 Germination, 11-16.
 — of spores, 682.
 Germ-pores, 728.
 Germ-tube, 683 (Fig. 229).
Geum, 408.
 Giant Eliza oat, 497.
- Glabrous, 71.
 Gladiolus, 56, 287, 329.
 Glands, 115.
 — honey-, 282.
 — lupulin, 338 (Fig. 106).
 Glandular hair, 339.
 Glasswork, 176.
 Globoid, 167.
 Gloxinia, 259.
 Glucose, 155.
 Glucosides, 230.
 Glumes, 73, 479 (Figs. 150, 207).
 Glutamine, 167, 224.
 Golden drop wheat, 526.
 — oat grass, 539, 668.
 Golding hop, 341, 342.
 Goldthrope barley, 506.
 Good King Henry, 351.
 Gooseberry, 29, 49, 65, 82 (Figs. 46, 91, 99, 260).
 Goosefoot, 351, 600.
 Goosegrass, 593.
 Gorse, 436.
 Graft, 262.
 Graft-hybrids, 262.
 Grafting, 259, 262.
 Gramineæ, 328, 475-555.
 Grand period of growth, 242.
Granulobacillus, 782.
 Granulose, 158.
 Grape, 99, 114, 262, 278.
 Grape hop, 343.
 Grape-sugar, 155.
 Grass mixtures, 560, 562.
 Grass 'seeds', 660 (Fig. 207).
 Grasses, 281, 475, 530-555.
 — determination by leaves, 553.
 — for temporary and permanent pastures, 556.
 — flower of, 480 (Fig. 150).
 — generic characters of, 552.
 — stem of, 475.
 Grass mildew, 756.
 Green manure, 383, 432, 434, 437.
 Greenweed, Dyers', 437, 606.
 Grey field pea, 414.
 Grey maple pea, 415.
 Grey oat, 497.
 Grey Warwick pea, 414.
 Groundsel, 4, 83, 91, 101 (Fig. 148), 595.
 Ground thistle, 609.
 Ground tissue, 113.
 Growing-point, 35, 148, 241.
 Growth, 240, 241.
 — conditions of, 243-246.

- Growth, energy of, 242.
 — grand period of, 242.
 — movements, 247-257.
 Guard-cells of stoma, 147 (Fig. 74), 194.
 Guelder-roses, 61.
 Gymnosperms, 324.
 Gynæcium, 79, 81, 85.
- HAIRS, 115 (Fig. 54).
 — root, 32.
 Hair Grasses, 537 (Fig. 177), 668, 676.
 Halophytes, 176.
 Hardcastle wheat, 524.
 Hard fescue, 544, 674 (Fig. 224).
 Hard head, 608.
 Hard seeds, 644.
 Hard wheat, 519 (Fig. 168).
 Hariff, 593.
 Hassock grass, 537.
 Hastate, 70.
 Haustoria, 684.
 Hawkbit, 609.
 Hawthorn, 66, 103, 263, 407.
 Hazel, 41, 63, 73, 87, 90, 96.
 Healing of wounds, 131.
 Heart cherry, 67, 264, 400.
 Heart-wood, 127, 199.
 Heat, influence of, 185, 196, 213, 227
 243, 251, 774.
 Heath, 225.
 Hedgehog wheat, 521.
 Hedge parsley, 102.
 Heel, 261.
Helianthemum, 93.
Helianthus, 470.
 Heliotropism, 253.
 Hellebore, 280.
 Hemiasci, 688.
 Hemibasidii, 688, 715, 716.
 Hemibasidium, 716.
 Hemicellulose, 160, 224, 229.
 Hemicyclic, 80.
 Hemlock, 92, 167, 454.
 Hemp, 332, 348.
 Henbane, 469.
 Henham's Jones hop, 341.
 Hermaphrodite, 87.
 Heterœcious, 726.
 Heterozygote, 294.
 Higher fungi, 688.
 Hilum, 8, 156.
 Himalayan barley, 503 (Fig. 160).
 Hip, 404.
 Hoary white wheat, 526.
Holcus, 535, 552.
 Hollow-crown parsnip, 453.
- Holly, 128, 305.
 Hollyhock, 89, 738.
 Homogamous, 281.
 Homozygote, 294.
 Honey-gland, 282.
 Honey-suckle, 62, 248, 282.
 Hop, 4, 29, 83, 87, 102, 115, 248, 268, 281.
 — common hop, 332 (Figs. 103-108).
 — Japanese hop, 332.
 — varieties of, 339.
 Hop-clover, 428.
 Hop, mildew, 749.
 — mould, 749 (Figs. 254, 255).
 — oil, 346.
 — tannin, 347.
 — trefoil, 428, 429.
 Hopetoun oat, 497.
 — wheat, 526.
Hordeum, 501, 547, 552.
 Hornbeam, 63, 128, 136, 225.
 Horse beans, 416, 417.
 Horse chestnut, 62, 71.
 Horse-tail, 603, 613.
 Host, 684.
Humulus, 332.
 Humus, 208, 225.
 Hungarian forage-grass, 545.
 Hunter's white wheat, 524 (Fig. 169).
 Hurt-sickle, 595.
 Hyacinth, 69, 86, 91, 268, 328.
 Hybrid, 285, 287.
 Hybrid clover, 425.
 Hybridisation, 285, 287.
 Hydrogen, 171, 783.
 Hydrolysis, 230.
 Hydrotropism, 257.
 Hymenium, 743 (Fig. 252).
Hyoscyamus, 469.
 Hypertrophied tissues, 686.
 Hypha, 677 (Fig. 229).
Hypochaeris, 609.
 Hypocotyl, 10 (Fig. 5).
 Hypogean cotyledons, 18.
 Hypogynous, 81 (Fig. 35).
 Hypophysis, 276 (Fig. 100).
- ICE, in plants, 244.
 Imbricated bulb, 60.
Impatiens, 101.
 Imperfect flower, 87.
 Imperial barley, 506.
 Incomplete flower, 81.
 Increase in thickness of cell-wall, 109,
 110.
 — of root, 142.
 — of stem, 122.

- Indefinite, 40 (Figs. 15, 22).
 — branching, 40.
 — inflorescences, 89.
 Indehiscent fruits, 96.
 Induced movements, 250.
 Inferior gynæcium, 82.
 Inflorescence, 89-93 (Figs. 39-42).
 Initial cells, 122.
 Insect fertilisation, 281.
 Insect pollination, 281.
 Integuments, 271 (Fig. 99).
 Intercalary growing-plants, 241.
 Intercellular, 684.
 Intercellular spaces, 112 (Fig. 48).
 Interfascicular cambium, 120 (Fig. 54).
 Intermediate carrot, 449.
 Internodes, 34, 36.
 Intine, 270 (Fig. 97).
 Intracellular, 684.
 Intramolecular respiration, 238.
 Intravaginal shoots, 476.
 Inulase, 229.
 Inulin, 163, 223, 229.
 Invertase, 156, 219, 230.
 Invert-sugar, 156.
 Involucel (Fig. 41).
 Involucre, 91 (Fig. 40), 470.
 Involution forms of bacteria, 770.
 Iodine, 168, 204.
 Iridææ, 288, 329.
Iris, 73, 329.
 Iron, 175, 213.
 Irregular flower, 80.
 Italian clover, 426.
 — seed of, 647 (Fig. 197).
 Italian rye-grass, 549, 657 (Fig. 186).
 Ivy, 53, 69, 91, 254.

JERUSALEM artichoke, 56, 163, 222, 229.
Juglans, 64.
 Juncaceæ, 328, 612.
Juncus, 328, 612.

KAIL, 367, 368.
 Kedlock, 591.
 Kentish cherry, 49, 67, 400.
 Kidney vetch, 102, 434, 634.
 Kilk, 591.
 Knapweed, 608.
 Knot, 125 (Fig. 58).
 Knot-grass, 326.
 Kohl-rabi, 368, 369.

LABIATÆ, 280, 327, 610.
 Laburnum, 128.
 Lactic fermentations, 780.

 Lady's bedstraw, 606.
 — fingers, 654.
 — smock, 605.
 Lamella, 742 (Fig. 251).
 Lamina, 68.
Lamium, 283, 327.
 Lammass wheat, 526.
 Lanceolate, 70.
Lapsana, 597.
 Larch, 30, 128 (Fig. 63), 134.
Larix, 134.
 Lateral roots, 26.
 Latex, 472.
Lathyrus, 420, 439.
 Layers, 259, 261 (Fig. 92).
 'Laying' ('lodging'), 175, 488.
 Leaf, 34, 68-77.
 — arrangement, 74.
 — blade, 68 (Figs. 29, 149).
 — compound, 71 (Figs. 32, 33).
 — fall of, 76.
 — floral, 73, 80.
 — foliage, 68, 144 (Figs. 29, 75).
 — forms of, 70 (Figs. 30, 32).
 — margin, 70 (Fig. 31).
 — simple, 71.
 — structure of, 144-147.
 — scar, 77.
 — sheath, 68, 69 476 (Fig. 149).
 — spine, 74.
 — stalk, 68.
 — tendril (Fig. 33), 74.
 — trace, 117.
 — venation, 69.
 Leaf-bud, 39.
 Leaflet, 71 (Figs. 32, 33).
 Leaves of grasses, 553.
 Legume, 97 (Fig. 37).
 Leguminosæ, 280, 288, 327, 410-440, 605.
 Length of branches, 43.
 Length of roots, 29.
 Lenticels, 130.
Leontodon, 609.
 Lettuce, 470.
 Leucine, 167, 224, 231.
 Leucoplast, 107, 108, 223, 224.
 Levulose, 155.
 Leys, 558, 562.
 Lichens, 324.
 Light, effect on 'assimilation,' 211, 213, 214.
 — bacteria, 774.
 — growth, 246, 253.
 — transpiration, 195.
 Lignin, 162.
 Lignocelluloses, 161.

- Lignone, 162.
 Ligowo oat, 497.
 Ligulate corolla, 472 (Fig. 147).
 Ligule, 478 (Fig. 149).
 Ligulifloræ, 472.
Ligustrum, 62.
 Lilac, 92.
 Liliaceæ, 163, 328, 611.
 Lily of the Valley, 69, 91, 328.
 Lily, Trumpet, 90.
 Lime trees, 63, 128, 136.
 Linaceæ, 326, 389, 642.
 Linear, 70.
 Linseed, 163, 389, 642.
 — cake, 396.
Linum, 389.
 Lipase, 231.
Listera, 329.
 Liverwort, 324.
 Lobed, 70.
 Loculus, 86.
 Loculicidal, 98.
 'Lodging' of cereals, 176, 488.
 Lodicules, 480 (Fig. 150).
Lolium, 548, 553.
 Longitudinal sections, 104.
 Long red Surrey carrot, 450.
 Lords-and-ladies, 90.
Lotus, 435, 439.
 Lousewort, 576.
 Lower fungi, 688.
 Lucerne, 71, 429 (Fig. 133).
 — seed of, 645 (Fig. 195).
 Lupin, 71, 167, 437.
Lupinus, 437, 440.
 Lupulin, 338 (Fig. 106).
Luzula, 328, 612.
Lychnis, 326, 592.

MACROSPORIUM, 705 (Fig. 236).
 Magnesium, 175.
 Magnum Bonum potato, 308.
 Mahaleb, 67.
 Main's stand-up wheat, 524.
 Male flower, 87.
 Male reproductive cell, 270 (Fig. 97).
 Malic acid, 164.
 Malting barley, 508.
 Maltose, 156, 211, 220.
 Mangel wurzel, 18, 27, 81, 83, 176,
 189, 352 (Figs. 109-114).
 ——— seed, 658.
 ——— rust, 740.
 ——— varieties of, 358-360 (Fig. 114).
 Maples, 62.
 Marl-grass, 424.
 Margin of leaf, 70 (Fig. 31).
 Marigold, 91.
 — corn, 595.
 Marram, 533.
 Marsh Bird's-foot trefoil, 436, 655.
 Mat-grass, 533, 547 (Fig. 185).
 Mathon hop, 342.
Matricaria, 594.
 Mayweeds, 594.
 Mazagan bean, 417.
 Meadow barley, 547.
 — clover, 424.
 — fescue, 543 (Figs. 182, 220), 672.
 Meadow foxtail, 531 (Figs. 172, 209),
 555, 664.
 — grasses, 92, 542, 671 (Figs. 149,
 182, 219, 220).
 — saffron, 328, 577, 611.
 — sweet, 408.
 Mealy endosperm, 481.
Medicago, 429, 440.
 Medick, 102, 428, 645, 646.
 Medlar, 263, 405-407.
 Medulla, 113 (Figs. 53, 54).
 Medullary ray, 114 (Figs. 53, 54, 56).
Melampyrum, 225.
 Meld-weed, 600.
 Melick-grass, 670 (Fig. 216).
 Melilot, 432.
Melilotus, 432, 440.
 Melon, 87, 278, 299, 807.
 Mendelian inheritance, 289.
Mentha, 327.
 Meopham hop, 341.
 Mercer's hop, 341.
Mercurialis, 280.
 Mercury, 280.
 Mericarp, 97.
 Meristem, 111.
 Mesocarp, 99, 398 (Fig. 124).
 Mesophyll, 146.
Mespilus, 407.
 Metabolism, 217.
Micrococcus, 771 (Fig. 261).
 Micropyle, 8, 271 (Figs. 98, 99, 101).
 Midsummer rye, 513.
 Mignonette, 5, 91.
 Mildew, 726, 748.
 Milk-thistle, 596.
 Millefoil, 473.
 Mimoseæ, 410.
 Mint, 29, 115, 327.
 Mistletoe, 128, 575.
 Mixed buds, 39.
Molinia, 670.
 Monadelphous, 85, 411.

- Monkshood, 326.
 Monocarpic, 6.
 Monochasium, 93.
 Monochlamydeous, 83.
 Monoclinous, 87.
 Monocotyledons, 21, 69, 81, 328.
 Monœcious, 87.
 Monomorphic, 682.
Monotropa, 225.
 Morello cherry (Fig. 19), 49, 50, 67, 264, 400.
 Morphine, 167.
 Morphology, 3.
 Mosaic-hybrids, 287.
 Mosses, 324.
 Mountain ash, 66, 405.
 Movements of growth, 247-257.
 —induced, 250-257.
 —spontaneous, 247.
 Mucoelluloses, 161.
Mucor, 689 (Fig. 230).
 Mucronate, 71.
 Mulberry, 96.
 Multilocular ovary, 86 (Fig. 38).
 Mushroom, 740 (Figs. 251, 252).
 Mussel plum, 264.
 Mustard black, 381, 386 (Fig. 123).
 —seed of, 641.
 —white, 16, 383, 386 (Figs. 5, 123).
 —seed of, 642.
 Mustard-oil, 382, 383.
 Mycelium, 677.
 Mycetozoa, 323.
 Mycorhiza, 226.
Myosotis, 93, 327, 676.
 Myrosin, 231, 382.
 Myronate of potassium, 382.
 Myxamoeba, 766 (Fig. 259).
 Myxomycetes, 323, 765.
- NAKED BARLEY, 501.**
 —buds, 39.
 —flower, 83.
 —oat, 493.
 Napiform root, 28.
Narcissus, 73, 268, 287, 310, 329.
Nardus, 547, 552.
 Nectar, 282.
 Nectarines, 305.
 Nectary, 282.
 Negative-pressure, 188.
Neottia, 208, 225.
 Nepal wheat, 503.
 Net-veined, 69.
 Nettle, dead, 74.
 —stinging, 4, 187, 610.
- Newmarket oat, 497.
 Nicotine, 167.
 Nightshade, 468.
 Nipplewort, 597 (Fig. 199), 649.
 Nitragin, 802.
 Nitrates, 218.
 Nitrification, 789.
Nitrobacter, 789.
 Nitrogen, 171.
 Nitrobacterine, 802.
 —fixation of, 793-803.
 —sources of, 172, 217.
 Nitrogenous organic substances, 154, 165.
 Nitrogenous reserve-materials, 224.
Nitrosomonas, 789.
 Nodes, 28, 34.
 Nodules, 796 (Figs. 264, 265).
 Non-essential elements, 175.
 Non-essential parts of flower, 83.
 Non-nitrogenous organic substances, 155.
 Non-septate hyphæ, 678.
 Nonsuch clover, 429, 646.
 Notching, 261.
 Nottingham long-eared barley, 506.
 Nucellus, 271 (Figs. 98, 99, 101).
 Nucleus, 107 (Fig. 49).
 Nut, 96.
 Nutation, 247.
 Nyctitropic movements, 252.
- OAK, 66, 124, 128, 135 (Fig. 64), 263.
 Oat, 92, 314, 317, 493-499.
 —varieties of, 495-498.
 —wild, 493, 539 (Fig. 155), 602.
 Oat-grass, golden, 539 (Figs. 178, 213), 555-668.
 Oat-grass, downy, 540.
 —narrow-leaved, 540.
 —tall, 536 (Fig. 176), 555, 669.
 —yellow, 539.
 Obligate, 775.
 Obtuse, 71.
 Ochrea, 326.
Oenanthe, 455.
 Oidia, 680.
Oidium, 749, 757, 758.
 Oil, essential, 163.
 —fixed, 163, 224, 231.
 —volatile, 163.
 Old common barley, 506.
 One-grained wheat, 516 (Fig. 167).
 Onion, 19 (Figs. 6, 24), 58, 59, 69, 91, 223, 276.
 Onion-couch, 536.
Onobrychis, 432, 439.

- Ononis*, 437.
 Oogonium, 695 (Fig. 233).
 Oomycetes, 688, 692.
 Oosphere, 273, 695 (Fig. 233).
Oospora, 710.
 Oospore, 695 (Fig. 233).
 Open bundle, 117.
 Orache, 351, 600.
 Orange, 278.
 Orchard-grass, 541.
 Orchidææ, 281, 329.
 Orchids, 280.
Orchis, 101, 329.
 Order, 322.
 Organs, reproductive, 269.
 —vegetative, 78.
 Organic acids, 164.
 Organised ferments, 780.
Ornithopus, 434, 439.
Orobanche, 172, 599.
 Orthotropous ovule, 272 (Fig. 98).
 Osier, 65.
 Osmosis, 177, 203.
 Osmotic pressure, 178.
 —substance, 178.
 Ovary, 85 (Fig. 38).
 Ovate, 70 (Fig. 38).
 Ovule, 85, 271, 277 (Figs. 99, 101).
 Ovum, 273 (Figs. 99, 100, 101).
 Ox-eye daisy (Fig. 147), 607, 649.
 Oxalate of calcium, 164, 174.
 Oxalic acid, 164, 174.
Oxalis, 164.
 Oxygen, 171, 233-238, 775.

 PACEY'S rye-grass, 549, 675.
 Palea, 91, 479 (Fig. 150).
 Palisade parenchyma (Fig. 75), 147.
 Palmate, 71.
 Palmately-veined, 69.
 Palmatifid, 70.
 Palmatipartite, 70.
 Palmatisect, 70.
 Panicle, 92 (Figs. 41, 149), 480.
 Pansy, 279, 317 (Fig. 202), 652.
 Papilionaceæ, 410.
 Papilionaceous, 410.
Papaver, 590.
 Papaveraceæ, 326, 590.
 Pappus, 83, 472 (Fig. 148).
 Paradise apple, 30, 32, 263.
 Parallel-veined, 69.
 Paraphyses, 743 (Fig. 252).
 Parasites, 208, 684, 687.
 Parenchyma, 112.
 Parietal, 87 (Fig. 58).

 Parthenogenesis, 269.
 Partridge pea, 415.
 Parsley, 92, 280, 444.
 Parsley, hedge, 102.
 Parsnip, 69, 92, 97, 312, 443, 452.
 —seed, 657.
 —varieties of, 453.
 —wild, 312.
 Passion-flower, 74.
 Pasteurisation, 776, 805.
Pastinaca, 452.
 Pastures, temporary and permanent,
 556-570.
 —weeds of, 604.
 Pathogenic bacteria, 804.
 Pea (Figs. 33, 37, 72, 127, 194), 71, 74,
 83, 276, 284, 412.
 —varieties of, 414-415.
 Pea-mildew, 757.
 Peach, 49, 263, 300, 305, 400.
 Peacock barley, 504 (Fig. 161).
 Pear, 30, 32, 39 (Figs. 17, 18, 20, 126),
 49, 66, 82, 100, 189, 260, 262, 263,
 267, 278, 280, 310, 405.
 Pectin, 161.
 Pectose, 161.
 Pecto-celluloses, 161.
 Pedicel, 89.
Pedicularis, 225, 576.
 Peduncle, 78, 89.
 Pelargonium, 259, 287, 305.
 Pentosans, 162, 796.
 Peptones, 231.
 Perennials, 4, 223, 578.
 Perennial rye-grass, 548 (Figs. 186, 225),
 553, 675.
 Perianth, 83.
 Periblem, 149 (Figs. 76, 77, 100).
 Pericarp, 95.
 Pericycle, 116 (Fig. 60), 141.
 Periderm, 128 (Fig. 59), 129.
 Perigynous, 82 (Fig. 35).
 Perioplasm, 695.
 Perisperm, 277.
 Perithecium, 748 (Fig. 255).
 Permanent grasses, 563.
 —pasture, 561, 562, 565.
 —tissue, 111.
Peronospora, 713 (Fig. 238).
 Persistent, 83.
 Petals, 79 (Figs. 34, 35).
 Petaloid, 83.
 Petiole, 68, 69.
Petasites, 607.
Peucedanum, 443, 452.
 Phanerogams, 3, 323, 324.

- Phaseolus*, 798.
 Phelloderm (Fig. 59), 129.
 Phellogen (Fig. 59), 129.
Phleum, 532, 552, 666.
 Phloëm, 117, 119.
 Phosphorus, 173.
 Photosynthesis, 208, 210.
Phragmites, 205.
 Phycomycetes, 688, 689, 692.
 Phyllaries, 470.
 Physiology, 3, 152.
Phytophthora, 697 (Figs. 234, 235), 699.
Picea, 134.
 Pickling of cereal grains, 721, 722, 725.
 Pileus, 742 (Fig. 251).
 Piliferous layer, 141 (Fig. 72).
 Pimpernel, 89, 99, 252.
 Pine-apple, 278.
 Pine, Scots, 134.
 Pinks, 326.
 Pinnate, 71.
 Pinnately-veined, 69.
 Pinnatifid, 71.
 Pinnatifurcate, 71.
 Pinnatisect, 71.
Pinus, 134.
 Piper's thick-set wheat, 521.
 Pistil, 79.
 Pistillate, 87.
Pisum, 412, 439.
 Pith, 113.
 Pits, 110 (Fig. 50).
 Placenta, 85.
 Placentation, 87.
 Plantain, 70, 90, 99 (Figs. 45, 199), 280, 649, 675.
Plantago, 90, 280.
 Plants, 1.
 Plant diseases, 687.
 Plant-names, 322.
Plasmodiophora, 765.
 Plasmodium, 323, 765 (Fig. 259).
 Plasmolysed, 179.
Plasmopara, 713.
 Plastids, 107.
 Pleomorphic, 682.
 Plerome, 149 (Figs. 76, 77, 100).
 Plum, 39 (Figs. 19, 28, 29, 75, 124), 49, 67, 99, 102, 114, 155, 262, 263, 264, 278, 305, 397-399, 739.
 Plumule (Fig. 3), 10.
Poa, 542, 552.
 Polish wheat, 516, 518 (Fig. 167).
 Pollard, 51.
 Pollen, 84.
 — grain, 84 (Figs. 36, 97, 99), 269.
 Pollen sac, 84 (Fig. 36).
 — tube, 270 (Fig. 97, 99).
 Pollination, 279, 299.
 Polyadelphous, 85.
 Polyarch, 142.
 Polycarpic, 6.
 Polychasium, 93.
 Polygonaceæ, 325, 600, 610.
Polygonum, 326, 600.
 Polypetalous, 83.
 Polysepalous, 83.
 Pome, 100 (Fig. 126).
 Poplar, 51, 66, 102, 136.
 Poppy, 27, 81, 89, 98, 101, 590.
Populus, 66, 136.
 Potassium, 173.
 Potato, 4, 18, 29, 56, 85, 99, 229, 263, 268, 305, 308, 456 (Figs. 138-146).
 — diseases, 697-712.
 — varieties of, 460, 465.
 Potato oat, 496.
Potentilla, 403, 606.
Poterium, 408.
 Primary axis, 10, 40.
 — bast, 125.
 — cortex (c Fig. 60).
 — medullary rays, 126 (Fig. 62).
 — root (Fig. 4).
 Primary shoot, 34.
 — wood, 125 (Fig. 60).
 Primordial utricle, 107.
 Primrose, 83, 87, 281, 282.
 Privet, 62, 69, 77.
 Prolific hop, 341.
 Promycelium, 683, 716.
 Prophylla, 89.
 Prosenchyma, 112.
 Proskowetz, E., 311.
 Prostrate stems, 53.
 Protandrous, 280.
 Proteids, 165, 221.
 — formation of, 217.
 Proteid-crystal, 167.
 Proteid-grains, 167.
 Protobasidiomycetes, 726.
 Protogynous, 280.
 Protoplasm, 105, 106, 110.
 Protoxylem, 119.
Prunella, 327, 610.
Prunus, 30, 65, 66, 264, 397, 399.
 Prussic acid, 231, 399.
Psalliota, 740.
Psamma, 533.
 Pseudocarp, 96.
Pseudomonas campestris, 806.
 Pseudo-parenchyma, 679.

- Pteridophytes, 324.
 Ptomaines, 788.
Puccinia, 727, 727-739 (Figs. 245, 249).
 Puel's vernal-grass, 531.
 Pure culture, 776.
 Purple clover, 421.
 Purple medick, 429.
 Purple melick grass, 670 (Fig. 216).
 Putrefaction, 787.
Pyrola, 225.
Pyrus, 65, 66, 405.
Pythium, 693, 694 (Fig. 233), 697.
 Pyxidium, 99 (Figs. 45, 129, 130).
 Pyxis, 99.
- QUERCUS*, 66, 129, 135.
 Quince, 30, 32, 262, 263, 407.
 Quitch, 551, 602.
- RACE, 321.
 Raceme, 90 (Fig. 39).
 Racemose branching, 40 (Fig. 15).
 — inflorescences, 89-92.
 Rachilla, 478 (Fig. 150).
 Rachis, 89, 479 (Figs. 39, 149).
 Radial longitudinal section, 104.
 Radicle, 10 (Figs. 2, 5, 6).
 Radish, wild, 386, 592.
 Ragweed, 608.
 Ragwort, 608.
 Ramsons, 328, 577.
 Ranunculaceæ, 326, 589, 605.
Ranunculus (Figs. 21, 34), 322, 589, 605.
 Rape, 163, 224, 379, 381, 386.
Raphanus, 386, 592.
 Raphides, 165 (Fig. 80).
 Raspberry, 49, 65, 99, 287, 403.
 Rattle, 102, 225, 327, 576, 610.
 Ray florets, 471 (Fig. 147).
 Ray-grass, 548.
 Reading April wheat, 527.
 Receptacle, 78, 81 (Figs. 34, 35), 91, 472.
 Recessive character, 290.
 Reciprocal hybridisation, 289.
 Red clover, 27, 99, 421, 423, 648 (Figs. 128, 129, 130, 198).
 — currant, 49, 64.
 — fescue, 544.
 — mustard, 381.
 — rattle, 225, 576.
 Redwood willow, 65.
 Reed, 205.
 Regular flower, 80.
 Reniform, 70.
 Replum, 98.
- Reproduction, 258.
 — of fungi, 679-681.
 — of bacteria, 770-773.
 — sexual, 258, 269.
 — vegetative, 258.
 Reserve materials, 18, 36, 223, 227.
 Resin, 346.
 Respiration, intramolecular, 238.
 — ordinary, 233.
 Rest-harrow, 437, 605.
 Resting-spores, 682.
 Reticulate, 69.
 Reversion, 299, 317.
Rhamnus, 61, 64, 737.
Rhinanthus, 225, 327, 576, 610.
Rhizobium, 797.
Rhizoctonia, 707.
 Rhizome, 55 (Fig. 22), 255.
 Rhododendrons, 225.
Ribes, 64, 65.
 Rib-grass (see narrow-leaved plantain).
Richardia, 90.
 Rind-grafting, 266.
 Ringing of stems, 221, 222, 261 (Fig. 92).
 Ripening of cereals, 490.
 Rivet wheat, 519 (Fig. 168).
 Rock-rose, 93.
 Rodmersham hop, 341.
 Rogues, 317.
 Roots, 10, 25.
 — absorption by, 183-185, 203, 204.
 — adventitious, 28 (Figs. 10, 21, 144), 55.
 — branching of, 26.
 — depth of, 30.
 — extent of, 30-32.
 — forms of, 27, 28.
 — increase in thickness, 142.
 — lateral, 26.
 — length of, 29.
 — primary, 25.
 — secondary, 25 (Fig. 9).
 — structure of, 140-143.
 — tuberosus, 27.
 Root-cap, 149 (Figs. 72, 78).
 Root-hairs, 32 (Fig. 72), 141.
 Root-nodules, 796.
 Root-pressure, 186, 187.
 Root-stock, 55.
 Root-system, 26.
 Root-tubercles, 796.
Rosa, 65, 404.
 Rosaceæ, 327, 397-409, 606.
 Rose, 29, 51, 65, 71, 83, 97, 103, 282, 305, 308, 404.
 Rose mildew, 756.

- Rose willow, 65.
 Rough chaff wheat, 526.
 Rough-stalked meadow-grass, 542 (Figs. 181, 219), 554, 671.
 Rouncival pea, 415.
 Rowan-tree, 66.
 Rubiaceæ, 593, 606.
Rubus, 65, 403.
Rumex, 164, 326, 601, 610.
 Runch, 592.
 Runner, 54.
 Rush, 280, 328, 612.
 Rust-fungi, 726.
 Rust of cereals, 726-737 (Figs. 245-249).
 Rust of other plants, 738, 739.
 Rutabaga or Swede Turnip, 376.
 Rye, 287, 512-514, 550.
 Rye-grass, 92.
 —French, 536, 669.
 —Italian, 549, 555, 676 (Figs. 186, 228).
 —perennial, 548, 553, 675 (Figs. 186, 225).
- SACCHAROMYCES, 746.
 Saccharose, 155.
 Sagittate, 70.
 Sainfoin, 432, 655 (Fig. 206).
 Saint Julian plum, 264.
 Saint John's Day rye, 513.
Salicornia, 176.
 Salicin, 230.
Salix, 65, 136.
 Sallow, 65.
Salsola, 176.
 Salt, 176.
 Saltwort, 176.
 Samara, 97.
Sambucus, 62.
 Sand-culture, 169.
 Sandy oat, 497.
 Sap-wood, 127.
 Saprophytes, 208, 683.
Sarcina, 771 (Fig. 261).
 Savoy cabbage, 368, 369.
 Scab of potatoes, 709.
 Scale-leaves, 37, 39, 72.
 Scaly buds, 39.
 Schizocarp, 97.
 Schizomycetes, 324.
 Schizophyta, 324.
 Schrader's Brome-grass, 545.
 Scion, 262 (Figs. 95, 96).
Scirpus, 328.
 Sclerenchyma, 112.
 Sclerotium, 679, 759.
- Scotch kail, 367.
 Scots pine, 134.
 Scrophulariaceæ, 288, 327, 610.
 Scutch, 602.
 Scutellum (Fig. 7), 22.
 Sea-beet, 176, 301, 351.
 Seakale, 176.
 Seaweed, 323.
Secale, 512, 513, 550, 553.
 Secondary axes, 40.
 —bast, 125.
 —cortex, 129.
 —medullary rays, 126 (Fig. 62).
 —nucleus, 273.
 —wood, 125 (Fig. 60).
 Sections, 104 (Fig. 47).
 Sedges, 56, 281, 328, 612.
 Segregation, 294.
 Seeds, 7, 277, 614.
 —absolute weight, 630.
 —age of, 11, 620, 621.
 —brightness, 637.
 —colour, 636.
 —form, 635.
 —germination capacity, 620.
 —germination energy, 626.
 —perfect sample, 616.
 —purchase of, 663.
 —purity, 616.
 —smell, 638.
 —specific gravity of, 629.
 —volume-weight, 632.
 —weight of, 629.
- Seed-leaf, 72.
 Selection, 305-310.
 Self-fertilisation, 279.
 Self heal, 327, 610, 652, 667 (Fig. 203).
 Self-pollination, 279.
 Seminal-roots, 484.
 Seminal sports, 305, 306.
 Seminal varieties, 310.
 Semi-parasites, 225.
 Semi-saprophytes, 225.
Senecio, 595, 608.
 Sepal, 78.
 Septicidal, 98.
 Septifragal, 98.
 Septate hyphæ, 678 (Fig. 229).
 Serradella, 434.
 Serrate, 70.
 Sessile, 69.
 Sexual affinity, 285.
 —reproduction, 258, 269.
 Sheath leaf, 68, 69.
 Sheep's fescue, 544, 554, 674 (Figs. 183, 223).

- Sheep's sorrel, 70, 610.
 Shepherd's purse, 27, 98, 275, 592.
 Sheriff, Patrick, 307.
 Shield-budding, 263.
 Shoot, 34.
 — of fruit-trees (Fig. 19).
 Shooting of corn, 487.
 Short-lived grasses, 563.
 Short oat, 494.
 Shrubs, 53.
 Sieve-plates, 120.
 Sieve-tube, 119.
 Silage, 764.
 Silica, 175, 205.
 Silicon, 175.
 Silicula, 98.
 Siliqua, 98 (Fig. 44).
 Silver-fir, 128, 134.
 Silver-weed, 403, 606.
 Simple inflorescence, 90.
 Simple leaf, 71.
 Simple pits, 110 (Fig. 50).
 Sinalbin, 384.
Sinapis, 16.
 Sinigrin, 230, 382.
 Six-rowed barley, 501 (Fig. 160).
 Sleep-movements, 252.
 Slender foxtail, 532, 665 (Fig. 210).
 Slime-fungi, 323, 765.
 Sloe, 54, 66, 74, 103, 399.
 Slugs, 807.
 Smooth-stalked meadow-grass, 542, 554,
 671 (Fig. 218).
 Smut of barley, 719.
 — maize, 723.
 — oats, 716.
 — rye, 720.
 — wheat, 718, 719.
 Snapdragon, 91, 327.
 Snowdrop, 73, 229, 329.
 Sodium, 176.
 Soft-grass, 535.
 Soft Brome-grass, 546 (Fig. 184), 555.
 Solanaceæ, 327, 456-469.
Solanum, 251, 456.
 Solitary flower, 89.
Sonchus, 596.
 Sorrel, 70, 164, 326, 610.
 — wood 164, 252, 279.
 Sorus, 728.
 Sow thistle, 596.
 Spadix, 90.
 Spalding wheat, 526.
 Spanish chestnut (Figs. 27, 67), 62, 96,
 124, 136, 263.
 Spathe, 73, 90.
 Spathulate, 70.
 Spawn of fungus, 678, 741.
 Spear thistle, 608.
 Species, 321.
 Species-hybrids, 287.
 Speedwell, 89, 280, 327.
 Spelt-wheats, 516, 518.
Spergula, 326, 593.
 Spermaphytes, 3, 324.
 Spermatia, 731.
 Spermogonium, 731 (Fig. 248).
Sphacelia, 761.
Sphærotheca, 749, 750.
 Spike, 90 (Fig. 39), 479.
 Spikelet, 90, 478 (Figs. 149, 150, 207).
 Spines, 54.
 Spindle tree, 61.
Spiræa, 408.
 Spiral arrangement of buds, 64.
 — of leaves, 75.
 Spiral thickening, 110 (Fig. 51).
 Spiral vessel (Fig. 51).
 Spirillum, 769 (Fig. 260).
 Splint-wood, 127.
 Spongioles, 183.
Spongospora, 710.
 Spongy parenchyma, 147 (Fig. 75).
 Spontaneous movements, 247.
 Spores, 323, 679, 771.
 Sporangiphore, 680 (Fig. 230).
 Sporangium, 680 (Fig. 230).
 Sporidia, 716.
 Sporophore, 682, 742.
 Sport, 304.
 Spring-rust, 735.
 Spring-wood, 124 (Fig. 64).
 Sprouting, 683, 746.
 Spruce, 128, 134.
 Spurge, 93.
 Spurious fruit, 96.
 Spurrey, 326, 593.
 Spurs, 44 (Figs. 17, 19, 20).
 — age of, 50.
 — arrangement of, 49.
 Squarehead wheat, 524 (Fig. 169).
 —'s Master wheat, 527.
 Squirrel-tail fescue, 676.
 Stamen, 79 (Fig. 36).
 Staminate flowers, 87.
 Staphylococci (Fig. 261).
 Starch, 156 (Fig. 79), 211, 223, 224.
 Starch-cellulose, 158.
 Starch wheat, 518 (Fig. 167).
 Stele, 114, 116.
Stellaria, 93, 326, 593.
 Stem, 34.

- Stem anatomy of, 112-140.
 — branching of, 40.
 — herbaceous, 52.
 — increase in thickness of, 122.
 — varieties of, 52-60.
 — woody, 52.
 Sterigmata, 726, 730, 743 (Figs. 247, 252).
 Sterilisation, 776, 805.
 Stigma, 85 (Figs. 37, 38, 99).
 Stinging nettle, 4, 187, 610.
 Stipe, 742 (Fig. 251).
 Stipulate, 68.
 Stipule, 68.
 Stitchwort, 93.
 Stock, 262 (Figs. 95, 96).
 Stolon, 54.
 Stomata, 145 (Fig. 74).
 Storage of plant-foods, 219.
 Strawberry, 29, 54, 95, 96, 97, 103, 278,
 287, 308, 310, 401 (Fig. 125).
Streptococcus, 771, 781 (Fig. 261).
 Strig, 335.
 Strobile, 335 (Fig. 104).
 Stromata, 760.
 Strychnine, 167.
 Style, 85 (Figs. 37, 38, 99).
 Stylopodium, 441 (Figs. 134, 137).
 Suberin, 161.
 Sub-hymenial layer, 743 (Fig. 252).
 Sub-species, 321.
 Succulent fruits, 99.
 Sucker, 50, 56, 260.
 Sugar-beet, 155, 156, 223, 229, 316, 361
 (Fig. 115).
 Sugar-cane, 155, 156, 223.
 Sugars, 155.
 Sulphur, 173.
 Sunflower (Figs. 54, 55), 280.
 Superior gynaecium, 81, 82.
 Surrey carrot, 450.
 Suspensor, 275 (Fig. 100).
 Suture, dorsal, 85 (Fig. 37).
 — ventral, 85 (Fig. 37).
 Swarm-spore, 680, 694 (Fig. 259).
 Swede, 114, 376, 386 (Fig. 120).
 — seed of, 640.
 Swedish clover, 425, 651.
 Sweet vernal-grass, 280, 530, 555 (Figs.
 171, 208), 663.
 Sycamore (Figs. 12, 13, 14, 16), 62, 69,
 74, 97, 102, 128, 136, 187.
 Symbiosis, 800.
 Symmetrical, 80.
 Sympetalæ, 327.
Symphytum, 327.
 Sympodium, 41 (Figs. 15, 22), 56.
 Syncarpous, 86.
Synchytrium, 711.
 Synergidæ, 273.
 Syngenesious, 85, 471.
 Systematic Botany, 3, 320.
 TALAVERA wheat, 522 (Fig. 169).
 Tall oat-grass, 536 (Fig. 176), 555, 669.
 — fescue, 544, 673.
 Tangential longitudinal section, 105.
 Tannin, 230.
 Tap-root, 27.
 Tap-rooted crops, 31.
Taraxacum (Fig. 148).
 'Tares, 418.
 Tartarian oats, 495, 497.
 Teleutospore, 726, 729 (Fig. 247).
 Temperature, influence of, 185, 196,
 213, 227, 243, 251.
 Temporary pastures, 561, 565.
 Tendrils, 53 (Fig. 33), 74.
 Terminal buds, 38.
 — growing-points, 241.
 Testa, 8.
 Tetradyamous, 365.
 Thallophyte, 323.
 Thallus, 324.
 Thistles, 4, 83, 101, 595, 596, 608, 609.
 Thorns, 54.
 Thousand-headed kail, 367, 368.
 Thousand-leaf, 473.
 Throwing-back, 317.
 Tick bean, 417.
Tilia, 63, 136.
 Tillering, 482-485 (Figs. 152-154).
 Tilletiaceæ, 716, 723.
Tilletia, 723, 725 (Fig. 244).
 Timber of conifers, 134.
 Timber of dicotyledons, 134.
 Timothy grass, 532 (Figs. 173, 211),
 555, 666.
 Tissue, 111.
 — formation, 111.
 — fundamental, 113.
 — ground, 113.
 — parenchymatous, 112.
 — prosenchymatous, 112.
 — sclerenchymatous, 112.
 — tensions, 247.
 Toad-pipe, 603.
 Tobacco, 167, 185, 186, 284, 469.
 Tomato, 96, 99, 264, 278, 300, 309, 469.
 Tongue-grafting, 266 (Fig. 95).
 Tongueing, 261 (Fig. 92).
 Top-grasses, 557.
Torilis, 102.

- Toxins, 804.
 Tracheæ, 119.
 Tracheids, 119.
 Trama, 743 (Fig. 252).
 Translocation of food, 218.
 Transpiration, 191.
 — conditions which influence,
 194-196.
 Transpiration-current, 191, 198.
 Transverse section, 104.
 Trees, 53.
 Trefoil, 71, 429, 646 (Fig. 196).
 Triarch, 142.
Trifolium, 322, 421, 426, 440, 647
 (Figs. 128, 197).
Trisetum, 538, 552, 668.
 Trispecific hybrids, 289.
Triticum, 515, 550, 553.
Tropæolum, 189, 251.
 Trump wheat, 524.
 Trumpet lily, 90.
 Trunk, 53.
 Trypsins, 231, 232.
 Tuber, 56, 459 (Figs. 141-144).
 Tubercles of root, 796.
 Tuberculosis, 805.
 Tuberos root, 27.
 Tubuliferæ, 472.
 Tufted hair-grass, 537, 671.
 Tulip, 58, 59 (Fig. 25), 102, 223, 251,
 268, 305, 310, 328.
 Tunicated bulb, 60.
 Turgid, 178.
 Turgid wheat, 519 (Fig. 178).
 Turnip, 72, 98, 161, 276, 309, 317, 371,
 386 (Figs. 48, 116-120, 123).
 —seed of, 641.
 —varieties of, 374, 375.
Tussilago, 594.
 Tussock grass, 537.
 Tyloses, 128.
 Tyrosine, 167, 231.
 Tway-blade, 329.
 Twigs in winter, 42.
 Twining plants, 53.
 Twitch, 551, 602.
 Two-rowed barleys, 504 (Fig. 161).

ULEX, 436, 440.
Ulmus, 63.
 Umbel, 91.
 Umbelliferæ, 69, 92, 97, 280, 288, 327,
 441-455, 606.
Uncinula, 757.
 Unilocular ovary, 86 (Fig. 38).
 Unisexual, 87.

 Unorganised ferments, 227, 780.
 Upright grow-foot, 605.
 Urea, fermentation of, 786.
 Uredineæ, 726.
Uredo, 732.
 Uredospore, 728 (Fig. 246).
Uromyces, 739 (Fig. 250).
Urtica, 610.
 Urticaceæ, 610.
 Ustilaginaceæ, 716.
Ustilago, 717, 719, 720, 723.
 Utricle, primordial, 107.

 VACUOLE, 105.
 Valves, 98.
 Variation, 305, 312, 316.
 Varieties, 321.
 Variety-hybrid, 286.
 Vascular bundle, 113 (Figs. 53-55, 70,
 71).
 Vascular cylinder, 114, 116.
 Vegetable marrow, 96.
 Vegetative cell, 270 (Fig. 97).
 — organs, 78.
 — reproduction, 258.
 — shoot, 34.
 Velum parziale, 743 (Fig. 251).
 Velvet-eared wheat, 526.
 Venation, 69.
 Ventral suture, 85 (Figs. 37, 38).
Verbena, 90.
 Vernal-grass, sweet, 280, 530, 555, 663
 (Figs. 171, 208).
 — Puel's, 531, 664.
Veronica, 280, 327.
 Vessel, 119 (Fig. 55).
 Vetch, 71, 74, 280, 284, 418.
 Vetchling, 420.
 Vexillum, 410.
 Vibrio, 769 (Fig. 260).
Viburnum, 61.
Vicia, 412, 416, 439.
 Victoria wheat, 524 (Fig. 169).
 Vilmorin, 309, 312.
 Vine, 74, 92, 187, 260.
 Vine mildew, 713, 757.
Viola, 287, 667.
 Violet, 279.
Viscum, 575.
 Vittæ, 442 (Fig. 134).
 Volatile oil, 164, 347.
 Volume-weight of seeds, 632-635.

 WAGNER'S Everlasting pea, 420.
 Wall barley, 548.
 Wallflower, 81, 91, 98 (Fig. 44).

- Walnut, 64, 99, 128.
 'Wart,' Potato, 710.
 Water, absorption of, 182.
 —conduction of, 198.
 —culture, 169 (Fig. 82).
 —Dropwort, 455.
 —Hemlock, 454, 577.
 —in plants, 153.
 —influence on growth, 245, 257, 774.
 Wavy hair-grass, 537, 668 (Figs. 177, 214).
 Waxy bloom on plants, 114.
 Webb's Beardless barley, 506.
 Weeds, 571.
 —duration of, 577.
 —extermination of, 582.
 Weeds, habit of growth, 579.
 —how spread, 580.
 —injurious effects of, 571.
 —of arable ground, 589.
 —of pastures, 604.
 Wet-rot of potatoes, 707.
 Wheat (Figs. 7, 8, 81), 22, 92, 276, 287, 303, 309, 313, 316, 515-528, 550.
 Wheat-grass, 551.
 Whickens, 551.
 Whin, 436.
 Whip-grafting, 266.
 White beam, 65, 405.
 —clover, 29, 425, 653 (Figs. 131, 132, 204).
 —dead-nettle, 283 (Fig. 102).
 —heart cherry, 49.
 —lupin, 437.
 —melilot, 432.
 —mustard, 16, 383, 386 (Figs. 5, 123).
 —seed of, 642.
 —poplar, 66.
 —rot, 807.
 —rust, 714.
 —thorn, 66, 407.
 —Willow, 65.
 White's early hop, 341.
 Whorl, 74.
 Wild apple, 263.
 —cabbage, 366.
 —carrot, 4, 312, 444, 606.
 —cherry, 400.
 —cornel, 61.
 —hop, 344.
 —mustard, 591.
 —oat, 493, 539 (Fig. 155), 602.
 —pansy, 279, 317, 667 (Fig. 202).
 Wild parsnip, 4, 312.
 —pear, 30, 54, 263.
 —plum, 54, 67, 399.
 —radish, 386, 592, 656.
 —service tree, 65, 405.
 Willow, 44, 65, 83, 87, 88, 90, 102, 136, 305.
 Willow-herb, 102.
 Wind-fertilisation, 281.
 —pollination, 281.
 Winter bean, 417.
 Winter-green, 225.
 Woad-wax, 437, 606.
 Wood (Figs. 54, 55), 117.
 —avens, 408.
 —meadow-grass, 543, 672.
 —rush, 612.
 —vetchling, 420.
 Wood-parenchyma, 119.
 Wool-sorter's disease, 805.
 Wormwood, 470.
 Wounds, healing of, 131.
 Wych elm, 63.
 XANTHOPHYLL, 212.
 Xylem, 117.
 YARROW, 473.
 Yeast, 232, 746 (Fig. 253).
 Yellow flag, 329.
 —lupin, 437, 438.
 —melilot, 432.
 —oat-grass, 539 (Figs. 178, 213), 555, 668.
 —rattle, 102, 225, 327, 576, 610.
 —suckling, 428 (Fig. 205), 654.
 —trefoil, 429.
 —seed of, 646 (Fig. 196).
 Yew, 126.
 Yorkshire fog, 535 (Figs. 175, 210), 555, 665.
 ZIGZAG clover, 424.
 Zinc, 168.
Zinnia, 470.
 Zoogloea, 770.
 Zoology, 1.
 Zoospore, 680, 694 (Fig. 233).
 Zygomorphic, 81.
 Zygomycetes, 688, 689.
 Zygospore, 689.
 Zygote, 294.
 Zymase, 232, 747.

