

**MAKING
POULTRY PAY**

EDWIN C. POWELL

Missing Page

Cornell University Library
SF 487.P88 1907

Making poultry pay ...



3 1924 003 134 958

mann



Cornell University
Library

The original of this book is in
the Cornell University Library.

There are no known copyright restrictions in
the United States on the use of the text.

<http://www.archive.org/details/cu31924003134958>

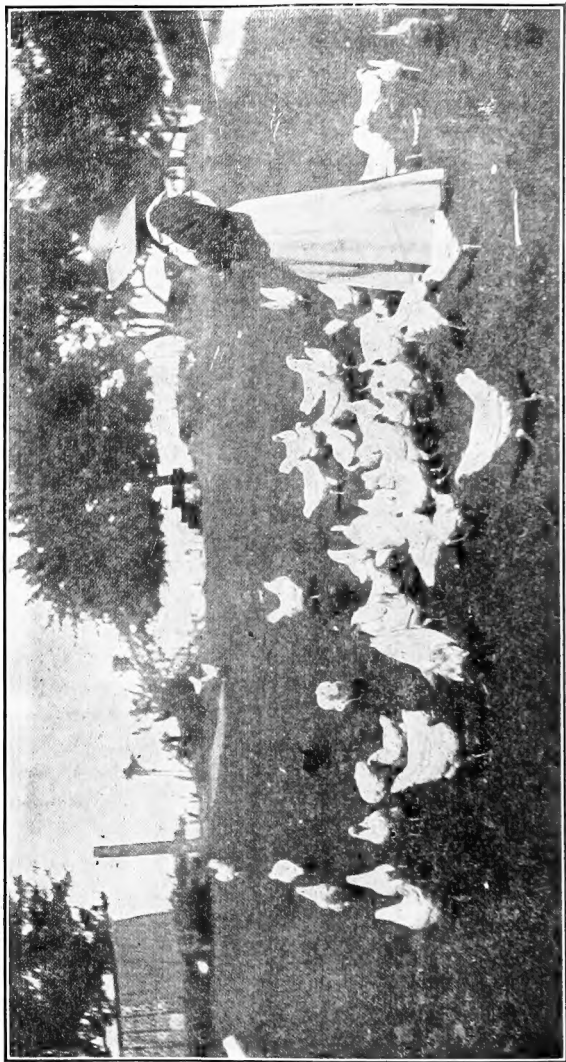

MONEY MAKERS ON AN AMERICAN FARM

Making Poultry Pay

Special

J. M. Acheson
E. F. Barry
Michael K. Boyer
Emma Clearwaters
E. I. Cole
William Cook
I. C. H. Cook
Samuel Cushman
J. H. Davis
D. Myron Greene
J. G. Hoover
A. F. Hunter
G. A. McFetridge
A. V. Meersch
Myra V. Norys
T. E. Orr
George H. Pollard
Francis E. Pearson
E. O. Roessle
W. H. Rudd
W. R. Smith
John Weber

Writers

By

EDWIN C. POWELL

*Editor Farm and Home, Formerly Poultry
Editor American Agriculturist Weeklies*

ORANGE JUDD COMPANY
NEW YORK, NINETEEN HUNDRED AND SEVEN

umd

Copyright, 1907
ORANGE JUDD COMPAN
NEW YORK

Introduction

The market is full of poultry books and poultry literature, but many of these works are out of date or have been written by people who know more of theory than of practice. Others, again, have had certain hobbies to advocate. The amateur, who knows little or nothing about poultry, in reading one or more of the so-called standard works often gets erroneous ideas which prove costly when carried out, so that before learning by experience to keep poultry successfully he either loses much necessary time and money, or gives up discouraged. The author, who claims to be only a practical poultryman, has no theories to advance, no hobbies to ride. He has aimed, in preparing this work, to draw largely from the experience of practical poultry keepers and to present a brief hand-book of poultry keeping, which will be a safe and convenient guide for those who keep a few or many fowls. That he has succeeded in this, even in a small way, is very gratifying and the words of commendation from those who have read the first edition show that the way to profitable poultry keeping has been pointed out to many amateurs.

Contents

CHAPTER I

	PAGE
Profits in Poultry.....	I
Not a quick-get-rich scheme—Where figures lie—What it costs to keep a hen—Conservative and actual profits—Starting in the poultry business.	

CHAPTER II

Care of Poultry.....	20
Cost of producing eggs—A laying competition—The sex of eggs—Selecting best layers—An amateur's experience—Forcing the molt—Care of poultry manure—Best size of flocks.	

CHAPTER III

Where to Keep Fowls.....	46
Buildings of many kinds—Arranging the interior—Yards and fences—Nests and appliances—A well-arranged poultry farm.	

CHAPTER IV

Breeds and Breeding.....	82
Principles of correct mating—Pure-bred poultry on the farm—Crossing pure breeds—Serviceable cross-bred chickens—Breeds and varieties of poultry	

CHAPTER V

	PAGE
Feeds and Feeding.....	119
Feeding for eggs—Fattening poultry for market—Composition of feeding stuffs.	

CHAPTER VI

Hatching and Rearing the Natural Way.....	149
Setting the hen—Brood coops for hen and chicks—Care of newly hatched chicks—Water for young chicks—Removing the hen.	

CHAPTER VII

Artificial Incubation.....	166
A bit of history—Setting the incubator—Turning the eggs—Proper heat—Testing the eggs—Moisture—Feeding incubator chicks—The brooder—Handling brooder chicks—Brooder houses—Homemade brooders.	

CHAPTER VIII

Broilers, Capons and Roasters.....	206
Best breeds—Philadelphia broilers—Capons and caponizing—The soft roaster industry.	

CHAPTER IX

The Market End.....	224
Fancy vs. utility—Storing eggs for winter—Shipping live poultry—Dressing and shipping poultry	

CHAPTER X

	PAGE
Waterfowl	234
Commercial duck breeding—Care of young ducks—Handling breeding stock—Winter quarters for ducks and geese—Killing and picking—Breeds—Keeping geese for profit—The care of breeding geese—Feeding and fattening—Picking—Breeds—Cross breeding—Breeding and keeping swans.	

CHAPTER XI

Turkeys, Guineas, Peafowls.....	265
Selection and care of breeding turkeys—Keeping turkeys in confinement—Feeding and care of young turkeys—Marketing turkeys—Guineas—Peafowls.	

CHAPTER XII

Pigeons and Squab Raising.....	278
Squab raising a fad—Where to keep pigeons—Pigeon lofts and houses—Pheasant rearing.	

CHAPTER XIII

Enemies and Diseases.....	286
Asthenia—Blackhead in turkeys—Bowel trouble—Bumble foot—Cholera—To avoid colds—Consumption—Cramps—Crop bound—Douglas mixture—Egg bound—Feather eating—Gapes—Hawks—Leg weakness—Lice—Mites—Limber neck—Rats—Roup—Sore heads—Scaly leg—Skunks—Venetian red—Worms.	

List of Illustrations

	PAGE
Money makers on an American farm....	Frontispiece
Types of good and poor layers.....	32
The original scratching shed house.....	48
Ground plan of scratching shed house.....	49
Nest boxes	50
Curtain front house.....	51
Cornell two-pen house.....	52
Frame of Cornell house.....	53
Side view Cornell house.....	55
Front elevation Cornell house.....	56
Ground plan Cornell house.....	57
Messrs. Perry's well-arranged house.....	60
Daniel Lambert's inexpensive house.....	61
Interior view D. J. Lambert's house.....	62
House and yards at New York experiment station	63
A forty-five-dollar house of the author's.....	64
Barrel stave house.....	65
A novel house for winter layers.....	66
House in a Boston suburb.....	67
A corner in the hallway.....	68
House with pens on both sides.....	69
Mr. Hayward's A-shaped house.....	70
Framework of a small house and yard.....	71
Runway to second story.....	72
Good interior arrangement.....	74
Well-planned interior.....	75
Plan for dark nests 76; Maine trap nests.....	78
Pair Light Brahmas.....	94
Black Langshan pullet.....	96
Pair Single Comb Brown Leghorns.....	98
Rose Comb Black Minorca.....	100

	PAGE
Pair White-Faced Black Spanish.....	101
Ancona pullet.....	102
Houdan cock.....	103
Barred Plymouth Rock cockerel 105; Hen.....	106
White Plymouth Rock hen.....	107
Pair of Golden Wyandottes.....	108
Pair Silver Laced Wyandottes.....	109
White Wyandotte cock.....	110
Pair Rose Comb Rhode Island Reds.....	111
Mottled Java cock.....	112
Buff Orpington cock.....	114
Cornish Indian cock.....	115
Red Pyle Game Bantam; White Cochin Bantam	117
Feed trough	121
Self feeder feed box.....	123
Self feeder.....	124
Clover cutter.....	127
Grit boxes 128; Grit crusher	129
Protected nests for sitting hens.....	151
Old-fashioned A coop; Coop with run and shelter	152
Coop with wire covered run.....	153
Convenient box coop	154
Framework of coop and run.....	155
Ventilated coop for hen and chicks.....	156
Protected coop for early chicks.....	156
Utilizing old barrels for coops.....	157
Shade board	157
Coop for two broods.....	158
Feeding trough for chicks.....	162
Covered feeding pen for chicks.....	162
Chick fountain.....	164
Outdoor summer shelter for chicks.....	165
Cat-proof shelter for chicks.....	165
Size of air cell during incubation.....	173
The completed hatch.....	174

	PAGE:
A modern incubator cellar.....	176
Plan of simple brooder house.....	184
Brooder house for farmers.....	185
Sectional hot water brooder.....	186
Sidehill brooder house; Individual brooder house	187
Author's colony-brooder house.	188
Inexpensive colony-brooder house.....	189
Small brooder houses on the range.....	190
A Rhode Island colony-brooder house.....	191
Built of two piano boxes.....	192
An Indiana colony-brooder house.....	193
Cornell colony-brooder houses and yards.....	194
Cornell colony-brooder house.....	196
Frame of Cornell colony-brooder house.....	197
Dr. Woods' brooder	198
An improved brooder.....	202
Heater parts for brooder.....	203
The Tillinghast homemade brooder.....	204
Hot water brooder and tank.....	205
Pen of capons.....	213
Caponizing table with weights.....	214
Position of fowl on operating table.....	215
Set of caponizing tools.....	216
Caponizing tools	217
Spoon forceps.....	217
Colony house for south shore roasters.....	221
Shaping rack and fowl.....	229
Water tank for ducks.....	238
A few Pekins on a California duck ranch.....	240
Pekin duck	246
An object lesson in duck keeping.....	247
Indian Runner drake.....	248
Toulouse gander	258
An Embden gander	259
Flock of Brown Chinese geese.....	260

	PAGE
Gray African geese.....	261
Enclosed roosting shed for turkeys.....	267
Group of Bronze turkeys.....	273
A perfect Bronze turkey hen.....	274
Pair of Pearl guineas.....	276
Mating coop for pigeons.....	278
Pigeon house and fly.....	279
Pigeon loft in second story.....	280
A five-hundred-mile record Homer.....	281
Pigeon house and covered fly.....	282
Interior view of pigeon house.....	283
Hawk trap	297
Protecting roosts from lice.....	299

CHAPTER I

Profits in Poultry

NOT A QUICK-GET-RICH SCHEME

Father: "Now, see here! If you marry that young pauper how on earth are you going to live?"

Sweet girl: "Oh! we have figured that all out. You remember that old hen my aunt gave me?"

"Yes."

"Well, I have been reading a poultry circular, and I find that a good hen will raise twenty chickens in a season. Well, the next season that will be twenty-one hens; and as each will raise twenty more chicks, that will be 420. The next year the number will be 8400, the following year 168,000, and the next 3,360,000. Just think! At only fifty cents apiece we will then have \$1,680,000. Then, you dear old papa, we'll lend you some money to pay off the mortgage on this house."

She had figured it all out like many another person has and got rich on paper, but, unfortunately, the hen died. In no line of work or business are such large fortunes made (on paper) in so short a time as in poultry keeping. Here is how an incubator manufacturer puts it in his catalog: "Suppose one starts with fifty hens, for example. If the hens are properly selected, and one year old, they should yield from twenty-five to forty eggs per day from December until June; say 245 eggs per week. These eggs, placed in incubators weekly, should insure at least 175 chicks per week, after the hatching begins. As broilers are usually marketed when three months old, one would

need to keep constantly on hand about 2000 chicks. In six months from December to June, you would market at this rate, 4200 chicks; and an average of forty cents each would make your receipts \$1680. The cost of raising these chicks, including the cost of keeping the parent stock, and of operating the incubators and brooders, would not be half that. But figuring one-half, the profit from six months' business, over all expense, would be \$840." But further along in his catalog he says: "In egg farming, the profit runs from \$1.50 to \$2.40 per hen. The raising of broilers costs about four cents per pound. The average selling price the year round is eight cents per pound. The profit on broilers, therefore, averages 100 per cent. It costs about five cents per pound to raise capons to market maturity. The profit is about \$2 per head on them." But as broilers weigh about two pounds each when marketed there is a big hole, somewhere, between forty cents each, and eight cents per pound. And thus again: "Poultry raising is the easiest way that I know of to make money. It is also the surest. The investment necessary is slight, and the risk almost nothing. There is no other line of work open to most people that pays so well for the time spent on it." That's very true, except the poultry business as a business is not easy. It's hard work 365 days in the year, same holidays and Sundays as week days.

WHERE FIGURES LIE

Again, the enthusiast who has the hen fever sits down and figures that a hen will lay 150 eggs a year (some will lay 200) which at two cents each will bring in \$3. It costs \$1 to feed her, which leaves a profit of \$2. Now if one hen makes a profit of \$2, 500 hens will make a profit of \$1000 and 1000 hens \$2000, or

10,000 \$20,000. Many poultry keepers are making this rate of profit from flocks of 500 or larger, but they have spent years in getting their knowledge and experience. The trouble with the amateur enthusiast is that he counts experience as nothing and attempts to walk before he can creep. His would-be profits go to pay the price of experience.

But the poultry business does pay and pay well to those who understand it, have mastered its details and give it the necessary time and attention. It's fun to care for a flock of twelve or fifty, but an eternal, everlasting grind to look after 500. So don't attempt poultry keeping as a business unless you will personally put in from twelve to sixteen hours every day in the year.

THE HEN AS A MONEY MAKER

The earning capacity of the American hen has never been carefully determined. Like all other lines of business, farming and stock husbandry, the results are dependent largely upon individuality of the animal and the attention given by the owner. Long experience of farmers and poultry keepers has shown that a flock of hens may be kept so as to give a return ranging from a considerable net loss on food consumed and labor, to a profit of as much as \$5 per fowl. Yet, under good average conditions, with fair fowls, suitable food and a reasonable amount of intelligent care, it ought not to be difficult to arrive at a basis which will show what a flock of hens are capable of earning.

There were entered in American Agriculturist's money-in-poultry contest, which closed April 1, 1901, over 500 contestants who sent in their reports. These came from every state and territory in the union. The flocks varied in size from ten to 500 fowls. All manner

and sizes of houses and yards were used and every condition presented which is likely to be found on this continent so that an average taken from the figures given will necessarily show what the American hen can do and is doing, under average conditions. In computing these results, we used the records of 305 poultry keepers who supplied all the figures called for in the record, the others being incomplete in some one or more details.

The contest year was started with 24,345 fowls, and closed with 27,268, there being a gain during the year of 2923. As these represent almost entirely pullets hatched during the spring, they affect the income only part of the time—that is, after they reached maturity and began to lay, which we have assumed at eight months of age. Therefore we have added one-third of this increase to the original number and figured that 25,340 fowls were the number kept during the year. There was invested in these fowls, in the poultry houses, yards, fixtures, etc., the sum of \$43,987.52, or an average investment of \$1.81 per hen. Figuring that each hen is worth about fifty cents, there would be required an investment of about \$1.30 in the way of buildings, land, etc., to keep her. During the year there was expended for food and supplies, which includes grit, green bone, condition powders, medicines and the like, \$23,712.34, or ninety-four cents per hen. This is very close to the usual estimate of \$1 per year as the cost of keep of a hen.

An accurate account was kept by each contestant of the amount of time expended in the care of poultry and a fair valuation was placed upon this, which amounted to thirty-four cents per hen per year, or \$23.96 per flock, there being an average of sixty-nine fowls in each flock. During the year these hens laid an average of eighty-two eggs each. The best record

was an average of 247 eggs from a flock of twenty Rose Comb White Leghorns by a Connecticut poultry keeper; the smallest from another Connecticut poultryman who obtained 485 eggs from forty-nine fowls, or about ten eggs per hen per year. While this average record of eighty-two eggs per hen may seem small, it must be borne in mind the number of fowls given also includes the roosters, which would make a slight difference in the average yield.

The eggs sold for \$1.15 per hen, showing a fair profit on eggs alone over cost of feed. A considerable portion of the income was derived from the sale of poultry, either young stock or the original fowls, which were turned off and replaced by young stock raised during the year. This amounted to \$17,118.81, or sixty-eight cents per hen. Making no estimate for stock raised, but charging the entire food cost to eggs, makes the eggs cost 41.15 cents each for food consumed, but as nearly one-third of the food used was consumed by young stock, the net food cost per egg was about three-quarters cent each. This must, of course, vary largely with locality, as food costs more than double in some sections what it does in others. It can safely be assumed, however, that the food cost of eggs is in the neighborhood of one-half their market value.

The total receipts per fowl amounted to \$1.95 each, leaving a profit of \$1.01 over cost of feed and sixty-seven cents net over cost of food and labor. This gives a net income of \$46.23 per flock and a gross income of \$135.40. The gross income is actually much nearer the profit derived from the fowls in the contest than the net figures, for nearly all the labor given was that employed at odd intervals, which would otherwise be of small value, while a good proportion of the food was that produced on the farms and gardens, or refuse from the table which would otherwise go to waste. As

a basis for future figuring in the poultry industry, a cost of food of \$1 per hen and a return over feed of \$1 are pretty safe figures to tie to. The cost will vary largely from year to year, or in different localities, depending largely on the price of grain and other feeds. These figures from the contest are briefly summarized as follows:

INCOME AND PRODUCTION OF AN AVERAGE HEN

Eggs laid in a year.....	82
Value of eggs sold and used.....	\$1.15
Value of chickens sold.....	.68
Gross income.....	1.95
Cost of food.....	.94
Cost of labor.....	.34
Profit over food cost.....	1.01
Net profit.....	.57
Investment, including hen, buildings, etc.....	1.81

GETTING EGGS IN WINTER

Some valuable results are gleaned from the winter egg laying contest conducted by Farm and Home, from November 1, 1906 to April 1, 1907. There were 117 contestants, living in all sections of the United States who kept 7040 fowls in 136 flocks. With the exception of three flocks, whose owners were sick part of the time, all showed a profit from the sale of eggs laid during the five months. The general average was sixty fowls per owner which laid forty-two eggs each, that sold for ninety-five cents. The food cost was thirty-eight cents each, leaving a profit of fifty-seven cents per fowl.

Taking all points into consideration, the age of the fowls and the manner of housing seem to have

the most influence on the results obtained. Pullets gave far greater returns than either hens or flocks consisting of both pullets and hens. The results from the pullets were fifty-two eggs each which brought, at market prices, \$1.19 per fowl. The hens averaged forty-six eggs each which brought ninety-six cents. The cost of food was practically the same with each. The pullets made a profit of nearly fifty per cent greater than the hens.

The best results were obtained in warm houses (those thoroughly built but without artificial heat) and in houses with a curtained roosting room, the profit being the same in each case. The scratching shed style of house ranked next.

This contest was the most successful of the kind ever conducted and the results were so strong in some directions that we may safely draw some definite conclusions as follows:

Pullets produced the most eggs and the greatest profit.

Poultry houses should be warm or at least there should be a warm sleeping apartment for the greatest egg yield and the highest profit.

The rations should consist largely of whole grain fed in a deep litter of straw or other scratching material. There seems to be no advantage in feeding a warm mash. Better results are obtained by feeding the mixed ground grain dry in a hopper or box to which the fowls can have access at all times. There is no danger of their eating too much of this.

The breed is not so important as the feed and care. Well matured pullets, comfortably housed and well fed have got to lay in spite of themselves. Preference should be given at all times to well bred stock, because there is an added return in the sale of eggs

or fowls for breeding purposes or, with American and Asiatic breeds, in the greater weight of market poultry.

CONSERVATIVE AND ACTUAL PROFITS

A profit of \$1 per hen a year may be counted on as reasonably as you can estimate profits in any business, by one who will give the fowls necessary care and attention. There are scores of people who are making a good, comfortable living keeping 200 or 300 hens, producing eggs for market, raising the pullets each year and dressing and selling the cockerels. It does not require much capital for a start, but one should have enough to get through the summer and fall in easy circumstances and take into consideration that 600 or 700 chickens will eat a good many dollars' worth of grain while growing. Here is what some poultry keepers have done and are doing:

From our experience with fowls and cows, without counting the expense of either, we had decided that twenty-five hens would pay full as much profit as a cow and with less labor. An accurate record showed us that the hens brought an average profit of \$1 each.—[Mrs. J. L. Marvin, Rensselaer County, N. Y.]

Last year I kept an average of 144 hens, starting the year with 143 hens and pullets and closing with 145. The monthly financial record is as follows:

FINANCIAL STATEMENT OF THE FLOCK

	Income	Cost of feed	Profit
January	\$37.16	\$17.88	\$19.28
February	40.21	13.00	27.21
March	42.36	10.25	32.11
April	46.30	8.45	37.85
May	39.39	6.30	33.09

	Income	Cost of feed	Profit
June	29.06	8.90	20.16
July	19.96	10.00	9.96
August	22.08	9.40	12.68
September	19.38	11.00	8.38
October	22.32	10.75	11.57
November	18.00	10.90	7.10
December	28.18	10.75	18.43
Total	<u>\$365.40</u>	<u>\$127.58</u>	<u>\$237.82</u>

From the total profit should be taken \$7 for stock bought and \$12 for eggs and oil used for hatching, which leaves \$218.82 as the exact profit for the year. Chickens consumed by family were not counted. No account of time was kept. I hatched 300 chickens, but raised only seventy pullets and about eighty cockerels. Fifty died from wet, cold weather when from one to two weeks old, and the rest disappeared gradually until they were shut up for the winter. Fifteen disappeared after they had been housed.—[M. C. Harris, Massachusetts.

The sweepstakes prize of \$200 in American Agriculturist's money-in-poultry contest was awarded to Mrs. Leonard Johnson of Radnor, Pa., not because of the greatest profit, but because her report complied the closest with the rules under which the contest was held. She lives on a place of one-fourth acre, and keeps a small flock of mostly White and Barred Plymouth Rocks. She began the record year with sixty-three hens, two males and eighty early-hatched chicks, and closed with twenty-eight hens, two males and sixty-two pullets. The hens laid during the year 5828 eggs, which sold for \$149.18. Those used and set were worth \$5.90. She sold 126 head of broilers and old fowls for \$100. The hen manure, feathers, etc., brought the

total receipts of the flock to \$267.59. The feed, nearly all of which was bought, cost \$88.78, labor was worth \$27.48 and other incidental expenses brought the total expense to \$121.21, leaving a profit of \$146.38, to which should be added a gain of \$18.04 in added value of stock at the end of the year and of \$17.92 profit on eggs and poultry bought and sold to customers. This, with the pay for her time, brings Mrs. Johnson's income close to \$200, and that from a small flock which were cared for largely at odd moments. An interesting comparison of the egg and hatching records of her flocks for seven years is here given:

LAYING AND HATCHING RECORD FOR SEVEN YEARS

	1900	1899	1898	1897	1896	1895	1894
Number hens....	50	90	110	113	85	70	36
Eggs laid, dozen.	507	952½	846	1030	727	653½	257½
Number per hen.	121½	132½	101	104	103	112	100
Income per hen..	\$2.78	\$2.89	\$1.73	\$1.78	\$1.72	\$1.98	\$1.92
Cost feed per hen	.80	.80	1.00	1.00	.60	.55	.70
Eggs set.....	370	236	1039	824	1080	276	374
Eggs hatched....	116	139	686	554	680	200	127
Per cent hatched	52	56	66	67	63	72	69
Chicks raised....	69	70	*280	130	175	170	93
Per cent raised..	60	50	67	28	25	85	49

I began with 100 chickens at New Year's, and at New Year's a year later had 185, besides eating sixty-six and selling \$16 worth at prices ranging from fifteen to twenty-five cents each. Also sold \$103 worth of eggs, after eating all we could. Did not pack any eggs, but sold every week at market prices, which were as low as six cents a dozen for a while in the summer, and eighteen cents was the highest price I got in winter. My flock is just a scrub flock.—[Mrs. J. Sykes Wilson, Davison County, S. D.]

A profit of \$2.67 per hen was made by W. H. Pearson of Cumberland County, Me., who started the year with seventy-five Barred Plymouth Rock hens, and closed with eighty-five. The receipts from 11,594

*Sold 250 newly hatched chicks.

eggs sold were \$236.91, and from 498 chicks and fowls \$148.87. The total cost of feed and of eggs for setting was \$153.15. During the early part of the season, a good many of the eggs were sold for hatching at three cents apiece, but the rest went at market prices.

A very high price for pure-bred poultry often yields a big return to the one making the investment. A Maine carpenter, who by accident was unable to work at his trade, invested \$15 for a trio of turkeys. From the two hens he raised 122 turkeys, most of which he sold at \$2 to \$5 each for breeding purposes and the remainder at \$1.25 per head for market. Another breeder paid \$50 for a Brahma hen and her brood of chicks. In less than a year he sold \$300-worth of stock and eggs.

A Living from Poultry and Bees can be made on a small plot of ground but the person must study to learn the conditions of success and then faithfully carry them out in detail. His plant must be large enough to give him constant employment and he should have a taste for the work so that instead of its being onerous to him he will enjoy doing it. In this business as in any other what leads to success is a large capacity for painstaking work. On my little farm in the village, I have four large poultry yards. In these yards are planted small fruit and apple trees, which make a shade for the hens and furnish me with fruit for family use and for market. In each yard, as fast as they increase, I shall set twelve or fifteen hives of bees. These do not in any way disturb the hens, and with good management are a source of considerable profit. I have been able to pay for my farm and many improvements upon it, besides saving some money, because our poultry have nearly made a living for my little family, so we could save about all the receipts from my special money crops grown on the farm. Our poultry and

bees and the three acres on which strawberries and celery are grown for market, I know are more profitable to me than would be a good dairy farm of 100 acres.—[W. H. Jenkins, Delaware County, N. Y.

Keeping Poultry for Pin Money—I am a farmer's wife and in the spring of 1899 I determined to find some way to get "woman's pin money." I decided to turn my thoughts to poultry. I set a good many eggs from White and Barred Plymouth Rocks that were on the place and bought some others of different breeds. The result was 240 chicks, some of which were sold for broilers, and some the crows carried off, so that I had 100 pullets and five old hens in the fall. I put twenty-eight in an old henhouse and the remaining seventy-two in an underground cellar. I fed a warm mash through the winter and gave them good feed and care. I closed the year with 140 hens on hand. They laid during the year 12,129 eggs, which brought \$266.60. Stock sold brought \$29.35 and sixteen barrels of manure \$12, making total receipts \$307.95. Feed and supplies cost \$122.95, labor \$25.50, birds bought \$2.20, making total expenses for the year \$150.65, which left a profit of \$157.30, to which may be added \$48.33, gain in inventory value from increased number of hens.—[Mrs. D. McDonald, Connecticut.

WHO SHOULD ESSAY THE POULTRY BUSINESS?

It often strikes me as a part of the irony of life, that the two classes who seem most eager and determined to try their hand at poultry are those who have no income whatever, and those who already have an assured and ample income. These, it seems to me, are just the two classes to whom poultry insures most risk, with least prospect of satisfaction.

At first glance, this idea may seem paradoxical. It is not so, however, because the reasons which render the business an uncertain venture to the one class are an entirely different set from those which render it an unwise opening for the others—just as their object in attempting it is different. Those who know anything at all about the risk, the difficulty, the anxiety, the work connected with poultry raising as a means of support, will need no words to convince them of the folly of entering upon this work without capital, experience, or means of support while the latter is being acquired. Yet it is the poor in our cities, who are straining their eyes for some means of getting a bare living, who are the most frequent inquirers—at least that has been my experience.

It is just because the farmer has his living assured, whether the poultry flourish or die; and it is because the wife and children can put into the work time which has no commercial value, and which is not the one thing which stands between the family and absolute starvation, that the farm is pre-eminently the place for poultry raising. This wholly aside from the patent fact that here, of all places, is room to give the flocks proper chance for full and best development. The farmer's family are of all the people in the world best fitted in every direction for this work.

Those who live on the farms, yet still believe that there is no money in poultry, or who believe that it needs someone with ready money to hand to make poultry really pay, should consider one fact which they almost invariably overlook. This is, that the man with an income and no farm must spend that income in acquiring the things which the farm furnishes; and if he throws up a paying job of any sort to keep poultry, that poultry must pay him a surplus equal to that which he before received, and which was his own

value, ere the word profit can be applied to it at all. Thus, it may not count for much if a man's flock of fowls is paying him a profit of \$800 per year; if he has given up a position which paid him \$1000, he is raising poultry at a loss. That is, this is the case, unless his other work was an injury to his health, or he gets sufficient pleasure, or profit (if it is "profit" to him) in some side line to make up the difference to him.— [Myra V. Norys in Farm Poultry.

STARTING IN THE POULTRY BUSINESS

An inquiry comes to our desk: "How much does it cost per hen per year, and what is a reasonable percentage of profit on an investment in the egg and broiler business?" It is assumed that the party asking that question has sufficient capital to start, but knows nothing about the business. Probably he has been building air castles; has figured out on paper the huge profits that will eventually make him wealthy. Or, on the other hand, he may be a man of limited capital and wants to begin right.

There are two classes to whom satisfaction cannot be given: The first, those who have a lot of capital and no experience, and who want to begin on a gigantic scale. The second, those who have a limited capital and no experience, and who cannot afford to begin on a small scale, as they want to make a living from the start. A successful poultry farm must grow. It must be started on the ground floor. Capital is necessary, but capital without brains will be useless. "Money and fools soon part."

To get to the question: "How much does it cost per hen per year?" An estimate for years accepted by the poultry fraternity has been that it costs \$1 a year to keep a hen, and that \$1 a year is the

average profit per hen in well-managed flocks. We do not know exactly how these figures were reached but we do know that if they were true twenty years ago they are somewhat changed today.

For the past eight years, we paid special attention to our feed accounts. Eight years ago we bought meat, cracked corn, oats and other feed at about one-half what we are paying today; but on the other hand, the market prices of eggs and broilers are almost a third better than they were then. Carefully kept accounts show that, taking into consideration the rise and fall of the prices of feed, as well as the prevailing prices of the market, it has averaged us—for the past eight years—ten cents per month per head, making a total of \$1.20 per year for each fowl.

As for receipts, we have found that, allowing fifty cents as the average price for the full two-year-old hen, when sent to market, we have made a profit of a little over \$2 per head (for two years) as a general average. We have done even better with some hens, especially with those which laid from 120 to 150 eggs a year. We had records of 180 and even reached the 200 mark, but our average egg yield for the entire farm was 100 eggs per year. So here are the figures:

Two hundred eggs were laid in two years by the hen. At the average price of two cents each, the receipts were \$4. At the close of her second season we sold the hen in market at fifty cents and this put the total receipts at \$4.50. It cost us \$2.40 to feed that hen two years, so that amount must be taken off the receipts, and this gives us a clear gain of \$2.10 on each hen. This was from an average of 200 head of stock.

Now at this point the novice is very apt to jump to conclusions. He will reason: "Here are figures showing that there is a profit of \$2 per head. One

thousand head will make \$2000—just the income that I want.” And that is just where he is making a great mistake. In the first place, no one man, not even an expert, can properly take care of 1000 hens. Consequently, he will have to hire labor. To keep down the expense he will naturally hire a cheap, inexperienced man. This man’s ignorance of the business, coupled with the lack of practical knowledge on the part of the owner, will soon be the origin of a multitude of mistakes and final failure. The cheap man will be a dear one.

If an expert is employed, it will be necessary to divide that \$2000 profit with him, and as this would mean that the hired man was getting as much money as the owner, and did not have the risks to run, it would not be long before the arrangement would be cut short, and the owner, who by this time probably has had a little experience, is now at that stage when he thinks himself fully capable of doing the work himself “just as good as this costly man”—and in less than a year the plant is for sale. In the second place poultry in large numbers do not receive the proper care. In small lots they are divided up into families in separate runs. The successful poulterers seldom run more than fifteen head in a flock. There is no crowding in consequence, the condition of the stock is noticed each day and the little details of the business are not neglected. All these matters go to making success.

On a large farm it is utterly impossible to give it that attention and the result is mistakes after mistakes will happen, disease will get a foothold, and loss instead of gain will be the outcome. This is not hastily written. It comes from years of experience and close observation. Right here in Hammonton, N. J., where poultry farms sprung up right and left, where the gigantic broiler boom started, where attempts at

poultry culture in every line were begun, and where, at one time, fifty poultry plants were operated—today but ten successful ones remain, and forty monuments are erected to the memory of men who overestimated their ability and capacity.

Yet, with all that, the fact cannot be disputed that a good, honest living can be made on a poultry farm, but when we say "living" we do not call for professional incomes. We mean the equal of the wages received by the average mechanics. Our observation has taught us that 300 hens, properly cared for, and the egg crops partly used for broilers, will be more profitable than a larger concern, excepting probably 500 hens kept for egg farming exclusively.

It costs about fifteen cents a pound to produce a marketable broiler, and the average profit on a broiler is about ten cents a pound. Where part of the time is to be consumed in broiler raising, not more than 300 hens should be kept. This will give all the work a man and a good boy can perform. That number of hens would run from three to five 200-egg incubators steadily and leave a large lot of eggs over for market purposes. Three hundred hens would lay from 100 to 150 eggs a day. To run three 200-egg incubators steadily would require about thirty eggs a day, leaving from seventy to 120 left for sale in market.

Three 200-egg incubators run regularly should produce from 300 to 400 chicks every three weeks. These, however, will not all be raised to broiler size, but supposing that only 100 pounds can be marketed each week, there would be an income of \$10 a week, clean money. Also, supposing that only seventy eggs a day could be sold, that, at an average price of two cents each, would give \$9.80 a week. Therefore, we are safe in saying that from \$15 to \$20 a week can be

made from 300 hens, when the egg and broiler business is combined, and when it is rightly managed.

To erect a plant sufficiently equipped to carry on a business like that just mentioned, will require about \$1200 for hen and brooding houses, incubators, brooders and general supplies, and it would cost, in addition, from \$1.50 to \$2 per head for the poultry. Three hundred head at \$1.50 would need \$450. This would give a total cost of \$1650, but there must be money for feed and money to pay the hired boy, as well as money to maintain the owner. We should not advise the attempt to be made with a capital less than \$2000. It will take several weeks before the hens become reconciled to their new quarters and start in laying, and it will take another several weeks until the machinery etc., can be arranged for incubation, and the hens give enough eggs to start the incubators. Then it will be three weeks before the first hatch, and from fourteen to sixteen weeks before the first shipment of broilers.

The income, however, will begin on a small scale after the hens have started in to do steady laying—say, a month after being domiciled—and it will keep them busy for a week to fill the three machines. Then, after that, say, the sixth week after starting, there will be table eggs for sale. All these matters have to be fully considered before starting.

Now, in all this, we are assuming that the man knows his business, for a novice could not secure this success without experience. Therefore the best plan is to begin in a small way. Start with 100 hens and one incubator; next year make it 200 hens and two incubators; and the third year 300 hens and three incubators. In this way the work can be gradually done, and the experience will come in the same way. In running three incubators it would be best to start one each week, and in that way, after rightly started,

there would be a hatch due and a batch of broilers marketed each week. It would keep the machinery moving nicely.

If this work is carefully mapped out, and worked with a system, we certainly can predict a good, honest living for a good, honest man (or woman).—[Michael K. Boyer in American Poultry Journal.

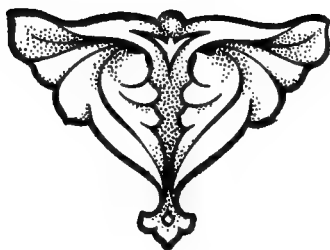

CHAPTER II

The Care of Poultry

THE COST OF PRODUCING EGGS

There is as much difference between hens as there is between dairy cows, is the result of a co-operative test made by the Cornell experiment station of New York in the cost of producing eggs. This experiment was started in December, 1901, and carried on for four months. The tests were continued during the winter of 1902-3, under the direction of Prof. H. H. Wing, and the result shows a great similarity in many respects with those of the first year. Eleven flocks in various parts of the state, in which were included 3133 hens and pullets, participated in the experiment.

The food was reckoned at a uniform price, as near as possible to the actual cost to consumers. The fowls were credited for the eggs on the basis of highest weekly New York quotations for fresh eggs. The experiment began December 1 and closed March 28, and was divided into four periods.

A careful study of the figures presented by Prof. Wing shows that the cost of eggs is influenced more by the individuality of the fowls than by the food used. The difference in the cost of food for the flock that produced the eggs at the lowest cost and that which produced eggs at the highest cost was only four cents per 100 fowls. The flock fed at lowest food cost ranked among the highest in cost of eggs; on the other hand some of the fowls that were fed at a relatively high cost produced eggs the cheapest. There was no marked difference between the number of eggs

laid by hens and pullets. The following table shows the breed and age of fowls, cost of eggs produced, percentage of eggs laid and cost of food consumed:

COST AND PRODUCTION OF EGGS

Breed	Age	Food Cost per dozen Eggs	* Eggs laid	† Cost of Food
White Leghorn.....	pullets	8.5c	38.	\$32.06
White Leghorn.....	pullets	8.7	36.1	31.28
White Leghorn.....	pullets	9.3	34.1	31.63
Mixed	pullets	10.2	34.9	35.61
White Leghorn.....	pullets	11.	28.6	31.30
White Leghorn.....	pullets	11.2	26.8	30.
Mixed	mixed	11.3	34.9	39.07
White Leghorn.....	mixed	13.6	26.8	36.16
White Leghorn.....	pullets	13.5	29.9	40.31
White Leghorn.....	pullets	14.2	24.1	33.91
White Leghorn.....	hens	14.6	21.6	31.26
Plymouth Rock.....	pullets	16.2	30.8	49.51
Mixed	mixed	16.3	17.7	28.62
White Leghorn.....	hens	16.4	24.8	40.36
White Leghorn.....	pullets	16.7	18.6	30.84
White Leghorn.....	hens	17.3	18.5	31.66
Mixed	pullets	17.6	18.1	31.71
Black Minorca.....	pullets	17.6	21.7	37.92
White Leghorn.....	hens	18.1	17.2	30.86
Mixed	hens	18.7	19.2	35.64
White Leghorn.....	hens	19.5	16.	31.02
Brown Leghorn.....	hens	20.3	14.6	29.46
Brown Leghorn.....	pullets	20.5	20.6	41.88
Black Minorca - White Wyandotte	mixed	23.3	19.4	44.78
Mixed	mixed	21.1	9.5	17.58
Plymouth Rock-Wyan- dotte	hens	30.	16.6	49.38
Black Minorca.....	hens	32.	16.3	51.94
Black Minorca.....	pullets	32.1	16.4	52.20
Black Minorca.....	hens	33.9	9.3	31.32

Reducing Cost of Eggs—Eggs have cost me the most when I have kept the hens too much on grain rations. I believe I can reduce the cost of eggs nearly one-half by feeding less grain and in its place giving cut clover, cut meat and bone and vegetables both cooked and green. Feed them the morning mash of bran middlings and corn meal but only enough to partly satisfy them. Keep the cut clover and meat in boxes so made that they cannot get in to scratch them out; also shells and grit. Cover a little small grain with litter to induce them to exercise and make the house warm and light.

*Per 100 fowls per day. †Per 100 fowls for 17 weeks.

Do not overcrowd. In my own rooms which are thirteen feet square I can get more eggs in the winter from fifteen hens than I can from forty and save more than half the expense for feed. I keep no cockerels among my laying hens, where eggs are sold for consumption, but keep one in a room of thoroughbreds whose eggs are wanted for incubation.

I want no hens older than two years and I want pullets hatched in March and April, so they will commence laying in the fall. I want no stock that when well fed and cared for is not in condition to lay eggs in the winter. To further widen the margin of profit I try to market my eggs where I can get above market quotations for them, and I certainly cannot afford to sell eggs at the country stores when I have fine stock.

Keep the breed of hens that lay the kind of eggs your market demands and grade as to size and color, then pack clean, strictly fresh eggs and ship them to a reliable grocer or commission dealer, and you can soon establish a trade for fancy eggs at fancy prices.— [W. H. Jenkins, Delaware County, N. Y.]

English Laying Competition—Every year there are two poultry clubs in England which hold open laying competitions. Four pullets of the present year's hatch are penned for a period of sixteen weeks beginning October 16 and ending February 4. These are placed under the management and control of one man, who does all the feeding, etc. The reports of a recent contest by the Utility poultry club and the Burnley society are here given:

UTILITY POULTRY CLUB LAYING COMPETITION

No. Pen	Breed	Eggs				Total		Order-merit
		1st mo	2d mo	3d mo	4th mo	Eggs	Points	
1	Buff Orpington	17	18	28	9	72	144	15
2	White Leghorn	—	17	50	43	110	220	9
3	Buff Orpington	20	7	28	38	93	186	12
4	White Leghorn	13	44	17	31	105	208	11
5	Buff Orpington	24	54	44	42	164	328	3

No. Pen	Breed	Eggs				Total		Order merit
		1st mo	2d mo	3d mo	4th mo	Eggs	Points	
6	White Leghorn	24	65	50	46	185	362	2
7	Silver Wyandotte	20	15	41	48	124	244	6
8	Minorca	11	33	9	34	87	172	14
9	Golden Wyandotte	65	44	36	55	200	397	1
10	Minorca	—	1	—	33	34	68	20
11	White Wyandotte	20	13	15	66	114	222	8
12	Buff Leghorn	4	15	43	51	113	223	7
13	Barred Rock	—	16	23	19	58	115	17
14	Ancona	—	3	16	50	69	136	16
15	Buff Rock	28	5	34	40	107	213	10
16	Ancona	30	52	18	43	143	281	5
17	Black Rock	3	16	12	20	51	100	18
18	Ancona	—	18	28	44	90	178	13
19	Faverolles	—	3	17	15	35	70	19
20	White Leghorn	40	44	37	43	164	328	3
Total		319	483	546	770	2118		

N. B.—In scoring, an egg weighing up to 1¾ ounces counted one point; above that weight, two points.

The Burnley society reckoned one point for an egg weighing up to one and one-half ounces; above this weight two points. Each soft-shelled egg was disqualified. In previous competitions of the Utility club, the prizes in 1897-8 went, first to Black Minorcas, which laid 161 eggs; second, to Black Minorcas, with 149 eggs; third, to Langshans, with 146 eggs; in 1898-9, Buff Leghorns, 154 eggs; Barred Rocks, 146 eggs; Golden Wyandottes, 133 eggs; in 1899-00, Silver Wyandottes, 223 eggs; Golden Wyandottes, 161 eggs; Buff Orpingtons, 151 eggs; in 1900-1, Barred Rocks, 127 eggs, Buff Leghorns, 81 eggs; Lincoln Buffs, 73 eggs.

BURNLEY SOCIETY LAYING COMPETITION

Hatched	No. Pen	Breed	Eggs				Points	Order merit
			4 wks	8 wks	12 wks	16 wks		
March 1	1	Buff Orpington..	23	62	107	127	254	5
April 2	1	Buff Leghorn	40	73	99	130	260	4
April 3	1	Silver Wyandotte	49	101	159	201	402	2
April 4	1	Brown Leghorn..	—	20	70	114	227	6
April 5	1	Barred Rock	23	84	128	173	346	3
April 6	1	White Leghorn	6	28	47	76	152	8
April 7	1	Ancona	—	—	27	64	128	10
April 8	1	Buff Orpington	19	80	161	210	420	1
April 9	1	Buff Leghorn	6	22	49	92	184	7
April 10	1	Buff Orpington	—	12	33	72	144	9
			166	482	880	1259		

HOW TO GET EGGS IN WINTER

If the hens have comfortable houses and plenty of food, they will scarcely know it is winter. The natural conditions under which hens will lay must be looked into, and we find these to be a mild temperature, variety of food, and plenty of exercise. Under such conditions hens will lay, because they can't help it—and if we produce such conditions in winter, we will surely get eggs, especially from early hatched pullets.

The first requisite is comfortable houses, which may be designed according to fancy, but should open to the south. The house can be made warmer by the addition of building paper or plastering the room, which should be whitewashed at least twice a year. A good tight floor is desired, one through which no drafts can enter. Always bear in mind while building that your house must be free from drafts, and warm, so warm that water will not freeze in it. The hens must be kept comfortable and dry, with some place to exercise, and plenty and a variety of good nourishing food that will go to aid in creating eggs.

An egg is composed of all the elements that sustain life, and unless the hens are supplied with these elements, they can no more furnish eggs than a cow can furnish a large supply of milk on insufficient food. Not only is the carbonaceous material required for the yolk, but the nitrogenous matter composing the white of the egg is essential. Wheat and oats come nearer furnishing a perfect food than any other grains, because they not only furnish the elements named, but also mineral elements which must also be supplied. Clover (and alfalfa) has now come to be recognized as an excellent egg producing food, as it is rich in lime and other egg forming materials. In the winter this can best be fed by chopping into short lengths, place in a tub or

bucket, pour boiling water over it, and allow to stand till morning. Mix with bran, shorts, meal, a little salt, and feed warm. Oats should be scalded and fed same as clover, as the sharp points of the oats in the dry state are likely to injure the fowls. Wheat can be scalded or fed dry in scratching pens; and note the pleasure it gives the hens with their bright red combs, merrily singing and scratching for grain. Chopped clover is an ideal litter for scratching pens, as it furnishes food also. The chaffy fodder and shelled corn picked up where corn has been "shredded," makes good litter also, the fodder supplying green food, as they will eat much of it.

Feed plentifully of green food. A cabbage head hung up every day where the fowls will have to take exercise in jumping to reach it; small potatoes and turnips chopped and fed raw, or together with all parings, cooked and mixed with morning or evening mash, will supply green food. All kinds of roots such as mangels, sugar beets, carrots, etc., are excellent. Keep charcoal and gravel mixed with lime by them all the time. An occasional mess of parched corn is feeding charcoal in a valuable form. Mashed or cut bone and meat scraps should be fed to take the place of bugs, etc., which is one of the natural foods in summer. Milk, acorns and all nuts are valuable as food. Supply plenty of water that has the chill removed. Fowls will drink lots of water if it is where they can get it; as the egg contains some water, it is necessary that the fowls have plenty.

The large breeds require somewhat different treatment from the small fowls. Being large and heavy, they are naturally inclined to be indolent and inactive, so the more necessary to devise means to make them exercise, the exercise helping in digesting their food, and keeping them warm, which is an important factor

in egg production. By no means keep the lazy hens of any breed, for a lazy hen is not a good egg producer. Keep the ones that molt early for winter layers, and avoid crowding. Hens having the range of the farm do not need as much attention as those confined in pens. Do not leave chickens to shift for themselves until the cold bleak days are here, but give them attention all the time (they do not need so much during the warm months when nature supplies their wants), especially during the molting season, when they need plenty and a variety of good wholesome food to supply the extra demand made upon them. At all times endeavor to keep the hens busy, comfortable, happy and cheerful.

Every successful poultry keeper has worked out a way of feeding and care which is best for him. He might not be successful with the methods which bring good results for another. The following plan of feeding has been quite satisfactory with one good poultry keeper who makes his living from hens. He says: "I mix bran middlings and corn meal in about equal parts, putting in a tablespoonful of ground bone to every two quarts, and season the mash with a little salt and pepper and wet up the mixture with hot milk, when I have it. In the morning, I feed this mash to the hens, and give them only what they will eat up at once, but not enough to quite satisfy them. I then scatter a few handfuls of grain, using wheat, oats and buckwheat for a variety, on the floor, and cover it with leaves, chaff, or other loose litter. This is done several times a day to induce the hens to scratch for the grain and thus get plenty of exercise. In the coldest weather, I feed them boiled corn at night. I give them warm water to drink and keep cut clover, meat and bone, grit and shells in boxes so made that they cannot get into them to scratch them out. I hang up cabbages and

chop up the celery trimming to keep them supplied with green food. I try to give them the kind of food that hens naturally seek when on a large range in summer. Then furnish them a warm house and make them work for a part of their living."

Egg-eating is a habit more easily prevented than cured. Give the hens plenty of exercise, with a variety of food. Gather the eggs frequently, provide sufficient nesting places and keep one or more porcelain eggs upon the floor of the house. Dark nests are advisable, and a meat diet is excellent. To cure the habit provide dark nests and add meat to the food. Remove one end from several eggs and pour out the contents. Make a mixture of flour, ground mustard and red pepper, adding a little water to hold the materials together. Fill the shells and place upon the floor of the henhouse. The hens will make a wild scramble for these prepared eggs, will gobble down some of the contents, and will soon be gasping with open beaks. Follow up this treatment until the hens refuse to touch an egg. It seems, and perhaps is somewhat severe, but no permanent ill effects will follow. The hens will soon learn that eggs are not so palatable as they regarded them, and will desist from the bad habit. Positive cures have followed this method. Another is to cut off the end of the upper beak, making it blunt by paring back near the quick. Probably the best way to prevent egg-eating is to use one of the simple automatic nest boxes that are now becoming so popular. These nest boxes are necessarily dark. Only one hen can get in at a time, and after getting in the hen can only get out into another compartment. Once here she cannot get back to the egg. It would take a pretty clever hen to beat a mechanical contrivance of this sort. With dark nests there is no temptation to scratch and eggs seldom get broken. If they do get broken it is so dark

that there is little likelihood of the hen eating the egg before it is discovered and removed. It is a wise plan to collect the eggs on each of the regular trips through the poultry house and to put them in a place of safety where they are not likely to be broken.

Brown vs. White Eggs—Why are brown eggs more salable than white ones? Most people will answer, because they are richer. How many people blind-folded could tell the difference in taste between a white egg and a brown one? I doubt if it could be done with more accuracy than one can call heads or tails to a properly tossed coin. An interesting experiment was recently carried out to test the physical and chemical composition of eggs. A large number of breeds were chosen, and several hundred eggs dealt with. The brown eggs were laid by Cochins, Dark Brahas, Black Langshans Wyandottes and Barred Plymouth Rocks; the white ones by Brown and Buff Leghorns, White and Black Minorcas, and the tests showed the following:

PHYSICAL DIFFERENCE BETWEEN BROWN SHELLED AND
WHITE SHELLED EGGS

	AVERAGE	Brown	White	All the eggs
Weight (in grains)	59.4	62.9	61.3	
Length (in inches)	2.27	2.27	2.27	
Width (in inches)	1.69	1.76	1.72	
Specific gravity	1.082	1.058	1.070	
Number eggs to pound	7.67	7.32	7.50	
Shell (per cent).....	10.70	10.92	10.81	
	Edible portion	Per cent	Per cent	Per cent
Yolk	31.76	33.18	32.47	
White	57.54	55.90	56.72	
Total edible parts	89.30	89.08	86.19	
	THE CHEMICAL COMPOSITION SHOWN	Brown	White	All the eggs
		Per cent	Per cent	Per cent
Water	11.84	11.92	11.82	
Protein	10.77	11.22	11.00	
Fat64	.67	.66	
Ash	10.70	10.92	10.81	
Shell				
	99.52	99.52	99.47	
	670	690	680	
	Calories	Calories	Calories	
Food value per pound	64.57	64.79	65.18	

The food value of the white shelled eggs was therefore slightly the greater. Taking all points into consideration, there is nothing to choose between them in physical or chemical properties. Yet who will make the average householder believe it? The brown shell is thought to be richer than the white shell; it has been held so for a number of years. They look prettier on the breakfast table, and that always bears weight; but there is no ground for believing that the white are less rich than the brown. The Boston market will pay a premium for brown eggs; New York for white ones.

THE SEX OF EGGS

The story is told of an English farmer who asked his wife to pick out a sitting of eggs. She chose medium size, good shaped eggs, but he rejected all, saying: "Them's cockerels, Martha." Instead he picked out all round eggs. They hatched eleven chicks—all cockerels.

Another English poultry keeper, who has been working on this subject for several years, thinks he has at last discovered a way to insure a large proportion of either pullets or cockerels, as may be desired. He has given up all idea of being able to determine the sex by the shape of the egg, size of air cell, time of day it was laid or any external characteristics. He now thinks the sex of the egg is determined at the time of sexual contact and that there are two elements or forces which unite, a positive from the male and a negative from the female.

Where the predominating force is positive, a male will result, and vice versa. To test this he mated in April a very vigorous cockerel with two hens which had laid all winter, with the object of getting cockerels. The hens had worked hard for some months and the

conclusion was that they must be more or less weakened by it. Thus was obtained a condition which pointed to a preponderance of the positive element, and the result was about eighty per cent cockerels.

To further test this matter, six pullets, in the pink of condition, were put in a pen by themselves and every afternoon a two-year-old cock, which all the rest of the day was running with forty hens, was placed with them. This mating resulted in eighty per cent of the chicks coming pullets. Similar matings have been practiced by American breeders for some years, and they have been able to obtain a large per cent of pullets or of cockerels, but not always as high as eighty per cent as here mentioned.

A new idea in breeding for sex is advanced by Arthur Wulff according to the following translation from the German *Geflügel Zeitung*: Of greater value than the statistics of the human race is the record (well supported by documentary evidence) of our most important animal—the horse. The considerable size and costliness of the individual, the consequent easy determination of identity, the long period of gestation, the birth of (invariably) but one young at a time, and especially the careful registration of the stallion's "visits," combine to furnish weighty material, from which we draw the conclusion that foals in cases where the mare has been "covered" in the evening (that is after the stallion had been previously used during the day) will generally follow the sex of the mother.

We do not know whether this fact, which is no doubt capable of a plausible explanation (the older seminal cords have a tendency to produce male, the younger ones female offspring), has already been noticed in the poultry world, though we may add that we alluded to it two years ago. At all events, poultry

is in our opinion specially adapted to similar experiments, owing to its, shall we say, handier size, and to its capability of great and speedy reproduction. I beg leave to adduce two examples from personal experience, the first an accidental case, the second an intentional experiment, not (by a long way) as final proofs, but merely as links of a progressive chain of evidence.

In 1899, in the midst of the breeding season I bought a fine Minorca hen. Not wishing to put her into my breeding pen, whose members had not visited any show since autumn, and were just in full lay, when the introduction of a stranger generally causes a disturbance of acquired conservative habits, I placed the fresh arrival in a small pen. In the evening when the inmates of the breeding pen had retired to rest, I took out the male bird and put him into the run of the pen, then turned out the stranger hen when he invariably attended to her at once. From forty eggs laid by this hen and set I obtained only pullets. Last year, proceeding on the same lines, I got 11% cockerels and 89% pullets. During the interval I did not do much breeding.

It is not so very difficult to arrange these matters with our poultry as vigorous male birds are generally pretty active throughout the day. Therefore place your hens intended for cockerel breeding into the run with the male as soon as they leave their house in the morning, and remove them again early. Your pullet breeding hens should not associate with their appointed mate until evening, the latter having been with other hens during the day, (but, of course, the special hens must not in the meantime run with other cocks). Active males generally pay immediate attention to strangers of the other sex, and it is desirable in this present instance for breeders to watch the process. It

is, as a rule, only a case of one, two or three hens specially destined for the experiment. Should, after abundant tests, a real law of nature be here discovered, the future of poultry breeding would certainly appear in a rosy light. I am far from asserting that the law would universally apply, but we certainly ought to try to find out if, and to what extent, it can be proved.

SELECTING THE BEST LAYERS

While the trap nest is the surest, best and only reliable means of picking out the good and poor layers expert poultrymen can, by the general appearance and makeup of the fowl, tell pretty closely which are the best layers in the flock. There is something in the



FIG. 1—A GOOD LAYER



A BAD LAYER

makeup of the good layers that is indicative of quality to the expert as are the points of a heavy milking cow to the eye of the experienced dairyman. The trouble with most of us is that we are not expert enough to distinguish the points of the good layer. Mr. P. A. Cook in the *Orpington Poultry Journal*, says he can invariably pick out the good and poor layers by the shape of the head. As an example he uses the illustration (Figure 1) of two heads of Light Brahma hens. You will see that the hen on the left has a thin, clean cut head, with bright and prominent eye and also a thin neck. This is the good layer. Notice that both

the eyes are so prominent that they stand out like the side of a ball. These illustrations were drawn from life and are not exaggerated. In the bad layer you will find a thick, clumsy head, dull eye, somewhat sunken, which will not be as bright as the former bird's spoken of. She will also have a thick neck.

After reading the above, some will probably go out into their poultry yards and inspect their flock for good and bad layers. If you do you must take into consideration the breed or breeds that you keep; also the age of the birds. The reason is this, such fowls as Leghorns, Minorcas, Anconas, Campines, etc., of course will have a smaller head than Orpington, Rock, Brahma, etc. This is because the former breeds are so much smaller in size. Then as a bird gets older the head thickens. This is of course learnt by experience; but do not expect a three year old hen to have as thin a head as a young pullet.

Most people know that the first birds out in the morning and the last ones to go to roost will nearly always prove to be the best layers. These birds will roam further and if in confinement will scratch about more than the bad layers as these are usually lazy. Of course there are exceptions to all rules.

Of course the bad laying fowl will lay some eggs but these will be produced in the late spring and summer months when eggs are cheap, but the good layer will produce them in the late autumn and winter months when they are dear, hence ten good layers are worth more than twenty-five bad ones, taking the cost of keeping.

To Pick Out a Layer—When she sheds her feathers and we kill off the non-layers, it is well to be sure and not slay a fowl full of eggs. When the rear bones are wide apart at the points below the tail

feathers, you have caught a layer. When they are close together, bidy is taking a vacation.

SOME EXPERIENCES OF AN AMATEUR

I began to raise chickens for my table and had no idea of any enjoyment in the business. I am surprised to discover that I have made a nice hobby for my coming old age, and am really having considerable fun besides some little profit. The chicken business is a mere episode in a professional life, begun to produce fresh eggs and some food for my household of seven people. It has developed into a pleasant recreation. I have nearly half an acre in a city, on which I raise nothing but fruit and chickens. I never mean to exceed forty-five hens and five cocks, or thereabouts. From the last of November until about May 1 I keep them in small flocks, and then let them run together. I think I know the best breed. The all around fowl for domestic use is the Plymouth Rock. I know more money is made in eggs than in poultry, and the Leghorn is said to surpass them in egg-laying capacity, yet, taking the year altogether, I have my doubts of it. But when you kill Leghorns for the table, compared with the Plymouth Rocks you have to kill two to one, and the two are not much at that. The Plymouth Rock makes, in my judgment, the finest poultry for the table in the world. Forty-five April hatched pullets will give all the eggs I want in the dead of winter. Never fall in love with your chickens, and by all means don't let the women of the house do it. Cocks and pullets are not worth sentiment. One is fit for nothing but to lay eggs in a nest; the other to lie on the table for food. A hatching and brooding hen is interesting, but interest ends when she drives her brood away.—[Austin G. Yates, New York.

Preparing Fowls for the Show Ring—The preparation of show birds really begins with the selection and mating of the breeding pen. After they have attained an age of four or five months, when they give evidence of future form, the best birds should be selected, or the entire flock, if it is not too large, may be fed with the show ring in view. Feed them sound, nutritious food but not so as to fatten them. In the morning, give a warm mash of cooked meal and potatoes; at noon, whole wheat or buckwheat, and at night, a very little whole corn with crushed bone and a small allowance of scraps three times a week. Give also two or three times a week some cooked meat or fish. Never feed more than they will eat up clean at one time. Supply regularly with pure, fresh water, and give milk to drink if you have it. Unless they have free range, provide a large, dry run and ample dust boxes.

From two to four weeks before the show, pick out as many birds as you contemplate exhibiting and two or three extra ones. Separate the sexes and provide pens for both, the floor of which is covered with clean, dry sand two inches deep. Give the most nutritious feed obtainable while the fowls are confined. Rice boiled in milk is one of the best foods, but whole wheat is also excellent. There is nothing like sunflower seed to give the plumage the rich, brilliant gloss which is so attractive in the show pen. Clean water, grit and a little charcoal must also be provided.

The final preparation of all white birds is to wash and clean the plumage, which should be done the day before shipping. Take three tubs of water, one hot, one lukewarm and one cold. Place the bird in the hot water, which should be deep enough to cover the back and come well up on the neck. Use white castile soap and make a good suds, then rub the bird well with the

soap on all the dirty parts, rubbing the feathers hard, but not so as to break them. Give the bird a good washing and then rinse in the lukewarm water, being sure to get out all the soap and dirty water. Add enough bluing to the cold water to give the feathers a nice appearance. Clean the beak and legs and place the bird in a clean box with cut rye straw or excelsior in the bottom, placing it by the stove. With a soft sponge, bathe the wattles, face and comb with a little alcohol, which will give them a rich, red color. The shanks and feet may be rubbed lightly with a little sweet oil, taking care not to get on so much that the dust will settle on them and make them look grimy. A little butter color will deepen the shade of yellow-legged birds.

As a rule, few exhibitors know or care about all the little tricks and so-called mysteries so often referred to in the columns of the fanciers' papers. A few undoubtedly attempt all that sort of thing, but the greater part of the men who exhibit successfully are content to send a good bird away with no more preparation than is necessary to make it a clean healthy bird, with a short course of such dieting as is necessary to enable it to stand the confinement of a show coop for five or six days. This reasonable method of getting birds ready to show is certainly not difficult, and any breeder who would like to exhibit as well as to raise market fowls, will find little trouble in catering to his desires in this respect.

Bringing Birds up to Weight—Last year I had two clutches of eggs hatched out May 18 and one June 2. The result was thirteen fine Light Brahma chicks. I also had chicks hatched in March and April and of these later hatched I wish particularly to speak. Laying aside the hard boiled egg ration after the first day, I fed stale bread soaked in water and pressed dry

before feeding. The hens were kept in a small grass run for the first ten days, after which they had the liberty of a fifty-foot square pen with plenty of grass. The chicks could run out on the lawn. From the time they were a week old until the first of September their principal feed was millet seed, whole wheat and bran, with plenty of fresh water constantly before them, also cut bone. After September 1 a mash was fed every morning, consisting of two parts bran to one part each of shorts and corn meal, by weight. To every ten pounds of this mixture one pound of deodorized blood meal was added.

Two quarts of this mixture was scalded each evening, and fed as a morning mash to twenty-five chicks. Nothing more was given until roosting time, when they were fed all the whole corn or wheat that they would eat. During the day they had about the usual range of town reared birds. At eight months of age the heaviest cockerel weighed twelve pounds and the lightest nine and one-half pounds. The pullets weighed from seven and a half to nine pounds. As little chicks they were never allowed out in the morning till the dew was off the grass. They were fed systematically, and as near the same time each day as possible. I believe a single feed missed will tell on the growth of a chick.

Constant vigilance is the price of a show bird or a good sized specimen for the breeding pens. My earlier hatched birds were no larger than the later ones, with the same care; and I do not think much is made in this cold northwest in hatching chicks before May, at least. Get a chick out after the cold changeable weather and spring rains, and then push him right along with good care, regular and systematic feeding, and the work is done.—[Rev. J. M. Acheson in Western Poultry Journal.]

Forced Molting—When a specialty is made of winter eggs, it is of much importance to have the hens shed their feathers early in the fall, so that the new plumage may be grown before cold weather begins. In case molting is much delayed, and it will be delayed if fowls are fed heavily for eggs during the summer, the production of the new coat of feathers in cold weather is such a drain on the vitality, that few eggs are laid until spring. If the molt takes place earlier the fowls would be in good condition for winter laying and yearling hens will produce as many eggs as early hatched pullets. A method of forced molting has been worked out very successfully by Henry Van Dreser, a New York poultry keeper. Briefly stated it consists in confining the fowls in yards during August and withholding two-thirds of their feed for two weeks. This stops egg production in a few days, reduces the weight of the fowls, and then heavy feeding on a ration suitable for the formation of feathers causes a quick molt, and a general building up of the system.

Picking fowls to help molting is practiced and recommended by some poultry keepers. During July and August when the hens have fully matured their feathers and are inclined to be broody, they may be picked the same as one would pick geese or ducks. The feathers are very fine to use, and the operation hastens the molting season so that fowls are ready to lay in early October. In addition to the regular food, which should be made up largely of wheat and oats, either ground or whole, a little sulphur will be of great help in the formation of feathers. Skimmilk, meat meal and an abundant supply of green stuff should also be given.

The growth of a new crop of feathers is a severe drain on the vitality, and even when it occurs naturally fowls should have extra feed and care. The grain

ration should be increased a third, and the fowls protected at night from drenching rains and severe storms.

The Care of Poultry Manure—The dung of fowls is a highly nitrogenous manure, and should be carefully used and saved. Most of the nitrogen is in the form of uric acid, and is very readily available to growing plants. Weight for weight, the droppings of the hen roost are not nearly as valuable as guano, but are worth much more than ordinary barn manure. Unless properly preserved, the nitrogen is easily lost. Roosts should have tight platforms under them, which should be cleaned weekly, or oftener, and the accumulated droppings mixed with a suitable absorbent and kept under cover. By itself hen manure is a one-sided nitrogenous fertilizer, and as usually managed half or more of its nitrogen is lost. As both acid phosphate and kainit prevent the loss of nitrogen when mixed with manure, it is possible to use them in connection with sawdust or some other dry material, as an absorbent, so as to make a well-balanced fertilizer. Good dry loam will answer very nicely for this purpose. This material should be spread freely on the roosting platforms. For example, a mixture of thirty pounds hen manure, ten pounds sawdust, sixteen pounds acid phosphate and eight pounds kainit would carry about one and one-fourth per cent nitrogen, four and one-half per cent phosphoric acid and two per cent potash. Kainit or acid phosphate by itself makes the manure quite sticky.

Whitewash—Poultry houses and coops should be whitewashed inside and out. All the nest boxes and other fixtures should receive a coating. The ordinary lime and water wash has the disadvantage of easily washing off, and also sticking to and marking one's clothes or whatever rubs against it. Here are some

excellent recipes for making whitewash that will not rub off :

Slake in boiling water one-half bushel of lime, keeping it just fairly covered with water during the process. Strain it to remove the sediment that will fall to the bottom, and add to it a peck of salt dissolved in warm water. Mix the different ingredients thoroughly and let the mixture stand for several days. When ready to use apply it hot. If a less quantity is desired, use the same proportions.

A good whitewash for use upon outside work: Slake in boiling water one-half bushel of lime, and strain as before. Add to this two pounds of sulphate of zinc and one pound of salt dissolved in water. If any color but white is desired, add about three pounds of the desired coloring matter, such as painters use in preparing their paints. Yellow ochre will make a beautiful cream color, and browns, reds and various shades of green are equally easily obtained.

An excellent wash, lasting almost as well as ordinary paint: Slake in boiling water one-half bushel of lime. Strain so as to remove all sediment. Add two pounds of sulphate of zinc, one pound common salt and one-half pound whiting, thoroughly dissolved. Mix to proper consistency with skimmed milk, and apply hot. If white is not desired, add enough coloring matter to produce the desired shade. Those who have tried this recipe consider it much superior, both in appearance and durability, to ordinary washes; and some have not hesitated to declare that it compares very favorably with good lead paints. It is much cheaper than paint, and gives the houses and yards to which it is applied a very attractive appearance.

Ordinary whitewash is made more effective by the addition of carbolic acid. Slake lime (in an old tub or half-barrel) with a sufficient quantity of water to

make a wash of the desired consistency, adding a little water at a time. Then add a fluid ounce of crude carbolic acid to every bucket of wash. Apply the wash with an old broom or with a force pump. Put it on hot and get it into the cracks.

Best Size of Flock—At the Maine experiment station, flocks of fifteen, twenty, twenty-five, and thirty hens, respectively, were tested for comparative profits. The lots containing twenty hens gave a greater net profit per lot than any other number. Lots of twenty-five hens gave slightly greater net returns than did the fifteen-hen lots, and those with thirty hens gave much less net returns than any of the others. The result indicates that the best profits will be obtained by allowing each hen eight to ten square feet floor space.

A very common mistake is the keeping of hens to an age when they have passed their usefulness, and frequently this is done because of the feeling that the hens are unusually good ones, when as a matter of fact a hen more than two years old, no matter what her record has been, is less valuable than one younger. It would pay to mark all chickens when hatched so that you could readily by selection keep your flocks down to pullets and one-year-old hens.

Litter for Scratching—In order to induce fowls to exercise in winter, it is essential to cover the floor several inches deep with some loose kind of litter, in which to throw the whole grain. Long rye straw makes probably the best litter, because it does not mat down. Wheat or oat straw is also good. Hay or cornstalks will answer the purpose admirably. Leaves break up quickly and must be renewed often. Refuse from hay loft containing seeds, clover heads, etc., should be used frequently where it can be obtained. The chickens will get a great deal of good material out of this.

Clipping Wings—Many hesitate to clip the wings on account of an almost certain disfigurement that is likely to be the result. If care is taken in cutting, the wings can be clipped in such a manner that the mutilated feathers cannot be detected unless the fowl is caught. I have a flock of Leghorns which I recently clipped; it would take a very acute observer to note that the wings had been tampered with in the least. The task is by no means difficult; anyone can do it by using a little care. If the operator is a right-handed person, take the fowl in the left hand and hold close to the body partly by the hand and forearm. Spread out the left wing with the thumb and forefinger of the arm that is holding the fowl. With the right hand take a sharp pair of shears and cut the flight feathers, or the ones on the outer side; cut until you come to the natural division between the flight feathers and the secondaries. The section that should be cut is technically known as the "primaries." If the primaries are cut as close to the flesh as possible and the operator is careful not to cut over too far and get into the secondaries, the effect will not be noticed when the fowl is in its natural position. Except in extreme cases this will prove just as effective in restraining high fliers as though the wing had been practically cut entirely away. When this is not sufficient, which is seldom the case, more clipping will be necessary. It is possible to cut the wings when the chickens are young so that their flying ability will be effectually impaired for all time. This will often prove to be a great advantage especially with fowls of the Leghorn, Hamburg and Minorca breeds. This is not difficult nor painful to the chick, if done at the right time, and consists simply in cutting the wing at the last joint; the portion cut off is but a trifle when the chick is young, but when it is developed it makes quite a material difference in

its wing power, so much so that it is a comparatively small matter to confine them, and so far as practicality is concerned, it does not impair their useful qualities. If the work is done when the chicken is about ten or twelve days old, it is scarcely painful, and the chick soon recovers its usual activity.

Road Dust and Coal Ashes—The fine, dry dust on the roads, which is such a nuisance to the traveler, is a blessing to the poultryman. It is an admirable absorbent, and used under the roosts and mixed with the droppings, it preserves the volatile properties of the hen manure, increasing in a very material degree the fertilizer made by the flock. Used in a dust bath, it penetrates the feathers of the fowls and stops up the air passages of the parasites that dwell on the bodies and hide among the feathers of the hens, thus promoting the comfort and health of the fowls. Used on the floors and about the house, it assists in destroying little mites that hide in the cracks and corners of the building, removes noxious odors and exhalations, and makes the poultry house a healthy home for its feathered occupants, instead of a disease breeding prison. It pays to gather and use road dust, which is plentiful everywhere. In most cases where coal is used for fuel, the coal ashes make perhaps as good a dust bath as can be had. It has the further advantage that the bits of coal which hens find among the ashes will be eaten by them, and will help grind the food in their gizzards. The coal itself will also be digested in the process, and may appear as black specks on the egg shells of fowls that have access to coal ash heaps. Coal ashes make a very excellent insecticide. They are finer than any road dust can be made, and therefore are more effective, closing the pores of vermin which breathe through the holes in their sides. When these are closed by fine powder, the vermin

quickly die from suffocation. The addition of a few wood ashes to the dust bath is a great help in keeping down body lice.

Poultry on Shares—If A furnishes B with poultry to raise on shares, B doing all the work and supplying the feed, he should receive one-half the poultry, A to take his half and the original flock at market time in the fall.

To prevent frozen combs keep the poultry in their houses on very cold days, particularly when the cold is accompanied with a high wind. Make a burlap curtain to hang over the roosts and down around the fowls to keep them warm at night.

The color of the yolk is influenced by the food. Feed plenty of cut clover and some corn; and the yolks will be yellow enough to suit you. Fowls fed largely on buckwheat and wheat often lay eggs with light colored yolks; but it does not affect the fertility of hatching.

Dehorn Roosters—It sometimes becomes quite a problem what to do with the old males after the breeding season is over. If turned out on the range with the cockerels, they tyrannize over them, driving them from the feeding grounds, injuring and even killing them by their assaults. If put into an inclosure together, a series of fights will immediately begin, and when it is over the birds will be hardly worth keeping. Cut off the spurs with a very fine saw within one-half inch of the leg and put on a little powdered chalk or sulphate of iron to prevent bleeding, then trim down the beak until the blood shows close to the cut. Then the birds will run together as quiet as a lot of pullets and by the time the beak grows out they will be living in peace and harmony.

Crooked breast bones are commonly caused by the chicks going on the roost too young, as a chicken's

breast bone at that age is little more than cartilage, and bends very easily. Chickens should not be permitted to roost until about twelve weeks old, and if of the heavier varieties, such as Brahmas and Cochins, they should be four or five months old before being allowed to roost. We have known of breast bones being deformed in birds that did not roost at all, and that could possibly be done by their crowding too much on the ground. The bones of chickens could be hardened by feeding them lime or fine bone meal in small quantities from time to time.

Teaching Chicks to Roost—Sometimes changing the chicks from the house they have been accustomed to to one with roosts conveniently placed induces them to roost. When this fails, the only effective plan is to put wide boards on the roosts extending clear back to the wall, and lift a part of the chickens to these every night until they learn to go themselves. When a part of the flock learns to roost the rest gradually follow suit. It is a rather tedious performance, but we know of no other way to accomplish the end sought.

CHAPTER III

Where to Keep Fowls

While fowls can be kept almost anywhere and everywhere, they do best in congenial locations. The soil and arrangement of buildings have much to do with their health and profit. As a general proposition it may be said that a light soil which provides good natural drainage, yet is strong enough to grow grass, makes the ideal location. An exposure varying from southeast to southwest, protected from prevailing winds, is best.

Fowls naturally like to roam. The ideal conditions are such that provide them with a liberal area. On the farm the most that is needed is a suitable house and a good sized yard in which they can be confined at certain seasons. In village and city lots the area is necessarily limited and the fowls must be kept in yards most of the time.

Where poultry is kept as a business there are two plans which may be followed: One, the intensive system, whereby they are crowded together in small yards; the other, the colony plan, in which small houses are scattered about the place so that the fowls are given either partial or entire free range. One must be governed by circumstances and amount of land at disposal as to which plan to adopt. The intensive plan requires considerable more labor to care for the fowls because every want must be supplied. The colony plan is, no doubt, the best for the great majority of poultry keepers who have a few acres at their disposal. With this system separate yards may or may not be necessary.

BUILDINGS OF MANY KINDS

A warm house, or at least warm sleeping quarters, is essential to get eggs in the winter. Fowls of the Mediterranean breeds and others which have large combs and wattles must be kept in warm houses to prevent freezing the combs and wattles. Warming the house by means of artificial heat is not advisable. This gives an unnatural condition which leads to many troubles. It is better to spend a little more in building the house substantial and warm. The importance of warm houses cannot be too greatly emphasized. A test by the West Virginia experiment station shows clearly the value of a substantial house. Two houses built exactly alike and placed side by side were selected for an experiment and in each were placed twelve pullets. One house had previously been sheathed on the inside and covered with paper to make it perfectly tight. Both were boarded with matched siding and shingle roofs. Fowls were fed alike in each case and the experiment, which started November 24, continued five months. In the warm house the twelve pullets laid a total of 629 eggs; in the other, 486 eggs. North of the Mason and Dixon line it will pay to make all houses double boarded with or without a dead air space. A small roosting room that can be closed tight during winter nights, and roomy, airy quarters for the daytime, is the ideal arrangement for health and profit. Such an arrangement is provided for in the scratching shed house or in some modification of it.

The Scratching Shed House—Although open sheds have long been used for poultry to run under during winter, we believe the scratching shed house, so called, originated with Mr. A. F. Hunter, formerly editor of *Farm Poultry*. Such a house, shown in

Figures 2 and 3, is thus described by him in that journal:

The house can be built of any length desired, the pens and sheds being in groups of two, with doors opening through from pen to pen and from shed to shed, so that the whole house can be passed through without going out of doors. Each roosting room is eight by ten feet, and each shed (adjoining) is ten by ten feet, the front being seven feet high, the back four feet high. The shed having a tight roof, and being tight on the north and west, is all open to the south (when the curtains are up), giving the birds fresh air



FIG. 2—THE ORIGINAL SCRATCHING SHED HOUSE

and sunshine, at the same time they are protected from our cold northwest winds.

Each combined pen and shed is eighteen by ten feet, and will well house twenty-five fowls; and as it is the most economical plan to build upon, it is easy to see that it is by all odds the best for the man who has to make his dollars go as far as possible. For these reasons we recommend this compact open shed and roosting pen plan of house as being the best all-around house that can be built. We have 108 feet (in length) of this house on our farm, and find it just about perfect.

We intend that the top of the sills of our house shall be about a foot above the ground level. The sills are two by four-inch scantling, halved and nailed

together at splices and corners. They rest upon posts of cedar or chestnut, which go into the ground about two feet. A board one foot wide is nailed along lower half of sill, extending into the ground three or four inches. The plates are same as sills, and are halved and nailed together at splices and corners. A sufficient number of studs six feet eight inches long for the front and three feet eight inches long for the back, are cut from the scantlings, one for each corner of the pen

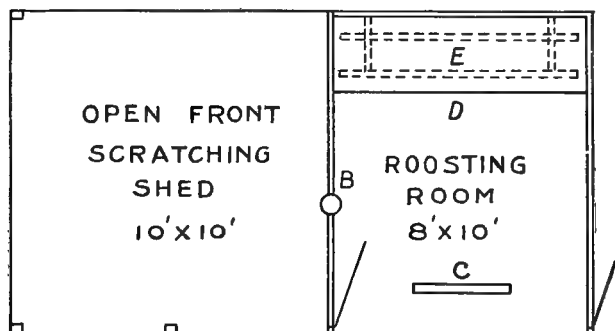

FIG. 3—GROUND PLAN OF SCRATCHING SHED HOUSE

and shed. These are toe-nailed onto sills, and the plates spiked onto top of them. We set an intermediate stud in front of each scratching shed and two two by three-inch studs in front of roosting pen set the right distance apart to receive the window. At the back, we use one intermediate stud of two by four-inch stuff in each pen and shed. As we purpose double boarding this back wall, boarding on the inside of studs with matched boards, we use the two by four-inch studs, and thus get the four-inch dead air space.

Rafters are of two by four-inch scantling, notched and spiked onto plates, the top end cut flush with out-

side of plate, the lower end projecting about eight inches, and mitered to nail a gutter to. It is best economy to set rafters two feet apart. All outside boarding is lengthwise of building, and is cheapest hemlock boards, put on with as small cracks as possible, then covered with, first, sheathing; then, roofing paper. This is put on lengthwise of building, also, each strip lapping about three inches, and secured with the tin head nails provided with each roll. We add battens, stripped one-half inch thick from seven-eighth-inch boards, putting them on over the rafters, two feet apart. We give the roofing paper a coat of

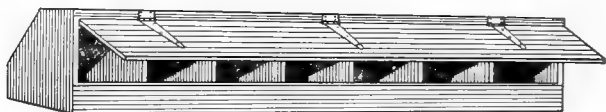

FIG. 4—NEST BOXES

paint, and also paint the battens before putting them on, then put on a second coat of paint over battens and all. A twelve-light window of eight by ten-inch glass is set in the middle of front of roosting room, and a half-window is set in each partition between shed and pen.

The roost platform is three feet wide, as long as will go easily in between the partitions, and rests upon strips of furring securely nailed to the partitions, the top of rest being twenty inches above floor. The platform we make of matched boards, and edge it with a strip of furring all around, so that it is a shallow pan one and a half inches deep. The two roosts are of two by three-inch scantling slightly rounded on top, and are fifteen inches apart, the rear one being ten inches from the back wall. The bank of nest boxes, explained by the illustration, Figure 4, is set under the

roost platform so the fowls can go round the ends and enter any apartment from the back, the front (hinged at top and secured by a simple button at the bottom) lifting up to allow of removing the eggs. Keeping this front closed makes the nests dark and secluded, most important aids to prevent forming the egg eating habit.

We make the floor of scratching shed ten by ten feet, and plan for two curtains four and one-half by five and one-half feet to close the front. Both these curtains can be hinged to right and left, the right hand one being a door to admit to shed and thence to pen; or they can be simple curtains on frames secured by buttons, excepting that the shed at end must have a



FIG. 5—MAINE TYPE OF CURTAIN FRONT HOUSE

door for entrance. A better plan, and probably the best, is to have the curtains hinged at top so as to swing in and up along the roof rafters, where a hook secures them. This plan has many advantages, not the least of which is having the curtains hung up out of the way all summer, when they are not wanted.

The Curtain Front House—This is a style of building designed by Prof. G. M. Gowell of the Maine experiment station, and is a modification of the scratching shed house. It has been in use by him for many years. Figure 5 shows a general view of it. This building is 150 feet long, fourteen feet wide, five and one-half feet high in the rear and six and two-thirds in the front. The sills are four by six inches in size.

and rest on a stone foundation. The studding is two by four-inch. The building is boarded, papered and shingled on roof and walls. The rear wall and four feet of the lower part of the rear roof are ceiled on the inside of the studding and plates and packed with hard and dry sawdust. The end walls are packed in the same way. The house is divided by close board partitions into seven twenty-foot sections and a ten-

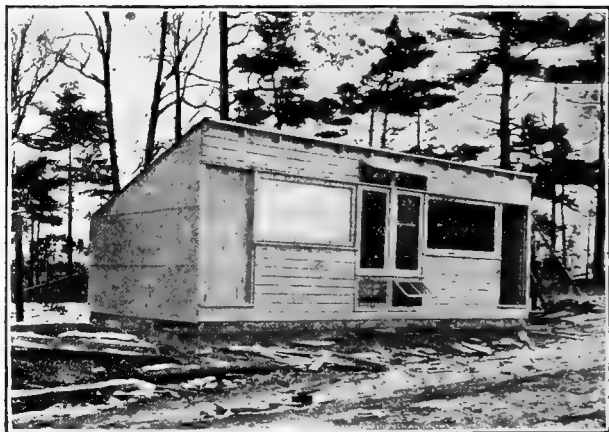

FIG. 6.—CORNELL TWO-PEN HOUSE

foot section is reserved at one end for a feed room. The feed section has two twelve-light outside windows screwed onto the front. The space between the windows, which is eight feet long and three feet wide down from the plate, is covered during rough winter storms and cold nights by a light frame covered with ten-ounce duck closely tacked on. This door or curtain is hinged at the top and swings in and up to the roof when open. A similar curtain at the rear closes in

the roosts, there being two roosts over a tight platform. The curtain is made to fit closely and enough air gets through it to afford sufficient ventilation for the fowls. The several years during which this house has been used shows that it is the ideal house for American breeds. Fowls are rarely, if ever, sick in it and the yield of eggs during the winter is very satisfactory.

The Cornell House—Only in recent years have

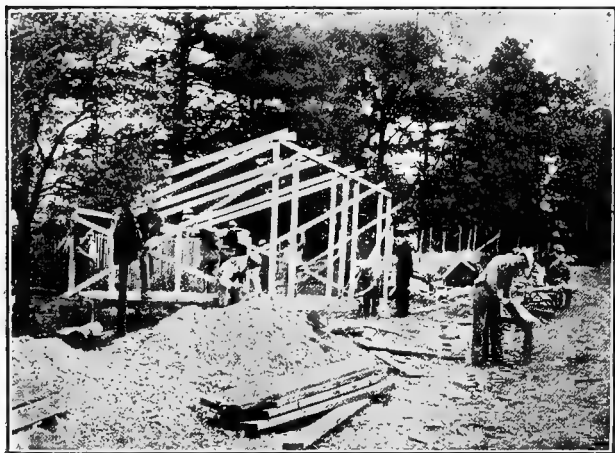

FIG. 7—FRAME OF CORNELL TWO-PEN HOUSE

poultrymen discovered the value of cloth curtains in poultry house construction as a means of providing ventilation and promoting the health and comfort of the flock. The latest fashion in poultry house construction, as exemplified by the house on the Gowell Poultry Farm in Maine, the model house built by Prof. James E. Rice of the Cornell experiment station and many other practical poultry keepers, is to use cloth-covered screens in place of part of the glass. A roost-

ing closet inclosed with a cloth screen in front protects the fowls at night during the coldest weather. Where exercise is provided by making the fowls scratch in deep litter for their grain, they keep warm in open houses.

The science of poultry house construction is being gradually worked out. The latest style of house is that shown in Figures 6, 7, 8, 9 and 10, which is described by Prof. James E. Rice in a recent reading course bulletin for farmers. The house is four feet eleven inches in the rear and eight feet seven inches in front, which is as low as it is possible to build without danger of bumping the head while doing the work. The house is twelve feet wide and twenty-four feet long, divided into two pens, each twelve feet square. It may be made of any length desired, but in a long house, it would be advisable to make it fifteen feet wide and the pens fifteen feet square.

The shed roof is used because it is easiest to build, provides the largest volume of sunlight and the best possible conditions of sanitation, warmth, brightness and dryness. There is no projection on the north side or rear of the house, which enables the paper to run continuously without breaking at the eaves, thus making an air tight joint and preventing rain from washing the soil, also doing away with eave troughs. Each pen is intended to accommodate from thirty to forty fowls.

The foundation is built of concrete. The wall need not be more than eight to ten inches thick. It should stand at least six inches above the natural level of the land and need not go more than six or eight inches below the surface, except in soils inclined to heave badly. The floor is also made of concrete. The sills are of two by fours, which should be placed upon the foundation before the floor is laid, so the cement

can be flushed against the sill to prevent air and water entering.

The walls on all sides except the south are made of one thickness of matched pine lumber with planed side inside. The outside, including the roof, is covered with one thickness of roofing paper. The only part of the house that is double boarded is the portion directly back and above the roosting platform. An air space is formed between the studding and the inner

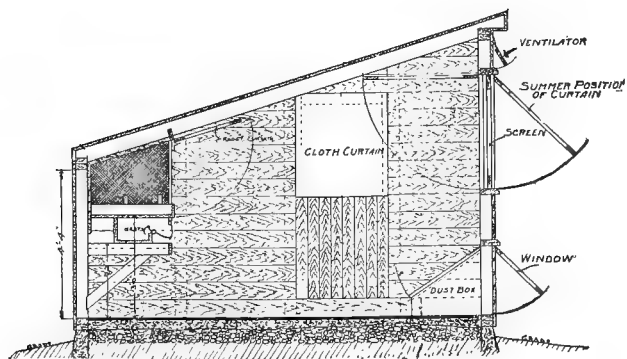

FIG. 8—SIDE VIEW CORNELL HOUSE

boarding, which is opened above and below. Holes are bored through the plate, which permit the air to circulate freely up between the studding through the plate, between the rafters and out into the room again. This makes the inner wall warmer than it would be with a dead air space, owing to the fact that the air is continually changing and, therefore, must be nearer the temperature of the room than it could possibly be with the dead air space, which in time becomes as cold as the outside boarding. The front of the house is made of one thickness of ship lap without paper either inside

or out. This type of wall more readily warms up on the inside when the sun shines than would a double wall and the warm air does not readily pass out because the house is free of draft.

The frame is made wholly of two by fours, except the rafters, which are two by five. The studding is placed four feet apart and the rafters two feet upon the centers. See Figure 7. The boards are laid horizon-

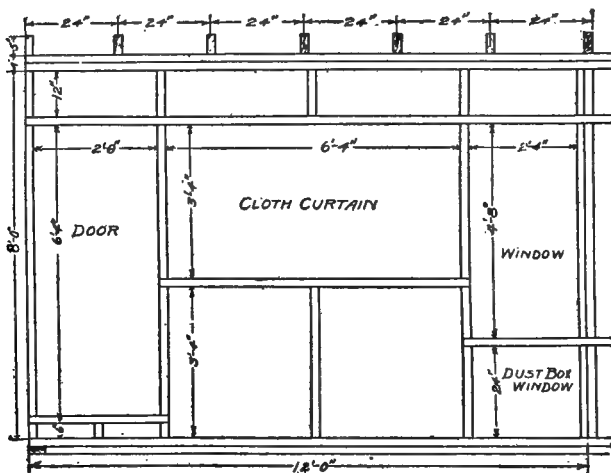

FIG. 9—FRONT ELEVATION OF FRAMEWORK

tally. Most of the front of the house is filled with door and window openings which are easy of construction and require a small amount of material. Details of construction are shown in Figures 7, 8, 9 and 10.

The best light is obtained by always placing the windows high. By placing the windows near together and making that part of the partition near the front of the house of wire, the sunlight can pass

through so that each pen gets the benefit of the sunlight from its own window and that of the other pen also. The windows are hung at the side and swing against the partition, in which position they are readily opened and closed. When opened, as they should be during the entire summer season, they are in the most

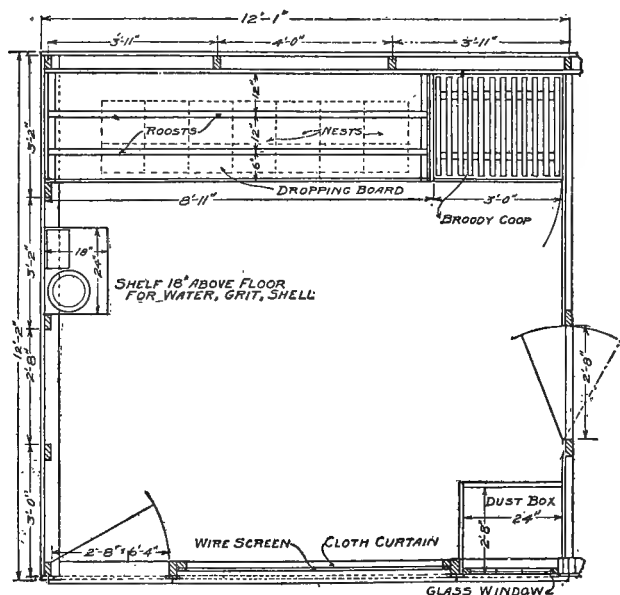

FIG. 10—GROUND PLAN CORNELL HOUSE

secure place possible to avoid breakage. The glass windows are two feet four inches by two feet eight inches and contain eight by ten inch glass. Each pen is provided with a cloth frame hung at the top, covering a window opening six feet four inches by three feet four inches. The top of the window is six feet

eight inches from the floor. Over each window is provided a board hinged at the top, which swings out, shading the opening so sun can shine in and permit the warm air, which accumulates at the highest portion of the roof, to pass out freely. This is intended to be open only in summer. The cloth window can be hung on the outside and swung out during the summer to form an awning. A dust bath is provided by constructing a well six or eight inches deep in the floor of the house directly under the small glass windows. A two light cellar sash two feet four inches by two feet is placed directly under the large window and is hung at the top to swing outward. A wire screen covers the pen on the inside so arranged that the dust wallow can be emptied or filled readily from the outside. The hens enter from a narrow pen at the end. This arrangement furnishes a splendid dust wallow with very little dust escaping into the room, except when the fowls come out to shake themselves.

The inner arrangement of the house, Figure 10, is portable. The platform and nest boxes are all movable. The arrangement shown provides for trap nests under roosting boards, but most any form of nests can be used. One nest is allowed for five fowls, which is usually sufficient. A coop for broody hens is provided in connection with the roosting arrangement where it is most out of the way. The floor of this coop is slatted. If a long house of this type is built the doors between the pens should be hung on double acting hinges. The cloth for covering the screens may be of burlap or a medium sheeting. A heavy type of cloth or one that is oiled is objectionable, as it does not allow the air to go through it. The bill of materials and approximate cost of same is as follows, although the cost will vary somewhat in each locality:

35	bags	Cayuga cement
12	pieces	2x4 inches by 12 feet
6	"	2x4 inches by 14 feet
20	"	2x4 inches by 10 feet
13	"	2x5 inches by 14 feet
4	"	2x6 inches by 12 feet
2	"	1x4 inches by 12 feet
2	"	1x6 inches by 12 feet

All of above stock hemlock and surfaced on four sides.

15 feet 1x12 inch basswood or poplar; no shakes or cracks.

15 feet 1x6 inch.

30 square feet cove siding in 12 foot lengths.

50 square feet cove siding in 14 foot lengths.

786 square feet sap pine flooring in 14 or 16 foot lengths, surfaced one side.

400 square feet sap pine flooring in 12 foot lengths, surfaced one side.

2	pieces	1½x4 inches by 12 feet
2	"	1½x4 inches by 14 feet
3	"	1½x2 inches by 16 feet
15	"	1½x3 inches by 12 feet
4	"	1½x3 inches by 10 feet
6	"	1½x1½ inches by 12 feet
6	"	1½x3 inches by 14 feet

140 linear feet ½x1 inch window stop

Above to be good grade white pine surface four sides. Cost \$91.87.

Bill of hardware material for the laying house:

2-9 light 8x10 inch glass

2-6 " 8x10 inch glass sash

2-2 " 12x14 inch glass (cellar sash)

3 pairs 3 inch light loose pin butts (pressed steel)

11 " 3 inch light T hinges

2 " 2½ inch light loose pressed steel butts

- 2 " 4 inch double action spring butts (steel)
 screws for all of above.
 4 rim night locks (2 keys)
 6 1½-inch japanned iron buttons
 3 pounds 5d nails (box)
 10 pounds 10d nails
 10 pounds 8d nails
 25 pounds 20d nails
 7½ squares Neponset roofing paper
 2 gallons paint. Cost \$24.35
 Total material cost \$116.22.



FIG. 11—MESSRS. PERRY'S WELL-ARRANGED HOUSE

A well-arranged house is that of E. R. Perry & Son of New Hampshire, whose modern scratching shed house is shown in Figure 11. This consists of four roosting pens with a scratching shed attached to each. A two-story building provides a feed room, brooder house, incubator cellar, a place for storing vegetables and general all around handy storage room.

An Inexpensive House—The simple house shown in Figures 12 and 13 is one of the cheapest that can be made, and will commend itself to many practical poul-

trymen. According to Daniel Lambert of Rhode Island, the owner, it is entirely satisfactory and suitable for both summer and winter. The building is twenty-eight feet front and fourteen feet deep, eight feet high at the center and four feet at the eaves. A partition runs from the center from front to rear, making two rooms each fourteen by fourteen feet. Two

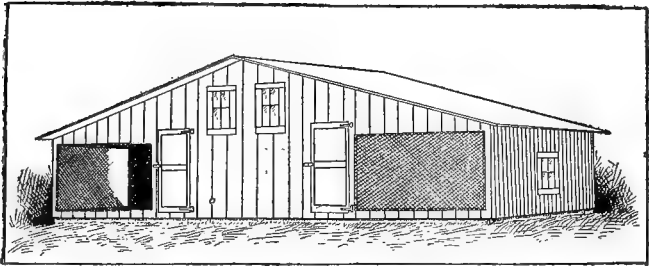

FIG. 12—D. J. LAMBERT'S PRACTICAL AND INEXPENSIVE HOUSE

feet above the sills along the partitions are the dropping boards four feet wide. Over these at a height of six inches are the roosting poles of two by three inch spruce each fourteen feet long. In front of the roosts are two swinging doors hung just below the ceiling which shut down flush with the dropping boards. The doors in this case are made of unmatched lumber, but frames covered with muslin are preferable, because they provide better ventilation without drafts. Between the two doors in front of the roosts is a board one foot wide, at the bottom of which is an opening large enough for the fowls to come out of the roosting cupboards when the doors are closed.

The openings in front of the building are seven and one-half by four feet and are covered with two-

inch mesh wire netting. These are closed at night when necessary and on stormy days with a muslin covered frame on hinges which swings open against the side of the building. There are small windows in front of the roosting rooms just under the ridge as shown in Figure 12 and one at each end of the house. In summer these windows should be removed to permit better ventilation. The entrance doors are four feet from the center and are five by two and one-half feet in size. The nest boxes can be placed under the drop-

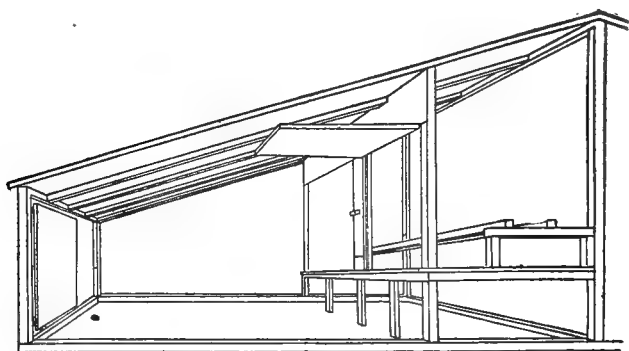

FIG. 13—INTERIOR VIEW OF D. J. LAMBERT'S HOUSE

ping boards or along the rear or side of the house back of the windows as may be desired.

This house was built of second grade inch hemlock boards and second grade spruce timber for sills and studding, the lumber costing about \$14 per thousand. The sills are four by four inch and the studding two by three and two by four inch. The center partition should be absolutely air tight so that there can be no drafts between the two rooms. The roof is covered with roofing paper and the sides and rear with similar material. The building is on an underpinning of stone

set in mortar. Mr. Lambert has several of these houses which cost less than \$75 each. From 100 to 125 fowls are kept in each house.

A Continuous House—An ideal house for the intensive system of poultry culture is shown in Figure 14. This house is built in two sections with a story and a half building in the middle which is used as a feed, storeroom, incubator cellar, etc. Such a building can be made of any length desired. The yards attached are necessarily long and narrow. A three-foot alley at



FIG. 14—HOUSE AND YARDS AT NEW YORK EXPERIMENT STATION

the rear of the house is generally considered essential in a long building for ease in doing the work, although this is a very expensive addition and many poultry keepers find it cheaper and fully as satisfactory to go through the pens.

A Cheap Structure for Fifty Hens—A house built recently by the author at a cost of \$45 for material is shown in Figure 15. It is twelve feet wide, thirty-one and one-half feet long, front studs six feet two inches and rear studs five feet. It is single boarded, of matched boards, covered with asphalt roofing paper

on top and Neponset red rope roofing on the sides. It is divided into three pens and has four large windows. All lumber and windows were second-hand material, which reduced the cost.



FIG. 15—THE AUTHOR'S FORTY-FIVE DOLLAR HOUSE

A barrel stave house, which can be built at practically no cost for material, is shown in Figure 16. It was put up by the Rhode Island experiment station to show how cheaply a house can be built. It answers the purpose very well for summer protection.

A novel house is that shown in Figure 17. It was an old hogpen twenty feet wide transformed into a poultry house by two Massachusetts poultry keepers who practice the most intensive system of poultry culture. Three floors two and one-half feet apart were put in and divided into pens six by twelve feet in

size. The front was closed in with wire netting. At the rear a space two by six feet in size was partitioned off for a roosting room. In each of these pens twelve hens are kept. During a very severe winter only one hen was frozen, and this hen by accident did not get into the roosting room at night. The floor is kept covered with sand and litter and fowls do not seem to mind such close confinement. In summer they are placed in pens six by twelve feet in size and two feet high, built of wire netting. A frame four feet square

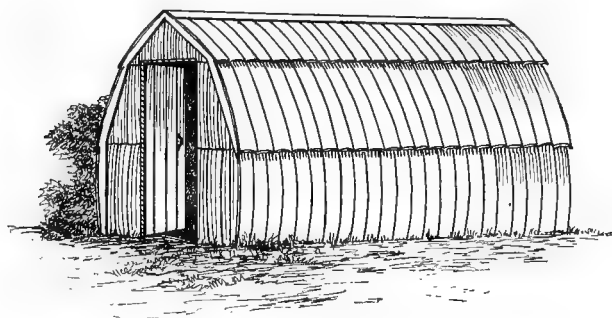

FIG. 16—BARREL STAVE HOUSE

and three feet high is covered with tarred paper, in which a roost is placed. These are moved weekly to fresh ground. Hens are fed heavily on oats and other grains and lay well from spring to fall, at which time they have been fed fat and are killed and marketed.

A suburban poultry house shown in Figures 18 and 19 is located in a Boston suburb, on a lot sixty feet wide by 110 deep. The ground is the cleanest of sand, with a hard gravel bottom. The house is set in the middle of the strip, with two runs, at the east and west ends. A cellar four feet deep, sixteen feet

long and ten feet wide, is walled with hemlock plank nailed to cedar posts. These posts are six feet long, so that they are two feet out of ground. The sill of the house rests on them, and is sixteen feet long, but only eight feet broad. This makes the cellar project two feet from the house on the long (southern) front. This projecting space is covered with glass, slanting from the sill to the edge of the cellar, and gives abundant light and sun to the lower room. The upper house is

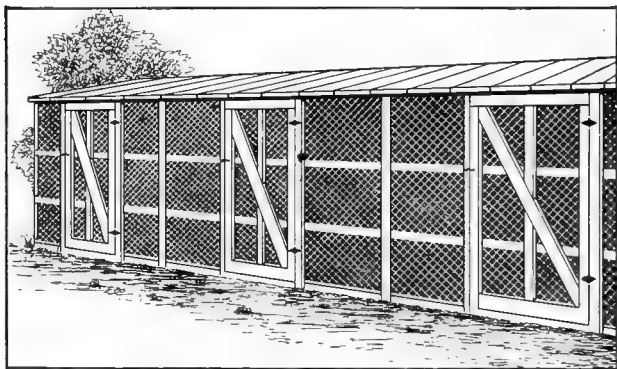

FIG. 17—A NOVEL HOUSE FOR WINTER LAYERS

nine feet high at the ridgepole, sloping to four at the eaves. A glazed door and two windows on the front, and a smaller window at each end, give light enough. In very small ground space this gives two distinct houses, one eight by sixteen, and one ten by sixteen, the lower house being six feet high in the clear.

The interior arrangement is such that the work can be done without soiling clothes. As shown in Figure 19, the door opens into a central hallway four feet wide, with a room six feet wide on each side of it. In the floor of this hallway is an ample trap-door,

with a flight of steps leading down into a similar hallway in the cellar, also with a six-foot room on each side of it. In the upper house the nests are two feet from the floor against the hallway partition, and over them the roosting board. A flap in the partition opens all the nests at once for gathering eggs and for cleaning and kerosening nests, and another flap opens the space above the roosting board, so that with a fine rake it can be cleaned off. The two runs, each twelve by twenty-two feet, are covered in, both front and top, with wire netting and those nettings are nearly covered

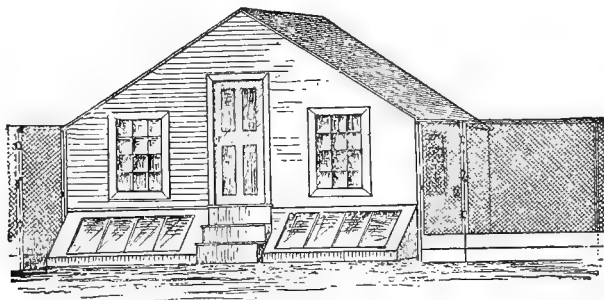

FIG. 18—HOUSE IN A BOSTON SUBURB

with grapevines, which give a delightful shade in hot weather. The other three sides of each are tight fence or house.

A very satisfactory house for a large village or city lot is shown in Figure 20. This is a double house, twenty to twenty-five feet wide and of any length desired. It is built in two sections, one projecting three feet above the other. In this three-foot space are windows facing south, which provide light and sun for the rear pens. Such a house should be four feet high in front with a pitch of two and one-half feet to

the roof, then a rise of three feet and a slope to the roof, which will bring it five feet high in the rear. An alley is provided through the center in which to do the work. Roosting platforms in each pen are next the alley and beneath these are the nesting boxes. The platforms can be cleaned from the alley and the eggs gathered and all the feeding and watering done from this passageway.

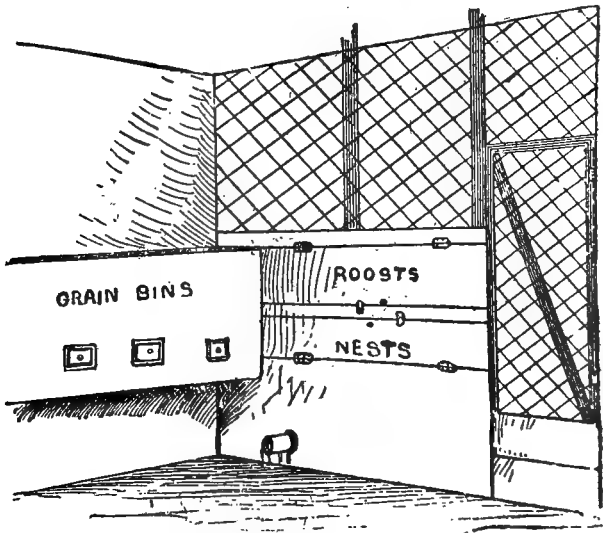

FIG. 19—A CORNER IN THE HALLWAY

A cheap house for a renter can be built of a few poles, cornstalks and straw. Make the building eight feet wide and as long as needed. Drive posts in the ground four to six feet apart and fasten poles to them with wire, making the front seven feet high and the back about four feet. Place the door and windows

and inclose the balance with cornstalks stood on end. Lay rails or poles for the roof, then cornstalks, and cover with straw to the depth of two feet, and lay on a few poles to keep the straw in place. A few poles for roosts and boxes for nests will complete the outfit, and you will have a house both dry and warm.

A-Shaped House—Probably the largest egg farm in New England is that of C. L. E. Hayward, southern New Hampshire. The place includes 800 acres and there are 6500 hens the year round. The method

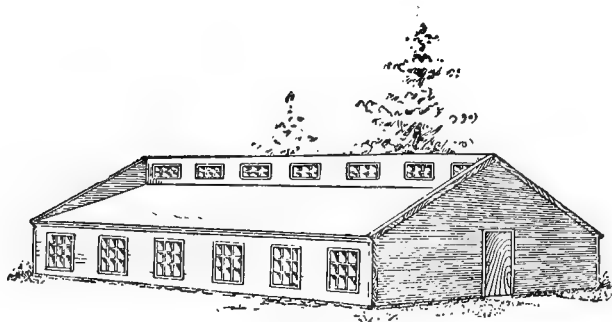

FIG. 20—HOUSE WITH PENS ON BOTH SIDES

pursued is somewhat peculiar. No chickens are raised, but the pullets are brought each fall from Vermont, where they are raised to order each year by a number of farmers. When these pullets are brought to Mr. Hayward's farm, they are at once put into A-shaped coops, like the one illustrated in Figure 21. Twelve are put into each coop, and the quarters would appear to be somewhat crowded, as there is no yard attached and the hens are never let out of the coop from the time they are put in until they stop laying the following summer and are taken out to kill for market. By careful feeding they are made to lay very well for

Missing Page

Missing Page

built tightly, if not provided with artificial means for ventilation, will become cold and damp during winter. The best ventilator is a square tight flue going straight up through the highest point of the house and extending to within a foot of the floor. It is a mistake to cut the ventilator off just below the roof. A damper or slide can be arranged inside the flue, which should be

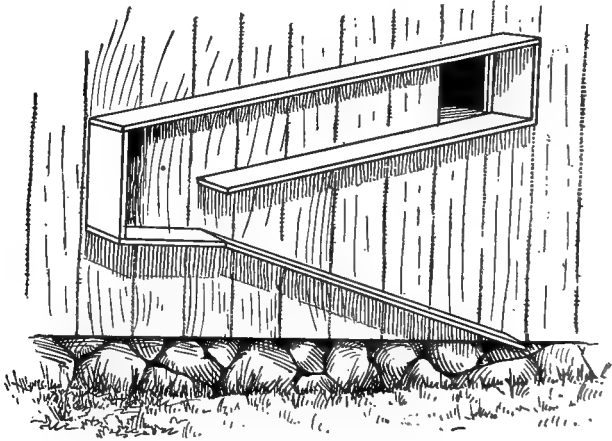

FIG. 23—RUNWAY TO SECOND STORY

about six inches square on the inside, to control the draft. This will take out the foul, damp air and create no drafts.

YARDS AND FENCES

Make the yards as large as possible for the good of the fowls. It is difficult to keep poultry in a small yard unless considerable labor is expended in spading up the earth frequently and providing an abundance of green feed, grit, etc. A small yard soon becomes contaminated with the droppings of the fowls. With the

continuous plan of houses the yard must be long and narrow. The nearer square a yard is made the less it costs to fence a given area and the fowls are more easily confined.

Wire netting is now used almost exclusively for poultry fences. There are many styles of such netting. In building a yard never place a rail at the top. It makes a good alighting place for the fowls that want to fly over. If you want to use a rail to add to the looks of the yard, either extend the netting six inches above it or string two wires several inches apart above it. This will keep the fowls from flying over. Small yards adjoining that are used for breeding purposes should have the lower two feet of fence solid in order to prevent males from fighting. Posts should be well set in the ground and ten to twelve feet apart. A six-foot fence is generally high enough for the small breeds like Leghorns, five feet for American breeds and four feet for Asiatics. A small yard needs a higher fence than a large one.

A burlap fence is useful for confining *small chickens. On many farms bran and fertilizer sacks accumulate in great numbers. Rip these open, sew them together lengthwise and nail them to strips at top and bottom with posts ten or twelve feet apart. The strips are easily taken down and if made in sections the fence can be rolled up and put away for use another year.

Shade in the poultry yard is essential for the health and comfort of the fowls. It is best provided by trees, among the most suitable of which are plum trees. They grow quickly and are greatly benefited by the fowls. A successful New Jersey poultry specialist grows blackberries in his yards. Bushes are trained high so that fruit is out of reach of the poultry. Along

the outside fences grapes or other vines may be trained to provide shade or ornament.

INSIDE THE POULTRY HOUSE

The interior arrangement should be as simple as possible in order to provide no harbor for lice or mites. The ideal plan is to have roosts, roosting platforms, nest boxes, etc., removable. The roosting platforms

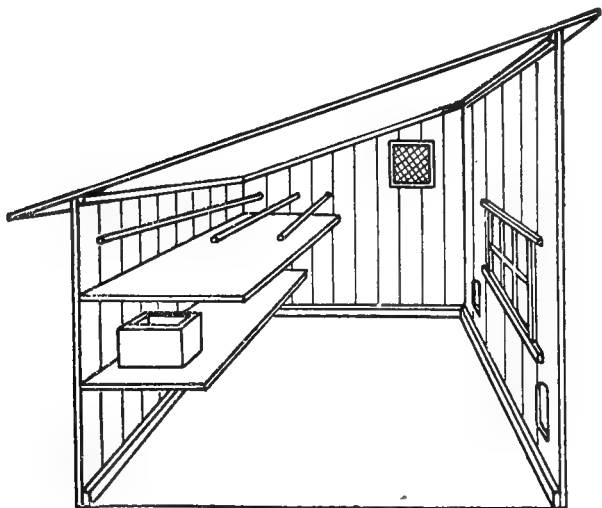

FIG. 24—GOOD INTERIOR ARRANGEMENT

should be two and one-half to three feet above the floor, two feet wide for one roost and three feet wide for two roosts. They should be built of planed, matched boards with the smooth side up. Finish the front edge with a one by two-inch strip, which will prevent the manure from falling off. Roosts may be two by three-inch scantling planed smooth, with upper edges rounded. Set these in brackets at each end.

Nests may be arranged beneath the roosting platform. Inside partitions should be built solid of boards two and one-half feet high and above this wire netting. Inside any long house there should be several solid partitions to prevent drafts. These should also extend across the alley, unless the partition lengthwise along the alley is made solid. Figures 24 and 25 show two well-arranged houses.

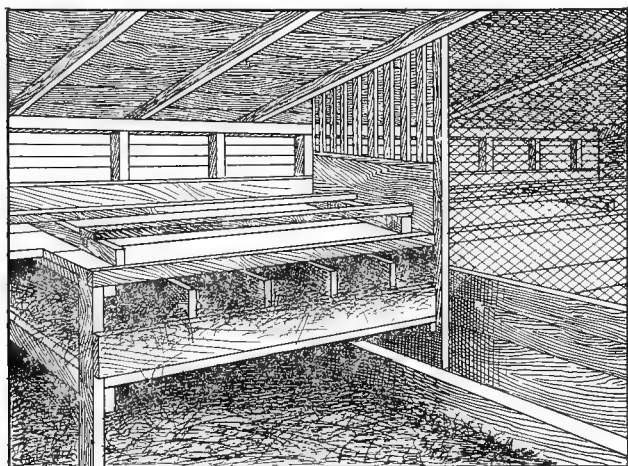

FIG. 25—WELL PLANNED INTERIOR

The nests should usually be made dark. Hens like a dark corner in which to lay and a dark nest also tends to prevent egg eating. A handy contrivance for securing dark nests is shown in Figure 26. Where the fowl house is inside another building, or has a hallway, the plan can be easily and conveniently used. Long boxes are used for the nests, each having a partition across the middle with a round opening through

it large enough for a hen to pass through. Two other round openings for each nest are made—one in the outside of the box, as shown; another in the partition. Place the box against the outside of the partition so that the two openings will come together, when the hen can enter and pass around into the dark nest. A hinged cover gives access to the eggs

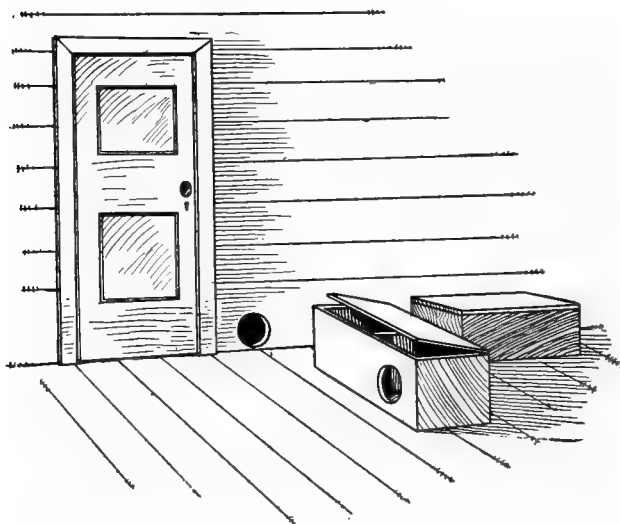

FIG. 26—PLAN FOR DARK NESTS

The trap nest is an individual nest. It should be so constructed as to be inviting to the laying hen and yet exclude the non-layer. As the hen remains on the nest until removed by the attendant, an accurate record of her product is obtained and we are able to weed out the drones and perpetuate the best by breeding from the prolific layers. At least one-third of the hens of an average flock do not lay eggs enough in one

year to pay for their food. The good layers are undervalued, while the poor layers are given undeserved credit. They may lay fairly well in the spring, yet do little or nothing the rest of the year. By the use of trap nests we learn the egg value of each hen in the flock and are enabled to handle the layers frequently, thus taming them and keeping constantly informed as to their individual condition and requirements. The individual nest system has gradually developed until now its adoption presents a practical business proposition to the market poultryman and the farmer, as well as to the fancier and pedigree breeder. The practical, simple, inexpensive yet scientific trap nest enables every poultry keeper to adopt the individual system.

The trap nest is valuable to fanciers who wish to follow line breeding or those who have a limited number of choice fowls from which they wish to establish a pedigree strain. It is the favorite device of the man who has a desire to bring up a strain of phenomenal layers, and also useful to experimenters who need to determine the results of certain crossings or matings.

Although it is possible by the use of trap nests to determine the number of eggs laid by individual hens, the impracticability of their use on a large scale is evident, since the expense of attending them overbalances, in a business sense, the results obtained. It is necessary to look at the nests during the busy laying season at least five times per day, and if a hen has laid each time it takes considerably more than the "one minute a day" claimed by more than one of the inventors to release the hen and credit the egg to her account. In looking after twenty pens of about five hens each it takes on the average fifteen minutes each time, or one and one-quarter hours per day. A person keeping 500

fowls would therefore use about six hours a day in determining how many eggs each hen was laying.

One of the best non-patented devices for keeping egg records is that used at the Maine experiment station and illustrated in Figure 27. In one of the views is shown the interior workings of the device, and in the other the completed nest. It is a box-like structure, without front end or cover, twenty-eight inches long, thirteen inches wide and thirteen inches deep, inside measurements. A division board with a circular open-

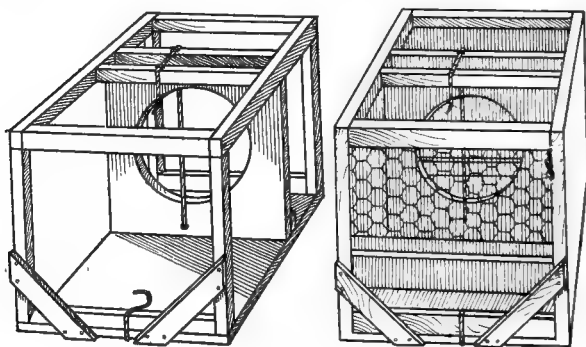

FIG. 27—MAINE TRAP NESTS

ing seven and one-half inches in diameter is placed across the box twelve inches from the back end and fifteen inches from the front end. The back section is the nest proper. Instead of a close door at the entrance, a light frame is covered with wire netting. The door is ten and one-half inches wide and ten inches high and does not fill the entire entrance, a good margin being left all round to avoid friction. It is hinged at the top and opens up into the box. The hinges are placed on the front of the door. The trip consists of

one piece of stiff wire about three-sixteenths of an inch in diameter and eighteen and one-half inches long, bent as shown. A piece of board six inches wide and just long enough to reach across the box inside is nailed flatwise in front of the partition and one inch below the top of the box, a space of one-quarter inch being left between the edge of the board and the partition. The purpose of this board is only to support the trip wire in place. The six-inch section of the trip wire is placed across the board and the long part of the wire slipped through the one-quarter-inch slot, and passed down close to and in front of the center of the seven and one-half-inch circular opening. Small wire staples are driven nearly down over the six-inch section of the trip wire into the board so as to hold it in place and yet let it roll sidewise easily.

When the door is set, a section of the wire comes under a hardwood peg or tack in the lower edge of the door frame. The hen passes in through the circular opening, and in doing so presses the wire to one side, letting the door down, which fastens itself by a wooden latch or lever. The latch is five inches long, one inch wide and one-half inch thick, and is fastened loosely one inch from its center to the side of the box, so that the outer end is just inside of the door when it is closed. Pieces of old rubber belting or strips across the lower corners are nailed at the outside entrance for the door to strike against.

A WELL-ARRANGED POULTRY FARM

A fourteen-acre farm provides a little paradise of fruit and poultry and incidentally a good living for R. G. Buffington in southeastern Massachusetts. Five hundred breeding fowls and about 1400 chickens are kept, most of them in colonies of twenty or thirty. Almost the entire farm is divided into runs varying

from one-eighth to one acre in size, and inside these runs are set pear and other fruit trees which afford abundant shade for the poultry and produce heavy crops of fruit. The wire netting for the yards is four feet wide placed above a narrow strip of scantling. The cost of netting an acre averages about \$9. The houses are six and one-half by fourteen feet, six feet high in front, four feet at the rear. Ten feet is floored and the balance is an open shed. The door opens from the shed and there is one full window in the south side. Matched hemlock boards planed on one side are used and the whole building is covered with roofing paper and painted. The studding is of two by four spruce. The houses cost about \$16 each, including labor, and accommodate twenty hens. Most of the yards are one-sixth of an acre in size.

One of the largest poultry farms in the United States is that belonging to Isaac Wilbour of southern Rhode Island, who has 100 houses and 4000 head of laying and breeding fowls. Geese are largely kept and from 1500 to 2000 goslings are raised annually. The colony plan is used over the entire establishment and the thousands of poultry are scattered over three or four large fields sloping down to the sea. About 250 fowls are assigned to the acre. The houses are of the simplest plan possible, built of rough hemlock boards and having a small window in front, and very simple arrangement inside. The cost cannot be over \$20 per house and may be made considerably less. Some of the houses have a double roof, others are single and made of rough, unmatched hemlock lumber. The roof is of plain boards not shingled, and no roofing or batting paper is used unless as an experiment. Mr. Wilbour, however, says: "We have found it more economical to shingle the roofs. We are also careful to batten the cracks, so that no direct draft can come upon the

fowls. The average cost is \$16 to \$20 per house complete. We have demonstrated that an inexpensive attachment, to serve as a scratching shed, is a good investment. As to warmth, direct drafts are always to be avoided, but we have never suffered from low temperatures. We use tarred paper sometimes inside, which is clean and healthy, but we never have been able to discover specially favorable or improved results."

The cheapest style is considered the most profitable. Built in this style there is no need of providing for ventilation, as the air is admitted through numerous cracks between the boards. The fowls are outside almost every day in the year, as there is very little snow. In summer, fresh salt breezes keep the air cool and the fowls are vigorous and active the year around. This style of house will do when the climate is not too severe.

CHAPTER IV

Breeds and Breeding

PRINCIPLES OF CORRECT MATING

The most important point in breeding good poultry is mating. This should be considered of so much importance that the utmost care should be given to the selection of our breeders. Careless or haphazard mating cannot be too strongly condemned. First, and above all, the most important point is perfect health in both sexes. The males and females should be in absolutely perfect health. A strong vigorous male bird is half the pen. No other kind must be thought of for a moment. Perfect health in the male is indicated by a brilliant red comb, smooth glossy plumage, and a general strong vigorous carriage. He should be selected with great care at least a month before he is needed, and fed well and put in fine breeding condition; but remembering always that he must not be fat. Usually a bird in show condition is not in breeding condition; but the prize winner can easily be put in breeding condition by judicious feeding and plenty of exercise. He must be a bird of few defects, the fewer the better.

I am a firm believer in size for a male. I do not mean extra large, but a well-grown and well-developed bird. Small, weak, immature birds make poor breeders, and beget weak and diminutive chickens. Good legs, large, firm, and which support the body well, are worth considering. In the females we might look for specimens which are, above all things, not overfat. After being cooped during the cold, stormy winter,

overfat is the rule, and not the exception. Fat hens are poor breeders, usually laying small eggs, and showing a very poor percentage of fertility. Plenty of green food and exercise will remedy this to a great degree. Here again we want size. I believe in large females, and can never be induced to breed from small ones. Fully developed, fully grown females are the best. This is one reason why so many breeders prefer yearling hens to pullets to breed from. Development means strength, and strength in both males and females means strong chickens. Fine points in the females are important. Good shape is of the greatest importance.

Inbreeding, which is practiced most successfully by experts, should never be attempted by amateurs. It is much better to buy new male birds every year. Keep the general health and vigor of the stock up to a high pitch. Mating breeds of solid colors, such as white and black, is carried on on simple lines, and usually on the single mating plan, which is one mating to produce both males and females. The mating of colored breeds, such as Barred and Buff Plymouth Rocks, Buff Cochins and Buff Leghorns, is usually done by the double mating system which means a separate mating to produce males, and another to produce females. It must not be understood, however, that good chickens cannot be produced by general mating. Too much skill and too much science are apt to discourage the small breeder. Careful breeders make up pens and keep them separate during the entire breeding season, gathering and marking the eggs, and even marking the chickens when hatched, in order to keep track of them for future notice. A good flock of fowls all of one breed, and of course all thoroughbreds (no other kind is worth mentioning), may be let run at large with sufficient male birds, say one to ten females,

and if the entire flock is strong, healthy, and of a good strain, the chickens will be a pretty fair lot, and will contain among them, not perhaps a world beater, but some pretty good birds for competition—and above all, they will be pleasing to look at, so that the breeder may not be ashamed of them.—[E. O. Roessle in *The Country Gentleman*.

Mating for Size—The male bird undoubtedly exercises a certain amount of influence in regard to the size and shape of the offspring; but to attempt to remedy—as so many amateurs do—the deficiency of size in their stock by the purchase of an extra large cock, is the wrong way to go to work. The hen has far more influence over both the size and shape of the progeny than the male has. Take a broad-shouldered, deep-breasted cock, and mate with narrow-shouldered hens, deficient, also, in breast, and the result of such a union will be but little, if any improvement. Had, however, the tables been turned, and the hens possessed the size instead of the cock, far greater improvement would appear in the offspring. It will be found that by breeding from large hens, and a cock deficient in this respect, that the pullets produced show a far greater improvement than is observable in the cockerels, and it is only by continuing the process of breeding from large hens that the cockerels will far outdistance the original cock. There is no question but the best plan is to have size and shape on both sides; but if a deficiency must occur on one side or the other, do not let it be on that of the hens. It is fully as important to have mature fowls of vigorous constitution. We believe that many of the poor hatches and loss of young stock can be traced to the use of overfat and immature breeding stock. In our own practice, we aim to mate a well-developed cockerel with yearling or two year old hens of large size and a cock with

large, well-matured pullets. The result has been strong, vigorous chicks that are ready to grow from the start, while the loss from sickness or disease has been nil.

In-and-in-Breeding—My observation leads me to believe that nothing is more susceptible to this evil practice than fowls, and no manner of poultry breeding can be more ruinous. It is essential that every breeder infuse fresh blood each year by securing his male birds from other breeders whose flocks he knows to be of a different strain from that of his own.—[George Underwood.

PURE-BRED POULTRY ON THE FARM

It ought not to be necessary to argue the advantages of keeping pure-bred hens rather than scrubs and dunghills, but the number of these latter classes still to be seen on the majority of farms convinces us that it is. It is now a half century since our fathers and grandfathers began practical comparisons between the Shanghais and the common barnyard fowls. The Shanghais were followed by the Brahmas, the Cochins and the Leghorns, and in the meantime our own Javas, Plymouth Rocks and Wyandottes were originated and perfected. Dorkings, Hamburgs and Houdans were tried. In all these years and with all these varieties and dozens of others, thousands of tests have been made and nearly always with the same results—the pure-bred varieties far in the lead, either for eggs or meat. Still we find the mixed and miscellaneous flocks far outnumbering the others. I am pretty familiar with poultry conditions from Maine to Texas, and yet fail to recall a single marked success in the poultry business, either eggs or meat, that has not been made either with pure-bred or high-grade fowls.

I would as soon go hunting for birds with a bulldog as to go into poultry or egg production for the market with a dunghill or much mixed flock.

The practice of top-crossing every year or two with new males of a different variety is most harmful. You can't begin to guess what you will get as a result of any particular cross on such a mixed foundation. If you cannot start with pure-bred males and females of some variety, at least be persistent in grading toward some particular point by using the same variety of males year after year. One step further let me urge: If you are breeding some variety in its purity do not even change the strain. For fresh blood, if you must have it, go back to the man from whom you got your foundation stock rather than throw away the characteristics he worked so long to secure by crossing another strain upon your females which will probably fail to "nick" with them.

The farmer is the real fancier by nature and location. All he needs to do is to rid his premises of all oddities in the feathered line, kill, eat or sell every specimen not known to be pure bred of his chosen variety, and he has made a good stride on the road to success as a fancier. So soon as his neighbors, and even the passersby, see a flock of hens in his fields "as much alike as peas in a pod" they will respond to this effective advertisement and stop to buy breeding birds or eggs for hatching. He does not need to build expensive poultry houses or high fences to keep his varieties from getting mixed. If he has but one variety the mixing of these is not dangerous. Let me urge for the farmer some pure-bred variety and but one. Two years' careful experience will convince him that he cannot afford to go back to the mixed flock of a dozen different characteristics and colors.

If his eggs are uniform in size and all of one color he can readily get five cents per dozen above the market price. If his broilers are all of one color and uniform in size in the same crate they will bring one or two cents per pound more than if a mixed lot. Uniformity counts for something. If the product is uniformly good it counts for much. The farmer, the producer, may just as well have the advanced price as to allow it to go to the middleman, who sorts up his mixed products into uniform packages and gets well paid for doing so.—[T. E. Orr, Pennsylvania.

Value of Thoroughbreds—I had a good object lesson of the greater profit of pure bloods last spring. A pen of pure bloods I received and graded, laid one-third as many eggs as eighteen times their number of mixed hens with free range. The treatment and feed were the same except the mixed hens had range of the place. Is it not an eye-opener? Then they are pleasing to the eye. I cannot afford to bother longer with loafers.—[Emma Clearwaters, Indiana.

Some years ago I ventured to pay \$1 a head for three hens and a cock of full blood White Wyandotte stock. I bred from one particular hen, a beauty, very vigorous and a persistent layer of a large, dark brown egg. I kept nine splendid pullets from her, besides selling quite a number, and then sold her and the cock for \$2 apiece, as much as I paid for the four original birds. From the nine pullets I sold the next spring during the hatching season more than 700 eggs without advertising. For these eggs I received from two to four times as much as the store prices. I might have sold many more if I had had them. I take a far greater interest in beautiful thoroughbred fowls than in the common barnyard stock. They are much more attractive, too, being all of the same color and size. Neighbors passing by and seeing them cannot resist

Missing Page

Missing Page

ing a pure-bred rooster to turn in his yard; but now, very few ever breed from anything but a pure bird, that is, if their aim is to produce winter eggs.—[William Cook.

There are different breeds of fowls that can be crossed with impunity. By exercising care and thought, birds can be produced in this way often that are superior for general purposes, and especially for poultry. They are equally as profitable or more so than either of the pure breeds used for the purpose. For instance, crossing the Light Brahma with the Barred Plymouth Rock (using the Plymouth Rock male and Brahma female) certainly improves the poultry stock. You will get fully as large birds as the pure Brahma and birds that will mature considerably earlier. This I know from recent experience as well as from observation. Many growers cross promiscuously. Not giving thought to the subject, they simply cross something with something else, often producing mongrels of the meanest type, that are comparatively worthless.—[George Underwood.

SOME SERVICEABLE CROSS-BRED CHICKENS

When eggs are wanted, such fowls as Leghorns; Minorcas and Andalusians, when freely crossed into the stock, will largely increase the egg average. Even when the hens are nearly all nondescripts, the introduction of male birds of any of these breeds will greatly improve the laying stock. An excellent cross for laying is a Minorca cock on Langshan hens. The pullets are handsome black fowls, mature early and lay good sized, tinted eggs. They are well adapted for either free range or small run and stand confinement well. The Andalusian-Langshan is another very good cross for laying, the eggs being large and mostly colored.

When big, meaty chickens are required, it is not advisable to use male birds such as Leghorn or Minorca, for the produce will be narrow and deficient of breast. There is no better cross for producing high-class table chickens than Indian Game-Dorking. The chickens are very large and carry a lot of meat on the right places. The old English Game crossed with Dorking hens results in chickens that are more tender in flesh than the Indian Game cross, but they are not so large. A fowl of great merit that is not made use of sufficiently is the Houdan. It is in most respects as good for crossing as the Dorking. Chickens from a Houdan cock, crossed with Brahma, Indian Game, Plymouth Rock, Langshan or other breeds, mature very quickly and are big, meaty birds.

For a good, useful cross for all-around purposes, there is hardly any better than the Dorking cock on Light Brahma hens. The pullets in their first season will lay many good sized, tinted eggs, while for eating purposes the chickens are excellent. Generally speaking, when table chickens are desired Dorking, Indian Game, Houdan, English Game, Langshan and Plymouth Rock cocks will all do well, whatever the breed of the hens may be.—[A. V. Meersch, Dutchess County, N. Y.]

A good cross-bred fowl for the production of eggs, as well as market poultry, is obtained by crossing White Leghorn cocks and Light Brahma hens. I. K. Felch, the well-known Massachusetts Light Brahma breeder and poultry judge, who has tried it, says that the resulting progeny is nearly as large as the Brahma in size, almost as prolific in eggs as the White Leghorn, while the majority of eggs are laid during the fall and winter months. Most of the fowls will come pure white in color and will lay dark-colored eggs. He does not advocate more than the first cross and says

that where farmers do not care to breed pure stock no better fowls can be obtained than this cross. One must necessarily keep a pen of pure Brahma hens in order to get the eggs.

THE BREEDING PEN

It will pay generally to have a house and yard for a breeding pen. In this should be placed a dozen or fifteen of the best hens and pullets and one or two fine males. These will provide eggs enough to raise 200 or 300 chicks, and give better results than if the eggs are saved promiscuously from the flock.

THE TEST OF BREED

"Uncle, what breed of chickens is the best?"

"Well, sah, de white ones is de easiest found, and the dahk ones is de easiest hid arter yo' gits 'em."

The old darkey who made the above sage remark was just about right. The white fowls, although they show off the best on a lawn or field, are easiest seen by hawks and other chicken thieves. For this reason many farmers who keep fowls on the open range prefer dark-colored birds, for the losses by hawks and crows are less. On the other hand the white fowls dress off the nicest, as the pinfeathers do not show as plainly.

VARIETIES OF POULTRY

There are thirty-eight breeds, with 88 varieties; in all 104 kinds recognized by the Standard. There are several not yet recognized by the American Poultry association. For practical purposes these can be divided into four classes, viz: those adapted for the production of meat, eggs, general pur-

poses and fancy. These classifications cannot be made arbitrary, for a breed of one class in the hands of one man may do as well or better for the production of eggs than one of the egg breeds in the hands of another poultry keeper. Any breed or variety of standard-bred poultry will, if properly handled, do well and return a profit for their keeping. If as much care and attention was bestowed upon feeding and care as upon the question of the best fowls to keep, better results would be obtained.

THE MEAT BREEDS

This term is used to designate those breeds whose greatest usefulness is the production of meat. Most of these fowls are of Asiatic origin, are of large size, compactly built and quite similar in general shape and outline. As a rule the Asiatic breeds are larger and more compactly built than the Mediterranean, broader and deeper in body, fuller in breast, with relatively shorter necks and legs. They are generally classed as poor layers and are persistent sitters, yet some strains and varieties produce a large number of eggs during the year. They lay large, brown eggs. They are more or less sluggish in disposition, becoming very tame and gentle with careful treatment, do not range far and are well adapted for small flocks and yards. Because of their large, heavy bodies they are easily confined with a low fence. Their development is slow and it requires from eight to twelve months for them to reach maturity.

The Brahmas are the largest of all breeds and are very hardy fowls. There are two varieties, the Light (Figure 28) and the Dark. The Light Brahmas are a pound heavier than the Dark variety, standard weights being, cock, twelve pounds; cockerel, ten; hen, nine and

one-half; pullet, eight. The Light Brahmas are considered good winter layers and without doubt are the best fowl for roasting purposes. They are very popular throughout southeastern New England. The

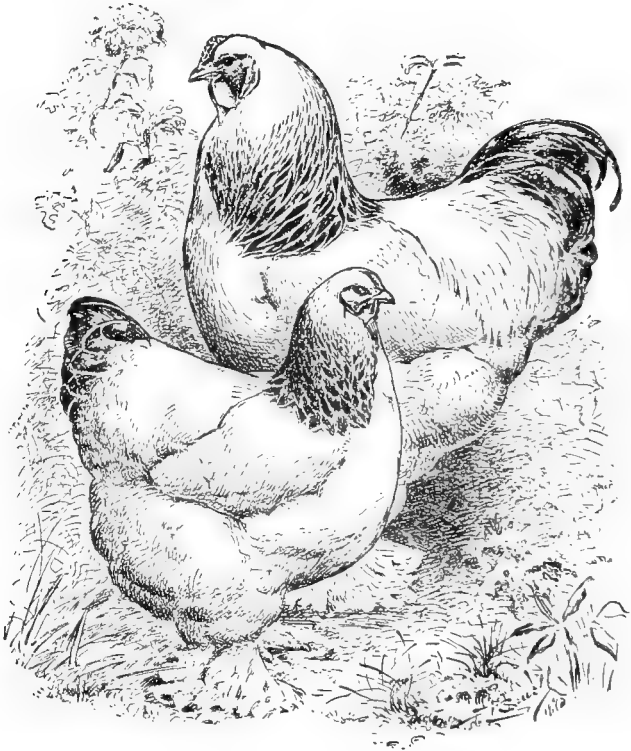

FIG. 28—PAIR OF LIGHT BRAHMAS

Brahmas have low pea combs and are heavily feathered. They need to be hatched early in order to get the pullets laying by winter.

The Cochins are distinctive in both shape and color. They are a pound lighter in weight than Light Brahmas. Cochins are the least restive of all breeds in confinement and are very persistent sitters. Of late years they have been bred with very long, loose feathers and the egg qualities have been neglected. There are four varieties, the Buff, Black, Partridge and White. The Buff Cochins are as pure buff as any of the buff breeds and they have been largely used in improving the color of other buff breeds. This variety is the most popular. They have small, single combs and are useful to the amateur who wants to keep a small flock in close confinement.

The Langshans (Figure 29) are more rangy in shape than either Cochins or Brahmas. They are one pound lighter in weight than Cochins, are good winter layers and the eggs sometimes have a purplish tint. They have medium sized combs, red ear lobes, with shanks and toes feathered, but not as heavily as Brahmas or Cochins. The tails are large and well carried out. There are three varieties, the Black, White and Blue (non-standard), the latter being quite rare.

THE FRENCH MEAT BREEDS

French poultry keepers have paid particular attention to the production of a choice quality of meat. They have several breeds which have been kept mainly for this purpose. The flesh is white, tender, juicy and the fowls heavily breasted. As they are only fair egg producers they are seen but little in this country except at poultry shows.

Faverolles are a class of cross-bred fowls which have supplanted the Houdan and other breeds in some parts of France. They are noted for quick maturity and the fine quality of young broilers and roasters.

They are a cross of Cochin, Dorking and Houdan, bred with white skin and light colored shanks, usually five toes and shanks slightly feathered, although often



FIG. 29—BLACK LANGSHAN PULLET

smooth where the Dorking blood predominates. In size they equal Plymouth Rocks and Wyandottes.

The La Fleche are a black breed with V-shaped comb of medium size, branching, and two antler-like

horns opening upward. The breast is very broad and very prominent, tail very long, full and carried rather low in males, upright and well expanded in females.

The Crevecoeurs are another black breed, having a large crest with a medium sized V-shaped comb.

THE EGG BREEDS

These include all the small or medium sized breeds that have a strong tendency toward egg production. They are generally poor sitters, of a nervous temperament, take flight readily when frightened, and the meat does not rank high for table purposes except when the fowls are young. They mature very quickly and make good broilers up to ten or twelve weeks of age. While mature fowls of some of the heaviest breeds will weigh six to eight pounds, the weight is seldom mentioned in descriptions, as egg production is the real aim for which they are bred and kept. They are somewhat tender while young and very active, quick, alert and great foragers. They do not stand confinement well and readily fly over the highest fences. Large, square yards provided with plenty of shade and hiding places are most suitable. The young birds feather very quickly, which is a great drain on the system, hence makes them delicate for a time. Nearly all of the egg breeds have large combs and wattles, hence are sensitive to cold. Some of them have such very large combs that extra precautions are needed to keep them from freezing. The egg breeds commonly kept in the United States comprise the so-called Mediterranean fowls, which include the Leghorns, Minorcas, Anconas, Andalusians and Spanish. To these should be added the Hamburg, Houdan, the Redcap, and possibly some others. They lay white shelled eggs.

The Leghorns—The present standard recognizes five distinct color varieties, viz, Black, Brown (Figure 30), Buff, Silver Duckwing and White. (See Frontispiece.) If we include shape, we can add three more—Rose Comb Brown, Rose Comb Buff and Rose Comb



FIG. 30—PAIR SINGLE-COMB BROWN LEGHORNS

White. Besides these there are at least three or four in the course of formation, not to mention the Golden, Silver Pyle and the Cuckoo, as named and recognized by the Fanciers' Club of England. The Leghorn, while a breed of great merit, is not a breed for every man and every place. Put the Leghorn in its place

and there is no fowl on terra firma that can surpass it; but if subjected to conditions that are not suitable to their wants, failure and disgust are inevitable. The person who endeavors to keep a flower garden, kitchen garden and poultry yard all in the same enclosure, will find that the Leghorn is a fowl not suitable for its environment. The Leghorns are ambitious and always willing to work, and if there is any scratching in sight they are in for it, no matter whether it is in a heap of barnyard produce or a fancy posy bed. Practically it is all the same to them. The only way that the Leghorns can be kept successfully is to provide them with quarters by themselves, or else keep everything that they can harm beyond their reach. In such a way they can be raised and bred with the best of success, and return number one results to the owner. The Leghorns are very nervous fowls and whenever danger approaches their first impulse is to get out of the way. They generally do it by using their wings, and if the yard is narrow the probabilities are they will go out. This will often be the case if the fowl sees or thinks it sees a prospect of being cornered. In a large square yard the fowl is given a better opportunity of getting out of harm's way without resorting to its wings, in fact, it does not require long before the fowl seems to forget the use of its wings as a means of getting out of difficulties.—[C. P. Reynolds in American Fancier.

The Minorcas (Figure 31) are next to Leghorns in popularity. They are of much larger size, standard weights for Single Comb Blacks being, cock, nine pounds; cockerel, seven and one-half; hen, seven and one-half; pullet, six and one-half, although they are frequently bred no larger than Leghorns, which is from one to three pounds smaller than standard weights. The standard weights for Rose Comb Black and for White are one pound lighter. They are grow-

ing rapidly in popular favor and lay very large, white eggs, but do not mature quickly. They have longer,



FIG. 31—ROSE COMB BLACK MINORCA

deeper bodies than the Leghorns, are not as wild and nervous in disposition. There are both Black and

White varieties, and single and rose comb sub-varieties.

The White-Faced Black Spanish (Figure 32), a once popular breed, are now little seen. Their practical qualities seem to be somewhat neglected through the

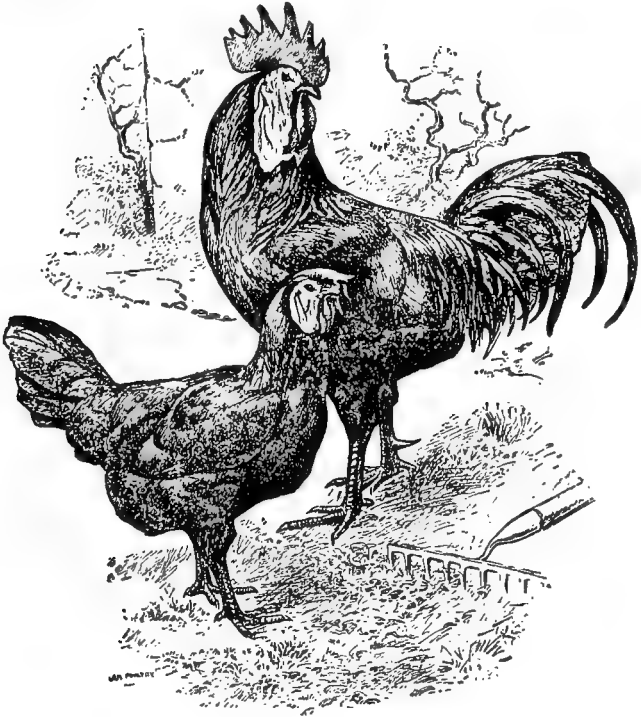

FIG. 32—PAIR WHITE FACED BLACK SPANISH

desire to breed them with large, white faces, which gives them a peculiar appearance. They are glossy black in color, lay very large eggs and the young are quite delicate.

The Andalusians are in shape and size between the Leghorns and the Minorcas. Their plumage is of a bluish gray color, but they do not breed very true,

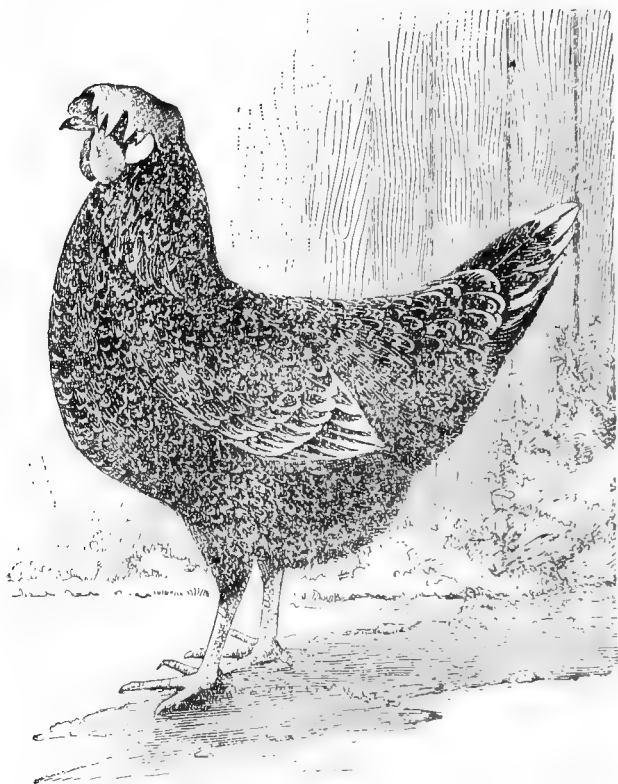

FIG. 33— ANCONA PULLET

a flock showing many shades. They are excellent layers but the color of skin and shanks is against them, the skin being white, the shanks and toes a blue or leaden blue.

Anconas (Figure 33) are comparatively rare and kept only by fanciers. They are excellent layers. The plumage is broken black and white evenly mottled.

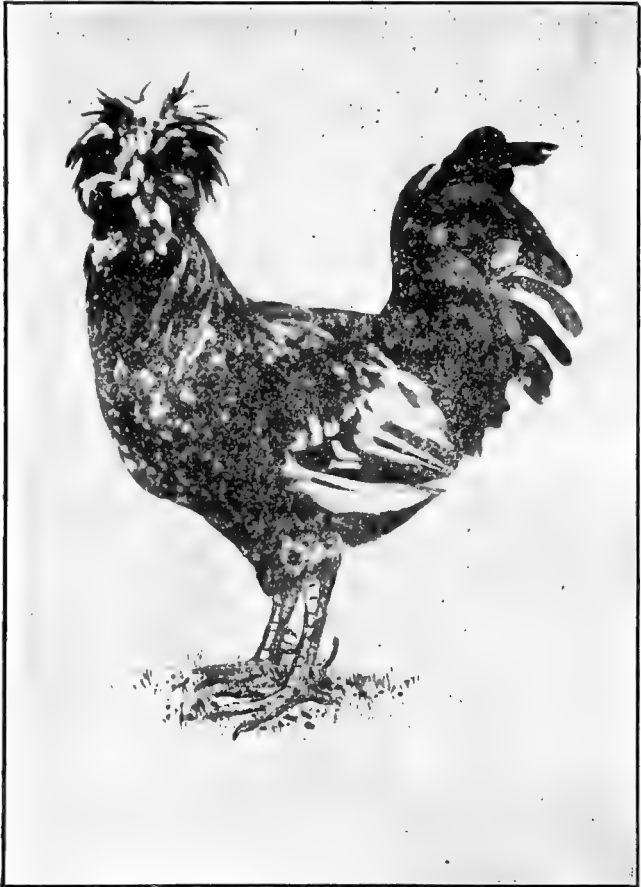

FIG. 34—HOUDAN COCK

Redcaps are another rare breed which may be aptly described as large Hamburgs with red ear lobes. Their colors are red, brown and black, each feather ending with a black spangle, shaped like a half moon. They have a very large rose comb, the larger the better for fancy points.

The Hamburgs have long been known as prolific egg producers. They are quite delicate when young and lay small eggs, but are outclassed by the hardy Leghorns. They are small, active fowls and probably no breed likes a wide range better than the Hamburgs. Their small size makes them unprofitable as table fowls, but under proper conditions they will equal the Leghorns in egg production. The recognized varieties are Black, Golden Penciled, Silver Penciled, Golden Spangled, Silver Spangled and White.

The Houdan (Figure 34) is a French breed of medium size, crested with a V-shaped comb; plumage black and white intermixed, the black slightly predominating. They are the most popular French variety bred in the United States. They rank high as egg producers and furnish a moderate quantity of fine flesh. The five toes and the crest are objectionable features.

GENERAL PURPOSE BREEDS

These include such fowls as may be profitably kept for the production of both meat and eggs, particularly under conditions that require natural incubation. These fowls are adapted to the common and general conditions found in this country. The term general purpose is relative. It is meant to cover particularly the so-called American breeds and others of like type. General farm conditions demand a fowl that is a good layer and at the same time produces an abundance of good meat. The farmer demands a fowl that is a

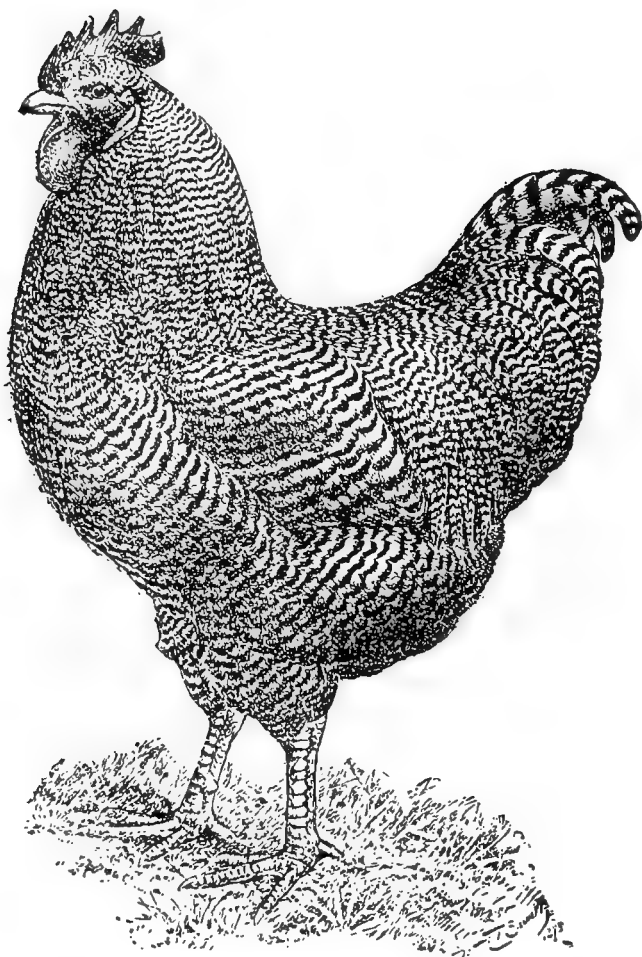

FIG. 35—BARRED PLYMOUTH ROCK COCKEREL

good winter layer and when he wants poultry for the table he wants a fowl that is big enough to make a meal for an ordinary sized family. These fowls are usually of medium size and do not go to either extreme in weight. They lay brown shelled or tinted eggs. They are bulky, have compact bodies, are of a quiet disposition, grow quickly, are hardy, good sitters



FIG. 36—BARRED PLYMOUTH ROCK HEN

and more or less good foragers, endure cold weather well and occupy a medium position between the Mediterraneans and Asiatics as regards size, egg production and docility. Some strains are as good layers as Leghorns.

Plymouth Rocks are now bred in several varieties—the Barred (Figures 35 and 36), both single and pea comb, Buff, White, (Figure 37), Partridge and the Silver Penciled. The Barred Plymouth Rock is almost

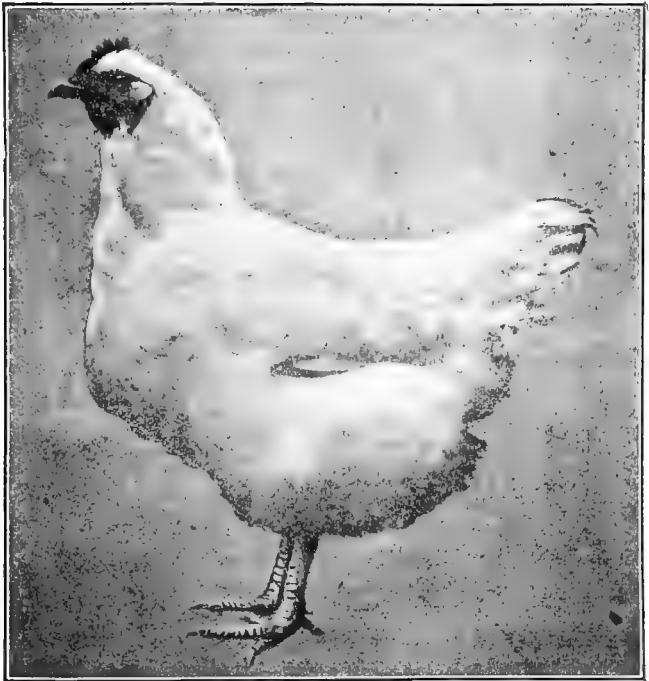

FIG. 37—WHITE PLYMOUTH ROCK HEN, SCORED $96\frac{3}{4}$

too well known to need description. It is the most popular fowl in America and is found in larger numbers and on more farms than any other breed, where it has held its own way by merit alone. It is of large size, standard weights being, cock, nine and one-half

pounds; cockerel, eight; hen, seven and one-half and pullet, six and one-half. It has a deep, well-rounded body, small to medium comb, with yellow skin and legs. The plumage is of a bluish gray, barred with narrow, parallel lines of a dark blue. They are excellent mothers, kind, and persistent sitters. Probably no

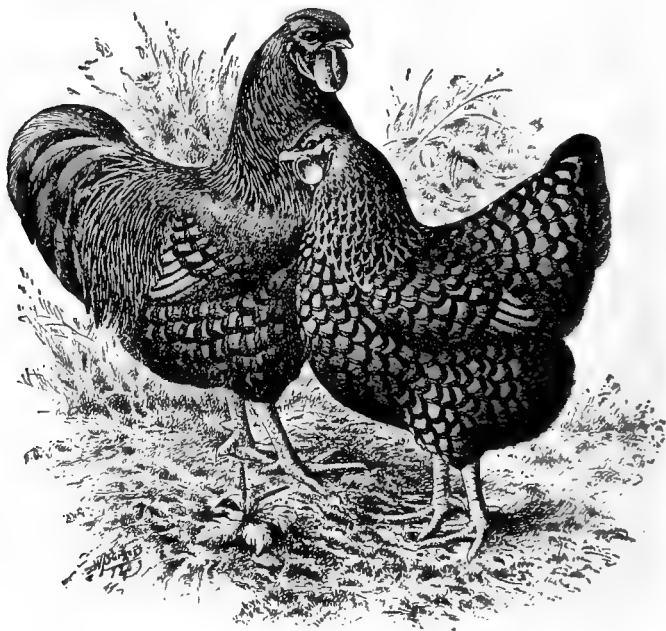

FIG. 38—A PAIR OF GOLDEN WYANDOTTES

breed better combines qualities of egg production and a large amount of good meat for the table. They rank nearly equal to Leghorns as layers. There are authentic records of over 230 eggs laid in a year. The other varieties differ from the Barred only in color of plumage.

The Wyandottes—The original stock of the Silver Wyandottes was derived from a cross of Silver Spangled Hamburg and Buff Cochin and was called American Sebrights. It was first mentioned in 1868. Later a cross of Silver Spangled Hamburg and Dark Brahma

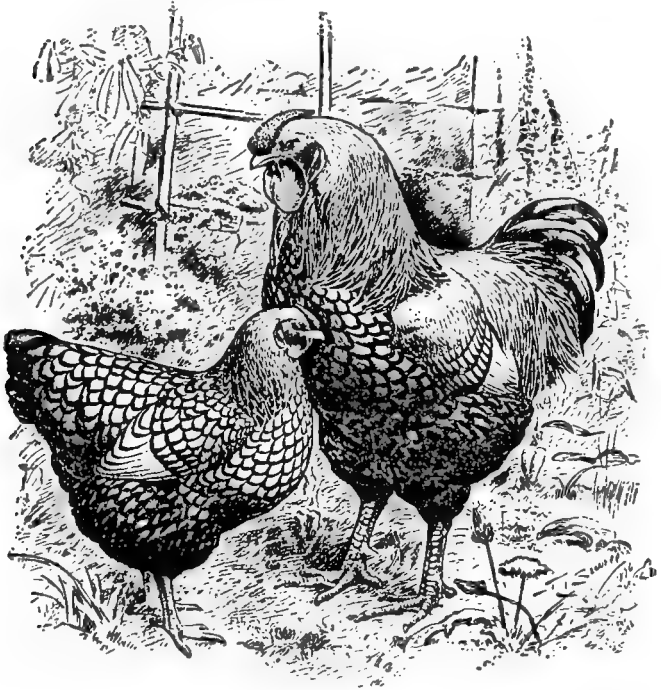

FIG. 39—PAIR OF SILVER LACED WYANDOTTES

was used on this cross, and from this sprang the present breed, which had its first boom in the early eighties. They are more blocky in shape than Plymouth Rocks and one pound lighter. They are very useful for the

production of broilers, as when well fed are always plump. For utility purposes they equal Plymouth Rocks. The standard recognizes the following varie-

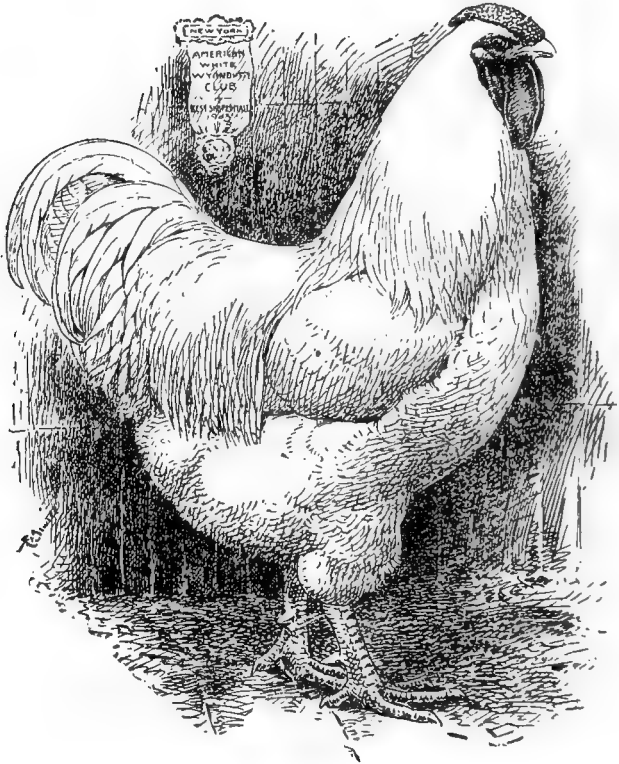

FIG. 40—PRIZE WINNING WHITE WYANDOTTE COCK

ties: Black, Buff, Golden, Partridge, Silver (Figure 39), Silver Penciled (Figure 38) White (Figure 40) and Columbian.

Rhode Island Reds are a comparatively new breed. There are both single and rose-comb (Figure 41) varieties. They are rapidly growing in popularity, particularly in New England, where they originated.

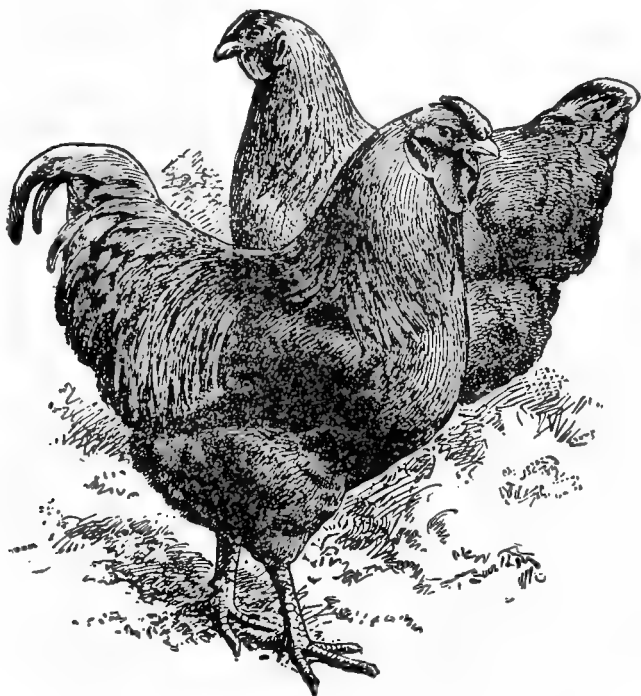

FIG. 41—PAIR OF ROSE-COMB RHODE ISLAND REDS

In color they are a reddish buff with strong tendency to variation in shade. They are excellent layers and somewhat smaller than Plymouth Rocks.

The Buckeys, recently admitted to the standard, are virtually a pea-comb Rhode Island Red and were first admitted under the name of American Reds.



FIG. 42—MOTTLED JAVA COCKEREL

The Rhode Island Whites are a Rhode Island breed which originated with J. Alonzo Jocoy. They closely resemble the White Wyandottes and they

have been bred particularly to produce roasters and broilers, but are excellent layers.

The American Dominique is one of the oldest of American breeds. The color is a grayish white, something like yet lighter than Plymouth Rocks. They are compact and hardy, have rose combs and are about the size of Wyandottes. They are a useful breed, but the larger size of Plymouth Rocks has made the latter more popular.

The Javas are a valuable, useful, non-popular breed. The lack of popularity is undoubtedly due to the color of both plumage and skin, the latter being white with black or leaden color shanks and toes. They are as large as Plymouth Rocks, good layers, sitters and mothers, mature quickly and produce a good quality of meat. There are two varieties, the Black and Mottled (Figure 42), the plumage of the latter being a mixture of black and white.

The Dorkings, the most popular breed in England, are little known in the United States. They are noted for the fine quality of meat. They have long bodies, comparatively short legs, and are rather delicate. The white skin and fifth toe are objectionable to Americans. As a breed they are rather poor layers. There are three varieties, the Colored, Silver Gray and White, which vary not only in color but in size, the Colored being the largest and the White the smallest.

Orpingtons are the newest English breed, now quite popular and attracting considerable attention. In size they rank with Plymouth Rocks. They are hardy, good layers and are a useful general purpose fowl. They have white skin and pink shanks, which is objectionable from the American standpoint. There are several varieties and sub-varieties. The Buff (Figure 43) is the most popular. There are also the White,

Black, Golden Jubilee and Spangled. They are bred with both single and rose combs.

The Indian Games can properly be put in the class

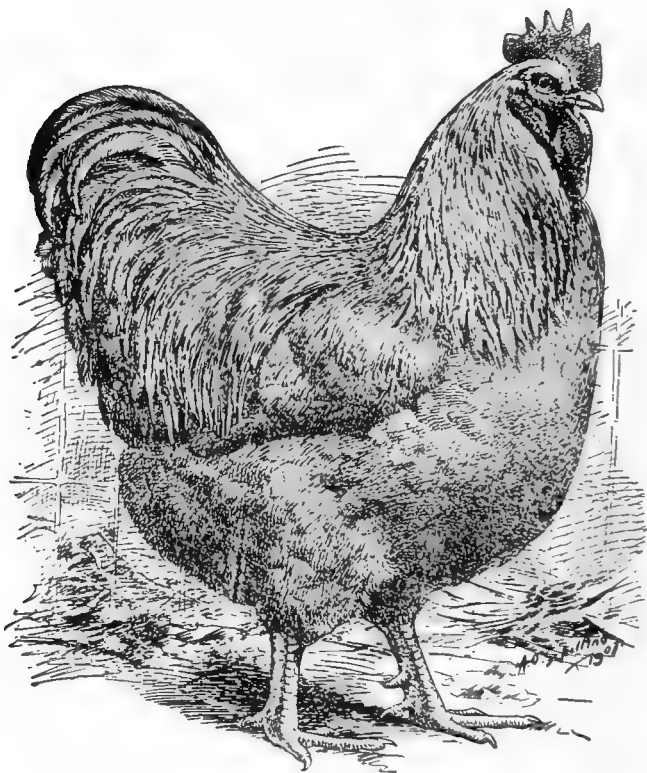

FIG. 43—BUFF ORPINGTON COCK

of general purpose fowls, although they are bred particularly for meat qualities. They are of a large size, ranking with Plymouth Rocks in this respect. They have prominent breasts and thighs, a coarse, thick head

and a small pea comb, thick, heavy shanks and tail carried low, which gives them a peculiar appearance. The meat is very firm and being closely feathered it makes

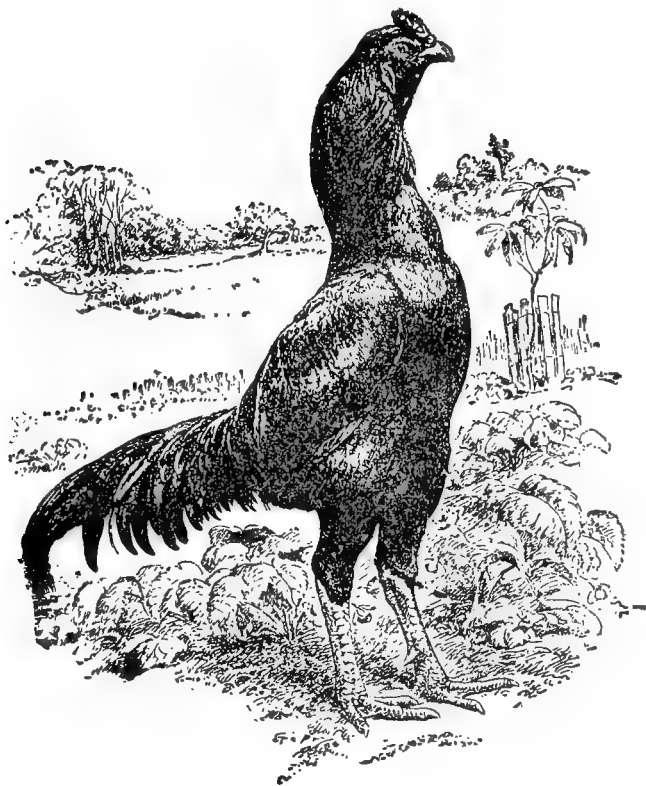

FIG. 44—CORNISH INDIAN COCK

their size deceptive as regards weight. They are rather poor layers. There are two varieties, the Cornish (Figure 44) and the White. They are very useful

to cross on other fowls in order to improve the table qualities.

THE FANCY BREEDS

In this class may be put most of the other varieties of poultry. Some of them, like the Polish, are remarkably good layers, others, like the Games, furnish the highest quality of meat for the table, yet none of them are kept in a commercial way as farm poultry. Among them are many oddities such as the Silkies, which have webless, hair-like feathers; Frizzles, having feathers curled backward at the end; Rumpless, which are tailless fowls; Sumatras, black fowls with heavy drooping tails; Russians, black bearded fowls with rose combs having no spike.

The Games include a large number of varieties and can easily be divided into two general classes—pit and exhibition. The former are prized for their fighting qualities and are bred with this one end in view. There are many strains and families with a great diversity of color and markings which are not generally uniform. They are heavily meated birds with close plumage and large flowing tails. They are very pugnacious in disposition and because of their fighting qualities are not a profitable breed to raise, as the young males when but a few months old fall to fighting among themselves and keep it up until either disabled or killed. The hens are also inclined to kill chicks of other broods. They are handsome fowls, fair to good layers, and are most profitable in small flocks. The exhibition Games are distinctive in style and type. They have been bred with exceptionally long legs, neck and head. They are closely feathered and have a small tail carried nearly level. The varieties are Blacks, Birchen, Black Breasted Red (the most popular),

Brown Red, Golden Duckwing, Silver Duckwing, Red Pyle and White.

The Polish are distinctly a fancier's fowl. The demand for them is small. They are delicate, particularly when young, good layers of white eggs and non-sitters. Their flesh is of fine quality. The varieties are Bearded Golden, Bearded Silver, Bearded White, Buff Laced, Golden, Silver, White and White Crested Black. They are very handsome in plumage.

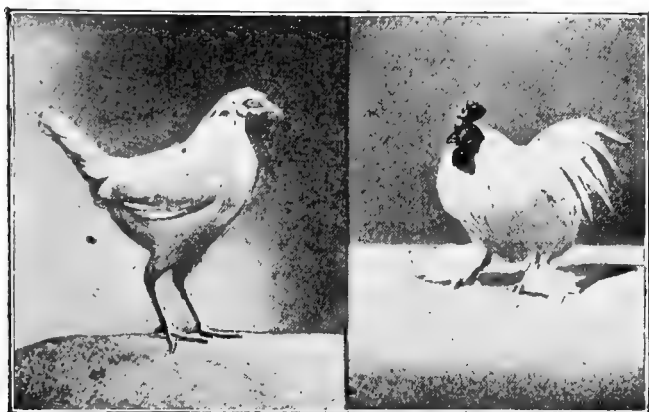

FIG. 45— { RED PYLE GAME BANTAM HEN
WHITE COCHIN BANTAM COCK

The Bantams include the dwarfs of poultrydom. They are diminutive in size but of the same shape, color and markings of the large breeds from which they were developed. Some of them are excellent layers and can be profitably kept for eggs to supply the home table where quarters are so limited as to preclude the keeping of larger fowls. There are many

varieties and the number is constantly being added to, the latest being Barred Plymouth Rock and Rhode Island Red. Recognized standard varieties are Booted White, Buff Cochin, Black Cochin, Partridge Cochin, White Cochin (Figure 45 right hand), Light Brahma, Dark Brahma, Game (same varieties as Standard Games), Golden Sebright, Silver Sebright, Black Tailed Japanese, Black Japanese, White Japanese, Rose Comb White, Rose Comb Black, Buff Laced White and Bearded White Polish, and Malay.



CHAPTER V

Feeds and Feeding

The subject of feeding for eggs demands the most careful attention on the part of the poultry keeper who would get best results. The breed, quarters, season of the year, foods available and cost, all have an important bearing. The prime function of food is to support life—to keep the body warm. Any excess over the amount required for this purpose is turned into energy of one kind or another and with fowls generally goes to eggs or growth. Therefore, to secure an abundance of eggs it becomes necessary to feed the hen such a variety and quantity of foods as will supply her bodily needs and leave a surplus that will be turned into eggs. No single food forms a complete ration for poultry. They may subsist for a time on one, but sooner or later will cease to thrive and eventually perish by starvation. It is fortunate that a variety is required, for this allows the poultry keeper to select such foods as will make up a ration to give the best results with his flock.

Corn is the most widely used of any grain in America. This because it is cheap and abundant, raised by most farmers, nearly always at hand, easy to handle and universally liked by poultry. In fact, fowls prefer corn to any other grain and when fed a mixture will pick up the corn first. But corn is a heating and fattening food and needs other grains to properly balance it. It should be fed in greater quantities in winter than in summer, and more to the active breeds than to the larger, sluggish ones

Wheat comes next to corn in popularity, but is much higher in price. It is considered a better egg producing food. The best grades of milling wheats are generally too expensive for poultry. Some of the lower grades have nearly as high a feeding value, such for instance as No. 3 Red. Scorched wheat, which is wheat that has come through a fire or has been badly heated, is generally of low feeding value.

Oats are a valuable food too little used. The only objection to them is the long spike which often sticks in the crop and causes trouble. Clipping machines are made which cut off this long end, making the kernels shorter, and such oats are sold largely in eastern cities as "clipped" oats. They weigh about forty pounds to the measured bushel. Oats are a nitrogenous food and give the fowls lots of vim and nerve. They should be fed in larger quantities in summer than in winter, and may at all times form a considerable proportion of the ration, either whole or ground.

Barley is of nearly the same composition as oats and may be fed with equally good results where it can be obtained at a reasonable price.

The above grains form the principal sources of food for poultry, but buckwheat, Kafir corn, millet and other small seeds are used to some extent.

One feed a day of ground grains mixed up with water or milk into a crumbly mash is commonly fed in winter and frequently the year round. While not absolutely necessary to use mash, this mixture forms a convenient feed in which a large variety of low priced products can be used. It is immaterial when the mash be fed—some giving it in the morning and others at night. The danger is in overfeeding during fall and winter when fowls are not laying, and getting them too fat. They will eat more food in mash form in a given time than they will of whole grain. A good plan

is to feed only what they will eat clean in five minutes, then give them a little grain in an hour or two in the litter to keep them busy.

A comparison of feeding a part of the ration in the form of ground grain with the entire ration composed of whole grain has been made by the West Virginia experiment station, and the result is published in Bulletin 83. One flock of fowls was fed a mash in the morning, a second flock a mash at night, and the third flock had only whole grain. Results showed very little difference between feeding the mash in the morning or at night, but a material gain in egg production in the use of a mash in comparison with whole grain. The pens which were fed mash at night laid 1166 eggs, the pens fed mash in the morning 1159 eggs, and the pens receiving whole grain 1006. Trials with yearling hens gave a less difference in favor of the mash.

Somewhat similar work has been carried on by the New York experiment station at Geneva, with White Leghorns and Buff Cochins. The Leghorns having their grain food only dry and whole, ate more food at greater cost per fowl and for the live weight than did two similar lots having about thirty-seven per cent of their grain ground and moistened. With the Cochins better results were obtained where all the grain was



FIG. 46—FEED TROUGH

fed whole. This was probably due to the benefit derived from having to scratch in the litter for it. The Hatch experiment station of Massachusetts has found but little difference in the number of eggs produced from feeding the mash in the morning or at night.

In the winter egg laying contest conducted by Farm & Home from November 1, 1906 to April 1, 1907

the feeding of mash once a day gave rather disappointing results. There were over 7000 hens in this contest. The greatest egg yield and profit was obtained from those flocks which had dry ground grain constantly before them in hoppers. They produced an average of fifty-six eggs per hen during the five months at a food cost of forty-five cents. The flocks fed entirely on whole grain produced an average of forty-seven eggs per hen at a food cost of thirty cents, while those fowls which had one or more feeds a day of a mash averaged thirty-eight eggs each at a cost of forty cents for food.

The mash is commonly fed in troughs. A good one is shown in Figure 46. This is made of a piece of board six inches wide and three feet ten and one-half inches long. That is nailed securely to two "feet," which are pieces of two by four-inch scantling a foot long each on the bottom, but scarfed off to about seven or eight inches on top; these are set about five inches in from the ends. The end pieces are seven inches high, six inches wide at base, and narrow to two and one-half inches at top; the sides being perpendicular for one and one-half inches, and then narrowing. The ends are nailed on to the bottom board, and the top strip, of two and one-half inch furring, is inserted between the ends and nailed—this last point being to guard against the nails drawing out when the trough is lifted by the top, which serves as a handle. Good clear laths nailed along the sides and to the end pieces, make a sufficient side guard to the trough, projecting three-quarters of an inch to an inch above it, which is ample protection for the food put upon it. When this trough is intended for outdoor use a quarter-inch hole is bored in each corner, to allow the water to run off during a rain.

Some use a self feeder for the grain and feed only a whole grain ration. This will answer with Leghorns and other active breeders but is not so satisfactory for the larger breeds, which get too fat and stop laying if feed is constantly before them. The self feeder consists of a hopper which exposes only a little grain at once. It is simple in construction and may be of any size desired, but for thirty or forty hens it should be about one foot wide, three feet long and one and one-half feet high. A good pattern is shown in Figure 47. The

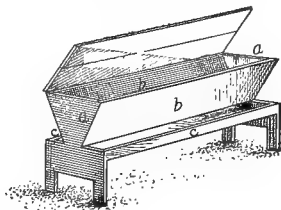

FIG. 47—SELF FEEDER

ends, *a a*, should be cut as shown, then a board as wide as the ends and as long as the feeder should be nailed horizontally between the ends as they stand upright and four inches below the shoulders. Cut the sides, *b b*, and nail in position, next make a V-shaped trough as long as the feeder and invert between the lower edges of *b b* to keep the food from running out too much at once. Nail on strips, *c c*, which should be four inches wide, and put on a cover with hinges.

A very simple and successful feeder for dry ground grains, beef scrap or other feeds consists of a



FIG. 48—FEED BOX

shallow box (Figure 48) four inches inside, nine to twelve inches wide and of any length desired. Around the top fasten a rim projecting one to one and one-half inches inside which will prevent the fowls from throwing out the feed with their bills. Without this projecting rim there will sometimes be much feed scratched out and wasted.

A self feeder and exerciser is shown in Figure 49. It is a box two feet long, eight inches wide and ten to twelve inches high with a V-shaped trough inverted in the bottom to throw the grain at either side. The

lower four inches of the feeder on each side is covered with one-quarter inch mesh wire netting which keeps the grain from running out while the fowls can take out a kernel or two. The feeder should be hung so that the fowls have to

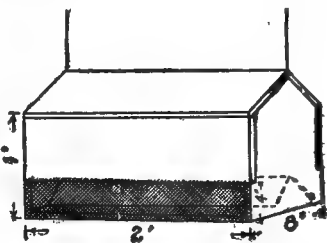

FIG. 49—SELF FEEDER

jump from six to twelve inches to get at the grain. This feeder has been used very successfully by a large eastern breeder.

It is generally considered that poultry like a variety of food and do better when the rations are frequently changed than where one or two things are fed continuously. An Iowa poultry keeper, who has been very successful in securing winter eggs, varies the ration from day to day and feeds as follows: Monday morning, sheaf oats; night, warm mash; Tuesday morning, vegetables; noon, cut green bone; night, cracked corn scattered in litter; Wednesday morning, sheaf wheat; evening, warm mash; Thursday morning, vegetables; noon, whole wheat in litter; night, whole corn and crushed oats; Friday morning, vegetables; noon, green cut bone; night, cracked corn in litter; Saturday morning, sheaf wheat; evening, warm mash; Sunday morning, vegetables; noon, whole wheat in litter; night, whole and cracked corn and wheat in litter. The sheaf wheat or oats fed in the morning keep the fowls busy all day, so that no more feed is required. The mash consists of cooked potatoes or

vegetables, cut clover and beef scraps, all mixed in a crumbly mass with some bran, shorts, chop feed, a little oil meal and salt, and sometimes a little powdered charcoal. Clean, fresh water is given them twice a day and oyster shells and grit are kept before them at all times. The houses are dry and warm and the fowls are fed only as much as they will eat up clean.

The flavor and quality of the eggs are greatly dependent upon the food given to the fowls. Healthy hens, fed on wholesome corn and allowed a free range, supply eggs that have a very consistent white and yolk of a bright yellow color. These eggs are well flavored and nutritive. Hens badly fed, that have to seek their food, not in the open country, but in dirty manure heaps and similar places, where they come across decomposing carcasses, especially if these latter be fish refuse, produce eggs with thin albumen or white, and, when cooked, are very unpleasant to both smell and taste. Fowls having free range during the summer pick up all the green food and animal matter in the shape of bugs and worms which they need. When confined to small pens and yards, or in the winter time when such things cannot be procured, they must be supplied artificially.

Animal food in some form is required in winter as well as in summer. Green cut bone forms a cheap and good food where the bones can be procured. By green bone we mean bones fresh from the butcher, with the adhering gristle, meat, etc. Every meat shop has a great deal of this waste material, which is unfit for market, and which finds its way to some soap factory, or is thrown to the hogs. Sometimes there will be several large pieces of meat which the butcher cannot sell. These pieces add a great value to the bones. Then on the farm there are a great number of joints and pieces of waste meat and bone which are thrown

to the dogs and cats, which ought to be put to better use.

Green bone contains the natural juices as well as the adhering substances. This makes it superior to the bones that have laid on the ground for years, and lost all the natural juices or animal matter. Green bone, having the animal matter in it, is quite soluble and easily assimilated by the digestive organs of the fowl. It is an easy matter, since the introduction of the bone cutter, to prepare green bone and meat for the hens. Green bone cannot be ground, but must be cut. A good cutter can now be purchased for \$5 and upward. The value of green bone lies in its well proportioned and numerous constituents, which are just what is needed by the hen to produce eggs. In it we have lime for the shell, mineral matter for the yolk, and albumen for the white. It is as near an all round food as any one food can be. There is only one objection to it, and that is that it is somewhat concentrated. If hens are fed on it entirely, they will eat too much; hence it is necessary to feed it in connection with some bulky food, such as clover or bran. A good method of feeding it is to give about a handful to two or three hens three times a week, but all depends upon the conditions to which the fowls are subjected. Too much meat or green bone will cause bowel disease, and should be fed carefully. It should never be fed when tainted or moldy, or it will cause trouble at once in the whole flock.

Running a bone cutter is hard work and the cut bone does not keep well. For this reason many prefer to use some of the prepared animal meals or meat scraps which contain but little moisture and keep a long time. It gives nearly as good results and can be handled with much less hard labor. Fish, where they can be procured cheaply, make a good food. Milk is

a very nutritious food not used as much for poultry as it should be. Fowls are very fond of it.

Skimmilk is a food which contains muscle and flesh forming material in a form to be readily taken up and digested by the system. Milk that has been skimmed has really lost but a small amount of its value as a food, the cream consisting of considerable fat, which in itself is the least nutritious part of the milk. The cheesy matter left in the milk is its most valuable part for food, and tends to produce a vigorous, healthful growth when fed to calves, pigs and chickens. If more American pigs and chickens were fed less corn and more skimmilk, it would not only be to their lasting benefit, but it would also eventually result in financial benefit to the farmer.

Green Food—A variety of vegetables are available for this purpose in winter. Chief among them is cabbage. Mangels, beets, carrots, parsnips, apples, potatoes, celery trimmings, etc., are all useful. Well preserved corn silage is greatly relished and makes a fine food. Well cured clover or alfalfa hay is splendid either whole, cut or ground. Cut clover and alfalfa, as well as clover and

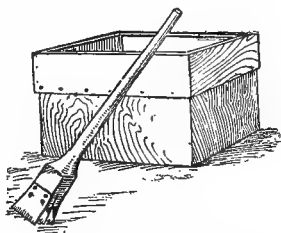

FIG. 50—CLOVER CUTTER

alfalfa meal, are now commercial articles with feed dealers. If fed whole the fowls will pick off all the heads, leaves and much of the fine stalks. Clover or alfalfa can be run through a cutter, but where such a machine is not at hand, a homemade cutter, such as shown in Figure 50, can be devised. Take a stout block of wood, with smooth top, and build a box about it, using the block for the bottom of the box, as shown in the cut. The cutter is a pestle-shaped

affair, square at the lower end. To this are attached three sharpened steel plates, as suggested. Set them into the wood and bolt securely. Any blacksmith can make these plates, and they can be sharpened on the grindstone. With this, one can cut up clover as the housewife chops meat in her tray, but a few moments being required to cut sufficient for a large flock.

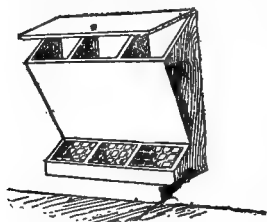

FIG. 51—GRIT BOXES will answer the purpose. Coarsely ground dry bones are also useful. These substances should always be kept before the fowls in boxes provided for this purpose. An excellent box for supplying these is shown in Figure 51. It is self-delivering, but the grating or wire netting over the front keeps the fowls from throwing the material out with their bills, and thus wasting it.

For preparing the grit a homemade grit machine can be built any size, and any lumber will do. The construction of the machine can be easily studied out from Figure 52. My crusher is made up as follows: Two supports, *a a*, each four feet, six inches long, of four by four-inch lumber resting on board supports, *c*, two feet long and six inches high. Nail on the four cross pieces, *b*, four feet long, size one by four inches. Make the two crushing arms, *d*, each five feet long and of four by six-inch lumber. The lower five inches are beveled off so that the two arms work together something like a hinge. Just above the beveled part, attach an iron plate, *h*, four by six inches and one-quarter inch thick, against which the stone is crushed.

Make a hole, *l*, in the lower end of each crusher arm for an iron pin. The smaller cut at the right shows the details of the crusher arm. There must be space enough at *m* to let through the fine-crushed stone. The handle part is made as follows: The central block, *g g*, is of four by four-inch lumber and two feet long. It is attached by a bolt through the middle of the handle, *k*, which is five feet long and strengthened by side pieces fastened to the main block by tight bolts at *i*, passing through small blocks two by two by two inches at *g*. The four connecting strips, *e*, are of one by two-inch stuff bolted at one end loosely to *g*, but at the other end tightly to *d*. The machine is now complete except to nail boards, *j j*, on the sides to keep in the stones.

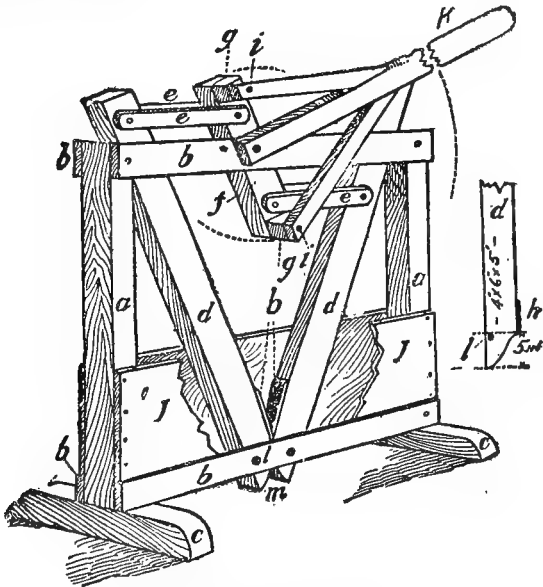

FIG. 52—GRIT CRUSHER

METHODS OF SUCCESSFUL POULTRYMEN

Growers say that the way they feed and take care of their hens leaves only two alternatives; either lay, or die, and they choose the former. The boiler and the boiler house are essential preliminaries of the farmer poultryman's outfit. From the infant chicken to the mature hen, the food can be cooked to advantage. Chickens just hatched will not need much food for the first day or two, and for the first week they need to receive delicate treatment. A food which has been successful is composed of cracker crumbs and hard-boiled eggs with a little milk, while others use wheat bread softened with milk.

For the first month the chicks should be fed at least five times a day; early in the morning, at 9 a. m., at noon, at 3 p. m. and just before dark, being a convenient arrangement. After the first week the chickens may receive for their morning food the same as the larger poultry, although some even then abstain from giving them meat scraps. For the afternoon feed, give wheat or cracked corn which has been swelled.

The food for the matured hens consists of meal and shorts, about twice as much of the former as of the latter, and some meat scraps, from one to two quarts to 100 fowls. These three elements should be mixed the night before being used. To this mixture other ingredients may be added, such as wheat, cracked corn and oats. In the winter, vegetables, such as carrots, turnips, onions or potatoes, should be cooked with this soft feed, several times a week. Sometimes a small quantity of clover hay is mixed in.

Milk is a valuable food for hens, and if the food is cooked with the skimmilk, profitable results will be sure to follow. If more milk were fed to poultry

instead of to the hogs, the farm income would be larger. Even sour milk, scalded until it becomes curd, is valuable.

If a small amount of charcoal be powdered and cooked with the food once a week, it will keep the fowls in a healthy condition. Care should be taken not to put in too much charcoal, since it would make the food black and probably would not be touched. Occasionally a very little salt and pepper should be added. The afternoon food need not be cooked, and may be of corn or oats.

Mr. Hunter's Successful Way—This account is by A. F. Hunter, formerly editor of *Farm Poultry* and of *The Practical Farmer*. His wonderful success in profitable egg production attracted much favorable comment. He writes as follows:

“Five mornings of the week we feed a mash made up of about a third cooked vegetables mashed fine, or cut clover cooked by being brought to a boiling heat in water, an equal amount of boiling hot water added, a heaping teaspoonful of salt to a bucketful; a heaping teaspoonful of condition powder two days, then powdered charcoal one; and into this is stirred mixed meal, until the mash is as stiff as a strong arm can make it. This mixed meal with us consists of one part each corn meal, fine middlings, bran, ground oats and meat meal, a scoop or dipper of each being dipped in turn into a bag and poured from the bag into the meal barrel, from which it is dipped into the mash. We consider the thorough mixing of these meals a considerable factor in making a good mash.

“When we have cut fresh bone in abundance we omit the meat meal from the mixture; ordinarily we have only about half rations of cut bone to go around, so use, regularly, half the amount of meat meal to make up the deficiency.

“An excellent mixed meal consists of equal parts corn, oats, barley and wheat ground up together and kiln dried before bagging for shipment. We consider it not quite sufficiently nitrogenous, so add from a quarter (in winter) to a third (in summer) of shorts to it. As it is not always easy to get germ meal of our grain dealers about here, we make up the mixture as above, and the fowls will complain little of that mixture in their mash. The foundation of the mash is the cooked vegetables, which may be refuse potatoes, beets, carrots, turnips, onions (anything in the vegetable line), and into the pot goes the table waste, potato parings, etc., and the potato, squash and apple parings from the kitchen. The potatoes, or beets, etc., are washed before putting on to cook, and the mess when boiled is sweet and savory. If one has a set kettle in which to stir up the mash, and there leave it to cook in its own heat and the heat of the brick work, they are fortunate. We haven't, and have to make ours up in common water pails.

“The vegetable or clover kettle is put on before sitting down to dinner, usually, and another kettle of water to be boiling hot when wanted. When the vegetables are cooked, we set out four buckets in a row, dip out the vegetables into the buckets about equally, mash them thoroughly, add the salt—always—and the condiment of the day, add boiling water until the bucket is two-thirds full, then stir in the mixed meal till it is stiff and firm; then cover and set away to cook in its own heat. Clover rowen (second crop clover) cut fine makes an excellent foundation for the mash and two or three days of the week in winter we use that instead of vegetables. We fill two kettles with the cut clover and as much cold water as they will conveniently hold, and heat to a boil. The clover is ladled out into the buckets about equally, the clover tea added and

boiling water as before, then salt and the stimulating condiment and the meal stirred in.

“This mash contains a great variety of food elements, and this variety is a quite important factor. A fowl needs a variety of food to supply her various physical needs, and give her a surplus out of which to make eggs, and this ‘variety’ of foods we believe we can best attain in the manner described above. An additional advantage is that a tonic or stimulant can be added if desired; we sometimes substitute a teaspoonful of tincture of iron for the condiment, and sometimes add a handful of linseed meal or cottonseed meal; but the latter are somewhat fattening as well as stimulating and those who feed their fowls well must beware of too fattening foods. Some poultrymen make a practice of stirring up the mash scalding hot in the morning and feeding it at once. In that case the meals are simply scalded—are not cooked. By our method the meals are semi-cooked and more immediately available for assimilation; hence we prefer making up the mash the afternoon of the day before and having it semi-cooked when fed, to having it fed hot but only scalded.

“This morning’s mash is fed in troughs large enough so that all of the fifteen fowls in a pen can get about it at one time; another important factor because if the trough is small some of the birds have to stand back and wait for second table and when their chance does come there’s nothing left for them. With a trough four feet long by six inches wide, there is plenty of room, and if a bidy is driven away from one place, she runs around and goes to eating at another, and thus all get a share.

“Our fowls have exercise ground in summer, in yards 125 by twelve feet, which give them a grass run with growing grass always in the growing season and

they will take ample exercise in pleasant weather. To keep them out of doors the noon feed of whole barley (or buckwheat) and night feed (before sunset) of wheat is scattered upon a graveled space immediately in front of the houses. Each family of fifteen has a pen within the house twelve feet square, or 144 square feet of floor space, which gives about ten square feet per fowl. The floor is the earth covered about six inches deep with screened gravel. On this gravel inside the house the grain is scattered in stormy weather, in spring, summer and early fall, when we want the birds to stay indoors. When cold weather approaches, exercise must be stimulated, and we cover the pen floors three or four inches deep with meadow hay or straw, into which the grain is scattered, and the biddies have to dig it out. Some poultrymen use dry leaves for pen litter; chaff from a threshing mill, or buckwheat hulls, would be most excellent, nothing could be better; and we have found one or two cases where common corn-stalks were used. With us, straw or meadow hay is most easily obtained, and we use that. What the scratching material is, is of far less importance than that the scratching material is there.

“Whole wheat is the best grain food for fowls, whole barley is the next best, and buckwheat next. We make barley or buckwheat the noon feed five days in the week, and wheat the night feed five or six days in the week. We do not make the mash on Sunday, because we want to reduce the work to its lowest terms on that day, doing no more than the regular feeding and watering and collecting the eggs.

“Monday we feed oats (or barley), wheat, whole corn; Tuesday, mash, barley (or buckwheat), wheat; Wednesday, mash, cut bone, wheat; Thursday, oats, barley, wheat (or corn); Friday, mash, barley, wheat; Saturday, mash, cut bone, wheat; Sunday, mash, bar-

ley (or buckwheat), wheat. Two feeds of cut bone each week, one or two of whole oats, and one or two of whole corn (according to season), give variety to our ration, and to that are added whole cabbages hung in the pens in cold weather to tempt picking them to get green food; or turnips, beets or carrots are split in halves and placed in the pens to be picked in pieces and eaten. Grit and ground oyster shells are always accessible, and fresh water, replenished three times a day (warm in winter), and the water pans are carefully rinsed every day.

“We vary from this program in winter by feeding a slightly lighter feed of mash in the morning, making it a breakfast rather than a full meal, and then scatter barley or buckwheat in the scratching material about midforenoon, to induce even more scratching exercise. To search and scratch for seeds, grains, insects, etc., is the fowl’s normal method of feeding, and the nearer we approximate to Nature’s way, the better; hence the greatest possible amount of exercise should be compelled.”

Prof. Gowell’s Methods—The methods practiced by Prof. G. M. Gowell of the Maine experiment station in feeding poultry should command attention, for no experimenter has done more or better work in the breeding and handling of fowls for eggs. For over twenty-five years Prof. Gowell has been at work with the same family of barred Plymouth Rocks and has learned several ways to feed and handle them to secure eggs and to avoid the losses which are so common to mature hens of that breed from overfatness. Several years ago he gave up the morning mash and fed it late in the afternoon with far better results. The full meal in the morning produces laziness, fatness and soft shelled eggs, but these bad conditions and results were not

encountered when the birds were required to eat slowly and exercise by digging the hard grains out of the straw bedding.

The birds were fed throughout the year daily as follows: Each pen of twenty-two received one pint of wheat in the deep litter early in the morning. At 9.30 a. m., one-half pint of cracked corn was given in the litter as before. At 3 p. m. in winter and 4 p. m. in summer they were given all the mash they would eat up clean in half an hour. The mash was made of the following mixture of meals: 200 pounds wheat bran, 100 pounds corn meal, 100 pounds wheat middlings, 100 pounds linseed meal, 100 pounds gluten meal, 100 pounds beef scrap. The mash contained one-fourth of its bulk of clover leaves and heads obtained from the feeding floor in the cattle barn. The clover was covered with hot water and allowed to stand for three or four hours. The mash was made quite dry, and rubbed down with the shovel in mixing, so that the pieces of clover were separated and covered with the meal. Cracked bone, oyster shell, clean grit, and water were before them all of the time. Two large mangolds were fed to the birds in each pen daily in winter. They were stuck onto large nails which were partly driven into the wall a foot and a half above the floor. Very few soft shelled eggs were laid and so far as known, not an egg has been eaten by the hens during the last five years.

The records of several years' feeding show that from fifty to fifty-five pounds of dry meals, not including the clover leaves of which the mash was made up, were eaten by each hen per year. The quantity of grain fed in the litter was the same every day, winter or summer. The quantity of mash was variable, being all they would eat in an hour at the close of the day. They ate more in cold than in warm weather; also con-

siderably more when they were laying heavily than when they were yielding few eggs.

The feeding above described was with hens in a house kept warm enough by hot water pipes, so that the temperature was above the freezing point at all times. The amount of food required by the birds kept in this house for several years was always less during the winter season, than where birds were kept in the colder houses.

In addition to the fifty to fifty-five pounds of mash, the hens in this house have averaged each year 18.2 pounds wheat, 6.4 pounds cracked corn, 5.8 pounds of oats, 5.9 pounds oyster shell, 3.2 pounds dry poultry bone, 2.9 pounds mica grit; and forty pounds man-golds. The straw for litter has averaged thirty-six pounds per bird. The birds, fed and housed as above described, have averaged laying about 150 eggs each.

Another method which has been coming into prominence of late is the feeding of the ground grains dry instead of a moist mash. Fowl do not at first take readily to the dry mixture, but when accustomed to it they will eat considerable quantities. The best practice is to keep it in self feeders and allow the fowls access to it at all times. There is no danger of their over eating.

Experience in Feeding for Eggs—The great egg yield obtained by C. H. Wykoff, a New York state breeder of White Leghorns, provoked extended comment. Following is a summary of his feeding methods: All the fowls are fed three times daily. In the morning they are given a ration composed half and half by weight of wheat bran and a mixture made of equal quantities by measure of oat and corn meal. This is scalded. At noon a little grain, a mixture of oats, buckwheat and wheat in equal parts, is scattered on the floors lightly to induce the fowls to scratch for

exercise. At night they are given all they will eat of the grain ration. Sour skimmed milk forms a daily diet and would easily take the place of meat if it could be obtained in sufficient quantities. As it is, every other day each group of sixty fowls receives about one and one-half pounds of pressed meat. Ground oyster shells are continually accessible. About four and one-half quarts of green food is given daily to each lot, consisting of cabbage, turnips and beets in winter, grass in spring and sea kale in summer. Salt is the only condiment fed, stimulating commercial feeds having long ago been abandoned as dangerous. Clean clover hay, chopped fine and mixed with corn meal and steamed, is frequently fed, but only in small quantities, as it is found to be too bulky for the crop.

W. H. Rudd's Ration—"My morning feed consists of corn meal and fine feed in equal parts, ground beef and scraps, and in the winter boiled potatoes. This is all mixed together with hot water, adding a little salt and egg food. This is fed as soon as the fowls can see to eat, except in the longest days in summer. This feed is put in troughs eight feet long, eight inches wide and three inches high. The ends are put in so the bottom of the trough will be three inches above the 'ground. This same trough is used for the dry grain on stormy days, and in all winter weather. At other times the grain is fed in the yards. For dry grain feed, I use equal parts of whole corn, oats and wheat. This grain is mixed together in a basket that holds three pecks, and I always use a two-quart flour scoop to deal out both wet and dry feed. This mixture is fed twice a day, morning and night. I never feed in the middle of the day or disturb the hens in the least. I want them to spend all the time they want in laying eggs. I used to feed at noon, but found if

all the hens were called off the nest to eat dinner the same number would not go back again that day.

"Four to six quarts of feed per day for twenty-six hens would be about right. If large Brahmas, they require more; if Leghorns, less. The proper way is to give them what they will eat up rapidly. Wheat screenings contain a large quantity of foul seed; some of them the hens will not eat and of course they will take root and grow. We have known hens to die from eating the seed in screenings. It is better to feed good wheat. A good winter feed for laying hens is equal parts corn meal and fine feed; add to this one-twentieth as much ground beef scraps and some boiled potatoes, mix with hot water and feed every morning. Give whole corn, oats and wheat in equal quantities at noon and night, giving a light feed at noon and all they will eat at night."

Farming for Eggs—This account of the methods employed by the poultry specialists of southeastern Rhode Island is given by D. Myron Greene who has spent several years in that section.

The houses need not be costly, but they must be dry, warm and well ventilated. A convenient size is from eight by ten to ten by twelve feet. These houses may be placed in a large field about fifty yards apart and not over thirty-five hens should be in a house. The houses should always be kept clean, and lice never allowed to become numerous. Care should be taken that the soil is not too wet. Houses should be frequently moved and the land plowed and seeded every other year. This is not only a benefit to the soil, but to the poultry. Sometimes incubators are used for hatching here, but of 25,000 chickens hatched annually perhaps 1000 are hatched by incubators, the rest in the old-fashioned way.

FATTENING POULTRY FOR MARKET

The fattening or finishing of poultry by any special process and feeding with this definite object in view, is practically a new and almost unknown industry in the United States. The common plan has been to let the fowls run at large and feed them all the corn they would eat for a month or six weeks before marketing. It is difficult to understand why the farmer, who has every facility for properly finishing his fowls, should waste this opportunity. He is very careful to see that every steer, hog or sheep that he sends to the shambles is carrying all the weight possible. He usually counts that the poultry costs him nothing to produce it, and all that he gets for it is clear profit. If properly handled, a pound of grain can be converted into more poultry meat of greater value and in less time than through the four-footed channels.

The farmer sticks to corn, which perhaps above all other cereals produces the most unsatisfactory quality of meat. As it produces weight and is the cheapest and most available grain, he supplies it, and where the supply is unstinted the weight is gained. Corn has a special tendency to deposit a soft, oily fat in layers under the skin, and in masses in the abdominal cavity, instead of depositing this fat in globules throughout the tissue where it belongs. If oats, barley or a suitable mixture of these and other grains ground had been used as a base, these globules would not waste, but would soften in cooking, thereby rendering the tissues soft and juicy.

If the fowls are confined in small pens and kept quiet they will fatten much quicker than if allowed their liberty. Give all they will eat three times a day and provide plenty of pure water to drink. In a half hour remove the drinking and feed vessels. Separate

the cockerels early from the pullets and give them the range of a yard and clean, airy quarters. Ground barley or oats, with one-third corn meal mixed up with skimmilk makes a splendid growing and fattening food. Two weeks before killing pen them up and feed with corn and corn meal. Give pure fresh water and keep before them a box of sharp grit.

Crate fattening and cramming are practiced some by experts and by those who wish to produce fowls of high table quality. Although the cramming machine in the hands of an expert will probably give the best results in finished product, small coops for fattening chickens will be found the most profitable by most chicken raisers. These coops are used very largely in England and have been adopted successfully by the Canadian government. They are built of lath and one-inch-square pieces for the framework. Each part is two feet long, sixteen inches wide and twenty inches high, which experiments have shown to be the best size.

The coops are placed out of doors in the shade, either under trees or in an open shed, but in severe weather should be placed in a closed building. A small V-shaped trough is used to hold the feed, and water is supplied in a cup, which may be fastened to the slats. Young chickens from four to six months of age are commonly used for fattening. About four are placed in a coop, where they are fed three times daily, as much as they will eat of ground grain, chiefly oats. At or near the end of this period of fattening, which lasts from four to six weeks, a little tallow is added to the feed, which at all times is mixed with skimmilk. The Ontario agricultural college in a test with different rations for fattening poultry, found that a mixture of two parts corn meal, two parts ground buckwheat and

one part pearl oat dust, with an equal weight of skim-milk, gave a pound of grain for less than three and one-half cents. Four parts corn meal, two parts each ground buckwheat and pearl oat dust, with an equal weight of milk, made the cost a trifle over four and one-half cents per pound. Oat dust with milk made the gain cost nearly five cents per pound. A very good fattening ration consists of 100 pounds of corn meal, 100 pounds of wheat middlings and forty pounds of animal meal.

Convenient Table—It is not always convenient to weigh the parts of ground grain which we intend to mix for the mash. Most of us find it easier to measure it out in scoopfuls. The following table will be found useful for those who desire to have their mash made up of equal parts each of ground food:

One pound of corn meal will measure about one and one-half pints.

One pound middlings will measure about one quart.

One pound ground oats will measure about two and one-half pints.

One pound wheat bran will measure about three pints.

One pound clover meal will measure about two quarts.

VALUES AND RESULTS IN FEEDING

The food buyer who knows the make-up of all kinds of feeding stuff can save many dollars by taking advantage of every chance the market affords. The price of a food is often no guide to its value. Poor crops often make certain grains advance in price out of all proportion to other grains and mill products. On the other hand a food which is very plenty for the

time, or a refuse food too little known to meet with ready sale, may be bought at a great bargain. By comparing the per cents in the table the feeder will get a very fair idea of relative food values. The per cents of protein, carbohydrates and fats are of course of main importance. The potential energy or fuel value is also a good general indicator of the nutriment present. Refuse or second class products suitable for poultry can be bought very cheap in large cities, and the poultryman who knows the values of these substances can keep his feed bill at a reasonable level even when standard grain feeds are scarce and high. Thus in 1902 corn and corn meal were unusually costly, while No. 2 wheat screenings, gluten feed, bran, meat scraps, waste popcorn, waste bread, etc., could be bought at prices which the tables on Pages 146-7-8 and experience also showed to be much more economical.

In some sections also, some of the less common grains and seeds can be had at a bargain, such as chicken corn, sorghum, millet, rice, broom corn, etc. The table shows that many of these may be used in place of the standard grains, being of practically equal feeding value. The prices of the special or waste feeds do not change to such an extent as in the case of regular commercial feeds, and shrewd feeders use a greater or less quantity according to the fluctuations of the general markets.

COMPOSITION OF FEEDING STUFFS

Water—All feeding stuffs contain water. The amount of water in 100 pounds of such dry material as hay, straw or grain is from eight to twenty pounds; in green fodder, sixty to eighty-five pounds, and as high as ninety pounds in some roots.

Dry matter is that portion of the fodder or feeding stuff which is not water. Hence the feeding value depends mainly upon the dry matter contained in the stuff. This varies widely.

Ash is what is left when the dry matter in a feeding stuff is burned away. It consists chiefly of lime, potash, magnesia, iron, chlorine and carbonic acid, sulphuric acid and phosphoric acid, and is largely used in making bone.

Protein, or nitrogenous substances, is the name of a group of substances containing about six per cent of nitrogen. The foods rich in protein are spoken of as nitrogenous foods. They are also sometimes called albuminoids, because containing albumen, or the same substance found in the white of hens' eggs. Protein furnishes the materials for the lean flesh, blood, skin, muscles, tendons, nerves, hair, horns, wool, and the casein and albumen of milk, etc. It is one of the most important constituents of feeding stuffs.

Fiber or woody matter, also called cellulose, is the framework of plants, forming the walls of their cells. It is the most indigestible constituent of feeding stuffs, and their nutritive value decreases as the proportion of fiber increases.

Nitrogen-free extract includes starch and sugar mainly, also gums, organic acids, etc., and forms an important part of all feeding stuffs, but especially of most grains. The nitrogen-free extract and fiber are usually classed together under the name of carbohydrates, both being composed of carbon, oxygen and hydrogen. The carbohydrates form the largest part of all vegetable foods. They are either stored up as fat or used in the animal system to produce heat and energy. Therefore, carbohydrates are spoken of as heat-producing substances, as against flesh-forming

substances, which are nitrogenous compounds or protein.

Fat or oil, the materials dissolved from a feeding stuff by ether, is an impure product and includes besides real fats, wax, the green coloring matter of plants, etc. The fat of food is either stored up in the body as fat or used to furnish heat or energy. One pound of fat will produce as much heat as two and one-quarter pounds of carbohydrates.

Organic matter includes all that portion of a feeding stuff that may be burned off, and hence includes everything except the water and ash. The fuel value is expressed in a term or unit named the "calorie." The calorie is the amount of heat required to raise the temperature of one kilogram of water one degree centigrade (one pound water, .818 degree Fahrenheit). From practical experiment it has been found that a pound of protein or of carbohydrates yields, when burned, about 1860 calories of potential energy, and that a pound of fat yields 4220 calories, or over twice as much. The total number of calories in the digestible matter in 100 pounds of feed is a measure of its heating effect, or fuel value, or potential energy. High potential energy shows a concentrated food.

Nutritive ratio is the relation between the protein in a food and the fat and carbohydrates. To ascertain it, multiply the fat by two and one-quarter to equal the carbohydrates, add the latter and divide the total by the amount of protein. Foods with a large proportion of carbohydrates are wide in ratio. A common example is corn. Foods with the proportion of carbohydrates smaller in proportion to the protein are narrow ratio, as in the case of bran or meat scrap. Food with narrow ratio are generally highly concentrated and tend to produce eggs and rapid growth. Foods or mixtures of wide ratio are more heating and fattening.

Not all the protein and carbohydrates in the feeding stuffs are digestible. A certain per cent is wasted and voided in the process of digestion. For fowls the per cent of waste is not known, nearly all digestion tests having been made with cattle, sheep and horses. It seems very probable that the powerful apparatus of crop and gizzard enables the fowl to extract more of the food value than in the case of animals.

In computing a ration for laying fowls or for growing chicks the most satisfactory and economical ratio will be about one to six; that is, the substances fed should average about that ratio, while the potential energy should be about 100. For fattening a better ratio is one to eight, with a potential energy of 108.

COMPOSITION OF FEEDING STUFFS

FOODS	Water.		Dry Matte.		Fiber.	Ash.	Protein.	Carbo- hydrate	Fat.	Nutritive Ratio 1 to	Potential Energy.
	%	%	%	%							
<i>Grain and Mill Feeds.</i>											
Field corn	10.9	89.1	1.9	1.5	10.4	70.3	5.0	7.9	106		
Sweet corn	8.8	91.2	2.8	1.9	11.6	66.8	8.1	7.5	111		
Pop corn	10.7	89.3	1.8	1.5	11.2	69.2	5.2	7.3	107		
<i>Small and immature</i>											
ears of field corn.	35.7	64.3	1.0	0.9	7.3	50.7	3.5	8.1	68		
Cracked corn	12.3	87.7	—	1.3	8.6	73.9	3.9	9.5	103		
Corn meal	15.0	85.0	1.9	1.4	9.2	68.7	3.8	8.5	100		
Corn and cob meal.	15.1	84.9	6.6	1.5	8.5	64.8	3.5	8.6	94		
Corn germ.....	10.7	89.3	4.1	4.0	9.8	64.0	7.4	8.4	105		
Hominy chops.....	11.1	88.9	3.8	2.5	9.3	64.5	8.3	8.7	108		
Gluten meal	9.6	90.4	1.6	0.7	29.4	52.4	6.3	2.3	111		
Starch feed (wet).	65.4	34.6	3.1	3.0	6.1	22.0	3.1	4.8	30		
Wheat	10.5	89.5	1.8	1.8	11.9	71.9	2.1	6.3	102		
Wheat screenings..	11.6	88.4	4.9	2.9	12.5	65.1	3.0	5.8	97		
Low grade flour....	12.4	87.6	0.9	0.7	10.0	75.0	1.0	7.7	101		
Wheat bran	11.9	88.1	0.9	5.8	15.4	53.9	4.0	4.1	90		
Wheat middlings..	12.1	87.9	4.6	3.3	15.6	60.4	4.0	4.7	98		
Dry bread	31.2	68.8	—	—	6.9	44.2	0.5	6.6	61		
Oats	11.0	89.0	9.5	3.0	11.8	59.	5.0	6.1	96		
Oat meal	7.9	92.1	0.9	2.0	14.7	67.4	7.1	5.8	113		
Oat bran	7.7	92.3	19.3	3.7	7.1	57.9	2.3	8.9	81		
Oat feed.....	8.2	91.8	12.5	4.2	12.6	56.3	6.2	5.7	96		
Oat middlings.....	9.2	90.8	3.8	3.2	20.0	56.2	7.6	3.7	108		

FOODS.	Water.	Dry Matter.	Fiber.	Ash.	Protein.	Carbo- hydrates.	Fat.	Nutritive Ratio, 1 to	Potential Energy.
	%	%	%	%	%	%	%		
<i>Grain and Mill Feeds—</i>									
<i>Continued</i>									
Barley	10.9	89.1	2.7	2.4	12.4	69.8	1.8	6.0	100
Barley screenings...	12.4	87.6	7.6	3.6	12.2	61.6	2.6	5.5	92
Barley meal	11.9	88.1	6.5	2.6	10.5	66.3	2.2	6.8	93
Malt sprouts.....	10.2	89.8	10.7	5.7	23.2	48.5	1.7	2.3	87
Brewers' grain (wet)	75.7	24.3	3.8	1.0	5.4	12.5	1.6	3.0	24
Brewers' grain (dry)	8.2	91.8	11.0	3.6	19.9	51.7	5.6	3.3	97
Distillers' waste....	5.0	95.0	8.0	11.3	27.4	36.1	12.2	2.4	105
Buckwheat	12.6	87.4	8.7	2.0	10.0	64.5	2.2	7.0	83
Buckwheat groats...	10.6	89.4	0.3	0.6	4.8	83.1	0.6	17.0	103
Buckwheat bran...	14.0	86.0	14.7	3.4	17.1	46.4	4.4	3.3	85
Buckwheat mid- dlings	13.2	86.8	4.1	4.8	28.9	41.9	7.1	2.1	101
Rye	11.6	88.4	1.7	1.9	10.6	72.5	1.7	7.2	100
Rye bran.....	11.6	88.4	3.5	3.6	14.7	63.8	2.8	4.8	98
Ground corn and oats equal parts.....	11.9	88.1	—	2.2	9.6	71.9	4.4	8.6	106
Corn and bran feed, 8 parts corn, 5 parts bran	11.5	88.5	—	2.7	10.6	71.2	4.0	7.6	105
Corn, rye and oats...	10.4	89.6	—	1.9	10.6	73.7	3.4	7.4	106
"Provender," 450 lbs. corn, 125 lbs. oats, 100 lbs. bran.....	9.4	90.6	10.4	3.1	13.0	58.8	5.3	5.5	97
<i>Miscellaneous</i>									
Sorghum seed.....	12.8	87.2	2.6	2.1	9.1	70.0	3.6	8.6	102
Sorghum seed meal...	13.2	86.8	1.8	1.6	8.3	71.3	3.8	9.7	102
Broom corn seed.....	14.1	85.9	7.1	2.0	9.6	64.7	3.5	7.6	95
Broom corn seed meal.....	13.5	86.5	6.9	2.1	9.7	64.2	3.6	7.3	95
Sorghum, chicken corn	14.8	85.2	8.7	4.3	10.6	58.9	2.7	6.2	87
Chinese corn	7.9	92.1	1.8	1.5	9.6	75.5	3.7	8.8	108
Brown dhoura.....	7.6	92.4	1.5	1.7	9.0	76.0	4.2	9.6	110
Millet	13.5	86.4	9.5	3.0	12.7	58.0	3.3	5.2	83
Hemp seed	8.0	92.0	14.0	2.0	10.0	45.0	21.0	9.7	119
Rape seed	13.8	86.2	10.0	3.9	19.4	10.4	42.5	6.3	147
Flaxseed	11.8	88.2	7.9	3.4	21.7	19.6	35.6	5.0	141
Ground linseed	8.1	91.9	7.3	4.7	21.6	27.9	30.4	4.8	137
Linseed meal, old process	9.2	91.8	8.9	5.7	32.9	35.4	7.9	1.7	99
Linseed meal, new Process	10.1	89.9	9.5	5.8	33.2	38.4	3.0	1.4	91
Cottonseed meal....	8.2	91.8	5.6	7.2	42.3	23.6	13.1	1.3	111
Cottonseed hulls....	10.4	89.6	44.4	2.6	4.0	36.6	2.0	10.1	52
Sunflower seed.....	8.0	92.0	28.5	3.0	13.0	23.9	23.6	6.3	105
Rice	12.4	87.6	0.2	0.4	7.4	79.2	0.4	10.9	101
Rice bran	9.7	90.3	9.5	10.0	12.1	49.9	8.8	5.9	95
Rice hulls	8.2	91.8	35.7	13.2	3.6	38.6	0.7	11.2	48
Rice (flour) polish..	10.0	90.0	6.3	6.7	11.7	58.0	7.3	6.5	80
Cockle bran	11.1	88.9	9.2	3.2	10.6	63.5	2.5	6.5	82
Cocoa dust	7.1	92.9	5.4	6.3	14.4	42.8	24.0	7.0	129

FOODS.	Water.	Dry Matter.	Fiber.	Ash.	Protein.	Carbo- hydrates.	Fat.	Nutritive Ratio 1 to	Potential Energy.
	%	%	%	%	%	%	%		
<i>Dry Hay.</i>									
Red clover	15.3	84.7	24.8	6.2	12.3	38.1	3.3	3.7	67
White clover	9.7	90.3	24.1	8.3	15.7	39.3	2.9	2.9	71
Alfalfa	8.4	91.6	25.0	7.4	14.3	42.7	2.2	3.4	71
Timothy	13.2	86.8	29.0	4.4	5.9	45.0	2.5	8.7	66
<i>Grass and Tops.</i>									
Green grass, clip- pings	76.4	23.6	4.1	2.4	2.3	13.8	1.0	7.0	15
Cabbage	90.5	9.5	1.5	1.4	2.4	3.9	0.4	2.0	8
Dandelion tops.....	14.5	85.5	—	0.5	2.5	7.3	0.6	3.5	13
Beet tops	90.0	10.0	—	0.1	1.3	2.3	0.3	2.3	5
Onion tops	91.0	9.0	—	0.1	0.8	3.0	0.2	2.7	8
Lettuce	95.9	4.1	0.5	0.8	1.0	1.6	0.2	2.1	4
Spinach	92.4	7.6	0.7	1.9	2.1	2.4	0.5	1.7	6
<i>Vegetables—Seeds.</i>									
Peas	13.4	86.8	6.4	2.4	22.4	52.6	3.0	2.4	85
Cowpeas	14.8	85.2	4.1	3.2	20.8	55.7	1.4	2.8	92
Pea meal	10.5	89.5	14.4	2.6	20.2	51.1	1.2	2.6	85
White field beans...	15.0	85.0	3.2	3.1	20.4	56.7	1.6	3.0	93
Navy beans	12.4	87.6	7.2	3.7	22.2	53.1	1.4	2.5	90
Soja beans.....	10.8	89.2	4.8	4.7	34.0	28.8	16.9	2.1	117
<i>Vegetables, Fruits, Roots.</i>									
Tomatoes	91.3	8.7	0.7	0.7	1.0	5.8	0.5	7.0	9
Apples	84.1	15.9	0.9	0.2	0.2	14.3	0.3	75.0	17
Cucumbers	96.0	4.0	0.7	0.5	0.8	1.8	0.2	2.8	3
Pumpkin, flesh	93.5	6.5	1.0	0.6	0.9	3.9	0.1	4.6	6
Pumpkin, seeds, etc.	76.9	23.1	3.9	1.5	6.0	4.8	6.9	2.0	31
White potatoes	78.9	21.1	0.6	1.0	2.1	17.3	0.1	8.3	22
Sweet potatoes	71.1	28.9	1.3	1.0	1.5	24.7	0.4	17.1	31
Red beets	88.5	11.5	0.9	1.0	1.5	8.0	0.1	5.5	13
Sugar beets	86.5	13.5	0.9	0.9	1.8	9.8	0.1	5.5	11
Mangel wurzels.....	90.9	9.1	0.9	1.1	1.4	5.5	0.2	4.3	8
Turnips	90.5	9.5	1.2	0.8	1.1	6.2	0.2	6.0	8
Rutabagas	88.6	11.4	1.3	1.2	1.2	7.5	0.2	6.6	10
Carrots	88.6	11.4	1.3	1.0	1.1	7.6	0.4	7.8	11
Parsnips	81.0	19.0	6.3	1.0	1.6	8.5	1.6	7.8	15
Onions	87.6	12.4	0.7	0.6	1.4	9.4	0.3	7.2	13
Peanuts, hulled.....	10.9	89.1	3.1	3.8	31.5	46.9	3.8	1.4	100
<i>Animal Food.</i>									
Whole milk.....	87.2	12.8	—	—	3.5	4.8	3.7	4.0	18
Skim milk, raised....	90.4	9.6	—	—	3.1	4.7	0.8	2.0	11
Skim milk, separated.	90.6	9.4	—	—	2.9	5.2	0.3	2.0	10
Buttermilk	90.1	9.9	—	—	3.9	4.0	1.0	1.6	13
Beef scrap	1.3	98.7	—	8.0	58.0	—	32.9	1.4	154
Pork scrap	0.8	99.2	—	2.2	57.4	—	39.6	1.7	170
Dried blood.....	6.7	93.3	—	6.6	65.1	5.3	16.3	0.6	124
Green bones	6.9	93.1	—	24.5	22.3	—	16.5	1.8	69

CHAPTER VI

Hatching and Rearing the Natural Way

The old hen must continue to be the means of hatching and rearing chickens for a vast number of poultry keepers, particularly those who have small flocks. The two great advantages of using artificial methods are in being able to handle a large number of chickens and eggs with the least expenditure of time, and in getting the eggs hatched during the winter and early spring months when it is difficult to obtain broody hens.

The first essential in the rearing of chicks is to procure fertile eggs with strong vigorous germs. These can only be obtained from healthy, well-cared-for stock. Fowls which are forced to heavy winter egg production are not likely to produce strong, vigorous eggs or chicks. For success in chicken raising comfortable houses and judicious feeding of the breeding stock during the winter are positively necessary. Gather the eggs frequently during cold weather to prevent chilling and keep them at a moderate, even temperature.

Early hatching is desirable to get pullets laying early in the fall or in order to sell the first brood for broilers during May and June, when prices are highest. However desirable it may be to have early broods nothing will be gained by anticipating the natural order of spring unless prepared with certain fixtures needed for the comfort and health of the young birds as well as the mother hen. There is also profit in late broods.

Hens should be set in July or August for this purpose. The chickens will reach broiling and roasting size by Thanksgiving and Christmas and can be raised at little expense, as they grow quickly and glean much from the fields during the fall months.

SETTING THE HEN

To set a hen successfully it is necessary first to get the hen. If a hen, when she first appears to be broody, is removed from her nest to the place where it is desired to have her sit, she will probably break up and not sit at all. It is therefore advisable to leave her on the usual nest for several days before removing her to the one where she is expected to hatch. The hatching nest should be made with care, thoroughly shaped, slightly hollowing, and provided with lice expelling substances, such as tobacco leaves, sulphur or some of the prepared insecticides. If it is made hastily and carelessly the eggs are in danger of being broken and the desired hatch may never take place.

An excellent nest for sitting hens is made of two duplicate grocery boxes, hinged as shown in Figure 53. A deep box makes it necessary for the hen to jump down upon the eggs. With this nest she has but to step in upon the surface of the nest, when the upper box can be let down, serving as a cover. Holes are bored in each box to give a sufficient circulation of air. A box eighteen inches long, fourteen inches wide and eighteen inches high makes a good nest. Take off the top and split so that one strip is seven inches wide, which is nailed to one side of the opening, as shown at the right in Figure 53. Two short pieces are nailed on this at *a* and *b* to hold the door. This box may be used for a nest in which to set the hens and it

stands on the floor. Several holes are bored in the box for ventilation.

If late enough in the season to procure it, earth makes the best foundation for a nest, because it can be properly shaped and pressed firmly together. Over the earth a sprinkling of chaff or short fine hay should be placed, because this keeps the eggs clean and is more comfortable for the hen. A hen which is comfortable will sit better and produce more satisfactory

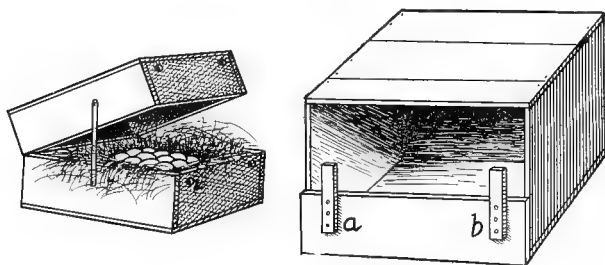

FIG. 53—PROTECTED NESTS FOR SITTING HENS

results than one which must pursue her duties with discomfort.

Having properly prepared the nest, place in it as many china eggs as the hen is expected to cover and gently remove the hen at night to this nest. If she is thoroughly broody and has been removed carefully she will settle down upon the china eggs with a satisfied croon. She should then be left for the night and fed and watered the next morning. If she is on her eggs the next night, they should be removed and the real eggs be given to her. Many advise giving a sitting hen only corn and water. But if the hen has been accustomed to a different diet she should have at the start the same kind of food as that to which she has

been accustomed. Sudden change in diet is liable to upset the digestion and bring on diarrhea. If one wishes to feed largely on corn, make the change gradually, adding a little larger proportion of corn each day. Should an undue looseness of the bowels occur,



FIG. 54—OLD FASHIONED A COOP

the addition of a little sulphate of iron to the drinking water will usually correct the difficulty.

It is a very good practice to thoroughly dust the hen with some insect powder about three times during the period of her incubation, once when she begins her duties, once after a week or so, and the third time about the nineteenth day. This will keep her from vermin. A sitting hen should be subjected to as little disturbance as possible, but it is necessary to notice whether the eggs are broken or fouled. In such cases



FIG. 55—COOP WITH RUN AND SHELTER

the nest should be furnished with clean materials and the unbroken eggs carefully washed in warm water. After washing they should be wiped dry and immediately replaced under the hen. If, however, the hen is a quiet fowl (and only such are fit for maternal

duties), and the nest has been properly made and the hen properly fed and cared for, there are not many chances of having the eggs broken or the nest fouled.

Two hens should be set at the same time and when they hatch give one the chicks and reset the other. The chicks must be removed as soon as hatched and taken out of hearing or she may refuse to sit again.

The number of eggs to put under a hen will vary with the season and size of hen and eggs. In Febru-

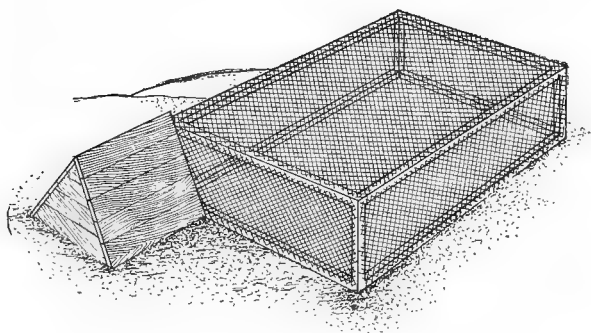

FIG. 56—COOP WITH WIRE COVERED RUN

ary and early March eleven eggs are usually as many as a medium-sized hen can cover. A little later thirteen or fifteen may be used, while in May and June seventeen or nineteen can be given to a Plymouth Rock or Brahma. An odd number of eggs generally fit in the nest better than an even number.

Between the seventh and tenth day of incubation, the eggs should be tested, and infertile ones taken out to cook for young chicks. The testing must be done in the dark. If you have no tester hold the eggs in

front of a lamp, one by one, with the thumb and forefinger of the right hand, while with the left shade the large base. If the egg is fertile, the air chamber is opaque while the rest of the egg is dark and heavy looking, the two portions being divided by a clear dark line. If the eggs are light and opaque throughout, like fresh laid, there is no use returning them to the nest. Sometimes more than half the eggs turn

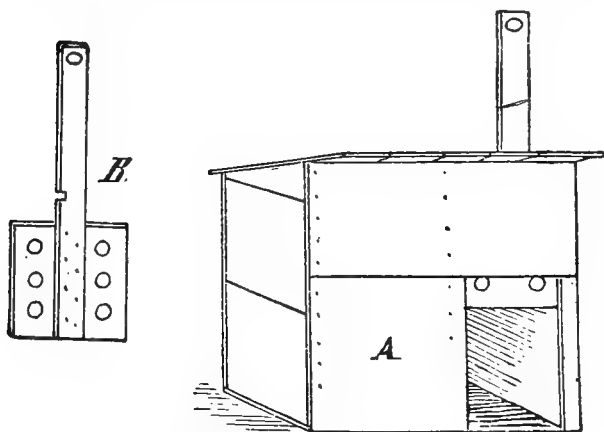

FIG. 57—CONVENIENT BOX COOP

out bad, and then if several hens have been set at the same time, the good eggs can be bunched, thus economizing the stock of hens.

When through hatching, squeeze a rag dipped in coal oil and rub lightly through the hen's feathers, especially along the inside of wing quills where the lice have deposited their eggs, then put her out with the other fowls if not needed for young chicks.

Some wear a glove or mitten when handling sitting hens. Some are cross and pick so hard they draw blood. If one has a hasty temper, the glove will at least save bad words.

BROOD COOPS FOR HEN AND CHICKS

Suitable coops must be provided for the hen and young chicks. There are almost innumerable numbers, varieties and styles. The old-fashioned A coop shown in Figures 54 and 55, is cheap, easily made and very serviceable. With a yard attached it is more comfortable for the hen. A modification of this coop

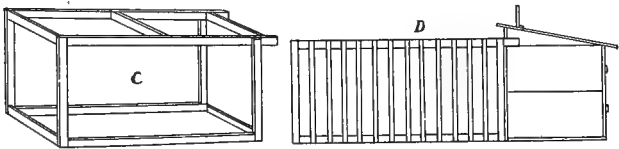

FIG. 58—FRAMEWORK OF COOP AND RUN

is shown in Figure 56, where a yard is made of inch mesh wire netting eighteen inches high and covered with netting also, which coop is valuable where hawks and crows are abundant. The yard should be made about four feet square.

A very convenient coop is shown in Figures 57 and 58. This is a square coop easily made from a grocery box and should have a tight roof either of matched boards or covered with paper. It has a floor and a small yard attached. The framework of the yard is shown in Figure 58 at *c* and one side of the yard and coop at *d*. At night the slide *b* in Figure 57 can be let down, which will keep out rats, minks, cats

and other enemies. A ventilated coop is shown at

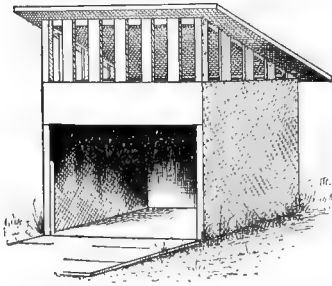

FIG. 59—VENTILATED COOP

Figure 59. This is similar in some respects to the above except that the raised portion above the top of the original box is made of slats. Such a coop will not do for cold weather but during warm nights is much better for the chickens.

A coop for very early chickens is shown in Figure 60. This consists of a box three by six feet in size, covered with a hotbed sash. The front is of wire netting or slats, through which the young chicks can be allowed to run out in suitable weather, while the hen is confined to the rear portion. A part of this coop could be shaded with a board, as even in early spring it becomes very hot when the sun is shining on the glass. At night the coop should be well covered with an old blanket or mat.

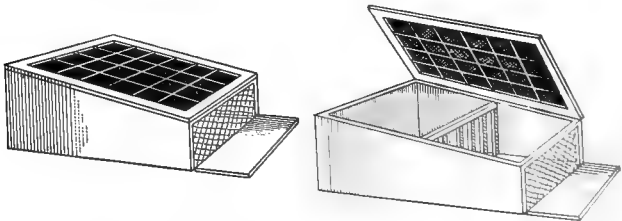

FIG. 60—PROTECTED COOP FOR EARLY CHICKS

An old barrel turned on its side, as shown in Figure 61, makes a very cheap and handy coop. It is protected from rolling by laying a stone or brick at

each side or driving in two stakes. A few stakes in front, three inches apart, serve to confine the hen.

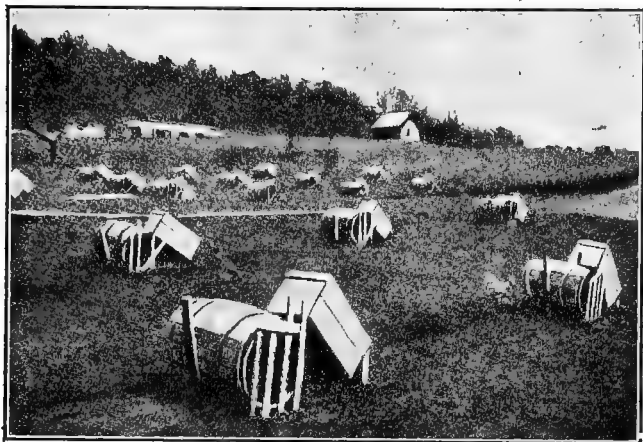

FIG. 61—UTILIZING OLD BARRELS FOR COOPS

Egg crates provide shade for the young chickens and at night are placed in front of the coop to keep out skunks, etc.

A front board for shade and protection is shown in Figure 62. This is hinged over the slatted front and can be adjusted at any angle to keep out sun or rain and closed at night. An open panel at the top covered with wire netting provides ventilation.

A coop for two broods is shown in Figure 63. This has a movable bottom *d*, and a partition *c*, which goes

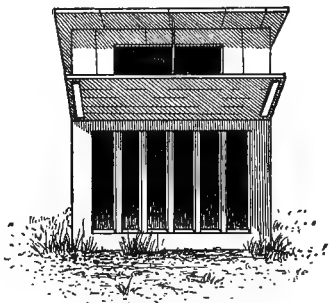

FIG. 62—SHADE BOARD

in the middle and separates the hens. This partition can be made solid if desired. Such a coop is useful only where hens are congenial and do not kill each other's chicks. The front panel *b*, which allows the chicks to run in and out, is replaced at night with the panel *a*, covered with fine wire netting.

CARE OF NEWLY HATCHED CHICKS

When the chicks are twenty-four hours old they are ready to take off. Dust hen with some insecticide

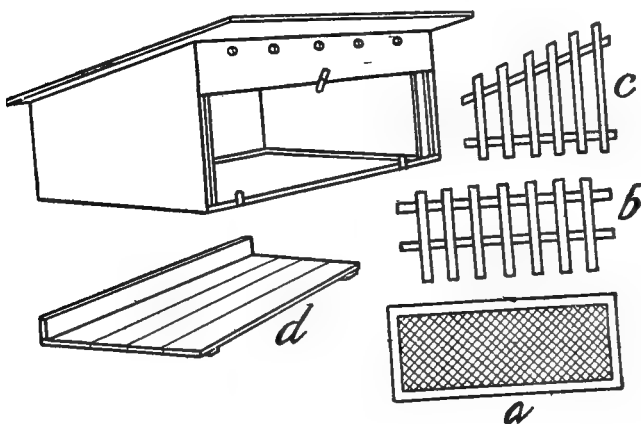

FIG. 63—COOP FOR TWO BROODS

and rub a bit of lard upon head of each chick. Remove hen and the chicks to a clean coop, with board floor covered with dry sand. No matter what kind of a coop, from a barrel laid down to the most improved patented article, is used, see that it is clean and the bottom covered with fine sand, or if the weather be really cold, with oat chaff or short fine hay. The last thing which the chick does before breaking the shell is

to absorb the yolk. This sustains it and gives it nourishment for twenty-four to forty-eight hours and until this yolk is thoroughly assimilated by the system it is unwise and injurious to give other food. Thousands of chicks are killed annually by feeding them too soon.

They can go without food as long as sixty hours after hatching and no harm will be done. Up to this time they should have received no food. But they are now ready for their first meal. Give them water to drink in a vessel into which they cannot get their bodies. Whatever their first food may be, give them only a small quantity, the best rule for feeding being "little and often."

Two distinct methods of feeding have their special advocates, the wet, that is, with mixed up dough; and the dry, that is, without the addition of water to the food stuffs. I have used both methods with success, but think, on the whole, the dry method or a judicious combination of the two is the more satisfactory for most persons. But whichever of the two methods is employed, the food should approximate to a balanced ration, that is, should have enough of muscle and fat forming elements to promote the growth of the whole organism.

Corn, whether finely cracked or ground into meal, does not make such a ration. There is too much of the fat and too little of the muscle forming elements. Yet, when chickens run out and eat grass and where insect life is abundant, they may do well on a corn diet, because they secure for themselves the lacking elements. If to the corn is added some form of animal food, the ration will be better. For a single grain, provided it could be obtained cheaply enough, I should prefer barley. I have used oats, corn meal and beef scraps with very satisfactory results and with even

better results when I have added shorts to the mixture.

No set rule of feeding can be laid down, so much depends upon the feeds at hand, the breed of chicks, and the season of the year. In early spring when chicks must be confined to sheds or buildings they will want different feeding from later in the season when they may have free run. Feed the first day or two upon a mixture of bread crumbs grated and finely chopped hard-boiled eggs. In a few days rolled oats may be added to this. If possible, use a little hard-boiled egg the first week. In a few days begin to add a little beef scrap or animal meal to their feed.

A most excellent plan of feeding and one which invariably gives good results is to mix together equal parts of corn meal finely ground, wheat bran or coarse middlings and ground oats or barley from which the hull has been sifted out. To one quart of this mixture add a tablespoonful of animal meal or fine beef scraps, a teaspoonful of bone flour and a teaspoonful of baking soda and mix up with skim milk. Put in a baking pan and bake hard. Then crumble it fine and feed the chicks upon this five times a day all they will eat clean in fifteen minutes. This system of feeding can be followed with profit and advantage until the chicks are six weeks old, when they can subsist entirely upon dry grains and one or two feeds a day of the mash which the other fowls receive. After the chicks are three or four weeks old two feeds a day can be given of small grain seeds and cracked corn.

The dry system of feeding, which is advocated by many and practiced with success, consists in feeding the chicks entirely upon dry grains either whole or ground. These may be placed in self-feeders and the chicks allowed free access at all times, or they may be fed five times a day as much as they will eat clean in

fifteen minutes. Either method will give satisfactory results in the hands of a careful person. Where such good care cannot be given, the dry method of feeding will prove most satisfactory, for there is no danger of sour, tainted feed causing diarrhœa and other troubles. There are now made and sold many prepared chick feeds, most of which will give good results.

Baby Chick Food—Cracked wheat, twenty-five pounds; pin head oatmeal or rolled oats, twenty pounds; millet seed, ten pounds; cracked corn, fifteen pounds; granulated charcoal, three pounds; chick size grit, five pounds; beef scraps, five pounds. This is the same as one of the best grades of chick food largely advertised.

In addition to grain young chicks require grit, charcoal, and some material to make bone. Sharp coarse sand will answer, but the fine grit from limestone rock is best. Keep a box of it where they can have free access to it. Charcoal is a great corrective for stomach and bowel troubles. A little of this may be mixed in the feed several times a week. The need of something to furnish material for the growth of bones is very important. A large proportion of the chick's body is composed of mineral elements and unless enough of these are supplied the chick will not make the fastest growth. It will grow only as fast as it can get mineral matter from the feed, and grain furnishes only about one-half as much as needed. Tests by the New York experiment station show that if mineral matter is supplied in addition to the grain a much more rapid growth results. Fine bone flour is one of the most convenient and best substances for this purpose. In this form it can be mixed with the mash or bread, or granulated bone can be kept in a box where the chicks can have access to it. Green cut bone is probably as good a form as any to supply this material, but

care must be taken that it is perfectly fresh and sweet.

A very satisfactory trough for feeding half grown chickens is shown in Figure 64. This is easily made of laths and inch boards. It should be four to

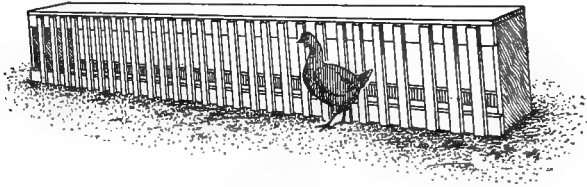

FIG. 64—FEEDING TROUGH FOR CHICKS

six inches wide, inside measurement, one foot high and the laths placed two and one-half inches apart. The cover can be hinged, which will prevent the chickens from getting in the feed. Dry grains are best scattered broadcast on the ground or in the litter. The growing chicks should always be fed by themselves where the older fowls cannot run over them or steal their food. If they all run together provide a feeding pen for the chicks in which the feed can be placed. A

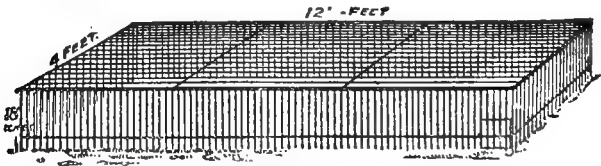

FIG. 65—COVERED FEEDING PEN FOR CHICKS

pen as shown in Figure 65, four feet wide and twelve feet long, will accommodate 100 chicks. The slats on the sides should be three inches apart. The top may be covered with wire netting. Make the sides in four

pieces and hook them together. The coop is easily taken apart and laid away in the fall.

Milk in any form is a good drink and food for young chicks; it furnishes both food and drink. But they must have water too. The milk must be placed in vessels in which the chicks cannot get their bodies or they will get all daubed up with it. Great care is needed to keep the vessels clean.

Bowel trouble is commonly caused by the chicks getting chilled, sour, putrid food, or improper feeding. Remove the cause and give a little charcoal in the food and baking soda in the drinking water and the trouble will usually quickly disappear.

The question of how much will a chick gain, is an interesting one. The following is about correct: The eggs weigh two ounces; the newly hatched chick weighs one and a quarter ounces; at one week old, two ounces; three weeks old, six and a quarter ounces; four weeks old, ten ounces; five weeks old, fourteen ounces; six weeks old, eighteen and a half ounces; seven weeks old, twenty-three and a half ounces; nine weeks old, thirty-two ounces; ten weeks old, thirty-six ounces; eleven weeks old, forty-one ounces.

WATER FOR YOUNG CHICKS

Fresh, clean water should be kept before the young chicks all the time. Some advocate giving water several times a day and removing the dish as soon as all the chicks have had a drink. This is too much work for most poultry keepers. There is no harm in keeping a drinking fountain before them if the water is clean and pure. For baby chicks a common teacup filled with water covered with an inverted saucer and then turned upside down, makes an ideal

fountain. After turning the cup over raise it slightly on one side and slip in a thin bit of wood. This causes a perpetual flow until the cup is empty and it will not run over the saucer. Tin cans in which vegetables or fruits have been preserved, make good drinking fountains. Remove the cover and with a nail punch a hole in the side of the can about one-half inch below the top

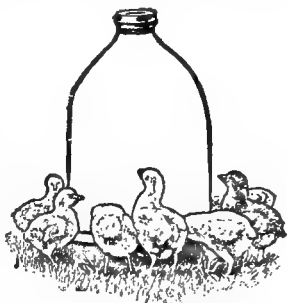

FIG. 66—CHICK FOUNTAIN of the rim. Fill with water and invert over it a saucer or shallow pan. Then turn upside down. Earthenware fountains, such as shown in Figure 66, are made in several sizes for small chicks and fowls. The advantage of fountains such as described is that the chicks cannot get their bodies wet. They keep the water clean and cool and provide a supply as long as any water remains in them.

REMOVING THE HEN

The hen should be removed as soon as the chicks are old enough to take care of themselves. In early spring this will be about six weeks to two months after hatching; in summer, four weeks. Chicks should have a coop to roost in at night. They must have plenty of ventilation, yet be protected from showers in the night. Shelters, such as shown in Figures 67 and 68, are very useful. After the chicks are two months old they should be provided with a shelter, shed or open houses of some kind in which to roost, and not be allowed to seek the trees.

Separate the Cockerels and Pullets—As soon as the cockerels can be distinguished from the pullets the

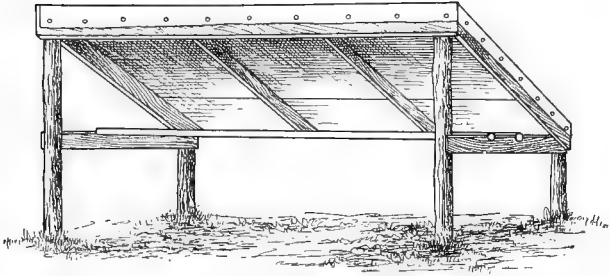

FIG. 67—OUTDOOR SUMMER SHELTER FOR CHICKS

sexes should be separated and the cockerels kept by themselves. A few of the best can be raised for breeding and the rest should be fed and marketed as soon as possible. Both sexes make greater gains and do better if separated.

Before the cold nights of fall come on the pullets should be taught to roost in the laying house where they are to be wintered. Remove the windows, substitute wire screens and get the pullets into these houses early. Where the fowls are allowed to roost in trees until cold weather and then confined in close houses there is certain to be more or less trouble with colds and roup, all of which can be avoided by getting them in the houses early.

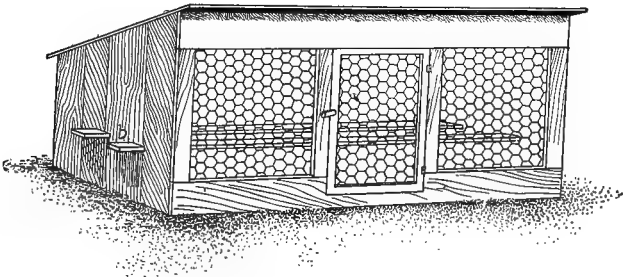

FIG. 68—CATPROOF SHELTER FOR CHICKS

CHAPTER VII

Artificial Incubation

AN ORPHAN

A well-known professor has a bright boy, who one day, at the age of four, appeared in his father's study clasping in his hands a forlorn-looking little chicken, which had strayed from a neighboring brooder.

"Willie," said his father, "take that chicken back to its mother."

"Ain't dot any mudder," answered Willie.

"Well, then, take it back to its father," said the professor, determined to maintain parental authority.

"Ain't dot any fader," said the child. "Ain't dot anythin' but an old lamp!"

A BIT OF HISTORY

How long artificial incubation has been practiced is not known. The Egyptians, the Assyrians, the Greeks, and the Chinese are known to have practiced it many centuries ago. And from the crude ovens of those semi-civilized peoples the American incubator has come in the evolution of things. M. Reaumur, a Frenchman, was so far as known the first European to plan an incubator. But Reaumur's plan was wholly and distinctly different from the incubators of today. The Frenchman put his eggs in boxes, casks, etc., and piled dung about them, which fermented and made the necessary heat, the manure being replenished when needed. But we have no details. We don't know

whether he turned the eggs and cooled them, and if he did, we do not know the process. Reaumur patterned after the Egyptians, but in a much smaller way. Another Frenchman, M. Cantelo, is really the inventor of our modern incubators. He studied the philosophy of upper heat, and constructed an incubator with a hot water tank above the eggs. Incubators were attempted in England later on, but no machine was produced that caused a sensation, or which gave promise to be an improvement over the manure method of M. Reaumur.

America, is, perhaps, the real birthplace of the successful incubator. About 1870, Jacob Graves & Co. of Boston invented an incubator which was a success, and many machines were sent to England, where they did good work. The Graves incubator was exhibited at the Boston poultry show of 1873, and did such good work that it at once stimulated inventors and breeders to make other machines. We cannot say positively that Mr. Graves' incubator was the first made in America, but upon investigation and inquiry can find account of no other. At least none were successful before that period.

The Start—Purchase a good machine. There are many of them. In fact, good incubators are the rule now; poor incubators the exception. An incubator to sell in this age must possess merit; must hatch. Time was, in the early days, when the rage for incubators was at fever heat, that any kind of a machine would sell, and there were some flimsy ones made by persons who knew nothing at all of artificial incubation. Happily, however, these wildcat machines have nearly all disappeared or been made better. It is no trouble now to get a good machine that will hatch a fair per cent of the eggs. Do not get one below 100 egg capacity, and double that is better. It is no more work

nor expense to run a large machine and results from the larger one count for something. There are both hot air and hot water machines with good reputations. Some prefer one kind, some the other kind. Under right conditions both hatch equally well.

Setting the Machine—Now that you have purchased your incubator, you may be inclined to put it in the cellar. Don't—not if you have a room above the cellar. Running down cellar and up again many times a day is tiresome and unnecessary work. You don't have to put the incubator in the cellar for best results. Incubators were put in cellars first, because insurance men objected to them as dangerous in buildings, and refused to insure houses where they were run in upstairs rooms. Then the idea got abroad and gained currency that the cellar was the proper place for an incubator because it was moister, and people put their incubators there. Above all, the room in which the machine is placed should be well ventilated, free from drafts and from great fluctuations of temperature between night and day.

Having selected a room or place for your incubator, the next thing is to get eggs. Fresh, fertile eggs are necessary for a good hatch. Having the eggs ready, heat up the incubator, and when it marks 103, and you have held it there for some time, put in the eggs, but don't change the regulator.

Do not place the thermometer on the eggs, nor let the bulb touch an egg. If there is no hook or device attached to the heater to fasten the thermometer to, make one, or have it made before starting the machine. If the thermometer is laid on the eggs, when the chickens hatch they trample on it, and you cannot tell how the heat is. Have the thermometer fixed so that it will hang slanting from above. It may rest on the egg tray, or hang just above the eggs.

What you want to tell all the time is the heat of the egg chamber. If the thermometer touches or rests on an infertile egg it will register wrong. Never use a cheap or common thermometer. If the machine you use is homemade send and get the best thermometer you can purchase. If you accidentally break the thermometer and cannot get another, secure the best you can, take it to a doctor and test it with his clinical thermometer, and you can then tell how many degrees it varies. I have known of complete failures in hatching because of the use of cheap thermometers. Even tested incubator thermometers vary from one to three degrees after being kept a year or two. They should always be tested each season before starting the machine and the temperature kept according to the corrected readings. Many failures and poor hatches are due solely to a thermometer which registers too high or too low.

Care of the Lamp—Be particular to fill the lamp and trim it at least once a day, morning or evening, but at a *regular time* every day.

Turning the Eggs—The evening of the third day take out the egg tray and turn the eggs by hand. There are incubators with turning machines. If you have an incubator of this kind, take out the patent turner. This will give you room for many more eggs. Then turn them in the natural way, as the hen turns them, so that they change positions once or twice a day.

Next comes cooling the eggs, which is a most important and necessary thing to do. Begin on the fifth day, and cool them five minutes, but not in cold weather, unless the temperature of the room be above sixty degrees. Eggs require less airing in cold weather. Cooling makes the chicks strong and vigorous. Start with cooling the eggs five minutes, and

increase the time each day, until you have cooled them fifteen to twenty minutes, and even thirty minutes the last week of the hatch if the temperature of the room be up to seventy or eighty degrees.

Quit turning and cooling the eggs on the evening of the eighteenth day, as with fresh, fertile eggs, some of the chicks hatch on the nineteenth or twentieth day. If the eggs are strictly fresh and fertile, the hatch will all come off as under the hen. I have had hatches all through within ten hours after the first chick pipped the shell. Again, I have had hatches drag along until the twenty-third day, when the eggs were of doubtful age. If you have your own hens in sufficient number to give the required number quickly, or if you can gather perfectly fresh eggs from your neighbors, the hatch will come off uniform and inside of twelve hours. Remember, then, that fresh, fertile eggs are the chief requisites for a good, quick hatch. The hen will sometimes be twenty-four hours hatching. A good incubator, with good eggs, managed rightly, will hatch just as well and quick as the hen.

The Proper Heat—The first week try to keep the mercury between 101 and 103, preferably at 102. After the first week the lamp does not burn so much oil, nor does it require so large a blaze as during the first week. And during the third week, if the weather be warm or hot, there will be afternoons where the lamp may be turned nearly out, or extinguished for from one to three hours. It is best, however, not to turn the lamp out, but to raise the cap over the lamp flue, so that the heat will pass out.

After the ninth or tenth day, when the chick begins to show signs of real life, heat develops, and this heat increases up to the time of the bursting of the shell. From this time on the lamp must be

watched, and the blaze regulated according to necessity as indicated by the thermometer.

If at any time the heat runs above 105, turn down the blaze and take out the eggs and cool them down to 100. With hot water machines it is difficult to reduce the heat quickly. A large body of water holds heat a long time, and for this reason hot water machines are preferred to hot air machines by some people on plea that if the lamp went out the heat would hold so long that the accident would be discovered before the hatch was injured. But if there is plenty of wick in the lamp, and it is kept filled, the lamp will never go out.

The second week the heat in the egg chamber will run up in the afternoon if not watched. It is better to have the heat too low than too high. If the heat be too low, it means a delayed and perhaps dragging hatch; if too high, it may mean the total destruction of the hatch. It must be watched by one person, whose duty it should be to manage the hatch entirely. Where the incubator is run by the family, allowing anyone who happens to have time to see to it, the result is bad, as a rule. The incubator should have one attendant who will see to it until the hatch is completed.

Testing the Eggs—The eggs should be tested on the ninth or tenth day. Some use the testers which come with machines or are on sale at the supply stores. My plan of testing is very simple. I set a tray full of eggs and an empty tray on a table, with a lamp between. The fertile eggs I put in the empty tray and the infertile ones in a basket. I pick up an egg in my closed hand and hold it to the lamp. If infertile, it is transparent; if fertile, dark; if doubtful, cloudy. I do this rapidly, and my sense of touch is so acute and sensitive that I can tell an infertile egg in the

dark by the feel of it. At first I used an egg tester. But this was too slow, and I resorted to the hand process as the most rapid way.

Dark or brown shelled eggs are hard to test satisfactorily. I never am satisfied with a test of such eggs. The shells are thick and not transparent, and much of the testing of them is mere guesswork. White shelled eggs are easily tested. An expert can test duck eggs when they have been in the incubator four or five days. The shells are like tinted glass and the white of the egg translucent.

I advise beginners to wait until the tenth or twelfth day before testing, and to do it at night, with a brilliant light. I have tested eggs in daylight in a dark room, having a small space for the sun to strike the egg, and testing can be done very successfully.

Moisture—The question of moisture is pretty nearly settled. There has been more argument, pro and con, on the moisture question than on anything pertaining to artificial incubation. The hot air machines revolutionized the moisture question and practically settled it, as the makers announced that no water pans were necessary, no moisture was needed in the egg chamber except the moisture generated by the eggs in the drying out process. This at once looked reasonable, and breeders began to study things. And when they tried their incubators without moisture pans and got as good and better hatches than they did with moisture they very sensibly adopted the new idea as the best. A hen will hatch as well up in the haymow as on the ground or in the cellar or under the barn. All farmers know this to be true. Birds build nests in trees, and several species of ducks nest and hatch their young in trees. The size of the

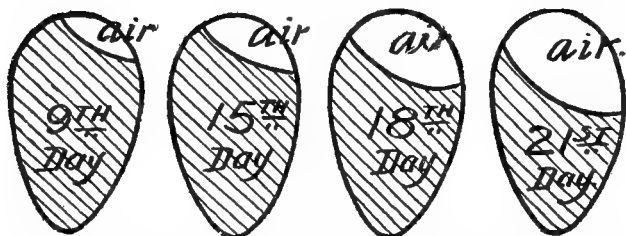

FIG. 69—SIZE OF AIR CELL DURING INCUBATION

air cell, shown in Figure 64, may be used as a guide in drying down the eggs or in adding moisture.

So far as I am concerned the moisture question is settled. But I advise purchasers of incubators to manage them according to instructions first, and then if they fail, they should experiment. If the instruction book says use moisture, use it. Then try the machine without moisture. You will then have experimental and practical knowledge you never could gain without experimenting. Moisture might be needed in high altitudes, but in low altitudes it has been proven to be wholly unnecessary in artificial incubation.

The loss in weight of eggs during incubation, due to the drying down of the eggs, has been carefully tested and figured out by Horace Atwood of the West Virginia experiment station, who has prepared the following table showing normal loss in weight of 100 eggs in ounces for the first nineteen days of incubation:

LOSS IN WEIGHT OF EGGS DURING INCUBATION

Days	Loss in oz.	Days	Loss in oz.	Days	Loss in oz.
1	1.65	8	13.44	14	23.88
2	3.31	9	15.16	15	25.66
3	4.96	10	16.88	16	27.44
4	6.62	11	18.60	17	29.21
5	8.28	12	20.33	18	30.99
6	10.00	13	22.10	19	32.77
7	11.72				

After placing the eggs upon the tray ready for the incubator, set the tray upon a pair of scales reading to ounces and note the total weight of eggs and tray. They should decrease in weight each day as per the above table. By watching the air cell, as shown in Figure 69, one can tell whether the eggs are

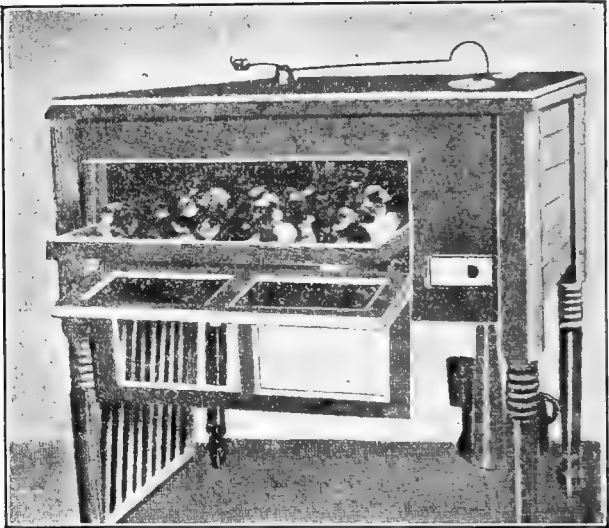

FIG. 70—THE COMPLETED HATCH

drying down enough and regulate the ventilation accordingly.

The Hatch—Quit turning and cooling the eggs on the eighteenth day, and keep the incubator door closed tightly, until the hatch is complete, and all the chicks out of the shells that will come out. With the beginner this is an anxious time, and the chicks are counted in advance. All expect a good hatch. Hope

is ever high and buoyant in the breast of the beginner, who sees a brooder full of downy balls. Failure is not thought of, or, if thought of at all, remotely. Yet it often happens.

To my mind, the most important time in artificial hatching is from the eighteenth day until the chicks are all out of the shell. When the chicks begin to pip the shells, do not open the door of the incubator, no matter who wants to see in. The curious can look through the glass door, which must satisfy them. There have been more hatches spoiled by opening the door during a hatch to satisfy the curious than you are aware of.

Keep up the heat, and see that it does not get too high or too low, 105 degrees being about right. But, if you don't watch, the mercury will run up to 110 or more, or it may drop to below 103, or below 100, which is fatal to a good hatch. The cause of so many dead chicks in the shell is due to letting the heat run down, as well as to opening the door of the incubator. If the heat gets too great, prop up the cap of the lamp flue, and the heat will escape. It is the heat escaping from the eggs and chicks which causes the high temperature.

Don't open the door to help chicks out of the shell. Such chicks have little vitality, and rarely amount to much. Besides, you might kill a dozen or more in the shell in trying to help one to get out. After the hatch is done (Figure 70), and you open the door, you can help those out of the shell which are partly hatched but can't get out themselves.— [J. H. Davis, Ohio.

Where several incubators are run it is advisable to have a building on purpose for them. This should be partly underground, so as to be as cool as possible, for a half dozen lamps burning continuously

generate much heat and make the room very warm, especially when the outside temperature is high. Figure 71 shows a good type of incubator cellar used by eastern Massachusetts poultrymen.

Mixed Eggs in an Incubator—Better results will be obtained by hatching the eggs of each breed separately, for this reason: Leghorn eggs, for instance,



FIG. 71.—MODERN INCUBATOR CELLAR

hatch rather more promptly, perhaps half a day earlier than Wyandotte or Plymouth Rock eggs, and the changed conditions within the egg chamber of the Leghorn chicks being there, would be a handicap for the Wyandotte and Plymouth Rock eggs. The same would apply to putting Brahma or Cochin eggs in an incubator with Wyandottes or Plymouth Rocks. We

have done that, putting the Brahma eggs in half a day earlier, so as to give them that much handicap, with fairly good results; and it is probable that if you put the Leghorn egg into the machine half a day later than you do the Wyandottes and Plymouth Rocks, the conditions would be more equable. Still, as a rule, it would be better to hatch Leghorn eggs by themselves.

Some Advantages of Incubators—By using an incubator chickens can be hatched earlier in the season. By having early hatched chickens much better prices can be obtained, and the chickens mature earlier in the fall and will commence laying before winter sets in, and if properly cared for a large number of winter eggs can be obtained. By using an incubator hens can be stopped from sitting and can commence laying again. A much larger number of chickens can be raised on a small lot. An incubator is time saving. It requires fourteen to sixteen large hens to cover 200 eggs, and to look after these hens properly will require three times as much time as a 200-egg incubator will require. It will take eight gallons oil to the hatch with a 200-egg incubator, which, at fifteen cents per gallon, will amount to \$1.20. It will take half a pint of corn per day to properly feed a sitting hen. For sixteen hens, four quarts per day would be required and for twenty-one days it would amount to eighty-four quarts. With corn at sixty-four cents per bushel (two cents per quart), the cost of feeding sixteen hens for twenty-one days would amount to \$1.68. It costs less to heat the incubator than to feed the hens. By having the incubator thoroughly disinfected before the eggs are put in, we avoid the worry and trouble of lice and mites.—[O. M. Watson, South Carolina.

It takes hens' eggs twenty-one days to hatch, guineas' and ducks' twenty-eight days, geese and turkeys' twenty-nine to thirty days.

Why Incubator Chicks Die—At the Rhode Island experiment station, careful investigation has been made of the cause of death of young incubator chickens. It was alleged that about one-third of the chicks had been more or less injured by uneven heat during incubation. Another common cause of trouble was in overcrowding of brooders, resulting in death by suffocation, trampling, etc. Tuberculosis was found to be very prevalent and fifteen per cent of the chickens were more or less affected. For guarding against this disease, it is recommended to give the interior of the brooders all the sun and air possible on pleasant days. Bowel troubles were a common cause of death. Lack of animal food sometimes causes diseases of the liver and gall bladder.

The Incubator a Necessity—For the farmer's wife, a large incubator is, or at least should be a necessity, if she is living up to her opportunity in the chicken business for profit. From 200 to 400-egg capacity is the kind she needs. Sometimes, especially early in the year, it is difficult to get enough fresh eggs to fill one of the larger size, but with us very few incubators are put to work until eggs are getting plentiful, as well as cheap. This lets you in on the early market if you have good luck with your early hatchings.—[Ida Shepler, Indiana.]

The best grade of kerosene should be used in both incubators and brooders, for a poor grade clogs the lamp and causes trouble. Between hatches the lamp should be taken apart, the burner boiled out and a clean wick put in. If the lamp gives too much heat toward the end of the hatch, instead of turning it down very low trim the wick to a sharp point.

FEEDING INCUBATOR CHICKS

It is not so much what the food is as how the food is supplied, providing there are plenty of starchy, albuminous and green matters, are the conclusions reached by Dr. Cooper Curtice of the Rhode Island experiment station in raising incubator chicks. In the fourteenth annual report of this station he says that in nature small seeds, insects and grass furnish food for chicks. These are abundant in the spring and summer months and it is at this time that the chicks thrive. To secure the best results foods simulating both the composition and mechanical character of these should be supplied. For green stuff to be easily assimilable, some plant should be supplied which may also be easily broken. We have found hanging a head of lettuce in the brooder by a string to exactly furnish the desired want and be greedily, even crazily, eaten by the chickens. Millet seeds, broken rice, rolled oats and other things of this character were greedily eaten and well digested.

For meat for the youngest chickens, we have given the sterile eggs boiled hard and ground through a sausage machine. While it is preferable, if one has time, to chop the egg fine and mix it with bran, or even feed it a little at a time to the chickens, we found it satisfactory to mix it with the bran until it was crumbly and feed it in bulk; a sufficient quantity being given for the number of chickens in the brooder. Mixing the eggs with cracker did not succeed with us as well for very young chicks, although it is fed by others apparently without harm. As the chickens grew older meat scraps were substituted. These were usually sifted, added to the grain ration, and strewn upon the floor of the brooder. Boiled liver and animal meal was also used, but there was very little difference

in the gain of the different chickens when fed upon the animal meal, meat scraps or egg.

One mixture of seeds was made as follows: For chicks from one day to six weeks old, mix four parts cracked corn, one of fine cracked wheat, two of rolled oats, one-half of millet seed, one-half of broken rice, and two of fine scraps. For the first two weeks we have added one pint of millet seed, leaving out scraps during the first week. Boiled eggs, three for each fifty chicks have also been fed. After six weeks, and up to ten weeks, feed the following mixture: Four parts cracked corn, two of cracked wheat, one of rolled oats, one-half of millet, one-half of broken rice, one of grit, and two of scraps.

For chicks kept in the colony system give for grain three parts wheat and four of cracked corn. Also give the following mash three times per week, and daily after ten weeks: One part ground corn, one of ground oats and one of brown shorts. To feed the meat scraps we made the seed-feed into a mash with boiling water, mixed the scraps with it and covered the mash until it was well steamed. This mash seems to hasten the growth of the chicks. While it seemed necessary to feed the youngest chicks rather oftener, those ten days old were fed mash in the morning, green food at noon and dry seeds at night, allowing them to fill their crops. When fed oftener they seemed to get satiated and had no desire to eat.

For the first day or two after the chick has emerged, little food seems to be necessary and little is offered by us. We, however, place the young chick directly on either sand filled with rather coarse grit, or procure grit of the proper size and allow it to eat what it will. That which is bright and attractive to the chick's eye, like quartz grains, seems to be best. Very

black grit does not seem to be eaten when any of the brighter sorts are near at hand.

THE BROODER

A good brooder is an indispensable adjunct to the poultry yard. The only conditions necessary in managing a brooder are to keep it clean and not overheated or overcrowded. Brooders are now made (some at least) so that it is impossible to overheat them, perfectly arranged mechanism allowing the surplus heat to pass off. The 100-chick individual brooders are large enough for all purposes. But seventy-five chicks are enough for any machine, after they get to be a month old, and fifty do better. If more chicks are wanted get more brooders. In fact, it is economy to have an extra brooder or two to divide up the chicks and put them in as they grow and the brooder becomes crowded. Don't crowd. Let this be impressed all the time on your mind. Don't crowd. Let the chicks have plenty of room, and they will do better in every way than with the hen. At two months old the chicks may be put in small houses and so make room for the smaller chicks. But I have kept chicks in the brooder until they voluntarily left the brooder for the roost.

The brooder should be cleaned every day. Put dry, fine sand on the floor, and then, with a small broom, sweep the droppings out into a box or bucket, to be deposited on the pile intended for garden manure. The sand need not be renewed oftener than once or twice a week, according to its quantity and condition. I have seen brooders in which the chicks perished by being overheated and then chilled. Overheating is common, and is the cause of the great mortality in chicks. Overcrowding is associated with overheating, but it comes from the chicks being so cool

that they crowd against one another to get warm. Brooders require little attention. I would rather manage half a dozen than one hen with chicks. And they pay for themselves over and over every year if rightly managed. Get a brooder, or several brooders. They are as handy as a clock to have about the house. It makes no difference whether the brooder is heated with hot air or hot water so that heat can be controlled and the brooder not overheated which is the cause of bowel trouble in chicks.

I prefer the brooder to hens for raising chicks. It is easier to care for 200 or 300 brooder chicks than for half a dozen hens with chicks. Brooder chicks have no lice on them, are not troubled with mites, are protected from storms, are not killed by the feet of the hen, grow fast, thrive well, are more gentle, and bear handling when grown better than hen raised chicks. They are always under your control and watchful care, and with right treatment you will raise more brooder chicks on the average than hens will raise.—[J. H. Davis, Ohio.

Brooder Capacity—Judging by my own experience in visiting a great many farms where brooders are used, I should not hesitate to say that the one great mistake of the amateur poultryman is overcrowding. It certainly will produce almost any or all of the many ailments so common in newly hatched chicks, and I do wish that something more could be done to impress it upon the beginner that one brooder and a 600-egg incubator is a bad combination. Another fault I find to be very common is trying to save oil by keeping the brooder closed when it should be open. Particularly is that true with the outdoor brooder, for which, for various reasons, I have little or no use. Give the chicks plenty of heat and an opportunity to get away from it if they want to, pure air,

and plenty of it, a dry floor with half an inch of litter, and plenty of floor space, and not until you have done at least these things ought you to complain about mortality among the chickens. If my experience in raising several thousand broilers annually counts for anything, forty, or at most fifty chicks are enough for any brooder, and my advice to one about to purchase an incubator is to buy one brooder for every fifty chicks he expects to take out of that machine for the first three or four times he sets it. That is, for one 360-egg machine run all through the spring I would plan for ten or twelve brooders, and I believe I would raise enough more chicks to pay for them.—[Francis E. Pearson, Lincoln County, Me.]

HANDLING BROODER CHICKS

The mortality among brooder chicks is due to the influences of heredity and the conditions of environment during incubation, mechanical causes, imperfect sanitation and imperfect feeding. Special emphasis needs to be placed upon the feeding. Experiments with brooder chicks by the Rhode Island experiment station showed at the end of thirty days a loss by death of 63.7 per cent in a lot fed on egg, liver and green stuff, chiefly from digestive troubles resulting in diarrhea. Another lot fed on grains alone, showed a mortality of 32.7 per cent, mainly from digestive troubles, strongly indicated by abnormal enlargement of the gall bladder. A lot fed on grain and green stuff suffered a mortality of 9.5 per cent, while a lot fed a complete balanced ration of egg, meat, grain and green stuff had a death list of only 3.5 per cent. By using a proper amount of animal food with the grain food, and supplying the necessary green food, a large proportion of the untimely deaths may evidently be

prevented, provided that the other factors are properly regulated.

The extreme variations of northern weather make it desirable that there be provided four degrees of protection or comfort for brooder chicks: (1) An inviting, properly ventilated hover, kept continuously, uniformly and sufficiently warm, to which the chicks may at any time resort as they would to the mother hen and warm up quickly. (2) A ventilated and lighted brooder or apartment warm enough to protect the chicks from chilling on raw, windy days and sufficiently attractive to tempt them from the hover as

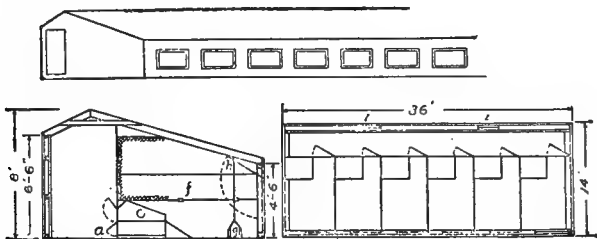

FIG. 72— PLAN OF SIMPLE BROODER HOUSE

much as possible. (3) A run protected from winds and storms by being inclosed within a brooder house, or, if outside, covered with hotbed sash. (4) An outside yard available in pleasant weather, into which even the youngest chicks should be tempted by litter, grain, green food and scraps whenever the sun shines or the winds are not too severe. In some way the chicks must be provided with a sure refuge where they will be comfortable whatever the weather. Then they should by every means possible be induced to keep out in the fresh air and to take exercise as they would with the mother hen in pleasant spring weather.

Before putting in the chicks heat the brooder to ninety-five degrees and keep at that temperature for several days. Then gradually lower it three degrees a week. A degree variation from eighty-five to ninety-five degrees at times, will not hurt the chicks. Gradually lower the temperature until the chicks are able to do without artificial heat. In cold weather this will be at from five to eight weeks; in warm weather they will need no artificial heat after the third week.

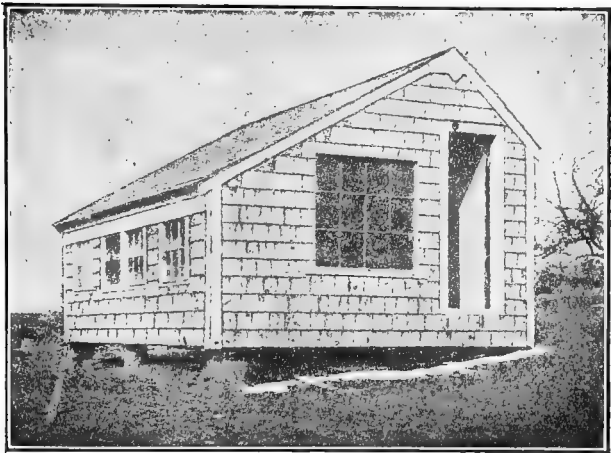

FIG. 73—A BROODER HOUSE FOR FARMERS

The brooder needs much the same attention as the incubator and if located out of doors it wants even more. During bright days the sun will furnish much or all the heat required, but as it goes down at night or is obscured by clouds, the lamp must be turned up. Failure to maintain a fairly even temperature in the brooder causes more loss of artificial chicks than anything else. The youngsters chill easily and quickly in

early spring and must have some place where they can warm up quickly or they will contract bowel trouble and then the end is near. A more uniform heat can be maintained if the brooder is located in a shed or building protected from sun and wind. For this reason it pays to put up a brooder house, and in building it one should make it warm, and substantial so as to

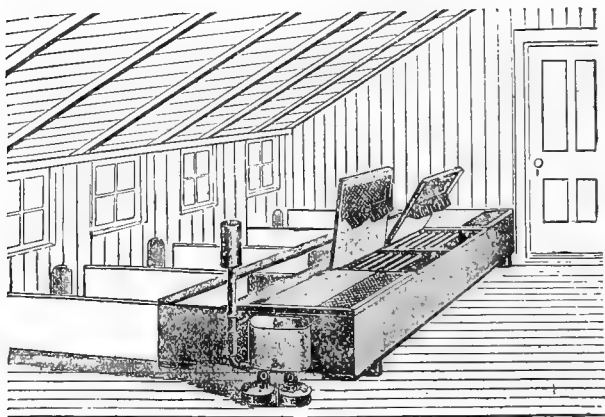

FIG. 74—SECTIONAL HOT WATER BROODER

be easily heated in late winter, when one wants to get out an early hatch.

BROODER HOUSES

There are several styles of brooder houses which may be used. The long, continuous house, heated by hot water, is useful on large chicken ranches where hundreds or thousands are raised annually, but smaller houses in which can be placed individual brooders are best for most poultry keepers.

A brooder set out of doors is all right in summer but it is no place to put a lot of chickens in during the changeable weather of early spring. It will pay to have a cheap house in which to put the brooders or a shed that can be closed in during stormy weather. The advantage of a small house is that the brooder can be kept at a more uniform temperature, but even more than this it provides a place of exercise for the chickens during long continuous storms which frequently last two or three days in early spring.

A continuous house should be twelve to fourteen feet wide and of any length desired. It should have

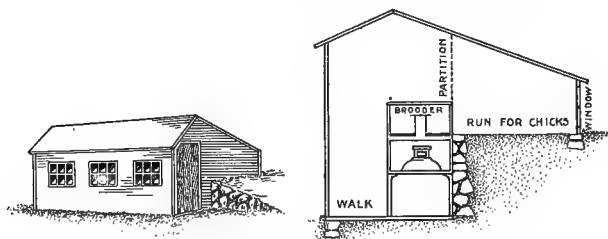

FIG. 75—SIDEHILL BROODER HOUSE

an alleyway three feet wide and six and one-half feet high at the back for convenience in doing the work. This house may be fitted up with a hot water system of brooders, or individual brooders can be used. For raising early broilers it is necessary that the house be heated artificially. A small hot water boiler and a coil of pipe going around the building inside the outer wall is necessary. If the passageway is lowered twelve to fifteen inches it will make less back-bending work to care for the brooders, particularly if individual brooders are used. The long slope of the roof should be toward the front. Such a house is shown in Figure 72, which gives the dimensions and suggests details.

This is designed for individual brooders, but the pipe system can be used. After the chicks are old enough the brooders can be removed, a board fitted in the partition and a movable platform and roost placed in each pen. Such a house will be very handy at all seasons of the year. Another style of house is shown in Figure 73, which is twelve by sixteen feet in size,



FIG. 76—ONE OF THE AUTHOR'S COLONY-BROODER HOUSES.

papered and shingled all around. This will hold five brooders with fifty chicks in each brooder and allow a pen three feet wide for each. Small holes are cut in each pen and yards thirty feet long built in front. A sectional hot water brooder shown in Figure 74 may be used to advantage in such a house. Still another style of house is shown in Figure 75.

Individual brooder houses which later in the season can be used as colony houses pay well. They can be built of any style desired. Several good ones are shown in Figures 76, 77, 78 and 79. These houses should be not less than four feet high at the rear, five feet in front and five by seven feet in size. A house six by eight feet is much more convenient than one five by seven feet and costs but little more. They should be

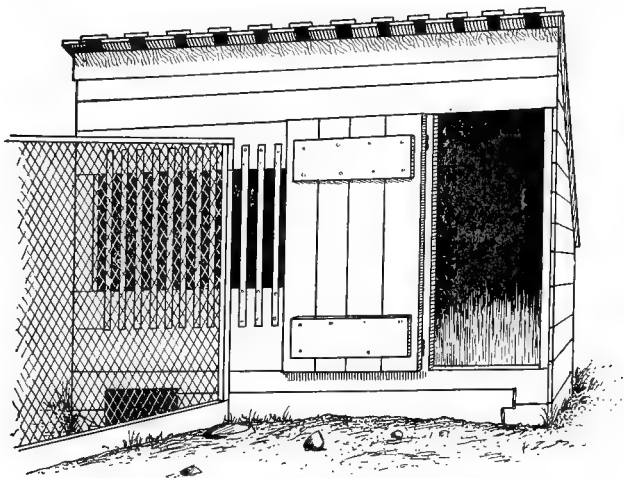

FIG. 77—INEXPENSIVE COLONY-BROODER HOUSE

built of planed and matched lumber well put together, and for use in early spring covered with building or roofing paper on top and sides to give greater protection. After the chicks are big enough remove the brooder and place in the house two or three roosts. Such a house will accommodate fifty chickens until time to remove the cockerels. The windows should be taken out and replaced with wire covered screens.



FIG. 78—SMALL BROODER HOUSES AT MAINE AGRICULTURAL COLLEGE.

A Piano Box House—Piano boxes make very cheap and useful houses for many purposes. We have used them successfully in early spring to hold a brooder. There is space enough to give plenty of room for the young chicks to exercise. Later the brooder is taken out and the house affords ample room for fifty to 100 young chicks. In winter it will hold ten or twelve hens. They also make good breeding houses in which to confine small pens of special mat-

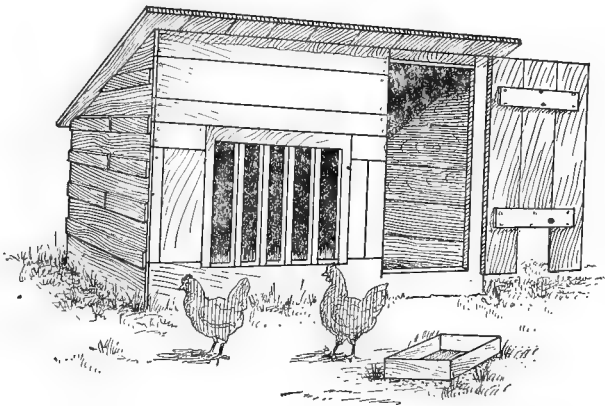

FIG. 79—A RHODE ISLAND COLONY-BROODER HOUSE

ings. We wintered thirty fowls one winter in one of these houses but they had the run of a large shed and never did a flock lay better than this. Two boxes of the same size should be procured. Remove the top and backs. Set them on two poles or scantlings back to back and about twenty-two inches apart which is the width at the top. Put down one top to fill out the floor and use the other to close up one space between the ends. Take the backs to pieces and rip one board

diagonally corner to corner so as to give the necessary slant to the roof. The boards which come from the two backs will cover the roof and make the door. The roof, or better still the whole building, can then be covered with a good building or roofing paper. One window of most any size can be placed in the front or if one wishes, at each side of the door wherever it is most convenient. These houses complete will cost \$5, the price depending on what one has to pay for the

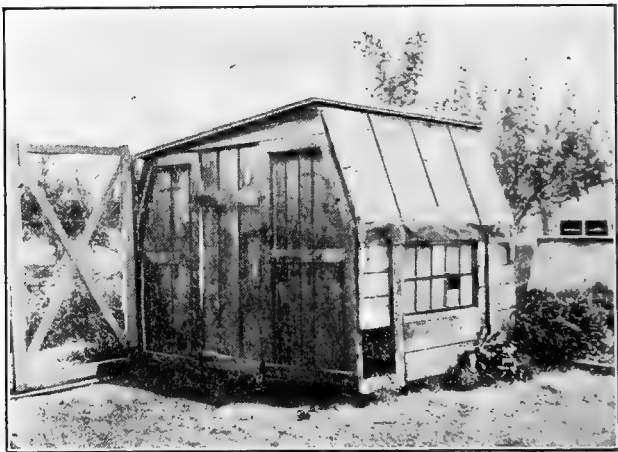

FIG. 80—BUILT OF TWO PIANO BOXES

boxes. We have two houses of this type in use illustrated in Figure 80, but some poultrymen use them exclusively.

Another type of colony-brooder house is shown in Figure 81 with wire covered yard attached. This house is put on sills of two by twelve-inch plank which are cut on a bevel at one end to serve as runners. Elevating the floor makes it easier to look after the

brooder and care for the young chicks. This also provides a shady place for the chicks to run under as they grow older. There is no door to this house, but the roof is made in two parts and hinged at the sides so that it can be opened, thus exposing the inside. The house is two feet high at the rear and three feet in front above the sill, four feet wide and six feet long. The yard attached can be of any size desired and covered with either one or two-inch mesh netting. This house is also very useful for special matings. If cleaned daily and moved to fresh ground once or twice

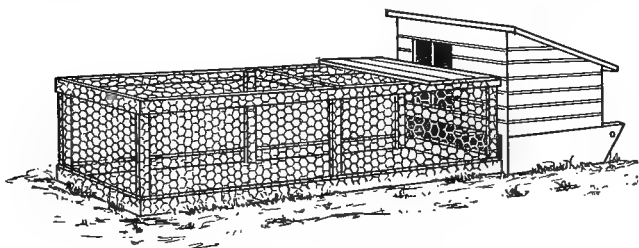

FIG. 81—AN INDIANA COLONY-BROODER HOUSE.

a week twelve fowls can be kept in it with a yard six by twelve feet in size.

. *A Gasoline-Heated Colony-Brooder House*—Latest developments in artificial brooding are to get away from the small individual indoor and outdoor brooders and to adopt a system that will hover more chicks at a less expense of fuel and labor. A system of using gasoline for heating a brooder is being successfully used by the Poultry Husbandry department of Cornell University. It has been devised by Prof. James E. Rice and associates. By his method of rearing chickens in large flocks in colony houses heated with gasoline from 1700 to 2000 chickens have been reared each



FIG. 82.—CORNELL COLONY-BROODER HOUSES AND YARDS

year for the past five years in thirteen colony houses (Figure 82) which formerly would have required about fifty ordinary kerosene-heated brooders. In experiments conducted by Prof. Rice it was found that in large colony-brooder houses with a large hover, where the temperature was kept at 100 degrees, 100 chicks could be brooded as successfully as fifty in a flock, and continued experiments show that 200 could be handled with practically the same labor and no more loss.

The secret of brooding in large flocks, if there is any, is to maintain a temperature of 100 degrees at all times accessible to the chickens. The larger the flock the more important it is that a high temperature be maintained, because the greater is the danger of crowding. If the temperature of 100 degrees is maintained, the chickens will spread out of their own accord. They can be trusted to remain in the temperature which is most comfortable to them, which also will be the temperature best suited to their needs. This heat cannot, with safety, be so well maintained with a kerosene burner, but with a blue flame gasoline burner and a brooder properly constructed, there is little or no danger of fire.

A five-gallon can is suspended inside the house at the top and filled as needed with gasoline. A pipe leads this to the burner arranged beneath the hover where a constant flame is maintained. The flame can be regulated at the will of the operator.

The "A" type of house (Figures 83 and 84) is eight feet square, inside floor measure, has twelve-inch side walls and is six feet, six inches from top of floor to top of ridge board. The sub framing is made and both floors laid before the upper part of the building is put together. The sills are gotten out first. They are made of two by twelve-inch stock and are cut eight

feet long with a bevel at each end to form runners or shoes upon which to draw the house about when desired. The floor joists, four in number, are made of two by four-inch stock, cut eight feet long, and are fitted into the runners with a half joint. This gives a strong sub frame that is not likely to get out of square when drawn over uneven ground. After fitting the joists into the runners and securely nailing



FIG. 83—CORNELL COLONY-BROODER HOUSE.

with 20d nails, the work is leveled, squared, and tied by means of a one-inch board nailed diagonally across the joists. The first or sub floor is made of one-inch matched hemlock siding and is laid diagonally, which helps to stiffen the building. The finished floor is made of seven-eighths-inch sap (white) pine flooring. This is blind nailed and is laid over a layer of building paper.

The studs are now put up (Figure 84). These, together with the plates, rafters and ridge-board, are made of seven-eighths by two and three-quarters-inch clear hemlock stock. The studs are placed flush with the outer edge of the floor and are toe-nailed to the plates. These are held in place temporarily by nailing a strip of board diagonally across them. The front and rear studs are fitted in place and then the boarding

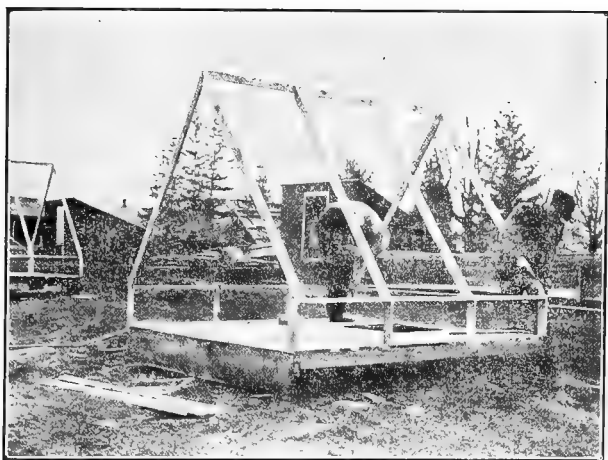

FIG 84—FRAME OF CORNELL COLONY-BROODER HOUSE

put on. The boards are put on horizontally and overlap the floor two inches.

The building is inclosed with seven-eighths-inch matched siding, planed one side, with the smooth side turned in. The boards for sides and roof are cut in eight-foot lengths, and since the house is to be eight feet square inside, a small space is left at each corner which is filled by a quarter round molding, thus making it possible to use sixteen-foot stock without waste.

The ends are boarded up solid, with the exception of the door opening. After the paper has been put on, the casings for the windows are nailed in place and then the openings cut. By this method of construction no studs are required for the windows.

Best results have been secured by running the strips of roofing paper vertically, instead of horizontally, as is generally recommended. The laps are made to come over the rafters and are covered with a three-quarter by two-inch batten. It requires much less time to put the paper on in this way and it presents a more pleasing appearance. After the house is

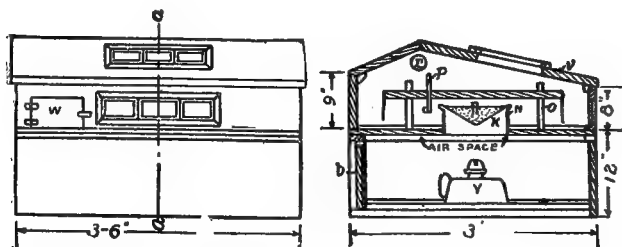

FIG. 85—DR. WOODS' BROODER

enclosed and doors and windows fitted and hung, the heater is put in place.

The burner used is the Dangler Furnace and Laboratory Lamp burner No. 154. The Omaha burner has also been used successfully, also the Menges burner. This type of house complete with brooder, burner, etc., has cost in Ithaca, N. Y., \$37.50.

Much experimenting has been done in the way of homemade brooders, some of which are both economical and successful. Most poultry keepers think that manufactured brooders cost too much, hence they do not procure enough brooders to properly accommodate

the chicks and severe losses are therefore sustained from overcrowding. Several good brooders are here described.

The Up-to-Date Brooder—A good homemade brooder that is up to date and can be depended on to raise a good percentage of the chicks intrusted to it when rightly managed is illustrated in Figure 85, and was described in *Farm Poultry* by Dr. Woods. It has stood the test of several seasons under varying conditions, and has successfully reared ninety per cent of the chicks placed in it. It is an economical brooder to build, and the cost for material, where all new stuff is used, need not exceed \$5 (this including lamp). By utilizing waste stock it can be made for less than \$3 (labor not included).

The brooder is made three feet wide from front to back, and three and one-half feet long from side to side. A general perspective view of the brooder complete is shown in Figure 85 with the smaller section of the movable roof removed and the loose board used for lamp door partly open. The front view shows how the windows are arranged and the door, *w*, by which the chicks enter and leave the brooder; an opening is left for inlet of fresh air into hot air chamber; there are two of these openings, one opposite the other. These openings may be made in the sides if more convenient. They are one and one-half inches wide, and the depth of the board which separates the iron floor of the hot air chamber from the floor of the brooding chamber. In cold weather it will prove economy in oil and heat to partially close one of these openings. The sectional view shows the construction of the brooder in detail.

The lower frame for the lamp chamber is built first, and is made of sufficient height to accommodate your lamp, and leave a space of nearly an inch between

the top of your chimney (if you use one), and the iron floor of the hot air chamber. To the top of the three sides of this frame, which are of equal height, is nailed the iron floor of the hot air chamber. This is a sheet of galvanized iron thirty-six by forty-two inches. Above this iron floor is fastened a frame of strips of board two inches wide to form the outer walls of the heat chamber, openings being left for the inlets. It is nailed fast to the iron in the back, and through the iron to the lower frame on the front and sides. On this frame is laid the floor of the brooder proper, which is made of matched boards. Before the floor is made fast to the frame a circular hole must be made in the center to receive the iron ring which conducts the heat into the brooding chamber. This hole in the wooden floor is nine inches in diameter.

The front and sides of the brooding chamber form a movable three-sided frame, firmed together at the upper portion of the rear third by a strip of inch stuff. In the front section of this frame is a six by eight-inch window, and a door, *α*. The door is hinged, and fastens with a button. The window is beveled at the top to shed rain, and is screwed to the frame. A cheaper and homelier way would be to set two lights of glass in the wood of the frame. .

The roof is made in two pieces. The main or front section is removable, and is held in place by cleats, as shown in cut. When the brooder is in outdoor use this section of the roof, *τ*, is secured to the sides of the brooding chamber by screws through the side cleats. The chamber sides are screwed to the base or floor cleats. A window ten by eighteen inches is provided in this part of the roof. The rear section of the roof is a movable board fitted and cleated and held in place by the cleats, with the additional security of a hook and screw eye on either end to keep animals from breaking

in at night. This small movable roof section is a great convenience. At the upper and rear third of the sides of the brooding chamber is a ventilator, *v*, one on each side, and having a tin, galvanized iron or wood shutter, as shown. The ventilating holes are two and one-half inches in diameter.

The heat conductor is a galvanized iron ring nine inches in diameter, and three and one-half inches high. This is fitted into the hole in the wood floor of brooder, and held in place by three nails driven from inner side of ring. To this ring is attached the heat spreader, an inverted cone of galvanized iron, hung to the ring by three strap hooks of galvanized iron. This heat spreader, *k*, is kept filled with chicken grit or gravel, which serves to hold the heat, and keep the temperature more uniform. The spreader serves to diffuse the warm air equally on all sides under the hover. The ring is wound with a triple thickness of felt, which entirely covers in the metal parts, and does not conduct a sufficient amount of heat to make the chicks crowd around the heat flue. It is important that the iron ring be wound with felt or some insulating material.

The hover is circular and is twenty-eight inches in diameter. It is made of matched stuff, and has no ventilating hole, as none is needed. A hole is made for the thermometer, and three holes for the hover legs; *p* is the thermometer, and *o* the legs. The legs (three in number) are ordinary broom handle, and are drilled so as to be adjustable from four and one-half to six and one-half inches in length, the hover being held in place by nails passed through the drill holes. A double thickness of slashed felt is used for hover curtains (any kind of cloth that does not fray easily will answer). These flaps come down to within half an inch

of the floor when the legs are at the four and one-half-inch length.

The lamp chamber has a one and one-half-inch ventilating hole in the side close up to iron near the front of the brooder. The lamp I have had the best results with, and the least trouble, is a common tin lamp (made from a tin pan), holding three pints of oil,

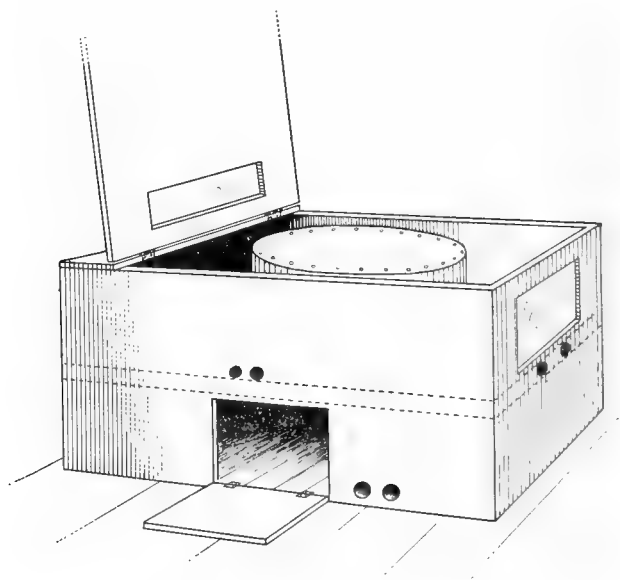

FIG. 86—AN IMPROVED BROODER

and having a common kitchen lamp burner with a glass chimney or a chimney of Russia iron (the iron chimney is best), having an isinglass opening in front to view the lamp flame.

An improved brooder is shown in Figures 86 and 87. Figure 86 shows the brooder complete with

cover raised. The hover is shown within the top. The upper dotted line shows the position of the matched board floor and the lower dotted line shows the position of the sheet iron beneath which the lamp stove is placed. Figure 87 shows the drum of sheet iron, or galvanized iron, which is attached to the edge of a circular opening in the floor, as shown at the right. This cut shows the floor, the sheet iron and the two-inch space between them, with the lamp underneath the sheet iron. The air above the sheet iron is warmer and rises through the drum, escaping through the small openings under the top, out into the brooder. A

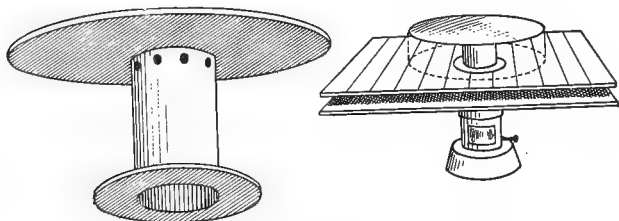

FIG. 87—HEATER PARTS FOR BROODER

cloth curtain is hung around the edge of the broad top of the drum, forming a hover, into which the chicks go for warmth. This curtain is "slashed" up every few inches. Openings in the sides of the brooder admit air to the lamp, to the space between the sheet iron and the floor above and also ventilate the brooder chamber. These openings from the brooder chamber can be controlled by corks in very cold weather. The brooder can be made any size up to three by four feet, which is large enough for seventy-five chicks. It can be heated with an incubator lamp or any good lamp with No. 2 burner and large oil chamber.

A Good Brooder—One of the best and simplest homemade brooders (Figure 88) we ever saw is used largely by G. G. Tillinghast of Connecticut, a successful poultry keeper and fruit grower. It costs not to exceed \$2.50, if made of all new material. It is built of matched lumber and consists of a frame three feet square and one foot high. In one side there is a door

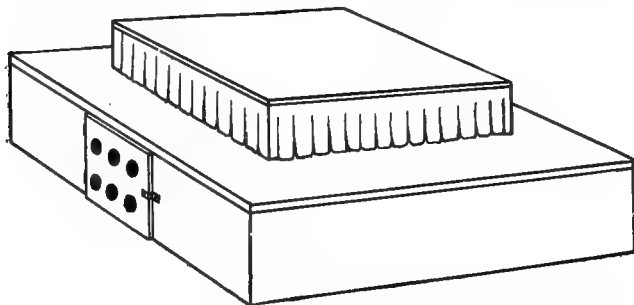

FIG. 88—THE TILLINGHAST HOMEMADE BROODER

or slide in which to place the lamp. This frame is covered with a sheet of galvanized iron and over this around the edges are nailed inch furring strips. A hole one-half inch high and one inch long is made through the ends of two strips on opposite sides to provide ventilation. The floor is nailed on these furring strips.

In the center of the floor is cut a four-inch square hole and over this is nailed a radiating drum. This drum is a two-quart tin pan, through which are punched a dozen holes with a big nail to allow the heat to escape under the hovers. The hover is two feet square and six inches high, with edges lined with felt slashed so that the chicks can easily get under it. The felt comes to within one inch of the floor. There is no cover to the brooder. A frame one foot high and

three feet square is placed on the brooder to confine the chicks until they are a week old, when some sods are thrown up against one side to make an incline for them to go up and down. The brooder is, of course, kept indoors.

The lamp is one of the most novel features. It is made of a two-quart tin pan and a tin pie plate soldered together. Three or four small holes are punched in the pie plate to allow the heat and gas to escape from the kerosene. A hole is cut in the pie plate and a No. 2 burner soldered in. This lamp holds oil enough to burn two or three days without filling. In very cold weather two lamps are placed under the brooder.

A Simple Hot Water Brooder—Figure 89 shows a simple form of hot water brooder to be used without a lamp, the galvanized iron tank being filled with hot water night and morning. The cut at the right shows the position of the tank behind the front board, the bottom having attached to it a double row of slashed woolen cloths, under which the chicks can run. The tank is seen to set back from this board, giving a chance for a packing of sawdust, or bran, over and all around the tank. The chicks huddle beneath the tank, and if they find it too warm, they poke their heads out

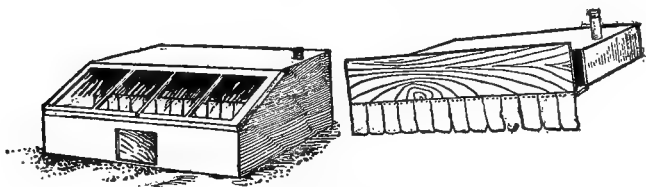

FIG. 89—HOT WATER BROODER AND TANK

through the cloth, or come wholly out into the outer, or scratching, room. Keep the tank hot enough so the chicks will not crowd together under it, but will be inclined to put their heads out through the cloth.

CHAPTER VIII

Broilers, Capons and Roasters

Broilers are young chickens under three pounds weight that are quickly grown and suitable to split in halves and broil over an open fire. In the South such chickens are commonly known as "fries." They are most in demand during May, June and July, but there is a market for them at all times. The raising of broilers has become a business in which large capital is invested, and single farms turn out thousands every year. It is a business which can be carried on by the housewife with a few hens as well as by the big broiler plant. The requisites are early hatched chicks that are grown rapidly and made to weigh one and one-half to two and one-half pounds each at ten to twelve weeks old. This industry requires both skill and capital when conducted on a large scale. A successful broiler plant should be run in connection with an egg farm, so that the eggs may be supplied from the home yard. It is difficult to get a good hatch in winter time from purchased eggs. They either get chilled or are infertile. The second requisite to success is a good incubator. Hens cannot do the hatching during cold weather. The brooder is important after the chickens have been hatched. Success in growing chickens during the confinement of the winter months does not consist so much in variety and quality of the food given as the manner in which it is fed and the amount of heat to which they are subjected when in the brooder. Of course chicks will always grow faster, develop better and mature sooner when the food is adapted to their age, growth and wants.

The American breeds—Wyandottes, Plymouth Rocks and Rhode Island Reds—are commonly used for broilers; any quickly-growing, plump bird will do. Leghorn and Minorca cockerels at ten weeks old make excellent broilers. Brahmas usually lack in plumpness. In order to determine the best breeds of fowls adapted for broilers, and also the cost of raising them to a marketable age, the South Carolina experiment station has conducted some experiments on these lines. Three varieties of thoroughbreds, two crosses of thoroughbreds, and two crosses of thoroughbreds on common fowls were used. The eggs were hatched in incubators and ten chicks from each lot were put into a brooder.

The chicks were fed the first week on bread made of equal parts corn meal and wheat bran, mixed with salt, buttermilk and soda, and thoroughly baked. They were fed all they would eat five times a day. The second week they were fed bread at six o'clock, beef scraps at ten, bread at two, and at four. German millet was scattered in straw for them to work on until night. After the second week they were given bread, beef scrap, cracked corn and cracked wheat. They also had skimmilk, buttermilk once a day and all the green food they would eat. The following table shows the growth of the chickens to twelve weeks of age:

WEIGHT IN OUNCES PER CHICKEN

	2d week	4th week	8th week	12th week
Barred Plymouth Rock	3 $\frac{3}{4}$	9 $\frac{1}{2}$	29	43 $\frac{1}{2}$
S. L. Wyandotte	3	8 $\frac{3}{4}$	28 $\frac{1}{4}$	42 $\frac{1}{2}$
Indian Game	3	9	28 $\frac{3}{4}$	43
Indian Game X Plymouth Rock..	4	10 $\frac{1}{4}$	32	45 $\frac{1}{2}$
Pit Game X Plymouth Rock.....	3 $\frac{1}{2}$	10	31 $\frac{3}{4}$	46
Plymouth Rock X common.....	3 $\frac{1}{4}$	8 $\frac{1}{2}$	23	43
S. L. Wyandotte X common.....	3	8 $\frac{3}{4}$	26 $\frac{1}{2}$	41

The Wyandotte, Indian Game and Plymouth Rock cross and Pit Game and Plymouth Rock cross showed

a plump breast. The Pit Game and Plymouth Rock cross, the Plymouth Rock on common hen cross, and the Wyandotte had most feathers. The Indian Game had few feathers but was plump. The cost of feed, which during the experiment was unusually high, was seven and one-half cents per chicken to eight weeks old, and twelve cents per chicken at twelve weeks of age.

Finishing Broilers—When nearly large enough for broilers put the chickens into a pen having a shady run and a shady side. Here give them clean, fresh water once or twice a day, and all the fattening food they can eat. Muscle and bone-making foods, remember, are not required. Corn in various forms, however, should be fed freely to them. Cooked corn, mashed corn and ground corn, as well as whole corn, should be fed every day. Warm potatoes and bread crumbs will also make fat. Any kind of milk and a little sugar will likewise help along the fattening process, and this should be as fast as possible, for during these days the chicks will eat considerable, and if they do not lay on fat every hour it will be a losing operation.

Squab Broilers—Small chicks, known to the trade as squab broilers, may be grown in eight to ten weeks in brooders kept in a room where the temperature is kept at about seventy degrees. The Rhode Island experiment station found that when marketed at this age they could be successfully raised without any outside exercise.

Celery fed broilers are broilers fed celery for a few days previous to killing, to flavor the flesh. Feeding celery for this purpose is but little practiced. It originated with some duck growers who fed their ducklings celery to give the flesh a flavor similar to

that of the wild ducks whose flesh is flavored by the wild celery which forms a part of their diet.

Philadelphia broilers, as the term implies, are broilers raised in the vicinity of Philadelphia, and are mostly bought up by New York city dealers, or at least the best of them find their way to New York, simply because New York consumers are willing to pay more for good broilers than Philadelphia consumers. It is also well known that the broilers raised within thirty miles of Philadelphia are the best to be found. They are noted for plumpness, with clear, yellow skin. The breeds most desirable are White Plymouth Rock and White Wyandotte. For small broilers a White Leghorn male crossed on White Plymouth Rock females will get the finest one and one-quarter-pound broilers that are put on the market. For one and one-half-pound broilers either White Wyandottes or White Rocks cannot be beaten. Being white, they dress off fine and do not show the pinfeathers like other colors.

The method of feeding is four times a day for the first three weeks, then three times a day. At first the feed consists of equal parts of bran, brown middlings and corn chop, and some No. 2 flour to stick the mixture together. Put the flour on after wetting and mixing, and shake it through the feed. It takes ten days to fatten the chicks, and the fattening feed should consist of four parts corn chop and one part bran. Wet and mix and use flour same as above. Confine the chicks in close quarters while fattening, and any which do not come up to the standard in ten days should be thrown out where they can range for at least two weeks. A healthy chick will get very fat in this time.

Feed light for the first two days. Give fresh water every feed, feed only twice, and give all they can eat. _Take away what is left as soon as they

stop eating. Against the wall place coops eighteen inches square, with slat front, with six-inch board run along in front to set the feed and water on. Put six chicks in each coop. Give plenty of grit; crushed flint is best.

When ready to ship, kill and pick dry, and if enough are ready at once the best thing to ship in is a barrel. If small quantities are shipped use an egg case, butter crate or any kind of a box. Broilers are very tender and should have a small quantity of either clean straw or excelsior on top and bottom to keep them from chafing. Cool thoroughly in ice water before packing and in warm weather use crushed ice on top, then the excelsior on top of the ice. Philadelphia broilers can be raised anywhere once the trick is learned, yet it will require some experience to get them so nice and fat that they appear almost like squabs. With strong, healthy breeding stock, which lay good, fertile eggs, the victory is half won.—[G. A. Fetridge.

CAPONS AND CAPONIZING

A capon is a castrated cock, especially when fattened. The object in caponizing is to secure quality and size, but quality is the most desirable. To secure this, much depends on both the breed and the feed. To secure the best capons, the birds must be given plenty of time to mature, and cannot, therefore, be marketed while young. A few months' old capon is no better than a cockerel. In fact, age does not impair the quality of a capon, provided the bird is not kept over a year and a half, as it more readily fattens after reaching maturity than before that time. The one great mistake in raising capons is in marketing them too early.

The demand, consequently the market for capons, is a peculiar one. While there is a very limited demand during the entire year, the bulk of them are sold between the holidays and spring. The turkey holds the place of honor at Thanksgiving, divides it with ducks and geese at Christmas and New Year's, and when these are past, there is more inquiry for capons, which continues till April or May. So little call is there for them outside of this season, that many, if not all dealers, cease quoting prices at other times.

The profit in capons is a moot question. It will not pay to perform the operation on any but the larger breeds, and there are many individuals and many localities where it will not pay at all. While good capons usually sell for somewhat higher prices than roasting chickens, the difference in price between the two is less than formerly. In Boston, it is said that the larger part of the capons are dressed clean, and sold as "south shore roasters." A capon must be fed for so long a time before marketing that the feed bill eats up a large part of the extra price.

Many poultrymen say that there is more profit in keeping pullets for eggs in the space that would be occupied by capons. But locality and circumstance must decide this point. A poor capon will bring no more than a chicken. The small sizes of capons, about five or six pounds, sell quite readily, but at lower prices. The large ones weighing nine, ten and twelve pounds, or even more, bring higher prices per pound. They take the place of turkeys to a considerable extent.

Capons grow rapidly and mature early, as they are quiet and peaceable. Their flesh remains soft and juicy, like that of a young chicken, and as a rule, they bring considerably more per pound than natural birds. They are most in demand from after the holidays and

until June and are not commonly marketed until from eight to fourteen months of age. Capons make more weight for the feed they eat than do other fowls, as their only ambition is to eat and rest, two things which are favorable to the production of fat and growth. A flock of capons are quiet, do not crow and are easily taken care of.

The best breeds to caponize are the medium sized varieties such as Plymouth Rocks, Wyandottes, Rhode Island Reds, etc. The Asiatics do not give as satisfactory results unless kept until they reach maturity, when they are so large as to be beyond the reach of private families. It does not pay to caponize smaller breeds, for they do not produce dressed fowls of the highest quality. A cross of the Dorking or Indian Game on Light Brahma, or a Pit Game on a Houdan-Brahma hen, will produce very fine capons. A pen of fine capons, mostly Brahmas, are shown in Figure 90.

The Operation—Birds are three months old. They are confined to the table by straps and weights around legs, wings and neck. A space of several square inches is plucked clean, a slit made with a sharp knife between the last two ribs one and one-half inches long. The ribs are held apart with a wire spreader, the intestines are moved back, the organs found and removed by a twist with the spoon hook. Apt students complete the operation in about three minutes.

To avoid needless cruelty the beginner should practice first with a dead fowl. The operation is best performed on chickens about three months old, although it will succeed if carefully done on older birds, but the percentage of deaths, slips and culls will be greater.

As with many other operations, this is one that can be learned most readily by seeing it done, and we advise those who would undertake it to procure



FIG. 90—PEN OF BRAHMA AND COCHIN CAPONS

instructions wherever it is available. Still, if one has a little confidence, he will meet with success if the directions here given are carefully followed.

In the first place a table is needed, in which a few screw rings are inserted at convenient places; these are furnished with broad tapes, by which the bird is securely held during the operation.

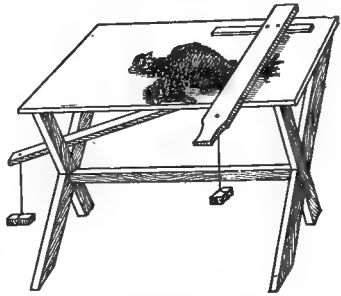

Two styles of tables are shown in Figures 91 and 92, but a barrel can be used. A set of tools is shown in Figures 93, 94 and 95.

Place the bird upon the table and fasten it down upon its left side, as shown at Figure 92, where the rings and ropes are seen. Straps with weights may be used instead. The spot where the opening is to be made is shown by the *x*. Here the feathers are plucked and an opening is made through the skin with a pair of sharp-pointed, long-bladed scissors, or a lance made for the purpose. The skin is drawn to one side and an opening is made with the instrument between the last two ribs for an inch and a half in length, great care being taken not to wound the intestines. The ribs are then separated by the U-shaped spring hook, so as to expose the inside. The intestines are gently moved out of the way with the handle of a teaspoon and the glands or testicles will be seen attached to the back. The tissue which covers them is torn open with the hook, aided by tweezers. The gland is then grasped with the forceps and the cord is held by the tweezers. The gland is then twisted off by turning

the forceps; and when this has been done, the other one is removed in the same way. Care must be taken not to injure the blood vessel which is connected with the organs, as this is the only seat of danger in the operation, and its rupture will be fatal. The hook is then removed, and if the skin has been drawn back-

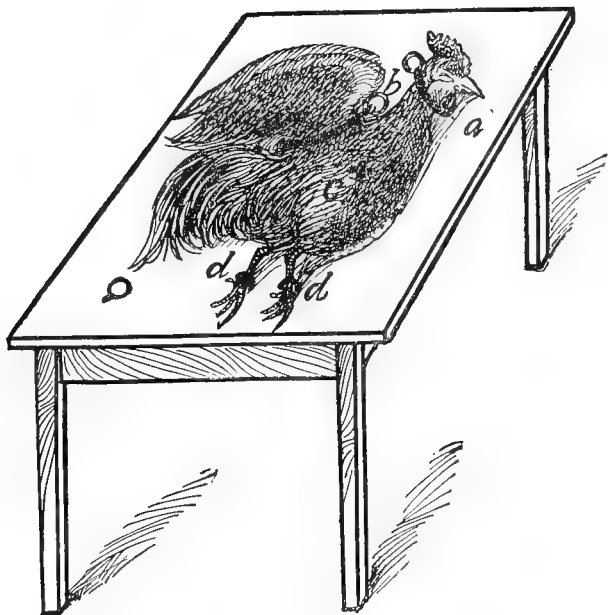

FIG. 92—POSITION OF FOWL ON OPERATING TABLE

ward at the outset it will now slip back and cover the inner skin which covers the intestines, and close the opening. No stitching is needed. A few feathers are drawn together on each side of the opening and plastered down on the skin with the blood, where

they will dry and form the best possible covering to the wound, which will begin to heal at once. The bird should be fed with a very little milk for a few days after the operation, but should have plenty of water. For two nights and one day before the operation no food or water should be given to the bird. This will greatly facilitate the work, and reduce the chances of loss. The operation, after a few successful trials, may be performed in less than three minutes; and by the use of the rings and taps, no assistance is needed.

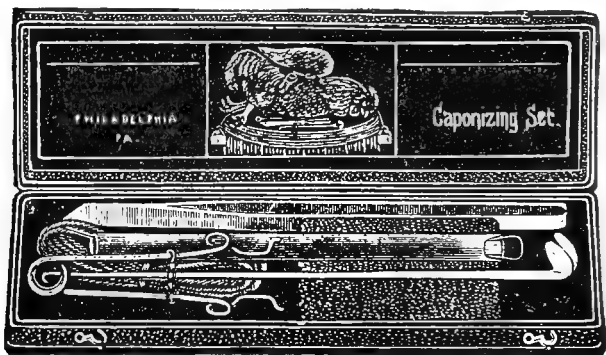

FIG. 93—SET OF CAPONIZING TOOLS

Examine the bird daily after the operation, until the wound is healed. The skin may puff up with air, and if this occurs an opening should be made with a needle inside a quill. Withdraw the needle, leaving the quill in, and press out the air, then remove the quill.

The one great mistake in raising capons is in marketing them too early and not having them fat enough. After caponizing keep them growing until they reach full size, which will take from six to ten

months. Then fat them. This can be done in two weeks by shutting them in a small, dark coop and feeding three times a day all they will eat of corn meal and middlings mixed up with milk.

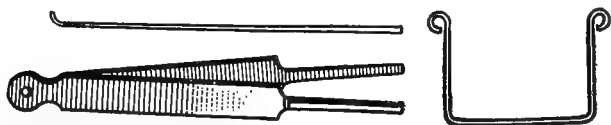

FIG. 94—TWEEZERS, SPRING HOOK, WIRE HOOK

The New York operating expert, I. C. H. Cook, writes: "Some care should be exercised in performing the operation lest the large artery following along the backbone is ruptured, since that would cause the immediate death of the chicken; still there is no loss, for he only provides us with a good broiler! Then, too, another thing to expect is from fifteen to twenty-five per cent 'slips'—these are cockerels on which imperfect operations were performed, and as they mature the comb grows, and to all appearances they are roosters. Possibly the most important factor of all in a

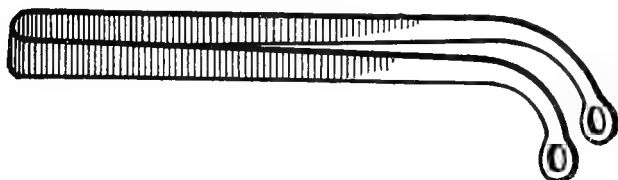

FIG. 95—SPOON FORCEPS

successful operation is having the cockerel at the proper age. I am better acquainted with the Plymouth Rocks than any other breed, and with them about three and one-half months seems to be the proper age.

Those breeds which mature much earlier, like the Leghorns, should be operated upon much younger, while a Brahma could possibly be caponized when five or six months old, and not have much danger attending the work.

"As soon as caponized the chicken should be given all the ground feed and drink it wishes, for it is hungry, since, in order to facilitate matters, the cockerel should be fasted about thirty hours previous to the operation; in three days' time the wound should be healed over, and in two or three weeks it would be quite difficult to find even a scar.

"Now we have a bird that will put on flesh at a surprising rate, the meat is of a delicious flavor and very tender and juicy, and with the same amount of feed, a capon will weigh about a third more at a given age than if left as a rooster. It is well worth the trouble to have the noisy young cockerels transformed into quiet, lazy birds, even if we were recompensed in no other way, but the price to be obtained for capons is what pleases the grower of them most of all, as the regular quotations range from six to ten cents above the ordinary chicken. I well remember the first year I engaged in this department of my poultry work, when I sold twenty capons averaging eight pounds each at twenty-five cents per pound, one of which dressed nine and one-half pounds, and a well-known lawyer paid me \$2.37 for the same. So we see the advantages are threefold—a better price, a larger bird and a quiet bird.

"The question usually comes up, What is the best breed for capons? All breeds. That is, whatever variety of fowls one has, by all means caponize your surplus cockerels; but for market purposes the larger breeds are of course preferable. The Plymouth Rock, for instance, is as good as the best; I, at least, am

perfectly satisfied with them, and come to this conclusion after trying several other breeds. But the best results in this as well as in any other line of work are attainable only by persistent effort, and doing it all in a thorough, businesslike way, having perfection as our goal and watchword, and then strive to win it."

Experience with Capons—An Ohio poultryman who has made a success of capon rearing is J. G. Hover. He writes: "My attention was drawn to capons by seeing them quoted in the New York markets at eighteen to twenty-six cents per pound. I concluded I would produce some and take my chances on learning how to caponize, feed, fatten, butcher, pack and ship. When young market fowls were selling at five to six cents per pound, eighteen or twenty cents seemed an enormous advance. My first experience was with fifty-one Barred Plymouth Rock cockerels, which weighed at the time of the operation in October three to six pounds each. It took me nearly two and one-half days to perform the operation. I could have done it much more rapidly if the birds had not been so big and strong. Forty-five of the birds survived. Under more favorable circumstances and with more experience, the loss of six of the fifty-one would have been a large percentage.

"I did not give them any special care through the winter, but just let them run with the other farmyard fowls until about three weeks before shipping, when they were separated from all others and fed alone on corn, corn meal and bran mixed with plenty of fresh water. Oyster shells were provided freely. They had not been crowded any through the winter and only weighed when dressed five and one-half pounds each. Forty were sent to market and sold for eighteen cents per pound and brought \$39.24, or nearly one dollar each. The feathers were very nice, as they were

picked dry, and sold for ten cents per pound, which more than made up the dollar. Capons must be large and fine to bring the best price. They should weigh from seven to ten pounds, or more, each. As near as I can estimate the cost of these capons was forty cents each, leaving in even numbers sixty cents for profit, or \$24 for the lot. This I considered very satisfactory returns for the first attempt.

“Remember this was some years ago, the sale being made in the spring of 1892, but as good or better results can be secured now by selecting heavy breeds and giving them good care and feed. Keep them growing rapidly. It will not pay to caponize cockerels of small breed, as they will weigh but a few pounds and sell at a low price. The size and development of the bird determines the time to caponize and not the age. No bird that weighs less than one and one-half pounds should be operated upon. Two pounds is just right.”

THE SOFT ROASTER INDUSTRY

The farmers along the south shore of Boston Bay of eastern Massachusetts have developed a special poultry industry which requires the most labor during the winter months and the least amount in summer. This section of the state is essentially a locality of small farms. On the largest plant, with a capacity of 6000 chickens a year, one man in addition to the proprietor does all the work.

Soft roasters are fowls which have nearly reached maturity and are marketed while the flesh is still soft. The demand opens in a small way in January and continues until midsummer. The best prices are realized in May, June and July and usually reach thirty cents per pound live weight. The market opens at

fifteen to twenty cents per pound and rises as the demand and season advances.

The fowls used for this purpose are Light Brahmas and Plymouth Rocks. The incubators are started in August with Brahma eggs and the hatching continues until the following April. A few farmers keep their own breeding stock, but most of the growers purchase the eggs of farmers or villagers who keep fowls for this purpose and contract the eggs at fifty

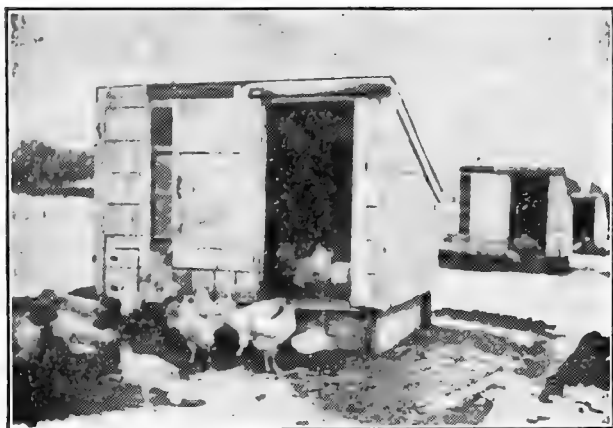

FIG. 96—COLONY HOUSE FOR SOUTH SHORE ROASTERS

cents per dozen for the season. Brahmas have long been the popular breed, but are being rapidly supplanted by Plymouth Rocks, especially the White variety. When pullets can be sold at thirty cents per pound live weight there is a great tendency to sell the larger birds. Added to this the fact that the smaller pullets mature the quickest and lay the most eggs, explains why the Brahmas have been allowed to dete-

riorate in size. Because Plymouth Rocks as now bred approach closely to the size attained by Brahmas in this locality, mature one to two months quicker and will lay more eggs, explains why they are becoming so popular. Plymouth Rocks also have the advantage over Wyandottes and Rhode Island Reds in being from one to two pounds heavier.

After the chicks are hatched they are placed in the brooders where they are kept until they feather out and are able to get along without artificial heat. Both the long, continuous brooder and individual brooders are used. After the chickens are feathered, or when they are from ten to twelve weeks old, they are placed in colony houses six by eight feet in size as shown in Figure 96. Fifty chickens are put in a house. No roosts are provided in the houses, which are cleaned out once or twice during the season. The fowls are given free range and as snow seldom lays on the ground longer than two or three days at a time, they are out doors practically every day.

They are fed exclusively on cracked corn and beef scrap which is kept in self feeders constantly before them. They are also provided with water, and green food is furnished in the form of cabbages, etc.

Most of the cockerels are caponized. Some of the growers perform the operation themselves, while others hire experts to do it. The loss is small, but about twenty-five per cent will prove to be "slips."

Two or three men make a business of buying, killing and dressing the fowls. With large wagons they visit the raisers once a week and together pick out what chickens are ready for market. It is a nice point to know just when a roaster is ripe. This is the point when they will cease to make profitable gains. With the pullets it is when they begin to lay. A Brahma pullet may lay for a week or two without materially

changing the quality of the flesh, but the flesh of Plymouth Rocks and other breeds changes very quickly at this time. The fowls are always bought alive by weight at the ruling market prices. They are bled in the mouth, picked dry, thrown at once into ice water and allowed to cool. They are then hung up to dry and the next morning packed in shipping cases and sent to market. Such prices can only be expected in localities which appreciate and are willing to pay for a high grade of poultry.

The breeding stock for laying is selected from January and February-hatched Brahma pullets and February and March-hatched Plymouth Rocks. This gives a hint of the value of early hatching to get winter layers.



CHAPTER IX

The Market End

The table is the end of all good fowls, and whether they be high-priced thoroughbreds or common mongrels their utility points for egg and meat production must ever be kept prominently to the fore. Fine feathers make fine birds only when they are useful for utility purposes. The great value of thoroughbred or "fancy" poultry, as it is commonly called, lies in the fact that they are of larger and more uniform size, better layers and will return a larger profit in eggs or growth for the food consumed than will mongrels. Many look with scorn upon thoroughbreds, saying and believing that they are less hardy than mongrels. There is some truth in this, for thoroughbreds have been more or less closely bred in order to fix the breed or variety characteristics. This close breeding, often done by those who do not clearly understand the laws of breeding, has resulted in imparting less vigor to their stock. It is the law of nature that all animals whose living comes easy soon lose the ability to "rustle" for their living. The Jersey cow is not so hardy as the range cow, but this is nothing against her. The man who would keep Jerseys under western range conditions would be a fool. So also the man who will take a flock of high bred fowls, turn them out in his barnyard to seek their living and let them roost in trees or sheds, will be surely disappointed, as he ought to be.

A flock of one variety will lay eggs of uniform size and color, will dress off about the same in size. Either alive or dressed they will command a better price than a flock of nondescripts. The only way to

get such a flock is to choose one variety and *stick to it*. Don't breed from a Plymouth Rock one year, the next year a Leghorn to increase egg production, and a Brahma to add size the year following, or you will have a flock of all colors, sizes and shapes. Stick to one kind whatever it may be and in the long run you will come out ahead.

Fresh eggs in the farmer's and housekeeper's mind and "fresh" eggs to the mind of the dealer are different commodities. To the latter all eggs which have not been in storage are "fresh." "New laid" is a term which is now applied to eggs laid within a week or two. The storage business has grown to such large proportions that thousands of cases of eggs are now put in cold storage during the spring months to be taken out when the price and conditions warrant. Many of these are sold as "fresh" or country eggs.

The farmer or poultry keeper who is in a position to do so will get the most money from his flock by selling the eggs direct to consumers. This can only be done advantageously where the eggs can be delivered each week. All dirty eggs must be washed clean, and if the eggs are crated and shipped it will pay to grade them as to size and color. Brown shell eggs are liked best in New England and command a premium; in New York spotless white eggs are worth most. In the west and south no difference is made for color of shell.

Eggs should be gathered every day and all from "new" nests and those about whose age there is any doubt kept separate and candled. One bad egg will often lose a good customer. Cases holding thirty dozen filled with pasteboard fillers which hold each egg separately are universally used for shipping and storage. A variety of styles of boxes and baskets are used for shipping eggs for hatching. Anything that is neat

and clean and that will keep the eggs from breaking will do for this purpose. A good way is to wrap each egg in excelsior, pack in baskets and mark in large letters EGGS FOR HATCHING. It will not hurt the eggs to wash them if they are washed clean, and then wiped clean and dry. The objection to poor washing of eggs is that it often simply serves to fill every pore of the shell with matter which stops evaporation. To illustrate, an egg smeared by the breaking of another egg might have half or less of the pores stopped up. If carelessly washed the broken egg might be only thinly and evenly distributed over the entire shell. In that case it is evident that it would have been better not to wash. But if the washing is well done it is an advantage. Take clean water that is warm enough to loosen the dirt. If that is very adhesive let the eggs soak awhile—but never use water hot enough to cook the egg next the shell. Don't attempt to rub the eggs hard. I prefer a bit of soft sponge for the washing, and a soft cloth to dry the eggs, though I only dry them when to be sold (market eggs). The eggs I set I wash clean and let dry in the air. There can be no bad effects if the eggs are clean. There may be a slight staining of the shell, which is of no consequence when the eggs are to be incubated, but does not look well on eggs offered for sale. If many soiled eggs are to be washed use small quantities of water, and change often. Using water that has become thick with the stuff washed off the eggs causes most of the trouble which makes some warn against washing eggs.

Storing eggs for winter use is frequently done by the thrifty housewife who gets them when they are plenty and cheap. There are many recipes for holding eggs but only two have been proved good by comparative tests. These are water glass and the lime and salt solution. Greasing the eggs, packing in oats or bran

or any of the other ways sometimes recommended, does not give as satisfactory results. The requisites for success in keeping eggs are strictly fresh or new laid eggs kept in a cool dark place. Place the eggs in a stone jar or wooden tub and cover them with a solution of one part water glass (silicate of soda) in ten parts pure soft water. The cellar is a good place to set the jar. Water glass can be obtained of most druggists, and is a heavy, almost colorless liquid costing from ten to thirty cents per pound. It sometimes comes in powder form when it must be dissolved by boiling in water for two to three hours, then when cool dilute with ten parts water. Eggs will keep perfectly in this solution for eight to twelve months. The other formula is to mix one pound fresh stone lime and one-half pound table salt with four quarts boiling water. After slaking and settling draw off the clean liquid and pour over the eggs so as to cover them. This is an old-fashioned method but is very effective. Eggs kept in water glass or lime water and salt may be taken out during fall and winter and sold for packed eggs at about five cents per dozen less than the price of fresh eggs. Many families can safely pack a few dozen to use for cooking purposes in winter, but whether it is a safe business venture to put down several hundred dozen is another question. The safest method, and the only one available on a large scale, is to use cold storage, where the eggs can be held at twenty-eight to thirty degrees Fahrenheit. A temperature below twenty-seven degrees is required to freeze the egg and split the shell

SHIPPING LIVE POULTRY

Crates should be built with solid board bottoms, lattice sides, ends and tops, the slats being not over

one and one-half inches wide. For turkeys and geese, the inside measurement should be forty-six inches long, twenty-eight inches wide and twenty-two inches high. For all smaller fowl they should be inside forty-six inches long, twenty-six inches wide and sixteen inches high. No crate, at any time, should have in it over 100 pounds poultry, large or small. Water and feed them regularly and keep them out of rain and sun, and you will thereby not only treat them as you would like to be treated, but bring them to the purchaser in the best possible condition.

Old hens usually bring the best prices in the early fall and winter, but old roosters do not pay for the labor and cost of sending them to market. In selling off the stock in the fall send only the small stock and the fat hens that do not lay. Old hens sell as well as pullets. The main point is to have them fat, as that covers all other defects, provided they are healthy. Never send a sick fowl to market; it may die on the way and serve to depress prices by casting suspicion on all the others. When the weather is settled cold, the fowls may be shipped alive or dressed. Hens that are only one or two years old are termed old hens when they are really young and in their prime.

To dispose of surplus stock, when prices are very low, all join hands and have a killing day. Put a large pot on the stove, kill and dress the birds, put them into the pot and boil till tender. Have glass jars or tin cans ready and fill with chicken pouring the juice on top, cover with fat or melted butter and seal while hot. It will keep through the year and can then be prepared in many different ways for the table. It makes a convenient dish for unexpected company.

DRESSING AND SHIPPING POULTRY

After the first of November it will pay better to send poultry dressed rather than alive. Do not feed for twenty-four hours before killing. Bleed the fowl through the mouth. A clean cut with a sharp-pointed knife across the mouth just below and under the eyes will do the business. A half-minute will be all-sufficient to bleed, and when the bird begins to struggle, give it a smart blow on the back of the head and begin the picking at once.

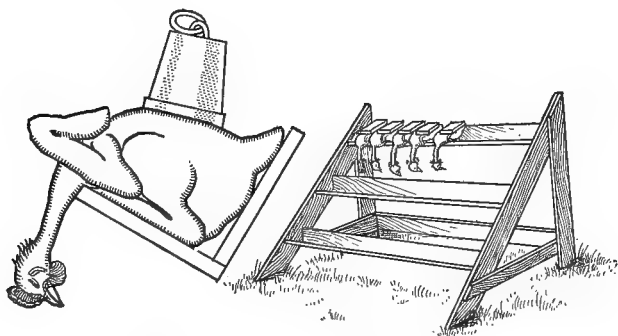

FIG. 97—SHAPING RACK AND FOWL

Fowls for Boston market should always be dry picked, as scalded poultry will surely be cut from ten to twelve per cent. For the New York market it is immaterial, as, other things being the same, the price will not vary much between dry picked and the scalded. Chicago and most western markets prefer dry picked.

At the molting season, young stock will look and pay about as well if scalded as if dry picked. This should be quickly done in water nearly up to the boiling point, then pick perfectly clean, dip immediately

into very hot water and then lay in cold water for fifteen minutes. If a little salt is added to the water it will draw the blood out of the skin. After the chicken has been plucked, it should be placed on a shaping board, as shown in Figure 97. The weight placed on the top of the chicken is used to give it a compact appearance. This weight may be of iron or a brick will answer. If chickens are hung by the legs after being plucked it spoils their appearance, making them look thin and leggy. Whether scalded or dry picked the fowls should be carefully packed, breast down, and (if shipped any distance) with layers of clean straw between. Most of the Boston dealers prefer poultry drawn, but that sent to New York and to Chicago and western cities in general is not drawn. Undrawn poultry keeps best.

Many good chickens are spoiled by being packed before they are thoroughly cooled. Care should be taken that all the animal heat is out of the body before the fowls are packed. In packing for dry shipment, the case should be clean and strong enough to carry the contents well. Barrels or cases holding about 200 pounds are the most satisfactory. For packing material clean, dry hand-threshed wheat or rye straw is best. Place a layer in the bottom, then alternate layers of poultry and straw. Place the backs of the fowls up and the legs out straight, filling so that the top layer will fit down closely upon the contents of the package. Pains must be taken to have every fowl perfectly dry before putting in the packing case. All blood remaining about the mouth must be removed with a damp cloth.

If the fowls are to be shipped in ice, use only poultry or sugar barrels. These latter must be thoroughly washed so that they will not contain any traces of sugar. Place a layer of cracked ice in the bottom

of the barrel, then alternate layers of poultry and ice until the package is nearly full. Over the top layer of poultry place a layer of ice, then a piece of burlap, and finally a layer of cracked ice on which the head rests. Pack the poultry breasts down and back up, with the legs out straight towards the center of the barrel, making a ring of fowls side by side around the outside. The middle of the barrel may be filled with fowls so that the top may be level.

The methods of dressing capons vary somewhat for different markets, and it is wise for the grower to learn from the dealer or commission merchant in the market to which he purposes shipping as to any special demands. They are usually, and always for best markets, dry picked. It is customary with most growers to leave on the feathers of the neck, tail and wings; some leave on more than others, but the carcass must show up its plump proportions and rich yellow color. For they must be well fattened.

For the English market, fowls of about five pounds weight, dressed, are the best size. They want a bird with a white flesh and skin instead of a yellow, and they object to black legs or feathers on the legs. While the Plymouth Rock and Wyandotte have yellow flesh and legs, the color can be influenced considerably by the feed. Oats and skimmilk have a tendency to make them light colored.

Turkeys are killed, dressed and shipped in the same manner as fowls. Never allow them to freeze; this greatly injures their market value. Dry picked turkeys usually sell best in most markets. Dry picking is not the difficult task many consider it if rightly managed. It is easily and quickly done if picked at once while the body is still warm. The skin is not so apt to be broken or the flesh bruised as when picking those that have been scalded. In packing, be careful

to assort the fowls properly and place all of the same grade together, putting the toms or any not looking so nice in boxes by themselves. Place together the hen turkeys, which always have rounder, plumper bodies than the toms, and to sell well the packages should always be of uniform quality. When different qualities are packed together they are invariably rated with the inferior fowls. Many dollars are lost every year by not giving attention to this simple but important particular. It is best to have packages to weigh from 100 to 200 pounds, as these sizes are most conveniently handled. On the outside of boxes should be plainly written the contents, gross weight and name of the consignee as well as the consignor. Care in this respect will insure prompt delivery and returns. Shippers should manage to get in all of their largest turkeys for Thanksgiving; they are then wanted as large as can be produced. Medium sized hen turkeys sell better for the Christmas and New Year's markets. After the holidays are over, eight and ten-pound birds sell best. When shipping poultry that is first-class in every respect, it is a good idea to neatly tag each fowl with the name and address of the sender. In this way a reputation may be gained that will enable him to always dispose of his stock at fancy prices.

Ducks and geese are commonly scalded. Dip them in water nearly to the boiling point and lift up and down a few times. Then take out and wrap in a flannel blanket to allow the feathers to steam a few minutes. They can then be picked very quickly. A blunt knife is of great service in removing the pin-feathers, as with it one can seize the shortest and pull them. After picking throw the carcasses in cold water to cool, then dry and pack the same as poultry.

All game birds should be shipped in their natural state—undrawn—except in very hot weather, when it

is necessary to get the animal heat out in order to keep from spoiling. With proper care, stock can be forwarded in all seasons so as to arrive in good condition. Trapped birds are more desirable than those that have been shot. Game birds can be packed dry unfrozen, or frozen solid before packing, or packed with ice. Of late years venison saddles have sold higher as a rule when skinned than when sent with skin on. Whole deer, however, should never be skinned, but the entrails should be removed, including liver and lights, and the inside of carcass thoroughly washed with cold water. Hares and rabbits should never be drawn, and should be kept as free from blood as possible.



CHAPTER X

Waterfowl

Duck keeping as a business has assumed very large proportions within the past twenty years, some breeders raising as many as 20,000 ducks a year. They are marketed when ten to twelve weeks old, at which time they are very tender and much prized by epicures. On the farm where only a small flock is kept and raised the care of them is very simple. Damp, marshy land, not suitable for fowls, is well adapted to ducks and geese, particularly the latter.

COMMERCIAL DUCK BREEDING

Let us begin with the location of the plant, and that may be almost anything that you can get. While water is one of the almost necessary points, there are many leading breeders who do not have water running through their yards and do not consider it necessary. In establishing a plant, if you could select just what you wanted, I should advise choosing a place with a good, sizable pond or running stream of water, for in that way you would gain in the fertility of the eggs.

The Pekin duck we advocate altogether because of the deep keel. In the improved type the breast line should be nearly parallel with the back and the breast should be nearly the same length as the back. The old line bird is something the shape of a Bartlett pear. Of course it is possible with the old type of bird to get a heavy weight, but the weight does not come in the right place; it is mostly back of the legs, which is where most of the waste comes, and there is no frame

to build on. In selecting birds for breeding I would choose preferably birds that only weigh from six to seven pounds apiece alive, and mate them carefully with medium-sized drakes. We used to mate five ducks to one drake, but now I should like to mate up in single pens one drake with five, six or seven females.

We feed them lightly until November, when we generally mate them. We try not to force them this year, thinking that it destroys the vitality of the birds and the fertility of the eggs, and so we feed what we call "harmless food"—largely clover, perhaps one part clover and three parts bran and two parts corn meal, and no beef scraps. It is not the question how many eggs they lay, but what we get out of them. As a rule we get less than 100 eggs rather than over. I think that ninety is nearer what we really get. Now if we get only ninety, it is a great point to get ninety good eggs, rather than so many poor ones. By forcing we destroy the fertility, yet the eggs are quite profitable if it does not take too much out of the breeding stock to get them. I would prefer not to have them begin to lay before some time in February. The first few eggs laid will not be very valuable, they are almost always infertile; perhaps the first two or three eggs from each breeder, and the first machinefuls do not average more than forty per cent fertile. If you hatch twenty-five per cent of them it will be doing well. If you try the eggs you will see that thirty-five or forty per cent comes nearer the average. After starting to hatch with hens and machines you will probably find that you average more with hens than machines, but if you average in either case fifty per cent you will be doing well, and even forty per cent will be doing fairly well. From the forty per cent you will naturally expect to raise eighty-five to ninety per cent of the ducklings, and that is all that you can expect, and

seventy-five per cent will often cover those raised by experts.

We feed the old breeding ducks, before we begin to force them for eggs, about a third clover and sometimes plain hay and the rest bran and meal. The idea is to fill them up with something bulky and when they begin to lay we begin with five per cent of beef scrap and work up gradually, until in a week or so we will be giving them ten or twelve per cent. We keep water before them all the time. At a season of the year when it is possible we let them have it for swimming.— [George H. Pollard, Bristol County, Mass.

In starting in the duck business the most important question that arises is personal adaptability. One must enjoy caring for the poultry, besides doing conscientious work. The money that is in the duck business attracts a great many people. We always recommend starting in a small way, and if successful, go right ahead. The man who starts a \$10,000 plant with a rush is usually in at the death. If one already owns a farm, \$1000 capital would give one a good start in the business; such an amount would be sufficient to cover all expenses—two incubators, a flock of about thirty ducks, a house for the breeders, a brooding house and heater, feed boards and water fountains, wire fencing, etc. Such a plant would keep one man busy and the future growth of his plant could be built on the profits.

In buying breeding birds our experience tells us that it is folly to breed from small, undersized birds, and our advice to beginners is to get only the best; begin right. One pound difference in the weight of each market bird makes quite a difference in the receipts at the end of the season.

The most suitable land for a duck farm is either sand or gravel, with a slope sufficient to give good

drainage. We have never kept our ducks in a marsh, or let them swim in water; but we think it would be an advantage to give the breeding ducks a marshy range if convenient. Pekin ducks never wander far from their night quarters, even when they have unlimited range. The ducks lay their eggs in the night, or very early in the morning. As a regular thing we gather them about 8 o'clock, but if the weather is extremely cold, we get them just as soon as it is light, to prevent any from freezing. We supply no nests for the ducks to lay in. They prefer to make their own nests in the different corners of the pen. The pens should be large enough to accommodate the number of birds put into them without crowding. We allow eight square feet to each bird, say forty ducks to a pen twenty-four by fifteen feet.

In the early part of the season when the prices are very high, we begin to market our ducklings when they are nine weeks old. Later on, as the price drops, we let them go till they are ten or eleven weeks old. In the height of the season, we market on an average nine hundred ducks per week. It takes four men to dress that number. We usually begin to market the birds the last week in March, and continue until Thanksgiving time.

On a large plant one must expect a greater percentage of mortality among the young stock than where only a few hundred are raised. Our loss is estimated at fifteen per cent right through the season. The average annual egg production is from 130 to 140. The duck, when she begins laying her eggs in the latter part of the winter, is somewhat different from a hen. When she begins she will lay one egg and then rest two or three days, then lay a few more, and then start in for good, and never stop until she has laid her last egg in the fall.—[John Weber, Norfolk County, Mass.

Growing ducks require a plentiful supply of fresh water. About the only neglect that will kill young ducks is failure to provide them with plenty of fresh water, in a vessel deep enough for them to get their heads beneath the surface of the water. One of the new diseases to which ducklings are subject is sore eyes. This may be avoided if they have water constantly before them, deep enough to get their heads in and keep the eyes washed. A cheap and convenient water tank for ducks may be made of the bottom third of an old barrel. Saw the barrel off just above the second pair of hoops, making sure that the bottom is whole. Bore an inch hole in the bottom, and fit with a soft pine plug, and you have a cheap and convenient tank that only requires to be properly set in the ground to be ready for use.

The best way to set such a tank is to dig a hole deep enough to make a blind drain of stones; on these stones arrange four bricks to support the tank, and fill in about it with earth firmly packed down. Figure 98 shows

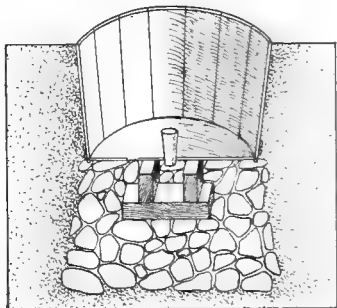

FIG. 98—WATER TANK FOR DUCKS

a section of tank so made, and the manner of making drain and the arrangement of the bricks.

The tank is emptied daily by pulling out the plug. It takes about two water buckets full to fill the tank even full. When the drain becomes foul and gives off a bad odor, it can be thoroughly cleansed by pouring into it a bucket of water in which has been dissolved two tablespoonfuls of sulpho-naphthol. After using the

disinfectant, rinse the tank before refilling. Properly constructed the tank will last a long time.

The breeding ducks keep clean and do better if they can have water to swim in. The eggs are more fertile, for they copulate in the water. Where no pond or stream is at hand a small pool can easily be made for them. Dig a square hole eight inches deep and as large as desired. Put eight-inch boards around the sides. Now tamp down the bottom hard and level, and coat the surface with an inch of cement, bringing the coating up to the top of the boards at the sides, of the same thickness as the bottom. Drive shingle nails thickly into the boards to give the cement something to cling to. In the same way a pool for a "water garden" can be made for the growing of aquatic plants. Keep this filled and clean out frequently, for it is quickly fouled.

CARE OF YOUNG DUCKS

The ducklings are left for twenty-four to thirty-six hours in the incubator to dry off and get upon their feet, during which time they receive no food or water. Then they go to the brooder houses, which in large establishments are heated with hot water pipes. The pens are three or four feet wide by ten feet long, with a passageway along the back, and each pen holds from seventy-five to 150 ducklings. Here the ducklings receive their first meal, which is the same as the regular rations which they are to receive afterward, viz, a mash of two-thirds bran and one-third corn meal, mixed with cold water or skimmilk. Ducks intended for market are not fed green stuff and an exclusive grain diet seems to give a firmer flesh. After the first four days the feed consists of corn meal and bran in equal parts and about one pound in

twenty of beef scraps. The amount of beef scraps is increased until at three weeks old they get about one-eighth scraps. This proportion is kept up until they are ready for market. This ration gives a white-skinned duck free from flabbiness. The houses and runs on a California duck ranch are shown in Figure 99.

HANDLING THE BREEDING STOCK

The birds should be housed in warm quarters before the first of December, placing from thirty to

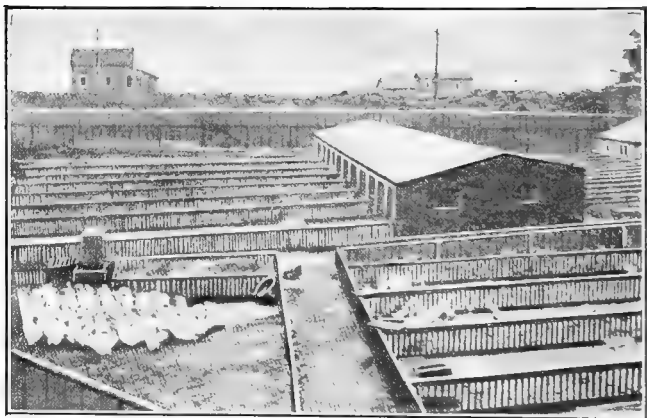

FIG. 99—A FEW PEKINS ON A CALIFORNIA DUCK RANCH

thirty-five together in a pen. Twelve by twenty feet will be large enough, if kept clean, with a yard of corresponding width outside 100 feet long. This will give the birds room enough to exercise in. These yards should have natural drainage, otherwise they will soon become filthy in the extreme. There is no

harm in letting the birds out on pleasant days during the winter; snow is no objection, provided the weather is not too cold. They enjoy it hugely, especially during a thaw. The pens inside should be kept dry and free from odors. This is absolutely essential, for though ducks are not as subject to disease as hens, they will not thrive in filth. Too often the health of the young bird is injured by the improper feeding of the mother bird during the laying season. This food should consist of the proper ingredients, in quantity just what the bird will eat clean, and no more. Grit is absolutely necessary, and is one of the essentials. We not only keep it, together with cracked oyster shells, in boxes constantly by them, but mix it in their food. They must have something during their confinement during inclement weather to enable them to assimilate their food. One ingredient which we consider of the greatest importance is green food, which should compose nearly one-fourth of the whole. We use green rye which is cut three-eighths of an inch long, and mixed with the food. When there is prospect of snow we cut large quantities of this in a frozen state and pile it up on the north side of a building. It will not heat in this condition. Should this be used up, and the ground still be covered with snow, we have several tons of fine clover rowen stored for the purpose, which we consider next in value to the rye, so that we are never out of that material for feeding. We also grow about 1000 bushels of turnips, which we steam until they are soft, and mix them in the food. This the birds relish highly. My formula for feeding breeding and laying birds, when fertile eggs are desired, is as follows: For breeding birds (old and young, during the fall), feed three parts of wheat bran, one part of Quaker oat feed, one part corn meal, five per cent of beef scrap, five per cent of

grit, and all the green food they will eat, in the shape of corn fodder cut fine, clover or oat fodder. Feed this mixture twice a day, all they will eat. For laying birds, equal parts of wheat bran and corn meal, twenty per cent of Quaker oat feed, ten per cent of boiled potatoes or turnips fifteen per cent of clover rowen, green rye, or refuse cabbage, chopped fine, five per cent of grit. Feed twice a day all they will eat, with a lunch of corn and oats at noon. Keep grit and ground oyster shells constantly by them. We never cook the food for our ducks, after they are a week old, but mix it up with cold water.—[James Rankin, Bristol County, Mass.

WINTER QUARTERS FOR DUCKS AND GEESE

Ducks and geese need dry winter quarters. This is absolutely essential. Scarcity of bedding or a low, damp floor will soon put a whole flock out of business. Rheumatism or leg weakness, accompanied by a general falling off in flesh, is the inevitable result of damp quarters. As breeding birds in off condition during the winter cannot possibly be early spring producers, the far-reaching results of a little neglect practiced now, probably in ignorance, are often visible, felt in the receipts at the end of a season.

Any shed that bids defiance to winds and rain and that has a floor at least six inches higher than the surrounding ground, is a fit place for quartering waterfowl during the inclement season. Feed the ducks near this shed at night and as soon as they have done justice to their meal drive them slowly without undue excitement into their quarters. The best door for this purpose is even with the ground, two feet high by three or four feet wide, fastened on hinges at the top and hooked, when open, with an iron hook on its

upper edge. A button on its lower side will secure the door during the night. As this shed is aimed mainly to be night quarters, one four or six-pane sash is ample to admit sufficient light for the few days or hours of really bad weather when the birds must remain indoors.

A shed eight by ten feet of floor space, six feet high in front and four feet in rear, is large enough to hold comfortably from twelve to twenty ducks or from six to ten geese. Let the temperature be your guide as to the sufficiency of air inside. If you find upon opening the house in the morning, that all walls are damp and the air close, ventilate more thereafter.

The mixing of ducks and geese in one shed cannot be recommended, as owing to the quarrelsome habits of geese, the ducks would not get the peace and rest they must have at night in order to produce best results. Teach your geese from the beginning that they must not feed or mix with the ducks and soon they will not trouble you any more, when attending to the latter. Geese are not in need of a closed shed, such as mentioned, but should such a one be allowed them, leave the door open, as they always need plenty of fresh air. In order to make their home attractive to them, provide empty barrels in all corners laid sideways and securely fastened down; half fill them with straw and add a few china nest eggs. This will save many a step in spring hunting their eggs. Make them familiar with their surroundings and future nests and eggs stolen away will become rarities. Ducks lay at night or early in the morning and should be confined during the laying season until 8 or 9 o'clock in order that all eggs may be saved.

KILLING AND PICKING DUCKS

The Muscovy and Pekin ducks are the leading market birds. The Muscovy has to be from two to four weeks older than the Pekin before it can be dressed, and is sometimes four months old when killed. After a duck gets its age it is rather deceptive as to weight, as it is then fat and solid. Pure-bred Pekins of proper grade should weigh about eleven pounds per pair at eleven weeks old. The smaller birds serve a purpose in hotels and restaurants. A quarter of a bird is served to each customer, and in that way the smaller birds answer the purpose just as well as the larger, nicer-looking ones. It does not pay to raise these small birds as well as it does to raise the large ones, for it costs just as much to raise, dress and market them, and they will not reach the largest birds by one cent per pound, though there is a season when there is a call for the small birds. One great drawback with ducks is that the shrinkage is so great as compared with other poultry that it seems a high-priced meat.

In different parts of the country, modes of dressing differ. In the west they are headed and drawn and sometimes scalded, but generally dry picked. A dry-picked bird holds its color better than one scalded. Scalded birds appear puffy and are likely to turn dark by exposure to the air. The market price of scalded birds would be from two to four cents per pound less than for dry-picked birds. In New England scalded birds could not be sold unless there was a shortage in the market.

Green ducks are shipped with heads on and undrawn. They are picked down one-half of the neck and to the first wing joint. The feathers from the white ducks are quite valuable, being worth thirty-

seven to thirty-nine cents per pound, and colored ones seventeen to twenty-three cents. The feathers would make quite a difference in the season's profit were you using colored or white birds. You cannot get the colored birds without the colored pinfeathers, and of all distressing sights for the poultryman, a bird shot with pinfeathers is the worst. At the stage when they should be dressed for the greatest profit, if the pinfeathers are thick all over the bird, it is impossible to dress them so that they will not have a badly tattooed appearance. Pekin ducks as compared with Muscovys would dress at ten weeks, while the Muscovys would dress at fourteen. At twelve weeks the Pekin would require little pinfeathering.

After killing, which is done by cutting in the roof of the mouth, and picking, the birds should, in warm weather, be thrown into cold water immediately after picking and allowed to soak for an hour or two. Then the blood is washed out of the head and bill and feathers and they are thrown into a tank of ice water. By putting them in the warmer water first, it swells the flesh and closes the pores, then by putting them into the ice water all the remaining animal heat is expelled and they are left white, hard and firm. To give them the best shape they should be tied before going into the water. If the wings are folded close to the sides of the body and tied down, and the birds are put into the water, it gives them a better shape and appearance for market. In shipping, they can be kept from twenty-four to forty-eight hours in ice water but if kept longer than that they should be packed in ice. In shipping them to market, pack them in the same way if it is a two or three hours' journey. Put in a barrel a layer of ice, then a layer of ducks, and on top of all put a layer of ice. The ice water trickling down among the ducks keeps them in good shape.

BREEDS OF DUCKS

There are several breeds of ducks but only three kinds are popular with poultry keepers. These are

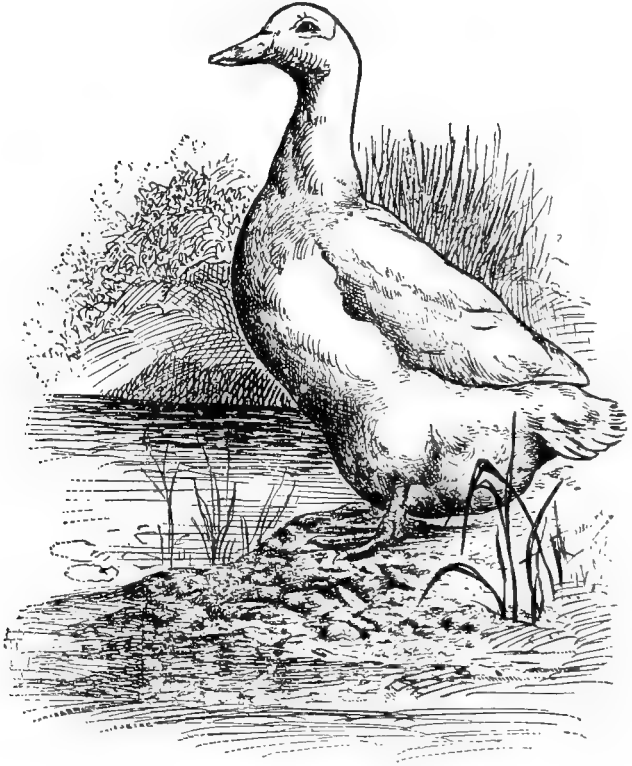

FIG. 100—PEKIN DUCK

Pekin, Muscovy and Indian Runner. There are several other breeds which are kept mainly for fancy

purposes, yet for the farm have some points of superiority to those mentioned.

Pekins are most popular because of their early maturity, large size and prolific egg yield. They are kept almost exclusively by the large duck raisers who grow thousands annually. Figures 99 and 100 show a typical duck ranch and individual bird. Standard weights are, adult drake, eight pounds; duck and young drake, seven pounds; young duck, six pounds.



FIG. 101—AN OBJECT LESSON IN DUCK KEEPING

The Indian Runner is a breed rapidly coming into popularity. It is aptly termed the Leghorn of the duck family, for it is a wonderful layer. Figure 101 gives a good illustration of the capacity of this breed. A good drake is shown in Figure 102. They are much smaller than *Pekins*, standard weights being, drake, four and one-half pounds; duck, four pounds. They are quite beautiful to look upon, the plumage being light fawn or gray and white.

The Muscovy is the largest of all ducks, the standard weights being, adult drake, ten pounds; duck and young drake, eight pounds; young duck, seven pounds. As commonly bred the drakes are much larger than the ducks. They have a peculiar appear-



FIG. 102—INDIAN RUNNER DRAKE

ance owing to the long, crest-like feathers on the head, the sides of which and the face are covered with caruncles. There are two varieties, the White and Colored, the plumage of the latter being a mixture of glossy black and white.

Other Varieties—The Rouen, which is larger than the Pekin, is very beautiful owing to the rich shades and markings of the plumage. The flesh is considered superior to that of the Pekins. The Aylesbury, a large, white breed, very popular in England, is little seen in America. Cayuga ducks are black and of the same size as Pekins. There are two varieties of Call ducks, the Gray and the White. These are smaller and kept mainly for ornamental purposes. The Black East India ducks are another fancier's breed, likewise the Crested White, which are large. The Blue Swedish is a new breed to this country, a native of northern Europe, hardy, exceptionally good layers, and the meat is of fine quality. They have delicate plumage. The White Muscovy is probably the quietest of all breeds, the Pekin the noisiest.

KEEPING GEESE FOR PROFIT

The two great objections to geese are the noise they make and the fact that they spoil a pasture for other stock. Cattle or sheep do not like to graze where geese have been. Yet there should be a place for them on many more farms than they now occupy. Under the right conditions geese give better returns than any other poultry. By nature geese are more like a sheep or cow in habit of feeding than like poultry. They are essentially grazing animals and too much grain will spoil them. Pure air is of even more importance to geese than to cattle. They will not thrive if shut up in buildings. If you have not a good pasture, do not try to keep geese, or at least to raise many goslings. They can, however, be kept in yards, if fed an abundance of fodder corn, green rape, clover or other green feed, but this adds greatly to the expense.

While green pasture is important for maintaining old geese, it is indispensable food for young goslings. They must have fresh, tender grass in abundance at all times during the day, from the first day they eat to the time they are well feathered and have grown their wings. After that, those intended for market may be penned and fed green stuff and grain, but those intended for breeding should continue to have pasture and free range. If a large flock is raised, quite a pasture is needed to sustain them. It takes geese almost as long to reach full development as it does cattle or sheep, but they remain profitable for many years. Yearling geese are very poor breeders, two-year-olds are better, and they only reach their best at three years of age.

If one wishes to make a start in keeping geese, the best plan is to buy breeding stock early in the fall. They must not only become accustomed to their new quarters, but to each other, for geese do not mate readily and if put together after January 1 will often fail to breed that year. Old, well-mated geese of the highest quality are the cheapest and most profitable to buy. The best way to get the finest geese is to buy young ones, and to order them before they are hatched. Have the large early hatched specimens selected for you and delivered early in the fall. They must be kept at least one year without profit and two years before they will do their best, but in this way one knows the age of his stock, and in the end will get better results.

MONEY IN GOOSE FARMING

The breeding and growing of geese on a large scale for market and egg purposes could undoubtedly be made profitable if handled in a practical manner.

It would be necessary to have farm range with plenty of pasture and sufficient water for the birds. It would not be necessary to have a small lake, as spring water or pond water is sufficient. Geese, as a rule, do not require much grain, as the young feed almost entirely on pasture.

Our best goslings are grown to about five months of age with less than one peck of grain each. After that age, if good weights are desired, furnish them with grain food. The mature or breeding stock should be fed very lightly during the spring and summer months, as overfatted specimens are usually entirely worthless as breeders. The leading varieties for both market and egg purposes are the Toulouse, Embden, African, White and Brown Chinese. As a general purpose goose, in my opinion, the Toulouse leads all other varieties; the Embdens are about the same size as the Toulouse, but much poorer layers. The Chinese are a smaller goose, but the best layers of any variety. We have produced large numbers of young Toulouse at six months of age, weighing on an average of thirty-two to thirty-five pounds per pair, and Chinese averaging at six months of age, when in good flesh, twenty-four to twenty-eight pounds per pair. To obtain the best results in hatching it is necessary to use common hens to hatch and care for the young goslings. After the goslings are eight weeks old they may be safely turned in the field with the old geese. The young goslings after a week old should have free access to plenty of fresh, green grass, when no grain food will be required. Young goslings are very rapid growers and at eight weeks old will be over one-half grown, if properly cared for.

Considerable revenue may be obtained from the feathers by picking the mature specimens some four or five times during the spring and summer months,

and early goslings may be also picked during the latter part of August and again in October, provided they are not being fattened for market. It would not be necessary to secure the best farming land for geese raising; on the other hand, geese would thrive much better in low, marshy land which had not been under-drained. If properly handled I see no reason why this industry should not prove a financial success.—
[Charles McClave, Ohio.

CARE OF BREEDING GEESE

Two geese are usually sufficient for each gander, and they would do better to be in pairs during the breeding season. About February, when the geese begin to talk "goose talk," about building a nest, the ganders will begin to tell you how many there are of them, which fact you might not have known before, for it is very difficult to distinguish the sex in geese. This distinction is very easily made by the ganders, who begin to decide supremacy. One gander will drive all others out of the pen, if they can get out, or injure them quite severely if they cannot keep out of his way.

Now is a good time to divide the flock. Leave one or two geese with the boss gander, and remove the others to another pen, and in the same way continue to single out pairs or trios until you have them all separate. This is only for the starting year. After they are separated put leg bands on them and record the same for future reference. It's a difficult matter to distinguish the young from the old in the fall, and the use of the leg band is the only way out of the difficulty. If holes are punched in the web of their feet they will grow up after a while, and the scar can hardly be found.

Each pair or trio should have a separate room or small house with yard attached in which they should be kept from the time they begin to mate till the goslings are able to follow their parents without getting tired out, when it will do to allow them free range. The old geese will generally come to the house at night for several weeks after the goslings are hatched, and frequent the building during storms as long as the goslings remain unfeathered, after which they will stop outside night and day.

For the reason that the three geese with their goslings are liable to need shelter even after nearly full grown, a pen eight by ten feet will be none too large for each trio. A yard twenty by forty feet will do during the breeding season, but if kept in a yard of this size they must be supplied with green stuff. That is the first thing the goslings want for feed, and the sooner they are let out on free range the better. As a rule each flock will keep separate during the entire summer. An occasional fight between ganders may take place. If a gander is very mean about fighting, better shut him up than the whole family, for it's the gander only that will fight.—[E. F. Barry.

Geese are quite partial to their mates. One old gander does not like to change his mate every year and there is often trouble from a change. They will not try to get out of a lot unless separated from mates, when they will try very hard and often succeed. A gander should never be kept longer than three years, as young ganders insure greater fertility in the eggs. On the contrary, a goose of three years or over will lay more eggs and more fertile ones than will a younger one. In goose raising there is the further advantage that a large number can run together without proportionally decreasing the profits, as with other fowls. For breeders, select large birds

and those having a record as being early and good layers. Of most varieties mate one gander to two or three geese, possibly to four. An Embden gander will care for eight or ten, and an African for from fifteen to twenty.

A low shed, open to the south, with straw on the floor, is all the shelter they usually need. They lay early in the morning, and should be penned until 9 a. m. in order that all the eggs may be gathered. Boxes and barrels on their sides make good nests for them, or lacking these, geese will make their own nests of the litter on the floor.

They commence to lay in March. The first clutch is ten to fifteen eggs, sometimes more. If not allowed to sit the goose will soon commence laying again and lay eight to ten eggs, and if not set will lay the third clutch of a few eggs, but the latter are not very fertile and the young are difficult to raise late. The early eggs are quite fertile. To get best hatches, the eggs should be gathered shortly after being laid, and well cared for, and in a reasonable time set in a warm place under a heavy hen. If well incubated the eggs hatch in twenty-eight days, but if not it will take thirty days; in the latter case one cannot expect a good hatch.

Breeding stock during winter should have free access at any time to a trough containing whole oats. Only on very severe days a little whole corn might be given to keep them warm over night. The tendency of all geese is to lay on fat, and our efforts in consequence must be to keep the breeding stock from getting fat, that strong fertilizers and good hatching eggs may be produced.

Distinguishing Sex—It is almost impossible to determine the sex of young stock. When they begin to mate one can easily tell them, but no one wants to

keep a flock until spring in order to pick out the geese and ganders. Lay the bird down on a board and with the fingers you can press out the private parts of the male. This is the only reliable test that can be applied and is, of course, conclusive.

THE GOOSE FATTENING BUSINESS

This is carried on quite largely by poultry keepers in Rhode Island and eastern Connecticut. E. A. Cornell of Rhode Island, who does the largest business, thus speaks of his methods: "I fatten from 12,000 to 15,000 geese each season. I send out teams to pick them up, and get them from the middle of April to the last of September. They are from eight to twelve weeks old when I begin to buy and will weigh from seven to nine pounds early in the season and later more. Through the summer I put about 100 in a pen forty to fifty feet square. Corn, meal and beef scraps is the feed used to fatten them. They are fed three times a day and heaviest at night in warm weather, as they will eat better in the cool of the day. They are fed from four to seven weeks. They are picked all but neck and wings and packed in barrels with ice, from fifteen to twenty-two in a barrel, according to size. The average price received is sixteen cents per pound. Later in the season I have the wild mongrels, which command a higher price. They are a cross between the common African or Embden and the wild goose and bring twenty-five cents per pound in market at wholesale."

FEEDING AND FATTENING YOUNG GEESE

When the young geese are hatched do not give them feed and water for the first thirty-six hours, or

if water, only a few drops from the finger tips. Their first feed should be bread crumbs, moistened with boiled sweet milk, and mashed up fine with a hard-boiled egg. After that for the first week feed boiled oatmeal, stale bread, potatoes, corn meal and bran moistened with milk, or scalded meal and shorts. Then add cracked corn and wheat. When three days old feed all the green food that they will eat, young sprouting rye, clover, purslane, onion tops, etc. Have plenty of water for drinking purposes near them, but in a vessel which they cannot get into, as they should be kept as dry as possible. They should be fed often, but not more than they will eat at one feeding. They should be kept clean, as they eat so greedily that they will devour droppings or anything, and filth is fatal to them. They need care for the first two or three weeks, after which they will look out for themselves.

A good pen in which they can be kept during this time is made of four boards one to two feet wide and ten to fifteen feet long, nailed together at the corners. This can be moved about from place to place over patches of young rye or tender grass, for a few young goslings will soon eat a place very clean of green food. They should always be housed at night, and have shade accessible during the day, as intense heat or dampness is fatal to them. When young they should not be allowed to run on the grass until the dew is off.

Kill by severing the artery in the neck with a small, sharp knife, or by giving a sharp blow on the head. Let them bleed hanging up for about five minutes. Then plunge into boiling water for about twelve seconds, wrap in a cloth and let steam for five minutes. Pick immediately, beginning at the head, and the down will come off very easily. Care should be exercised in plucking young goslings, as the skin is

often very tender and tears readily. Green goslings, as young goslings are called, should not be drawn for market. After picking place in ice cold water for an hour to plump them.

In eight weeks geese can be made to weigh eight pounds, and at the end of three months from fifteen to eighteen pounds, depending on the breed. Some large varieties will weigh twenty pounds the first season. When they are from eight to ten weeks old they can be sold to those who make a business of fattening them for market, or may be fattened at home, when they will bring much more. The fatter they are the better price they will bring, especially in Jewish quarters, as the Jews make extensive use of goose fat. The best market for them is in June or early July. If not sold then, keep them and fatten for Christmas. Pen them three or four weeks before selling them, first putting them into water to clean their feathers, and then into a pen with clean straw. Feed scalded meal in a crumbly state with about one-fifth part meat scraps, or give cracked corn with water, or a little corn and always plenty of grass. They should be given all the food they will eat. Keep them quiet, for if excited or disturbed they will not fatten. Young geese are ready for market when the tips of the wings reach the tail.—[E. I. Cole.

PICKING LIVE GEESE

Geese should not be picked till after the laying season is over, as picking retards laying, and if done in cool weather subjects them to sickness. Ganders are first picked about April, and every seven or eight weeks thereafter. In plucking a goose, draw a stocking over its head, or you are apt to be bitten. Do not pick the feathers that cover the wing butts, as

it will cause the wings to drop and means lots of trouble for the goose. Do not pick feathers growing in the back, or the down on any part of the body. If you tear the skin, which will not happen unless you take hold of too many feathers, put on a little pine tar.

VARIETIES OF GEESE

Of all the geese that the American Standard of Perfection speaks of, only three breeds come up to the

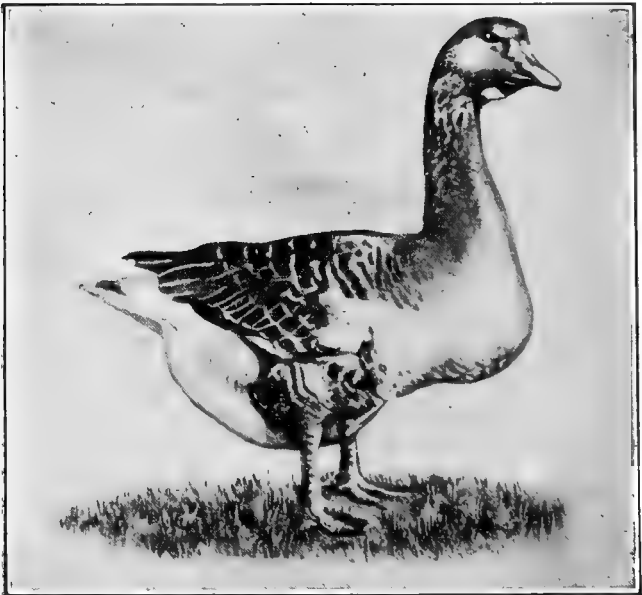

FIG. 103—TOULOUSE GANDER

requirements of the farmer, who sees more than anyone else to the actual market value of a bird, Toulouse,

Embdens and Africans are breeds that will do their best to bring an extra penny. They have the weight when matured that makes them desirable, the hardiness that causes their eggs to hatch well and their young to live, and the meat qualities that are in demand in the city markets.

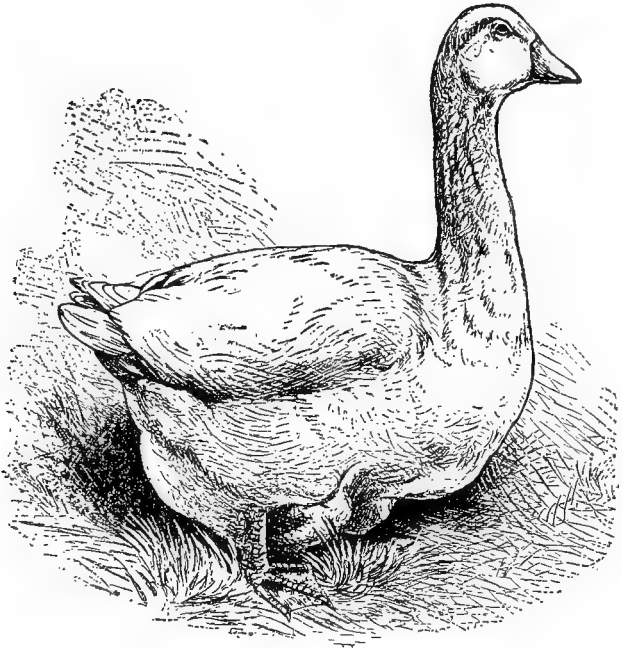

FIG. 104—AN EMBDEN GANDER

The Toulouse (Figure 103) are about as good as any. They are easily confined, as they are too heavy to fly and too large to get through a good fence, are strong and hardy, small feeders and good layers, commencing to lay early. They grow rapidly, are

gentle and quiet, weigh well, have good feathers and many of them. The principal objection to them is their color, which is gray.

The Embdens (Figure 104) are white, very hardy, weigh as much as the Toulouse, mature a trifle earlier and are better mothers.

The Chinese (Brown, Figure 105, and White) are the best of all layers and have a graceful, swan-



FIG. 105—FLOCK OF BROWN CHINESE GEESE

like look on account of their long necks, but are too small to be very profitable.

The Africans (Figure 106) grow the quickest, lay as many eggs as the Toulouse and have very nice flavored flesh. They are little known in the west, but are great favorites in the east, many preferring them to any other breed. African geese have a large head with a large knob and generally have a dewlap under the throat. These and the Chinese geese are different from the others in the head and are the only two

breeds that have a knob on the head. The bill of the African is rather large and stout at the base and their necks are long.

The wild or Canada geese are kept pure by a few breeders. They are easily domesticated. The

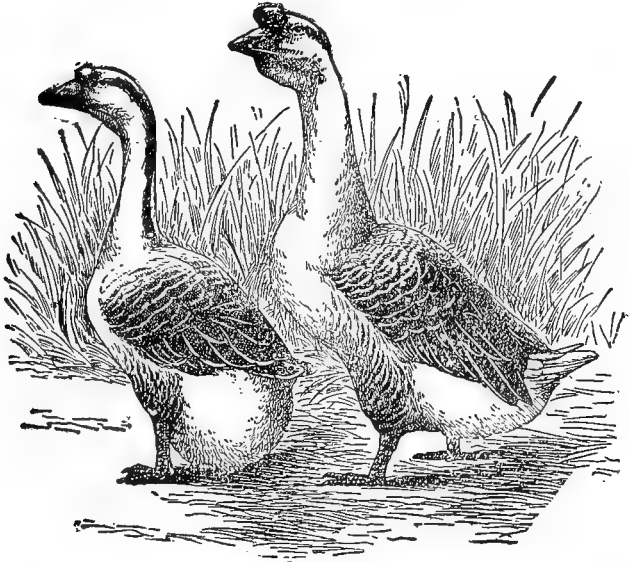

FIG. 106—PAIR GRAY AFRICAN GEESE

ganders are used largely for crossing to give the mongrel geese spoken of on Page 255 by Mr Cornell.

The Egyptian is a small colored breed kept by fanciers

CROSS BREEDING

Good Africans are as large as the best Embden or Toulouse geese, grow faster and larger than either

up to midsummer, the time goslings should be marketed. They also lay the largest eggs, and almost equal the Toulouse in number produced. They are good sitters, and therefore will not lay so steadily. The African ganders are like Leghorn males among fowls, the most active and attentive ganders of any of the large breeds. They may be given four times as many geese as the Toulouse ganders, and twice or three times as many as the Embden males, and rarely fail to insure highly fertile eggs. The only drawback of this most valuable and important breed is its dark bill and skin, and the fact that it is harder than the others to pick. When dressed, the white gosling leads it in price. A greater number of large goslings will usually be secured from pure Africans than from Embdens or Toulouse mated straight.

By mating an Embden gander with African geese, he will be more attentive than to either Embden or Toulouse geese, thus insuring a high per cent of fertile eggs, while a majority of the goslings raised will come white in plumage, and with yellow bills and legs. An African gander mated with Embden geese will insure more fertile eggs than if an Embden gander is used, and many of the goslings will be of the desired color for market. An Embden gander mated with Toulouse geese, while not so sure to give as high per cent of fertile eggs as an African, will usually insure excellent results, a large number of goslings, most of which will be light or white. For Christmas geese this is the most desirable cross, and gives the largest light colored goslings. The Toulouse gander in this sort of crossing has no place, and can be dispensed with.

Failing to secure African ganders of the right sort, Brown China or African-Brown China cross ganders may be used with about as good results. They are still more active than Africans, but are smaller,

not so hardy to stand cold winters, and their goslings partake of their nervous, excitable nature, and do not take on flesh, or fatten, as readily. However, where size of goslings is of little importance, or where a medium sized bird is desired, and especially where no preference is shown whether goslings dress white or dark, or whether the bills or legs are yellow or dark, the Brown Chinas, bred pure, will be the most profitable of all breeds; their sharp voice will be a drawback.—[Samuel Cushman in Farm Poultry.

BREEDING AND KEEPING SWANS

Swans are the most graceful of all breeds of waterfowl and where one wishes to beautify a pond they add more than any other breed to the scenery. Their keeping is easy, provided surroundings are congenial. Ponds that are freshly fed by springs and that have shallow banks, covered with vegetation, are their favorite abiding places. Make an artificial float, covered with a small, partly uncovered house, and anchor the same in the middle of the pond, and you have the best kind of breeding place for them. Cover it three inches deep with straw and then allow their instinct to do the rest.

Swans mate in pairs and the female, if more than two years old, is a good persistent sitter and watchful mother. She will take her young on the water within two days after hatching and will guard their every movement with maternal care. Feed them three times daily with chopped greens, such as lettuce, watercress and young rye, and when five days old add some finely broken bread. Throw this in the water, teach them a certain call, and they will soon learn to come to you for their feed. When four weeks old wheat, buckwheat

and cracked corn may be given them, placed in troughs along the water's edge.

A swan will lay from twenty-two to thirty eggs annually, and if, as said, all conditions are favorable, a large percentage of them should hatch and live. They are hardy and do not need any extra houses or care, even in the coldest winter. Treat them as you would treat old and hardened geese. Great precaution should be exercised in buying mated stock birds, as many irresponsible breeders sell two male swans for a pair. The goose test, if applied to swans, will reveal their sex.

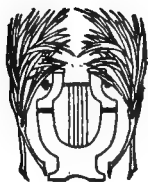

CHAPTER XI

Turkeys, Guineas, Peafowls

The turkey is a funny bird
For everybody knows
That when we "dress" we *undress* him;—
That is—take off his clothes.

And then he must be dressed again
And all sewed up, or tied,—
How odd! For now the "dressing" is
All put in his inside!

A. G. BUTLER.

SELECTION AND CARE OF BREEDING TURKEYS

No poulterer can hope to become a successful turkey raiser who resides in the midst of a thickly settled neighborhood, and must therefore keep his stock in close quarters. A prime requisite at the start is to secure the best stock, even at fancy prices. For vigor, hardiness, numbers and immunity from disease, the stock raised from a cross between the American wild and the domestic, a cross producing the Bronze turkey, is most satisfactory. Too great an admixture of wild blood, while it gives increased hardiness, decreases size, as does also breeding from young gobblers.

One gobbler may run with a flock of from twelve to twenty hens. The best results in breeding are from old gobblers not related to the hens. Go to an experienced turkey grower two or three weeks before Thanksgiving and select a good tom, not necessarily

the largest in the flock, but rather the brightest. Pick the one that flaunts his plumage most proudly and is quickest to resent a strange noise with the loudest gobble, and be sure he is a greedy eater. The one that meets you at the barn door when you come out with the corn is the one you want.

Now go to some other breeder for your hens. Here again you must exercise judgment in selection, looking carefully that you choose none with crooked backs or breast bones. Don't take fat birds, but get large bodied, bright plumaged, gentle acting ones. Mind that you see them eat and make careful inquiry as to whether they are related to your tom. No stock will show the evil effects of inbreeding so quickly as the turkey.

Turkeys are much healthier and hardier when kept out of doors. Charles McClave of Ohio, one of the largest turkey breeders in America, says: "My turkeys are wintered in the timber, which is nature's place, and I find after many years' experience in this line that they are much healthier than when kept around the buildings in the ordinary way; in fact, with the number that I carry over the winter for breeders, it would be impossible to keep them around the farm buildings. For more than ten years I have kept my large flocks of turkeys in this manner. The track of timber in which I winter them covers some forty acres and is inclosed by a woven wire fence. Near the center of the tract is a roosting pen covering one acre, also inclosed by high wire fence. The turkeys all roost in this pen at night for protection, and during the day roam about the timber at will."

Where thieves are apt to help themselves to turkeys it is not safe to let them roost in the trees all winter. An open shed, the front of which is closed with wire netting or fencing, as shown in Figure 107,

may be used. This can be locked securely, while at the same time providing plenty of fresh air. But whenever possible let the turkeys choose their roost if they can find easy access to apple trees on rising ground, rather than a valley. They should be fed away from the house, and not encouraged to intimate association with the hens and other fowls. A flock properly tamed will seldom venture into the woods for laying, but where nests are provided, will usually willingly seek them. An inclosure with wire netting, and

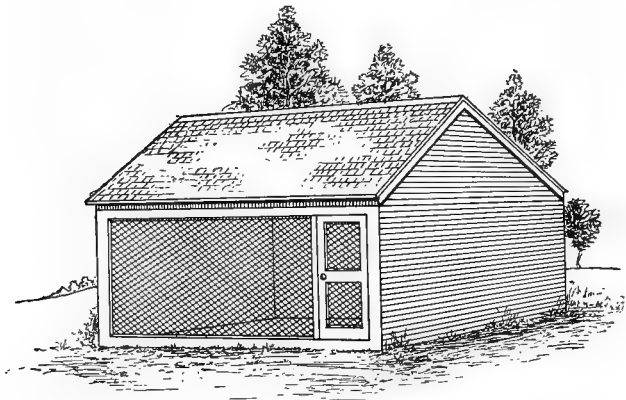

FIG. 107—INCLOSED ROOSTING SHED FOR TURKEYS

nests provided therein, may be used, and the birds confined within for a half day during the season, or with a little more watchfulness, nests can be built against the barn or other buildings.

Keeping Turkeys in Confinement—An experiment of confining turkeys in yards was tried recently by the South Carolina experiment station. A trio of Bronze and a trio of White Holland turkeys were confined in runs eighty by 100 feet, in which were placed

two covered nests thirty-six inches square. A few brush were thrown in front of each to make them private. The two Bronze hens laid forty-two eggs, of which thirty-seven were fertile and twenty-seven hatched. The two White Hollands laid thirty-six eggs, of which twenty-seven were fertile and sixteen hatched. The eggs that did not hatch were those laid during the first two weeks. Although the experiment was very limited, it tends to show that a considerable saving can be made by confining turkeys during the laying season, which would avoid loss by the hens stealing their nests and other accidents incident to it. In a commercial way where a large flock is kept, a yard inclosing an acre or more of ground would be desirable. A seven-foot wire fence will usually confine them.

Nests—Often large roomy boxes can be utilized very nicely for nesting purposes, but the handiest and best thing is a large sugar barrel securely blocked to prevent rolling, with the inside littered with straw or forest leaves. The barrels serve an excellent purpose in more ways than one. They are not only cheap and easy to get, but owing to their shape make an excellent protection for the turkey not only from cold winds and rains, but hot days as well. Very often one finds two, and sometimes even three turkeys, that will insist on the same nest, so that it often becomes quite provoking before they can be broken up so that only one will claim the nest. When one uses barrels for nests and such a thing occurs, he has everything his own way; he has but to lean a wide board across the end, leaving a few inches at the top. By such arrangement it is practically impossible for a turkey on the outside to get in, and the inmate of the barrel has but to push the board over when she wishes to walk out. When she returns the board can be replaced. The barrel

next serves an excellent purpose when the brood is hatched. Securely fasten an eight or ten-inch board across the lower end so that the little turkeys cannot squeeze out, but be sure to leave sufficient space so that the hen can leave or return if she sees fit. With a barrel so arranged the poults are not apt to become either chilled or lost and they are very easily caught when it is desired to move them.

Setting Turkeys—The first clutch of eggs should be set under chicken hens. Break up the broody turkey and she will soon go to laying again. Before setting the eggs, sprinkle the nest and turkey with pyrethrum powder or sulphur to prevent trouble from lice or mites, either of which may cause her to desert the eggs. The hen turkey is usually allowed to hatch the second clutch. The turks will be a little more trouble, as the turkey mother is more apt to wander farther from home than the hen. By driving them home for a few nights they will soon learn to return, especially if fed at the coop. Never leave them out over night, as they will most likely become the prey of some marauding animals. A whole flock may be destroyed during one night by foxes. The mother turkey is also likely to start on her travels before the grass is dry, dragging her little ones after her, often causing serious loss. Move coops to a clean spot every other day at first, and later every day.

FEED AND CARE OF YOUNG TURKEYS

After the young are thirty-six hours old remove all to a good sized coop and place the coop where there is plenty of grass. If the grass is long mow it off. For early in the season be sure to have a movable board bottom to the coop and clean this off and sand every day. Dampness and filth mean death. After the

weather settles and the ground warms up place the coop in the ground or grass and clean by simply moving it to fresh ground. Lice are the cause of nearly all the ills of turkeydom and kill more young ones than all else combined. Get rid of the lice on the old birds first by dusting them every week, while sitting, with insect powder and place green cedar leaves and branches in the bottom of the nests. Lice won't tarry long where these are. The poults should be given a drop of sweet oil on the head and neck, under the wings and around the vent, once a week, applied with the finger and rubbed on next the skin. Too much may hurt them.

The first feed should be dry bread. Take one quart each of corn meal, middlings and bran and one pint of sifted ground oats. Season with salt, add a little pepper, mix up with water or sour milk and add enough saleratus to raise it. Bake until done. Enough can be baked at one time to last several days. After the poults are several days old moisten the hard crust in sweet milk, squeeze out dry and feed. Give a little every two hours. Feed on a clean board and be sure that none is left over to sour.

Feed everything as dry as possible, as sloppy or uncooked food is injurious. After the turks are a week old the feed may be scalded. The saleratus and sour milk should be left out and a little meat added, or cook a piece of fresh lean meat and feed a little of it once a day. Ground bone may be put in the feed at all times if it is sweet and good. When the poults are ten days old commence to feed whole wheat for supper, and when a month old feed cracked corn for supper and wheat at noon. During all this time keep on with the scalded feed between the times when wheat or corn is given. After four weeks old feed only four times a day. When four months old twice

daily is sufficient and the feed may consist of whole grains, which should be kept up until killing time if you want to have the stock large. Feed very little corn unless you want to fatten them for market. Give a variety, if possible, such as wheat, oats, buckwheat and barley. Wheat is the best food if only one kind is given. Procure some whole black pepper, and every morning look over the little ones, and whenever one is noticed to appear droopy pick it up and look for lice, and at the same time give it a grain of the pepper. Most of the trouble with young turkeys can be traced to inbreeding and lack of vigor in the parent stock, lice and improper feeding. Corn meal and skimmilk curds are favorite feeds for young turkeys. Either alone is enough to kill them; combined they are not quite so bad, yet they are a very poor ration.

After turkeys "shoot the red," or are full feathered, they will largely take care of themselves, but before that they will require constant watching. Build a little pen with some short boards in front of each coop and don't let the little fellows out of this for the first four or five days. After that time they may be let out on every fair day—after the dew is off. Also let the hen out with her brood after the seventh day. Always know where your turkeys are and if a shower comes up get them under cover as soon as possible.

It pays to herd turkeys where they are raised in considerable numbers. A peculiar thing about herding turkeys, especially if the poults have turkey mothers, is that once their day's route is established they will go the same round each day and generally on schedule time. The best plan is to keep the flock restricted to the territory adjacent to their coop until the poults are feathered, when the broods can be flocked together and started out to the woods and fields. Here is where the herder is needed. The losses from various sources

—strays, hawks, foxes, minks and weasels, hunters and dogs a little later in the season, make big inroads into the flock unless guarded. Ordinarily this would be rather dull work for a boy or girl, and none should attempt it unless there were two for company. The route taken by the flock could be through all the stubble fields, where sufficient grain food would be gleaned, in the pastures and cut meadows, where the poults would do good work on grasshoppers, crickets and other insects, and into the woodland, where they will dust themselves in the fine dust of some rotten log, to rid themselves of lice. Even when it is impractical to guard them the entire day, much can be done by way of insuring their safety by having them roam in the direction showing least danger. This can be done by starting them right in the morning and feeding them a short distance from home on their return at night.

When fattening turkeys in the fall, feed plenty of whole corn and pen them up in a shed or stable, letting them out every four or five days to take exercise.

MARKING TURKEYS

In neighborhoods where many of the farmers raise turkeys it is necessary to brand or mark the stock in some way in order to prevent loss and the occasional neighborhood quarrels which result. As turkeys are so much inclined to roam, flocks of several neighbors frequently get mixed early in the season and run together more or less the rest of the year. The one who first rounds up the flock usually selects his original number and chooses the best turkeys; the others have to stand all the losses. By a system of punching the webs between the toes the turkeys can be easily identified. This is easily done with a harness punch or a



FIG. 108—GROUP OF BRONZE TURKEYS AND BROOD COOP

poultry marker. A large number of combinations can be worked out, and whichever combination is decided on should be registered with some town official.

BREEDS OF TURKEYS

While six varieties of turkeys are recognized by the American Standard of Perfection, only two are

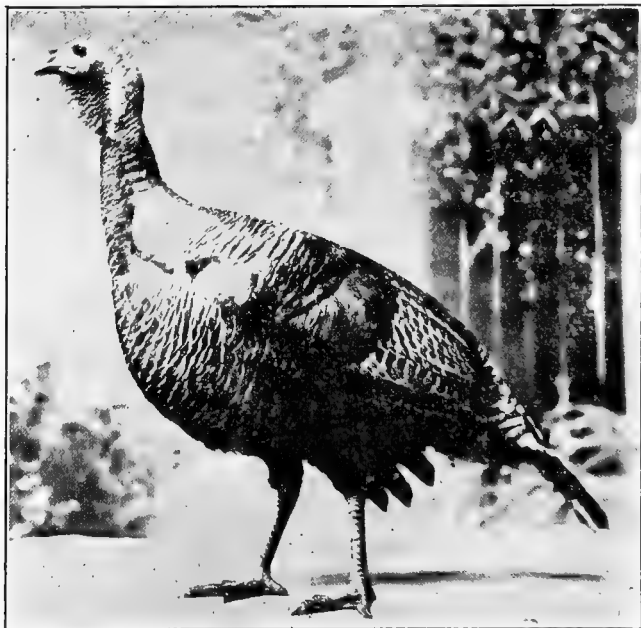

FIG. 109—A PERFECT BRONZE TURKEY HEN

kept to any extent by poultry growers. These are the Bronze and the White Holland. The Bronze (Figures 108 and 109) is the largest, hardiest and most prolific.

It is descended directly from the wild turkey and wild blood is frequently crossed in to keep up the vigor. The White Holland is much smaller than the Bronze, in fact, standard weights are lighter than for any of the other breeds. It is of a more quiet disposition and not so much inclined to roam. Buff turkeys are quite striking in appearance and are often met with in small flocks. Other varieties but little seen are the Narragansett, Slate and Black.

GUINEAS

Guineas are a noisy, useful fowl about the farm. They are great foragers and live very largely upon bugs and insects. They seldom scratch, hence need not be feared in the garden. They are apt to steal their nests and frequently several hens will lay in the same nest. They sit late, and unless the nest is found they will cover all the eggs they can, but many of them will not hatch. The period of incubation is twenty-six days. The young are hardy from the start and can be brought up in the same way as chickens or turkeys, but they need feeding every two hours the first week.

Guineas are very noisy and make a great racket when anything unusual occurs. They are useful in giving alarm at the approach of hawks or crows, or other intruders. It is a brave chicken thief who will go into a chicken yard or roost guarded with a pair of guineas. The eggs are small to medium in size, light brown in color, speckled with fine dots, and very pointed at one end. The shell is thick and tough. The eggs are rich in flavor and greatly prized by housewives.

The flesh of the guinea is quite gamy, dark in color, tender and relished by many who like game.

Cocks and hens resemble each other very closely and it is difficult even for the practiced eye to tell them apart. The head of the cock is frequently a little thicker, with wattles double the size of the hen. The hen cries out her song, "buckwheat," while the cock has an entirely different call. One cock mates with not over two hens. There are two standard varieties, the White and the Pearl (Figure 110).

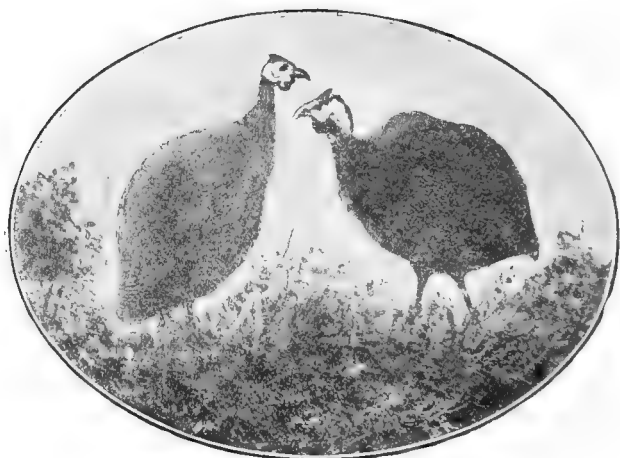

FIG. 110—PAIR OF PEARL GUINEAS

PEAFOWLS

No bird is more ornamental in appearance than the peafowl. They were formerly prized by epicures and the flesh is considered a very choice morsel by those who have eaten it. The young are very tender, much like pheasants in this respect, and should be brought up in about the same manner. They do best when

raised with the mother hens or in a brooder, for they want hovering for six months. The old are very hardy and delight to roost in tall trees or on the ridge-pole of buildings. They are quite noisy and inclined to roam. If the young are wintered the first year in a yard inclosed with wire netting on sides and top they will not roam so far in after years. The hens lay only a few eggs, which require twenty-eight to thirty days to hatch. The cocks do not get their full feathers until three years of age. There are several varieties. The Blue or variegated is the most common. The White are rare as well as very beautiful. Peafowls are often cruel to other fowls and are frequently a great nuisance about the poultry yard.



CHAPTER XII

Pigeons and Squab Raising

Pigeons, unlike poultry, are monogamous. They mate in pairs and when once mated generally stay so for life. Therefore, a careful breeder will see that all his pigeons are properly mated, for an unmated cock or hen in a loft will stir up a lot of trouble. Breeders of fine pigeons always make their own matings, which can be easily done by confining the birds to be mated

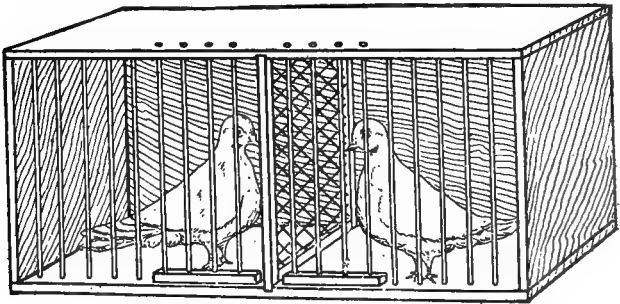

FIG. III—MATING COOP FOR PIGEONS

in a cage, such as shown in Figure III. A good size is three feet long, fourteen to eighteen inches deep and same high. It must have a partition in the center which can be removed when required. Place the cock in one side and the hen in the other, and after leaving them for a day or two remove the partition. If they do not seem ready to mate, separate again and wait a

day or two longer. This method prevents fighting and secures any mating desired.

Where pigeons are kept it is too often the practice to house them in some low loft under the eaves; where it is inconvenient to visit them and where the birds often suffer neglect. If possible it is better to have quarters upon the ground floor and preferably in a separate building. The pigeon house may well be made an ornament to the place. A good one is shown in Figure 112 and a suitable loft in the second story in Figure 113. The former represents a small and inexpensive house, built on attractive lines and



FIG. 112—PIGEON HOUSE AND FLIGHT

thoroughly suited to the purpose for which it is intended. A small hallway runs through the center, giving access to a commodious room on each side. A "flight" on either end of the house opens out from these two lofts. Such a little house, stained and covered with vines, will make a very attractive addition to any country place, and will do much toward getting children in love with country life and interested in the companionship of animals.

Squab raising is becoming a fad or boom in which many are doomed to disappointment, failure and finan-

cial loss. The squab is a young pigeon just before it leaves the nest and is considered a great delicacy. Squabs are much in demand in many large cities and take the place of quail. They bring from \$1.50 to \$6 per dozen, depending on quality and season of the

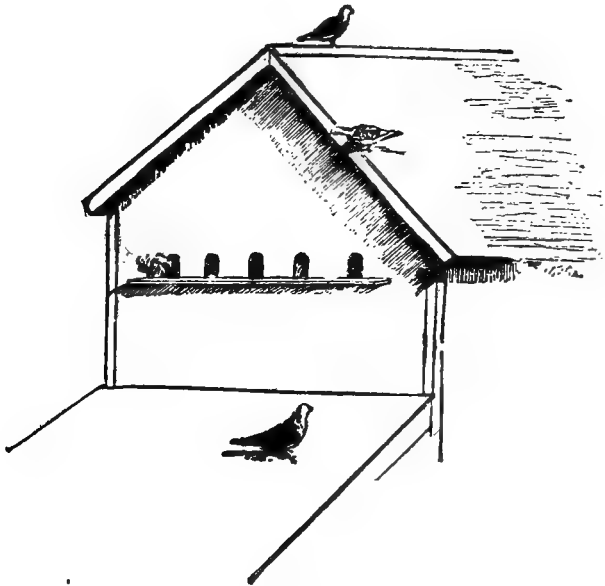

FIG. 113—PIGEON LOFT IN SECOND STORY

year. Although any pigeons will give squabs, Homers (see Figure 114) are by far the best breed for this purpose, being hardy, good breeders and of good size. A special house or loft is needed that is proof against mice, rats, cats and sparrows and where the temperature in winter can be kept above the freezing

point. If this cannot be done, the sexes should be separated until the approach of mild weather. A covered fly is necessary to confine the old birds. Homers brought from a distance will return to the place where they were raised at the first opportunity, hence must always be confined. Young birds raised on the place may be given their liberty.

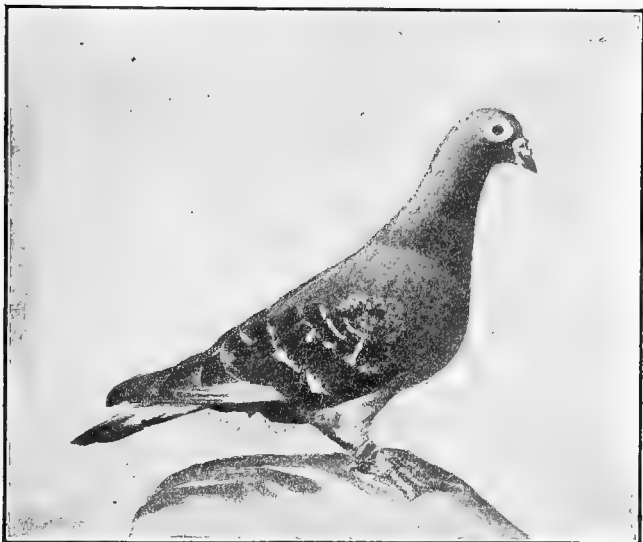

FIG. 114—A FIVE HUNDRED-MILE RECORD HOMER

A good house and fly is shown in Figures 115 and 116. A house six feet high between sill and plate, twelve to fifteen feet wide and of any length desired may be provided. The fly should be from ten to fifty feet long, six to eight feet high and covered on top and sides with inch mesh wire netting. This will keep out the sparrows which otherwise will come in swarms and

eat much of the food. A six-inch board or shelf should be put up along the two ends, and possibly one side, for the pigeons to alight upon, but nothing should be placed across the middle of the fly, or the pigeons may strike against it and be injured.

The interior should be divided into rooms ten feet wide, with a three-foot alley extending along the rear

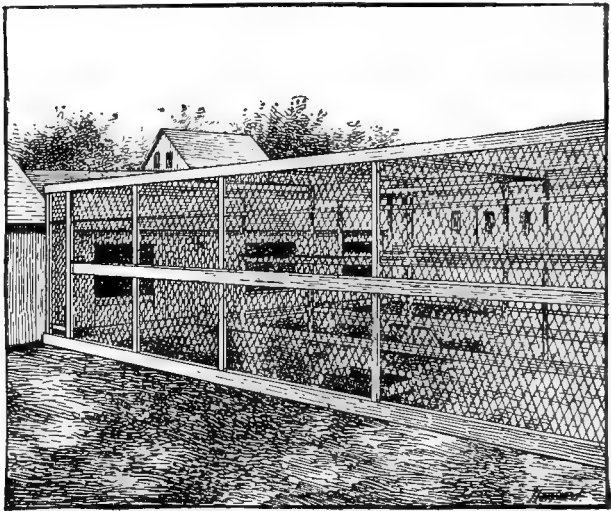

FIG. 115—PIGEON HOUSE AND COVERED FLY

in long houses. On each of two sides of the room the nests should extend from floor to ceiling. Shelves should be put up with partitions so as to make nests three feet long, one foot wide and twelve to fifteen inches high. There must be no alighting board in front for quarrelsome birds to walk on. As the hen will frequently lay again before the squabs have left

the nest, a box of this size must be provided so that two nests can be put in it. Lice killer must be used freely and the houses whitewashed frequently to keep down

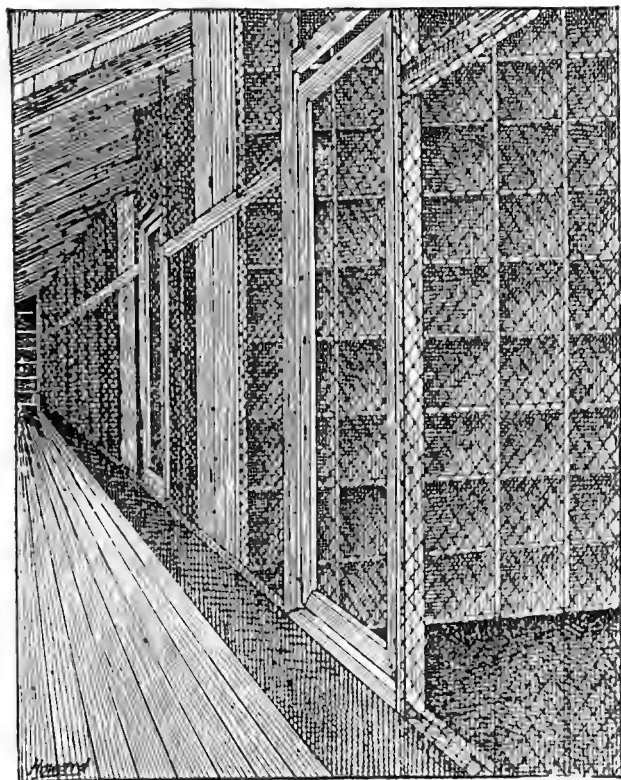

FIG 116—INTERIOR VIEW OF PIGEON HOUSE

the lice. A room and fly of the size mentioned will accommodate twenty-five pairs of pigeons, which is enough for one flock. The pigeons are fed a variety

of grains, such as cracked corn, wheat, peas, millet, hemp seed, etc. They need water for drinking and bathing, also sharp sand or grit and occasionally some salt. Besides Homers, which are the best and cheapest, Antwerps and Runts are also used for raising squabs. The latter are the giants among pigeons, but are shy breeders and not good feeders. White squabs always sell better than do colored ones. A flock of old birds will average in the hands of a skillful breeder about six pairs of squabs a year. Much bigger claims than this, however, are often made by persons who have birds to sell.

The beginner should start with a few mated pairs and then raise his own flock of breeders. Great disappointment and much loss comes from getting birds which are not mates. An unmated cock or hen in a loft will cause a lot of trouble—a few such will prevent any profit. Many dealers who find it more profitable to sell breeders than to raise squabs, send out anything and everything to their customers as mated birds. Some of them say mating commonly means in sales half cocks and half hens. William E. Rice, an authority on squab raising, thus defines mated pigeons: "A mated pair of pigeons consists of a male and a female which have built a nest, laid eggs and hatched a pair of squabs which are fit for market in four weeks from the time of hatching." The only safe way in buying breeders is to get a written guarantee that they are mated, and a list showing which the pairs were. If any dealer will not furnish this better let him alone. The purchaser who buys birds represented to be mated has a right to expect that they have actually been mated and will prove it by going to work and rearing squabs, and he ought to be provided with a list for his guidance showing which birds are mated.

Pheasant Rearing—The critical time of the young pheasant is the first two weeks, and during this time

too much care cannot be given the young birds; they should be fed at least four times a day. Custard made of milk and eggs is the best and only feed that should be given them for the first two weeks; feed them on a board or common pie pan.

Place some directly in front of the coop and just as close to the coop as possible, especially for the first two or three days; after that the birds will find the feed anywhere in the inclosure, as they will by that time run all over the space allotted them. Should you prefer, the hen and her brood can have their liberty in five or six days, as by that time the young will know the call and talk of their foster-mother and they will not leave her. The hen will always come back to the coop to roost.

Never allow the young to eat any stale custard, and be quite certain that all stale food is removed before feeding. After you have given them liberty, but little attention may be given them, as the hen will care for her brood better than you can. However, I find it an excellent idea to feed them once or twice a day, as by so doing they will get very much tamer.

Hard boiled egg is an excellent food for pheasants after they are two weeks old; boiled potatoes, chopped up fine, will not be amiss to mix with the egg, but care should be taken not to form a paste with the eggs and potatoes. Should you prefer, the hen can be left in the coop until the pheasants are ready to wean; in this case remove the birds and allow the young to roam over as much territory as they like. They will not be likely to get so far away that they cannot hear their mother's call.

Before you attempt to raise pheasants or quail, kill all your cats, and if you have neighbors who have cats, tell them that it means death if any of their cats are found trespassing.

CHAPTER XIII

Enemies and Diseases

Probably the best and most effective remedy for all serious poultry ailments, in young or old, is the application of a good sharp ax where it will sever the head from the body. This remedy is scouted by some, but it still remains the best time and money saver, and the surest means to promote health in our poultry. Many poultry ailments serve as a warning from nature that the affected birds are unfit for breeders through some constitutional taint. If we doctor these individuals which nature has marked as unfit, and succeed in pulling them through, we defeat our own best interests. Unless we weed out the ailing and weaklings, and refuse to breed from such, we must expect a large mortality in the offspring.

A correspondent writes us that after five years of using no remedy for sick fowls except "a good sharp ax," he now finds disease in his flock of very rare occurrence, and usually of trifling character, which recovers spontaneously. Previous to using the ax freely he had much trouble with sick hens, and never got through a winter without roup. Another correspondent, who always uses the medicine bottle, and cannot bring himself to killing off the diseased breeders, is complaining of great mortality among his chicks from "no apparent cause." His chicks die at all stages of incubation, and some are dropping off all the time from hatching up to maturity—a sure sign of unhealthy parentage, and evidence of the working of nature's law, that of "the survival of the fittest." Had

he used the ax and aided nature he would now be better off.

We are not afraid to advocate the free use of the ax as a poultry remedy. There is no danger of anyone overdoing it; people are not built that way. Everyone will hold on to a miserable, puny or diseased specimen until they are sure that there is no relief except in the ax.

The way to succeed in the poultry business is to start with the best, always keep the best, and always strive to improve it. Build it up, and keep it built up, and remember that "like begets like." The very first requisite in breeding birds is a strong constitution and sound health. Unless you have this solid foundation, all attempts at improvement are time and money wasted. You cannot secure healthy fowls with the aid of the medicine bottle; but you can rid yourself of undesirable specimens, and prevent the reproduction of disease in the offspring, if you will only use sound common sense—and an ax. However, there are some who wish to doctor their poultry; and there are times when it is wise to treat a fine specimen. Hence the necessity of giving a few simple remedies for some of the common ailments.

Asthenia or Going Light—This trouble is not a form of consumption, as many suppose. The fowl has a ravenous appetite, but the food seems to afford no nourishment and the fowl gradually wastes away and dies of actual starvation. The disease has been investigated by Dr. Charles F. Dawson, who finds that it is caused by a microbe or bacterium in the small intestine. The bacteria undoubtedly subsist largely on the food consumed by the fowl and cause a fermentation in it so that no nourishment can be obtained from it. A slight inflammation of the intestines is also noted. The treatment should be, first, the removal of

the bacteria, and the use of easily digested foods and tonics to build up the system. As medicinal agents for the removal of the cause by purgation, Dr. Dawson recommends castor oil in two-teaspoonful doses, or calomel in oft-repeated one-quarter-grain doses may be tried. Purgation should be followed by a stimulating tonic. Dr. Salmon recommends the following tonic in similar affections: Powdered fennel, anise, coriander seed, cinchona, of each thirty grains; powdered gentian and ginger, of each one dram; powdered sulphate of iron, fifteen grains. Mix; add from two to four grains of this mixture for each fowl to the food twice a day.

Blackhead in Turkeys—It is an infectious liver disease, similar in its nature to human dysentery. The disease takes its name from the fact that turkeys of a certain age, when affected, look shrunken, pinched and purple about the head. Turkeys having the disease probably infect the land they run upon. The organisms are present in their excrement, and if taken in with food or water, many produce the disease in other turkeys. Sick birds should be killed and burned or buried deeply. Buildings, coops, and feeding and drinking vessels which they may have contaminated, should be disinfected. Birds once having this trouble, even if they have apparently recovered, may still not be free from it, and be able to scatter infecting material. It is, therefore, not best to keep specimens that have ever been affected. Take great pains to clear out the sick from both young and old, and then if it is possible, change the well ones to new ground. Little turkeys are most susceptible. They are infected early in life, and the disease develops fast or slow, according to how numerous the organisms are, or to the strength of the turkey. Wet, stormy weather aggravates the disease. The feathers look rough, the birds

have diarrhea, with bright yellow excrement; and they weakly drag one foot after the other for some time before they die. In some cases both caeca are affected, in others but one or a part of one. Those having but a small part of the liver invaded may live through the winter, and not die until spring. Prevention is possible, but cure is difficult. By breeding them to secure great vigor, by feeding to counteract any tendency to diarrhea, and by giving preventive treatment upon the slightest symptoms of abnormal looseness, much may be done to help them resist the disease if they are exposed to it. A tonic and stimulant for the liver and bowels will help the disease; confinement and over-feeding favor it. Pepper and ginger and something sour are indicated, as well as an astringent. Sick turkeys sometimes recover after they can eat all the acorns they want; they administer the astringent themselves.

Bowel Trouble—Fowls whose droppings are black, watery or yellowish white have bowel trouble, probably caused by indigestion. Give an abundance of sharp, hard grit, moderately at first, some green vegetable food and good wholesome food, and pure, clean water, to which add one teaspoonful of Douglas mixture. Scald and keep clean all drinking vessels and feed boxes. Spread lime freely about the yard, spade it up and seed down to rye or wheat. Add two ounces sulphuric acid to two gallons water and sprinkle liberally around the house. Feed once a day a mash scalded, composed of four parts each of ground oats, wheat bran and corn meal and one part linseed meal, with sound, whole grain at other times. Every other day for a week add one ounce powdered charcoal to each quart of mash.

Bumble foot is caused by some injury to foot. Jumping from roosts that are too high is an exciting

cause. Put a good warm linseed meal poultice on the foot as soon as the trouble is discovered. When the swelling softens up lance at the point where the skin over abscess seems thinnest, and after lancing wash the wound out thoroughly with a solution of hydrogen dioxide one part, with two parts warm water. Use this solution to bathe the wound daily until healed. Do not be afraid to open the abscess freely when you lance it. One lancing should be sufficient. After you have opened it keep it open by packing the wound with gauze. So treated it will heal from the bottom out, and will give a good foot when healed. The wound should be bathed and dressed every day, and better, twice a day. Keep bird by itself in clean coop on clean straw, with foot well bandaged until well. If your roosts are too high, lower them.

Cholera is a highly contagious disease affecting all poultry and is caused by bacteria. The infection occurs by taking food or drink contaminated by the excrement of sick birds, or even by inhaling the germs floating in the air. It may run rapidly through a flock, destroying a large portion of the fowls in a week, or it may assume a chronic form, spread slowly and be troublesome for weeks or even months. The earliest symptoms are a yellow color of the urates, or excrement secreted by the kidneys, followed by loss of appetite. The bird separates from the flock, the feathers become rough, the wings droop, the head is drawn toward the body and the fowl becomes weak and sleepy. These symptoms are usually accompanied with a high fever and intense thirst. The disease lasts usually about three days. Medical treatment is of little avail. A dessertspoonful of a solution of one dram carbolic or hydrochloric acid to one quart of water for adult birds is recommended. Affected birds should be isolated and the greatest dependence placed on a

thorough disinfection of the premises and on sanitary precautions. Give a thorough cleaning to the houses, yards and whatever ground the poultry frequent. For disinfecting, sulphuric acid is the cheapest, but it is extremely dangerous to use, as it burns severely if it touches one's flesh or clothing. One pound to fifty quarts of water is the right proportion to use. Pour the acid slowly into the water in a wooden vessel, as it creates considerable heat in mixing. Sprinkle the weakened acid freely around the henhouse and on the ground frequented by the poultry. Thoroughly cleanse the drinking and feeding vessels and keep them clean. Persistent and heroic measures are necessary to get rid of cholera when once it gets into a flock. The following remedy is given by an Illinois poultry-keeper as a sure cure for chicken cholera: Two ounces pulverized capsicum, two ounces pulverized asafetida, one ounce pulverized rhubarb, six ounces Spanish brown, two ounces flowers of sulphur; mix thoroughly and keep in an air-tight can. Put one teaspoonful in two quarts of the mash and feed twice a day until all symptoms of the disease disappear.

To Avoid Colds—Each fowl showing evidence of cold or congestion should be shut up in a small coop and given two grains of calomel at night, followed by a one-grain quinine pill night and morning for two or three days. If there is any discharge from nostrils inject a few drops of camphorated oil into each nostril. If any improvement is manifest in two or three days, remove to a small room and add a solution of copperas to the drinking water. Keep here for a week or two, or until they show a complete recovery. If, on the other hand, after two or three days' observation and treatment, no improvement is manifest, the bird should be killed and buried.

Consumption is a disease prevalent to a considerable extent in parts of California and no doubt causes more or less loss in all parts of the country. The affected fowls grow thin, pale, listless and eventually die. Breeding from healthy, vigorous stock, clean, well ventilated quarters, food and care are the best ways to avoid it.

Cramp is a trouble which often affects chicks confined in damp quarters. The toes begin to swell, and grow crooked, turned to one side, and twist; joint after joint becoming affected until the whole foot is swollen. The chick stops growing, and its feet seem tender and painful. It is a gouty condition, and akin to rheumatism. It is often caused by overfeeding of heating and stimulating foods. Any considerable amount of greasy meat scrap or poor meat meal from which the fat has not been well extracted, will cause it. The disease appears most frequently in chicks from delicate or rheumatic parents, or those which are overfat or suffering from the effects of overfeeding. Chicks which have had cramps are worthless as breeders. Those which apparently recover are only fit for the pot, as they will almost to a certainty transmit to their chicks their tendency to rheumatic diseases. Treatment for mild cases, rub the legs and feet twice a day with a good liniment, carefully stretching out the toes. Add to a pint of fresh drinking water ten grains of salicylate of soda. Let the chicks have a drink of this morning, noon and night. Take it away as soon as they have each had a drink. Mix fresh every day. Continue treatment for a few days after apparent cure. Allow no other drink but the medicated water while under treatment.

Crop-bound is perhaps the commonest form of crop trouble, and is generally caused by careless feeding. The proof of a crop-bound is purely external, but

is, fortunately, very easily discernible. Instead of the crop having a firm, close appearance, in fact, not being noticeable, it is seen to hang down like a bag, and on being felt there is found to be inside a lump or ball of food. If the trouble is discovered early, cure is very easy. The first step is to pour some salad oil or melted lard down the throat, and then to work gently with the hand the mass in the crop. This, if properly and effectively done, will soon cause the food and the fluid to mix, and when the mass has been well broken up, it will in the course of a few hours pass away. Warm water may be used instead of the oil or lard, but it is not so rapid or so effective in its action. When the mass has been got rid of, great care is required in order to prevent a recurrence of the same thing. Feed sparingly for a few days on sopped bread. When the kneading process is ineffectual, then an operation becomes requisite, but no one need fear the performing of this operation, as it is a very simple one and needs no great skill. Nor is there any danger involved in it. Make an incision lengthwise in the upper part of the crop, about an inch or an inch and a half in length. This should be very cleanly made with a sharp lancet or penknife. Through this incision the contents of the crop may be removed, using for that purpose a small eggspoon. Sometimes the mass is so hard that it cannot pass through the aperture, and in that case it must be broken up, which can be done with care and patience. This mass is usually very offensive indeed, and to remove any contaminating matter from the crop this organ should be washed out with Condy's fluid, or a similar non-poisonous disinfectant. It is also desirable to pass the finger, well pared and oiled, into the orifice so far as to be certain that there is no obstruction there, for if so the whole process may have to be gone over again. This done, the incision must

be sewed up, and for this a small bent needle is best, as by it the skin can be most easily gathered together, and horsehair, not thread, used. Sew the inner skin first, and then the outer one. Three stitches will be needed in each skin. Tie each stitch separately. The food must be limited in quantity. No water must be supplied until the suture has completely healed up.

Douglas mixture is the best general poultry tonic. Mix one-half pound sulphate of iron, one ounce sulphuric acid and two gallons pure soft water. Let settle twenty-four hours, then drain off and bottle. Add one teaspoonful to each pint of drinking water for the fowls.

Egg-bound—Do not allow the hens to get overfat, and they are not likely to become egg-bound. The best thing to do when a hen gets in that condition is to kill and eat her before she gets in such condition that she is unfit for food. Dip the finger into sweet or castor oil, and introduce it into the vent. Ten drops of fluid extract of ergot, given the hen from a spoon, and followed in half an hour by holding the bird over hot water so the steam can reach the vent, will sometimes relieve this condition. At all events, remove her from the male bird, and feed soft food and warm water. If successful in removing the egg, and the bird is worth the extra trouble, keep her in dry, sunny quarters, and in her drink put ten drops of tincture nux vomica to one pint of water. Give this for ten days, avoiding foods rich in starch, such as corn and buckwheat.

Farus is a disease produced by a minute parasitic fungus and attacks the comb, wattles and neck, causing the feathers of the latter to fall out. It is very destructive in poultry yards in England, and being highly contagious, spreads with great rapidity. A single diseased bird soon contaminates the whole flock and several outbreaks have been traced to the introduction

of a new bird from an affected yard. Unless treated properly, it usually ends fatally. The feathers become erect, dry and fall out, leaving the skin covered with dull yellowish gray crusts. The English board of agriculture in a recent leaflet recommends bathing the affected parts with warm water and castile soap, then applying some ointment to destroy the fungus. Nitrate of soda and lard is useful. Red oxide of mercury has also proved an excellent remedy.

Feather eating is a vice caused by idleness and lack of exercise, also from want of proper food, particularly animal matter. Generally one or two hens in the flock are the guilty ones and if these are removed the trouble stops. Give them exercise and plenty of fresh meat. One who has succeeded in breaking it up, writes: Take a piece of raw, fat salt pork (a piece with a good rind, so it will not come down in the dirt) and driving a nail through the rind nail it to some part of the building in easy reach of the hens and let them work at it all they please. When this is gone if they still continue to pick off the feathers, give them another piece.

Gapes are caused by the presence of one or several forked red worms in the windpipe of the chick. The chicks get the gapes by eating the eggs of the worms which have been discharged from other affected birds. The worms can be conveyed from affected birds to healthy ones through the drinking water, also in the food if it has been contaminated by affected birds. The ground and coops that have been at any time contaminated by affected poultry should be thoroughly disinfected at frequent intervals with a two per cent (in water) solution of sulphuric acid. Whitewash all coops with hot whitewash, plow up all runs frequently, and keep them planted with quick growing green stuff. When gapes appear the drinking water should be medicated as a preventive measure. For this purpose

it will be well to add three drams of salicylate of soda to each quart of drinking water. Affected chicks will need radical treatment. Take each chick separately and remove the worms from its windpipe. This can be done with a strip of feather. Take a long slender feather, and tear off all the barbules except those at the tip. Mix a little oil of clove and sweet oil. Moisten the feather tip with this, and insert it gently into the windpipe of the chick. Twist the feather around several times, and withdraw it. If you have operated successfully you will draw out most of the worms with the feather, and the oil will kill the others which may have been left behind. After a little practice the operation is easily performed, and does not seem to trouble the chick much. It is seldom necessary to repeat the operation. Clove oil is used with the sweet oil because it has been found that its use is followed by less irritation than when other lubricants are used. The bodies of any birds which may die of gapes should be burned, all worms removed, and all excrement of affected birds should be burned also.

Hawks are often troublesome but can be frequently caught in an ordinary steel trap, not too large, mounted on the top of a common fence rail or a long pole, set firmly in the ground. It is best located on some moderately high point in the middle of a wide field, where there are no trees or other objects upon which a bird may light. No bait is needed. The trap is simply opened on top of the pole, where the bird sets it off and is caught in the act of alighting. Figure 117. Of course the trap must be firmly secured to the pole. The device is based on the principle that birds of prey habitually light on prominent objects in large open spaces, where they will have a good outlook for game. A trap well placed will, during one season, catch all the hawks within a radius of several miles.

Owls and other large birds are also frequently found in the trap. The longer and the more substantial the pole, the better it is.

Leg weakness is noticed more in young cockerels of the large breeds than in pullets or in those of the

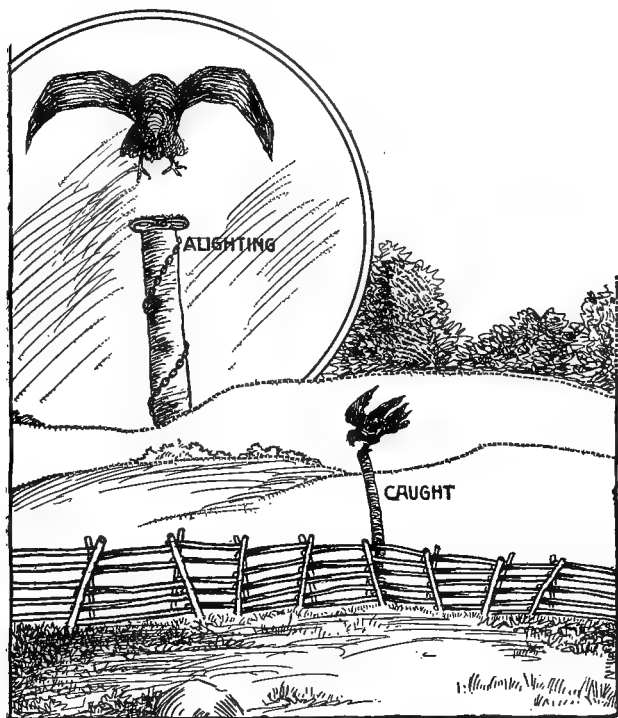

FIG. 117—HAWK TRAP

smaller varieties. It is generally caused by pushing too rapidly for growth. It will first be noticed by uncertainty in the gait and in a week's time the bird

will not be able to stand. The appetite is all right and examination will show nothing wrong except the weakness of the legs. The remedy is to take away all forcing foods, such as meat or green bone, also corn, buckwheat and rye if any of these are fed. Feed entirely on wheat, oats and barley. Give plenty of sharp grit and add fine ground bone or bone meal to the ration. What the chick needs is more mineral matter, which will be supplied in these grains and substances named. One-tenth grain quinine a day will also be a great help.

Lice and mites are the worst enemies with which the poultry keeper has to deal. There are several kinds but the two commonest ones are the gray body lice which live on the fowls and the mites which live in the houses and go on the fowls at night when they are on the roost. Once let a henhouse become infested with the mites and it is almost impossible to get rid of them. They multiply very rapidly and live on filth and refuse matter. Many houses, unsuspected, swarm with them. The gray body lice can be killed by dusting the hens with insect powder, greasing or dipping in sheep dip or tobacco water or confining them a short time in a box or barrel painted on the inside with lice killer. Wood ashes mixed with the dust in the dusting box, equal parts of each, will keep away the lice. A little vaseline on the heads of small chicks as a preventive of lice is better than lard, and if purchased by the pound, is not much more expensive. Thorough and persistent work is needed to rid a house of mites and keep it free of them. If the house is tight, fumigate with sulphur; if not, whitewash with hot lime, to every gallon of which add one ounce crude carbolic acid. Remove the old roosts, nests and other fixtures and saturate with kerosene before putting them back. Also clean out and burn all refuse. Twice

a month shut up the house and throw around air-slaked lime and sulphur. Tobacco dust in the nests and wallows is also useful. Paint the roosts frequently with a lice killer. A good one can be made of one-half pint carbolic acid, one-half pint bi-sulphuret of carbon and one-half gill pine tar. Shake thoroughly and add slowly to fifteen pints crude petroleum. Keep well corked in a jug or can. Shake well before using and apply with a brush to drop boards, roosts, nests and the inside of poultry house shortly before the fowls go to roost. Another good lice killer is made by dissolving in kerosene all the crude naphthalene flakes.

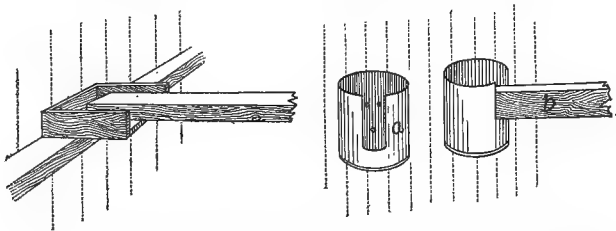

FIG 118.—DEVICES FOR PROTECTING ROOSTS FROM LICE

it will take up. Moth balls will not answer. Mites will not venture on roosts that receive a soaking in this fluid every two weeks. The odor of the naphthalene sticks to the roosts, and warns vermin away. After two or three applications the roosts will not need treatment oftener than once a month. Sawdust slightly moistened with this liquid is an excellent article to keep vermin from the nests. Vermin proof roosts are also effective and well worth using. Make the roost of two by three-inch planed joists and set both ends in shallow boxes arranged as shown in Figure 118. One end of each box is partly removed;

and the boxes are then filled with dry, powdery, air-slaked lime, heaped up so that the roost rests entirely upon the lime and does not touch the box at any point. Vermin will not get to a roost protected in this way. Another simple yet effective device is to place the ends of the roosts in tin cans containing kerosene. A slot or groove is cut in the can, *a*, half way down, to hold the end of the roost, *b*, as shown. The bottom of the can is kept filled with kerosene. These cans are nailed to the side of the building and effectually prevent all lice from crawling into the roosts.

Limber neck is a complaint common to chickens in the middle and southern states. It is caused by ptomaine poisoning from eating putrid flesh. The disease is a paralysis of the neck, and death is not caused by maggots gnawing through the craw, as is commonly supposed. Poultry keepers in England and France feed their birds on maggots, but where maggots are, the poison which causes this trouble is likely to be found. Turpentine is a good remedy, but probably the most effectual is venetian red, say half a teaspoonful to each bird daily. Mix this with dough and roll into strips one inch long.

Rats are one of the worst pests around the poultry house as they not only steal much of the grain but carry off eggs and young chicks. Persistent trapping and poisoning will keep them subdued. The best baits to use in trapping are small pieces of Vienna sausage (Wienerwurst) or bacon. One of the cheapest and most effective poisons is barium carbonate, or barytes, a mineral without taste or smell. In the small quantities used for poisoning rats and mice it is harmless to larger animals. Its action is slow but reasonably sure. Mix one-fifth barytes with four-fifths cornmeal or one-eighth barytes with seven-eighths of its bulk of oatmeal. Then mix it with water in the form of a

stiff dough and place the prepared baits in places where the rats frequent. Plaster of paris is also used frequently with good effect. Take a large box, make some holes in the sides and ends high enough from the ground so chickens cannot get in; put in corn meal for a bait for a few nights. After the rats get to eating good, mix some plaster of paris with the meal. The moisture in the rats' stomachs will cause the plaster to set hard, and the rats will die. A small dish of water in the box might be a good idea, and cause the rats to die sooner.

Roup is the name commonly given to most disorders of the passages of head and throat, the symptoms varying considerably, as in humans affected with colds, mild or severe, influenza, acute catarrh, sore throat, diphtheria, etc. These troubles, although not strictly one disease, are enough alike to admit being considered together. First signs are dumpishness, usually, but not always, a poor appetite, breathing is loud, and sometimes there is a choking noise or cough. Then follows a discharge from the nose, and if the case is severe, a secretion extending to the eyes, often covering them with a whitish matter. Sometimes the whole face is badly swelled. In diphtheritic roup, the roof of the mouth and throat show patches of white matter, which later becomes yellowish, sometimes with a bad odor. Mild cases of roup get well, others linger a long time and still others grow thin and die. Sometimes roup hangs around a flock for years, owing to bad conditions. Fowls of strong stock, which are not overfed, which are induced to exercise for a living, and not much exposed to drafts, damp floors, or infection from sick fowls, will not be likely to get roup. Those which have the malady must be kept in a dry, warm place, and separate, as the disease spreads through the drinking water and in other ways from

bird to bird. The buildings should be cleaned, white-washed and made as dry, light and warm as possible. Feed the well birds attractive food, but never leave it before them to eat at will. Add Douglas mixture to their drinking water. As for the sick fowls, if they are numerous enough or sufficiently valuable to be worth treatment, a simple remedy is a drop of kerosene in the nose passages and a very little applied to the other diseased parts with a small brush. Carbolic acid one part to fifty parts water may be used. Peroxide of hydrogen diluted one-half with water and squirted into the nostrils with a fountain pen filler or medicine dropper will help clear the passages. Remove matter on face and eyes with soft sponge and warm water, and from the throat with a cotton wad on a splinter. Roup is sometimes mistaken for gapes on account of the gasping for breath, but examination will show the difference by the appearance of whitish matter and other signs of roup.

Sore Heads—Use vaseline, kerosene and sulphur rubbed on the head. This is quick and effective.

Scaly leg is caused by a parasite that lives under the scale of the leg, and the scab is the excrement, etc., thrown off by these insects. It can be easily cured if a little pains is taken to rub on ointment made of kerosene, lard and a little sulphur added. The quantity is immaterial; the kerosene, being the most penetrating, is the best part of the remedy, and the lard gives sufficient consistency to it, so that it does not run off quickly. Rub this well in under the scales three times, about a week apart, and it will effect a cure. It is no harm to rub it on oftener if you wish to, but there is no particular need of it.

Skunks—Lay for them on moonlight nights with a good gun, and shoot them. After you have killed a few they will be less troublesome. You can trap them

in box traps, using a fresh killed chick for bait. Owing to the peculiarity of the beasts this method is not so satisfactory as shooting. Dosing the body of a freshly killed chick with arsenic and placing it where his skunkship will get it, is also recommended as a good method.

Venetian red has long been a popular remedy with some poultrymen. It is the red oxide of iron, and undoubtedly possesses medicinal virtue. Its value is vouched for by reliable men, and we can see no reason why it should not be tried in the diseases for which it is recommended; more especially as it is found useful in troubles which have hitherto been considered incurable and fatal. Venetian red is used in the drinking water, about a teaspoonful (for fowls, less for chicks) in a quart of water. It does not dissolve, and in time settles to the bottom of the vessel. The water is renewed without rinsing out the powder, which rises to the surface when fresh water is added. Those who have used venetian red are inclined to attribute to it "cure all" virtues, much the same as any enthusiast is liable to overrate the curing capacity of his special favorite remedy. There is reason to believe in the value of venetian red in the treatment of the following: canker, some bowel troubles (more especially those accompanied by wasting of flesh), "going light," "pasting up behind" in chicks, and in all diseases where a blood tonic would be useful.

Worms—Two kinds of worms are quite common in poultry; the round, and the flat or tapeworms. Infection takes place through fowls eating the eggs of the parasites found in the droppings of infected birds. Droppings of stock having worms should be collected frequently and burned. For round worms, give a two-grain pill of santonin to each affected bird every other morning before feeding, following it in

half an hour with two teaspoonfuls of raw linseed oil. Continue treatment one week. Flat or tapeworms when found in the droppings look like pieces of tape. The eggs of these parasites are expelled in the droppings, and are taken up and undergo a preparatory stage in some of the insect parasites like fleas and lice; when these vermin are eaten by the fowl the contained embryo is ready to develop into a full fledged tapeworm in the intestines of the fowl. The affected bird is often possessed of a remarkable appetite, and at the same time grows thin. At other times the presence of tapeworms in a fowl may not be suspected until pieces of the worms are found in the droppings. Make a mash of bruised pumpkin seeds with a little milk, and after allowing the bird to fast for twelve hours, feed it all of this mash that it can be forced to eat. In an hour or two give a teaspoonful of castor oil, or two teaspoonfuls of raw linseed oil. After the worms are expelled feed a warm mash of bran, middlings and milk. If worms appear again in droppings the treatment did not get all of them, and may be repeated in a few days.

Index

	Page		Page
Absorbents, road dust	43	Broilers, American breeds	207
and ashes	43	celery fed	208
Amateur's experience	34	finishing	208
Breeds, test of	92	methods of feeding	209
American Dominique	113	packing and shipping	210
Anconas	103	Philadelphia	209
Andalusians	102	requisites for raising	206
Bantams	117	squab	208
Brahmas	93	Capons	210
Buckeyes	112	experience with	219
Cochins	95	market for	211
Crevecoeurs	97	Caponizing, best breeds	
Dorkings	113	for	212
Faverolles	95	operation of	212
Games	116	Chicks, baby chick food	161
Hamburgs	104	bowel trouble	163
Houdan	104	care of	158
Indian Games	114	drinking fountain	164
Javas	113	feeding	159
La Fleche	96	feeding incubator	179
Langshans	95	feeding trough	162
Leghorns	98	handling brooder	183
Minorcas	99	teaching to roost	45
Orpingtons	113	why incubator chicks	
Plymouth Rocks	107	die	178
Polish	117	Clipping wings	42
Redcaps	104	Colony plan	46
Rhode Island Reds	111	Combs, prevent freezing	44
Rhode Island Whites	112	Contests, money-in-poul-	
White-Faced Black		try	3
Spanish	101	Burnley society	23
Wyandottes	109	Utility Poultry club	22
Ducks, Muscovy	248	winter egg laying	6
Ducks, Pekin	247	Coops, barrel	156
Ducks, Indian Runner	247	brood coops for hens	
Ducks, other varieties	249	and chicks	155
Geese, African	260	convenient	155
Geese, Chinese	260	for early chickens	156
Geese, Embden	260	for two broods	157
Geese, Egyptian	261	Cramming	141
Geese, Toulouse	259	Crate fattening	141
Geese, Wild Canada	261	Crooked breast bones	44
Turkeys	288	Dehorn roosters	44
crossing pure breeds	89	Diseases, asthenia or go-	
serviceable cross-bred		ing light	287
chickens	90	blackhead in turkeys	288
Breeding pen	92	bowel trouble	163, 289
Brooder, care of	181	bumble foot	289
capacity of	182	cholera	290
gasolene heated	193	colds	291
handling chicks	183	consumption	292
homemade, 202, 203, 204, 205		cramp	292
houses	186	crop bound	292
Tillinghast	204	egg bound	294
up-to-date	199	egg eating	27
use of	181	favus	294
		feather eating	295

	Page		Page
<i>Diseases, continued</i>		<i>Feed, continued</i>	
gapes	295	self feeders.....	122, 124
leg weakness	297	skimmilk	127
limber neck	300	substitutes for green	
roup	301	bone	126
scaly leg	302	table of weights	145
sore heads	302	trough	121
worms	303	variety	124
Douglas mixture	294	wheat	120
Ducks, breeds of	246	Feeding for eggs	131
care of young	239	incubator chicks.....	179
commercial breeding	234	mash	122
handling breeding		value and results in	142
stock	240	whole or ground grain	121
killing and picking		Fences	72
232, 244	244	Flock, best size of.....	41
marketing	232, 244	Floors, best kinds.....	71
water tank for	238	Fowls, for show ring,	
winter quarters for.....	242	preparing	35
Egg laying contests, 6, 22, 23		Frozen combs, preventing	44
Eggs, brown vs. white... 28		Geese, breeds of	258
chemical composition.. 28		care of breeding.....	252
cost of production... 20		cross breeding.....	261
eating	27	distinguishing sex ...	254
farming for	139	feeding and making	
feeding for	131	young	255
flavor influenced by		goose fattening busi-	
feed	125	ness	255
fresh defined	225	keeping for profit... 249	
in winter, how to get		killing	256
6, 24	24	marketing	232
marketing	225	money in	250
mixed in incubator... 176		picking live	257
new laid	225	Guineas	275
physical composition.. 28		Hatching, natural way.. 149	
reducing cost	21	setting the hen.....	150
sex of	29	Houses, cheap	68
shipping	226	A-shaped	69
storing	226	barrel stave	64
Enemies, hawks	296	breeding pen	70
lice and mites.....	298	brooder	186
rats	300	cheap structure	63
skunks	302	continuous	51
Experiences of an ama-		Cornell	53
teur	34	curtain front	51
Farm, large poultry.... 80		floor of	71
well arranged poultry.. 79		inside of	74
Fattening crate	141	novel	64
poultry	140	practical and inexpen-	
Feed, animal food	125	sive	60
baby chick	130, 161	satisfactory	67
barley	120	scratching shed	47
composition of various		suburban	65
stuffs	143	two-story	71
corn	119	ventilation of	71
green bones	126	well arranged.....	60
green food	127	Income, average per hen 6	
grit	128	Incubation, artificial.... 166	
influence on color of		Incubators, advantages of 177	
yolk	44	care of lamp.....	169
influence on flavor of		each breed separately.. 176	
eggs	127	feeding chicks	179
oats	120		

	Page		Page
Incubators, <i>continued</i>		Poultry, <i>continued</i>	
loss in weight of eggs..	173	for English market....	231
necessity of	178	keeping on shares....	44
proper heat of	170	keeping, best plans....	46
question of moisture..	172	keeping, starting	14
setting the machine....	168	keeping, who should es-	
testing the eggs.....	171	say it	12
the hatch	173	packing in ice	239
turning the eggs.....	169	shipping alive	227
why incubator chicks		Profits, conservative and	
die	178	actual	68
Individuality, influence		in poultry	1
of	20	Records, laying and hatch-	
Interior arrangements...	74	ing	10
Laying' competition, Eng-		Removing hen	164
lish	22, 23	Roasters, soft industry..	220
Farm and Home winter	6	Separating sexes	164
Layers, selecting best...	32	Shade	73
to pick out	133	Spurs, removing	44
Lice and mites.....	297	Squabs, Homer's best for.	280
Lice paint	299	house	281
Litter for scratching....	41	mating breeders	284
Manure, care of.....	39	market for.....	280
Marketing, dressing and		Swans, breeding and keep-	
shipping	229	ing	263
ducks and geese.....	232	Table, composition of	
eggs	225	feeds	146
game birds	232	income of hens	6
live poultry	227	loss in weight of eggs	
turkeys	231	during incubation ..	173
Mating for size.....	84	weights of chickens..	207
in-breeding	83, 85	Thoroughbreds, on farm	85
principles of correct...	82	starting with	88
Methods of feeding....	130	value of	87
successful poultrymen	130	Tonic, Douglas mixture..	294
A. F. Hunter's	131	Venetian red.....	303
Prof. G. M. Gowell's..	135	Turkeys, blackhead in..	288
C. H. Wykoff's	137	breeds of	274
W. H. Rudd's	138	dressing	231
Mistakes, very common..	41	herding	271
Milk for chicks.....	163	feed and care of young.	269
skimmilk valuable.▲	127	keeping in confinement.	267
Molt, forcing	38	marketing	231
Nest boxes	50	marking	272
Nests, construction of ..	75	nests for	268
for sitting hens	150	selection and care of..	265
for turkeys	260	setting	269
trap	76	Varieties of poultry	92
Pea fowls	276	Ventilation of houses...	71
Pests, lice and mites...	297	Water for young chicks..	163
Pheasants, rearing	284	Water glass for eggs....	227
Pigeons, housing.....	279	Weights and measures..	142
mating	278	Whitewash	39
Poultry, dressing.....	229	Wings, clipping	42
farm	79	Yards and fences	72
fattening	140	Yolk, color of	44

