

SF523

H568

1922



Cornell University Library

The original of this book is in
the Cornell University Library.

There are no known copyright restrictions in
the United States on the use of the text.

BEE-KEEPING SIMPLIFIED

BY

D. HERROD-HEMPSALL, F.C.S.
FOR THE COTTAGER
AND SMALLHOLDER.



PRICE 1^s. NET

The Bee World

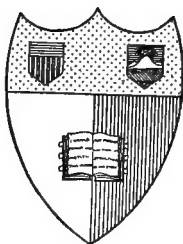

New York
State College of Agriculture
At Cornell University
Ithaca, N. Y.

Library

ngdom,
ference:

Grower, the
s invaluable.
Obtainable
ers, or direct
per copy, or
ial Fee, 10/6)
advantages.

ial Affiliation
ve the paper
per copy, for
Have you

Comb.

Sizes.

, 1922.]

advantageous
tion and the
ceeds that of
ruction which
d a thorough
ith reasonable

taking studies
g and modern
It commands

TON & SONS,
ussex.

BROS.,
nds Road,
inwell, London.

Mr. R. WHYTE, Cumbernauld Station, Dumbartonshire.

*And from other leading manufacturers of and dealers in Bee Hives and Appliances
in Britain and Abroad:*

BEE-KEEPING SIMPLIFIED

FOR THE
COTTAGER AND SMALLHOLDER

BY

WILLIAM HERROD-HEMPSALL,
F.E.S.

Author of "Producing, Preparing, Exhibiting, and Judging
Bee Produce," "Bee-Keeping in War Time."

Late Junior Editor of the "British Bee Journal" and "Bee-keepers' Record"; Hon Secretary, Lecturer, Expert, and Apiarist to the British Bee-keepers' Association; Judge at the Shows of The Royal Agricultural Society of England, The British Dairy Farmers Association, The Royal Lancashire, Lincolnshire, Warwickshire, Essex, Bedford, Cheshire, Norfolk, Tring, Hertfordshire, Cambridgeshire, Cornwall, and Derbyshire Agricultural Societies, and many other Shows throughout the country; Late Lecturer to The Horticultural College for Women, Studley Castle, Warwickshire; The Horticultural College, Swanley, Kent; The Bedfordshire, Middlesex, Lancashire, Nottinghamshire, Lincolnshire, and Hertfordshire County Councils; The School of Light Agriculture, Southgate, London, and many Bee-keepers' Associations.

Apicultural Adviser to the Colonial Office.

Technical Officer on Bee-keeping to the Ministry of Agriculture and Fisheries.

Third Edition.

LONDON:
SIMPKIN, MARSHALL, HAMILTON, KENT & CO., LTD.,
31 & 32, PATERNOSTER ROW, E.C.

All Rights Reserved.

(a)
SF523
H568
1922

@40120

DEDICATED
TO MY GREATEST HELPMATE
WHOSE AID
HAS MADE THIS BOOK POSSIBLE
MY WIFE.

PREFACE.

After repeated requests from friends, readers of "The British Bee Journal" and "The Bee-Keepers' Record," and also from members of the audience at a large number of the lectures which I have given in every part of the British Islands, that I should write a cheap, concise, and up-to-date Handbook on Bee-keeping suitable for the Cottager and Smallholder, and realising that at the conclusion of the present terrible war the country will have to be more self-supporting for its food supply, and that what are now considered small industries, amongst which bee-keeping is included, will obtain their legitimate recognition, I have felt compelled to try and meet their wishes. This small book is the result.

It is not claimed that it is an exhaustive treatise on the subject, but I have endeavoured to give in plain language simple methods of managing bees suitable for those who wish to keep, or who already possess, a few stocks. Having mastered the rudiments of the craft, those who become ambitious may gain further knowledge by reading more advanced works.

Without egotism, I claim that my varied experience during the past twenty-five years, first as a workman in the factories of appliance manufacturers, afterwards as a touring expert, and finally as a teacher and lecturer, being also the owner of a large apiary, enables me to give the advice required from actual experience instead of bolstering it up with theory and useless padding; neither has other writers' matter been cribbed and passed off as my own, which, unfortunately, is the practice of some persons who from mercenary motives try to obtain a reputation for knowledge which they do not possess, and who attempt to foist their purloined goods upon unsuspecting persons.

This book is not written as a means to such an end, and I shall at all times be pleased to explain by letter any point the reader may not quite understand, providing always that my correspondent encloses a stamped addressed envelope for a reply.

I am indebted to and hereby express my thanks for assistance rendered by Mr F. W. Harper for the line drawings contained in this book, as well as the design upon the cover, also for the loan of blocks from Mr. O. C. Jones, Messrs. Jas. Lee and Son, and Mr. W. P. Meadows.

If this book is the means of adding to the ranks of efficient bee-keepers, and enables those already trying to follow the craft with limited knowledge to do better, so that the working class may obtain more creature comforts with the money thus obtained, instead of allowing the foreigner to supply our markets with honey, thus diverting the cash he has hitherto taken from these islands into its proper place—the pocket of the Britisher—my labour will not have been in vain.

WILLIAM HERROD-HEMPSALL.

LUTON,
July 31, 1915.

PREFACE TO THIRD EDITION.

In spite of the fact that the price of the second edition had to be doubled, the demand for this little book has not decreased. I regret that my anticipation of a reduction in price of this edition cannot be realised, owing to the high prices of labour and material which still prevail.

I continue to receive many letters of appreciation; this, together with the fact that the demand for the book has increased, is a satisfaction to me, as it shows its utility and popularity. That it may continue to help the novice is my sincere wish.

WILLIAM HERROD-HEMPSALL.

LUTON,
July 31, 1922.

CONTENTS.

	PAGE
PREFACE	i
I.—CONSTITUENTS OF THE BEE COMMUNITY	1
II.—SKEPS OR STRAW HIVES AND BOXES	7
III.—MOVEABLE COMB HIVES	8
IV.—COMB FOUNDATION AND ITS USES	14
V.—NATURAL SWARMING	15
VI.—SECOND SWARMS, OR CASTS	17
VII.—THE ESTABLISHMENT AND MANAGEMENT OF A STOCK	18
VIII.—SUBDUING AND MANIPULATING BEES	26
IX.—DRIVING	29
X.—UNITING	30
XI.—MAKING ARTIFICIAL SWARMS	31
XII.—FEEDERS AND FEEDING	33
XIII.—WAX EXTRACTING	36
XIV.—OBTAINING HEATHER HONEY	38
XV.—PACKING BEES FOR TRANSIT	41
XVI.—MARKETING HONEY	42
XVII.—WINTERING	44
XVIII.—QUEEN REARING AND INTRODUCTION	45
XIX.—DISEASES	46
XX.—LIST OF APPLIANCES REQUIRED AND THEIR COST	48

ROBERT LEE

Successor to

JAMES LEE & SON, LTD.

BEE-HIVES & APPLIANCES,
STOCKS, SWARMS & QUEENS.

MANUFACTURER OF

BRITISH "WEED" FOUNDATION

Always freshly made all the Season.

DESIGNER & MAKER

OF THE

FAMOUS WEATHERPROOF

UXBRIDGE HIVE

Of which there are upwards of 10,000 in use.

BEGINNERS' OUTFITS A SPECIALITY.

EXTRACTORS, RIPENERS, HONEY JARS,
AND EVERY BEE-KEEPING REQUISITE.

CATALOGUE FREE.

OFFICE AND WORKS:

GEORGE STREET, UXBRIDGE, MIDDLESEX.

Telephone: 181 UXBRIDGE.

Telegrams: "GRAPHICLY, UXBRIDGE."

BEE-KEEPING SIMPLIFIED

FOR THE

COTTAGER AND SMALLHOLDER

I.—THE CONSTITUENTS OF THE BEE COMMUNITY.

To be successful, the bee-keeper, no matter how humble his circumstances, should know a little of the habits and requirements of bees. This knowledge should be obtained *before*, and not *after*, procuring his stock. Practical knowledge gained by one's own experience is excellent, but by obtaining it in this way a great deal of unprofitable time must be spent, and costly mistakes made. The wise take advantage of the experience of others, and read what they have written before commencing any pursuit connected with living creatures.

After studying this small treatise, and a start has been made, the bee-keeper will profit by taking either "The British Bee Journal," 2d. weekly, post free 10s. 10d. per annum, or "The Bee-keepers' Record," 2d. monthly, post free 2s. 6d. per annum, from the office, 23, Bedford Street, Strand. He will also do well to join the local or County Bee-keepers' Association.

In Great Britain there are over two hundred different species of bees, the majority of them solitary, and, with the exception of the honey bee, "*Apis Mellifica*" (which is wild by nature), none are social during the winter. The workers and drones of all the other species die off in the autumn, the queen hibernates during the cold months and commences breeding in the spring.

In the summer the honey bee community is made up of three kinds—one queen, forty to fifty thousand workers, and a few hundred drones, Fig. 1.

The *Queen* is the most important bee in the hive, not because she rules, which might be implied from her name, but because she is a fully developed female, capable of impregnation by the male, after which she can reproduce



FIG. 1.

either sex by laying eggs, which, at will, she either fertilises with spermatozoa originally obtained from the drone and stored in a little sac at the base of and inside her abdomen, or she allows them to pass unfertilised.

In size and appearance the egg is very like a fly-blow, Fig. 2, left side. Enclosed within the shell is a yolk and white as with the hen's egg. In the centre of the end, Fig. 2, right side, is a little hole called the micropyle, through which



FIG. 2.

the spermatozoon enters. The fertilised egg produces the females (workers or queens), the unfertilised produce drones only.

Occasionally, under abnormal conditions of queenlessness, a worker develops the power of laying eggs; these are unfertilised, and produce only males.

In appearance the queen is quite different from the other bees. The abdomen is more slender and tapering, the wings

in comparison to the size of the body are shorter, the back is darker in colour, while the underside of the abdomen has a golden tinge. The natural life of a queen is five years. She is in her prime in the second season, and should not as a rule be kept beyond that period.

A two year old queen is capable of laying from two to three thousand eggs a day. The output of eggs is regulated by the workers. They feed the queen upon digested food, and if an abundance of this is given a large number of eggs are produced, but if the queen is fed sparingly their number is reduced accordingly.

There is but one queen in the hive; a dual monarchy is not tolerated. Rival queens, if present, will fight each other until only one remains. The queen has a sting which is

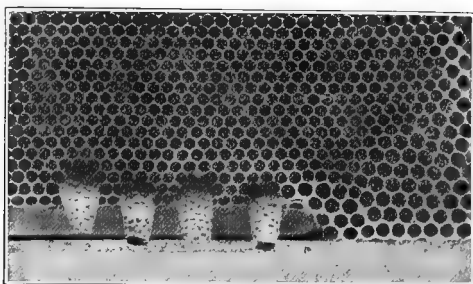

FIG. 3.

curved; it is only used on an adversary. She leaves the hive on two occasions—as a virgin for mating (this when once accomplished lasts for life), and when accompanying a swarm.

Workers are undeveloped females, and are the labourers of the colony. They are small and very active, have a perfectly straight sting which is used in defence of the home and its contents. They gather nectar from the flowers and convert it into honey, store and seal it over in the cells, secrete wax, build the combs, and collect and bring in pollen and propolis. The former, the farinaceous food of bees, the latter, a gummy substance gathered from the buds of trees, used as a cement in the hive for stopping crevices, &c. The duration of a worker's life in the working season is about six weeks, her strenuous labours wearing her out in this short period. Workers born in the autumn having very little work to do live till the following spring.

Drones are the male bees; they are reared in the early Spring which is the natural swarming season. Their sole work is to perpetuate the species by mating with the young queens. Bulky in appearance and heavy in flight, they are easily distinguished. About August, when no longer needed, they are killed off. Having no sting they are an easy prey to the attacking workers. The presence of drones from October to March is an indication of queenlessness, or the presence of an unfertilised queen.

Combs, Fig. 3, are made of beeswax, and a small quantity of pollen. Wax is not gathered, but is secreted in eight little pockets on the under side of the worker bee, Fig. 4. It is made from honey; for its secretion the bees gorge themselves with food, and then hang in festoons in the hive perfectly quiet for twenty-four hours; during that time the food is changed by chemical action into wax, and exudes in a liquid state into the pockets, where it hardens, and is then plucked out, mixed with saliva to make it plastic, and moulded by means of the jaws into cells.

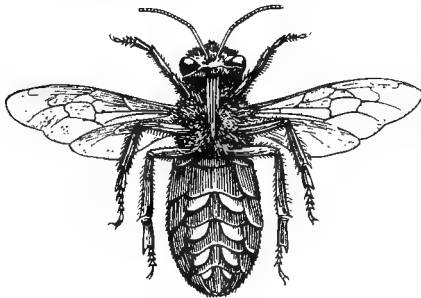

FIG. 4.

The cells of which the combs are made up consist of five kinds—worker, drone, queen, attachment, and transition. The worker cells are the smallest, being one fifth of an inch between the parallel sides. They are six sided, this being the only shape that will fit together without waste of space in which a round body can grow. They are built out horizontally from the midrib, and have a slight upward inclination, so that they retain the grub during its growth, and also the honey when it is stored.

Drone cells are larger, being one quarter of an inch between the parallel sides; in all other respects they are built in the same manner as the workers.

Queen cells are only built during the swarming season, or if by accident the mother is killed or lost. Instead of being horizontal they are pendulous, being about one inch in length, one third of an inch in diameter, and have the

opening at the bottom, while in all other cases the cells open sideways.

Queen cells are made very stout, and consist of wax with a liberal mixture of pollen. They also have upon them a number of depressions or indentations, which, by forming ribs, make the cell stronger, and the cavities allow of porosity.

Transition cells are those between, when drone cells are being merged into worker, or *vice versa*, they are irregular in shape, and are used only for the storage of food. Attachment cells are those by means of which the bees connect the combs to the material upon which they are being built; they are stored with food only.

To produce the worker a fertilised egg is laid in a worker cell; it is incubated for three days, the temperature required being 98 deg. Fahr., then from it hatches a little grub which is fed on pap or digested food for three days. The grub floats in this food, and absorbs it through the skin, as well as the mouth, therefore it grows very rapidly. At the end of three days the grub is weaned, *i.e.*, the food given consists of honey and partly digested pollen instead of the pap. It is fed until it is nine days old, when it is sealed over with a porous capping made from pollen and wax. The creature then passes through all the stages incidental to insect life, *i.e.*, it spins a cocoon, rests, becomes a nymph, and eventually an imago or perfect bee, the time occupied being twenty-one days. On the twenty-second day the worker eats its way from the cell, and in the course of a few hours commences to work, acting for the first fourteen days—during which period it does not leave the hive—as nurse to the grubs in the cells and the adult queen, and drones, making the pap upon which they are fed. At the end of a fortnight it becomes a foraging bee, working in the fields.

Queens are produced, like the worker, from fertilised eggs. A queen cell is built in which the queen lays an egg, or one is carried and placed in it by the workers, or they enlarge the base of a worker cell already containing an egg. This is incubated in the same manner, and for the same period as that which produces a worker. The grub is fed on the same kind of food, but with the difference that no weaning takes place. It is sealed over on the ninth day, and goes through identically the same changes as the worker, except that the time occupied is shorter, being about seventeen days. Being reared in a larger cell, and the grub having the rich food given throughout its existence, a female fully developed in all her organs is produced, capable of mating and reproducing either sex.

Usually, the first princess to emerge goes to the other cells containing her royal sisters, of which there may be any number up to thirty, tears down the side wall, and kills the inmate, thus precluding the possibility of a rival. The princess remains in the hive for five days, after which she leaves on her wedding trip. After marriage she returns to the hive, and within forty-eight hours commences her maternal duties.

Drones are produced from unfertilised eggs, laid in drone cells, incubation taking place as in the case of the worker and queen, and although the egg contains no male stimulus a grub hatches out on the third day, and is fed on pap for four days, when it is weaned. The creature passes through all the stages detailed for worker and queen, the period of

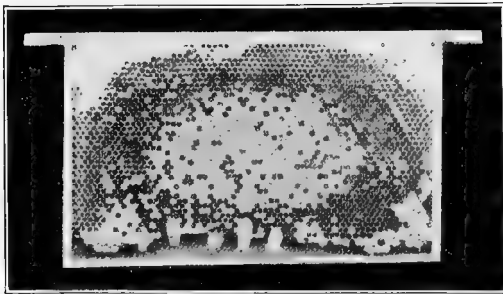

FIG. 5.

development being longer, occupying twenty-four days. On the twenty-fifth day the drone emerges and remains in the hive for fourteen days, when he commences to fly.

The capping covering drone brood stands out very prominently, and by this alone, apart from the size of the cell, it is easily recognised. From capping to capping through the comb, drone cells measure $1\frac{1}{4}$ inches, worker $\frac{7}{8}$ of an inch. The space between the face of combs containing honey sealed over is $\frac{1}{2}$ inch, while between capped brood it is $\frac{3}{8}$ of an inch. Fig. 5 illustrates the different kinds of brood.

In the autumn both worker and drone cells which have been used for brood rearing are gradually filled with honey for consumption during the winter months. The amount of brood reared increases gradually from January to July, from then until November it decreases, until it ceases altogether.

II.—SKEPS OR STRAW HIVES AND BOXES.

The use of these is strongly deprecated, as by having the combs fastened to the main structure they cannot be taken out for examination without breaking them from their attachment; it is impossible to replace them, therefore they are wasted.

Contraction or expansion of the brood nest, and detection of disease in its early stages are also impossible. Queen-rearing and drone-breeding cannot be controlled, and a great many other operations, which are easy of accomplishment with the modern moveable comb hive—to be described later—are debarred in the skep or box hive system of bee-keeping.

If the cottager still persists in following this system—the profits from which are very small compared with the moveable

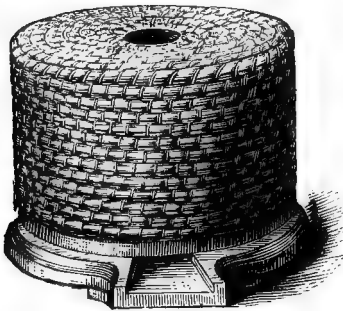

FIG. 6.

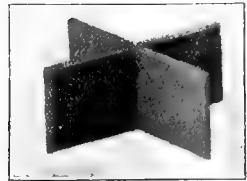

FIG. 7.

comb method—then it is advisable to have the skep as up to date as possible.

A flat-topped one with a hole in the centre should be procured and placed on a proper round floor-board with a projecting piece for an alighting-board, as shown at Fig. 6. A stand is made by halving two nine inch pieces of one inch wood together, Fig. 7. A wooden case, capable of carrying shallow combs or a section rack, made with a solid floor four or five inches from the bottom, inside, having a hole

in the centre to come over the hole in the skep, completes the arrangement, Fig. 8, so that saleable honey can be obtained

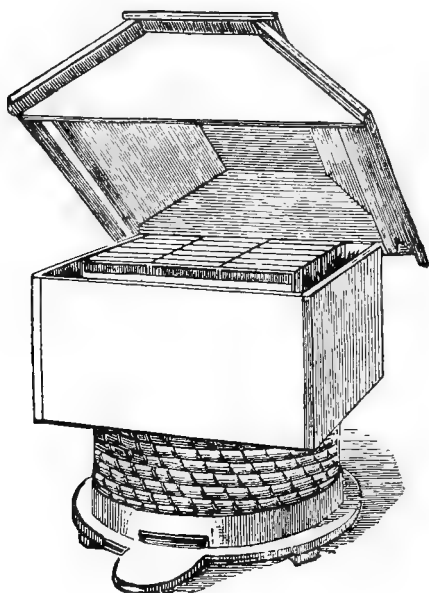

FIG. 8.

without killing the bees or taking it from darkly stained brood comb.

III.—MOVEABLE COMB HIVES.

These hives are made of wood, and are more or less costly according to design. The combs are built in frames so that they are easy to remove. Surplus is obtained by means of extra chambers called supers.

A simple and efficient hive is described and illustrated as

follows:—Fig. 9, No. 1. The floor-board, which has four splayed legs attached, a sloping alighting board at the front for the bees to settle upon; the first board of the floor-board proper is sunken to make an entrance. No. 2 is the brood chamber, which contains ten frames, a division board, and

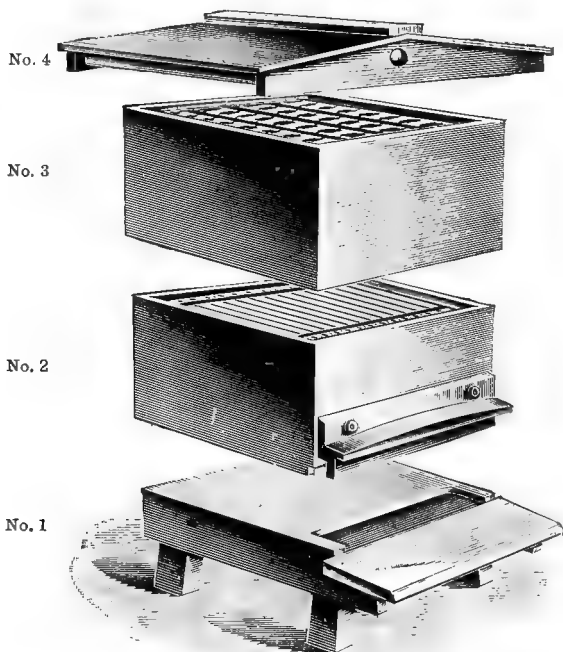

FIG. 9.

a slip of wood $\frac{3}{8}$ inch by 3-16. The division-board is for contracting the size of the brood chamber, and the strip to increase the distance between the face of the end comb and the hive side. This chamber, Fig. 10, is nine inches deep, the outside walls (o.w.) are made of $\frac{3}{4}$ inch material, the inside walls (i.w.), which are on two sides only, are made of $\frac{1}{2}$ inch material, and are secured to the outer wall by

strips of wood (s.) at the top and bottom making an air space (a.s.). The inside walls are $8\frac{3}{8}$ inches deep, and the top strips are placed level with the top edges of the inside walls to allow a metal runner $\frac{1}{4}$ in. deep—Fig. 11, and (m.r.)

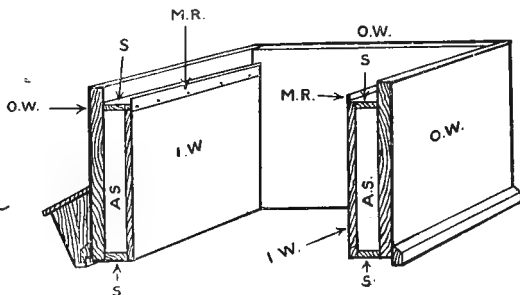

FIG. 10.

Fig. 10—to be nailed on the top to carry the frame tops just level with the outer wall; the metal runner gives the smallest possible contact of surface, and prevents the bees sticking down the frame ends with propolis. This runner also provides a hollow under the ends of the frame top to get the fingers under for lifting, and prevents the killing of bees by crushing when replacing the frames.

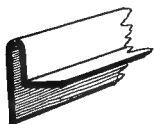

FIG. 11.

On the front of the brood chamber, No. 2, Fig. 9, is a porch, which is detachable, being fastened in position with a couple of screw eyes; the bottom side is grooved to carry two wooden slides by means of which the size of the entrance can be regulated from full-width to one bee space, or closed altogether.

No. 3 is the lift, which is made to fit over the brood chamber. Inside, about $\frac{3}{4}$ of an inch up, are nailed strips of wood $\frac{1}{2}$ inch by $\frac{3}{4}$ of an inch, which rest on the top edges of the brood chamber, holding the lift so that it provides room for the supers. For winter this is reversed, and telescopes down over the brood chamber, Fig. 12, to make it warmer. The roof to keep out the wet is seen at No. 4, Fig. 9. When put together with an additional small lift to give more room the hive is complete, Fig. 13.

As already mentioned, the brood chamber contains ten



FIG. 12.



FIG. 13.

frames. This number will be found the most satisfactory to work with. To obtain interchangeability, so necessary in

many operations, they must be of standard size as established by the British Bee-keepers' Association.

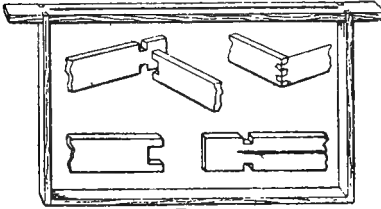

FIG 14

These frames are made of four pieces, which fasten together with lock joints, Fig. 14. The size is as seen at Fig. 15. Length, top bar 17 inches, bottom bar 14 inches, the

depth being $8\frac{1}{2}$ inches. These are all outside measurements. Thickness of top bar $\frac{3}{8}$ of an inch, end bar $\frac{1}{4}$ of an inch, bottom bar $\frac{1}{8}$ of an inch; the width throughout is $\frac{7}{8}$ of an inch. The hive is so made that the frames hang by a projecting piece at either end $1\frac{1}{2}$ inches long, called a lug, or ear; a space of $\frac{1}{4}$ of an inch at the end allows the bees to pass

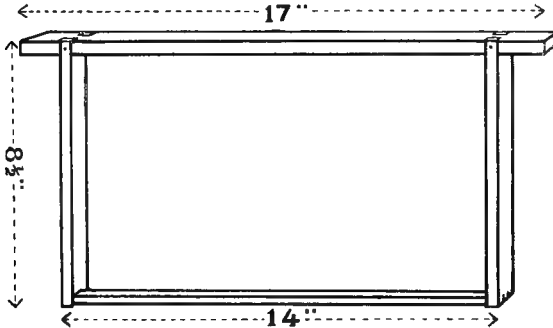

FIG. 15.

round. If made smaller they cannot pass and will propolise the frame end to the side of the hive; if more space is given they will build brace combs between—in either case defeating the object of the frames by making their removal difficult. Between the bottom bar and floor-board a space of $\frac{1}{2}$ an inch is left to allow free passage for the incoming

and outgoing bees, also for the easy removal of the dead, and other refuse, by the scavenging bees. As this space at the bottom of combs is natural to them the bees do not build brace combs.

The outside measurement of the frames as given must conform, without the slightest deviation, to the inside measurement of the brood chamber.

It will thus be seen that the inside measurements of the brood chamber are 9 inches deep, $14\frac{1}{2}$ inches across, between the inside walls parallel with the frames, $17\frac{1}{8}$ inches from rebate to rebate to take the 17 inch top bar, and $15\frac{1}{2}$ inches across the frames.

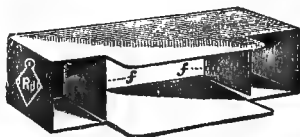

FIG. 16.

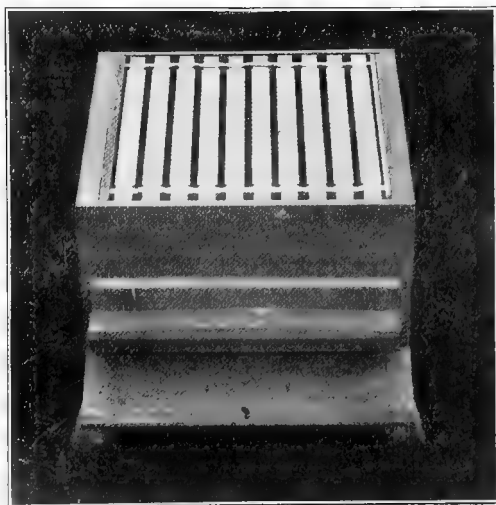

FIG. 17.

The division board is 9 inches deep and $\frac{1}{2}$ inch thick, top bar 17 inches long, 11-16 inches wide, so that it projects on one side 3-16 of an inch, for the proper spacing of the frame next to it. Length of board is $14\frac{1}{2}$ inches, so that it fits tightly into the brood chamber to prevent bees getting behind.

To obtain combs of the right width for brood rearing the frames are spaced $1\frac{1}{2}$ inches from centre to centre by means of a W.B.C. metal end, Fig. 16, pushed on the projecting end. The frames, division board, and slip of wood are seen in the right position, each metal end touching, Fig. 17.

IV.—COMB FOUNDATION AND ITS USES.

Comb foundation is pure beeswax sheeted and impressed with the base of either worker or drone cells. Its use is to get straight combs built in any desired position, and to

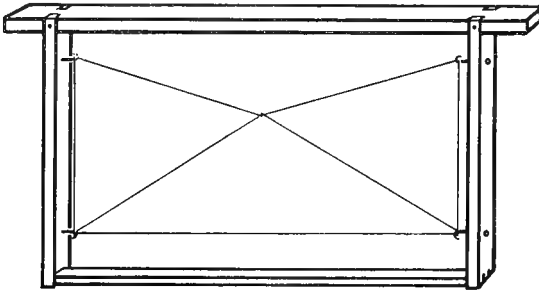

FIG. 13.

control the rearing of drones. Unless the combs are built in the framework designed for them the frame hive is not a moveable comb one. The brood frames should be fitted with full sheets of worker base foundation. Starters, which are narrow strips of foundation fastened to the top bar, should be scrupulously avoided, otherwise a large amount of drone comb will be built and a number of useless drones reared.

To fasten the foundation into the frames it is inserted into a saw cut provided right through the centre of the top bar. This saw cut can be opened easily for the reception of the foundation by driving a couple of headless nails into the bench about $\frac{1}{2}$ an inch apart; the frame is turned upside down, and placed so that the nails fit into the saw cut in the centre; the frame is then given a twist so that the nails come at right angles to, instead of parallel with the saw cut. Being held open automatically in this manner for its reception both hands are free to deal with the foundation.

To prevent the sheet buckling while being forced home owing to the saw cut not being straight through at either end, a piece about $\frac{1}{2}$ an inch wide should be cut off diagonally from the two top corners.

The frame should have thin wire stretched across it, Fig. 18. After the foundation has been placed in position in the saw cut this wire is forced into it by means of a heated spur embedder, Fig. 19. This holds it in position

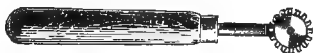

FIG. 19.

and makes the comb stronger when built. Failing such wiring, the foundation should be pushed right through the saw cut about $\frac{1}{2}$ an inch and then bent over alternately from side to side on the top of the top bar with the thumbs, so that it cannot slip out.

The sheets of foundation for brood frames are cut to the right size by the manufacturers. If the frames are wired that weighing ten sheets to the pound is used. If not then it must be thicker, *i.e.*, eight sheets to the pound.

V.—NATURAL SWARMING.

Nature provides for the increase of living creatures in various ways. Colonies of bees are increased by what are termed swarms.

Breeding commences about the last week in January, gradually the population increases until May or June, when the hive becomes overcrowded. This is indicated by the bees hanging in a large cluster at the entrance, especially towards night.

Preparation for the departure of the old mother is made by the building of queen cells, and the rearing of young queens; about three days before the most advanced princess is due to emerge great excitement prevails in the hive. One day, generally between the hours of ten and one, the swarm issues. This consists of from fifteen to twenty-five thousand old bees accompanied by the old queen. They fly round for a time, and eventually settle in a large cluster, as Fig. 20, when they are hived by the bee-keeper, and put into a new home.

If the bees are disinclined to settle, syringe water above, or

throw handful of soil amongst them. As soon as all have collected to the cluster, proceed to hive them. Take a straw skep, or wooden box, hold it bottom upwards under the clustering bees.



FIG. 20.

then with a vigorous shake of the branch upon which they are resting dislodge them so that they fall in a mass into the inverted receptacle. Now turn the skep or box gently over, placing it on a board, sheet, or sack, with one edge propped up at least three inches for ventilation, and to allow the

flying bees to enter, which they will quickly do if the queen has been secured.

When shaking, care should be taken to get as many bees as possible into the skep or box to ensure securing the queen, for if she is left out they will take wing, and the whole operation will have to be repeated. If the swarm clusters in a position from which it is impossible to shake it, fix the empty skep or box above so that one edge just touches the topmost bees; they will then gradually go into it. To prevent the swarm absconding through being overheated, the skep or box containing it should be shaded from the sun by means of a sheet or open umbrella. In the evening they should be taken to their permanent stand, and run into a movable comb hive as described later.

Never dress the hiving receptacle inside with beer, treacle, or other sweet stuffs, as this may cause robbing by other bees.

VI.—SECOND SWARMS, OR CASTS.

A cast or second swarm usually comes out about nine days after the first one has issued. Generally, when bees anticipate casting, all the virgin queens in the cells are allowed to emerge, instead of the remainder being killed immediately the first one is out, which is the case when no further swarming is to take place.

There may be from one to eight virgin queens in a cast, but after hiving one only survives in the eliminating fight. A virgin is also left in the parent colony to become its future mother.

Casts should not be encouraged as they weaken the parent colony, and, apart from the small possibility of their being able, unless fed generously, to establish themselves strongly enough to winter successfully, reduce the old colony's chance of building up strong enough to pass the same period in safety.

Should a cast issue, it is better to return it by running it back at the entrance in the same manner that a swarm is hived. This should be done on the evening of the second day after the cast issued. All the virgin queens will then have emerged and be old enough to fight during the night until only one survives, and no further trouble will ensue.

Casts may be prevented by cutting out all queen cells but the best one immediately after the swarm has issued. If two, or even three casts are joined together they will be more likely to make strong colonies.

VII.—THE ESTABLISHMENT AND MANAGEMENT OF A STOCK.

A swarm, as already described, consists of only the bees and their queen. When they have built combs and are established upon them, the term colony is applied. A stock consists of bees and combs, together with their home.

The best time to commence bee-keeping is in the Spring, with a swarm obtained as early as possible. The hive should



FIG. 21.

be purchased in February so that it may be painted and the internal fittings got ready without undue haste. A position should be chosen facing as near S.E. as possible; the entrance must not be facing a road or path, or there will be the danger of living creatures passing in front being stung by the out-

coming bees. The legs should stand upon bricks, and the hive be set perfectly level from side to side, with a slight

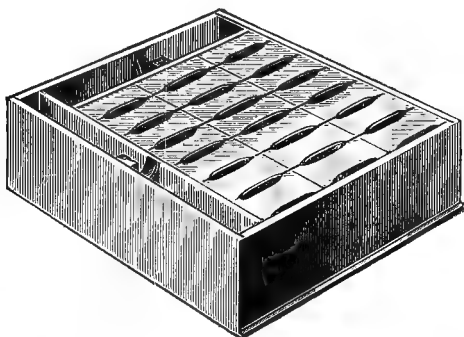

FIG. 22.

downward inclination towards the front to throw out the moisture which accumulates inside.

The frames fitted with full sheets of foundation are placed

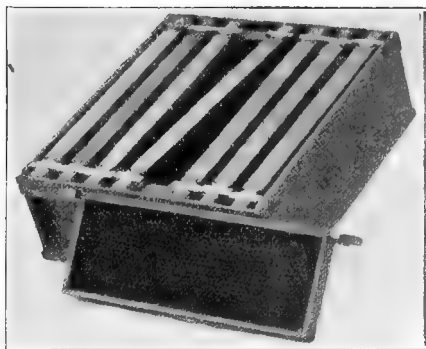

FIG. 23.

in position. A covering, called a quilt, of unbleached calico cut the size of the top of the brood chamber, is laid on the top of them to conserve the heat and to prevent the bees going

up into the roof. The hive is completed by putting on the lift and roof.

The swarm should be hived into the movable comb hive by running the bees in at the entrance. To accomplish this, place a



FIG. 24.

board the same width as the alighting board, and from two to three feet long, sloping from it to the ground; prop up the brood chamber at the front with wedges to give an entrance $1\frac{1}{2}$ inches deep. Take the skep or box in which the bees have been placed temporarily, or in which they have travelled after purchase (if the latter, the enclosing material of cheese-straining cloth or perforated zinc lid must be removed), hold it

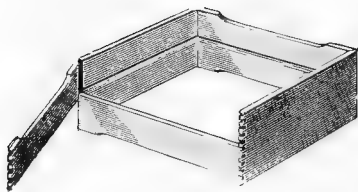

FIG. 25.

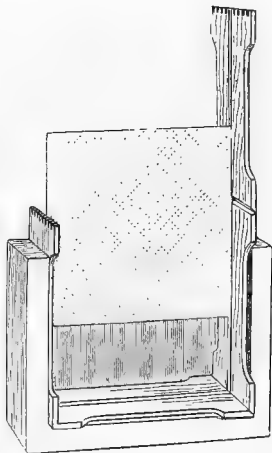

FIG. 26.

between the hands, mouth downwards, about a foot away from the entrance, and with vigorous downward jerks shake the bees out on to the cloth. Their natural inclination of creeping uphill asserts itself, and they travel into the new home very quickly, Fig. 21. It is advisable to watch and see that the queen enters safely. At night the brood chamber is lowered to its normal position. A bottle of white cane sugar syrup must be given over the feedhole in the calico

quilt (see "Feeders and Feeding"). Two additional quilts of thick material, such as felt or carpet, or several neatly folded newspapers, are also placed over the calico and feeder to make the bees snug and warm. Another method, to be adopted only in cold or damp weather, is to remove half the frames, spacing the five remaining ones equal distances apart, then shake the bees in from the top. Swarms should be run into the hive in the evening about six o'clock.

A swarm does not, as a rule, do more the first season than establish itself and store sufficient food for the winter.

The second season the colony reaches full strength about May or June, and unless more room is provided the bees will swarm.

The modern method is to prevent this, and obtain surplus, by giving room in advance of requirements by means of extra chambers called supers. These are of two kinds—section racks Fig. 22, for the production of comb honey, and shallow frame boxes, Fig. 23, to obtain extracted honey. The section rack contains twenty-one sections, which are purchased in the flat, Fig. 24; folded and fastened by lock joints they make a square $4\frac{1}{4}$ by $4\frac{1}{4}$ and 2 inches wide, Fig. 25.

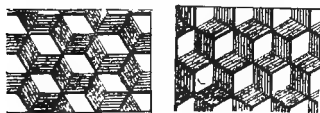

FIG. 28.

There is a groove in the centre into which very thin super foundation is pushed, Fig. 26, and secured by being gripped in the top, which is cut in half for the purpose, Fig. 25, and completed, Fig. 27.

The foundation must be placed so that the rows of cells run parallel with the top as on the right side, Fig. 28, and not diagonally as left side of the same illustration. The sections are placed in the rack in seven rows, three in a row, upon slats to allow the bees to pass into them. Between each row is a divider to prevent the comb from being built beyond the wood-work of the section; Fig. 29 makes this clear.

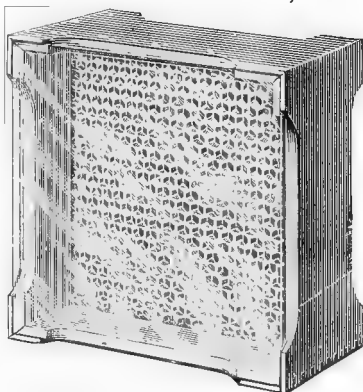

FIG. 27.

The shallow frame super is a box, the same size as the brood chamber, except in depth, which is only six inches, and carries eight frames $5\frac{1}{2}$ in. deep, spaced two inches from centre to centre with a wide metal end.

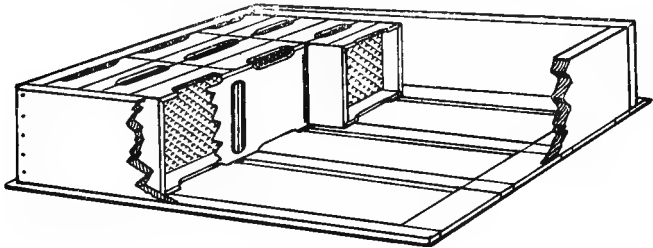

FIG. 29.

To prevent the queen from entering the supers and depositing eggs in the cells, a metal queen excluder, Fig. 30, is placed over the brood chamber, the perforations of which are so accurately made that the workers can pass through, but not the queen. See Fig. 31. The best pattern zinc excluder having the minimum amount of metal is that designed, patented, and sold by E. H. Taylor, Ltd.



FIG. 30.

The super is then put on and covered with the quilts. The bees enter this, build comb, and store honey. When the first super is two-thirds full it is raised and a second one put underneath, and so on to the end of the season.

In Fig. 32 the two kinds of supers are shown on the hive, the section rack being drawn back slightly to show the shallow frame box, while Fig. 33 shows the whole internal arrangement of the hive in section.

When the supers are filled and the honey sealed over, they are cleared of bees for removal by a "Bee"

escape, Fig. 34, which allows them to pass out through the springs, which close and prevent their return. This is fixed into a board, Fig. 35, which is placed under the super to be



FIG. 31.

cleared in the evening, during the night all the bees pass out, so that it can be taken off in the morning and carried indoors. If it is a section rack, all that is necessary is to take out



FIG. 32.

the sections, clean and pack them away ready for sale. If a shallow frame super the honey is extracted; this is done by centrifugal force. The cappings are first cut off with a

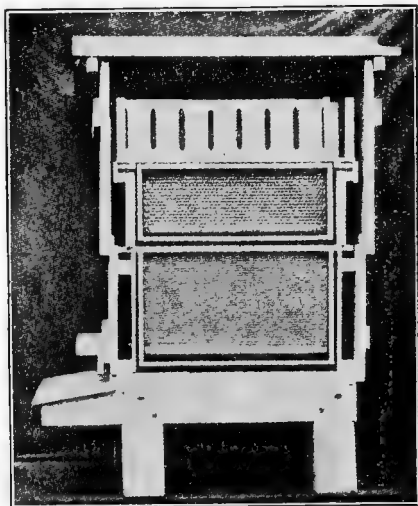

FIG. 35.

sharp knife, which is heated by being placed in a jug of hot water, or knife heater. The W.B.C. knife, Fig. 36, is the best. The method of uncapping is seen at Fig. 37.

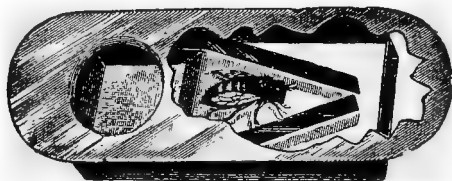

FIG. 34.

After the cappings have been cut off, the combs are placed in an extractor, Fig. 38, which is a tin cylinder, having a cage which will hold one comb on either side, that can be made

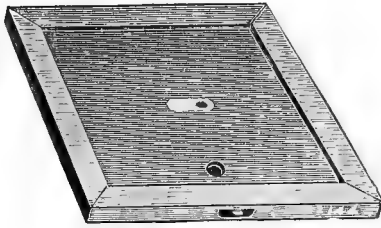

FIG. 35.



FIG. 36.



FIG. 37.

to revolve quickly by means of a handle fastened to the central shaft; in this way the honey is slung from the cells on one side of the comb; they are then reversed and the other side is dealt with in the same manner. The combs should be so placed that when revolved the bottom bar leads. The honey is run out

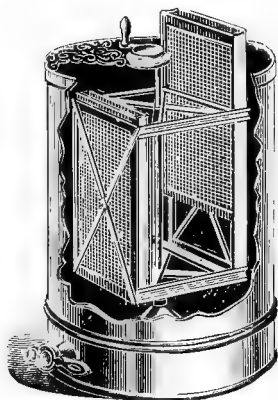

FIG. 38.

through the tap at the bottom into a vessel covered with muslin to strain out the tiny particles of wax; it is then put into tins or jars for selling.

Individual colonies may be supered with either all section racks or shallow comb supers, or they can be worked in conjunction with each other, as shown at Fig. 32.

After the removal of the supers very little work is necessary until the time for wintering, which is described in a later chapter.

VIII.—SUBDUING AND MANIPULATING BEES.

Bees that are full of food are not inclined to sting, unless unduly provoked. The bees constituting a natural swarm are good tempered, because before they issue sufficient food is taken into the stomach to sustain them for four days—a period sufficiently long to allow them to establish a new home. When frightened, they provision themselves so that in case their home is destroyed they may live until another is established.

For this purpose one of two subjugators is used, a smoker, Fig. 39, which is a tin cylinder having a conical nozzle open at the pointed end, and fastened to a pair of bellows with a connection at the back. Brown paper, rag, or fustian is rolled into a cartridge, lighted, and placed in the smoker barrel with the lighted end down; then by working the bellows a volume of smoke issues from the nozzle, which can be driven in any direction. Or a carbolic cloth may be used; this is made by sprinkling a piece of calico the size of the top of the brood chamber with a solution of one part Calvert's No. 5 carbolic acid in two parts of water. It should be rolled up, and when not in use, stored in an air-tight tin to retain its

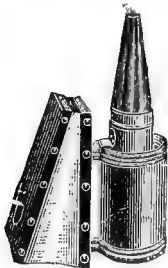

FIG. 39.



FIG. 40.

strength. The smell of smoke driven into the hive, or the fumes from the carbolic cloth laid over the top of the frames after removing the quilt, gives the desired effect.

When manipulating, a bee veil, Fig. 40, should always be worn, but gloves should not be used, as they tend to make the operator clumsy. The bees should be properly subdued before commencing operations. If they get restless before the work in hand is finished a little more smoke should be given, or the carbolic cloth applied again.

Never stand in front of the hive to manipulate, or the bees will be hindered in their work, become angry and sting. When handling or turning the combs, keep them on edge by four movements, shown in Fig. 41. If held flat in warm weather the comb may break down. Bright warm weather should be chosen for opening hives, as then the bees are in a good temper. If opened when cold or wet weather prevails the brood will be chilled and the bees made vicious.

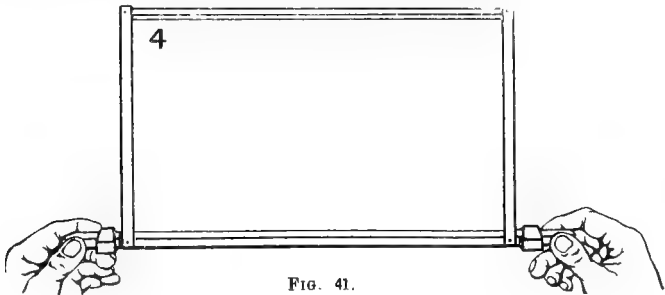
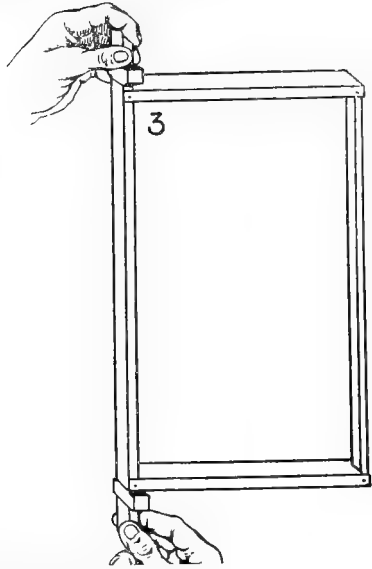
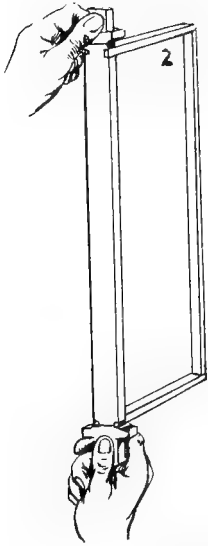
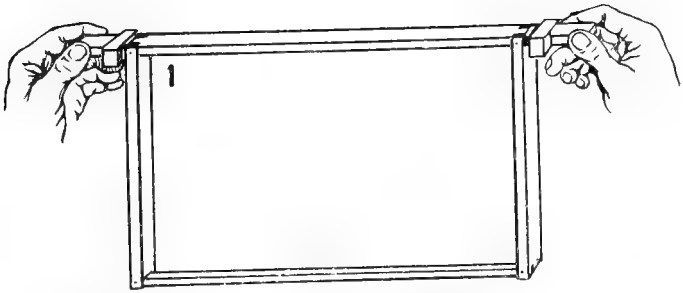

FIG. 41.

IX. DRIVING.

Owing to the decadence of the skep system of bee-keeping, driving is practically a thing of the past. Its object is to get the bees out of the skep or box without killing them.

It is done to make artificial swarms in the spring, in the autumn to save bees which would otherwise be suffocated to obtain the honey; and three or four lots joined together—(see Uniting)—hived upon combs already built in frames, and fed with white cane sugar syrup—(see Feeding)—until they have stored sufficient to maintain them during the winter; they will commence work as a colony the following year.

Driving should be carried out towards evening to avoid robbing. Subdue the bees as already described, then turn the skep or box upside down, taking care to turn it with the combs edgewise, or they may break off. Place it on a table. To keep a dome-topped skep level it will be necessary to stand it in a bucket, which is weighted and made to stand firm by being half filled with water.

An empty skep or box is now fixed on to it in the position of a box lid half open; the two edges are fastened together by pushing a three-inch nail right through the top one into the bottom one at the joint, taking care to make the junction of the two skeps or boxes at right angles to the combs, so that a direct clear passage is left for the bees when they commence to go up.

Driving irons are used on either side. They are made of iron wire, with one and a half inches turned at right angles at either end, or a couple of pieces of wood, with a two-inch nail driven through either end, will do. The driving irons are fixed with one projecting end or nail driven into each skep or box, Fig. 42.

The chink on either side of the joint is stopped by tying a cloth to one driving iron, pulling it tightly round the back, and tying it to the other one as seen in the illustration.

All that is then necessary is to beat with the hands upon the full skep or box. This should be done on the sides to which the ends of combs are attached, as illustrated, and not on the sides to which they run parallel, or the combs will break. By turning the skep or box upside down an uphill position is provided, up which the bees travel quickly, more especially as they are further frightened by the vibration caused by drumming with the hands.

If preferred, close driving may be practised; the operation is the same, except that the empty skep or box is shut close

down on to the full one. With the former it is possible to see and catch the queen, if required, as she passes up. For

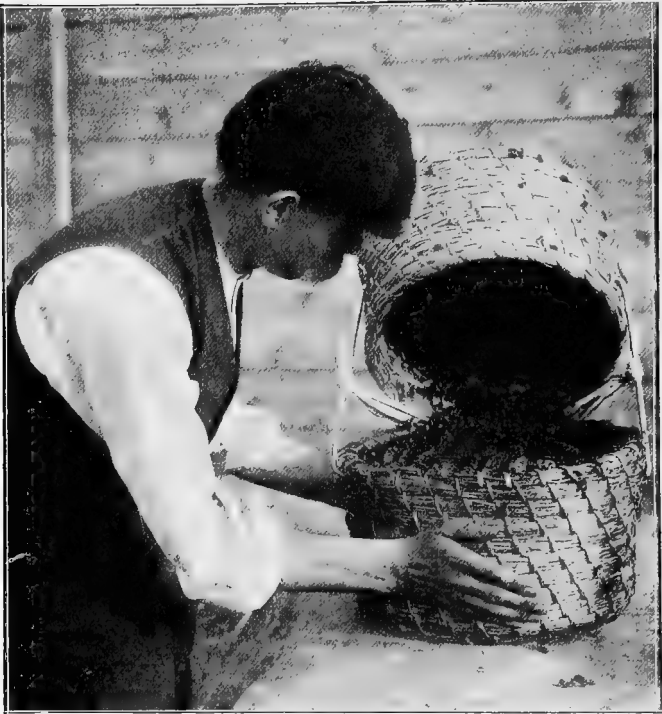

FIG. 42.

this purpose, the operator should stand with his back to the light so that a good view of the passing bees may be obtained.

X.—UNITING.

Colonies which are weak in the spring as a rule do little more than build up strong enough for wintering, while those

weak in the autumn generally die during the winter. At both periods they are unprofitable, and should be converted into strong colonies by uniting. This must be done in such a way that the bees in the separate hives attain the same scent, so that fighting may be avoided.

In the case of skeps or box hives, proceed as follows:— Move one or both the hives containing the bees, in the evening of those days only when they have been flying, not more than one yard per day, until the hives stand side by side. This is necessary, as bees locate position and not the hive; if moved a greater distance at one operation many will be lost by not being able to find their home. When they have stood side by side for a few days, so that the bees have got well used to the new location, drive both lots successively into an empty skep or box, as already described in "Driving." They will unite peaceably on account of the undue excitement caused by driving, and also because they are full of food. Then treat as a swarm, by running them in the usual way into the hive which is to remain. The queens may be allowed to fight it out as to which remains, or the worst one can be caught and destroyed when driving.

With a movable comb hive the same process of moving is followed. All the combs not covered by bees are removed from each hive; the worst queen is caught and destroyed; for safety the remaining one should be caged. (See Queen Introduction.) The bees on both sets of combs are then well dusted with ordinary flour, one set spaced wide apart, and the others lifted and put in between; the empty hive is taken right away. The flour—which should be used lavishly—imparts the same odour to all, and the interspacing of the combs mixes the bees thoroughly, so that no fighting takes place. Uniting should be carried out in the evening when all the bees are at home. The caged queen must be liberated twenty-four hours after uniting.

To unite driven bees with an established colony, remove five combs from the latter, shake off the bees and place them in a fresh hive, standing close by, hive the driven bees on to these combs, and allow them to work for a week, when they can be united as described above.

XI.—MAKING ARTIFICIAL SWARMS.

This can be accomplished with both skeps or box hives, and movable comb hives.

The principles to remember are that bees locate position,

and not the hive, that young bees are the best for queen rearing, and that it is the old bees and old queen which constitute a natural swarm. It is also obvious that artificial swarms should only be made from strong, healthy colonies, and at a time when natural food is being obtained in abundance. The operation should be carried out on a day when the bees are flying freely.

With a skep or box hive drive out the bees until the queen is found, put her with about a pint of bees in a fresh hive placed on the old stand, run back the remainder of the driven bees into the original skep or box and remove it to another position. The flying bees will join the queen, and the young bees of the parent colony will rear a fresh mother. If the swarm is to be sold, place the queen and pint of bees in a swarm box, instead of a hive, on the old stand. This is closed at night, and despatched the next day, the stock being put back in its original place.

For a movable comb hive, prepare a hive with its full complement of brood frames, fitted with full sheets of wired foundation. Find the queen in the colony, and place the comb on which she is located, with the adhering bees, into the centre of the fresh hive, having previously removed a frame for this purpose, and cover with the quilts. Push the combs in the parent hive close together, and place the frame of foundation so that it is the last one at one side; cover with the quilts, and remove it some little distance away, putting the fresh hive in its place. Should bad weather follow, feed both the parent and swarm.

Instead of the above method, several colonies may be used to make an extra one. One example of how to do this is given below. A larger or smaller number than those given may be utilised. The operator should remember that the greater number of colonies used the fewer brood combs must be taken from each.

To make one colony from three: From each of two remove three combs of brood, brushing back the bees, and replacing the combs removed by frames fitted with foundation placed on the outside of the brood nest. Put the six combs of brood in the centre of the fresh hive, with two frames of foundation on either side to make the full number of ten; cover with quilts. Remove the third stock, which has not been, and should not be, opened, to a new position; place the fresh hive where it stood. Thus two colonies supply the brood and one the bees. The new lot is allowed to rear a queen, or one may be introduced.

XII.—FEEDERS AND FEEDING.

It is sometimes necessary to feed bees. At times they place all the honey gathered in the supers, leaving the brood chamber with very little stored in it. As it is possible to actually see the amount of food stored in movable combs, instead of having to guess at the weight—as was the case under old-fashioned conditions—many colonies, which would otherwise perish, can be saved by supplying a little extra food.

Feeding can be done at all seasons if necessary. In the early spring stimulative feeding is carried out by means of the regulation bottle-feeder, Fig. 43, or by giving about one-quarter of a pint of syrup every third night, in a wide-necked jam jar, with a double thickness of muslin tied over the top. Fig. 44, or in a rapid feeder, Fig. 45. A feed-hole is made in the calico quilt by cutting



FIG. 43.

on three sides of a square about three inches, so that a flap is made to turn down to prevent the bees escaping when a feeder is not in use. The jar is inverted over the feed-hole, and the bees suck the syrup through the muslin.

The food should be given at night, and should be new milk warm. It is also made thin, as bees require a lot of water in the spring for rearing brood, which is the object of slow feeding. If there is a continual slow supply of food coming in, the queen lays more continuously. If the food is given too rapidly it does harm instead of good, as they store it in those cells which should be left for the queen to lay in. It is also harmful to give syrup when there is an abundant supply of natural food in the combs. In such a case for stimulation it is only necessary to bruise the cappings of the honey just round the brood patch on each comb. Artificial pollen should be supplied by putting Symington's Pea Flour on hay chaff, sheltered from the wet in a box in the garden.

Stimulative feeding is also carried out with newly-hived swarms for about a week or ten days to help them to build combs quickly. In those districts where there is a break between the honey flows, such as fruit blossom and clover, it is

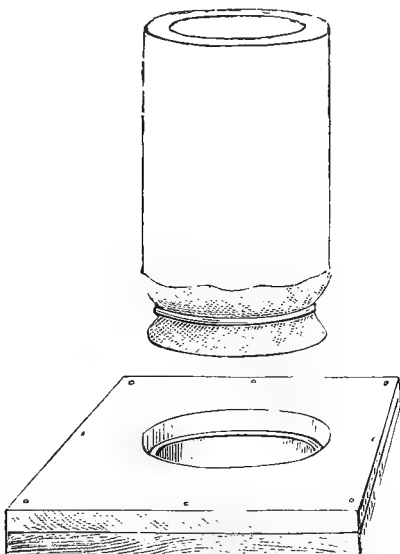

FIG. 44.

often desirable to give stimulative food for the production of combs in preparation for the second crop of honey.

In the autumn those colonies which require food should have it given to them slowly, so that they may rear more brood, and also store and seal some of it in the cells. At the end of September the full complement of food should be made up by means of a rapid feeder, Fig. 45. There are different forms of these, but the principle is the same in all, *i.e.*, the bees are allowed free access to the syrup, so that they can take it as quickly as they desire, provision being made to prevent them from drowning. The syrup for rapid feeding and for slow feeding in the autumn is made thicker than that for the other periods of the year. It should be stored and sealed over with

as little water in it as possible, so that the danger of dysentery from too much liquid is reduced to a minimum. In all cases when syrup feeding, the entrance to the hive should be closed to one bee space to avoid robbing. The food given in the

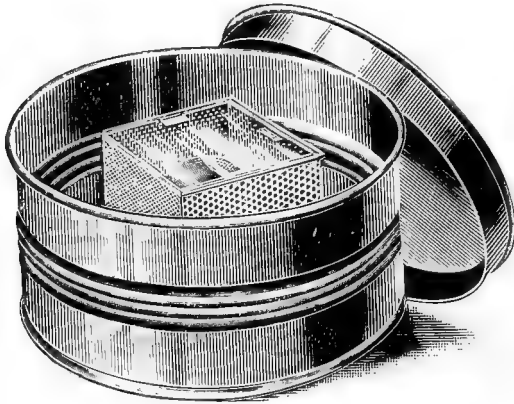

FIG. 45.

winter is candy, which is placed over the feed-hole. It is moulded in a glass-topped box or in saucers lined with paper, so that without disturbing the bees it is an easy matter to see when the candy is exhausted. The different foods are made as follows:—

Spring and Summer Syrup—

5lbs. white lump cane sugar.
 $3\frac{1}{2}$ pints water.
 $\frac{1}{2}$ oz. vinegar.
 $\frac{1}{2}$ oz. salt.

Autumn Syrup—

5lbs. white lump cane sugar.
 $2\frac{1}{2}$ pints water.
 $\frac{1}{2}$ oz. vinegar.
 $\frac{1}{4}$ oz. salt.

These ingredients should be put in a saucepan and placed over the fire, stirring continually until all the sugar is dissolved, when it is ready for use.

Candy.—Have a clean pan, for preference a brass preserving one, into which put 3lbs. of best white lump cane sugar and half-pint of water, together with as much cream of tartar as can be heaped up on a sixpenny bit. Stand beside the fire, stirring occasionally until the sugar is dissolved, then place on the fire and stir continually until the mass boils; allow it to boil for about a couple of minutes, then remove from the fire, and stand the pan in another vessel containing cold water until the sugar begins to cloud, then stir well and pour into the prepared glass-topped boxes made by glazing one side of a section, or into the saucers lined with paper, so that when cold it can be lifted out in a block. When set it should be a moist solid mass easily cut into with the finger nail.

Candy given in January should have about a quarter of a pound of pea flour mixed with the above quantity. This is best done during the cooling process. The flour should not be poured in all at once, but lightly sprinkled in while stirring, so that it mixes evenly right through the candy.

To medicate any of the above when dealing with Foul Brood, add to each pound of sugar as much Naphthol Beta as can be heaped on a threepenny bit. Dissolve this in sweet spirit of nitre, whisky, or methylated spirit, and add when the syrup or candy is cooling, not when it is hot.

XIII.—WAX EXTRACTING.

Many shillings are wasted by the bee-keeper neglecting to save old combs and scrapings from the hives. These should be carefully kept in an air-tight box until a quantity is collected, and then melted by any of the following methods.

Pollen-clogged combs should be broken up, well soaked in rain water, and as much pollen as possible washed out. The mass is then tied up in a cheese straining cloth and sunk by means of weights in a copper filled with rain water; hard water will spoil the colour of the wax. The water is then boiled, when the wax will melt, percolate through the straining cloth and float on the top; when cold it will set in a cake and can be lifted off, the bottom scraped free from dross and sent to the manufacturer to be made into foundation. If the mass in the cheese strainer is squeezed with the end of a stout piece of wood while boiling, the wax will come away quicker, and more will be obtained than if no pressure is employed.

Another method is to get a large shallow tin, put a partition of perforated zinc across the centre, break up the combs to be melted, and put sufficient on one side of the zinc to cover the bottom, cover with a sheet of glass, and stand it facing the sun; the half containing the comb should be raised at least six inches; this can be done by putting a brick under one end. The sun's rays striking the glass will generate sufficient heat to melt the wax, and it will be strained by running through the perforated zinc. The dross is then cleared out and a fresh lot of comb put in. Too much comb must

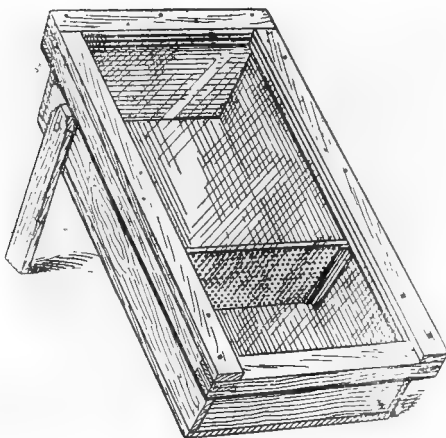

FIG. 46.

not be put in at one time, or the wax will not run freely from the waste.

A solar wax extractor, Fig. 46, may be purchased, and, although it entails expense, the amount spent is soon saved by the extra wax obtained which would otherwise be wasted.

Another method is by means of steam. An extractor, Fig. 47, consists of a bottom pan, which is filled with rain water. On the top of this fits another pan, with a false bottom held about one inch clear from the sides by means of stays. On this bottom stands a perforated tin cage, in which the pieces of comb are placed. The lid is put on and the extractor put on the fire; the team from the boiling water

in the lower vessel melts the wax; it runs out of the perforated cage down to the false bottom, the edges of which stand up about half an inch. The wax is conveyed to the outside by means of a spout connected to the bottom on which the cage stands.

The wax may then be moulded into different sized cakes for selling. Moulds for making cakes of varying size can be made by boring holes in a piece of hard wood the requisite size to hold, say, 1oz., 2oz., 3oz., etc., of wax; these can then

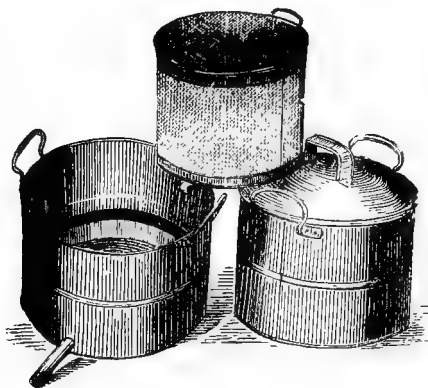

FIG. 47.

be retailed to customers, but the best value is obtained, as previously stated, by having the wax made into foundation.

In all cases when wax is being melted it should be done in a vessel standing in another containing rain water. If the vessel containing wax is placed in direct contact with the fire or oven shelf it will be blackened and its texture spoilt.

XIV.—OBTAINING HEATHER HONEY.

Heather honey is obtained principally in Scotland, Wales, and the northern counties of England. The heather harvest is derived from the common ling of the moors about August, when all other crops are over, and it is not unusual for the bee-

keeper to move his stocks seventy miles to obtain heather honey, which realises double that of ordinary honey.

Where heather honey can be obtained it is necessary to use a special hive so that plenty of ventilation is provided, to avoid suffocating the bees when travelling. That made by Robert Lee, of Uxbridge. Fig 48, is an ideal one, as ample ventilation

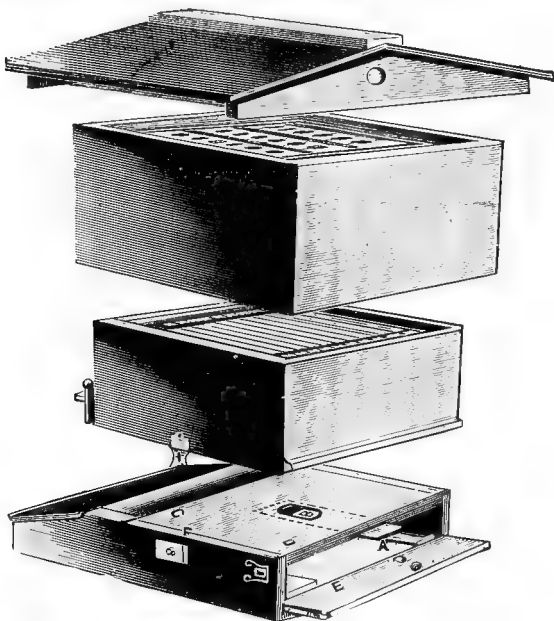

FIG. 48.

is provided in the floor board. The hives should not have legs, so that they can be packed close together for transit, and should be light and strong. Only strong colonies with an abundance of food and old wired combs should be sent to the moors. The bees should travel by night, so that they are kept cool. The conveyance must have springs, and the hives be placed on it so that the ends of the combs are towards the horse, or if taken by rail or motor car towards the engine. This prevents

them swinging about, which is likely to occur if placed the opposite way. See that everything is made secure previous to starting, and before liberating the bees upon arrival at the moors take the horse right out of the way to avoid an accident by stinging.

Combs already drawn out should be used in the supers, and it is best to work for sections only, as on account of its gelatinous nature it is impossible to extract heather honey by centrifugal force. The only way is to squeeze it from the combs by wrapping them in muslin or cheese-straining cloth. They are then placed

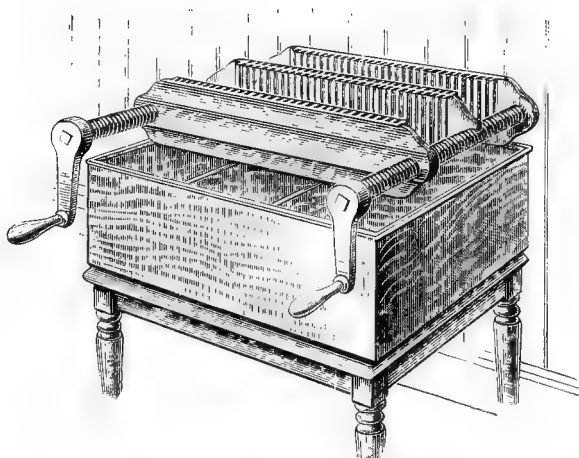

FIG. 49.

between the grooved plates of a press, Fig. 49; pressure is applied by screwing these together as tightly as possible, when the honey runs out. Shallow combs are too valuable to be spoilt in this way.

Uncompleted sections from the clover harvest should be extracted and used in the racks at the heather; those which are fully completed can then be sold intact, while the unfinished ones can be extracted by squeezing.

It is necessary to wrap the bees down well when at the moors, to keep up the temperature of the hive during the cold nights of autumn.

XV.—PACKING BEES FOR TRANSIT.

If a swarm of bees has to travel by road or rail in a skep it should be confined by tying over the mouth a piece of very open material, such as cheese straining cloth. The skep must travel mouth upwards, or the bees will be suffocated. Make a rough framework, and pack it as Fig. 50. The same method is

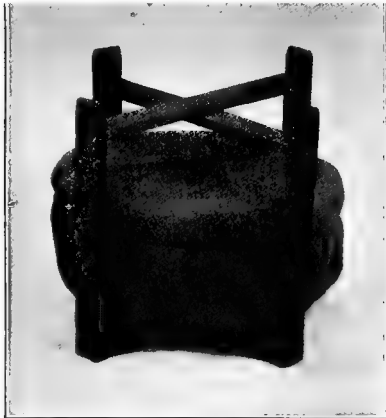

FIG. 50.

adopted with a stocked skep or box hive, with the addition of securing the combs by pushing wood skewers through them and the hive sides several days before removal, so that the bees may attach the combs to them.

It is better to send a swarm in a box, Fig. 51, the top and bottom of which is covered with perforated zinc, so that an abundance of ventilation is provided. Swarms should always be fastened up at night on the day of issue, and sent off the next morning before they have time to build combs.

To prepare a colony in a movable-comb hive for travelling, make a frame of one inch wood to cover the top of the brood chamber; remove the quilts and screw this frame firmly on to the sides of the hive, so that it holds the frames tightly to prevent them moving. Cover this by tacking on cheese straining cloth or

perforated zinc, which provides ventilation, and also allows the bees to collect on the top of the frames if they get overheated. Secure the brood chamber to the floor board by means of screws, put on the lift and roof (no quilt) and tie securely with stout string or fine rope. At night, when all the bees are

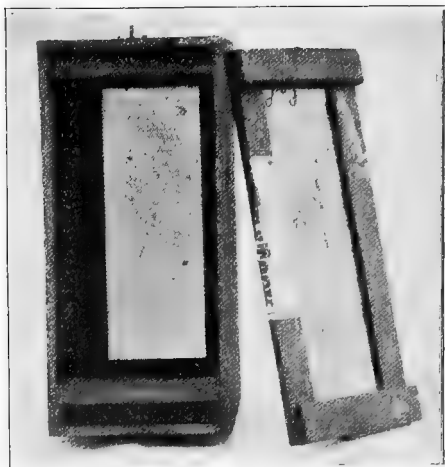

FIG. 51.

in, tack a piece of perforated zinc over the entrance; they are then ready to travel. To avoid disaster, never attempt to send bees in any kind of a hive on new combs, neither when very strong, nor yet in hot weather. The combs in movable comb hives should always be wired.

XVI.—MARKETING HONEY.

To obtain the best prices and regular customers, honey must be put up in a clean, neat, and attractive manner.

Sections should be graded into best and seconds, according to filling, sealing, etc. All incomplete ones should be extracted and saved for use the following season. After scraping the

woodwork of the sections free from propolis, those selected for sale should be protected from dust, and the visits of flies, etc., by being glazed, or cardboard boxes, with glass on both sides into which the sections fit, Fig. 52, may be used.

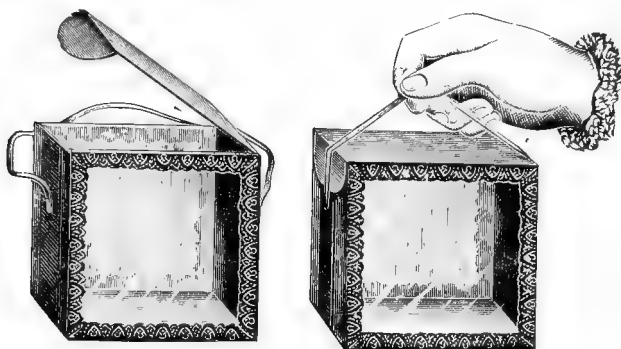

FIG. 52.

When sections are sent to the purchaser in dozen lots, a spring travelling crate, Fig. 53, should be used. If a larger quantity, they should be wrapped in paper, tied in half-dozen, and packed in Tate's cube sugar boxes, which hold three dozen, and allow for ample packing with straw. If sold unglazed, they should be wrapped and tied as described above with a piece of thin wood or cardboard $4\frac{1}{2}$ in. square at each end of the package to prevent the comb being damaged while packing.

Honey in shallow combs should be graded into light, medium and dark, and extracted separately, the light fetching the best price.

If mixed, only a medium quality is secured. The dark can be sold at a low rate, thus a better average price is obtained than if all were mixed together. After straining through

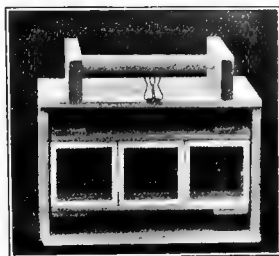

FIG. 53.

muslin the honey is put into clean one-pound or half-pound screw-cap jars; tie-overs, being messy, should not be used. For a single dozen a box, Fig 54, can be made, while larger

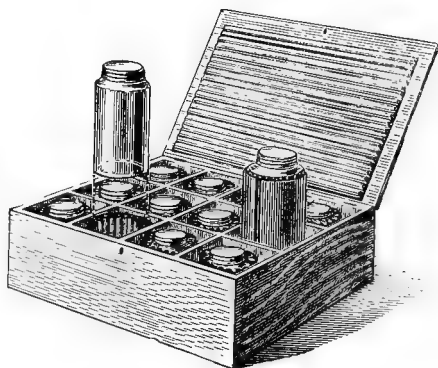

FIG. 54.

quantities are sent in Tate's cube sugar boxes, with plenty of packing, each jar being wrapped in a separate piece of paper. If sold in bulk the honey is run into tins, each holding twenty-eight pounds ($\frac{1}{4}$ cwt.).

Much depends upon the grading, cleanliness, neatness and packing in obtaining and retaining customers.

XVII. WINTERING.

The requirements for successful wintering are: (1) Plenty of bees; (2) a young prolific queen; (3) plenty of food; (4) a dry warm home.

Plenty of bees are secured by re-queening and stimulative feeding after the honey harvest. Honey from brood combs should not be touched for sale purposes, as it is the best food for wintering. The necessary quantity of food is eight combs well filled and sealed over. If the bees are short of this it should be made up by white cane sugar syrup given in a rapid feeder—see Feeders and Feeding—not later than the end of September.

Winter passages are given by laying a couple of pieces of wood, half an inch thick, over the top of the frames, under the calico quilt.

Naphthaline should be placed in the brood chamber and amongst the quilts. Extra wrappings are given, folded newspapers being excellent for the purpose.

If any doubt exists as to the supply of food being sufficient give a cake of candy.

The roof must be made water-tight, and secured by driving a stake down at one side of the hive, to which a cord is tied, then passed over the roof and a brick tied on the other end, so that it just swings clear of the ground. The entrance is opened to six inches.

Should snow fall it must be cleared from the roof and alighting board, and a shade board reared in front of the entrance to prevent reflected light from the snow entering the hive and attracting the bees out to their death.

An occasional look at the candy, and the dead bees cleared from the inside of the entrance by means of a hooked wire, is all the attention required during the winter.

All that can be done with skeps or box hives is to wrap them up warm and dry.

XVIII.—QUEEN REARING AND INTRODUCTION.

It is unnecessary for the owner of only a few stocks to follow an elaborate system of queen rearing, but he should see that all his colonies contain young vigorous queens. The best queens are those secured under the natural swarming impulse.

Make careful notes to find out which colony has the desired qualities, *i.e.*, the best workers, docile and good in constitution.

The second or third season bring the selected colony to swarming point, and when the queen cells are sealed over cut them out, and put one in each cage of a nursery frame, Fig. 55. The cages are made by cutting a number of square blocks of wood, through which a $1\frac{1}{2}$ inch hole is bored, covered on either side with perforated zinc or wire cloth. A hole is bored in the top of the block to take a cork. The cages are made to fit into a brood frame, the cells being fastened to the corks with molten wax and placed in the cages. The frame is then put in the centre of a colony until the queens emerge, when they are introduced to the colonies to be re-queened.

In introducing a queen, be sure that the colony has been queenless for twenty-four hours, then place the queen with a few attendant workers under a pipe cover cage, Fig. 56, and fasten it on to a comb over food by screwing the metal rim at

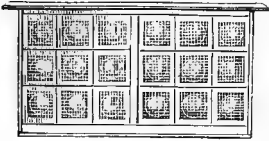

FIG. 55.

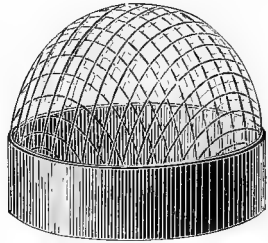

FIG. 56.

the bottom into the cells. In this way the queen is protected from the alien workers by the wire cloth covering until she attains the odour of the hive, so that when liberated at the end of twenty-four hours she will be accepted, whereas, if not caged, she would be killed immediately she was put in.

XIX.—DISEASES.

The most important disease is that called "Isle of Wight." Bees so affected soil the alighting board and entrance to the hive, and also the inside, with excreta. A number of bees will be found creeping on the ground and up the surrounding herbage, others collect in small clusters, and all are unable to fly. An examination of these will show that in many cases the wings are dislocated and the abdomen badly distended. The bees generally die off very quickly. If the colony is strong, it may be saved by introducing an imported fertile Italian queen. As the disease spreads rapidly, if the affected colony is weak, it is advisable to destroy the bees *at once* and spray the combs with Bacterol. They should not be used again for at least a month.

Foul Brood is another disease. When attacked the adult bees are listless, and much of the brood will be found dead in the cells. Instead of being quite white and curled up like the letter C the grubs will be elongated and of a buff colour,

in its advanced stages the cappings are sunken and have irregular perforations, while in the cell a ropy putrid brown mass will be found. Fig. 57 shows an affected comb. In some cases an offensive odour like decomposed glue is given off.

If there are few bees and the disease very bad, suffocate the bees and burn the combs, bees, quilts, etc., in a hole dug in the ground. When all is consumed fill in the hole with earth.

Should the population be numerous use "Apicure"—if persevered with, and used as stated in the instructions, the disease will disappear. All food should be medicated—see Feeders and Feeding.

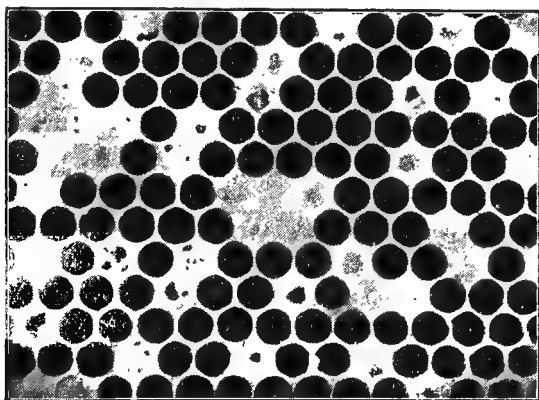

FIG. 57.

Dysentery is another disease caused by damp hives, unsealed food having an excess of water, and bad ventilation. The signs are soiling of the combs, and inner walls of the hive, the excreta in this case being of a very liquid character (in "Isle of Wight" it is of a pasty nature). Dysentery generally makes its appearance in the early spring.

To cure, move the bees into a clean well-ventilated hive, remove all the combs not covered by bees, and feed with warm thick syrup.

To disinfect hives in which bees have died from disease of any kind, scorch the inside with a painter's blow lamp.

Where disease is present avoid interchanging combs, prevent robbing, and wash all appliances used in strong "Izal." Also

be careful not to go to a healthy colony after handling a diseased one before removing propolis from the hands with methylated spirit, and well washing them and the appliances used with a strong disinfectant.

XX.—LIST OF APPLIANCES REQUIRED AND THEIR COST.

	Prices.	
	Lowest.	Highest.
	£ s. d.	£ s. d.
1. Hive having 10 standard frames and division board	1 4 0	2 9 0
2. Bottle feeder and stage	2 6	2 6
3. Weed brood foundation one pound...	3 2	3 2
4. Smoker	4 6	6 0
5. Section rack fitted with sections, dividers, and foundation	7 0	8 0
6. Shallow Frame Box and frames ...	6 0	6 0
7. Half-pound drone base foundation for shallow frames	1 7½	1 7½
8. Honey extractor	2 3 6	5 10 0
9. Veil	2 3	3 0
10. Swarm	1 10 0	2 10 0

If the bees are worked for sections only it will not be necessary to have an extractor. The hive can also be made at home at small cost by anyone with a little mechanical ability. The veil can also be made cheaply at home. A makeshift bottle-feeder as described is quite successful. After a colony is once well established increase can be made without further cost for bees. After establishment the average profit is 30s. per stock.

TAYLORS

Bees, Hives and Appliances.

TAYLORS COTTAGE OUTFIT

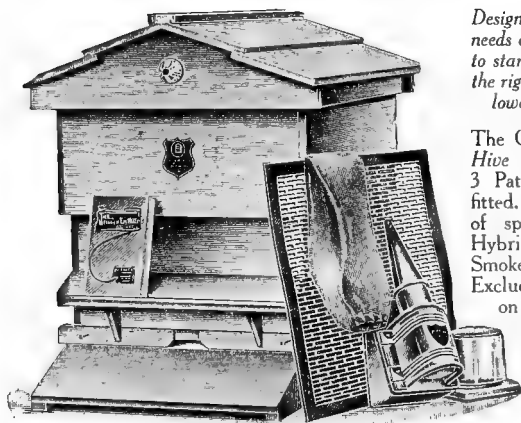

Designed to meet the needs of those who wish to start Bee-Keeping on the right lines, but at the lowest initial cost.

The Outfit includes :
Hive of Taylors No. 3 Pattern completely fitted. Bees, a nucleus of specially selected Hybrids or Italians, Smoker, Bee Veil, Queen Excluder, Feeder, Book on Bee-Keeping.

The largest Bee Appliance Manufacturers in Europe. This tells its own story.

*Write for our large Illustrated Catalogue.
No Beekeeper should be without it.*

E. H. TAYLOR, LTD. BEEHIVE WORKS, WELWYN, HERTS.

ISLE OF WIGHT, ACARINE, FOUL BROOD AND OTHER BEE DISEASES.

Don't wait for bee disease to appear. It is far better and far cheaper to prevent it by using "General Bacterol"—the cheapest insurance against disease.

Whether it be Protozoa, Bacteria or Mite use "General Bacterol," and you will be very pleased with the result. Follow the advice given below, because

THERE IS A SCIENTIFIC REASON FOR EVERY PROCEDURE ADVISED.

Medicate each pint of syrup with two teaspoonfuls of "General Bacterol." Stir in when syrup is just warm or tepid. Remove all stores of honey before feeding.

Better still, remove all honey and after medicating as above, feed back to bees.

Cover one side or both sides of a division board with cotton wool half-inch thick, and attach by wire netting to board. Saturate wool with undiluted "General Bacterol," and place in hive. The vapour from this will disinfect foul brood and the breathing passages of the bees. If more rapid action is necessary, saturate wool with "Vaporising Bacterol" each day.

During hot months—spray two or three times daily all crawlers on alighting board and in front of hive with a solution of one tablespoonful of "General Bacterol" to one quart of water. Use a mist sprayer obtainable from any Bee Appliance Manufacturer—not an ordinary syringe.

For foul brood.—Simply spray with a mist sprayer the 5 per cent. solution of "General Bacterol" right into the cells so that there are no spots untouched. Do this daily for three days, and where cells are sealed over reliance must be placed upon using "General Bacterol" or "Vaporising Bacterol" on a division board as mentioned in the directions above. The vapour from this will penetrate the capping over the brood.

All excreta and woodwork of hive can be scientifically disinfected by well spraying with a 5 per cent. solution (four tablespoonfuls to quart of water) of "General Bacterol." No need to burn off paint.

"Bacterol" cannot do any harm: It can only do good. Bees like it.

"General Bacterol" is obtainable from most Bee Appliance Makers, the office of the BRITISH BEE JOURNAL, or direct from Bacterol, Ltd., Price 2/- per half-pint bottle, post free 2/9; per quart bottle 6/-, post free 7/-.

Pamphlets and all information relating to the seven types of "Bacterol" which completely cover the fields of Antisepsis and disinfection of human beings and animals, and the disinfection of the habitations of both, will be willingly supplied by

BACTEROL LTD.,
19-25, Brookside Road, Upper Holloway, LONDON, N.19



“OUR BEES ARE GENTLE.”

This stock was opened and combs distributed without the use of smoke or other subjugator, and was the first time these children had handled bees.

Our Motto :

“Quality first, Quality last, and Quality all the way in between.”

Our Endeavour :

“To produce the best possible Stock, and give the greatest possible value.”

Our Reputation :

The Editor of the “British Bee Journal” says :

“Mr. Claridge has a reputation second to none for the quality of the nuclei sent out by him, and the same may be said of his queens. Nothing better than the ‘Claridge Quality’ nuclei can be obtained, a three-comb nucleus having all three combs packed with brood. . .”

Vide B.B.J., March 10th, 1921.

Brochure free from :

F. M. CLARIDGE

(Breeder of Pure Italian Bees),

Copford Apiary, Nr. Colchester.

The "B.B.J. Ideal" Candy-Making Thermometer

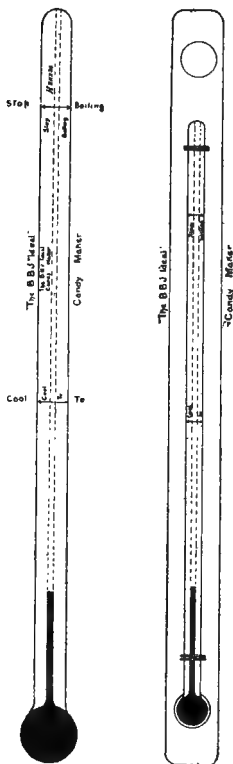

FIG. 1.

FIG. 2.

This thermometer has been specially designed for making candy for bee food. In place of the usual scale progressing by two degrees, there are only two marks on the scale. The top mark shows the temperature to which the candy should be boiled. The bottom one when it is cool enough to commence stirring.

These are both engraved *on the glass* and are *accurate*. There are no calculations to be made as on the ordinary sugar boiler's thermometer with a full scale of degrees, which are not always accurate. A recipe for candy and full directions are sent out with each instrument. Any other candy recipe may be used. The thermometers can only be obtained from this office. As they are being sold at cost price it is not possible to supply appliance dealers.

Fig. 1, plain glass tube, price 4s.

Fig. 2—Thermometer in brass case, 5s., packed in a neat cardboard case, postage 3d. We recommend the brass frames, as the tube being protected, it is not so likely to be broken. The frame is also plain, neat and easily cleaned.

"British Bee Journal" Office,

23, BEDFORD STREET, STRAND, LONDON, W.C.2.

J. T. BURGESS & SON

Guinea Street, EXETER

Established 1863.

Inventors and Manufacturers of
"UP-TO-DATE" BEEHIVES & BEEKEEPERS' APPLIANCES
necessary for the production of Pure Honey on modern principles.

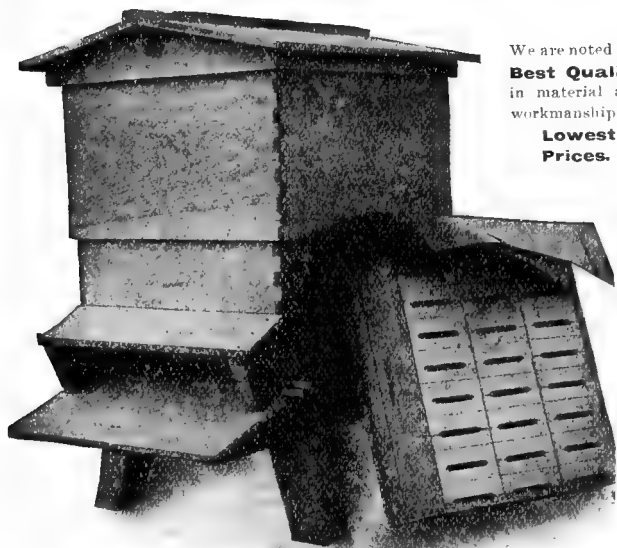

We are noted for
Best Quality
in material and
workmanship at
Lowest
Prices.

HIVES from 30/- to 70/-

For particulars see Catalogue, which will be sent post free on application.

HONEY EXTRACTORS, HONEY RIPENERS, WAX EXTRACTORS, QUEEN
EXCLUDERS, SWARM CATCHERS, &c., &c.

WE are Makers of all Kinds of
BEE HIVES & APPLIANCES for
BRITISH STANDARD FRAMES.

We also specialise in the making of
LANGSTROTH, DADANT-MODIFIED
and other American Hives.

All of the finest material and workmanship.

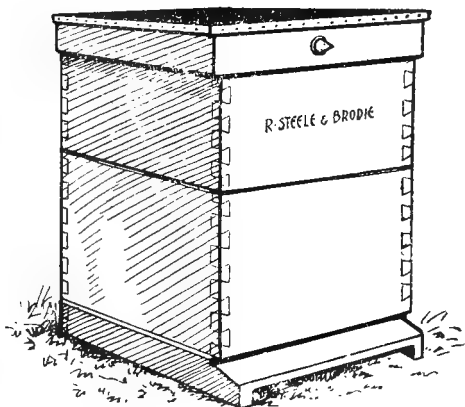

Our "Wormit" Commercial Hive.

DADANT'S NEW WIRED BROOD FOUNDATION.

The greatest invention of the age. All ready wired to put
into frames. Old method of wiring entirely superseded.

Send for sample pound.

Illustrated Catalogue sent post free on application.

R. STEELE & BRODIE,
(Bee Appliance Works),
WORMIT, FIFE, SCOTLAND.

"The Herrod Apicure."

SIMPLE ! CLEAN ! EFFICIENT !

For the Prevention and Cure of Foul Brood and other Diseases of Bees.

Don't delay—order and use at once.

Price, with full instructions, 1/8, 2/10, 5/8, per tin, post free.

From all the leading Appliance Manufacturers, and from

"British Bee Journal" Office.

No Bee-keeper can afford to be without a copy of

Producing, Preparing, Exhibiting, and Judging Bee Produce.

Write for a copy at once, and study it. You will be well repaid when you bring into practice the many useful hints you have found in its pages.

Beautifully Printed on Fine Art Paper, with 131 Illustrations.

Paper Covers, 2/- net, postage 3d.,
from the British Bee Journal Office.

The Dissectible Model of the Queen Bee

will enable you to study the anatomy without a costly microscope—plain and practical—with each part numbered and named, folding into its proper position.

Price 4/6, post free 4/9 from

**BRITISH BEE JOURNAL & RECORD OFFICE,
23, Bedford Street, Strand, W.C.2.**

The ONLY Two PRACTICAL Papers in the BRITISH ISLANDS

No Bee-keeper can afford to be without one or both of these papers, which deal with the most modern and advanced methods, and apply science and theory to approved and profitable practice. These papers are read by all the best Bee-keepers and Traders, and therefore prove the most profitable media both for display advertisements, and for Sale or Exchange paragraphs. Technical matters simply explained, and experiences of Bee-keepers in all parts of the world given. Answers to correspondents in need of advice, in the columns, a speciality. Urgent matters answered by post or telegram.

The British Bee Journal Established 1873.

Weekly Twopence, post free 10/10 per annum. *The Only Weekly Bee Paper in the World.* Edited by T. W. COWAN, F.L.S., F.R.M.S., &c., &c., and J. HERROD-HEMPSALL, F.E.S. Articles, some exclusive and copyright, contributed regularly, and answers to correspondents, by the best practical writers of the day.

The Bee-keepers' Record Established 1882.

Monthly Two Pence, post free 2/6 per annum. Edited by T. W. COWAN, F.L.S., F.R.M.S., &c., &c., and J. HERROD-HEMPSALL, F.E.S. A Paper written by Bee-keepers for Bee-keepers. It also contains Association Notes and News, Bee-keeping for Women, &c.

Can be obtained of all News Agents, most Secretaries of County Bee-keepers' Associations. Send us your address on a post card and we will post you a specimen copy of either free for your inspection.

Office: 23, Bedford Street, Strand, London, W

Cornell University Library
SF 523.H568 1922

Bee-keeping simplified for the cottager



3 1924 003 621 939

mann

