

Cornell University Library

BOUGHT WITH THE INCOME
FROM THE
SAGE ENDOWMENT FUND
THE GIFT OF
Henry W. Sage
1891

A.92156

21/4/96

Cornell University Library

QL 805.L26 1891

v.2

Text-book of comparative anatomy.



3 1924 024 558 284

olin

QW

805

h26

1891

V.2

TEXT-BOOK
OF
COMPARATIVE ANATOMY



TEXT-BOOK
OF
COMPARATIVE ANATOMY

BY

DR. ARNOLD LANG

PROFESSOR OF ZOOLOGY IN THE UNIVERSITY OF ZURICH
FORMERLY RITTER PROFESSOR OF PHYLOGENY IN THE UNIVERSITY OF JENA

TRANSLATED INTO ENGLISH BY

HENRY M. BERNARD, M.A. CANTAB.

AND

MATILDA BERNARD

PART II.

London

MACMILLAN AND CO., LTD.

NEW YORK: MACMILLAN & CO.

1896

A. 92156

~~9711882~~

TRANSLATORS' PREFACE

THE fact that this second volume of the translation appears four years after the first is due partly to the delay in the issue of the third and fourth German parts of which it is composed, and partly to the increased difficulty in the work of translation. A comparison of the two volumes will show at a glance that the work has developed under the hands of the author: the treatment has become more elaborate. The two "chapters" which practically fill this volume are in reality more like comprehensive treatises on the groups with which they deal, and as such could only be adequately translated from the German by some one with a very special knowledge of both groups. There are probably few zoologists who have attempted to make a special study of two such heterogeneous phyla as the Mollusca and the Echinodermata. In addition, therefore, to frequent references to the original literature and to constant applications to kind friends, the whole of the text relating to the two chief groups was submitted to specialists for revision. The translators beg to tender their warmest thanks to their friends who kindly undertook this laborious task. Mr. B. B. Woodward read the text of the chapter dealing with the Mollusca, revising the terminology, and suggesting slight alterations, which have been either adopted without comment in the text or else placed in short footnotes. Mr. W. Percy Sladen and Mr. F. A. Bather revised the text dealing with the Echinodermata, each with special reference to the group with which his name is most associated. Thanks are also due to Professor Jeffery Bell for his kind assistance in the solution of difficulties. We have no hesitation in saying that it is to the generous help of these gentlemen that

our translation owes much of the value it may possess for the English student.

In the use of certain technical terms we have given the English or the Latin form indifferently, *e.g.* pinnule or pinnula, auricle or auricula, with deliberate inconsistency. On the other hand, we have throughout used the terms madreporite, madreporitic, and Echinodermata, although some authorities are more in favour of madrepore, madreporic, and Echinoderma. We feel it our duty to call the attention of students to these points.

The following author's preface is a free translation of the *Nachwort* which appeared at the end of the fourth German part. In it the author answers the only serious charge against the work as a text-book which has been brought to our notice. It finds its most appropriate place as a preface to the second volume of the translation.

H. & M. BERNARD.

AUTHOR'S PREFACE TO THE SECOND VOLUME

WITH the publication of the last two chapters, dealing with the Echinodermata and the Enteropneusta—that is of the fourth German portion—I bring this text-book to a close for the time being, as a comparative anatomy of the Invertebrata.

I feel that some excuse is necessary for the tardy appearance of the separate parts, especially of the third (Mollusca). This was mainly due to my call to the University of Zurich, where official duties left only the holidays and vacations for my own work. When I add that the greater number of the illustrations were drawn by my own hand, the reader will, I trust, pardon the lapse of time. Indeed, if he be a trained zoologist, he will be specially sympathetic and indulgent, and will be able to realise my feelings as I watched the fresh relays of books piling up before me at the commencement of each new chapter. Original sources alone have been relied upon for the subject matter of the work.

In spite of the imperfections and deficiencies of which I am only too conscious, the book appears to have been found useful, judging from the favourable reception almost universally given to it, and from the circumstances that, even during its appearance, it was translated into foreign languages.

I am fully aware that the matter is unequally worked up. The divisions treated in the first volume are too briefly dealt with, a defect which must be remedied in a new edition. Any criticisms or advice with which my colleagues may favour me will be gladly accepted in the spirit in which they are intended.

I have been blamed by many for not mentioning the names of

authors in the text. From the very first this question caused me much perplexity, and I made repeated attempts to indite single chapters so as to bring in the historical development of the branch dealt with, together with the names of the most important authors. I then found that if this course were pursued the book would attain twice its present dimensions, that is, if strict impartiality were to be invariably observed. This latter I was resolved on no account to renounce, and I therefore determined to exclude from the text the names of all authors without distinction. Any one who is interested in knowing how a special question stands, can easily find his bearings by careful comparison of the text with the illustrations (the origin of which is everywhere given), and by consulting the literature. I have convinced myself of this among my own students.

I must here express my thanks to my honoured and dear friend, Mr. Gustav Fischer, for the care and patience he has exercised in connection with this work.

ARNOLD LANG.

ZÜRICH, *July* 1894.

CONTENTS

CHAPTER VII

MOLLUSCA

	PAGE
<i>Systematic Review</i>	2
Class I. AMPHINEURA	2
II. GASTROPODA (CEPHALOPHORA)	3
III. SCAPHOPODA	13
IV. LAMELLIBRANCHIA (PELECYPODA, BIVALVA, ACEPHALA, AGLOSSA)	14
V. CEPHALOPODA	21
I. ORGANISATION OF THE PRIMITIVE MOLLUSC	26
II. REVIEW OF THE OUTER ORGANISATION CHARACTERISING THE CHIEF GROUPS OF THE MOLLUSCA	28
A. PLACOPHORA OR POLYPLACOPHORA (CHITONIDÆ).	29
B. APLACOPHORA, SOLENOGASTRES	29
C. GASTROPODA (CEPHALOPHORA)	30
D. SCAPHOPODA	34
E. LAMELLIBRANCHIA	34
F. CEPHALOPODA	36
III. THE INTEGUMENT, THE MANTLE, AND THE VISCERAL DOME	39
A. PLACOPHORA	39
B. SOLENOGASTRES	41
C. GASTROPODA	42
D. SCAPHOPODA	49
E. LAMELLIBRANCHIA	49
F. CEPHALOPODA	53
IV. THE SHELL	55
A. AMPHINEURA	58
B. GASTROPODA	58

	PAGE
C. LAMELLIBRANCHIA	61
D. CEPHALOPODA	67
V. ARRANGEMENT OF THE ORGANS IN THE MANTLE CAVITY, AND OF THE OUTLETS OF INNER ORGANS IN THAT CAVITY	71
A. GASTROPODA	71
B. SCAPHOPODA	80
C. LAMELLIBRANCHIA	81
D. CEPHALOPODA	81
VI. THE RESPIRATORY ORGANS	84
THE TRUE GILLS OR CTENIDIA	84
A. AMPHINEURA	86
B. GASTROPODA	88
C. LAMELLIBRANCHIA	91
D. CEPHALOPODA	96
ADAPTIVE GILLS	97
LUNGS	99
VII. THE HYPOBRANCHIAL GLAND	101
VIII. THE HEAD	101
A. GASTROPODA	102
B. SCAPHOPODA	104
C. CEPHALOPODA	105
IX. THE ORAL LOBES OF THE LAMELLIBRANCHIA	105
X. THE FOOT AND THE PEDAL GLANDS	106
A. AMPHINEURA	106
B. GASTROPODA	107
C. SCAPHOPODA	112
D. LAMELLIBRANCHIA	112
E. CEPHALOPODA	115
XI. SWELLING OF THE FOOT (<i>Turgescence</i>)	118
XII. MUSCULATURE AND ENDOSKELETON	119
A. AMPHINEURA	120
B. GASTROPODA	120
C. SCAPHOPODA	123
D. LAMELLIBRANCHIA	124
E. CEPHALOPODA	126
XIII. THE NERVOUS SYSTEM	128
A. AMPHINEURA	128
B. GASTROPODA	132

CONTENTS

xi

	PAGE
1. THE AREAS OF INNERVATION OF THE VARIOUS GANGLIA .	133
2. ORIGIN OF THE CROSSING OF THE PLEUROVISCERAL CON- NECTIVE (CHIASTONEURY)	135
3. SPECIAL REMARKS ON THE NERVOUS SYSTEM OF THE GAS- TROPODA	137
C. SCAPHOPODA	142
D. LAMELLIBRANCHIA	143
E. CEPHALOPODA	145
XIV. AN ATTEMPT TO EXPLAIN THE ASYMMETRY OF THE GASTROPODA	149
XV. THE SENSORY ORGANS	162
A. INTEGUMENTAL SENSORY ORGANS	162
1. TACTILE ORGANS	162
2. OLFACTORY ORGANS	162
3. THE "LATERAL ORGANS" OF THE DIOTOCARDIA	165
4. GUSTATORY ORGANS	166
5. SUBRADULAR SENSORY ORGAN OF CHITON	166
6. THE SENSORY ORGANS ON THE SHELL OF CHITON	166
B. AUDITORY ORGANS	167
C. VISUAL ORGANS	169
1. OPTIC PITS	169
2. OPTIC VESICLES OR VESICULAR EYES	170
3. THE EYE OF THE DIBRANCHIATE CEPHALOPODA	170
4. THE DORSAL EYES OF ONCIDIUM AND THE EYES AT THE EDGE OF THE MANTLE IN PECTEN	173
5. THE EYES ON THE SHELL OF CHITON	175
6. THE COMPOUND EYES OF ARCA AND PECTUNCULUS	175
7. DEGENERATION OF THE CEPHALIC EYES	176
XVI. THE ALIMENTARY CANAL	176
A. BUCCAL CAVITY, SNOUT, PROBOSCIS	178
B. THE PHARYNX AND JAWS, THE TONGUE AND SALIVARY GLANDS	180
FORMATION OF THE RADULA	183
C. THE OESOPHAGUS	187
D. THE MID-GUT WITH THE STOMACH AND DIGESTIVE GLAND (LIVER)	190
1. AMPHINEURA	191
2. GASTROPODA	192
3. SCAPHOPODA	193
4. LAMELLIBRANCHIA	194
5. CEPHALOPODA	194
E. HIND-GUT (RECTUM)	195
XVII. THE CIRCULATORY SYSTEM	198
A. GENERAL	198

	PAGE
B. SPECIAL	201
1. AMPHINEURA	201
2. GASTROPODA	201
3. SCAPHOPODA	206
4. LAMELLIBRANCHIA	206
5. CEPHALOPODA	208
XVIII. THE BODY CAVITY	211
XIX. THE NEPHRIDIA	215
A. AMPHINEURA	216
B. GASTROPODA	217
C. SCAPHOPODA	221
D. LAMELLIBRANCHIA .	221
E. CEPHALOPODA	222
XX. GENITAL ORGANS	225
A. GENERAL	225
B. SPECIAL	227
XXI. PARASITIC GASTROPODA	244
XXII. ATTACHED GASTROPODA	218
XXIII. ONTOGENY	248
A. AMPHINEURA	248
B. GASTROPODA	252
XXIV. PHYLOGENY	268
<i>Review of the most Important Literature</i>	269
APPENDAGE,—RHODOPE VERANII	281

CHAPTER VIII

ECHINODERMATA

<i>Systematic Review</i>	285
CLASS I. HOLOTHURIOIDEA	285
II. ECHINOIDEA	288
III. ASTEROIDEA	295
IV. OPHIUROIDEA	299
V. PELMATOZOA	302
1. CRINOIDEA	302
2. CYSTIDEA	313
3. BLASTOIDEA	314
I. GENERAL MORPHOLOGY OF THE ECHINODERM BODY	315
II. MORPHOLOGY OF THE SKELETAL SYSTEM	317

CONTENTS

	PAGE
INTRODUCTION	317
A. THE APICAL SYSTEM (Calyx)	319
1. ECHINOIDEA	319
2. ASTEROIDEA	326
3. OPHIUROIDEA	327
4. PELMATOZOA	328
(a) CRINOIDEA	328
(b) BLASTOIDEA	330
(c) CYSTIDEA	332
B. THE ORAL SYSTEM OF PLATES	333
C. THE PERISOMATIC SKELETON	337
1. HOLOTHURIOIDEA	337
2. ECHINOIDEA	338
(a) THE NUMBER OF THE VERTICAL ROWS OF PLATES	339
(b) THE PORES OF THE AMBULACRAL SYSTEM	340
(c) THE SYMMETRY OF THE ECHINOID SHELL	340
(d) THE RELATION OF THE AMBULACRAL AND INTERAMBULACRAL PLATES TO THE PERISTOME	344
(e) MANNER IN WHICH THE SKELETAL PLATES ARE CONNECTED	345
(f) SPECIAL MODIFICATIONS OF THE AMBULACRA	346
(g) SPECIAL MODIFICATIONS OF THE INTERRADII	348
(h) FORM OF THE PERISTOME	349
(i) ORNAMENTATION	349
(k) MARGINAL INCISIONS OR PERFORATIONS	349
(l) THE PERIGNATHIC APOPHYSIAL GIRDLE	350
3. ASTEROIDEA	351
(a) THE AMBULACRAL SKELETON	351
(b) THE INTERAMBULACRAL SKELETON	353
(c) THE ACCESSORY SKELETAL SYSTEM	354
(d) COMPARISON OF THE PERISOMATIC SKELETON OF THE ASTEROIDEA WITH THAT OF THE ECHINOIDEA	355
4. OPHIUROIDEA	355
(a) SKELETON OF THE ARMS	355
(b) THE ORAL SKELETON	358
5. CRINOIDEA	362
(a) THE PERISOMATIC SKELETON OF THE CALYX	362
a. THE APICAL CAPSULE OR DORSAL CUP	367
b. THE TEGMEN CALYCIS	369
(b) THE BRACHIAL SKELETON	370
(c) THE STEM (COLUMNA)	373
(d) THE MANNER OF CONNECTION BETWEEN THE SKELETAL PIECES	376
(e) THE NERVE CANALS OF THE ARMS AND OF THE APICAL CAPSULE	377

	PAGE
(f) THE WATER PORES	377
6. BLASTOIDEA	379
(a) THE AMBULACRAL SKELETON	379
(b) THE STEM	384
7. CYSTIDEA	384
D. THE SPINES AND THEIR DERIVATIVES—THE SPHERIDIA AND THE PEDICELLARIE	387
E. THE MASTICATORY APPARATUS OF THE ECHINOIDEA. (Aristotle's Lantern)	400
F. THE CALCAREOUS RING OF THE HOLOTHURIOIDEA	403
G. FURTHER DEPOSITS OF CALCAREOUS MATTER	405
H. CONCLUDING REMARKS ON THE SKELETON	405
III. THE OUTER MORPHOLOGY OF THE HOLOTHURIOIDEA	406
IV. THE POSITION AND ARRANGEMENT OF THE MOST IMPORTANT ORGANS IN THE RADII	409
V. THE INTEGUMENT	414
VI. THE WATER VASCULAR SYSTEM	416
A. THE MADREPORITE AND STONE CANAL	417
B. THE WATER VASCULAR RING	423
C. THE RADIAL CANALS, THE CANALS OF THE TENTACLES AND TUBE-FEET, ETC.	426
D. THE AMBULACRAL APPENDAGES	431
VII. THE CÆLOM	436
A. THE BODY CAVITY	437
B. THE BRACHIAL CAVITIES	440
C. THE PERIGESOPHAGEAL SINUS	441
D. THE PERIANAL SINUS	444
E. THE AXIAL SINUS	444
F. THE AXIAL ORGAN	445
G. THE CHAMBERED SINUS	446
VIII. THE PSEUDOHÆMAL SYSTEM	447
IX. THE EPINEURAL SYSTEM	448
X. THE BLOOD VASCULAR OR LACUNAR SYSTEM	449
XI. THE NERVOUS SYSTEM	453
A. THE SUPERFICIAL ORAL SYSTEM	454
B. THE DEEPER ORAL NERVOUS SYSTEM	458
C. THE APICAL OR ABORAL NERVOUS SYSTEM	459
D. THE THIRD NERVOUS SYSTEM OF THE CRINOIDEA	461

CONTENTS

	XV
	PAGE
XII. THE SENSORY ORGANS	462
A. THE AMBULACRAL APPENDAGES AS SENSORY ORGANS	462
B. NERVE ENDINGS IN THE INTEGUMENT	466
C. AUDITORY ORGANS, ORGANS OF ORIENTATION	468
D. EYES	468
XIII. THE BODY MUSCULATURE	470
A. HOLOTHURIOIDEA	471
B. ECHINOIDEA	471
C. ASTEROIDEA	472
D. OPHIUROIDEA	474
E. CRINOIDEA	474
XIV. THE ALIMENTARY CANAL	474
A. GENERAL REVIEW	474
B. HOLOTHURIOIDEA	476
C. ECHINOIDEA	479
D. CRINOIDEA	481
E. ASTEROIDEA	483
F. OPHIUROIDEA	485
XV. RESPIRATORY ORGANS	485
A. THE (INNER) RESPIRATORY TREES OF THE HOLOTHURIOIDEA	487
B. REVIEW OF THE RESPIRATORY ORGANS OF THE ECHINODERMATA	487
XVI. THE CUVIERIAN ORGANS OF THE HOLOTHURIOIDEA	488
XVII. EXCRETION	489
XVIII. THE SACCULI OF THE CRINOIDEA	489
XIX. GENITAL ORGANS	490
A. GENERAL MORPHOLOGY	490
B. HOLOTHURIOIDEA	491
C. ASTEROIDEA	492
D. OPHIUROIDEA	494
1. THE BURSE	494
2. THE GENITAL APPARATUS	495
E. ECHINOIDEA	498
F. CRINOIDEA	500
G. ORIGIN OF THE SEXUAL PRODUCTS	501
H. HERMAPHRODITISM IN ECHINODERMS	501
1. CARE OF THE BROOD AND SEXUAL DIMORPHISM	502
XX. CAPACITY FOR REGENERATION AND ASEQUAL REPRODUCTION	504
XXI. ONTOGENY	506
A. THE VARIOUS LARVAL FORMS OF THE ECHINODERMATA	506

	PAGE
B. ONTOGENY OF THE HOLOTHURIOIDEA .	510
C. ONTOGENY OF THE ECHINOIDEA	519
D. ONTOGENY OF THE ASTEROIDEA	524
E. ONTOGENY OF THE OPHIUROIDEA .	532
F. ONTOGENY OF THE CRINOIDEA	533
XXII. PHYLOGENY .	545
<i>Review of the most Important Literature .</i>	551

CHAPTER IX

ENTEROPNEUSTA

I. OUTER ORGANISATION .	562
II. THE BODY EPITHELIUM .	563
III. THE NERVOUS SYSTEM	564
IV. THE SENSORY ORGANS	565
V. THE ALIMENTARY CANAL	565
VI. THE CŒLOMIC SACS AND THE BODY MUSCULATURE .	571
VII. THE "HEART VESICLE"	578
VIII. THE LIMITING MEMBRANES, THE PROBOSCICAL SKELETON, AND THE BRANCHIAL SKELETON	579
IX. THE BLOOD VASCULAR SYSTEM	581
X. THE GONADS .	585
XI. ONTOGENY	586
XII. PHYLOGENY	591
<i>Literature</i>	595

APPENDAGE TO THE ENTEROPNEUSTA

I. CEPHALODISCUS .	596
II. RHABDOPLEURA .	600
<i>Literature</i>	602
INDEX .	603

CHAPTER VII

SIXTH RACE OR PHYLUM OF THE ANIMAL KINGDOM

MOLLUSCA.

THE Mollusca are essentially bilaterally symmetrical animals with unsegmented bodies. The ventral wall is thick and muscular, and forms a foot which is used for locomotion, and assumes the most varied shapes. A fold of the body wall forms a circular mantle, which hangs down round the body, enclosing a space which is called the mantle or pallial cavity. This cavity is originally deepest and most spacious posteriorly, and contains, at the sides of the median anus, symmetrically grouped, the two gills and the renal and genital apertures. The dorsal portion of the animal is generally developed into a visceral dome or sac, and is protected down to the edge of the mantle by a shell. The mouth lies at the anterior end of the body and leads into a pharynx, which is usually provided with jaws and a rasp-like organ called the radula. The mesenteron or mid-gut is supplied with a large digestive gland (liver). The secondary cœlom (enclosed by its own walls) is reduced, but always persists as a pericardium. The blood vascular system is open, and generally to a great extent lacunar. The heart is dorsal and arterial, and was primitively provided with two symmetrical auricles. The nephridia were originally paired, and in open communication with the pericardium. The central nervous system consists of paired cerebral, pleural, pedal, and visceral ganglia. The Mollusca are either sexually separate or hermaphrodite. The gonads are usually single, with paired or unpaired ducts. In the course of development a modified Trochophora arises from the gastrula; this is the Veliger larva, typical of the Mollusca.

These general characteristics of the Molluscan body have to be modified for each class. In each class there are series of forms which deviate from the typical organisation in some one important point, or in several. The shell may disappear, and so may the mantle. Either one or both of the gills or ctenidia may be lost,

and new, morphologically different respiratory organs may be substituted. The visceral dome may be flattened down, and the foot become rudimentary or disappear. Teeth of all kinds may be wanting. The complex of the sub-pallial organs may be so displaced as to lie anteriorly, thereby causing a very pronounced asymmetry of the whole organism. But the typical Molluscan characteristics are never so entirely obscured that the members of the race cannot be recognised, on the one hand by means of transition forms leading to well-known Molluscan types, and on the other by their developmental history.

The Molluscs are divided into the five following classes :—

- | | |
|-------------------------|-----------------------------|
| I. Amphineura. | II. Gastropoda. |
| III. Scaphopoda. | IV. Lamellibranchia. |
| V. Cephalopoda. | |

Systematic Review.

CLASS I. **Amphineura.**

Bilaterally-symmetrical Molluscs. The nervous system consists of two lateral and two ventral nerve trunks, bound together by numerous commissures, and

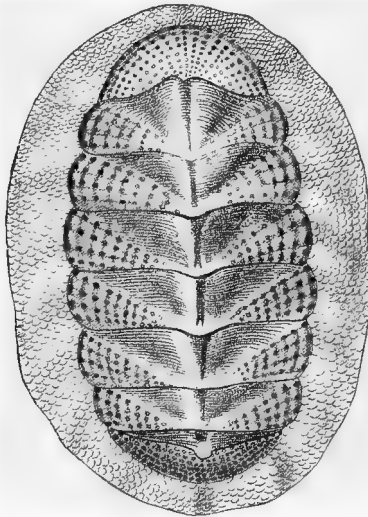

FIG. 1.—*Chiton*, from life (after Prêtre, in the *Voyage de l'Astrolabe*).

provided with ganglion cells throughout their whole length; these pass anteriorly into the cerebral ganglion. Special sensory organs are reduced. Marine.

ORDER 1. **Placophora (Polyplacophora) sive Chitonidæ.**

On the dorsal side there are eight consecutive shelly plates overlapping like the tiles on a roof. There is a distinct snout. The branchiæ are numerous, and are arranged in two longitudinal rows, one on each side in the groove between the foot and mantle. The foot (except in *Chitonellus*) is strongly developed, with a large flat

sole for creeping or for attachment. The sexual ducts and the nephridia are paired. The sexes are separate. The heart is provided with two auricles. Radula (3+1), (2+1), (1+1+1), (1+2), (1+3). *Chiton* (Fig. 1), *Chitonellus*.

ORDER 2. Aplacophora sive Solenogastres.¹

The body is almost cylindrical, and generally vermiform. There is no shell. The much thickened cuticle contains calcareous spicules. The foot is rudimentary, a mere ridge being left, and the mantle cavity is reduced to a groove at the sides of this ridge, and a cavity (cloaca) at the posterior part of the body, into which the intestinal canal and nephridia open, and in which are found, when present, the rudimentary gills. The nephridia serve as ducts for the genital products.

Family 1. Neomeniidae.

The foot is a longitudinal ridge, which rises from the base of a medio-ventral

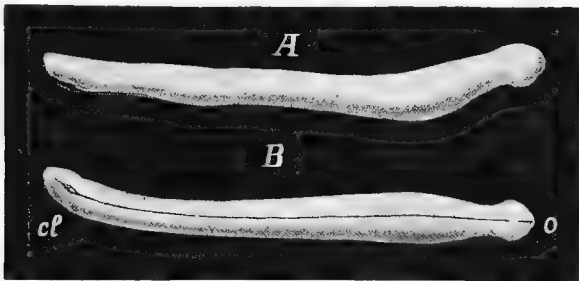

FIG. 2.—*Proneomenia sluteri*, two-thirds natural size. *A*, From the right side; *B*, from beneath; *o*, mouth; *cl*, cloaca.

longitudinal furrow. This family is hermaphrodite. *Proneomenia* (Fig. 2), *Neomenia*, *Lepidomenia*, *Dondersia*.

Family 2. Chætodermidae.²

The foot and the pedal furrow are quite degenerated. The sexes are separate. *Chætoderma*.

CLASS II. Gastropoda (Cephalophora). Snails.

The body is asymmetrical. The head, which carries tentacles and eyes, is generally distinct from the body. The foot is well developed—usually with a flat sole for creeping. The large protruding visceral dome may be flattened down secondarily in all the groups. It is covered by a shell, consisting of a single piece, into which the animal can withdraw. In all divisions, however, though rarely among the *Proso-*

¹ Simroth, in the new edition of Bronn's *Klassen und Ordnungen des Thierreiches*, vol. iii., 1893, divides the Solenogastres as follows:—

Sub-Order.	Fam.
Chætodermatina	Chætodermatidæ.
	(Neomeniidæ.
	Proneomeniidæ.
Neomeniina	(Dondersiidæ.
	Parameniidæ.

branchia, this shell may become more or less rudimentary (generally in connection with the reduction of the visceral dome).

The pallial complex becomes shifted forward on to the right (seldom the left) side, or along this side so as to lie quite anteriorly. The visceral dome and shell (with some exceptions) are spirally coiled.

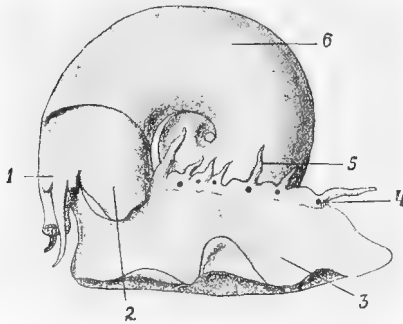

FIG. 3.—*Margarita Groenlandica* (*Trochid*, after Pelseneer). 1, Head; 2, anterior epipodial lobes; 3, foot; 4, pigmented prominence at the base of the epipodial tentacles (5); 6, visceral dome.

branchia are chiefly marine, and are sexually separate. The foot is generally provided with an operculum for closing the aperture of the shell. A shell is wanting only in *Titiscania*, a genus of the *Neritacea*.

Sub-Order 1. Diotocardia.

The heart has two auricles (excepting in *Docoglossa*). There are two kidneys. Instead of the pedal ganglion of other Gastropoda, there are two longitudinal nerves in the foot, supplied with ganglia and connected with one another by numerous commissures. The gills are feathered on two sides, their points projecting freely. The epipodium is well developed, and there is a circle of more or less numerous tentacles around the base of the foot. Proboscis, penis, and siphon are all wanting.

a. Zeugobranchia (Rhipidoglossa, Aspidobranchia).—Two gills; both auricles well developed. Heart traversed by the rectum. Shell with marginal cleft, or with apical perforation or with a row of perforations. Generally without operculum. Marine. Fam. *Haliotidae*, radula $\propto 1.(5.1.5)1\infty$, *Fissurellidae* (*Fissurella*, rad. $\propto 1.(4.1.4)1\infty$, with secondarily symmetrical shell. *Emarginula*, *Scutum*

In all except the lowest *Prosobranchia*, the asymmetry is evidenced by the disappearance of one gill, of one kidney, and of one auricle.

The radula is rarely wanting.

ORDER 1. Prosobranchia.

The pleuro-visceral connectives are crossed. The mantle complex is twisted round to the front side of the visceral dome. In most forms there is only one gill, placed anteriorly to the heart, and in the heart the auricle lies anteriorly to the ventricle. The Prosobranchia

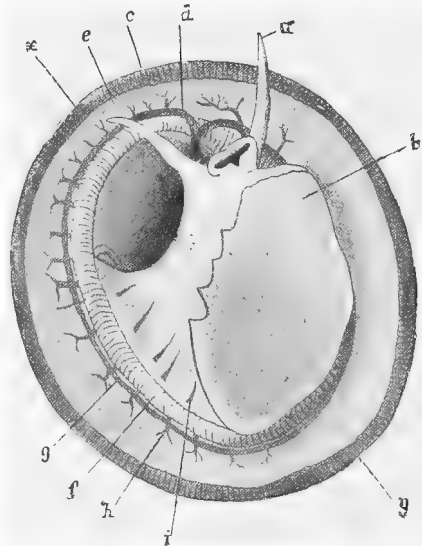

FIG. 4.—*Patella vulgata* (from beneath, after Lankester). *a*, Tentacle; *b*, efferent branchial vessel; *c*, free edge of the mantle; *d*, free edge of the shell; *e*, median line; *f*, afferent branchial vessels; *g*, branchial lamellae; *h*, one of the afferent vessels; *i*, spaces between the shell muscles; *j*, foot.

Emarginula, *Scutum*

= *Parmophorus*), *Pleurotomariidae* (*Pleurotomaria*, *Scissurella*, *Polytremaria*), *Bellerophonitidae* (exclusively fossil).

b. **Azygobranchia.**—One gill, homologous with the left gill of the *Zeugobranchia*. Right auricle ending blindly. Heart perforated by the rectum. Fam. *Turbonidae*, rad. $\infty 0.(5.1.5.)0.\infty$, *Trochidae* (Fig. 3) *Stomatiidae*, *Neritopsidae*, rad. $\infty 1.(2.0.2.)1.\infty$, marine, *Neritidae*, rad. $\infty 1.(3.1.3.)1.\infty$ (marine, but along the shore able to live out of water), *Neritinae* (marine and fresh-water). The *Hydrocoenidae*, rad. $\infty 1.(1.1.1.)1.\infty$, and *Helicinidae*, rad. $\infty 1.(4.1.4.)1.\infty$, have no gills but a lung resembling that of the *Pulmonata*. The *Helicinidae* are terrestrial.

c. **Docoglossa.**—Heart with one auricle, and not perforated by the rectum. Left kidney shifted to the right side of the pericardium. Visceral dome and shell secondarily symmetrical, the latter usually cup-like. Operculum wanting. Marine.

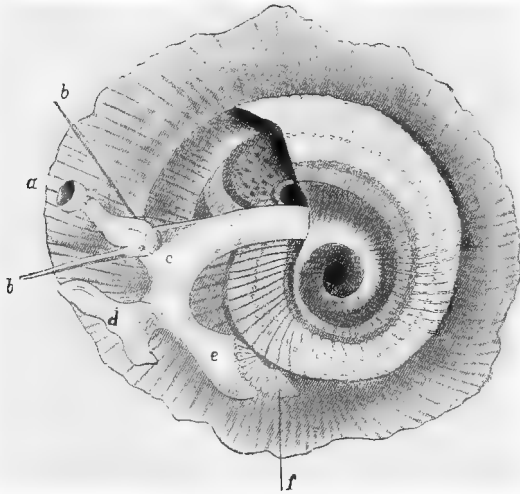

FIG. 5.—*Phorus exutus* (after Lankester). *a*, Proboscis; *b*, tentacle; *c*, eye; *d*, foot; *e*, metapodium with operculum *f*.

1. Left true ctenidium present. *Acmacidae*, rad. 1.2.(1.0.1.)2.1.; with numerous accessory gills in the mantle furrow: *Scurria*;—without such gills: *Acmacea* (*Tectura*).

2. True ctenidia altogether wanting, accessory gills very numerous in the mantle furrow.—Fam. *Patellidae* (Fig. 4), rad. 3.1.(2.0.2.)1.3.

3. Neither ctenidia nor accessory gills found (*Lepetidae*), rad. 2.0.1.0.2.

Sub-Order 2. **Monotocardia (Pectinibranchia).**

Heart with one auricle. A single true ctenidium feathered on one side, the point not projecting freely (except in *Valvata*). Pedal nerve trunks a rare exception, pedal ganglia the rule. Only one kidney. Siphon and penis generally present. Epipodium weakly developed or wanting. The *Monotocardia* are very numerous and are chiefly marine.

a. **Architaenioglossa.**—Pedal nerve trunks. In *Cypraea* (and in other forms?) a rudiment of the right auricle persists. Fam. *Cypraeidae*, rad. 3.1.1.1.3, *Paludinidae* (fresh-water), *Cyclophoridae* (terrestrial, pulmonate).

b. **Taenioglossa**. — Typical radula, 2.1.1.1.2. **Semiprobooscidifera**. Fam. *Naticidae* (Fig. 98, p. 107), *Lamellaridae*. **Rostrifera**. Fam. *Valvatidae* (fresh-water), *Ampullaridae* (fresh-water), *Littorinidae*, *Cyclostomidae* (terrestrial), *Planaxidae*, *Hydrobiidae* (fresh-water), *Aciculidae* (terrestrial), *Truncatellidae* (partly terrestrial), *Hippomyxidae*, *Capulidae*, *Calyptracidae*, *Pseudomelanidae*, *Melanidae*, *Cerithiidae*,

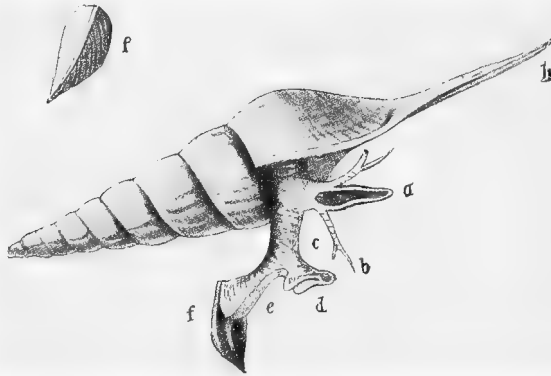

FIG. 6.—*Rostellaria rectirostris* (after Owen). a, Snout; b, tentacle; c, stalked eye; d, foot; e, metapodium with operculum f; h, beak (for the siphon).

Vermetidae, *Turritellidae*, *Xenophoridae* (Fig. 5), *Struthiolariidae*, *Chenopidae*, *Strombidae* (Fig. 6). **Proboscidifera holostomata**. Fam. *Scalaridae*, rad. $\infty O \infty$; *Solaridae*, rad. $\infty O \infty$; *Pyramidellidae*, rad. O; *Eulimidae*, rad. O. **Proboscidifera siphonostomata**. Fam. *Colombellinidae*, *Tritoniidae*, *Cassidiidae* (Fig. 7), *Doliidae*.

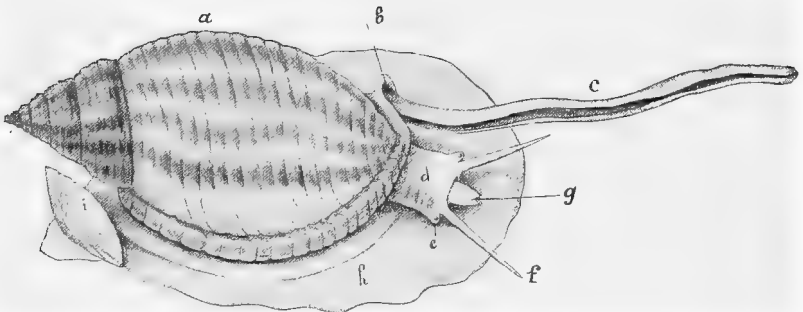

FIG. 7.—*Cassis sucosa* (after Poli). a, Shell; b, beak; c, siphon; d, head; g, proboscis; e, eye; f, tentacle; h, foot; i, operculum.

Janthinidae, rad. $\infty O \infty$. **Heteropoda** (marine *Taenioglossa*, with foot transformed into a perpendicular rowing fin). Fam. *Atlantidae* (Fig. 8), *Pterotrachacidae* (Fig. 9).

c. **Stenoglossa**. — Normal rad. 1.1.1. **Rachiglossa**. Fam. *Turbinellidae*, *Fusidae*, *Mitridae*, *Buccinidae*, *Muricidae*, *Purpuridae*, *Haliadae*, *Cancellariidae*, *Volutidae*, *Olividae*, *Marginellidae*, *Harpidae*. **Toxiglossa**. Fam. *Pleurotomidae*, *Terebridae*, *Conidae*.

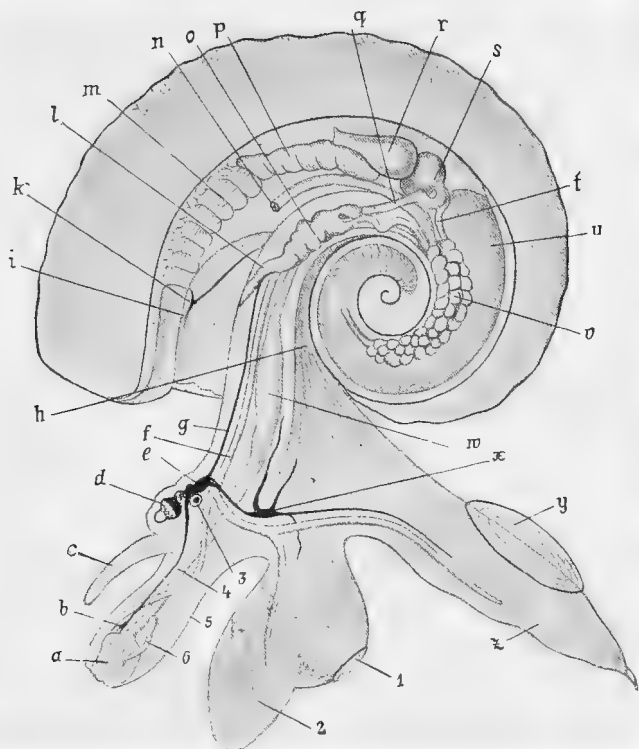

FIG. 8.—*Atlanta Peronii* (after Gegenbaur). *a*, Pharynx; *b*, buccal ganglion; *c*, tentacle; *d*, eye; *e*, cerebral ganglion; *f*, aorta cephalica; *g*, pleuro-visceral connective; *h*, columellar muscle; *i*, *k*, osphradium; *l*, vagina; *m*, ctenidium; *n*, anus; *o*, uterus; *p*, nephridium; *q*, aorta cephalica; *r*, auricle; *s*, ventricle; *t*, aorta visceralis; *u*, digestive gland (liver); *v*, ovary; *w*, stomach; *x*, pedal ganglion; *y*, operculum; *z*, metapodium; 1, sucker of the fin-like foot (rudimentary sole); 2, foot; 3, auditory organ; 4, œsophagus; 5, snout; 6, salivary gland.

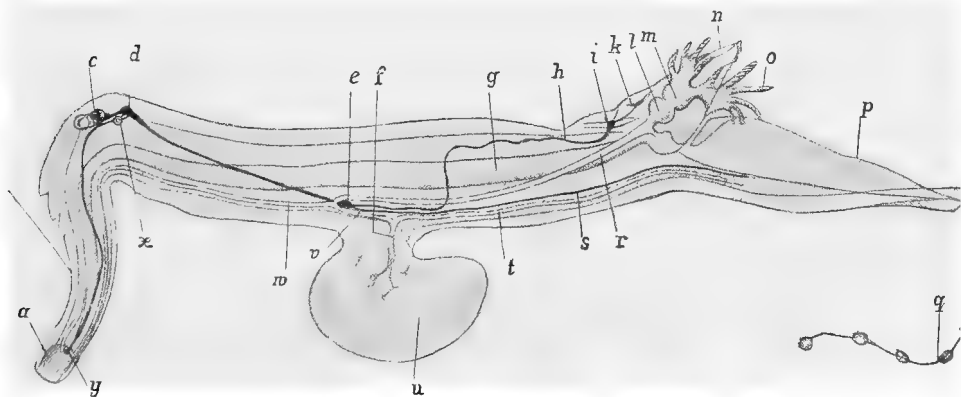

FIG. 9.—*Pterotrachea (Firola) coronata* (after Leuckart). *a*, Pharynx; *b*, proboscidal snout; *c*, eye; *d*, cerebral ganglion; *e*, pedal ganglion; *f*, pedal artery; *g*, intestinal canal; *h*, pleuro-visceral connective; *i*, parieto-visceral ganglion; *k*, osphradium; *l*, ventricle; *m*, auricle; *n*, anus; *o*, ctenidium; *p*, metapodium; *q*, appendage; *r*, aorta cephalica; *s*, nerve running to the metapodium; *t*, artery; *u*, foot; *v*, common pedal artery; *w*, cephalic artery; *x*, auditory organ; *y*, buccal ganglion.

ORDER 2. **Pulmonata.**

The pleuro-visceral connectives are not crossed. The ctenidium has disappeared from the mantle complex and is replaced by a lung, or respiratory vascular network, on the inner surface of the mantle. The pallial organs lie primitively to the right, anteriorly on the visceral dome. The edge of the mantle, with the exception of a branchial aperture on the right, unites with the integument of the neck. In terrestrial Pulmonata the visceral dome is often flattened down and the shell becomes rudimentary (Slugs). The operculum is always wanting. The heart has one auricle, which almost always lies anteriorly to the ventricle. The Pulmonata are hermaphrodites with hermaphrodite glands or ovotestes, and complicated efferent ducts. They are either terrestrial or fresh-water.

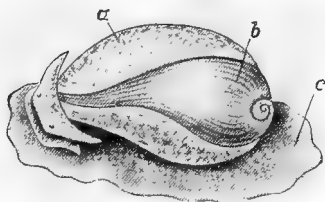

FIG. 10.—*Amphipeplea leuconensis* (after Adams). *a*, Lobe of the mantle bent back over the shell; *b*, portion of the shell uncovered; *c*, foot.

Sub-Order 1. **Basommatophora** (fresh-water).

Eyes at the bases of the non-invaginable optic tentacles. Genital apertures separate, to the right anteriorly, the male in front of the female. Fam. *Limnoidæ*, (*Limnea*, *Amphipeplea* [Fig. 10], *Physa* [Fig. 11], *Planorbis*, *Ancylus*), *Auriculidæ*.

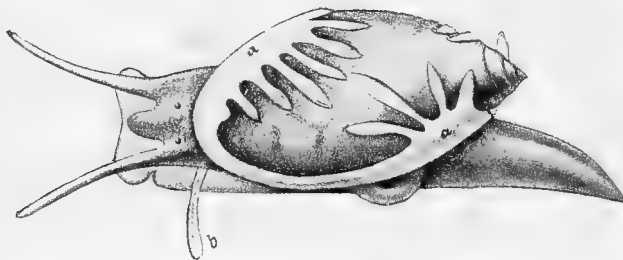

FIG. 11.—*Physa fontinalis* (after L. Reeve). *a*, Mantle lobes folded back over the shell; *b*, evaginated penis.

Eyes at the tips of the optic tentacles; tentacles invaginable.

Sub-Order 2. **Stylommatophora.**

a. Monogonopora.—With a single genital aperture to the right. Fam. *Helicidæ* (*Helix* [Fig. 12, *A*], *Arion* [Fig. 12, *D*], *Bulimus*). *Testacellidæ* (*Daudebardia* [Fig. 12, *B*], *Testacella* [Fig. 12, *C*]). *Limacidæ* (*Ariophanta*, *Limax*, *Vitrina*, *Zonites*, *Helicarion*). *Bulimulidæ* (Fig. 13), *Pupidæ* (*Buliminus*, *Pupa*, *Clausilia*), *Succineidæ*.

b. Digonopora.—Shell-less snails with separate male and female genital apertures, the male anterior, the female at the posterior end of the body, both to the right. Pallial complex at the posterior end of the body, lung cavity reduced. Fam. *Vaginulidæ* (terrestrial), *Oncidiidæ* (marine or amphibious); respiration partly by means of dorsal branchial appendages.

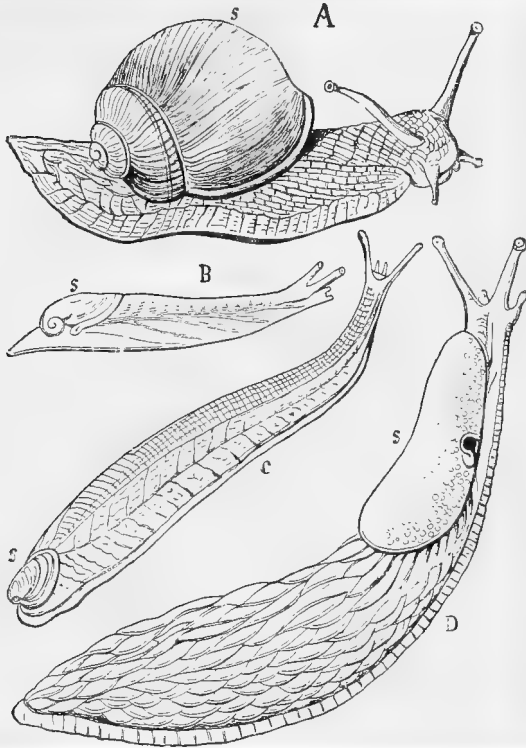

FIG. 12.—A, *Helix pomatia*; B, *Daudebardia (Helicophanta) brevipes*; C, *Testacella halio-tidea*; D, *Arion ater*; s, shell, in D shield (from Lankester).

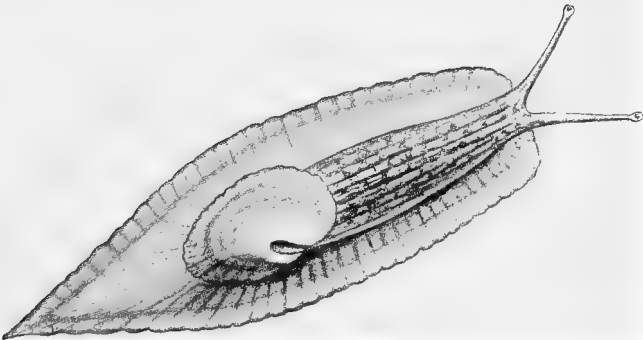

FIG. 13.—*Peltella palliolum (Bulinulid, after Ferrussac)*.

ORDER 3. **Opisthobranchia.**

The pleuro-visceral connectives do not cross.¹ There is one auricle placed behind the ventricle. A shell is sometimes present, more frequently wanting. An operculum is rarely found. Respiration by means of true ctenidia, or of adaptive gills, or through the skin. The visceral dome is very often levelled down. Hermaproditous with ovotestes. Marine.

Sub-Order 1. **Tectibranchia.**

The pallial complex is to the right of the body, and is more or less covered by the mantle fold belonging to that side. One true ctenidium (viz. that which was originally the right) is always retained in the mantle cavity, but is often very incompletely covered by the mantle. The visceral dome tends to disappear. A shell is always present, but tends to become rudimentary. Generally with parapodia, and mantle lobes covering the shell.

A. **Reptantia.**

a. **Cephalaspidæ.**—With frontal or cephalic disc. Fam. **Actæonidæ** (with operculum), **Scaphandridæ**, **Bullidæ** (*Bulla*, *Accra*), **Gastropteridæ** (Fig. 14), **Philinidæ**, **Doridiidæ**.

b. **Anaspidæ.**—Head without frontal disc; four triangular or ear-like tentacles. Fam. **Aplysiidæ** (*Aplysia*, *Dolabella*, *Notarchus*).

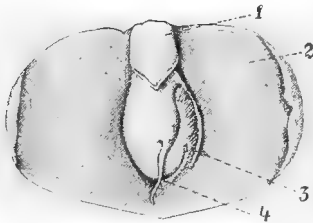

FIG. 14.—*Gastropteron Meckelii*, with internal shell (after *Vayssièrè*). 1, Cephalic shield (frontal disc); 2, parapodium; 3, ctenidium, left almost uncovered by the rudimentary mantle fold; 4, flagellum=appendage of the mantle fold.

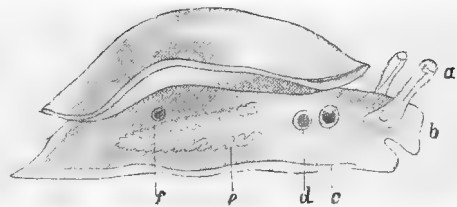

FIG. 15. *Pleurobranchus aurantiacus*, with internal shell (after *Leuckart's Wandtafeln*), seen from the right side. *a*, Rhinophores; *b*, labial sail; *c*, genital aperture; *d*, nephridial aperture (?); *e*, ctenidium; *f*, anus.

c. **Notaspidæ.**—Head short, with or without tentacles. Large dorsal disc (notum) in or on which a shell may lie. Fam. **Pleurobranchidæ** (*Pleurobranchus* [Fig. 15], *Pleurobranchia*, *Oscanius*), **Umbrellidæ** (*Umbrella*, *Tyrodina*), **Peltidæ**.

B. **Natantia sive Pteropoda.**²

These formerly constituted a separate class of the Molluscs, but are now recognised to be Tectibranchia adapted to a free-swimming pelagic life. The parapodia of the Tectibranchia develop as fins or wing-like swimming organs.

¹ Except in *Actæon*, which is streptoneurous, and thus forms a connecting link between the Opisthobranchia and Pulmonata on the one hand, and the remaining Gastropods on the other [Bouvier and Pelseneer], *v. Nat. Sci.*, July 1893.

² The classification of the Opisthobranchs, which places the Pteropoda thecosomata with the Cephalaspidæ, and the Pteropoda gymnosomata with the Anaspidæ, is accepted on p. 110 and elsewhere.

a. Pteropoda thecosomata.—These are nearly related to the *Cephalaspidea*, and possess a mantle, mantle cavity, and shell. The head is not distinct, and has only one pair of tentacles. The fins, at their anterior edges, are fused over the mouth; the anus lies to the left. Fam. **Limacinidæ**. An external calcareous shell, with left-handed or sinistral twist, and a spiral operculum. Anus to the right (*Limacina* [Fig. 16], *Peraclis*). Fam. **Cavoliniidæ**. External symmetrical shell (*Clio*, *Cavolinia*). Fam. **Cymbuliidæ**. Internal cartilaginous shell (*Cymbulia*, *Cymbulopsis*, *Gleba*). The Thecosomata feed chiefly on small Protozoa and Algæ.

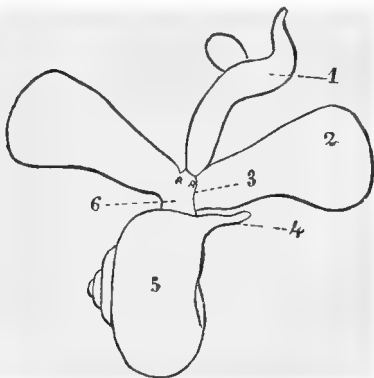
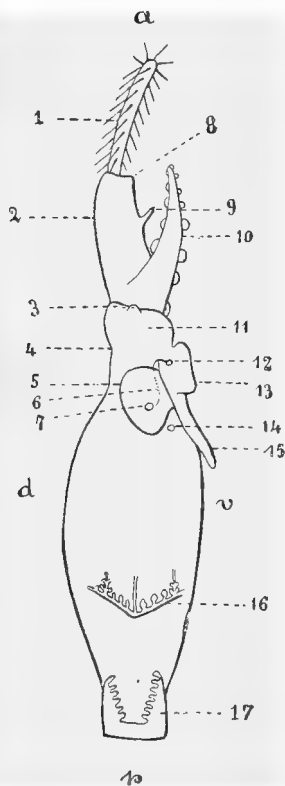

FIG. 16.—*Limacina Lesueurii* (dorsal aspect, after Pelseneer). 1, Penis; 2, fin (parapodium); 3, seminal furrow; 4, mantle process ("balancer"); 5, visceral dome; 6, head with two tentacles and the seminal furrow 3.

FIG. 17.—*Pneumoderma* (diagram from the right, after Pelseneer). 1, right evaginated process bearing hooks (hook sac); 2, proboscis; 3, right buccal tentacle; 4, position of the right nuchal tentacle; 5, right fin (parapodium); 6, seminal furrow; 7, genital aperture; 8, position of the jaw; 9, ventral proboscidal papilla; 10, right buccal appendage provided with suckers; 11, head; 12, aperture for penis; 13, right anterior pedal lobe; 14, anus; 15, posterior pedal lobe; 16, ctenidium; 17, posterior adaptive gill; *d*, *c*, *a*, *p* denote dorsal, ventral, anterior, and posterior.



b. Pteropoda gymnosomata.—These are nearly related to the *Anaspidae*. They have no mantle, mantle cavity, nor shell. The head is distinct, and carries two pairs of tentacles. The fins are separate; the anus lies to the right. Fam. **Pneumodermatidæ**. One ctenidium to the right (*Dexiobranchæa*, *Spongiobranchæa*, *Pneumoderma* [Fig. 17]). In the last two genera there is an adaptive posterior gill as well. Fam. **Clionopsidæ** and **Notobranchæidæ**. No ctenidium, but a posterior adaptive gill. Fam. **Clionidæ**. Neither ctenidium nor adaptive gill. All Gymnosomata are carnivorous, feeding principally on *Thecosomata*.

Sub-Order 2. Ascoglossa.

This sub-order is characterised by the fact that the worn-out teeth of the long narrow radula, which consists of a single row of dental plates, are preserved in a sac

at its anterior end. No jaws. The anus almost always dorsal. Except in the *Steganobranchia*, the disappearance of the mantle and its cavity is accompanied by the disappearance of the single ctenidium of the Tectibranchia.

Section 1. **Steganobranchia**.—With mantle, cavity, and ctenidium to the right; with a shell and parapodia. Fam. **Oxynoidea** (*Oxynoe*, *Lobiger*).

Section 2. **Cirrobranchia**.—Leaf- or club-shaped processes found laterally on the back. Fam. **Hermæidæ**, **Phyllobranchidæ**.

Section 3. **Pterobranchia**.—The sides of the body produced into lobes, in which the branches of the glands of the mid-gut spread out. Fam. **Elysiadæ**, **Placobranchidæ**.

Section 4. **Abranchia**.—Neither ctenidium, nor dorsal appendages, nor leaf-like lateral expansions of the body. Respiration through the skin. The body is almost like that of a Planarian. Fam. **Limapontiidæ**.

Sub-Order 3. Nudibranchia.

Without mantle fold, shell, or ctenidium. Jaws almost always found. Radula

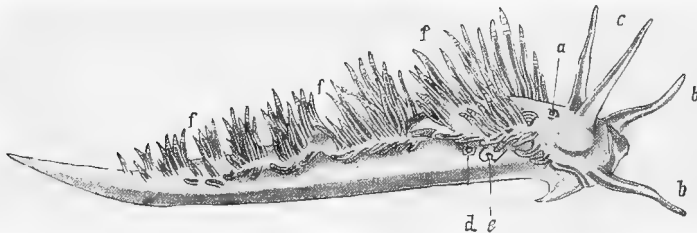

FIG. 18.—*Aeolis rufibranchialis* (right aspect, after Alder and Hancock). *a*, Eye; *b*, oral tentacle; *c*, cephalic tentacle; *d*, anus; *e*, genital aperture; *f*, dorsal respiratory appendages (cerata).

generally well developed, with teeth which fall off and are lost. Adaptive gills very variously developed, but occasionally wanting.

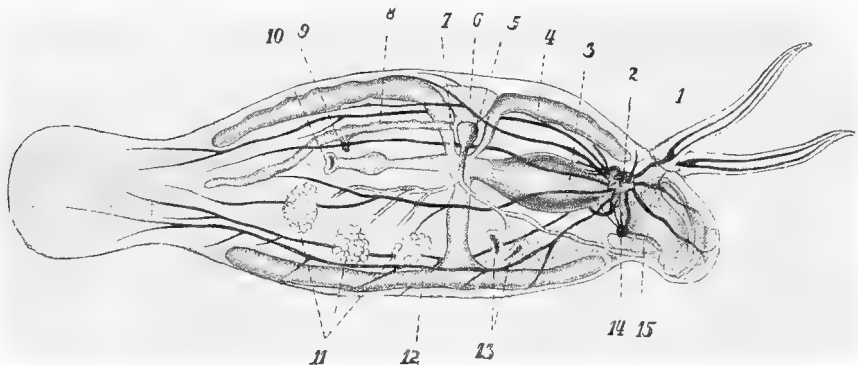

FIG. 19.—*Phyllirhoë bucephalum* (lateral aspect, after Souleyet, modified). 1, Tentacle; 2, cerebral ganglion; 3, stomach; 4 and 12, intestinal caeca (forming the digestive gland); 5, ventricle; 6, auricle; 7, pericardial aperture of the kidney; 8, kidney; 9, external aperture of the same (on the right side); 10, anus (on the right side); 11, hermaphrodite glands, the ducts not drawn; 13, genital apertures; 14, buccal ganglion; 15, salivary glands.

Section 1. **Holohepatica**.—One large unbranched hepatic gland (liver). Fam.

Phyllidiidæ. Numerous branchial lamellæ lie in a groove which encircles the body. No jaws and no radula. Pharynx transformed for sucking. Fam. **Doridopsidæ.** Without jaws or radula; pharynx adapted for sucking. Branchial rosette round the dorsal anus. **Dorididæ cryptobranchiatæ.** The branchial rosette round the dorsal anus can be withdrawn into a cavity. (*Bathydoris*, *Archidoris*, *Discodoris*, *Diaulula*, *Kentrodoris*, *Platydoris*, *Chromodoris*, etc.) **Dorididæ phanerobranchiatæ.** Branchial rosette not retractile. (*Goniodoris*, *Polycera*, *Acanthodoris*, *Idatia*, *Ancula*, *Euplocamus*, *Triopa*, etc.)

Section 2. **Cladohepatica.**—Digestive glands more or less broken up into separate branched canals spreading widely in the body. Various formed dorsal appendages chiefly connected with respiration. Anus usually to the right. Fam. **Aeolidiadæ** (*Aeolidia* [Fig. 18], *Berghia*, *Tergipes*, *Galvina*, *Cryptella*, *Rizolia*, *Facellina*, *Flabellina*, *Fiona*, *Glaucus*, *Janus*, *Hero*). Fam. **Tethymelibidæ**, without radula (*Tethys*, *Melibe*). Fams. **Lomanotidæ**, **Dotonidæ**, **Dendronotidæ**, **Bornellidæ**, **Scyllaeidæ**, **Phyllirhoidæ** (Fig. 19; marine free-swimming animals with narrow laterally-compressed body, without foot or respiratory appendages). Fam. **Pleurophyllidiidæ.** Numerous branchial lamellæ arranged in a single row on each side along a furrow between the dorsal shield and the foot (Fig. 20). Fam. **Pleuroleuridæ**, **Tritoniadæ** (*Tritonia*, *Marionia*).

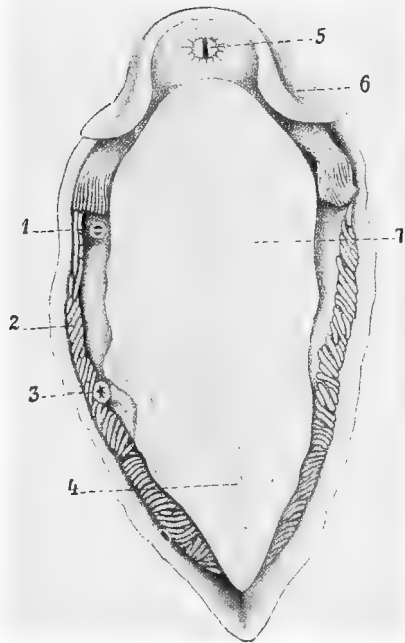

FIG. 20.—*Pleurophyllidia lineata* (from below, after Souleyet). 1, Genital apertures; 2, branchial leaflets; 3, anus; 4, pedal gland; 5, mouth; 6, tentacle shield; 7, foot.

CLASS III. Scaphopoda.

The body is symmetrical, and elongated dorso-ventrally. The mantle is a tubular sac with a narrow dorsal and a wider ventral aperture. Posteriorly, the mantle cavity reaches to the apical (dorsal) aperture. The shell forms a high tubular cone, and, like the mantle, has a small apical and a larger ventral aperture. Ctenidia are wanting; the kidneys are paired. The vascular part of the circulatory system is reduced to a ventricle; without auricles. The sexes are separate. There are no special ducts for the sexual products, which are ejected through the right kidney. The mouth lies at the end of a barrel-shaped snout, and is surrounded by a circle of leaf-like appendages. At the base of this snout there are numerous filamentous appendages, which can be protruded through the lower aperture of the shell and mantle. The foot is ventrally elongated. A radula is found. Limicolous. Marine. Fam. **Dentalium** (Fig. 101, p. 113). The foot is relatively short; it is shaped somewhat like an acorn, with a conical central portion and two lateral lobes. **Siphonodentalium.** The foot is long and worm-like, but broadens out at the end into a disc edged with papillæ.

CLASS IV. **Lamellibranchia (Pelecypoda, Bivalva, Acephala, Aglossa). Mussels.**

The body is symmetrical and more or less transversely flattened; it has two large lateral leaf-like mantle lobes, enclosing a spacious mantle cavity large enough to contain the foot, which is usually hatchet- or wedge-shaped. The shell consists of two lateral valves connected together only at the dorsal hinge. It is closed by means of two adductor muscles passing transversely from one valve to the other (*Dimyaria*); occasionally the anterior adductor degenerates and only one remains (*Monomyaria*). On each side in the mantle cavity there is a ctenidium. There are no jaws, no pharynx, no radula, no tentacles, and no distinct head. The kidneys and genital organs are paired, and the latter either have separate ducts or eject their products through the nephridia. The heart has two auricles. At each side of the mouth there are two oral lobes. Either sexually separate or hermaphrodite. They live in salt or fresh water, and are either limicolous or attached.

ORDER 1. **Protobranchia.**

The gills with two rows of leaflets, in the posterior part of the mantle cavity; they correspond in all respects with the ctenidia of the Zeugobranchia, their ends

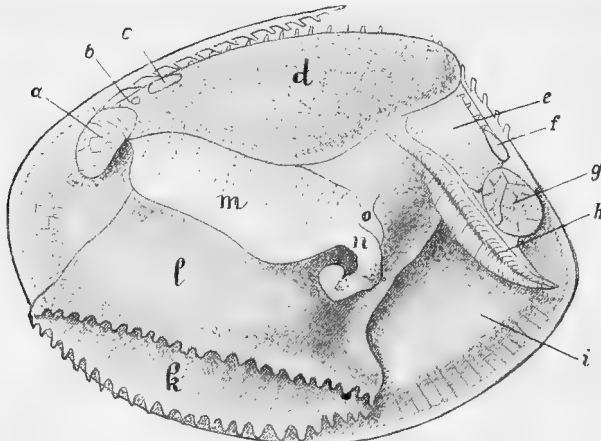

FIG. 21.—*Nucula nucleus*, left aspect after removal of the left valve and mantle (after **Pelseneer**). *a*, Anterior adductor; *b*, anterior retractor of the foot; *c*, elevator of the foot; *d*, genital mass; *e*, hypobranchial gland; *f*, posterior retractor of the foot; *g*, posterior adductor; *h*, ctenidium; *i*, mantle cavity; *k*, creeping sole of the foot (*l*); *m*, oral lobes (labial palps) with posterior appendages *n* and *o*.

project freely backward into the cavity. The foot has a sole for creeping. The pleural ganglion can be distinguished from the cerebral. Fam. **Nuculidæ** (*Nucula* [Fig. 21], *Leda*, *Yoldia*, *Solenomyidæ*).

ORDER 2. **Filibranchia.**

The branchial leaflets of the ctenidium have become lengthened out into long filaments hanging far down into the mantle cavity. Each is in two parts, the proximal descending and the distal ascending (*cf.* Fig. 88 B). Fam. **Anomidæ**: mantle open

without siphons; Monomyarian. Foot small; body and shell asymmetrical. Attached. Branchial filaments entirely free (*Anomia*, *Placuna*). Fam. **Arcidæ**: the branchial filaments of each row connected by ciliated discs; Dimyarian. No siphons. Foot large (*Arca*, *Pectunculus*). Fam. **Trigoniidæ**: ctenidia like those of the *Arcidæ*;



FIG. 22.—*Mytilus edulis* (after Meyer and Möbius), left aspect, with extended foot attaching a byssus thread; *d*, byssus threads; *a*, exhalant aperture (anal siphon); *b*, fringed edge of the inhalant mantle aperture; *c*, object to which the animal is attached.

Dimyarian. No siphons (*Trigonia*). Fam. **Mytilidæ** (excluding *Aviculidæ*): ctenidia connected by means of non-vascularised trabeculæ. The anterior adductor is smaller than the posterior (Heteromyarian). With siphons. Foot long. (*Mytilus* [Fig. 22], *Modiola*, *Lithodomus* [boring mussel], *Modiolaria*).

ORDER 3. Pseudolamellibranchia.

The consecutive ctenidial filaments of each row are connected by means either of ciliated discs or of vascularised trabeculæ; and the ascending and descending.

portions of each filament are similarly united (cf. Fig. 88, p. 92). Fam. **Pectinidæ**:

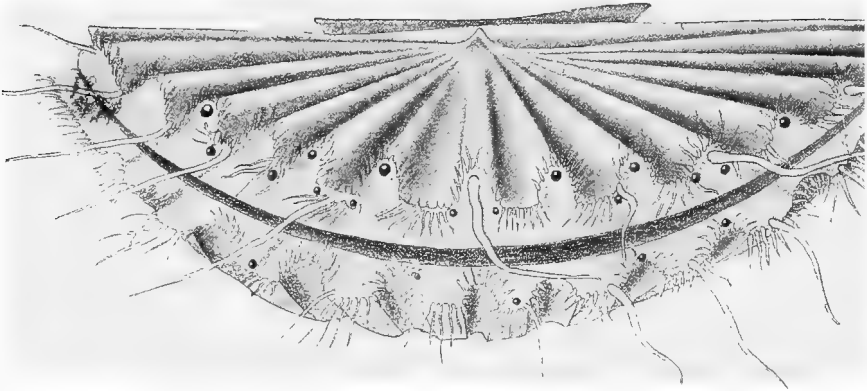

FIG. 23.—**Pecten Jacobæus**, ventral aspect, shell opened. The mantle cleft is seen between the fringes of the mantle, which are beset with numerous tentacles and eyes (after **Leuckart** and **Nitsche**, *Zool. Wandtafeln*).

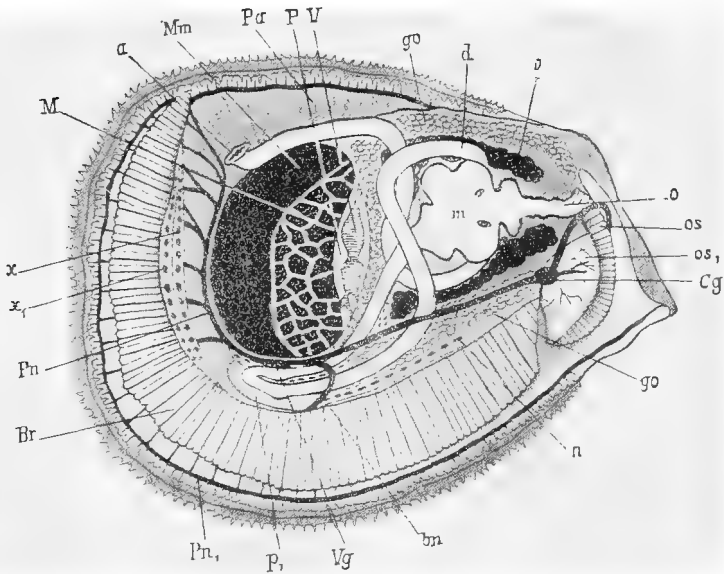

FIG. 24.—**Anatomy of the Oyster (*Ostrea edulis*)**, right aspect (after **Möbius**, **Leuckart**, and **Nitsche**, *Zool. Wandtafeln*). *br*, Gills; *Pn*, posterior mantle nerve; *α, α₁*, apertures of the cavities between the fused plates of the two left gills; *M*, large adductor muscle; *a*, anus; *Mm*, posterior portion of the adductor muscle; *Pα*, mantle; *P*, pericardium; *V*, heart; *gō*, gonad (hermaphrodite gland); *d*, intestinal canal; *l*, digestive gland (liver); *o*, mouth; *os, os₁*, oral lobes (labial palps) of the left side; *Cg*, cerebral ganglion; *n*, kidney; *bn*, branchial nerve; *Vg*, visceral ganglion; *P₁*, abdominal process; *Pn₁*, nerve of the pallial edge; *m*, stomach, with the apertures of the digestive gland.

Monomyarian with mantle entirely open, and eyes at its edge. Without siphons. Foot small and linguiform. Valves of the shell equal or unequal. Capable of

swimming. (*Pecten* [Fig. 23], *Chlamys*). Fam. **Aviculidæ**: Monomyarian or Heteromyarian without siphons. Valves equal or unequal (*Avicula* [*Melcagrina*], *Malleus*, *Vulsella*, *Perna*, *Inoceramus*, *Pinna*, *Melcagrina margaritifera*, pearl mussel). Fam. **Ostreidæ**: Monomyarian without foot, with completely open mantle, without siphons. Valves unequal, the left valve attached to the substratum. (*Ostrea*: oyster [Fig. 24]).

ORDER 4. Eulamellibranchia.

The gills no longer consist of distinct filaments. On the contrary, the filaments in each row and the two parts of each filament are so connected by means of vascularised trabeculae or sutures as to form together a lamella or trellis-work. There are, on either side, two such branchial lamellae (hence the name of *Lamellibranchia*), which in fact correspond with the two rows of leaflets of the typical tentidium. This order includes the majority of the Lamellibranchia.

Sub-Order 1. Submytilacea.

Branchial lamellae smooth. The mantle edges usually grown together only between the inhalent and the exhalent apertures. Dimyarian. Fam. **Carditidæ**: with open mantle and large foot (*Cardita*, *Venericardia*). Fam. **Lucinidæ**: with simple, and as a rule single, siphonal aperture. Foot often vermiform. Fam.

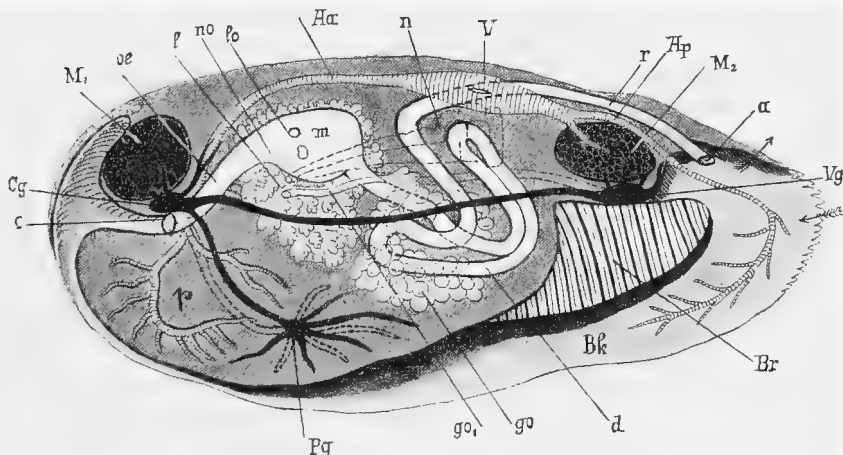

FIG. 25.—Anatomy of *Unio* (*Margaritana*) *margaritifera*, left aspect (after Leuckart and Nitsche). *u*, Mouth; *cg*, cerebral ganglion; *M*₁, anterior adductor muscle; *a*, œsophagus; *l*, digestive gland (liver); *no*, nephridial aperture; *lo*, aperture of the digestive gland in the stomach *m*; *Aa*, anterior aorta; *n*, nephridium, the outlines given in dotted lines; *V*, heart; *r*, proctodæum; *Ap*, posterior aorta; *M*₂, posterior adductor; *a*, anus; *Vg*, visceral ganglion; *Br*, gill; *Bl*, mantle cavity; *go*, gonad and ducts *go*₁; *Pg*, pedal ganglion; *p*, foot. The arrows mark the direction of the inhalent and exhalent streams of water.

Erycinidæ: mantle closed except at the two siphonal and the pedal apertures. Foot long. (*Erycina*, *Kelleya*, *Lasca*, *Lepton*, *Galcomma*.) Fam. **Crassatellidæ**: mantle open without siphons. Foot moderately developed. Fam. **Cyrenidæ**: mantle open, two siphons. Foot large. In fresh or brackish water. (*Cyrena*, *Corbicula*, *Sphaerium*, *Pisidium*, *Galatea*.) Fam. **Dreissensiidæ** (fluvial). Fam. **Unionidæ**: freshwater; foot large, hatchet- or wedge-shaped, two simple siphonal apertures or clefts, mantle open (*Unio* [Fig. 25], Painter's Mussel; *Anodonta*, pond Mussel; *Mutela*).

Sub-Order 2. **Tellinacæ.**

Dimyarian with completely separate siphons. Foot large. Gills smooth. Fam. **Tellinidæ** (*Tellina*). Fam. **Donacidæ** (*Donax*), **Mactridæ** (*Mactra*).

Sub-Order 3. **Veneracæ.**

Dimyarian with somewhat folded branchial lamellæ. Siphons separate, and foot large. Fam. **Veneridæ** (*Venus*, *Meretrix* [*Cytherea*], *Tapes*). Fam. **Petricolidæ**: boring muscles.

Sub-Order 4. **Cardiacæ.**

Dimyarian or Monomyarian. Branchial lamellæ much folded. Mantle closed except at the two siphonal and one pedal apertures. Fam. **Cardiidæ**: Dimyarian.

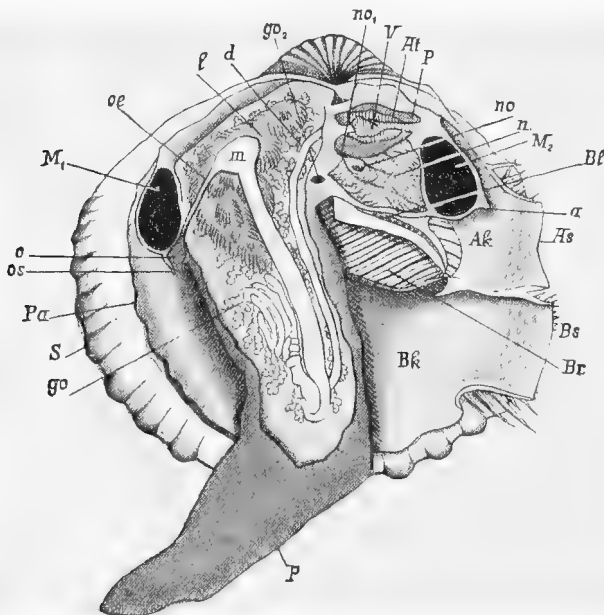

FIG. 26.—Anatomy of *Cardium tuberculatum*, left aspect (after Grobben, Leuckart, and Nitsche, *Zool. Wandtafeln*). *p*, Foot; *go*, gonad; *S*, shell; *Pa*, mantle; *os*, labial palps; *o*, mouth; *M₁*, anterior adductor muscle; *α*, oesophagus; *m*, stomach; *l*, digestive gland; *d*, intestinal canal; *go₂*, genital aperture; *no₁*, pericardial aperture of the kidney; *V*, ventricle; *At*, auricle; *P*, pericardium; *no*, aperture of the kidney in the mantle cavity; *n*, kidney; *M₂*, posterior adductor; *Bl*, point of concrescence of the right and left ctenidia behind the foot; *a*, anus; *Ak*, anal chamber of the mantle cavity, with anal siphon *As*; *Bk*, branchial chamber of the same cavity with branchial siphon *Bs*; *Br*, ctenidium.

(*Cardium* [Fig. 26].) Fam. **Chamidæ**: Dimyarian. Valves of shell unequal. (*Chama*, *Diceras*, *Requienia*.) To these the fossil forms *Monopleuridæ*, *Caprinidæ*, *Hippuritidæ*,⁸ *Radiolitidæ*. Fam. **Tridacnidæ**: Monomyarian. (*Tridacna*, *Hippopus*.)

Sub-Order 5. **Myacæ.**

Dimyarian with folded branchial lamellæ. Tendency towards concrescence of the edges of the mantle folds. Siphons very long and foot large. Fam. **Psammobiidæ**: pedal cleft of the mantle still very large (*Psammobia*). Fam. **Mesodesmatidæ**,

Lutrariidæ, Myidæ (*Mya*, *Corbula*). Fam. **Glycymeridæ** (*Glycymeris*, *Saxicava* [boring mussels]). **Solenidæ**: shell with anterior and posterior cleft; foot very large (*Solenocurtus*, *Cultellus*, *Ensis*, *Solen*).

Sub-Order 6. **Pholadacea.**

Dimyarian with closed mantle and well-developed siphons. Foot varies, and is

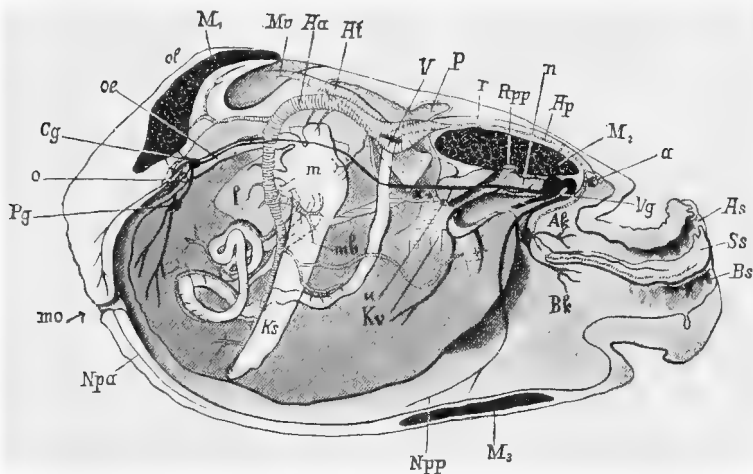

FIG. 27.—**Anatomy of Pholadidea**, left aspect (after Egger). Lettering as before. In addition, *Npa*, *Npp*, anterior and posterior nerves of the mantle edge; *mo*, anterior aperture of mantle; *Ks*, sac of the crystalline stylet; *Kv*, branchial vein; *ol*, anterior upper mantle lobe; *Rpp*, posterior retractor of the foot; *Ss*, partition between the two siphons; *M3*, accessory adductor; *mb*, intestinal caecum; *x*, pericardial section of the kidney, which opens into the pericardium by means of the renal funnel at *u*.

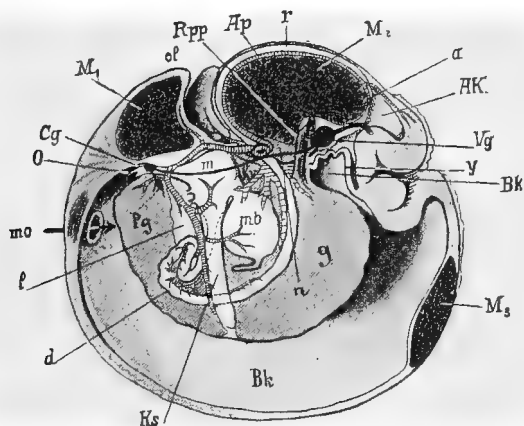

FIG. 28.—**Anatomy of Jouannetia Cumingii**, left aspect (after Egger). Lettering as in last figure.

sometimes rudimentary. Shell open, often having accessory pieces added to it. Fam. **Pholadidæ**: boring mussels (*Pholas*, *Pholadidea* [Fig. 27], *Jouannetia* [Fig. 28],



FIG. 29.—*Teredo Navalis* in its boring, ventral aspect (after Meyer and Möbius). The centre is omitted, the calcareous tube is for the most part uninjured.

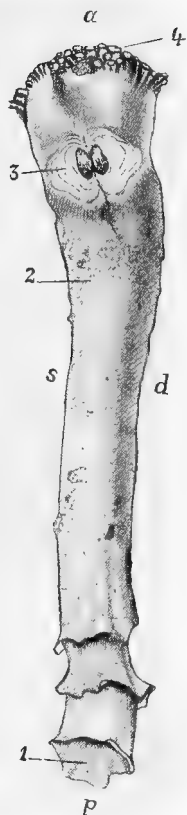

FIG. 30.—Shell of *Aspergillum* (*Brechites*) *vaginiferum*, dorsal view. *a*, Anterior; *p*, posterior; *d*, right; *s*, left; 1, siphonal aperture of the pseudoconch; 2, pseudoconch (calcareous tube); 3, true shell embedded in the pseudoconch; 4, anterior aperture of the pseudoconch.

Xylophaga). Fam. **Teredinidæ**: boring mussels (*Teredo* [Fig. 29]). Fam. **Clavagellidæ** (*Clavagella*, *Brechites* [*Aspergillum*, Fig. 30]).

Sub-Order 7. **Anatinacea**.

Mantle to a great extent closed. With siphons and foot. Hermaphrodite. Fam. **Pandoridæ**, **Lyonsiidæ**, **Anatinidæ** (*Anatina*, *Thracia*).

ORDER 5. **Septibranchia**.

The ctenidium on each side is transformed into a muscular septum pierced by

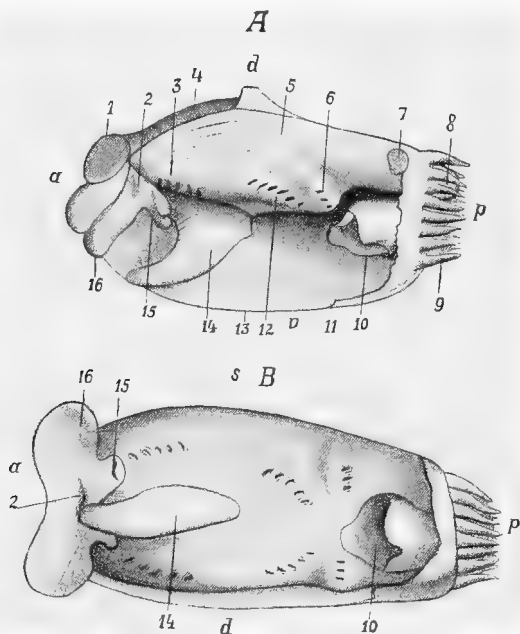

FIG. 31.—Soft body of *Silenia Sarsii* (*Cuspidaria*), after Pelseneer. *A*, Left aspect after removal of the mantle; *B*, ventral aspect after removal of most of the mantle; *a*, *p*, anterior and posterior; *d*, *v*, dorsal and ventral; *d*, *s*, right and left; 1, anterior adductor; 2, mouth; 3, anterior group of branchial slits; 4, hepatic mass; 5, branchial septum; 6, posterior group of branchial slits; 7, posterior adductor; 8, anal siphon; 9, siphonal tentacles; 10, valve of the branchial or inhalent aperture; 11, point where the free mantle edges limiting the pedal aperture fuse; 12, median group of branchial slits; 13, free edges of mantle; 14, foot; 15, posterior labial palps; 16, anterior labial palp.

slits, which divides the mantle cavity into two chambers, one lying above the other. Hermaphrodite. Fam. **Poromyidæ**, **Cuspidaridæ** (Fig. 31 *A* and *B*).

CLASS V.—**Cephalopoda** (Cuttlefish).

Body symmetrical with high visceral dome. The mouth is surrounded by tentacles or prehensile arms, which may be considered as portions of the foot developed round the mouth. Another portion of the foot forms the siphon. In

the posterior mantle cavity there are two or four ctenidia. The heart has two or four auricles, and there are two or four kidneys. Gonad unpaired, with single or paired ducts. The sensory organs are highly developed, especially the eyes, which lie anteriorly and laterally on the "head" (Kopffuss). The jaws and radula are powerful. There is sometimes a shell, either external or internal. An ink-bag is generally present. The Cephalopoda are large, highly-developed marine carnivora. *Dioecious*.

ORDER 1. **Tetrabranchia.**

An external chambered shell, the animal inhabiting the last (and largest) chamber. It is symmetrical, and exogastrically coiled. The mouth is surrounded by numerous tentacles without suckers, which rise from large lobes and can be

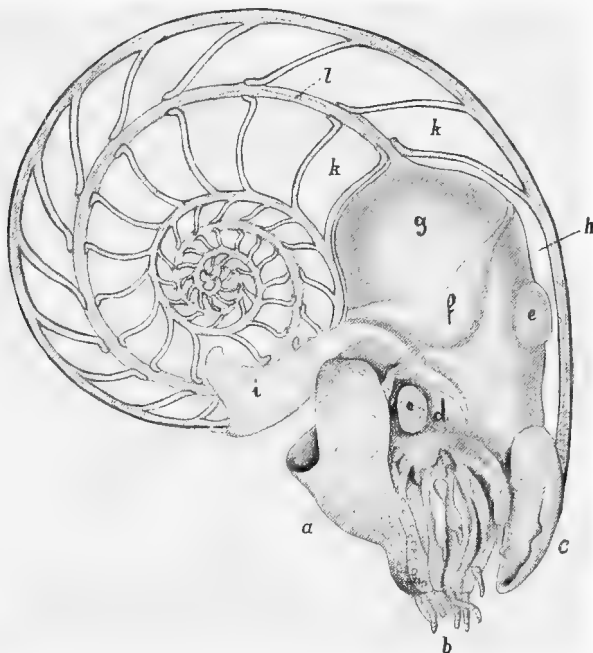
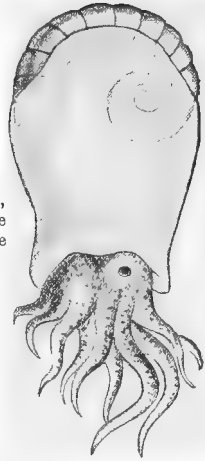

FIG. 32.—*Nautilus Pompilius*, after Owen. Median section of shell. *a*, Cephalic hood; *b*, tentacles; *c*, infundibulum (siphon); *d*, eye; *e*, projection caused by adductor muscle; *f*, point of attachment of the adductor muscle; *g*, upper portion of the visceral dome; *h*, last (inhabited) chamber of the shell; *i*, anterior lobe of the mantle; *k*, last chamber but one; *l*, siphuncle.

retracted into special sheaths. There are four ctenidia, four auricles, and four kidneys. The siphon consists of two lateral lobes distinct from one another, which by the apposition of their free edges form a tube. Without ink-bag. The eyes are simple pits. The only living form is the *Nautilus*, radula 2.2.1.2.2 (Fig. 32). The two large divisions of this order, *Nautiloidea* and *Ammonitidea*,¹ occur as fossils.

¹ The *Ammonitidea*, owing to the uncertainty concerning their anatomy, are by many authorities arranged in a separate order, "*Ammonia*," and placed between the other two.

FIG. 33.—*Spirula prototypus*, right aspect (after Chun and Owen), from Leuckart and Nitsche, *Zool. Wandtafeln*. Both portions of the shell are visible, the inner portion seen through the mantle. The eye should be placed more anteriorly on the "head" (Kopffuss).



A

B

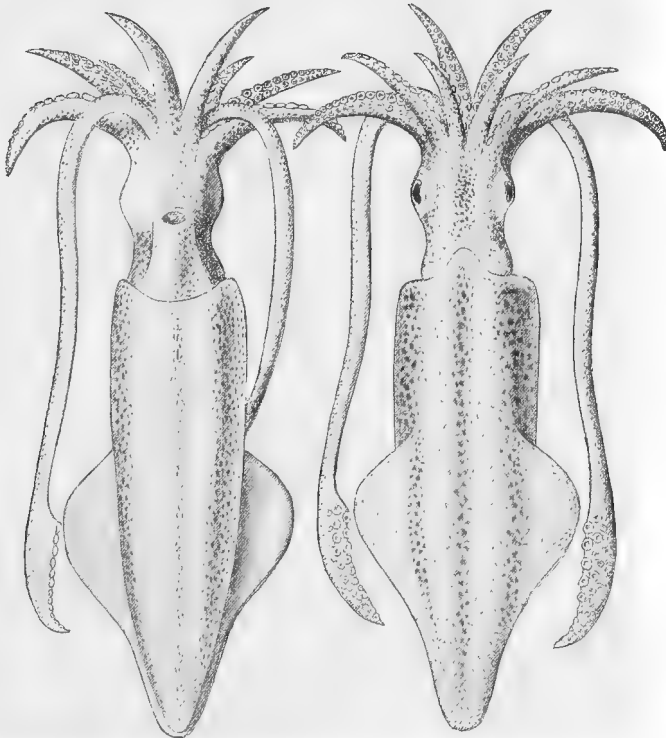

FIG. 34.—*Loligo vulgaris* (after D'Orbigny). A, Dorsal (physiologically ventral) view; B, anterior (physiologically dorsal) view. Of the five pairs of arms, the fourth are seen to be developed as long prehensile tentacles; the eyes, the edge of the mantle, the fins, and the chromatophores in the skin are depicted.

ORDER 2. **Dibranchia.**

The shell is either internal, rudimentary, or altogether wanting. When present it is endogastrically coiled. There are two ctenidia, two auricles, and two kidneys. The mouth is surrounded by eight or ten sucker-bearing prehensile arms. The free edges of the two lobes which form the siphon have grown together. The eyes are vesicular. An ink-bag is present.

Sub-Order 1. **Decapoda.**

Shell internal and often rudimentary. There are ten arms, the fourth pair being developed into long prehensile tentacles, which can be withdrawn into special cephalic cavities. The Decapoda are good swimmers; their bodies are elongated dorso-ventrally, and provided with lateral fins. The oviduct is unpaired. Fam. **Spirulidæ**: internal shell spirally (endogastrically) coiled. *Spirula* (Fig. 33). Fam. **Belemnitidæ**: fossil forms with internal chambered shell, usually long and straight (*Belemnites*, *Spirulirostra*, *Belemnoteuthis*). Fam. **Oigopsidæ** (*Ommastrephes*, radula 3.1.3, *Loligopsis*, *Cranchia*, *Chiroteuthis*, *Owenia*, *Thysanoteuthis*, *Onychoteuthis*, *Ommastrephes*). Fam. **Myopsidæ** (*Rossia*, *Sepiola*, *Sepiadarium*, *Idioscpion*, *Loligo* [Fig. 34], *Sepioteuthis*, *Belosepia* [fossil], *Sepia*, radula 3.1.3).

Sub-Order 2. **Octopoda.**

Without shell or "guard" (rostrum); eight arms; without specialised prehensile tentacles. Body thick, generally without fins, and little adapted for swimming.

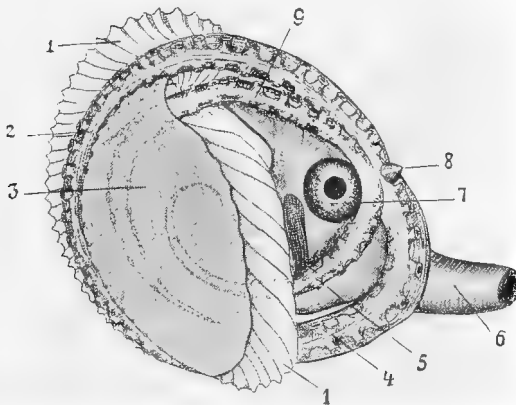

FIG. 35.—Female *Argonauta*, in the swimming position, right aspect (after Lacaze-Duthiers). 1, Uncovered part of the shell; 2, the right arm of the first (anterior) pair, with its lobe-like expansion (sail) 3, covering a large part of the shell; 4, fourth arm; 5, third arm; 6, siphon; 7, eye; 8, jaw; 9, second arm. The second, third, and fourth arms are stretched backwards inside the shell.

Oviducts paired. Fam. **Cirrhoteuthidæ**: with fins. Fam. **Philonexidæ**: *Argonauta* (Figs. 35, 36, and 200, p. 243). Female with external unchambered shell. *Philonexis*, *Tremoctopus*. Fam. **Octopodidæ** (*Octopus*, radula 1.3.1. [Fig. 37], *Eledone*).

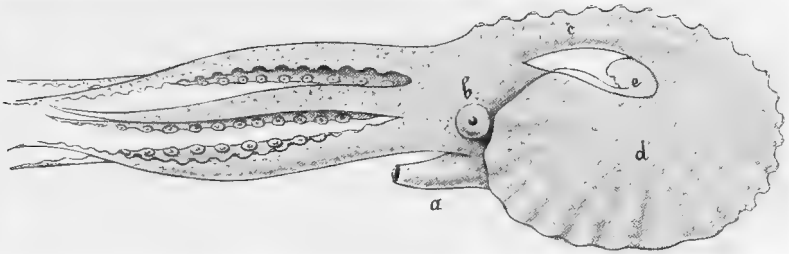

FIG. 36.—Female of *Argonauta Argo* (after VÉRANY). Second, third, and fourth pairs of arms stretched downwards. *a*, Siphon; *b*, eye; *c*, first pair of arms, covering with its sail *d* nearly the whole shell *e*.

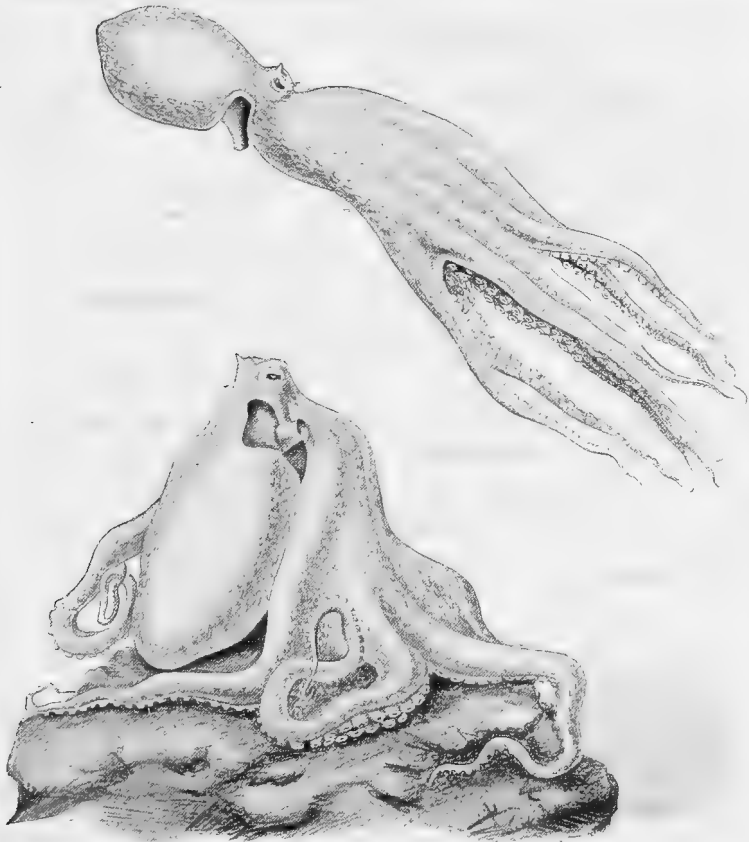

FIG. 37.—*Octopus vulgaris*, after MÉRULIANO (in "Aquarium Neapolitanum"). Above, in swimming position; below, quiescent, watching for prey.

I. Organisation of the Primitive Mollusc.

The hypothetical primitive Mollusc, reconstructed from the results of morphological research, may be described as follows:—

The body is **bilaterally symmetrical** and dorsally arched; its anterior end carries the mouth, eyes, and tentacles, forming a distinct **head**. The ventral side forms a powerful muscular **foot**, distinct from the rest of the body, with a flat sole for creeping.

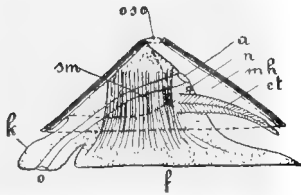

FIG. 38.—**Hypothetical Primitive Mollusc**, diagrammatic, left aspect. *o*, Mouth; *k*, head; *sm*, shell muscle; *oso*, upper aperture of the shell; *a*, anus; *n*, renal aperture; *mb*, mantle cavity; *ct*, ctenidium; *f*, foot.

The soft integument of the arched dorsal side forms a fold, which hangs down all round the body, and is called the **mantle** or **pallium**. The mantle encloses a circular cavity, the **mantle- or pallial cavity**, which surrounds the body, and communicates freely with the surrounding medium between the free edge of the mantle and the foot. The dorsal integument of the body and of the mantle secretes a closely-applied **shell**, which consists of a chitinous matrix (conchyolin) inter-stratified with deposits of carbonate of lime. This shell repeats the form of the dorsal surface, and is thus bilaterally symmetrical and arched. Such a shell detached and turned over would resemble a cup or plate. Since the dorsal shell covers the whole, or at any rate the greater part of the body, it forms a protection for it and at the same time plays the part of a skeleton, to which the muscles running more or less dorso-ventrally into the foot and head, can be firmly attached.

The mantle is of special importance as a protective structure. Apart from the fact that its edge secretes the greater part of the shell substance, and in this way adds to the shell as the animal grows, it covers the delicate **gills**, which thus also share the protection afforded by the shell. Analogous arrangements are to be found in other divisions of the animal kingdom,

The soft integument of the arched dorsal side forms a fold, which hangs down all round the body, and is called the **mantle** or **pallium**. The mantle encloses a circular cavity, the **mantle- or pallial cavity**, which surrounds the body, and communicates freely with the surrounding medium between the free

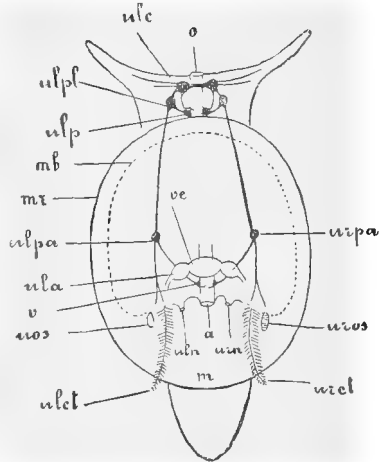

FIG. 39.—**Hypothetical Primitive Mollusc**, from above. *o*, Mouth; *ulc*, *ulpl*, *ulpr*, primitive left cerebral pleural and pedal ganglia; *ulpa*, *urpa*, primitive left and right parietal ganglia; *ula*, primitive left auricle; *uos*, *uros*, primitive left and right osphradia (Spengel's organ); *ulct*, *urct*, primitive left and right ctenidia (gills); *mb*, base of the mantle; *mr*, edge of the mantle; *m*, mantle cavity; *v*, visceral ganglion; *vc*, ventricle; *a*, anus.

e.g. the dorsal fold or carapace which, in the higher Crustacea, covers the branchial cavity, and the operculum of Fishes. The relations existing between the branchiæ, the mantle, and the shell in the Mollusca are of the highest importance; these organs should always be regarded as essentially interdependent structures.

The branchiæ lying in the mantle cavity are paired and symmetrical. It may be left an open question whether the primitive Mollusc possessed more than one pair of gills. If only one, we must suppose that one gill lay on each side of the mantle cavity posteriorly; if more than one, that there was a row of branchiæ on each side.

Each gill is feather-like, with a shaft and two rows of very numerous leaflets. The shaft stands out freely from the body in the mantle cavity. Close to the base of each gill, a sensory organ, considered to be olfactory, and called the **osphradium**, is found. Such a gill with an osphradium at its base has a very definite morphological value; in order to distinguish it from analogous though not homologous respiratory organs found in certain Mollusca, it has been named a **ctenidium**.

The head is provided with one pair of **tentacles** and one pair of **eyes**. The mouth lies anteriorly and ventrally. The remaining openings of the inner organs lie posteriorly above the foot; the **anus** in the middle line, and on each side, between it and the ctenidium (supposing that there is only one pair of ctenidia), an aperture for the sexual organs, and another for the kidney (**nephridium**). These five apertures are covered by the mantle, and thus lie in the mantle cavity. We have thus, to recapitulate, in the posterior part of the mantle cavity two ctenidia, two osphradia, and five apertures, the median anus, and the paired symmetrical sexual and renal apertures. These, taken together, form what is known as the **pallial complex**.

The inner organisation may thus be briefly described.

The intestinal canal. The mouth leads to a muscular pharynx, with horny jaws. At its base lies a chitinous rasp-like ribbon called the tongue or **radula**, which carries numerous consecutive transverse rows of sharp chitinous teeth. Paired **salivary glands** enter the pharynx, which passes into an **œsophagus**, which latter leads into the **mid-gut**. This, which we will suppose to be more or less coiled, runs right through the body, passing posteriorly into a very short **hind-gut**, which opens outward through the median anus. The mid-gut has large **paired glandular diverticula** (mesenteric gland, digestive gland, hepatopancreas, liver).

Musculature.—The muscles of the foot are powerful, and are adapted for the creeping movement. There are, in addition, muscles running from the inner surface of the shell into the foot and head (**columellar** or **shell muscles**), and special muscles for the different organs.

Nervous system.—Two well-developed **cerebral ganglia** lie dorsally in the head, and are connected by means of a short cerebral

commissure, which runs over the oesophagus. Each cerebral ganglion gives rise to two powerful nerve trunks which are provided along their whole length with ganglion cells; there are thus two pairs of nerve trunks running right through the body longitudinally. One pair, the **pedal cords**, run right and left in the foot; the other pair, the **visceral cords**, which lie more dorsally and are more deeply embedded in the body, run through the body cavity. The two visceral nerves are connected posteriorly.

If we leave the *Amphineura* and *Diotocardia* out of the question, the following modified sketch of the Molluscan nervous system holds good. **Two cerebral ganglia, two pedal ganglia, two pleural ganglia** lying at the sides of the pharynx, **two visceral ganglia** lying posteriorly in the body cavity. Giving the name **connectives** to such nerves as unite the ganglia of one side of the body, *i.e.* **dis-similar** ganglia, and that of **commissures** to the nerves that unite the similar ganglia of the two sides of the body, we have the following system: Commissures are found—(1) between the two cerebral ganglia (over the fore-gut); (2) between the two pedal ganglia (under the fore-gut); (3) between the two visceral ganglia (under the hind-gut). The connectives on each side are: (1) the cerebro-pedal connective; (2) the cerebropleural connective; (3) the pleuro-pedal connective; (4) the pleurovisceral connective.

There is a secondary **cœlom** or **body cavity** lined with endothelium, which has at least two divisions. In the anterior division, the **genital chamber**, the sexual products arise from the endothelium; this chamber is connected by means of two canals, the genital ducts, with the mantle cavity. In the posterior chamber, or **pericardium**, lies at least one organ, the heart; this chamber is connected with the mantle cavity by means of two **nephridial ducts** or **vesicles**.

The **circulatory system** is partly vascular and partly lacunar. The arterial **heart** lies in the pericardium above the hind-gut. It consists of one ventricle and two lateral auricles.

II. Review of the Outer Organisation characterising the Chief Groups of the Mollusca.

Having given above a general plan of the morphology of the Mollusca, let us now see how far the various groups of Molluscs agree with this description in their outer organisation. We shall at first only mention in connection with each group those special features which are now considered to be typical or characteristic of that group. In other words, we shall again give a general scheme of the outer organisation of each class of the Mollusca, in order that these more specialised schemes may be compared with that of the hypothetical primitive Mollusc above described.

Later sections will deal with the changes which the separate organs undergo, not only in the different classes, but within one and the same class, so far, that is, as these modifications bear on external morphology.

A. Placophora or Polyplacophora (Chitonidæ).

The body of the Placophora is bilaterally symmetrical, and dorso-ventrally flattened; viewed from the dorsal or ventral surface its shape is that of a long oval. On the ventral side there is a large muscular foot with a flat sole, the outline of which runs very nearly parallel with that of the body. In front of the foot, and also on the ventral side, there is a distinct snout which carries the mouth in the middle of its ventral surface. There are no eyes or tentacles on the head. Between the mantle, which forms the outer edge of the body, and the body and head it covers, there is a deep groove, in the base of which lie numerous lancet-shaped gills, arranged in a single row on each side. These two rows of gills sometimes approach each other so nearly both anteriorly and posteriorly that there is an almost complete circle of gills around the foot, or else they are more or less shortened, and are in some forms so reduced as only to occupy the posterior third of the branchial furrow. The anus lies posteriorly in the median line, ventrally, immediately behind the foot. The two apertures of the nephridial ducts lie in the branchial furrow on each side, and slightly in front of the anus. The two genital apertures lie immediately in front of the nephridial apertures, also in the branchial furrow.

The median dorsal region is covered by eight consecutive imbricating calcareous plates. The peripheral dorsal region, between the edge of the body and these shell plates, carries calcareous spicules, granules, etc. The corresponding peripheral region on the ventral side forms one of the boundaries of the branchial groove, and may be considered as the mantle.

B. Aplacophora, Solenogastres.

The body is here bilaterally symmetrical and vermiform; in section it is round, and is sometimes long and thin, at others short and thick. The large oral aperture lies in the form of a longitudinal slit on the ventral surface of the anterior end of the body. The cloacal aperture—or common opening for the intestinal canal and the urogenital organs—lies ventrally at the posterior end of the body. A narrow median ventral groove runs forward from the cloacal aperture and terminates anteriorly near the mouth. In the base of this pedal groove rises a ciliated ridge or fold which runs along its whole length; this ridge, in cross section, is triangular, and represents the reduced foot. In the *Chaetoderma* both foot and pedal groove are wanting. The Solenogastres have no distinct compact shell; its place is taken by calcareous spicules embedded in the integument.

C. Gastropoda (Cephalophora).

Although there can be no doubt as to the relationship to one another of the Mollusca grouped together in this class, it is almost impossible to give a general scheme of the outer form of the whole class. The greatest variation occurs, the body being sometimes outwardly bilaterally symmetrical, sometimes in a high degree asymmetrical. Further, forms such as *Fissurella*, *Oliva*, *Turritella*, *Cleodora*, *Pterotrachea*, *Phyllirhoe*, *Limax*, *Pleurobranchus*, *Thetys*, differ so greatly in outward appearance that, at the first glance, it is almost impossible to believe that they are related. A shell may be present, and may show the most marvellous variation in form; or it may be rudimentary or even (in adult forms) altogether wanting. The foot also may assume the most varied forms, or may be entirely wanting. The same may be said of the mantle fold, the gills, etc.

Setting aside those forms which are quite one-sidedly differentiated, it may be said in general—(1) that, in the Gastropods, the protective shell consists of one piece, and follows in a remarkable way the forms assumed by the body; (2) that the dorsal portion of the body, which contains the viscera, becomes constricted almost hernia-like from the head and foot, making a sac-like protuberance (visceral dome); (3) that, for the diminution of its surface, this dome or hump becomes coiled spirally, the shell repeating its shape; (4) that the head and foot, which project through the aperture of this shell for purposes

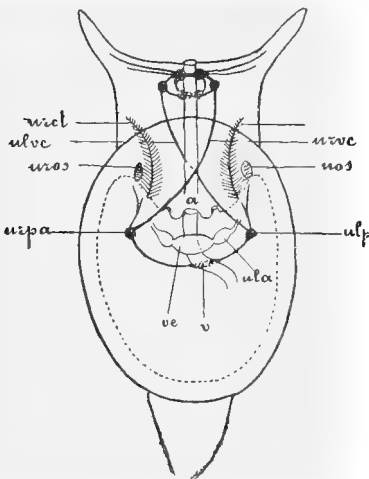

FIG. 40.—Diagram of the Organisation of a Zeugobranchiate Diotocardian. *a*, Anus; *ve*, ventricle; *ula*, right auricle; *urvc*, left tentidium; *uosc*, left osphradium.

of locomotion, can be withdrawn into it. The large, long foot generally has a flat sole for creeping. The head is distinct, and provided with tentacles and eyes. At some part of the body, the integument of the visceral dome forms a mantle fold which hangs downwards, covering and protecting the respiratory organs. The outer surface of this mantle takes part with the rest of the integument of the visceral dome in the formation of the shell. The following are more special descriptions of the outer organisation of the chief Gastropodan groups.

I. Prosobranchia.

The large visceral dome is coiled spirally, generally to the right (dextrally), the shell naturally assuming the same form. The well-

developed foot has a flat creeping sole. On the dorsal side of the posterior portion of the foot, the metapodium, there is a calcareous plate, the **operculum**, which, when the animal withdraws its head and foot, closes the aperture of the shell. The mantle fold hangs down from the anterior side of the visceral dome, and covers the spacious branchial or mantle cavity, in which lie certain organs of special morphological importance. These, which may be called the mantle or pallial organs, are, in such forms as may be considered primitive, (1) the anus, which lies, not posteriorly, but on the anterior side of the visceral dome, shifted forwards towards the mouth; (2) the two apertures of the paired nephridia, one on each side of the anus; (3) the two gills, one to the left and one to the right; (4) the two osphradia near the bases of the gills. In most Prosobranchia, however, the organs just mentioned as paired are unpaired; only the gill, nephridial aperture, and osphradium to the left of the anus being retained, while the hind-gut with the anus moves to the right side of the mantle cavity. The single genital aperture lies on the right side, in the head, or on the floor of the mantle cavity. (In the Prosobranchia the sexes are separate.) The abortion of one of each of these originally paired organs, gills, nephridia, and osphradia, produces a very striking asymmetry of the whole body. The name Prosobranchia indicates the fact that the gills lie in front of the heart.

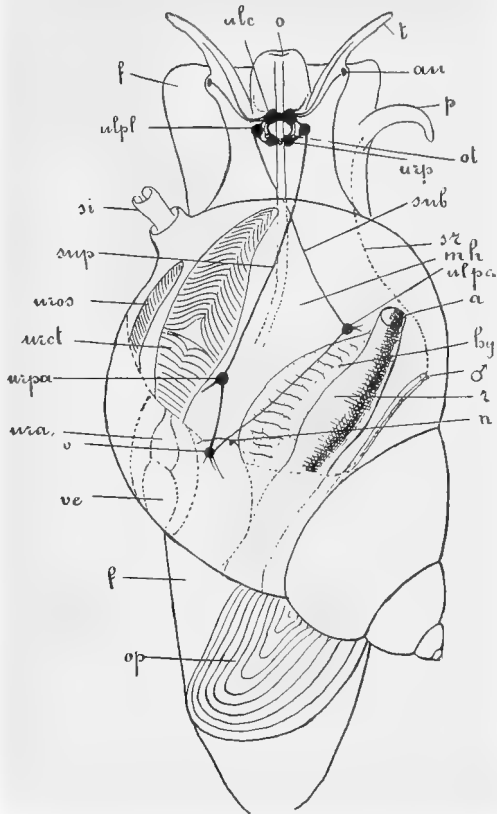

FIG. 41. Diagram of a Prosobranchiate Monotocardian. The outer form, shell, mantle, pallial complex, heart and pericardium, nervous system and operculum, are depicted. Lettering mostly as in Fig. 39. In addition: *f*, foot; *si*, siphon; *sup*, *sub*, supra- and sub-intestinal connectives; *op*, operculum; *ot*, auditory organ; *p*, penis; *sr*, seminal groove; *mh*, mantle cavity; *hg*, hypobranchial gland; δ , male genital aperture; *r*, rectum; *au*, eye; *t*, tentacle.

2. Pulmonata.

Type: *Helix pomatia*.—The visceral dome is well developed, and protrudes hernia-like from the rest of the body; it is dextrally coiled, and has a corresponding shell. The foot is large and long, and has a flat creeping sole. The head has two pairs of feelers, one of which carries the eyes. The mantle fold hangs down from the anterior side of the visceral dome, and covers a spacious mantle cavity (respiratory or pulmonary cavity). The free edge of the mantle fold unites with the integument of the neck near it, only leaving an aperture to the right, the respiratory aperture. This aperture serves for the inhalation and exhalation of the air. The anus and the unpaired nephridial aperture lie close to the respiratory aperture, and are thus on the right side. There are no gills in the mantle cavity, which contains air. Respiration takes place at the inner surface of the mantle fold, in which runs a fine network of vessels lying in front of the heart. The foot, unlike that of

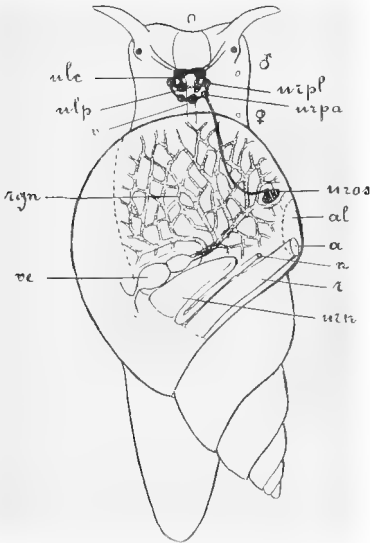

FIG. 42. Diagram of a Basommatophoran Pulmonate. *al*, Respiratory aperture; *rgn*, vascular network on the inner surface of the mantle. The kidney is incorrectly drawn. Further lettering as in Figs. 39 and 41.

the *Prosobranchia*, has no operculum. There is a common genital aperture on the neck, to the right, in front of the respiratory cavity (the Pulmonata being hermaphrodite). Many Pulmonata, however, differ greatly in their outer organisation from the *Helix* type.

3. Opisthobranchia.

The respiratory organs lie behind the heart.

(a) *Tectibranchia*.—The visceral dome is usually not large. It may be either spirally coiled or symmetrical, and is covered by a variously shaped shell. The foot is large, and usually has a flat sole for creeping. The head is variously shaped, and often carries tentacles or rhinophores, and unstalked eyes. The small mantle fold hangs down from the right side of the visceral dome, and often does not quite cover the single gill lying beneath it. The anus lies behind the gill, more or less removed from it. The Tectibranchia are, like all Opisthobranchia, hermaphrodite; the genital

D. Scaphopoda.

The body is symmetrical and long, *i.e.* the visceral sac is elongated dorso-ventrally, and is completely enveloped in a tubular mantle. The mantle cavity lies posteriorly, and is prolonged ventrally far enough to allow the snout and retracted foot to be completely concealed in it. Besides the large ventral aperture, there is a smaller dorsal aperture further placing the mantle cavity in communication with the exterior. The shell, like the mantle, is tubular, or like a tapering cone, slightly curved anteriorly. It has two apertures corresponding with those in the mantle. The head is developed into a barrel-shaped snout, and has no eyes. The mouth, which lies at its ventral end, is surrounded by a circle of leaf-like tentacles. At the base of the snout there arise two tassels of long filamentous contractile tentacles, which hang down into the mantle cavity and can be projected far beyond the ventral aperture. Behind the snout, the cylindrical muscular foot rises from the body, and can be protruded downwards. There are no gills. The

median anus lies posteriorly above the foot. The two nephridial apertures are at the sides of the anus. There are no special genital apertures (Figs. 44 and 101, p. 113).

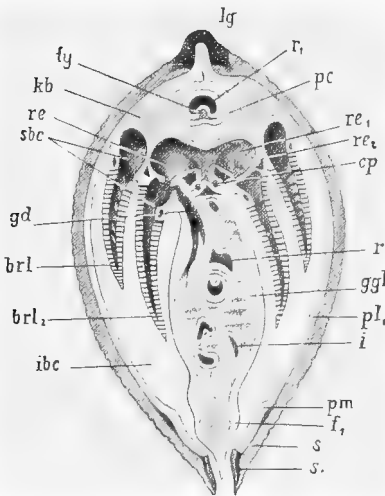

FIG. 45.—Transverse section of *Anodonta cygnæa* (ordinary freshwater mussel) (after Howes). *lg*, Ligament; *ty*, typhlosole; *kb*, pericardial gland (Keber's organ); *re*, kidney (glandular portion); *sbc*, chambers at the bases of the gills; *gd*, genital ducts; *brl1*, *brl2*, outer and inner branchial lamellæ; *ibc*, mantle cavity; *s*, shell; *s1*, edge of the shell; *f1*, foot; *pm*, pallial muscle; *i*, intestine; *pl1*, right mantle fold; *ggl*, gonad; *r*, rectum; *cp*, cerebro-pedal connective; *re1*, non-glandular vestibule of kidney; *re2*, renal aperture; *pc*, pericardium.

E. Lamellibranchia.

The body is bilaterally symmetrical; somewhat elongated (from before backward). The integument forms leaf-like mantle folds to the right and to the left, which at their bases are attached to the trunk along its whole length, and grow down ventrally. If the body of a Lamellibranch, from which the shell has been removed (the foot being retracted), be viewed from the side, the outline will be found to be formed, dorsally, by the dorsal median line of the body; anteriorly, posteriorly, and ventrally by the free edge of the mantle fold. The two mantle folds enclose a space whose transverse axis is always markedly shorter than either its dorso-ventral or its longitudinal axis, *i.e.* the animal with its mantle is laterally compressed.

Projecting into the mantle cavity, there is a large muscular process of the body, the foot, which is directed downward and somewhat forward, and can be protruded between the free edges of the mantle. This foot is also laterally compressed. In certain cases which, though exceptional, deserve special mention, its free end is flattened, and it thus has a flat sole. The outer surface of the trunk and mantle folds secretes a bivalve shell which covers the whole body. One valve lies to the right, the other to the left of the median plane, and the two are exactly alike. Each valve repeats the outline of its own side of the trunk with its mantle fold.

The two valves articulate dorsally, and are open anteriorly, ventrally, and posteriorly. Two strong muscles (adductors) run transversely

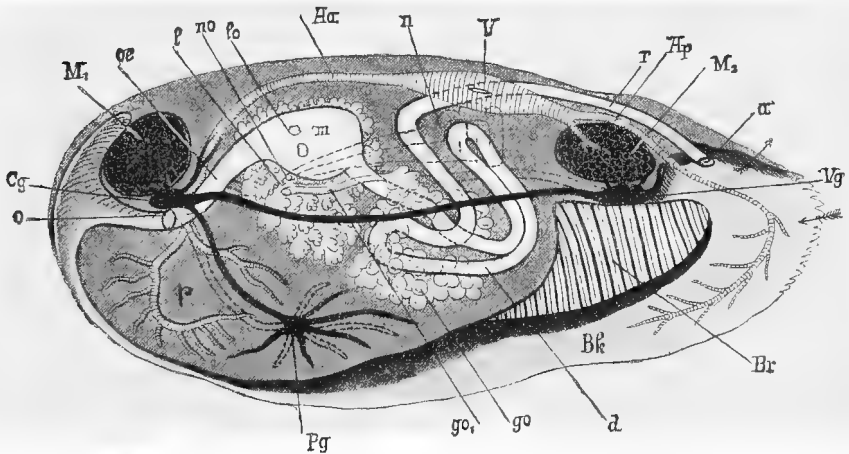

FIG. 46. **Anatomy of *Unio (Margaritana) margaritifera*, left side (after Leuckart and Nitsche).** *o*, Mouth; *Cg*, cerebral ganglion; *M₁*, anterior adductor muscle; *a*, oesophagus; *l*, digestive gland (liver); *no*, nephridial aperture; *lo*, apertures of the digestive gland in the stomach *m*; *Aa*, anterior aorta; *n*, nephridium, the outline given in dotted lines; *V*, heart; *r*, hind-gut; *Ap*, posterior aorta; *M₂*, posterior adductor; *a*, anus; *Vg*, visceral ganglion; *Br*, gill; *Bk*, mantle cavity; *go*, gonads with genital duct *go₁*; *Pg*, pedal ganglion; *p*, foot. The arrows indicate the direction of the inhalent and exhalent streams of water.

from one valve to the other. Their contraction serves to shut the shell completely. One of these muscles lies anteriorly, the other posteriorly. Their points of attachment produce impressions on the inner surface of the shell, which are always distinctly visible when the shell is removed.

The mouth lies below the anterior adductor, between it and the anterior base of the foot. The anus lies behind the posterior adductor. There is no distinct head. Near each side of the mouth, the body carries two leaf-like processes, the oral lobes or labial palps. At the line of insertion of the foot in the mantle cavity, a longitudinal ridge rises on each side in the middle and posterior regions of the body; this carries two rows of long branchial leaflets. There is thus,

on each side of the mantle cavity, one plumose gill, the shaft of which is attached lengthwise to the body (Figs. 45, 46, etc.).

In various divisions of the Lamellibranchia, the outer organisation deviates very greatly from the above.

F. Cephalopoda.

The body is bilaterally symmetrical. The visceral dome is large and often much elongated dorso-ventrally. The head is more or less distinct, and is surrounded by the foot, which is transformed in a peculiar manner. The foot has, in fact, grown round the head, and has developed numerous differently-shaped processes (arms and tentacles) arranged in a circle round the mouth; these serve principally for seizing and holding prey. In viewing the body of a Cephalopod, it must be remembered that the apex of the visceral dome (which a casual observer might take to be the posterior end of the body) is really the highest dorsal point, while the head and its arms lie lowest. We may thus distinguish, both in the visceral dome and in the transformed foot which has been combined with the head, and drawn out into tentacles, an anterior and a posterior part (which to a casual observer would seem upper and lower parts), and a right and a left side. This at first sight seems a paradox to those not acquainted with the comparative anatomy of the Mollusca, since the normal position in the water of certain well-known Cephalopods does not agree with it. A *Sepia*, for example, swims or lies at rest in such a way that the strongly pigmented anterior side of the visceral dome and of the "head" (Kopffuss) is uppermost, and the posterior side lowermost. The accompanying diagram illustrates the strict morphological position of the body, which alone concerns the comparative anatomist (Fig. 47).

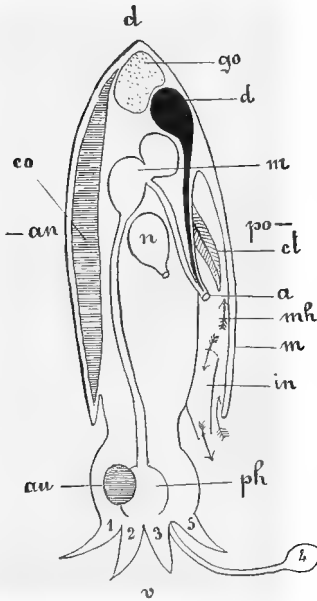

FIG. 47.—Diagram of *Sepia*, median section from the left side. *v*, Ventral (physiologically anterior); *d*, dorsal (physiologically posterior); *an*, anterior (physiologically upper); *po*, posterior (physiologically lower); 1, 2, 3, 4, 5, the five arms of the left side; *au*, eye; *co*, internal shell; *go*, gonad; *d*, pigment gland = ink-bag; *m*, stomach; *n*, kidney; *ct*, ctenidium; *a*, anus; *mh*, mantle cavity; *in*, siphon. The arrows indicate the direction of the respiratory current.

On the right and left of the "head" there is a highly-developed eye, and near it an olfactory pit.

The mantle fold hangs down posteriorly from the visceral dome, covering a spacious mantle- or respiratory cavity, which communicates

with the exterior at the free edge of the mantle fold, above the "head." Within the mantle cavity there are two or four gills, arranged symmetrically, the median anus, and the apertures of the sexual and excretory organs. Two symmetrical lobes are found on the posterior lower side of the visceral dome; the edges of these are apposed in such a way as to form a tube, the funnel or **siphon**, one aperture of which lies in the mantle cavity, while the other protrudes from the mantle cleft. The respiratory water enters the mantle cavity through the mantle cleft, and escapes through the siphon. The fæcal masses, waste and sexual products, and the secretion of the ink-bag also leave the body through the siphon. Originally, no doubt, all Cephalopoda possessed a shell which covered the whole visceral dome as well as the mantle fold. In recent Cephalopods the shell is rarely developed in this way; it is often rudimentary, and may, indeed, be altogether wanting. Recent Cephalopods fall into two entirely distinct divisions, the Tetrabranchia and the Dibranchia.

The Tetrabranchia (*Nautilus*, Fig. 48).

These have a shell coiled anteriorly (exogastrically) in the plane of symmetry, and divided by septa into consecutive chambers. The animal occupies the last and largest chamber; the others contain gas.¹ The septa separating the consecutive chambers are pierced in the middle to allow of the passage of a **siphuncle**, which runs through all the compartments, and is attached to the visceral dome. That portion of the foot which surrounds the mouth is produced into numerous tentacles, which can be retracted into special sheaths.

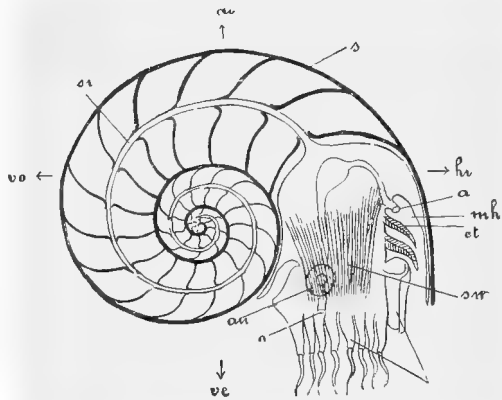

FIG. 48.—Diagram of *Nautilus*, left view. *ve*, Ventral; *do*, dorsal; *vo*, anterior; *hi*, posterior; *f*, foot (tentacles and siphon); *sm*, shell muscle; *ct*, ctenidia; *mh*, mantle cavity; *a*, anus; *s*, shell; *si*, siphuncle; *au*, eye; *o*, mouth.

The anterior portion of the foot, which lies in front of and over the head, is widened out into a concave lobe, the **hood**; this is applied to the outer surface of the occupied chamber of the shell anteriorly, and, when the tentacles are withdrawn, can close its aperture. The hood carries two tentacles, and on each side of the head there is an eye.

¹ Or water; *v.* Ford's Introduction to *Brit. Mus. Cat.*, Fossil Cephalopoda, 1889.

Above the head, the mantle fold encircles the whole body. It is short at the sides, but anteriorly it forms a large lobe which is folded back over the shell in the way shown in Fig. 32, p. 22. Posteriorly, the mantle covers a very deep cavity which contains the whole posterior side of the visceral dome. The siphon consists of two entirely distinct lateral lobes (epipodial lobes), whose free edges overlap in such a manner as to form a tube, open above and below. As we shall see later, this siphon is a part of the foot. Deep down in the mantle cavity, two pairs of pinnate gills—a lower and an upper pair—spring from the visceral dome. Nine apertures of inner organs are also found in this cavity; a single median anal aperture, and four paired apertures, viz. one pair of genital, two pairs of nephridial, and one pair of visceropericardial apertures. The position of these is depicted in Figs. 78 and 79, p. 82.

The Dibranchia.

With one exception, viz. the female *Argonauta*, which has an external unchambered shell, the Dibranchia either have an internal shell lying on the anterior side of the visceral dome, covered by an integumental fold, or no shell at all. The visceral dome is sometimes compact and pouch-like (in reptant animals, Fig. 37), sometimes, in the good swimmers, much elongated dorso-ventrally, produced dorsally to a point, and flattened antero-posteriorly (Fig. 34). In the latter case, the body is further generally encircled by a fin-like integumental fold, which marks the limit between the anterior and posterior sides of the visceral dome.

The "head" is usually distinct from the visceral dome, and carries to the right and left the well-developed eyes. The mouth is surrounded by eight or ten arms for seizing prey; these are provided with suckers on their lower adoral sides.

The mantle fold covers nearly the whole posterior surface of the visceral dome, and thus encloses a very deep and spacious cavity. Laterally and anteriorly to the visceral dome, the mantle fold is continued as a narrow border which, immediately above the "head," covers a shallow groove or furrow.

The two lateral lobes which form the siphon of the Tetrabranchia have in the Dibranchia grown together at their free edges, and form a tube open at each end. There are only two gills in the mantle cavity, one right, and one left. Near the upper siphonal aperture in the mantle cavity lie the anus, and the genital and nephridial apertures as well as that of the ink-bag. Details as to the arrangement and number of these apertures will be given further on.

III. The Integument, the Mantle, and the Visceral Dome.

The whole body is covered by a single layer of epithelium, which, in parts not protected by the shell, may be more or less ciliated. This layer is very rich in glands which are almost exclusively unicellular; some of these lie in the epithelium itself, while some have sunk into the subjacent tissue, their ducts, however, passing between the epithelial cells.

The layer immediately beneath this body epithelium is called the corium, and consists of connective tissue and muscle fibres. It is, however, not distinctly marked off from the tissues beneath it.

The pigment is almost always found in the cells of the subepithelial connective tissue.

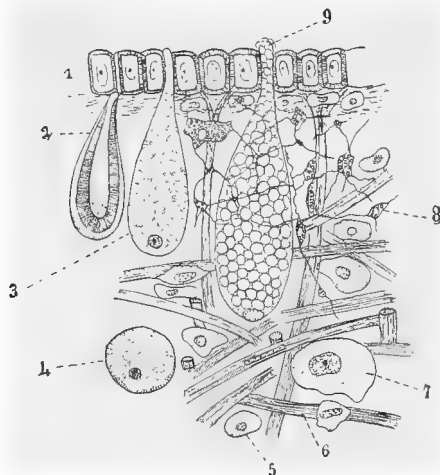

FIG. 49.—Section of the integument of *Daudebardia rufa* (after Plate). 1, Epithelium; 2, 3, 9, various forms of unicellular glands; 4, globular pigment cells; 5, 7, unpigmented cells of the connective tissue; 6, muscle fibres; 8, branched and anastomosing cells of the connective tissue containing pigment.

A. Placophora. (Cf. the sketch of the Outer Organisation, p. 29.)

The *Chiton* is provided dorsally with eight consecutive shell-plates (Fig. 1, p. 2), which overlap in such a manner that the posterior edge of each plate covers the anterior edge of the next. These plates are bilaminar. The outer and upper layer which forms the dorsal surface is called the **tegumentum**, the lower hidden layer the **articulamentum**. As a rule, the tegumentum of the anterior plate only is as large as the articulamentum beneath it; in the other plates, the latter is the larger and projects beyond the former laterally and anteriorly. These projecting parts of the articulamentum, called **apophyses**, slide under the plate next in order anteriorly. Between these two layers, tissue is found, which is a continuation of the dorsal integument. The tegumentum is penetrated by canals of various sizes, which open at its surface through characteristically arranged pores.¹ The tegumentum consists of a horny or chitinous substance, which may be considered as a cuticular formation, impregnated with calcareous salts. The articulamentum is compact and free from canals; it contains little organic substance, and much calcareous salt. **It alone answers to the shell of other Molluscs**, while the tegumentum must be considered as a calcified cuticle covering the true shells (the articulamenta) as a continuation of the cuticle of the zone which encircles the eight shell-plates. This zone carries

¹ On the relation of these canals and pores to peculiar sensory organs and eyes on the shell of the *Chiton*, cf. section on Sensory Organs, p. 166.

chitinous or calcareous spines, setæ, scales, granules, etc., varying in number and arrangement according to the genus and species.

Each spine, as a rule, arises as a globular vesicle within an epithelial papilla and above a very large formative cell (Fig. 50). As it grows, it is pushed upwards by the newly-forming cuticular layers. The formative cell at its base persists, but remains connected with the epithelial papilla only by a protoplasmic process which continually lengthens, and may surround itself with a nucleated sheath. In fully-developed spines, the remains of this cell are still found as a small terminal swelling (Endkölbchen).

There are, however, spines and specially flat scale- or plate-like calcareous formations in the integument which do not arise from single large formative cells, but are probably produced by several cells in the base of an epithelial papilla.

FIG. 50.—A, B, C, Three stages in development of a spine in the Chiton (after Blumrich), diagrammatic. *st*, Spine; *bz*, its formative cell; *e*, epithelium; *c*, thick cuticle secreted by the epithelium; *ek*, terminal swelling (Endkölbchen) = remains of the formative cell.

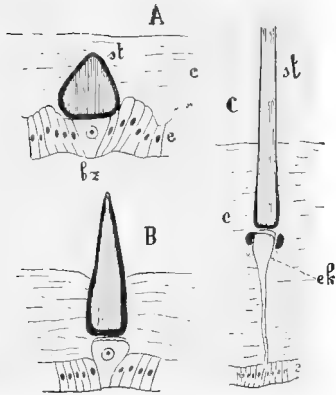

Just as we have recognised the tegmentum covering the articulamenta to be merely a special portion of the general cuticle, so we may further recognise in the articulamenta the homologues of the calcareous spines, scales, etc., which are developed in the integument of the mantle. The articulamenta

would thus be nothing more than very large and expanded calcareous scales.

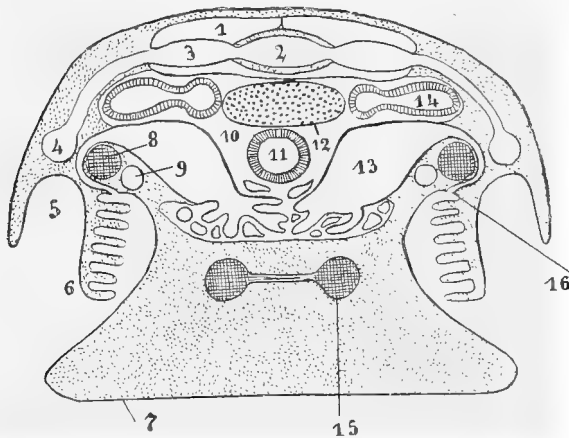

FIG. 51.—Transverse section through a Chiton near the nephridial apertures, highly diagrammatic (after Sedgwick), somewhat modified. 1, Pericardium; 2, ventricle; 3, auricle; 4, branchial "vein"; 5, branchial groove (mantle cavity); 6, gill (ctenidium); 7, foot; 8, pleuro-visceral connective; 9, branchial "artery"; 10, secondary coelom; 11, intestine; 12, posterior portion of the gonad lying below the pericardium; 13, 14, the two posterior branches of the nephridium, one of which (13) opens into the branchial groove (at 16), the other (14) being connected in a way not here depicted with the pericardium; 15, pedal nerves.

This view, finally, leads to the conclusion that the shell (if it may here be so

called) of the Molluscs originally consisted of isolated calcareous spicules or spines, which were enclosed in a thick cuticle, and projected from the same as in the *Pronomenia*, *Neomenia*, etc. (v. below).

In *Cryptochiton* the shell is internal, *i.e.* it is entirely covered by a fold of the integument, which grows over it from all sides. It consists exclusively of the articulamentum, since the whole dorsal integument is covered by an even cuticle, which therefore forms no tegumentum.

The only part of a *Chiton* which can be called the mantle fold is the marginal zone of the body, the ventral side of which encircles the head and foot and forms the lateral boundary of the branchial groove or furrow. Just as the dorsal side of this mantle, which is called the zone, carries large spines, setæ, or scales, so may the under surface be covered with small closely-crowded spines. The rest of the integument is bare, being merely covered with a simple epithelium.

The genus *Chitonellus* is of great importance in comparing the outer organisation of the Placophora with that of the *Solenogastres*. The body is not dorso-ventrally flattened, as in the *Chiton*, but nearly cylindrical; the ventral surface, however, is flattened (Fig. 52), and has a median longitudinal groove. The foot is not externally visible, but can

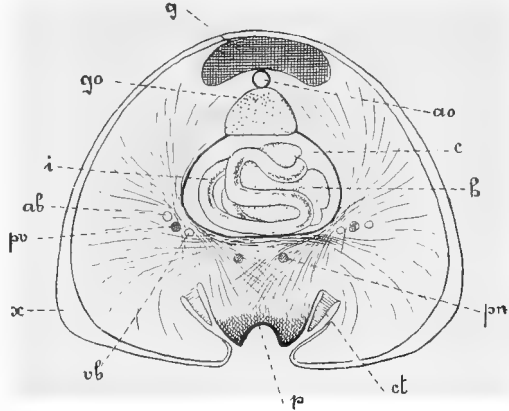

FIG. 52.—Transverse section of *Chitonellus*, diagrammatic, adapted from figures by Peiseneer and Blumrich. *g*, Shell (articulamentum); *go*, gonad; *i*, intestine; *ab*, *vb*, branchial arteries and veins; *pv*, pleuro-visceral nerves; *x*, latero-ventral thickening of the cuticle; *p*, foot; *ct*, ctenidium; *pm*, pedal nerve; *h*, digestive gland (liver); *c*, secondary coelom; *ao*, aorta.

be discovered, much reduced, in the base of the median groove, itself possessing a ventral median groove representing a narrow contracted sole. The flat ventral surface is therefore the mantle. In the narrow cleft on each side, between mantle and foot, in the posterior half of the body, lie the gills. The lateral margin of the body in *Chiton* is represented in *Chitonellus* by a mere blunted ridge, which is almost exclusively caused, as may be seen in transverse sections, by a great thickening of the cuticle.

B. Solenogastres.

In the Solenogastres (Aplacophora), whose outer organisation has already been sufficiently described (p. 29), the shell is altogether wanting, but the cuticle secreted by the epithelium over the whole body is usually exceedingly thick (Fig. 53). It contains calcareous spicules, which sometimes project above the surface. These, like the spines of the *Polyplacophora*, rise from cellular cups, which are connected with the basal epithelium of the cuticle by nucleated stalks. There can be no doubt that the spicules are formed by these cups and nourished by them during growth. The foot, as we have seen, is reduced to a narrow ciliated longitudinal ridge, which rises from the base of the medio-ventral groove. The term mantle is here inapplicable, except perhaps to the integument which forms the lateral boundary of this groove.

In *Chaetoderma* the foot finally atrophies, and the medio-ventral groove also disappears.

The long series of undoubtedly primitive characteristics in these two groups—the

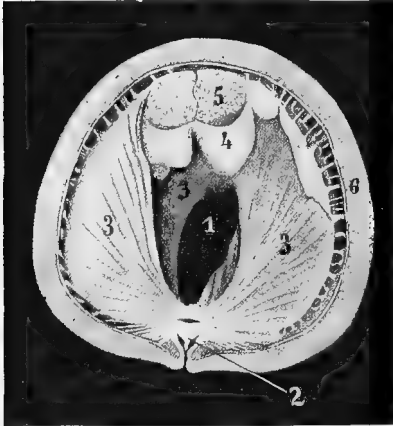

FIG. 53. — Transverse section of *Proneomenia Sluiteri* in the region of the mid-gut. 1, Mid-gut; 2, rudimentary foot; 3, sepia projecting into the mid-gut; 4, testicular portion of the gonad; 5, ovarian portion of the same; 6, thick cuticle secreted by the epithelium.

Placophora and *Solenogastres*—obliges us to place them, as we shall have repeatedly to point out, near the root of the Molluscan phylum. In some points the *Solenogastres* are perhaps more primitive than the *Polyplacophora*, and the vermiform body, the slight development of the mantle, the foot and the gills have been thought to be primitive characteristics. More recently, however, it has been maintained, as the present writer thinks, with justice, that these conditions are rather the result of secondary adaptation to a limicolous habit of life (most *Solenogastres* inhabiting mud). The shell, mantle, gills, and foot are such essential characteristics of the Mollusca that we must assume their existence in the racial form.

The series *Chiton*, *Chitonellus*, *Nomenia*, *Chaetoderma* does not, therefore, illustrate for us the rise and development of typical Molluscan

characteristics, but rather their progressive obscuration and disappearance.

C. Gastropoda. (Cf. Sketch of Outer Organisation, pp. 30-33.)

Integument.

The free edge of the mantle, which takes the chief part in the formation and growth of the shell, is particularly rich in **mucous, pigment, and calcareous glands**.

The epithelium is ciliated over areas of varying extent, especially in aquatic Gastropods. In many of the shell-less *Opisthobranchia* the whole surface of the body is ciliated.

The remarkable marking and colouring of the integument especially seen in the *Nudibranchia* are caused by pigment cells, which are more often found in the cutis than in the epithelium.

Where there is no firm shell, calcareous granules or spicules may be found scattered throughout the cutis.

In several *Nudibranchia* **stinging cells** have been discovered in the integument.

Mantle, Visceral Dome.

The mantle fold is, as a rule, well developed in Gastropods, and covers a spacious pallial cavity. Whenever the fold is small or altogether wanting, the condition is secondary rather than primitive.

1. Prosobranchia.

In the Prosobranchia, the mantle fold develops on the anterior side of the visceral dome, and there covers a spacious cavity. It further usually extends like a narrow collar right round the base of the visceral dome.

In the symmetrical *Fissurellidæ*, the mantle cavity is short, and opens outwardly by means of a dorsal aperture through the mantle fold, which corresponds with the perforation at the apex of the shell. A circular fold, provided with a highly sensitive fringe, is formed by the mantle around the aperture, and projects for a short distance beyond the perforation in the shell. The water needed for respiration passes into the pallial cavity through the slit-like aperture at the free edge of the mantle fold, over the nuchal region, and flows out through the apical aperture just described. This aperture also serves for the ejection of excretory matter from the rectum, which lies immediately behind it. In *Rimula*, the apical apertures in shell and mantle have moved somewhat forward, and lie anteriorly between the apex and edge of the shell. In *Emarginula*, the mantle has an anterior cleft, the edges of which, in the living animal, are folded in such a way as to form a tubular siphon, which can be protruded through the marginal cleft of the shell. In *Paranophorus* there is no second opening into the mantle cavity, but the lateral edges of the mantle are very much widened, and bent back dorsally over the outer surface of the shell in such a way as to cover the greater part of it.

In *Haliotis*, the enormous development of the columellar muscle on the right side confines the mantle cavity to the left. The mantle fold has a long slit reaching from its edge to the base of the pallial cavity. This slit lies under a row of perforations in the shell which are characteristic of *Haliotis*, and through these the respiratory water is expelled. In the spaces between the consecutive perforations, the edges of the mantle cleft are apposed, merely separating beneath each aperture to allow of free communication between the cavity and the exterior. The edges carry three tentacular processes, which can be thrust outward through the perforations. The anus is always found under the posterior perforation. The edge of the mantle surrounding the body splits into two narrow lamellæ, which bend round to form a groove for the reception of the edge of the shell.

The *Trochidæ*, *Turbinidæ*, *Neritidæ*, and nearly all *Monotocardia* have no second aperture and no mantle cleft.

In *Docoglossa* (*Patella*, etc.) the mantle forms a circular fold round the visceral dome, which is in the form of a blunt cone. It covers the edge of the almost circular broad-soled foot. The mantle is broadest anteriorly, where it covers the head and neck, *i.e.* the pallial cavity or groove is here deepest.

The visceral dome, in the *Monotocardia*, is almost always distinctly constricted at the base, and spirally coiled. The pallial cavity occupies its typical position. In many *Monotocardia*, the free edge of the mantle fold is prolonged on the left side, projecting forward, sometimes to a great extent; the lower edges of this projecting fold bend round towards each other to form a tube or semi-cylindrical channel, which is called the siphon. Through this siphon, the water needed for respiration flows into the mantle cavity. It can generally be told, by the shape of the shell, if there is a siphon or not, since most *Monotocardia* which possess one have either a notch in the edge of the shell at the columella, or a process called the canal or beak, at this same point, which encloses the siphon. The length of this latter canal need not, however, correspond with that of the siphon.

The *Monotocardia* have even been grouped, according to the presence or absence of a siphon, into the *Siphoniata* or *Siphonostomata*, and the *Asiphoniata* or *Holostomata*; but this classification is artificial, since siphons are sometimes present and sometimes absent in forms which are undoubtedly nearly related.

In most *Monotocardia*, the shell is not outwardly covered by the mantle, but in some groups, the edges of the mantle bend back over the shell, and finally grow over it to such an extent as to unite above it. The external shell in such cases becomes an internal shell.

In the *Harpidæ* among the *Rhynchoglossa*, the mantle bends back over the columellar lip of the shell. In the *Marginellidæ*, it covers a large part of the outer surface, and the same is the case in *Pyrula* among the *Tuenioglossa*, in most *Cypræidæ* and in the *Lamellaridæ*. In *Lamellaria*, the shell is completely grown over by the mantle. In *Stilifer* among the *Eulimnæ* also, the shell is more or less covered by the mantle.

The edge of the mantle may be fringed or notched, or (*Cypræidæ*) provided with wart-like, tentacular, or branched appendages.

2. Pulmonata.

In the Pulmonata, the arrangements of the mantle fold and visceral dome and of the shell, which is intimately connected with them, are of great interest. We have, on the one hand, forms such as *Helix*, with large protruding spirally-coiled visceral dome and large mantle fold enclosing a spacious cavity; on the other, forms such as *Oncidium*, without distinct visceral dome or mantle fold and without shell. Between these two extremes there are numerous transition forms; indeed, complete series of such forms may be found

even within some of the natural divisions of the Pulmonata. The following are a few characteristic types.

Helix (Figs. 12 A, p. 9; 72, p. 75).—The visceral dome is large and spirally coiled, and is covered by a spiral shell sufficiently large to shelter with ease the whole body. The mantle fold covers a cavity lying anteriorly to the visceral dome (pulmonary cavity). Its free thickened glandular edge unites with the nuchal integument

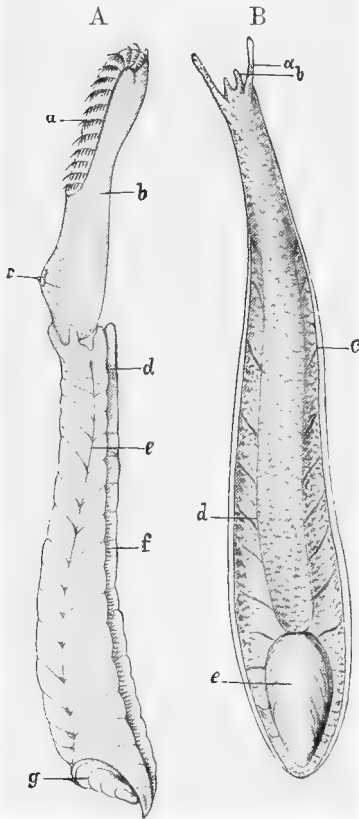

FIG. 54. — *Testacella haliotideia* (after Lacaze-Duthiers). A, right view; b, enormous pharynx evaginated through the buccal cavity, carrying on its surface the radula (a); c, opening of the pharynx into the œsophagus; d, position of the genital aperture; e, latero-dorsal groove along the body; f, latero-ventral groove; g, mantle, rudiment of the visceral dome. B, dorsal view: a, b, the two pairs of tentacles; c, the latero-ventral groove; d, the latero-dorsal groove; e, shell.

near it in a way characteristic of the Pulmonata, leaving only one aperture, the respiratory aperture—on the right. (In Pulmonata whose shells have the sinistral twist, the respiratory aperture lies to the left.) The apertures of the hind-gut and excretory organ are close to the respiratory aperture, through which their excreta have to pass out.

In many species of the genus *Vitrina*, the shell cannot contain the whole animal. The mantle fold projects in front of the shell, and has a process which is bent back over the shell, and is used for cleansing it.

In *Daudebardia* (*Helicophanta*) (Fig. 12 B, p. 9) the visceral dome and shell are, in comparison with the rest of the body, much smaller than in *Vitrina*. The animal cannot be sheltered by the shell. The visceral dome begins to be levelled down to a certain extent, disappearing into the dorsal surface of the foot. It lies far back on the body, the respiratory aperture being on its right side.

A somewhat similar arrangement is found in the genus *Homalonyx*, in which the low visceral dome lies on the centre of the back. The respiratory aperture lies to the right at the edge of the mantle. The edge of the flat ear-shaped shell is fixed into the mantle fold. *Daudebardia* and *Homalonyx* begin to look like slugs.

In *Testacella* (Figs. 54 and 55) a visceral dome hardly exists. The only remains of it is a small mantle at the dorso-posterior end of the body, which is covered by an ear-shaped shell. Beneath the mantle lies a reduced respiratory cavity. The respiratory aperture lies to the right posteriorly, beneath the edge of the shell. The viscera lie dorsally on the foot.

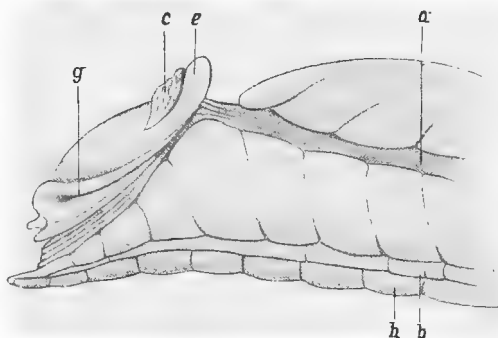

FIG. 55.—*Testacella haliotideae*, posterior portion of the body from the right (after Lacaze-Duthiers). The shell is removed to show the rudimentary visceral dome. *a*, latero-dorsal groove; *b*, latero-ventral groove; *c*, end of the muscle attached to the shell; *e*, mantle edge of the visceral dome; *g*, respiratory aperture.

The respiratory aperture lies to the right posteriorly, beneath the edge of the shell. The viscera lie dorsally on the foot.

The common terrestrial snails *Limax* and *Arion* (Fig. 12 D, p. 9) resemble *Testacella* in the reduction of the visceral dome, but in them the mantle or so-called shield which takes its place lies anteriorly behind the head. At its right edge lies the respiratory aperture. In *Limax* there is a small round rudimentary shell which is internal, *i.e.* it is entirely enveloped in or overgrown by the mantle fold. In *Arion* this shell is represented by isolated calcareous granules. In *Onchidium* and *Vaginulus* there is no trace of a visceral dome, nor, in the adult, of a shell. The visceral dome has to a certain extent spread out over the whole dorsal surface of the foot, and has disappeared. There is, further, no outwardly recognisable mantle fold distinct from the rest of the dorsal integument. A longitudinal furrow still divides the dorsal part of the body from the foot. The respiratory aperture with the anus lie posteriorly in the median line.

In the genus *Physa* (Fig. 11, p. 8), the edge of the mantle takes the form of lobe-like or finger-shaped processes, which bend back over the shell, and can be applied to its outer surface. In *Amphipeplea* (Fig. 10, p. 8) the mantle is much widened and, when bent back over the shell, covers all but an oval spot on the dorsal side of the last coil.

The dorsal integument of the *Onchidium* has wart-like protuberances or (in *Peronic*)

branched appendages. These are richly supplied with blood-vessels, and serve for respiration. In *Peronia* there are besides these also dorsal prominences which carry eyes.

The dorsal integument projects all round the body above the foot, and thus forms, as in *Chiton*, a peripheral zone, which is ventrally separated from the foot by a groove. In *Oncidiella* the edge of this zone, *i.e.* the lateral edge of the body, is dentate or fringed.

3. Opisthobranchia.

The typical outer organisation of the Gastropoda here suffers even more varied and thorough modification than in the *Pulmonata*. We have, on the one hand, forms with head, foot, visceral dome, shell, mantle and gill; on the other, forms which possess none of these organs and nevertheless are both Gastropods and Opisthobranchia. In one principal division of this order, the *Palliata* or *Tectibranchia*, the mantle fold is retained on the right side of the body, and partially covers a typical Molluscan ctenidium; in other divisions both mantle and ctenidia are wanting. We do not here apply the term mantle to the fold or edge of the dorsal integument which surrounds the body at the part where the head and foot take their rise; such an edge is more or less developed in most Opisthobranchia and distinctly marks off the foot and head from the rest of the body or back. The mantle here means only the broader fold which covers the mantle cavity, in which lies a typical molluscan gill. The edge of the mantle never forms a distinct siphon in the Opisthobranchia, though there is an approach to such a structure in the *Ringiculidæ*.

(a) Tectibranchia.

(a) **Reptantia.**—In this division we have, on the one hand, forms which still have a distinctly projecting visceral dome, whose integument secretes a coiled shell, into which the whole body can be withdrawn. On the other hand, forms occur in which the flattened visceral dome has spread out over the whole dorsal surface of the foot, the shell being rudimentary and internal. Examples of the former are found in the *Cephalaspidæ*, *e.g.* the *Actæonidæ*, *Tornatinidæ*, and some *Scaphandridæ* (*Atys*, *Cylichna*, *Amphisphyra*), a few *Bullidæ* (*Bulla*), and the *Ringiculidæ*.

In *Scaphander* among the *Scaphandridæ*, and *Acera* among the *Bullidæ*, the body cannot be completely withdrawn into the shell.

In the *Cephalaspidæ*, to which so far reference has been made, the shell is external.

In *Gastropoeron* the mantle is rudimentary, and is provided posteriorly with a filiform appendage. It covers a delicate membranous internal shell, into which the body cannot be withdrawn. The same is the case in *Philina* and *Doridium*, where there is also a delicate internal shell covering only a small portion of the viscera; this shell, in *Doridium*, is produced in the form of two lobes, the one to the left ending in a filiform process.

The visceral dome in the *Ampsidæ* is small as compared with the size of the animal, but rises distinctly above the rest of the body, and is covered by a thin inconspicuous shell. The mantle and shell often only partially cover the gill. In *Aplysia*, the shell is internal, *i.e.* it is entirely overgrown by the mantle; in *Dolabella*, this enveloping overgrowth is not quite complete, as a circular median dorsal

aperture is left, through which the dorsal surface of the shell is visible. The mantle in *Dolabella* forms a small anal siphon posteriorly.

Notarchus has a microscopically minute shell. In certain species of this genus, the integument forms protuberances or delicately branched appendages.

In the *Oxynoidea*, the shell is only partially covered by the mantle, and is, further, much too small to shelter the body.

Among the *Notaspida*, the *Umbrellidae* have a small flattened cap-like visceral dome lying upon the massive foot. The visceral dome is surrounded by a mantle fold which, on the right side, covers the gill. The integument of the dome and mantle is covered by a flattened disc-shaped shell.

In *Pleurobranchia*, the visceral dome is relatively large. The right and left margins project as short mantle folds, but there are no such folds to the front and back, so that at these latter parts the flattened visceral dome is not distinct from the rest of the body. In *Pleurobranchus*, the integument of the flattened visceral dome broadens out into a large fleshy disc which projects on all sides beyond the large, broad-soled foot; its margin (mantle fold) is separated from the foot by a deep continuous groove running right round the body; in this groove, to the right, lies the large gill, while in *Pleurobranchus* a small flat internal shell, thin and membranous, is still found; in related forms this may be wanting. The dorsal integument is often strengthened by a layer of calcareous granules.

(β) *Natantia*.

Pteropoda Thecosomata.—The *Limaciniidae* have a well-developed visceral dome and corresponding shell, with sinistral twist; the shell can be closed by means of a typical operculum. The mantle fold covers a cavity which lies anteriorly to the visceral dome. The anus is to the right. The animal can withdraw into its shell. In the *Cavoliniidae* the dome and shell are bilaterally symmetrical, not twisted, and the body can be entirely hidden within the shell. The mantle cavity here lies posteriorly to the visceral dome, on what is usually called its lower side. The symmetrical shell of the *Cymbulidae* does not correspond with the shell of other Thecosomata; it is a cartilaginous "pseudoconch" covered with body epithelium. In the *Cymbulidae* the mantle cavity also lies posteriorly. We shall return later to the varying position of this cavity among the Thecosomata.

The mantle, in the genus *Cavolinia*, shows peculiarities which can best be described in connection with the shell. In the latter, two surfaces are distinguished, a slightly arched anterior surface (usually described as the upper), and an arched posterior surface. The anterior surface projects forwards and downwards beyond the posterior for a third of its length. The shell has three slit-like apertures, one

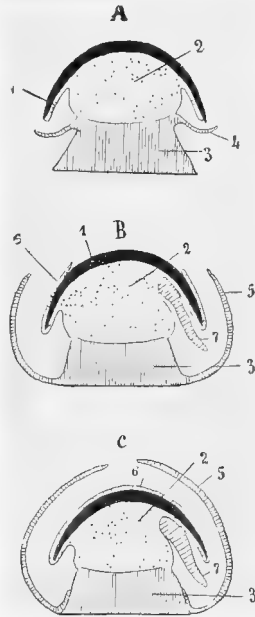

FIG. 56.—Diagrammatic transverse sections of Gastropods, to illustrate the arrangement of the shell (black, 1), visceral dome and mantle (dotted, 2), and foot (streaked, 3). A, Prosobranchiate with outer shell and epipodium (4). B, Tectibranchiate with lobes (6) of the mantle turned back over the outer surface of the shell. Dorsally the shell is still uncovered; 5, parapodia; 7, ctenidium. C, Tectibranchiate with internal shell, i.e. completely overgrown by the lobes of the mantle.

anterior and ventral, through which the fin-like processes of the foot can be protruded, and two lateral apertures stretching far up, so that the shell appears almost bivalve.

At these lateral slits, which admit water to the mantle cavity, the mantle bends round on to the outer surface of the shell, covering the greater part of it; and, at the upper angles of the slits, has two freely projecting processes.

Pteropoda Gymnosomata.—In these, the long outwardly symmetrical body is naked and without a mantle, and the foot, which is much reduced, is found on the ventral side of the most anterior part of the body.

(b) **Ascoglossa and Nudibranchia.**

In mature Ascoglossa and Nudibranchia, with the single exception of the *Steganobranchia*, a shell is always wanting, as also a distinctly demarcated visceral dome. The latter, indeed, spreads out over the whole dorsal surface. The dorsal integument, nevertheless, forms a circular fold (mantle fold) separated from the foot by a groove sometimes deep, sometimes shallow; but, except in the *Phyllidiidæ*, no gills lie in this groove. Where this groove has nearly disappeared, the animals strongly resemble Planaria.

Phyllidiidæ.—In these, the mantle fold is distinct, and carries on its lower surface, to the right and left, a row of branchial leaves, herein recalling *Patella* and *Chiton*.

The genus *Dermatobranchus*, which, judged by its organisation, belongs here, has, however, no gills.

Dorididæ.—The dorsal integument (notæum), which here covers the body like a shield, being generally distinctly demarcated from the foot and the head, contains numerous calcareous particles, which give it a firmer consistency. Anteriorly, there are two feeler-like processes, the rhinophores, which can generally be withdrawn into special sheaths or pits; these are not to be confounded with the tentacles. The anus lies in the median line, generally behind the middle of the body, and is surrounded by an ornamental circlet of pinnate gills. The notæum is often covered with prominences, and in some genera the margin carries variously shaped processes.

Cladohepatica.—Here there are no anal gills. The dorsal integument has variously formed and variously arranged appendages; these may be conical, club- or finger-shaped, lobate or branched; they are, for the most part, very striking in colour and appearance. Sacs of nematocysts are generally found at their tips, and cæca of the intestinal canal (branches of the digestive gland) penetrate them. These dorsal appendages, which, like the rest of the body, are ciliated, have, at least partly, a respiratory function. In many forms they easily fall off, and are later regenerated (Fig. 18, p. 12).

Many Cladohepatica have a certain external likeness to Planaria with dorsal papillæ (Thysanozoon), but this likeness is still more marked in the following family:—

Ascoglossa.—Anal gills and also, as a rule, dorsal appendages are here wanting. The whole body is naked and ciliated. The back is indistinctly demarcated from the head.

Phyllirhoë.—This Nudibranchiate genus, of all Opisthobranchia, shows least of the typical external organisation of the Mollusca. The body here is naked and laterally compressed, with sharp dorsal and ventral edges. It has neither foot nor gills (Fig. 19, p. 12).

D. Scaphopoda. (*cf.* Review of Outer Organisation, p. 34.)

E. Lamellibranchia.

From each side of the body there typically hangs a large leaf-like mantle fold of the same shape as the shell-valve formed by it. These mantle folds project beyond the body in front, below, and behind, and enclose a mantle cavity which everywhere, except dorsally, opens outward by means of the slit left between the edges of the folds. This large single cleft serves for the admission of nourishment and water into the mantle cavity, and for the expulsion of the excreta, genital products, and respired water; through it also the foot is protruded. Such a primitive mantle is thus **completely open**, its simple edges (*i.e.* without folds, papillæ, tentacles, or eyes) are quite free, coalescing nowhere.

The above serves for a description of the mantle of *Nucula*—one of the *Protobranchia*—and must be considered as the primitive arrangement.

In most Lamellibranchia, however, special differentiations of the margin of the mantle occur; these take the form of folds, thickenings, protuberances, papillæ, tentacles, glands, eyes, etc., and this is the case both in forms which have an open mantle and in those in which the mantle is partially closed.

The partial closing of the mantle is brought about by the concrescence at one or more points of the free edges of the mantle folds.

A. A completely open mantle, *i.e.* one single large cleft entirely separating the edges of the mantle, is found:

(a) Among the *Protobranchia* in *Nucula*.

(b) Among the *Filibranchia* in the *Anomiale*, *Arcide*, *Trypniidae*, and a few *Mytilide* (*Pinna*).

(c) In all *Pseudolamellibranchia* except *Melagrina*.

(d) Among the *Eulamellibranchia*, only in a few species of *Crassatella*.

B. The mantle folds of the two sides grow together at one point.—In this case the point of concrescence almost always lies high up posteriorly; and marks off a small aperture from the originally simple cleft. This aperture, occurring on a level with the anus, forms the **exhalent** or anal aperture of the mantle. Its edge may be more or less prolonged posteriorly to form an anal siphon, which can be protruded beyond the valves of the shell.

At a point a little below this exhalent aperture, the mantle edges usually become applied to one another, **although no concrescence takes place**. Above this point, between it and the anal siphon, they separate to form an **inhalent** or branchial aperture. The edges of this aperture also may be produced posteriorly into a branchial siphon, which, however, in this case, has a cleft extending along the whole of its lower side, which is a continuation of the large cleft of the mantle. A branchial siphon formed in this way, by mere apposition of the mantle edges, is found in the genus *Mulleria* among the *Protobranchia*.

An anal aperture, separated by a point of concrescence from the large mantle cleft, is found in the following Lamellibranchia :

(a) Among the *Protobranchia* in *Malletia*.

(b) Among the *Filibranchia* in most *Mytilidae*.

(c) Among the *Pseudolamellibranchia* in the *Aviculidae* (genus *Meleagrina*).

(d) Among the *Eulamellibranchia*, in the *Carditidae* (*Venericardia*, *Cardita*, *Milneria*), the *Astartidae*, and most *Crassatellidae*; among the *Cyrenidae*, in the genus *Pisidium*; among the *Unionidae* in the *Unioninae* (*Unio*, *Anodonta*); and among the *Lucinacea*, in *Cryptodon Moseleyi*.

In *Solenomya*, among the *Protobranchia*, the two mantle edges grow together only at one point, but to such an extent as to close the whole posterior half of the

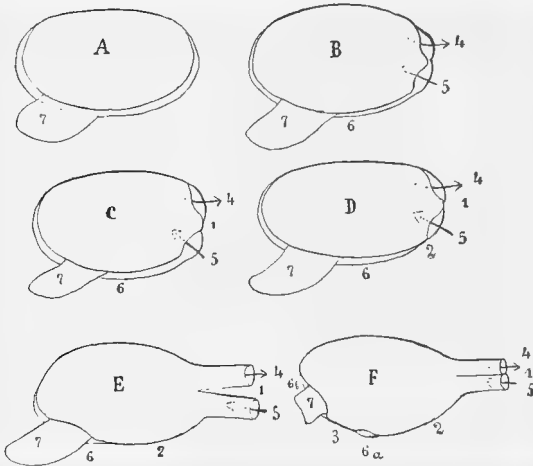

FIG. 57. —Diagrams to illustrate the various ways in which concrescence of the mantle and formation of siphons take place in the Lamellibranchia. The foot (7) protruded forward through the mantle cleft; A, mantle completely open; B, mantle open, but with its edges applied to one another at two points, thus giving rise to incompletely separated anal and respiratory cavities; C, edges of the mantle grown together at one point (1), the anal or exhalant aperture of the mantle (4) is separated; D, edges grown together at two points (1, 2), the branchial or inhalant aperture (5) is also separated, the mantle has three apertures; E, mantle closed by the extension of the place of concrescence (2), three limited apertures remain, viz. the anal, branchial, and pedal apertures—the first two are produced into siphons; F, a third concrescence (3) takes place. Mantle with four apertures (4, 5, 6a, 6b), the most anterior (6b) for the protrusion of the foot. The siphons have united.

ventral mantle opening. In this way the mantle cleft is divided into two; the anterior aperture serves for the protrusion of the foot, while the posterior serves at the same time as inhalant (branchial) and exhalant (anal) aperture. *Solenomya* is the only bivalve in which this arrangement is found.

C. The mantle folds grow together at two points, thus forming three apertures.—This condition arises in consequence of the complete separation (through concrescence) of the branchial aperture from the rest of the large anterior mantle cleft. The anal and branchial apertures may remain as slits, or may be produced into longer or shorter anal and branchial siphons. The large anterior and ventral mantle cleft serves for the protrusion of the foot, and is called the pedal cleft. These two points of concrescence are found:

(a) Among the *Protobranchia*, in *Yoldia* and *Leda*.

(b) In most *Eulamellibranchia*, viz. in most *Lucinidæ*, most *Cyrenidæ*; among the *Unionidæ*, in the *Mutelineæ*, in the *Donacidæ*, *Psammobiidæ*, *Tellinidæ*, *Scrobiculariidæ*; among the *Veneracea*, in the *Veneridæ*, in the *Cardiidæ*, the *Maclidæ*, *Mesodesmatidæ*, and the *Solenidæ* (excepting *Solen* and *Lutraria*).

(c) In all *Septibranchia* (*Poromyia*, *Cuspidaria*).

In the above forms the mantle is still wide open, *i.e.* the points of concrescence are small and local. But these points may become lines of concrescence of considerable length. In the *Chamaacea*, for example, and especially in the *Tridacnidæ* among the *Eulamellibranchia*, the three apertures of the mantle are found at considerable distances from one another, being divided by long intervals where the edges have grown together.

In some groups of Lamellibranchia, the concrescence between the anal and branchial apertures or siphons remains short, *i.e.* the one aperture lies directly below the other, but in such cases the edges anterior to the branchial aperture grow together to a greater extent, so that the pedal aperture becomes reduced to a small anterior fissure. In this condition the mantle is **closed**. Such a mantle is found :

Among the *Eulamellibranchia* in the *Modiolarca*, *Dreissensia*, *Petricola*, all *Pholadidæ* (*Pholas*, *Pholadidea*, *Jouannetia*, in which the pedal aperture is said to close entirely in old animals, *Xylophaga*, *Martesia*); in the *Teredinidæ*, and among the *Pandoridæ*, *Pandora*, the *Verticordiidæ* and *Lyonsiidæ* (*Anatinacea*).

D. There are some Lamellibranchia with closed mantle, in which a fourth aperture is added to the three found in the above groups, **the mantle thus having three points of concrescence**. The fourth aperture is always small, and is found between the pedal and branchial apertures; it probably corresponds with a rudimentary fissure for the byssus.

This arrangement is found in the *Eulamellibranchia*; among the *Solenidæ*, in *Solen* and *Lutraria*; among the *Pandoridæ*, in *Myochama*; in *Glycymeris*; among the *Anatinacea*, in the genus *Thracia*; in the *Pholadomyidæ* and the *Clavagellidæ* (*Clavagella* and *Brechites* [*Aspergillum*]); and, finally, in *Lyonsia norvegica*.

The anal aperture is often and the branchial aperture nearly always fringed, or in various ways edged with protuberances, papillæ, or tentacles, and this is the case whether these apertures are found on the edge of the mantle or at the ends of (longer or shorter) siphons.

The siphons can be contracted and extended, and either wholly or partly withdrawn into the shell, by means of special muscles. These muscles are attached on the inner surface of the shell-valves to the right and left posteriorly, and their line of attachment forms the pallial sinus, which will be described later on.

The length of the siphons varies greatly. Specially long siphons are found in the *Maclidæ*, *Donacidæ*, *Psammobiidæ*, *Tellinidæ*, *Scrobiculariidæ*, many *Veneracea* and *Cardiidæ*, the *Mesodesmatidæ*, *Lutraria*, the *Pholadidæ*, *Teredinidæ*, *Anatinidæ*, and *Clavagellidæ*.

The siphons may be separated throughout their whole length, and often diverge one from the other (*e.g.* *Galatea* among the *Cyrenidæ*, the *Donacidæ*, *Psammobiidæ*, *Tellinidæ*, *Scrobiculariidæ* (Fig. 58), *Mesodesmatidæ*, *Pharus*, etc.).

In other forms they coalesce along their entire length; they may even look like a single tube, which is, however, always internally divided into an upper (anal) and a lower (branchial) channel. This common siphon is sometimes protected by a special sheath of epidermis, particularly in those forms in which it cannot be

withdrawn into the shell. Siphons united throughout their whole length are found in the *Macridæ*, a few *Veneracea*, *Lutaria*, *Solenocurtus*, *Solen*, the *Pholadidæ*, many *Anatinidæ*, and the *Charayellidæ*.

In some cases, siphons which are united for some distance at the base, separate near their ends and even diverge, e.g. in *Petricola* among the *Veneracea*, *Teredo*, etc.

The two siphons are often of unequal length. In the *Modiolaria* (*Mytilida*) only one, the anal, is developed, while the branchial aperture remains unseparated from the large mantle cleft. The reverse is the case in *Dreissensia* and *Scrobicularia*, where the branchial siphon is much longer than the anal.

The siphons are sometimes provided with valves; these occur more often in the anal than in the branchial siphon.

Significance of the development of the Anal and Branchial Apertures and Siphons.

Most Lamellibranchia inhabit mud or sand, into which they sink the anterior part of the body, burrowing by means of the protrusible foot. The water necessary for bathing the gills and for respiration can only be received into and expelled from the mantle cavity through the cleft at the posterior end of the body which projects above the mud. The fecal masses from the anus near this point must also here be ejected from the cavity. The development of localised inhalent and exhalent apertures is explained by the fact that a constant regulated stream of water into and out of the mantle cavity is necessary both for respiration and for conducting particles of food



FIG. 58.—*Scrobicularia piperata* buried in mud. The inhalent siphon takes in mud as nourishment; the anal siphon stands erect (after Meyer and Möbius).

to the mouth. The most advantageous point for the exhalent aperture is obviously directly behind the anus.

Siphons attain development in consequence of the habit of life of many bivalves, which bury themselves deep in mud, sand, wood, and even rock. By means of their siphons they can still remain connected with the water which bathes the surface of their place of concealment, and, as long as the animals remain undisturbed, a constant current enters the mantle cavity through the branchial and leaves it through the anal siphon.

Where the mantle folds have grown together to a large extent (closed mantle) the siphons are always well developed. Such closing of the mantle is found principally among bivalves which bore into wood, clay, rock, etc., and in which the foot of the adult is weakly developed, or altogether rudimentary. The degeneration of the foot leads to the shortening of the pedal aperture which originally served for its protrusion.

The mantle is found completely open with only slightly developed anal and branchial apertures or none at all, in bivalves which do not burrow, but live surrounded by water, either attached to the bottom or lying freely on it.

In such animals the surrounding water can circulate through the usually open mantle cleft and the mantle cavity. We here find protuberances, papillæ, tentacles, etc., carrying sensory organs, all along the free edges of the mantle, whereas, in bivalves which inhabit mud or bore into wood, rock, etc., such organs are mostly found massed together round the edges of the branchial and anal apertures.

The Edge of the Mantle.

The edge of the mantle often forms a number of diverging folds, which in transverse section look like finger-shaped processes. The outermost fold is always applied to the shell. The edge of the mantle may also be beset with one or more rows of protuberances, papillæ, or tentacles, and often contains unicellular or multicellular glands, mucous glands, and others which have been considered to be poison glands for protective purposes. Tactile sensory cells are very common. Eyes are rarely developed on the edge (*cf.* section on the Sensory Organs).

In the *Pectinidæ*, *Spondylidæ*, and *Limidæ*, the inner fold of the mantle has a somewhat broad border, which, when the shell is open, projects from the mantle towards the median line of the body (Fig. 23, p. 16). The free opposite edges of these folds (flaps, or curtains), springing from right and left, may meet in such a way as to shut off the central part of the mantle cavity even while the shell is open, apertures only remaining anteriorly and posteriorly.

F. Cephalopoda.

Integument.

The integument of the Cephalopoda consists of an outer cylindrical epithelium, and a subjacent cutis in the form of thick connective tissue. In this cutis, not far removed from the epidermis, and above a layer of connective tissue plates (which are refractive and often shimmer like silver), there are large pigment cells or **chromatophores** which, by their alternate contraction and expansion, bring about the well-known changes of colour in these animals.

These chromatophores are single cells containing yellow, brown, black, violet or carmine pigment, either as fluid or in small granules. The layers containing them are either single or double; in the latter case, the colour of the pigment in the one layer of chromatophores differs from that of the chromatophores in the other. Radial fibres, arising from the surrounding connective tissue, are attached to each chromatophore, round that equator which lies parallel to the integument. The chromatophores are enveloped in a special, possibly elastic, membrane, and when contracted are almost globular; the pigment corpuscles are then crowded together. The chromatophores expand equatorially, diminishing the distance between their poles, *i.e.* they become much flattened. In this condition, they may, further, throw out fine branches, the pigment granules being thus spread out over a large surface. It was formerly believed that the expansion of the chromatophores was caused by the contraction of the radial fibres, which were thought to be muscular, but more recent investigations have shown the fibres to be of the nature of connective tissue. The changes of colour, which are of great physiological and biological interest, and which are partially under the control of the animal, are brought about by the alternate contraction and expansion of these variously coloured chromatophores

Mantle, Visceral Dome.

Some of the most important points connected with the mantle and visceral dome have already been mentioned (pp. 36-38).

In *Nautilus*, the body is attached right and left to the inner surface of the shell of the last or inhabited chamber by powerful muscles, which may make a slight impression on the shell. Between the points of attachment of these lateral muscles, the integument of the visceral dome coalesces with the inner surface of the shell of the inhabited chamber in a narrow circular zone, so that the gas¹ enclosed in the upper chambers of the shell cannot escape. While the integument and mantle beneath this zone of concrescence (*i.e.* towards the free aperture of the last chamber) are rough, fleshy, and muscular, the integument of that portion of the visceral dome which lies above the zone and is applied to the last septum is delicate and soft. The siphuncle, which arises at the dorsal end of the visceral dome and passes through all the septa, is membranous and hollow and filled with blood. It is said to communicate with the pericardium. In the female *Nautilus*, the nidamental gland (see Genital Organs, p. 241) lies in the free mantle fold, near the point at which it separates from the visceral dome. We thus have parts which usually lie in the visceral dome wandering into the mantle fold.

Among the *Dibranchia*, which are good swimmers, fins are found. In the *Octopoda*, which are distinguished by the round, compact form of the visceral dome, these are wanting, except in the remarkable genus *Cirrhoteuthis*. Fins are universal among the *Decapoda*, and vary much in form, size, and arrangement.

In *Scpia* (Fig. 80, p. 83) and *Sepioteuthis*, the fins are inserted on the lateral edges of the body, along the whole height (length) of the visceral dome, forming the boundary between the anterior and posterior (physiologically the dorsal and ventral) surfaces of the latter. In *Rossia*, *Scpiola*, and *Sepioides* they are almost semicircular, and are like distinct appendages situated on the anterior surface of the dome, about half-way up it. This is also the case in *Cirrhoteuthis*, where the more or less circular fin-lobes rise from the body on stalk-like bases.

The triangular or semicircular fins of *Cranchia*, *Histioteuthis*, *Onychoteuthis*, *Loligo* (Fig. 34, p. 23), *Loligopsis*, *Ommastrorhynchus*, etc., are found at the dorsal end of the visceral dome, on its anterior side.

In many *Dibranchia*, there is a concrescence of the free edge of the mantle fold with the integument of the "head" (Kopffuss), which lies below it. This connection is effected by means of a muscular band, which passes over the neck (nuchal band). In most *Decapoda*, this connection is wanting, and the edge of the mantle is free all round the body; the exceptions are the genera *Sepiola*, *Cranchia*, and *Loligopsis*, which have a narrow connection of this sort. All *Octopoda* have this concrescence, commencing with the *Argonauta*; it lengthens in *Philonexis* and *Octopus*, till in *Cirrhoteuthis* it spreads to the posterior surface (physiologically the ventral surface), so that the edge of the mantle remains free only at the aperture through which the funnel or siphon is protruded.

Arrangements for fastening the mantle fold to the adjacent body wall are very common. Such attachment is either temporary or permanent. In the former case, there are prominences with corresponding depressions for locking the mantle (*appareil de résistance*); in the latter case, dermal or muscular fusions take place between the mantle and body wall.

¹ Cf. note, p. 37.

1. **Apparatus for locking the mantle.**—These are paired or unpaired. The former are to be found on the posterior side of the body, in the mantle cavity, near its lower end; they lie to the right and left at the base of the funnel, and on the corresponding points of the inner surface of the mantle fold. The unpaired, on the contrary, are found on the anterior surface of the neck. Since all the arrangements serve the purpose of cutting off the mantle cavity from the external medium, it is easy to see that their development is in inverse ratio to the extent of the concrescence of the edge of the mantle round the neck before mentioned. Where no concrescence is found, as in *Sepia*, the arrangements for locking the mantle are highly developed; while, where the line of concrescence is very long, as in *Octopus*, the locking apparatus may be altogether wanting. The locking apparatus consists, in general, of cartilaginous prominences (often accompanied by depressions) on the inner surface of the mantle fold, *i.e.* the surface turned towards the mantle cavity, which exactly fit corresponding cartilaginous depressions accompanied, as the case may be, by prominences, on the opposite body wall (*cf.* Fig. 80). The special forms of the mantle and nuchal locking cartilages are of importance in classification.

The cartilaginous arrangements for locking, which are almost always found in the *Decapoda* (they are wanting only in *Owenia* and *Cranchia*), are still retained in a few *Octopoda* in the form of more or less modified fleshy processes (*Argonauta*, *Tremoctopus*). The nuchal locking apparatus is the first to disappear on the rise of the pallio-nuchal concrescence. It has disappeared among the *Decapoda* in the genus *Scpiola*, where the mantle is firmly attached to the neck.

2. **Permanent connections** between the mantle fold and the adjacent body wall traversing the mantle cavity are found only in those Cephalopods which have no locking apparatus. Thus in *Octopus* and *Eledone* the mantle is attached to the body wall by means of a median muscle above the funnel. This muscle consists of two closely-applied lamellæ, having the anus between them. In *Cranchia* the free dorsal edge of the funnel (at its so-called base) has become united by an integumental band on the right and left with the mantle fold, and a similar arrangement is found in *Loligopsis*.

Water pores.—Near the mouth, or at the bases of the arms, or laterally on the head, in many Cephalopods, there are apertures leading to integumental pouches of varying size. The function of these organs is unknown.

IV. The Shell.

General.

The Shape of the Shell, and its Relation to the Soft Body.

All the various forms of shell found in the Mollusca are deducible from a cup- or plate-like shell covering the dorsal region. Such a shell affords sufficient protection for animals such as *Fissurella*, *Patella*, etc., which can firmly and almost immovably attach themselves to a hard surface by the sucker-like foot. The soft body is in this case protected on one side by the shell, and on the other by the surface of attachment. Free-moving Mollusca, however, show a tendency to protect the whole body exclusively by means of their shells, and this object is attained in various ways.

In the *Chitonidae*, for instance, the shell is made up of consecutive

joints, overlapping in such a way as to be movable one upon the other. This segmented shell can protect the whole body, since it allows the *Chiton* to roll up like an Armadillo or a Wood-louse.

In the *Lamellibranchia*, the protection of the whole of the soft body is provided for by the development of a bivalve shell, from which the foot can be protruded, and which, by the closing of its two valves, completely envelops the soft body as well as the retracted foot.

In the *Gastropoda*, *Scaphopoda*, and *Cephalopoda*, the most complete protection on all sides of the body by means of the shell is attained on another plan. The shell becomes much elongated and turret-like, and is thus so capacious that not only the visceral dome but the head and foot also can find place in it. Even the only remaining unprotected aperture, the one weak point of this fortification, can very often be completely closed by a hard operculum.

A long, turret-like shell is an inconvenient burden for a freely moving animal, being, in consequence of its large surface, a hindrance to locomotion. A reduction of the surface is brought about in the *Gastropoda* and *Cephalopoda* by the coiling of the shell, either in one plane or in a conical spiral.

In the latter case the spiral twist is almost always right-handed or dextral.

In order to decide the direction of the twist, the shell should be held in such a manner that the point of the spiral is uppermost, while the aperture is directed downwards and towards the observer (Fig. 60, p. 60). If, in this position, the aperture lies on the right of the axis, the shell has a dextral twist if to the left its twist is left-handed or sinistral.

We have a striking and in most cases unexplained phenomenon in the reduction and even complete disappearance of the shell, which takes place not only in nearly all the classes, but even within some of the smaller groups of Molluscs, e.g. the *Solenogastres* among the *Amphineura*, a few *Heteropoda* and *Titiscania* among the *Prosobranchia*, many *Pulmonata*, very many *Opisthobranchia*, and most extant *Cephalopoda*.

In almost all cases the forms in which the shell is rudimentary or wanting can be shown to be derived from forms in which it is well developed. All shell-less snails (slugs) have shells in the early stages of their development.

The process of the gradual reduction of the shell to a rudiment, which will be more fully described later on, is often as follows: (1) the shell becomes internal; (2) it decreases in size, so that it no longer can cover the body; (3) the visceral dome disappears; (4) the shell is only to be found in the form of isolated calcareous particles in the dorsal integument; (5) even these vanish, and the shell is only to be found in the embryo.

Only in a few cases is it possible distinctly to recognise the reason or the advantage of this reduction of a protective covering so useful to and exercising so profound an influence on the organisation of the

whole race. The following are a few cases in which the utility of the reduction of the shell in adaptation to special conditions is to some extent evident: (1) In free-swimming marine forms, where the shell is too heavy and increases friction; (2) in *Testacellu* and allied forms, which prey upon earthworms, where a large shell would prevent them from following their prey into narrow holes and passages; (3) in *Gastropods*, which browse among thick tangles of Corals, Bryozoa, Hydroida, or Algæ (*e.g.* many *Nudibranchia*).

The loss of the shell is generally followed by compensatory adaptations for protection, such as great capacity for regeneration, especially of the easily detachable appendages, voluntary amputation of portions of the body, stinging cells, and colouring which may be protective in various ways.

The carnivorous *Cephalopods* are protected (1) by their extraordinary swimming powers, which are in keeping with their highly developed organisation; (2) by their well-developed sight; (3) by great muscular strength; (4) by strong jaws; (5) by the discharge of the secretion of the ink-bag; (6) by their partly mimetic changes of colour, etc.

Certain peculiarities of organisation, which can only be understood as remains of a shelled condition (*e.g.* the lateral position of the genital and renal apertures and also to some extent of the anus in the *Nudibranchia*), always persist after the shell has disappeared.

Chemical Composition of the Shell.

The shell of the Mollusca consists principally of carbonate of lime, with traces of phosphate of lime and of an organic substance related to chitin,—conchyolin. Besides these, various colouring matters may occur.

Structure of the Shell.

The shell of the *Lamellibranchia* consists of three layers, the innermost layer being applied to the surface of the mantle. The shell is to be regarded as a cuticular structure.

The outer layer (shell-integument, epidermis, cuticle, periostracum) is, so far as its physical constitution is concerned, horny and wanting in lime. It generally disappears off the older portions of the shell.

The middle layer (columnar, prismatic, or porcelaneous layer) consists of slender prisms of carbonate of lime, usually perpendicular to the surface of the shell and closely crowded together.

The inner (nacreous) layer has a finely lamellated structure. The very delicate transparent laminae of which it is composed are thrown into slight waves; these cause the wavy lines on that surface of the shell which lies on the mantle, which, by interference, produce the characteristic nacreous lustre. The pearls of the pearl oyster are formed of the same substance as this layer.

The constitution of these three layers varies greatly in details both in the *Lamellibranchia* and in other Mollusca. The outer and middle layers are formed at the free margin of the mantle, the inner layer is yielded by the epithelium of its whole outer surface.

The shell in the *Gastropoda* and *Cephalopoda* consists principally of the middle

or porcelain layer, which, however, has a structure very different from that of the same layer in the *Lamellibranchia*. This layer is generally, if not always (at least in the young), covered by a periostracum. The inner (nacreous) layer is very often wanting.

Growth of the Shell.

In the Arthropoda, the chitinous exoskeleton, which we may compare with the Molluscan shell, develops at the surface of the whole body and its appendages. This skeleton, when once formed and hardened, encases the body on all sides within fixed boundaries, and is incapable of growth. Hence the moults of the Arthropoda, by which alone growth becomes possible.

The Molluscan shell, on the contrary, is open. In the *Gastropoda* and *Cephalopoda*, it assumes the shape of a conical mantle, coiled round a single axis and open at the base of the cone. By continual additions at the edge of its aperture, it grows with the growth of the animal, without materially altering its form. The lines on the surface of the shell of the adult snail register its phases of growth. During growth, the oldest, uppermost coils or whorls of the shell either continue to be filled by the apex of the visceral dome (in many *Gastropods*), or are deserted by the animal which, as the shell grows, withdraws farther and farther from its tip. These whorls may remain empty, or may be partially or completely filled with shell substance. In the latter case, they may be successively thrown off. The *Nautilus* and allied forms, during growth, periodically form transverse septa, so that the forsaken parts of the shell become chambered and filled with gas,¹ the animal occupying the largest and last-formed chamber, which opens externally. In the *Lamellibranchia*, the growth of the shell keeps pace with the growth of the body in exactly the same manner, the free edge of the shell valve continually receiving additions of shell substance from the edge of the mantle to form the periostracum and the prismatic layers, while the whole external surface of the mantle yields an additional nacreous layer. The consecutive phases of growth are here also registered by the concentric markings on the surface of the shell.

Special.

A. **Amphineura.** (Cf. pp. 39-42.)

B. **Gastropoda.**

A few details concerning the shell of the *Gastropods* must here be added. As a rule, the shell is coiled spirally round an axis. This spiral is, in rare instances, so flattened that the coils come to lie almost in one plane, giving rise to a nearly symmetrical shell (e.g. *Planorbis*).

There are, however, among the *Gastropoda*, uncoiled shells which are symmetrical, and these require special attention. The most important are the cup-shaped or more or less bluntly conical shells of the *Patellidae* and *Fissurellidae*. Since (1) we derive

¹ Cf. note, p. 37.

the Gastropoda from bilaterally-symmetrical ancestors with symmetrical shells; and since (2) the *Fissurellidae* undoubtedly possess the most primitive organisation of all the Gastropoda, and thus stand nearest to the racial form, and are moreover (3) strikingly symmetrical in their organisation, it seems, at first sight, natural to consider this symmetry a primitive feature. Certain peculiarities of the nervous system, however, especially the crossing of the pleuro-visceral connectives, taken in connection with other conditions explained more fully elsewhere, make it certain that the cup-shaped shell of *Fissurella* is only *secondarily* symmetrical, *i.e.* that *Fissurella* is descended from forms which possessed a spirally coiled shell. The same is the case with the *Patellidae*.

The following important facts are in harmony with this conclusion: (1) the young shell of *Fissurella* is asymmetrical and coiled, and it only gradually assumes

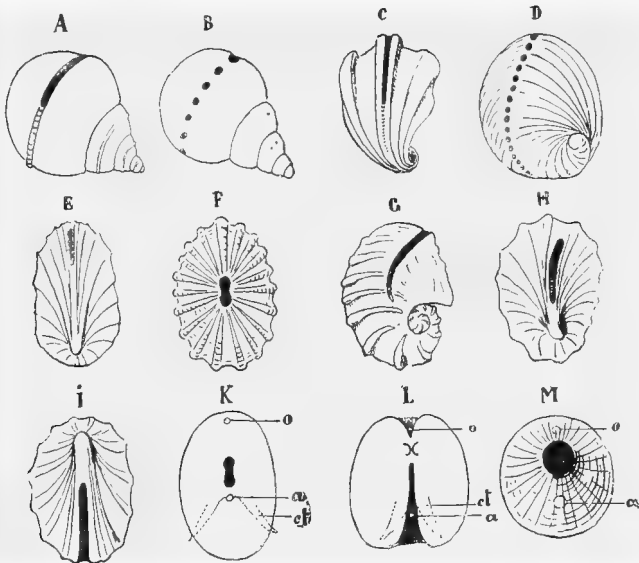

FIG. 59.—Shells of—A, *Pleurotomaria*; B, *Polytrema*; C and E, *Emarginula*; D, *Haliotis*; F, *Fissurella*; G and H, stages in the development of the shell of *Fissurella*; I, shell of the twisted racial form of the Gastropoda with marginal cleft; K, the same with apical aperture; L, shell of *Lamellibranch*; M, shell of *Dentalium*, seen from the apical aperture. The holes and clefts of the shells are black; o, mouth; a, anus; ct, etenidium.

the symmetrical form (Fig. 59, G, H); (2) the apparently symmetrical shape of some forms nearly related to *Fissurella* and *Patella* prove on closer inspection to be somewhat asymmetrical, the apex especially being more or less excentric; (3) other forms nearly allied to *Fissurella*, such as *Haliotis*, *Scissurella*, and *Pleurotomaria*, have spirally coiled shells (Fig. 59, A, B, C, D).

In the *Fissurellidae*, many *Pleurotomariidae*, and the *Haliotidae*, *i.e.* in the most primitive Gastropods, peculiar and noteworthy perforations of the shell occur, such as are occasionally found in other divisions. These perforations lie above the slit in the mantle which is characteristic of this order (*cf.* p. 43), and they everywhere establish communication between the mantle cavity and the exterior, especially needed when the mouth or edge of the shell is closely applied to the object on which the creature crawls.

In *Scissurella*, *Pleurotomaria*, and *Emarginula*, there is a median indentation in the anterior edge of the shell, which corresponds with an incision in the mantle edge. This is the case in the young *Fissurella*, but, during further development, the edge of the shell grows across the incision, so that in the adult animal the aperture lies near the apex. Beneath it is the anus, placed high up in the mantle cavity. If such a cleft were to arise at both the anterior and posterior edges, and to become very deep, a double shell would result comparable with the bivalve shell of the *Lamellibranchia*. It is in fact probable that this notching of the shell edge is of great phylogenetic significance.

In *Haliotis* we have a row of perforations of the shell, the process of formation of the perforation in *Fissurella* being often repeated; the older apertures are always, however, closed by shell substance, and the younger only remain open as long as they lie immediately over the respiratory cavity.

In very many *Prosobranchia* (the *Siphoniata* of earlier writers), there is, at the columnar edge or lip of the shell, a notch which gives passage to a channel-like fold of the mantle margin. This channel keeps up communication between the mantle cavity and exterior, even when the shell is closed by the operculum. Instead of a

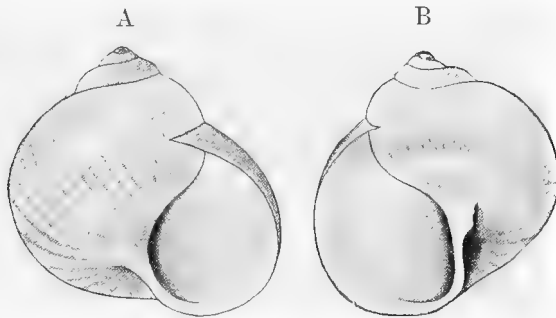

FIG. 60.—A, Dextrally twisted; B, sinistrally twisted shell of *Helix pomatia*.

notch, a more or less long process or beak may enclose a corresponding process of the mantle, the siphon. The latter may become a tube by the apposition of its edges.

It has already been mentioned that the shells of most Gastropods are dextrally twisted. There are, however, a few families, genera, or species in which the shell has a sinistral twist; and in some species where the twist is dextral, a few individuals with sinistral twist may occur, and *vice versa*. It is a curious fact that some species, in which the shell has a sinistral twist, show the asymmetry of the dextral twist in the soft body, whereas, in others, the asymmetry of the soft body corresponds with the twist of the shell. We shall return to this point.

For details as to the growth of the shell, and the capacity of the animal to dissolve the shell already formed, both of which are points full of interest, we must refer to special works on Conchology, as also for detailed descriptions of forms of the shell and opercula, and differences due to age.

Progressive reduction of the shell occurs in each of the three divisions of the Gastropoda. In the *Prosobranchia*, this has only been observed in marine, free-swimming *Heteropoda* and in *Titiscania*; in the *Pulmonata*, it is much more common; and in the *Opisthobranchia*, so frequent that nearly all the members of this division have more or less rudimentary shells. Many adult *Opisthobranchia* have even lost every trace of a shell (*Pteropoda gymnosomata*, *Nudibranchia*, and most *AscoGLOSSA*), although, in their earliest stages at least, they possessed a coiled

shell, for the closing of which there may even be an operculum, secreted by the foot, as in the *Prosobranchia*.

The following are some of the principal stages and concomitant phenomena of the reduction of the shell: (a) The well-developed shell ceases to be large enough to shelter the whole body. (b) The shell, which becomes thinner and smaller, is dorsally overgrown, partially or altogether, by extensions of the mantle. (c) As the shell (which is then either cup- shield- or ear-shaped) becomes continually smaller, the visceral dome begins to be levelled down, till it no longer rises above the rest of the body, its contents spreading out to a certain extent over the dorsal surface of the foot. (d) The external asymmetry of the body passes by degrees into symmetry, whereas the internal asymmetry never entirely disappears. (e) The shell is reduced to a number of isolated calcareous particles in the integument of the flattened visceral dome. (f) There is at last no trace of a distinct visceral dome; calcareous particles are to be found in the dorsal integument of the long and now naked Gastropod. (g) Even these particles finally disappear.

In connection with the reduction of the shell in *Opisthobranchia* and *Pulmonata*, compare the section on the mantle, pp. 43-48.

The **Heteropoda** present the following interesting series:—

Atlanta. The shell is very light and thin, but large and spirally coiled (with an incision at its aperture); the animal can entirely withdraw into it, and close it by means of an operculum developed on the distinct metapodium.

Carinaria. The shell is thin, light, and delicate; it is cup-shaped, and covers the large stalked visceral dome, but is incapable of sheltering the long and thick cylindrical body and foot. There is no operculum.

Pterotrachea. The visceral dome is small, and there is no shell and no operculum.

C. Lamellibranchia.

The two lateral valves of the Lamellibranch shell are connected, at their dorsal edges, by means of a **hinge** and a **ligament**. The ligament counteracts the muscles of the shell, which will be described later on, and which, by their contraction, close the shell. It is usually composed of two layers, the inner layer being elastic, while the outer is not. The outer non-elastic layer passes into the epidermis or periostracum of the shell. The inner layer of the ligament is elastic and calcareous, and is often called cartilage, but this is histologically incorrect.

The ligament lies either externally, distinctly seen dorsally between the prominences of the hinge edges of the valves, or internally, stretched between the apposed edges of the hinge, which are furnished with depressions for its reception. These depressions can easily be distinguished from those belonging to the hinge itself, since the former are alike on the two valves, whereas the furrows and other depressions belonging to the one face of the hinge correspond with teeth, ridges, etc., on the opposite face.

When the elastic "cartilage" of the ligament is at rest, as in a dead bivalve, or when the adductor muscles of the living animal are relaxed, the valves open. When the adductors contract, the "cartilage" is—apparently in all cases—compressed. On the other hand, when the adductors are relaxed, the elasticity of the "cartilage" forces the shell open again (Fig. 61).

The continuity established between the two valves, by means of this dorsal ligament, causes the Lamellibranch shell to appear to consist, strictly speaking, of one dorsal piece, developed to the right and left ventrally into two valves. The constitution of the ligament and hinge are of importance in classification.

We must refer the reader to systematic zoological works for the special forms taken by the shell, and content ourselves with the following remarks:—

The Lamellibranch shell is originally symmetrical, that is to say, the two valves, apart from the almost invariable asymmetry of the hinge, are exactly alike (equivalve). This is the case in most of the Lamellibranchia. The two valves may, however, become unlike, *i.e.* the shell (and to a much lesser extent, and only in unimportant details, the soft body also) may become asymmetrical. As far as we can at present judge, this asymmetry is caused by adaptation to an attached manner of life.

The left valve of the Oyster is firmly cemented to the surface on which it rests. This valve is thicker, more convex and spacious, and forms a sort of basin in which the soft body lies, while the right valve acts rather as a lid, and is thinner and flatter. We have thus an "upper" (the right) and a "lower" (the left) valve, but it is hardly necessary to point out that this use of the terms upper and lower has as little morphological significance as in the Pleuronectidæ among the fishes. The attached valve is sometimes the right, sometimes the left, and this

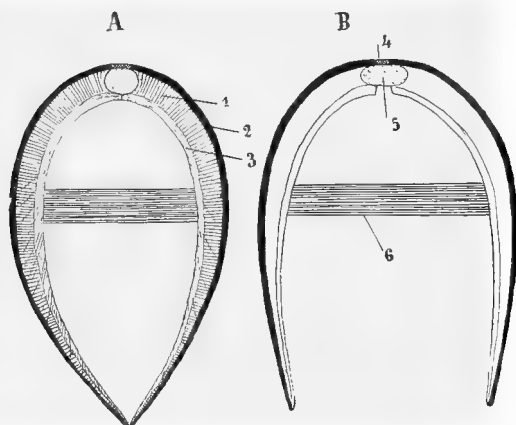

FIG. 61.—Diagram in illustration of the mechanism for opening and closing the Lamellibranch shell. 1, 2, 3, The three layers of the shell—1, prismatic layer; 2, cuticle or periostracum; 3, nacreous layer. A, Shell closed by the contraction of the adductor muscle (6), by means of which the elastic inner portion of the ligament (5) is compressed. B, Shell opened by the elastic pressure of the inner portion of the ligament during the relaxation of the adductor muscle. 4, Non-elastic outer portion of the ligament, which passes into the periostracum.

variation may occur within one and the same genus (*Chama*), or even species (*Aetheria*).

Besides the above-named, the following bivalves are also attached, and have dissimilar valves: *Spondylus*, *Gryphæa p. p.*, *Ecogyra p. p.*, and especially the fossil *Hippurites* (*Rudistes*), in which the right valve assumes the form of a high cone attached by its point, while the left looks like a lid. The conical valve has, however, no corresponding internal cavity, but is almost entirely filled up with shell substance, so that, in spite of the form of the shell, the space occupied by the animal between the two valves is very limited.

This same condition is found in certain fossil *Chama*. In *Requienia*, the left valve is produced spirally and is attached by its point, while the spirally-coiled flattened right valve covers it like a lid, so that the whole shell closely resembles a Gastropod shell closed by its operculum.

There are also free, unattached bivalves with unequal valves, *e.g.* many *Pectinidæ*. In these animals, however, many peculiarities of organisation, such as

the rudimentary foot, the constitution of the mantle edge, and the absence of siphons, indicate descent from sedentary forms. In the case of other forms with unequal valves, however, no such descent can be established.

In *Anomia* we have an example of an inequivalve bivalve, in which the valve turned to the surface it rests on is flat and the upper arched. The lower valve is here the right one, and takes the exact imprint of the surface on which it rests, so that, for example, the markings of the shell of the *Pecten* or the Oyster, to which *Anomia* frequently attaches itself, are exactly reproduced. In this right attached valve there is a perforation into which a shelly plug, the calcified byssus, fits; by means of this, the animal fixes itself to its substratum. The explanation of this perforation is seen in the course of development. It commences as a simple notch at the edge of the shell, as found also in other bivalves, for the passage of the byssus. By the further growth of the shell, this notch to a certain extent is grown round, and thus apparently travels away from the edge of the shell, with which, however, it is still really connected (Fig. 62). In related forms (*Curolia*) this aperture becomes quite filled up by a homogeneous calcareous mass.

Impressions on the inner surfaces of the shell.—Various organs of the Mollusc, attached to or adjacent to the inner surface of the shell, leave more or less distinct impressions on this surface, which are visible when it is empty. These impressions are of great importance, especially to the paleontologist, for by their means fairly

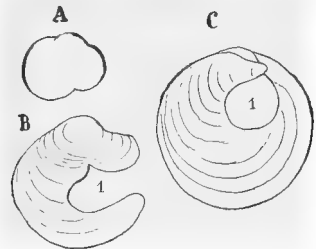

FIG. 62.—Three stages in the development of the shell valves of *Anomia*. A, Very young shell; B, older shell with notch for the byssus; C, still older shell, the byssus notch surrounded by the shell and persisting as a hole (after Morse).

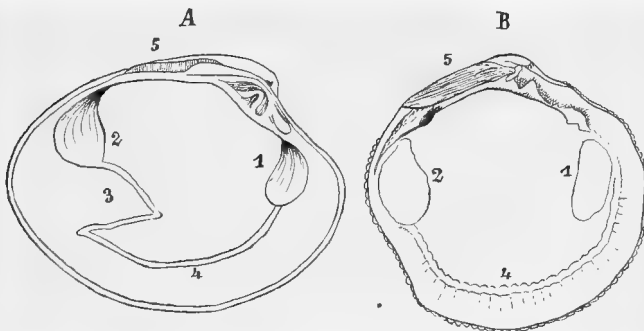

FIG. 63.—*Dimyaria*, inner surface of the left shell valve. A, *Cytherea chione* (*Sinuopalliata*); B, *Lucina Pennsylvanica* (*Integrupalliata*); 1, impression of the anterior; 2, impression of the posterior, adductor; 3, sinus of the pallial line (4); 5, ligament.

safe conclusions may be arrived at as to certain points in the organisation of the soft body which has disappeared.

1. The most distinct impressions are those caused by the adductor muscles. Where there are two powerful adductor muscles, one anterior and the other posterior (*Dimyaria*), there are two impressions in the corresponding parts of the inner surface of the shell (Fig. 63). In cases where the anterior muscle is rudimentary, while the posterior is unusually powerful, and has moved anteriorly towards the middle of the shell (*Monomyaria*), there is only *one* large impression (Fig. 64). The anus

is always to be found close to the posterior (which in the *Monomyaria* is the only) adductor.

2. Parallel to the edge of the shell, and more or less removed from it, we find on the inner surface of the shell the so-called **pallial line**, caused by the muscle fibres which attach the edge of the mantle to the valves.

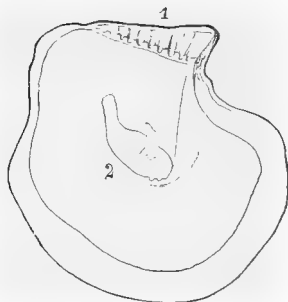

FIG. 64.—*Monomyarian*, internal surface of a shell valve of *Perna ehippium*. 1, Hinge edge; 2, impression of adductor.

The course taken by this line undergoes characteristic modification in such Lamellibranchs as have siphons; at the posterior part of the shell it suddenly bends forward and upward, and then again passes backward and upward towards the lower edge of the posterior adductor. The pallial line, in this case, forms an indentation, leaving a sinus or bay opening posteriorly, the **pallial sinus**, which has been utilised for systematic purposes (*Sinupalliata*, *Integripalliata*, Fig. 63). The sinus marks the line of attachment of the siphon-retractor muscles; the stronger these retractors and the better developed the siphons the larger and clearer is the sinus.

3. The foregoing impressions are the most distinct and constant, but others may occur as well, caused by the protractors and retractors of the foot, by the muscles or ligaments which attach the visceral dome to the shell, etc.: but these cannot be further described.

In most Lamellibranchia, when the shell is closed, the edges of the two valves meet exactly, so that the soft body can be entirely enclosed and cut off from the exterior (**closed**) shell. There are, however, shells in which, in the closed condition, the valves gape posteriorly, or, more frequently, both posteriorly and anteriorly (e.g., *Myidae*, *Alycemeridae*, *Solenidae*). This is accounted for by the great development of the siphons and of the foot, which can only partially (*Myidae*, *Solenocurtus*) or with difficulty be withdrawn into the shell. Such **gaping** shells are found in most boring bivalves, whose shell formation is specially interesting owing to the development of accessory valves or calcareous tubes. In this respect *Pholas*, *Pholadidea*, and *Jouannetia* represent the most important stages in a remarkable series.

The shell of *Pholas* is elongated longitudinally, and gapes anteriorly and ventrally for the passage of the short club-shaped foot, and posteriorly for that of the strongly developed siphons. As many as three accessory valves are developed dorsally (prosoplax, mesoplax, metaplax).

The shell of *Pholadidea* somewhat resembles that of *Pholas*. In the young animal it gapes anteriorly, as in *Pholas*, for the passage of the foot. Posteriorly, each valve is produced into a horny process, which is succeeded by an accessory piece (siphonoplax), hollowed out like a trough. The siphonoplax of the one valve often fuses with that of the other to form a single tube for the reception of the siphons. There are two pieces of prosoplax, while the meso- and metaplax are rudimentary. In the adult the boring activity is suspended, and the anterior opening becomes entirely closed by the secretion of an accessory piece, the **callum** (hypoplax). The functionless foot atrophies, and the animal can move no farther in the substance into which it has bored.

The shell of the adult *Jouannetia* is much shortened longitudinally, and is globular, and the animal cannot move in the round hole it has bored for itself in a block of coral. Any alteration in its position in the hole, which might be fatal to the animal, is avoided by means of a posterior tongue-like process of the shell, which, however, only belongs to the right valve. The shell is completely closed anteriorly, and a foot is wanting (cf. also Figs. 27, 28, p. 19, and 66, p. 67).

The adult condition of *Jouannetia* is explained by its developmental history. The shell of the young animal is like the segment of a sphere, whose greatest height is hardly half of the radius. It covers the dorsal upper portion of the body, its free edges thus bounding a very wide aperture, which corresponds with the anterior pedal gape of *Pholas*.

In this *Pholas*-stage, in fact, *Jouannetia* really possesses a foot. Twisting the body about and rasping the stone with the anterior edge of the shell, the animal excavates a hole, which is spherical in consequence of the shape of its shell. When this hole is made, new accessory shell material is secreted at the free edge of the shell; this forms the "callum," and as the edge of the mantle follows the lines of excavation, the form of the accessory shell is here (as in *Teredo*) determined by the form of the hole, and the sphere of which the original shell was but a segment is completed.

Setting aside a few related forms (*Martesia*, *Teredina*, *Xylophaga*, *Gastrochaena*, and *Fistulana*), in which the conditions are somewhat similar, we come to the ship-worm *Teredo* (Fig. 29, p. 20). This animal has a long tubular mantle which is produced posteriorly in two long siphons. The body lies at the anterior end of the mantle. *Teredo* bores cylindrical passages in wood. The valves of the shell are very small in comparison with the body; they take the form of tri-lobate pieces, which encircle the anterior end of the mantle. This rudimentary shell gapes anteriorly for the passage of the pestle-shaped foot, and very widely posteriorly. The mantle further secretes over its whole surface a calcareous tube which lines its burrow, but which does not fuse with the shell valves. Two small accessory shell-pieces, the so-called "palettes," lie at the place where the siphons separate. If the anterior portion of the animal reaches (*i.e.* if it bores through to) the water, the calcareous tube is rounded off and closed.

Aspergillum (*Brechites*, Fig. 30, p. 20, and Fig. 65) and *Clavagella* show similar conditions. In the club-shaped shell, which inserts its anterior thicker end into rock, shell, coral, or sand, we can distinguish a true and a false shell. The false shell forms by far the larger portion of the tube, and corresponds with the secreted tube of *Teredo*, and with a callum like that of *Pholas*. The true shell is very small and lies anteriorly. The two valves of this true but rudimentary shell are, in *Aspergillum*, placed saddle-like over the anterior end of the tube, with which they are firmly fused (Fig. 30, p. 20). Were they isolated, their gape would be unusually wide, not only anteriorly and posteriorly, but ventrally. The shell-tube is open posteriorly, over the apertures of the siphons; anteriorly, however, it is closed (in the adult) by means of a disc perforated like the rose of a watering-can, which corresponds in position with the callum of the *Pholadidae*. The perforations at the edge of the disc, or even over its whole surface, are sometimes produced into calcareous, and at times dichotomously branched tubules. In the middle of the disc there is sometimes found a narrow slit-like aperture corresponding with the pedal aperture in the mantle beneath, but this is often wanting. Less frequently, we find another aperture in the ventral middle line, corresponding with the fourth mantle aperture above described (p. 51).

Aspergillum buries its anterior end in mud or sand, but its whole organisation, and especially its shell arrangement, point to a former boring mode of life.

Clavagella, which is nearly related to *Aspergillum*, bores into rock or the calcareous shells of various other animals. The arrangement of its shell differs from that of *Aspergillum* chiefly in the somewhat greater size of its true valves, and in the fusion of only the left valve with the calcareous tube, the right lying free within that tube.

In the *Pholadidae*, the ligament, which is still found at the hinge, no longer acts for opening the shell. In consequence of a peculiar arrangement of the anterior

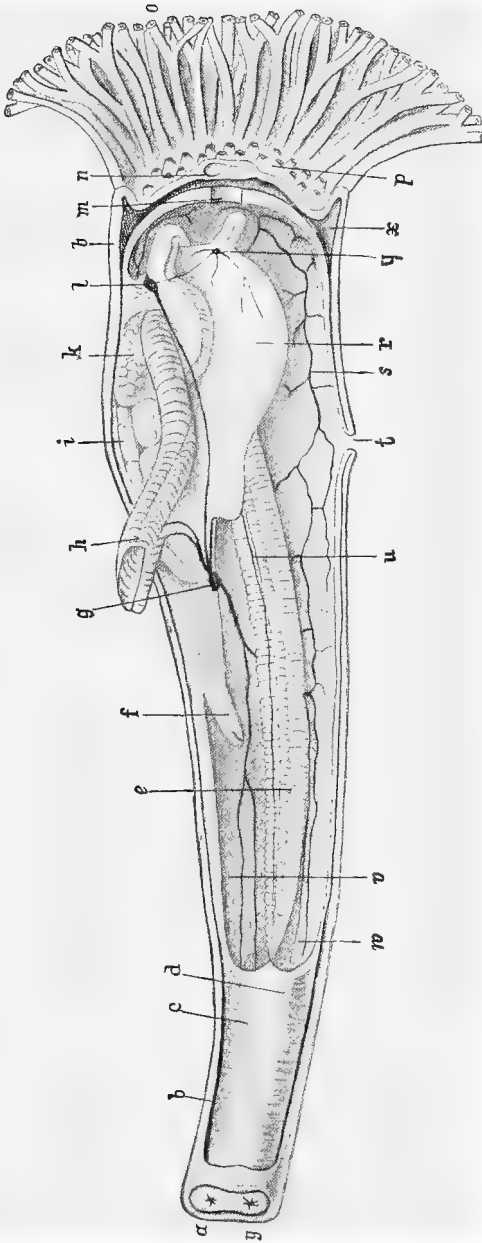

FIG. 65.—Anatomy of *Aspergillum dichotomum*. Shell and mantle of the right side removed (after Lacaze-Duthiers). *a*, Aperture of the anal siphon; *b*, the calcareous tube enclosing the siphons; *c*, anal siphon; *d*, branchial siphon; *e*, left ctenidium; *f*, hind-gut with anus; *g*, visceral ganglion; *h*, right ctenidium; *i*, heart; *j*, cerebral ganglion; *k*, gonad; *l*, pedal aperture; *m*, anterior mantle aperture; *n*, anterior shell aperture (homologous with the pedal aperture in other Molluscs); *o*, *p*, the perforations in the closing piece of the shell produced into tubules; *x*, cavity between mantle and shell; *y*, pedal aperture at the base of the rudimentary foot; *r*, body containing the viscera; *s*, pallial nerve; *t*, fourth mantle aperture; *u*, branchial nerve; *v*, anal chamber; *w*, branchial chamber of the mantle cavity; *y*, outer aperture of the branchial siphon.

adductor, the opening of the shell, such as it is, is brought about by the muscles. The anterior and upper edges of the valves are bent outward, and to these edges the anterior muscle is attached. We thus have external instead of internal points

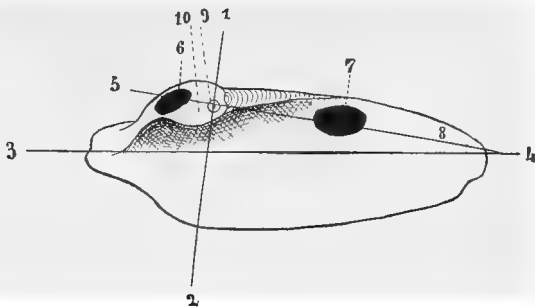

FIG. 66.—*Pholas dactylus*, right valve, internal aspect (after Egger). 1-2, Axis round which the valves move upon one another; 3-4, longitudinal axis of the shell; 5-8, line connecting the shell muscles; 6, anterior muscle; 7, posterior muscle; 9, rotating point of the valves; 10, anterior and upper edge of the shell, which is bent outwards, and to which the muscle 6 is attached; 6-9, shorter anterior; 9-7, longer posterior arm of the lever.

of attachment, and the whole shell may be compared to a double-armed lever acting along the longitudinal axis of the body, its fulcrum being at the point where, in other bivalves, the hinge is found. When the anterior muscle contracts, the shell opens posteriorly and ventrally; when the posterior adductor contracts, the shell closes (Fig. 66).

D. Cephalopoda.

The Cephalopoda are all to be derived from an ancient fossil form which possessed a chambered shell, in the last and largest portion of which the animal lived, leaving the rest of the shell empty, or rather filled with gas (or water) and traversed by the siphon or siphuncle. Such a shell is now found only in the sole living representative of the *Tetrabranchia*, the *Nautilus*, an animal of great importance to the comparative anatomist. Many fossil forms allied to the *Nautilus*, and grouped in the order *Nautiloidea*, possessed such a shell, as did also the *Ammonoidea*, with their enormous wealth of forms which, rightly or not, are generally considered to be nearly related to the *Nautiloidea*, i.e. to belong to the *Tetrabranchia*. In nearly all these animals the shell, when coiled at all, is, unlike the *Gastropod* shell, coiled anteriorly or exogastrically.

One group of the *Nautiloidea*, the *Endoceratidae*, which includes only very old forms (Cambrian and Lower Silurian), is distinguished by the fact that the chambers of its straight shell, which were filled with gas (or water), lay at the side of and not behind the inhabited chamber. There was no real siphuncle, but the upper end of the visceral dome, much narrowed by the air chambers, stretched as far as to the apex of the shell.

In other *Nautiloidea*, the air chambers always lie, as in *Nautilus*, above the occupied chamber, and are traversed by a thin membranous siphuncle, which, however, in old forms, is much thicker, and represented the narrow prolonged portion of the visceral dome (Fig. 32, p. 22).

Some forms of *Nautiloidea* have shells coiled endogastrically; this is never the case, however, when the shell forms a complete spiral. The sutures, which correspond with the lines of insertion of the septa, are simple in the *Nautiloidea*, as

compared with those in the *Ammonoidea*, in which they are folded in a complicated manner.

Nautiloidea.—In the following table we have the chief forms of the shell among the *Nautiloidea*:¹—

- (a) *Orthoceras* group.—Shell straight or slightly bent. Silurian—Trias.
- (b) *Cyrtoceras* group.—Shell curved like a horn, but not regularly spirally coiled. Cambrian—Permian.
- (c) *Gyroceras* group.—Shell regularly spirally coiled, the coils, however, not touching each other. Silurian—Permian.
- (d) *Nautilus* group.—Shell regularly spirally coiled, the coils touching, or the outer clasping the inner. Silurian—recent.
- (e) *Lituites*.—Shell at first regularly spirally coiled, straightening later. Silurian.

The siphuncle runs either through the centre of the septa, or through their anterior or posterior sides.

Ammonoidea.—The shells of the (fossil) Ammonoidea are distinguished by very complicated sutures, their zigzag lines are like the outlines of sharply-indented leaves or richly-branched mosses, they are due to the extraordinary folding of the edges of the septa, which are attached to the inner surface of the shell. The siphuncle is always very thin in the Ammonoidea, and almost always pierces the septa on the posterior side.

The following quotation summarises the chief peculiarities in the form of the Ammonite shell:—²

“The shell, as a rule, forms a closed symmetrical spiral, the coils touching or clasping one another. Some of the oldest forms are straight, or in youth incompletely coiled. In certain groups of the *Ammonoidea* we find a tendency repeated at different times (Trias, Jurassic, Chalk) to depart from the close symmetrical spiral, and to adopt what are called accessory forms. The first step in this process of change is in most cases the detachment of the occupied chamber from the next inner whorl; then, little by little, the inner whorls also separate, though they still remain in the same plane—the *Crioceras* stage. Sometimes the shell grows straight for a time, then becomes hooked—the *Ancyloceras* and *Hamites* stages, and, if only the occupied chamber separates from the coiled part—the *Scaphites* stage. Finally, entirely straight shells arise in the *Baculites* stage. Rarely, the coils leave the symmetrical plane and assume the shape of a snail's shell; in this case, the shells may be either closely or loosely coiled,—the *Turrilites* stage.”

Dibranchia.—The shells of all known *Dibranchia*, extinct or recent, are more or less rudimentary, since they are never capable of sheltering more than a small portion of the animal. Further, they are always internal, on the anterior side of the visceral dome, and are overgrown by a fold of the integument. In *Spirula* (Fig. 33, p. 23) alone, the shell is not completely overgrown, a portion at the apex of the visceral dome remaining uncovered.

The shell of the (fossil) *Belemnites* (Fig. 67 C) is straight, conical, and chambered; the septa are near one another, and are pierced on the posterior or ventral side by the thread-like siphuncle, which is enclosed in short, calcareous sheaths. The apex of the shell (**phragmocone**) is protected by a conical calcareous sheath (**rostrum** or **guard**), the only part usually preserved. The anterior wall of the last chamber is produced downwards into a broad thin process, the **pro-ostracum**.

In *Spirulivostra* (Fig. 67 D), the phragmocone begins to bend posteriorly (endogastrically). The rostrum is triangular and pointed at the top.

¹ Steinmann-Döderlein, *Elemente der Paläontologie*, 1890.

² *Ibid.*

In *Spirula* (E), the shell is coiled spirally and endogastrically. The siphuncle is thick, and is surrounded along its whole length by septal envelopes. The rostrum is rudimentary, and there is no pro-ostacrum.

Starting again from the *Belemnites*, the modification of the shell may take another direction. The phragmocone may become smaller and shorter in comparison with the continually lengthening pro-ostacrum (e.g. *Ostracoteuthis*, F). The rostrum also may become thinner and smaller. Finally, the shell may be reduced to a very

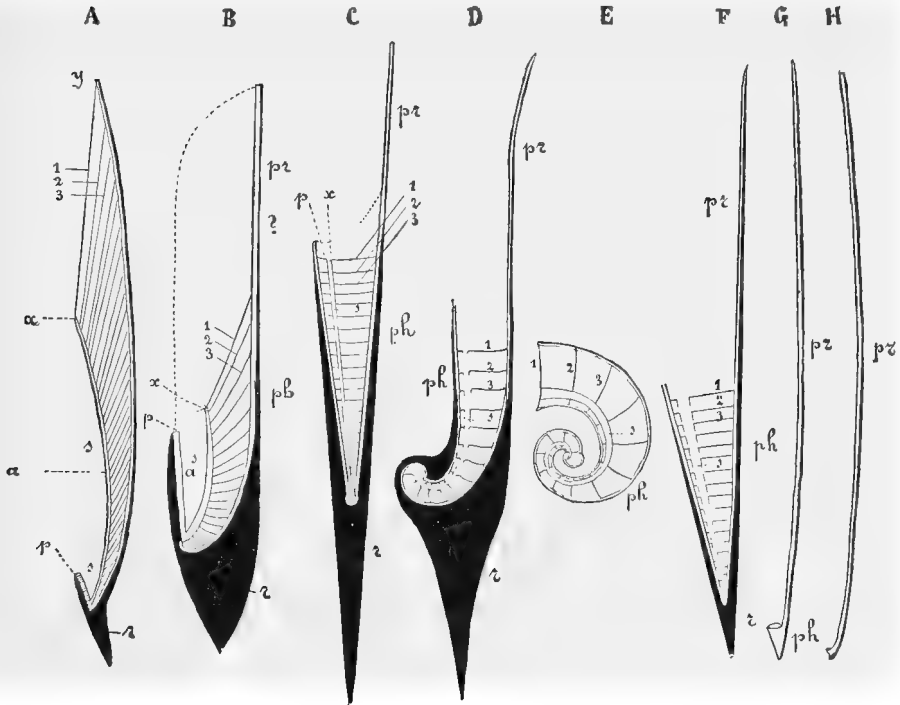

FIG. 67.—A-H, Diagrammatic median sections through the shells of eight extant or fossil *Dibranchia*, from the left side. The point of the visceral dome is turned downwards, the posterior side of the shell is to the left and the anterior to the right (cf. the position of the Cephalopod body, p. 36). A, *Sepia*; B, *Belosepia* (fossil); C, *Belemnite* (fossil); D, *Spirulirostra* (fossil); E, *Spirula*; F, *Ostracoteuthis* (fossil); G, *Ommastrephes*; H, *Loligopsis*; *ph*, chambered shell = phragmocone; *pz*, pro-ostacrum; *r*, rostrum (guard); *s*, siphuncular canal, or space which contains the siphuncle; 1, 2, 3, last three septa (the most recent); α , anterior wall of the siphuncle; *p*, posterior; *x*, anterior edge of the first septal or siphuncular envelope = anterior or posterior edge of the siphuncular canal.

small hollow cone at the end of a long narrow horny lamella which corresponds with the pro-ostacrum, and is called, in the extant *Decapoda*, the **gladius** or **calamus** (or **pen**) (*Loligo*, *Ommastrephes* (G), *Onychoteuthis*). In *Dosidicus*, this terminal cone is almost solid, and in *Loligopsis* (H) it is nothing more than a thickening at the upper end of the gladius; in other *Decapoda*, there is no trace of it on the gladius. In the *Octopoda*, the shell has completely disappeared.

Again starting from the *Belemnite*, the shell may develop in a third direction to form the *Sepia* shell. The transition form is found in *Belosepia* (B) (Eocene),

that is, if this interpretation is correct. This shell is somewhat bent, the septa are crowded together and slope downwards anteriorly. They are penetrated posteriorly by an extremely thick siphon, which is enclosed throughout its whole length in an envelope with a very thick anterior wall. The completely enclosed siphuncular space is thus a wide funnel running through the chambers of the shell on its posterior side (Fig. 67 B). The phragmocone is enclosed in a thick, strongly-developed rostrum, and its anterior and lateral walls are produced downwards into a broad, posteriorly concave shell (prostracum?).

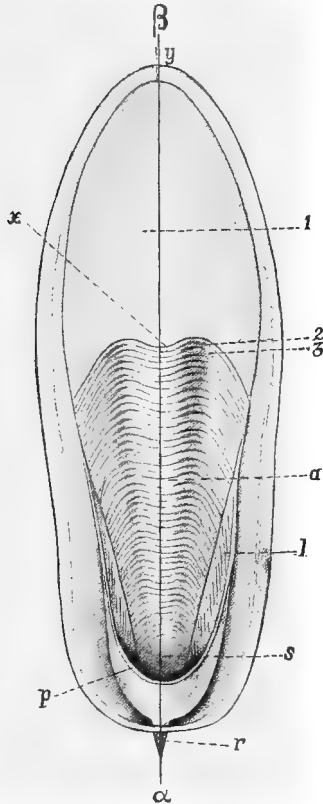

FIG. 68.—Shell of *Sepia aculeata*. Posterior (physiologically ventral) aspect. Lettering as in Fig. 67. The last septum 1 is seen in its whole extent; s, the mouth of the broad, slipper-shaped siphuncular cavity; l, lateral wall of the cavity; α - β , line of the section which in Fig. 67 A is diagrammatised. The two figures should be compared (principal details after D'Orbigny).

anterior pair of arms. It has no nacreous layer, but is porcelanous, and is apparently produced from the integument of the visceral dome and the mantle. The dorsal pair of arms is said only to deposit the so-called black layer on its surface.

It is usually considered that this *Argonaut* shell is not the homologue of the shell of other Cephalopods, but is a formation peculiar to the *Argonaut* female. An opposite view has, however, recently been very ably advanced—that the *Argonaut* shell is an *Ammonite* shell which has lost its septa and siphuncle and also its

These arrangements seem to have culminated in the extant *Sepia* (Figs. 67 A and 68). The siphuncular space fits over the visceral dome like a mould. The anterior portions of the septa slope downward much more obliquely from behind anteriorly, so that, in a back view of the shell, the whole area of the last septum is visible at the surface (Fig. 68, 1). The septa are thin calcareous lamellæ, closely superimposed one upon the other, with very narrow air chambers between them; and these latter are traversed by perpendicular trabeculæ. The shell is thus very light, its specific gravity is less than that of water. Behind the siphuncle, on the posterior very much shortened side of the shell, the short septa are closely contiguous, without any intervening air spaces.

The dorsal end of the shell is enclosed in a small pointed rostrum. The whole anterior surface is covered by a thin lamella of conchyolin, which projects laterally beyond the edge of the shell, and is itself covered by a calcareous layer which is an anterior and ventral extension of the rostrum.

The female *Argonaut* is the single exception to the rule stated above, that in the Octopoda the shell has entirely disappeared. This animal has a light, thin external shell coiled anteriorly or exogastrically, which is not firmly attached to the body at any point, and serves more for receiving the eggs (Figs. 35, 36, pp. 24, 25) than for protecting the body. This shell is surrounded and secured by lobate processes of the

nacreous layer.¹ Should this view prove correct, the Cephalopods would have to be differently classified. The division into *Tetrabranchia* and *Dibranchia* would have to disappear, as we cannot tell whether the fossil *Ammonoidea* were *Tetrabranchia*, and are also ignorant as to when the *Dibranchia* developed from the *Tetrabranchia*. The Cephalopods would then have to be divided into (1) *Nautiloidea* with the extant genus *Nautilus*; (2) *Ammonoidca* with the still living *Octopoda*; and (3) *Belemnoidca* with the extant *Decapoda*.

Bivalve shelly plates called aptychi have been found sometimes in the last chamber of the *Ammonoidea*, sometimes isolated. These have been proved to belong to the bodies of certain species of *Ammonoidea*, and have been considered by some to be protectives for the nidamental gland, by others as opercula, and by others again as the analogues or homologues of the infundibular cartilage of the *Decapoda*. No one of these three views has as yet been generally accepted.

V. Arrangement of the Organs in the Mantle Cavity and of the Outlets of Inner Organs in that Cavity.

A discussion of this subject at this stage will help to explain the asymmetry of the *Gastropoda* and to simplify the discussion in later chapters.

There are, in the mantle cavity, many important organs crowded together in a comparatively small space, and into it also open all the apertures of the inner organs except the oral aperture of the alimentary canal. The term "circum-anal complex," though especially applicable to the arrangement in the *Gastropoda*, is not so suitable as "pallial complex," which applies to nearly all Mollusca, and comprises not only the pallial organs themselves, but the apertures of inner organs that lie in the mantle cavity.

The most important constituents of the pallial complex are the **ctenidium**, the **osphradium** (Spengel's organ, olfactory organ, or accessory gill), the **hypobranchial gland**, the **anus**, and frequently the **rectum** as well, the **nephridial apertures** and often the **renal organ** also, the **genital apertures**, and frequently the **pericardium**, with the enclosed **heart**.

Starting with the *Chitonide*, which, as has already been described (p. 42), must be considered as the most primitive of all living Molluscs, we have:—

The median anus, lying at the posterior end of the body in the mantle groove; on each side of it anteriorly the nephridial apertures, and again on each side, in front of these, the genital apertures.

Assuming this to be the primitive arrangement, we have the following important variations.

A. *Gastropoda*.

1. *Prosobranchia*.

a. Diotocardia.—In *Fissurella*, the pallial complex is still quite symmetrical, but instead of lying posteriorly, as in *Chiton*, it, together with the mantle and the pallial cavity, lies on the front of the visceral dome. We have to imagine that the whole complex has shifted forward along the right side of the body, so that the gill originally on the left has come to lie on the right anteriorly, and that originally on the right now lies anteriorly on the left, and the same applies to the other organs belonging to the complex.

¹ Steinmann, *Bericht Freiburg Gesellsch.*, iv. pp. 113-129.

In order to prevent confusion, the hypothetical original position of each organ will be denoted by *vr* (=originally right) and *vl* (=originally left) in brackets.

In the upper part of the mantle cavity in *Fissurella*, beneath the median aperture in the mantle and shell, lies the anus, and immediately to its right, the right (*vl*) nephridial aperture, immediately to its left the left (*vr*) nephridial aperture; the right (*vl*) and left (*vr*) ctenidia, again, lie symmetrically to the right and left. There are no distinct osphradia, and the genital apertures are wanting as the genital gland opens into the right nephridium.

Haliotis.—The mantle cavity has here shifted to the left, and the rectum, attached to the mantle fold, runs forward some way through it, so that the anus is at a considerable distance from the posterior apex of the cavity. On the right of the rectum lies the right (*vl*), and to its left the left (*vr*) ctenidium, both fastened to the mantle, and stretching far forward. The right and left nephridial apertures lie near the bases of the ctenidia, in the upper and posterior part of the mantle

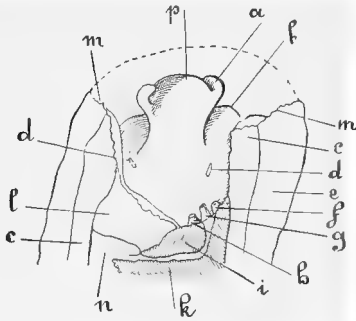

FIG. 69.—Anterior portion of *Patella*, from above, after removal of the mantle fold (after Ray Lankester). *a*, Tentacle; *b*, foot; *c*, pedal muscles (shell muscles); *d*, osphradia; *e*, mantle fold; *f*, aperture of the right nephridium; *g*, anal papilla and anus; *h*, papilla and aperture of the left nephridium; *i*, left nephridium; *j*, right nephridium; *k*, pericardium; *l*, digestive gland (liver); *m*, cut edge of the mantle; *n*, snout.

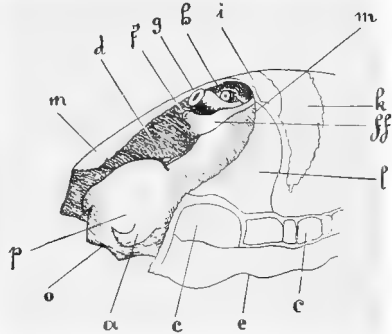

FIG. 70.—The same specimen from the left side. Lettering as before; *o*, mouth.

cavity. Between the rectum and the left ctenidium, also on the mantle, is found the long, well-developed hypobranchial gland (mucous gland), which stretches as far forward as the gill. Only a small portion of the gland lies to the right between the rectum, as far as it runs, and the right ctenidium. There are two osphradia which run as bands along the axes of the ctenidia facing the mantle cavity.

Turbinidæ and Trochidæ.—Only the left (*vr*) ctenidium of *Haliotis* is here retained; it lies far to the left on the roof of the mantle cavity, *i.e.* on the mantle. The rectum runs far forward along this roof. Two nephridial apertures lie on papillæ in the base of the cavity, at the sides of the rectum. The hypobranchial gland is found in various stages of development, the highest being attained in the *Turbinidæ*. It is largest between the rectum and ctenidium, *i.e.* between the right side of the latter and the left side of the former. In the *Turbinidæ*, however, a portion of it lies to the right of the rectum. There is a diffuse osphradium on the axis of the gill.

Neritina.—There is here only one gill (the left (*vr*) in *Haliotis*) shifted somewhat far to the right. The rectum lies asymmetrically to the right in the respiratory cavity,

reaching so far forward that the anus is found near the right edge of the mantle cleft. There is only one nephridial aperture to the left of the base of the ctenidium, far up in the mantle cavity. The inner surface of the mantle, between the rectum on the right

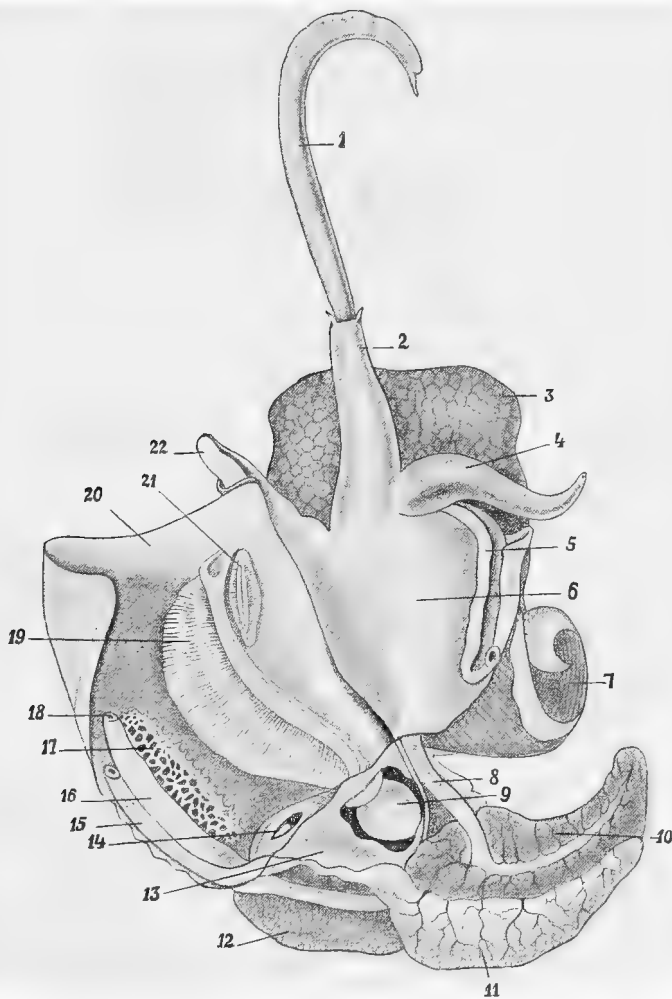

FIG. 71.—*Pyrula tuba*, male, taken out of the shell (after Souleyet). The mantle is cut open along its base and right side, and laid back to the left; the position of the pallial organs is thus reversed. 1, Proboscis; 2, snout; 3, foot; 4, penis; 5, seminal duct, which is continued at 15; 6, floor of the pallial cavity = nuchal integument; 7, columellar muscle; 8, intestine; 9, heart in the opened pericardium; 10, digestive gland (liver); 11, testes; 12 and 13, renal organs; 14, renal aperture; 15, seminal duct; 16, rectum; 17, hypobranchial gland; 18, anus; 19, ctenidium (gill); 20, mantle; 21, osphradium; 22, respiratory siphon.

and the gill on the left, is glandular, and represents the slightly differentiated hypobranchial gland. The genital aperture lies close to the anus.

Docoglossa.—In the *Patellidae* (Figs. 69, 70) a short conical portion of the

rectum projects into the small mantle cavity. This anal cone is not median, but is distinctly shifted to the right. To its right and left lie the nephridial apertures, raised on short conical papillæ. There is no separate genital aperture. In some forms (*Tectura*, *Scurria*, *Acmea*) one ctenidium is found attached to the mantle, on the left side of the pallial cavity. Further details as to the gills in the *Patellidæ* will be given later on. We further find, on the floor of the cavity, on each side, traces of an osphradium in the shape of a small patch of sensory epithelium, which may be raised on a prominence. It is doubtful if the prominence found in *Patella* close to each osphradium, containing a blood sinus divided up by septa, can be considered as a rudimentary gill. These prominences rise from the floor of the mantle cavity, whereas in *Tectura*, for example, in which a true gill still occurs on the left, it lies far removed from the left osphradium, in the usual position on the roof of the cavity, *i.e.* on the inner surface of the mantle.

b. Monotocardia.—In this division, the numerous forms of which show little variety of organisation, the arrangement of the pallial complex is very uniform. The single genital aperture is always distinct from the single nephridial aperture. The position of the organs in the spacious pallial cavity (Fig. 71), from right to left, is as follows:—

1. To the extreme right, lies the afferent duct of the genital organs (ovary or seminal duct), which runs more or less far forward, in the mantle cavity.
2. In contact with this, but quite on the roof of the cavity, is the rectum.
3. To the left of the rectum, far back in the base of the mantle cavity, lies the slit-like nephridial aperture, which pierces the wall separating the cavity from the renal organ behind and above it. Exceptions occur in *Paludina* and *Valvata*, in which this aperture is shifted forward to the end of a urinary duct which runs on the mantle.
4. On the roof of the mantle cavity are found the hypobranchial glands (mucous and purple glands), which are developed in varying degrees.
5. Quite to the left, and also on the roof of the cavity, the ctenidium, feathered on one side (the left (*ur*) of *Haliotis* and *Fissurella*), at whose base, deep back in the cavity, the pericardium is visible with the ventricle and auricle seen through it.
6. Finally, to the extreme left, lies the osphradium, which is always well developed and sharply circumscribed, and is either filamentous or feathered on two sides, and attached to the roof of the pallial cavity.

The position of the organs in the pallial complex of the *Heteropoda*, certain forms of which, such as *Atlanta*, are closely related to the other *Monotocardia*, requires to be re-investigated. The osphradium lies at the base of the gill.

2. Pulmonata.

In the Pulmonata, the single or double (♀ and ♂) genital aperture (Fig. 72) no longer belongs to the pallial complex, but lies outside the mantle cavity laterally on the head or neck. In *Oncidium* the male aperture lies anteriorly under the right tentacle, the female posteriorly, near the anus.

Bearing in mind that the mantle or pulmonary cavity communicates with the exterior only by means of the respiratory aperture lying on the right, we have the following arrangement of the pallial complex as typical (excluding such aberrant forms as *Daudebardia*, *Testacella*, and *Oncidium*).

1. On the extreme right of the pulmonary cavity lies the rectum, the anus opening in the respiratory aperture.
2. On the roof at the back of the cavity lies the nephridium (kidney).
3. To the left, near the kidney, also far up in the cavity, and on its roof, lies

the pericardium, containing the ventricle and auricle, the latter lying in front of

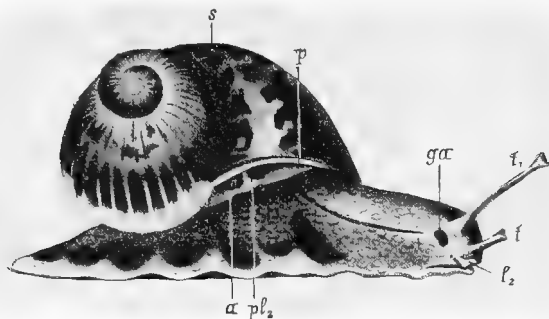

FIG. 72.—*Helix aspersa*, fully extended from the right (after Howes). α , Anus appearing in the respiratory aperture, pl_2 ; s , shell; p , edge of shell aperture; ga , genital aperture; t_1 , optic tentacle; t , anterior tentacle; l_2 , upper lip.

the former. From the ventricle the aortic trunk runs upward and backward, and from the auricle rises the pulmonary vein, which runs forward along the roof of the pulmonary cavity.

4. The respiratory vascular network spreads over the whole remaining surface of the roof of the pulmonary cavity, and is thus in front of the kidney and pericardium.

5. An osphradium has till now only been found in the *Basommatophora* (*Planorbis*, *Physa*, *Limnaeus*), near the respiratory aperture, and among the *Stylommatophora* in *Testacella* on the floor of the pulmonary cavity at its extreme posterior angle.

The floor of the pulmonary cavity (the dorsal nuchal integument) is smooth and devoid of organs.

The arrangement of the efferent ducts of the renal organ varies and deserves special description (Fig. 73).

1. The anterior side of the renal sac opens on a simple papilla in the mantle cavity (*Bulinus oblongus*, and some species of *Planorbis*) (Fig. 73 A).

2. The papilla lengthens and runs forward as a straight ureter (primary ureter). This occurs in most *Basommatophora*, and some species of *Bulinus*, *Cionella*, *Pupa*, *Helix* (B).

3. The ureter runs backward along the kidney, and opens at the base of the respiratory cavity. *Testacella*, and some forms of *Helix* (C).

4. A secondary urinary duct is added, becoming constricted from the wall of

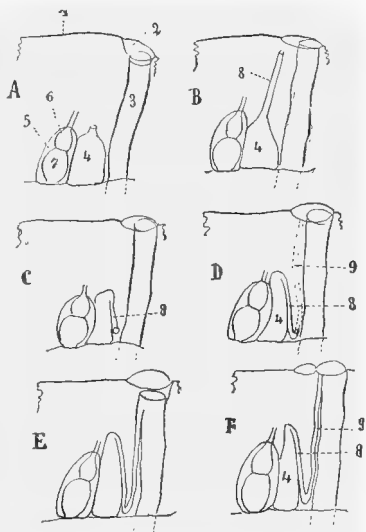

FIG. 73.—Six diagrams illustrating the variations in the renal ducts in the Pulmonata. The organs are supposed to be seen through the mantle above them. 1, Free edge of mantle; 2, respiratory aperture; 3, rectum; 4, kidney; 5, pericardium; 6, auricle; 7, ventricle; 8, primary urinary duct; 9, secondary urinary duct, which, in D, is a groove. Further explanations found in the text.

the pulmonary cavity, and at first forming a more or less closed channel along which the urinary discharge can be forwarded from the base of the cavity to the respiratory aperture. Some species of *Bulinus* and *Helix* (D).

5. The secondary urinary duct becomes closed, and opens either alone or with the anus into the pulmonary cavity. Some species of *Bulinus*, *Helix*, *Daudebardia*, *Vitrina*, *Hyalinia*, *Zonites*, *Arion*, etc. (E).

6. The end of the secondary urinary duct and the end of the rectum together form a cloaca which is distinct from the pulmonary cavity, and opens close to the respiratory aperture. *Limax*, *Amalia*, and some species of *Daudebardia* (F).

When the primary urinary duct runs back along the kidney it is externally indistinguishable from the substance of the latter, and it thus often appears as if the duct rose from the posterior end of the renal organ.

The variations which occur in the position of the organs of the pallial complex in the **carnivorous Pulmonata** are specially interesting. In a series of carnivorous forms, commencing probably with *Hyalinia* among the *Stylommatophora*, and proceeding through *Daudebardia* to the extraordinary genus *Testacella*, we find progressive diminution of the visceral dome and its displacement to the posterior end of the body, simplification and diminution of the shell, and further, a shifting back of the liver and genital organs from the visceral dome into the nuchal portion of the coelom, which now is found along the whole length of the dorsal surface of the foot. Finally, in *Testacella* and certain *Daudebardia*, the visceral dome completely disappears, and the pulmonary cavity covered by the shell is alone left, the cavity reaching up to the apex of the shell. The floor of this cavity, and indeed the whole cavity, with the mantle and the shell, sink down into the body. In this way *Testacella*, which follows its prey, the earthworm, into its underground passages, is admirably adapted to its manner of life; its body is slender, and the somewhat flat shell at its posterior end, which does not stand out above the surrounding surface of the body, in no way hinders its movements. These alterations, however, especially the displacement of the visceral dome to the posterior end of the body, are accompanied by important alterations of position in the pallial organs, which finally lead to the condition called opisthopneumonic.

It is important to note that concrescence of the mantle and the subjacent dorsal integument is complete except at the respiratory aperture on the right, and that the latter shifts farther and farther back, in its relation to the pulmonary cavity, till, in *Testacella*, its position is almost terminal.

The first important step in the displacement of the pallial organs is seen in *Daudebardia rufa*. The pericardium, instead of lying far back at the base of the pulmonary cavity, here lies far forward on its roof, so that by far the greater portion of the vascularised pulmonary tissue lies on the roof *behind* the pericardium (Fig. 74 A). *Daudebardia rufa* is thus actually **opisthopneumonic**. But in this case the relative position of the ventricle and auricle is still unaltered. The auricle is, as before, placed in front of the ventricle; the pulmonary vein from the auricle is thus obliged to bend round in order to run backward, while the aorta, which becomes almost exclusively the anterior or cephalic artery, supplying that portion of the body which lies in front of the visceral dome (by far the greatest part), must bend forward from the ventricle.

In another *Daudebardia*, *D. saulcyi*, the case is somewhat similar, but the kidney and pericardium together form a sort of sac which hangs down into the pulmonary cavity from its roof. In this sac, the ureter lies dorsally and the pericardium ventrally to the kidney. The floor of the cavity sinks right and left deep into the subjacent region of the body.

If we imagine that the pulmonary vein which runs back from the anteriorly

placed auricle, and the aorta which runs forward from the chamber lying behind the auricle have pulled these chambers round in such a way that the flow of blood can have a straight course (*cf.* diagram, Fig. 74), the ventricle will then come to lie in front of the auricle. Indeed, the pericardium (with the ventricle and auricle) has actually twisted round 180° . In this twisting it has been followed by the kidney, which is connected with it by the reno-pericardial aperture, so that the latter organ no longer lies to the right but to the left of the pericardium, the aperture of the urinary duct remaining at its former place. The whole reno-pericardial complex, as compared with its typical position in the *Pulmonata*, is quite reversed. This reversal is characteristic of *Testacella*.

It is, further, noteworthy that, in *Testacella*, the floor of the pulmonary cavity becomes invaginated anteriorly into the body below it to form a large air sac. The walls of this sac are not supplied with blood vessels, and it seems to serve merely as a reservoir of air. In many *Testacellidae* the reno-pericardial complex hangs down in the shape of a sac into this air sac from the roof of the pulmonary cavity.

In the *Vaginulidae* and the *Oncidii* the arrangement of the organs, originally belonging to the pallial complex, deviates still further from the type. A shell is

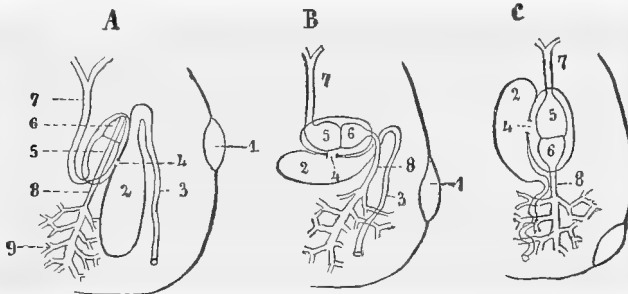

FIG. 74.—Diagrams to illustrate the changes of position in the pallial organs of *Daudebardia* and *Testacella* (adapted from figures by Plate). Mantle organs drawn as in Fig. 73. **A**, *Daudebardia rufa*; **B**, Hypothetical stage, the pallial complex of **A** twisted round 90° ; **C**, *Testacella*. 1, Respiratory aperture; 2, kidney; 3, ureter or urinary duct; 4, reno-pericardial aperture (renal funnel); 5, ventricle; 6, auricle; 7, aorta; 8, pulmonary vein; 9, pulmonary vascular network.

wanting in the adult and a mantle also; and the mantle- or pulmonary cavity seems in consequence to have atrophied. The pericardium lies posteriorly to the right, sunk into the integument, the ventricle lying, as in *Testacella*, in front of the auricle. Respiration takes place principally through the skin; in the amphibious *Oncidia* it is assisted by dorsal papillæ. In *Vaginulus*, the urinary duct joins the proctodæum to form a cloaca which somewhat widens at the point of junction, and opens externally at the posterior part of the body. The same is the case in most *Oncidia*, but in *Oncidium collicum*, the urinary duct and the rectum emerge separately, but one close to the other, at the posterior end of the body. Close to these apertures lies, in all cases, the female genital aperture; the male aperture, however, lies anteriorly to the right below the tentacle.

The cloaca just mentioned, which is filled with air, has given rise to interesting discussions. From its wall there rise into the lumen closely packed folds, which may also be continued along the posterior portion of the urinary duct. The cloaca has therefore been considered by some to be a rudimentary pulmonary cavity, into which the urinary duct and the rectum open. The present writer holds the opinion,

provisionally, that this cloaca has arisen by the junction of the terminal portions of the secondary ureter with the rectum, as in other Pulmonata, but that here the pulmonary cavity having atrophied, it opens outward direct, *i.e.* no longer through a respiratory aperture. Others, again, have thought the arrangement in *Oncidium* and *Vaginulus* to be primitive, the pulmonary cavity appearing here first as an insignificant widening of the terminal portion of the primary ureter.

If this were the case, then the condition described above (p. 75, 1) for *Bulimus oblongus*, where the kidney opens on a papilla direct into the base of the pulmonary cavity, would be thus explained: the pulmonary cavity would have to be considered as a much widened primary urinary duct. Then, in this primary ureter (pulmonary cavity) would follow the successive stages of the development of the secondary ureter, at first an open and later a partially closed channel, and finally a closed tube, so that at last, as in *Helix pomatia*, the primary ureter is divided into two distinct portions, *viz.* the much widened pulmonary cavity and the secondary ureter. But in the *Linnæidae*, for example, the pulmonary cavity admittedly corresponds with the mantle cavity of other Gastropods. The Pulmonata would thus fall into two groups, the *Nephropneusta* (*Stylommatophora*), in which the pulmonary cavity = the widened primary ureter, and the *Branchiopneusta* (*Basommatophora*, *p. parte*), in which the pulmonary cavity = the mantle cavity of other Gastropods.

We consider this view incorrect because of the uniformity of the whole organisation in the *Pulmonata*, and especially because of the occurrence of an osphradium in the pulmonary cavity of a *Stylommatophore* (*Nephropneusta*), *viz.* in the genus *Testacella*. For the osphradium invariably belongs to the mantle cavity, being primitively connected with the ctenidium, it never lies in the urinary duct.

3. Gastropoda Opisthobranchiata.

We can here speak of a pallial complex only in connection with the *Tectibranchia*, since in them alone is a distinct mantle fold developed on the right side of the

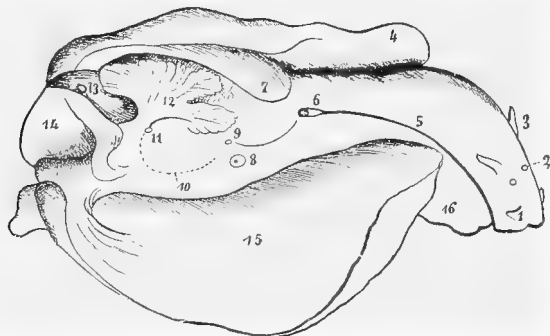

FIG. 75.—*Aplysia*, right aspect, the right parapodium (15) turned downwards; the pallial complex is seen under the mantle fold 7 (after Lankester). 1, Anterior tentacle; 2, eyes; 3, posterior tentacle (rhinophore); 4, left parapodium; 5, seminal furrow; 6, genital aperture; 7, mantle fold; 8, gland; 9, osphradium; 10, outline of some inner organ seen through the integument; 11, nephridial aperture; 12, ctenidium; 13, anus; 15, right parapodium; 16, anterior portion of the foot. (There should be no connecting line between 6 and 9.)

body. The general order of the organs in the pallial cavity (Fig. 75) is as follows:—

1. Far back, and often hardly or not at all covered by the mantle, sometimes at the summit of a conical prominence, lies the anus, and near it occasionally an anal gland.

2. In front of the anus, between it and the ctenidium, is the nephridial aperture. Following these there may be—

3. A hypobranchial gland.

4. The ctenidium.

5. At the base of the ctenidium or on its axis, the osphradium.

Were this complex of organs to be shifted along the edge of the body, we should have the arrangement found in the *Monotocardia* among the *Prosobranchia*. The correspondence is, however, apparently marred by the position of—

6. The genital aperture, which in the Opisthobranchia lies farthest forward of all the pallial organs.

In all other Opisthobranchia (after excluding the *Tectibranchia*) the pallial complex is broken up when the mantle and the true ctenidium disappear. The only exception to this is found in the *Phyllidiidae*, where, apart from the gills, a similar arrangement to that in the *Tectibranchia* occurs. The single or paired genital aperture always lies asymmetrically on the right side in front of the anus, which is sometimes found asymmetrically on the right side, and sometimes has a median dorsal position between the middle and the posterior end of the body. The renal aperture lies between the anus and the genital aperture, sometimes close to the latter.

In the *Pteropoda gymnosomata* (Fig. 76) the shell and mantle are wanting. The ctenidium, when retained, as in the *Drexiobranchia* and *Pneumoderma*, lies somewhat far back on the right side of the body, far behind the anus. On the disappearance of the mantle, it evidently shifted back from its original position between the anus and the genital aperture, while the osphradium, which is generally found close to the ctenidium, has, as far as has yet been observed, retained its original position.

The anus lies anteriorly behind the right fin; the nephridial aperture lies close by, either distinct or united with the anus at the base of a common cloacal depression. Immediately in front of this lies the osphradium, then follows, considerably farther forward on the neck, to the right behind the base of the right fin, the genital aperture, from which, as in many *Tectibranchia*, a ciliated furrow runs forward along the surface of the body to the aperture of the penis, which lies to the right in front of the foot.

All *Thecosomata* have a mantle and a mantle cavity, and often a shell as well; in the *Cymbuliidae*, the latter is replaced by a cartilaginous pseudoconch, a subcutaneous formation of the mantle.

Among the *Thecosomata*, the *Limaciniidae* indicate the primitive arrangement; they possess a dorsal or anterior mantle cavity, a coiled shell, and an operculum.

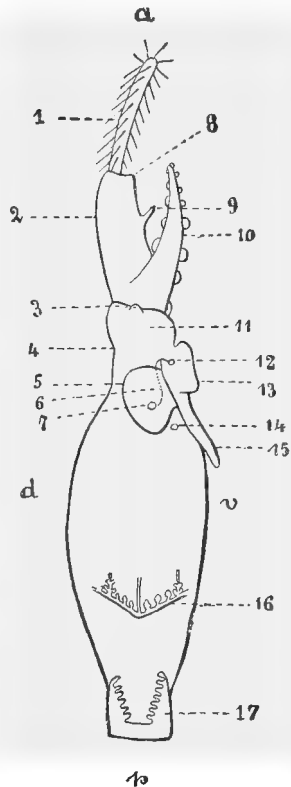

FIG. 76.—*Pneumoderma*, from the right side, diagrammatic (after **Pel-seneer**). 1, Right process bearing hooks (Hakensack) evaginated; 2, proboscis; 3, right buccal tentacle; 4, position of the right nuchal tentacle; 5, right fin (parapodium); 6, seminal furrow; 7, genital aperture; 8, position of the jaw; 9, ventral proboscidal papilla; 10, right buccal appendage bearing suckers; 11, head; 12, aperture of penis; 13, right anterior pedal lobe; 14, anus; 15, posterior pedal lobe; 16, ctenidium; 17, posterior adaptive gill; *d*, *v*, *a*, *p*, dorsal, ventral, anterior, posterior.

The ttenidium, however, is wanting. In the base of the pallial cavity, to the left, lies the pericardium, and immediately in front of it the kidney, with a narrow aperture into the cavity; then follow the osphradium (where this has been found), and, at the extreme right of the cavity, the anus with the anal gland. The mantle gland (hypobranchial gland, shield) is found on the roof of the pallial cavity. The genital aperture lies to the right anteriorly in the cephalic region; from it a ciliated channel or furrow runs dorsally to the aperture of the penis, which lies anteriorly between the fins.

As compared with the *Limacinidae*, i. e. the *Thecosomata* with coiled shell, the

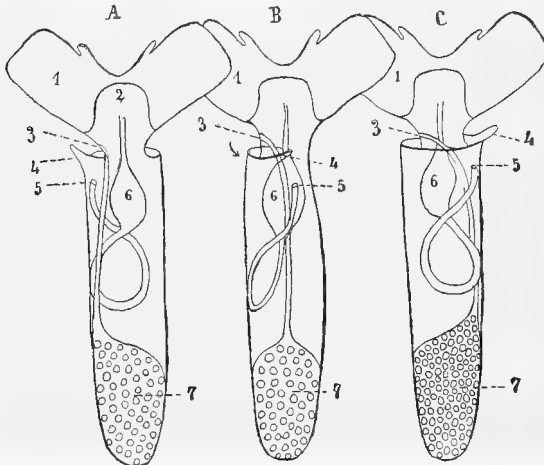

FIG. 77.—A, B, C, Three diagrams to illustrate the relation of the *Limacinidae* to the *Cavoliniidae* (after Boas). A, *Limacinidae*; B, hypothetical intermediate stage between the *Limacinidae* and the *Cavoliniidae*. The visceral dome twisted 90° . C, *Cavoliniidae*. All the diagrams from the ventral or posterior side. In A the visceral dome is drawn straight, whereas it is in reality coiled. 1, Right fin (parapodium); 2, foot bent forward; 3, genital aperture; 4, tentacular appendage of the mantle edge; 5, anus; 6, masticatory stomach; 7, gonad.

Cavoliniidae and *Cymbuliidae*, or *Thecosomata* with straight shell, show a very different arrangement of the pallial complex, which can only be explained by the supposition that the larger posterior portion of the body (the visceral dome) of the *Limacinidae*, with all the pallial organs belonging to it, has twisted round the longitudinal axis of the body 180° , in relation to the cephalic region with the genital apertures belonging to it. Such a twist gives the organs the position they actually occupy in the *Cavoliniidae* and *Cymbuliidae*; the posterior (ventral) pallial cavity containing, on the left the anus, on the right the pericardium and kidney and the osphradium, the genital aperture occupying its original position to the right. The cause and significance of this twist are at present unknown.

B. Scaphopoda.

There is no gill in the posteriorly placed mantle cavity. The anus lies in the middle line above the foot, having a nephridial aperture on each side of it. There are no distinct genital apertures.

C. Lamellibranchia.

The general arrangement of the organs in the mantle cavity of the Lamellibranchia has already been described. The strict symmetry of the body in this class must again be pointed out. All originally paired organs remain paired and symmetrical.

The two **nephridial apertures** lie on the body above the base of the foot, or farther back near the posterior adductor muscle; they usually lie beneath the point of attachment of the gill-axis, between it and the line of concrescence of the (inner) ascending lamella of the branchial leaf with the foot, where such concrescence takes place. In the *Septibranchia*, on the contrary, the apertures open into the upper pallial chamber.

The outer **genital apertures** may be wanting, and in this case the genital products are ejected through the nephridial apertures, which is the primitive arrangement. When present, in dioecious bivalves, they are always found in one pair, and lie on each side just in front of the nephridial apertures, sometimes in the base of a common pit or furrow, less frequently at some distance from these apertures. There are no special copulatory organs.

In hermaphrodite Lamellibranchia the arrangements may vary as follows:—

1. Both kinds of sexual products may be ejected on each side through a common aperture (*Ostraca*, *Pecten*, *Cyclas*, *Pisidium*, etc.).
2. There may be, on each side, two distinct apertures, one male and the other female (*Anatinacea*).
3. The seminal ducts and the oviducts may unite before opening to form a short, common, terminal piece (*Septibranchia*).

The **osphradium** is paired in the Lamellibranchia, and always lies near the posterior adductor muscle over the visceral ganglion, at the point of insertion of the branchial axis on the body. A pair of sensory organs is found in many Lamellibranchia, one on each side of the anus (**abdominal sensory organs**), or to the right and left on the mantle at the inner aperture of the siphons of the Siphoniata (**pallial sensory organs**).

Hypobranchial glands have been found in the *Protobranchia* (*Nuculidæ* and *Solenomyidæ*). They are large and well developed, and belong to the mantle, lying in the posterior part of the body above the base of the gill on each side, to the right and left of the pericardium, and in front of the posterior adductor.

The leaf-like oral lobes (labial palps), one occurring on each side of the mouth, between it and the anterior end of the base of the gill, will be described more in detail in another place.

D. Cephalopoda.

In the Cephalopoda the primitive symmetry of the pallial complex is on the whole retained.

If we cut open the mantle of the *Nautilus* (Figs. 78 and 79), which covers the posteriorly placed pallial cavity, and lay it back on all sides, the following organs are revealed:—

1. On each side there are two gills, an upper and a lower.
2. The anus lies on the visceral dome, between the bases of the four gills.
3. Below the base of each gill is found a nephridial aperture—making four in all.
4. Close to the two upper nephridial apertures lie the two so-called visceropericardial apertures.
5. Between the bases of the lower gills there are in each sex, two genital

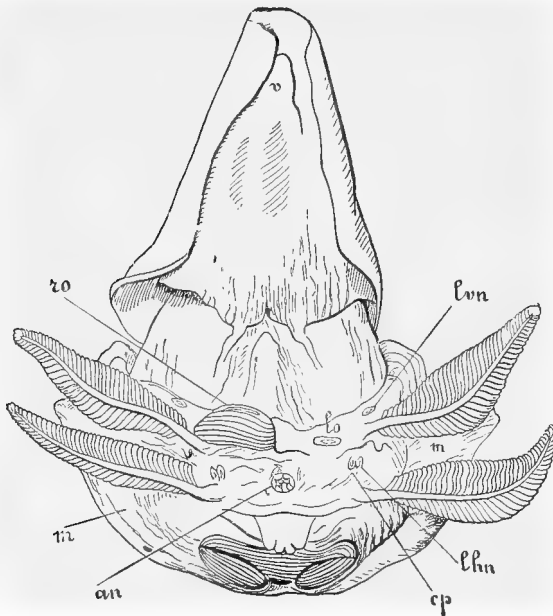

FIG. 78.—Pallial complex and siphon of *Nautilus pompilius* ♀ (after Bourne and Lankester). *r*, Valve of the siphon; *ro*, right genital aperture; *m*, the mantle fold, with the nidamental gland, folded back; *an*, anus; *cp*, left aperture of the secondary coelom; *lhv*, left upper nephridial aperture; *lo*, aperture of the left rudimentary oviduct; *lvn*, left lower nephridial aperture. The four ctenidia are not lettered.

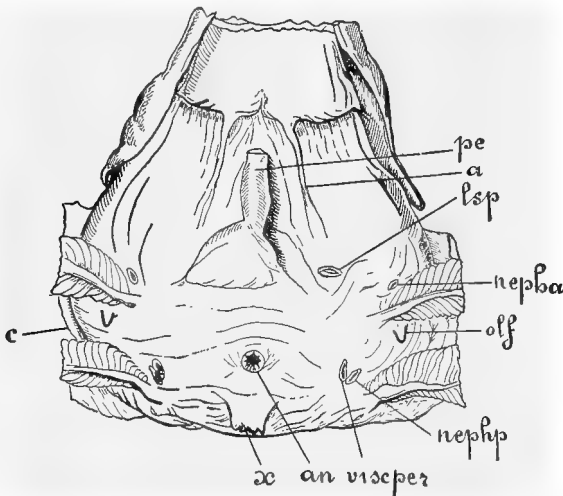

FIG. 79.—Pallial complex of *Nautilus pompilius* ♂ (after Bourne and Lankester). *pe*, Penis; *a*, muscle band of the siphon; *lsp*, aperture of the left rudimentary seminal duct; *nephra*, *nephyp*, lower and upper nephridial aperture of the left side; *olf*, left osphradium; *viscer*, left aperture of the secondary coelom; *an*, anus; *s*, supra-anal papilla of unknown significance; *c*, mantle cut off.

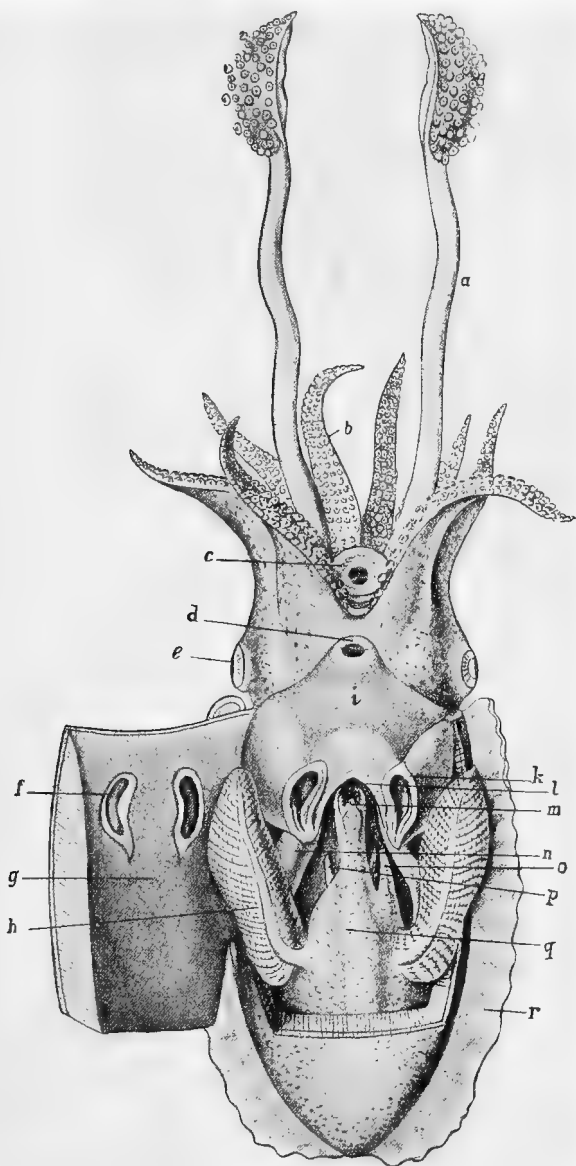

FIG. 80.—*Sepia Savignyana*, from behind (after Savigny). The greater part of the mantle cut open and laid back on the right side (left in the figure). *a*, Prehensile tentacle; *b*, oral arm; *c*, mouth with jaws; *d*, lower aperture of siphon; *e*, eye; *f*, locking apparatus of the mantle; *g*; *h*, right ctenidium; *i*, siphon; *k*, locking apparatus of the mantle on the visceral dome; *l*, upper aperture of siphon; *m*, anus; *n*, depressor infundibuli; *o*, penis; *p*, right nephridial aperture; *q*, posterior integument of the visceral dome; *r*, fin.

apertures, but only that on the right side is functional. In the male, the aperture is produced into a tubular penis.

6. Above the bases of the lower gills there is an osphradium on each side placed on a papilla.

7. Above the anus there is a large median papilla of unknown significance.

8. The nidamental gland lies dorsally in the mantle.

If we compare with the above the pallial complex of a dibranchiate Cephalopod, such as *Sepia* (Fig. 80), we find the following arrangements :—

1. There is one gill on each side.

2. Along the median line of the visceral dome, the rectum and the duct of the ink-bag descend together, to open through a common aperture at the tip of a papilla at the base of the siphon.

3. On each side near the rectum, above the anus, a nephridial aperture occurs on the point of a papilla.

4. Of the two paired genital apertures only the left has been retained in *Sepia* and many other Cephalopods; this lies near the left nephridial aperture at the summit of a large papilla (penis). In the female *Octopus*, the genital apertures are paired and symmetrical, and lie to the right and left of the rectum.

5. The two nidamental glands (in *Decapoda*) lie in the visceral dome, symmetrically with regard to the median line; they open above the nephridial apertures into the mantle cavity.

VI. The Respiratory Organs.

The True Gills or Ctenidia.

The most important of the pallial organs in the Mollusca is the gill, for it is in order to protect it that the mantle, and with it the pallial cavity, develop. The gill found in the mantle cavity is throughout all the divisions of the Mollusca a homologous organ, to be derived from the gill of a common racial form. But since this gill is wanting in certain Mollusca (*e.g.* many *Opisthobranchia*), and is functionally replaced by new organs which are morphologically altogether unconnected with it, it has been found useful to distinguish the primitive Molluscan gill by the name of **ctenidium**. This word, therefore, has a special morphological significance.

The **ctenidia** of the Mollusca are **originally paired** and **symmetrically** arranged ciliated processes of the body wall, **carrying two rows of branchial leaflets**, and **projecting into the mantle cavity**.

Venous blood flows into the gills through afferent vessels (branchial arteries), and after becoming arterial by means of the respiration, flows through efferent vessels (branchial veins) back to the body, passing first through the heart. At or near the base of each ctenidium there always lies a sensory organ, which is considered as olfactory, the so-called **osphradium** or Spengel's organ.

Such primitive ctenidia are met with first in that group of the Mollusca which has undoubtedly retained more primitive characteristics than any other, *viz.* the *Chitonidae* among the *Amphineura*. They are, further, found in all other Mollusca which have retained the original

bilateral symmetry of the body, such as the *Lamellibranchia*, the *Cephalopoda*, and—a point of great importance—also in the primitive

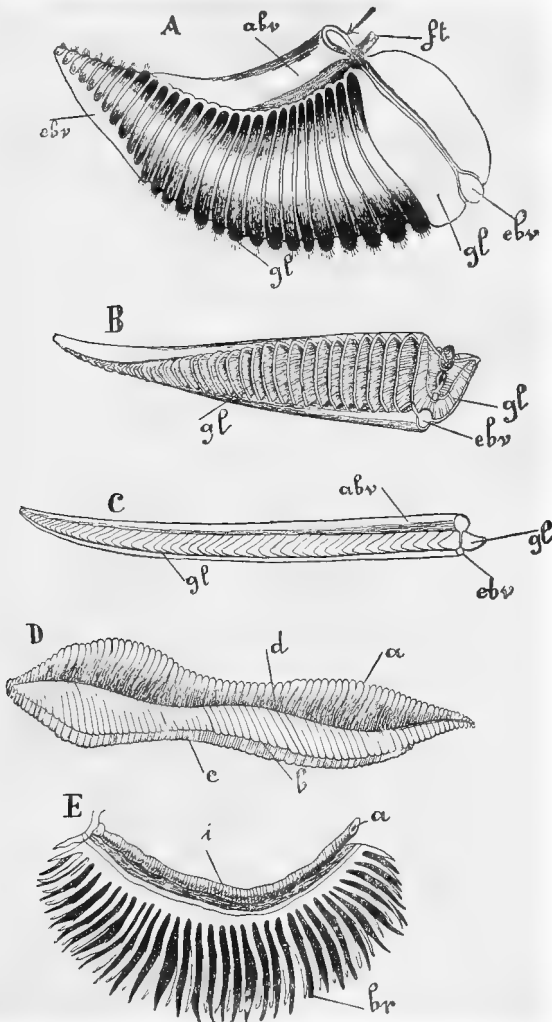

FIG. 81.—Ctenidia of various Molluscs (after Ray Lankester). A, Chiton; B, Sepia; C, Fissurella; D, Nucula; E, Paludina. *ft*, Longitudinal branchial muscle; *abv*, afferent branchial vessel; *ebv*, efferent branchial vessel (branchial vein); *gl*, paired lamellæ (leaflets) of the feathered gill; in D: *d*, position of the axis; *a*, inner; *b* and *c*, outer rows of branchial lamellæ; in E: *i*, rectum; *br*, branchial filaments; *a*, anus.

Gastropoda, the *Zeugobranchia*. In the latter, however, the left ctenidium was originally the right and *vice versa*, but this will be dealt with more in detail later.

With regard to the number of gills originally present on each side of the body, opinions are divided. Those who hold that there were several seem justified by the arrangement in *Chiton*, where numerous consecutive ctenidia lie in a longitudinal row in the branchial furrow (mantle cavity) on each side, and also by that in the *Nautilus*, which is rightly considered the most primitive of extant *Cephalopods*, where four gills are found (*Tetrabranchia*). We shall, however, see later that the other view, viz. that the *Mollusca* originally possessed only one pair of ctenidia, has, to say the least, equal claim to be accepted.

In all other *Mollusca* with paired ctenidia, including the *Lamelli-branchia*, there is only one pair at the posterior part of the body. Further, in the racial form of the *Prosobranchia*, a single pair of gills must be assumed to have occupied a posterior position in a mantle cavity which, with them, shifted forward later to the anterior position. The *Zeugobranchia* still retain this single pair of gills.

In most *Prosobranchia*, the asymmetry of the body is also seen in the gills, only the left gill of the two in the *Fissurellidæ* and *Haliotidæ* being retained, the right completely disappearing. In the forms which most resemble the *Fissurellidæ* and *Haliotidæ*, the single-gilled *Diotocardia* (*Turbinidæ*, *Trochidæ*, etc.), the gill is still feathered on both sides, but in all *Monotocardia* it has only a single row of leaflets.

In one division of the *Opisthobranchia*, the *Tectibranchia*, one ctenidium is still retained, that on the right side. Other *Opisthobranchia* have lost the true ctenidium together with the mantle cavity; it may be replaced by analogous (but not homologous) respiratory organs, such as adaptive gills.

The *Pulmonata*, in consequence of their adaptation to aerial respiration, have lost the ctenidia.

The blood, which has become arterial in the ctenidia, reaches the heart through the auricle, and passes into the body through the arteries. It is therefore evident that a close relation must exist between the gills and auricles. This relation is briefly as follows: where the gills are paired, the auricles are paired, and unpaired gills are accompanied by a single auricle on that side of the body on which the gill is retained. Where gills are paired, there is almost always only one pair, and then there is one right and one left auricle.

The *Nautilus* has four gills, and, to correspond, two right and two left auricles. The *Chitonidæ*, on the other hand, in spite of their numerous pairs of gills, have only one right and one left auricle.

The *Scaphopoda* possess neither true ctenidia nor any other localised gills. Respiration may take place at the various soft-skinned surfaces which come in contact with the water, such as the inner surface of the mantle, the tentacles, etc.

A. Amphineura.

Chitonidæ.—A single ctenidium of a *Chiton* (Fig. 82) may serve as a type of the Molluscan gill with its two rows of leaflets. The plumose ctenidium rises freely from

the base of the branchial groove (mantle cavity). The axis here takes the shape of a thin septum. At each side, on the broader surface of the septum, extending from

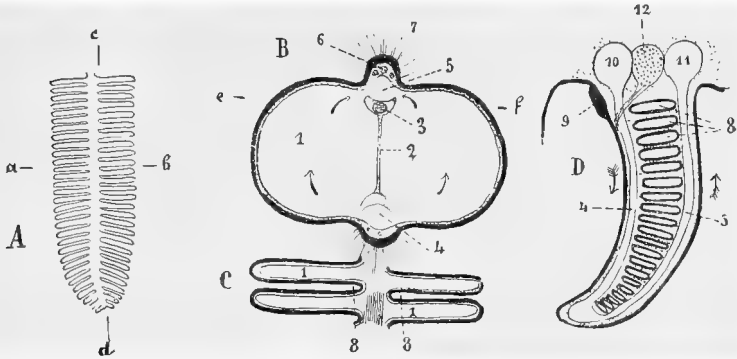

FIG. 82.—Structure of the ctenidium of a Chiton (after B. Haller). **A**, Single ctenidium with its double row of branchial leaflets. **B**, Transverse section of the gill along the line *a-b* in Fig. **A**. 1, Narrow blood sinus in the branchial leaflet; 2, septum in its axis; 3, longitudinal muscle; 4, afferent branchial vessel; 5, efferent branchial vessel; 6, nerves; 7, long cilia on the branchial axis. **C**, 2 pairs of branchial leaflets cut through at right angles to their surfaces, along the line *c-f* in Fig. **B**. 1, Same as in Fig. **B**; 8, space between the consecutive branchial leaflets. **D**, Longitudinal section of the ctenidium somewhat laterally to the axis, and parallel to its septum, along the line *c-d* in Fig. **A**. This section is part of a transverse section of the body. Lettering as in Figs. **B** and **C**. In addition: 9, olfactory ridge of the branchial epithelium; 10, general afferent branchial vessel; 11, general efferent branchial vessel; 12, pleuro-visceral strand of the nervous system. The branchial epithelium is everywhere indicated by a thick black line.

base to tip, there is one row of smooth, delicate branchial leaflets. In outline they are more or less semicircular, and stand crowded together in great numbers almost like the leaves of a book. The entire surface of the branchial epithelium is ciliated; on the axial epithelium, the cilia are remarkably long. On that side of the axis which is turned towards the foot, a blood-vessel runs from base to tip, conducting venous blood to the gill (afferent branchial vessel). On the opposite side, which faces the mantle, another vessel, the branchial vein, runs from the tip to the base of the gill, and carries the blood, which has become arterial by respiration, to the general branchial vein, and through it to the auricle. These vessels have no special endothelial walls, but are surrounded by circular muscle fibres. The branchial vein is accompanied by a powerful longitudinal muscle. At the base of each branchial leaflet, the blood flows out of the branchial artery through an aperture into the narrow cavity of the leaflet, and passes through a similar aperture on the opposite side of the axis to enter the branchial vein. Nerves are supplied to the ctenidium from the pleuro-visceral nerve which runs close to its base.

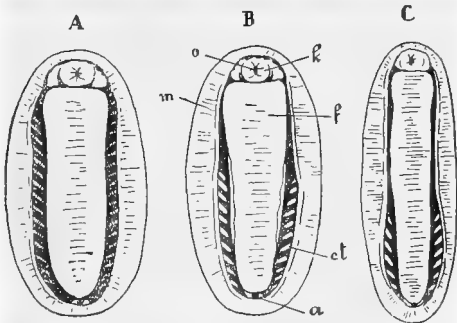

FIG. 83.—Diagrams illustrating the arrangement of the gills in the Chitonidae. *m*, Mantle; *o*, mouth; *k*, snout; *f*, foot; *ct*, ctenidia; *a*, anus.

At the base of each branchial leaflet, the blood flows out of the branchial artery through an aperture into the narrow cavity of the leaflet, and passes through a similar aperture on the opposite side of the axis to enter the branchial vein. Nerves are supplied to the ctenidium from the pleuro-visceral nerve which runs close to its base.

The number of ctenidia in each row varies very much in the different species of *Chitonidae*; it ranges from 14 to 75. The row extends along the whole length of the branchial furrow (Fig. 83 A), or else (in *Chiton laevis*, *C. Pallasii*, and *Chitonellus*) is confined to its posterior half (B, C).

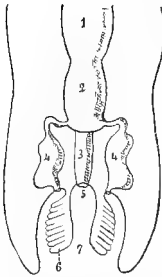

FIG. 84. Posterior end of the body of *Chætoderma* (diagram after Hubrecht). 1, Gonad; 2, pericardium; 3, rectum; 4, nephridium; 5, anus; 6, ctenidium; 7, cloaca.

Solenogastres.—(*Proneomenia*, *Neomenia*, *Chetoderma*). The mantle cavity, in these forms, is much reduced, consisting only of the groove on each side of the rudimentary foot; it opens into the cloacal cavity, or rather widens to form that cavity. The cloaca is thus the posterior portion of the mantle cavity. In *Chetoderma* (Fig. 84) the foot has disappeared, and the mantle cavity is reduced to the cloaca, in which one typical gill lies on each side of the anus. These gills are regarded as the last ctenidia of the rows found in the *Chitonidae*, which in *Chitonellus* and some species of *Chiton* are already confined to the posterior half of the body. In *Neomenia*, there is no longer a pair of ctenidia, but a mere tuft of filaments rising from the wall of the cloacal cavity, and in *Proneomenia*, there are only irregular folds of the cloacal wall.

On the relation of the gills in the *Chitonidae* to certain patches of epithelium, which may perhaps be considered as osphradia, see the section on Olfactory Organs, p. 165.

B. Gastropoda.

The *Fissurellidae* (Fig. 85, A and B) among the *Prosobranchia* stand nearest to the racial form of the Gastropoda. The mantle cavity is anteriorly placed; into it from behind and above project two long gills feathered on each side; these lie symmetrically to the middle line, and to the right and left of the anus. The posterior portion of their axes is connected by a band with the floor of the respiratory cavity, while the anterior pointed portion projects freely.

The fact that in the *Fissurellidae* (and related forms) the gills are paired and symmetrical is very significant. It points to the primitive character of these forms, and enables us to compare their gills with those of the lower *Lamellibranchia*, *i.e.* the *Protobranchia*, and of the *Cephalopoda*. We must, however, again emphasise the generally-assumed fact that the left gill of *Fissurella* answers to the right gill of the *Lamellibranchia* and *Cephalopoda*, and the right gill of the former to the left of the latter, these latter having retained their primitive symmetry in this respect. This assumption becomes the more plausible when we consider that the mantle cavity with its organs originally lay posteriorly on the body, and shifted forward secondarily along its right side.

The *Haliotidae* are closely connected with the *Fissurellidae*. Their spacious mantle cavity is, however, forced to the left side by the great development of the columellar muscle. There are two gills, feathered on both sides, of which the right is the smaller. The axis of each gill has united, for nearly its whole length, with the inner wall of the mantle, and only its anterior end is free; its tip even projects a short distance beyond the respiratory cavity.

Although the *Fissurellidae* and *Haliotidae* still possess two gills, other *Diotocardia* have retained only the left (ur) and larger gill of *Haliotis*. This gill is, however, still feathered on both sides, although this characteristic is obscured in a peculiar manner. The septum or axis of the gill, to the broader surfaces of which the branchial leaflets are attached, and one edge of which had, in *Haliotis*, already fused with the

inner wall of the mantle, becomes attached to the mantle by its other edge also (viz. that along which the branchial artery runs), somewhat to the right of the first line of concrescence. In this manner, which is illustrated by the accompanying diagrammatic sections (Fig. 86), the mantle cavity is divided by the branchial septum into two unequal parts, which open into one another anteriorly.

Into the much smaller upper division the one row of smaller branchial leaflets projects, while the opposite row of larger leaflets hangs down into the lower and larger chamber. The anterior end of the gill, however, is still free, its point projecting anteriorly (*Trochidae*, *Turbinidae*, *Neritidae*).

In the *Docoglossa* (*Patellida*) the arrangement of the gills is very varied. While the *Leptidae* have no gills whatever, we find in *Patella* a single row of numerous small branchial leaflets right round the body, on the inner or under side of the short encircling mantle fold, between it and the foot. This row is broken only in one place anteriorly on the left. It is, however, evident that these gills, which somewhat resemble those of the *Chitonidae*, are no true ctenidia, from the fact that there are *Docoglossa* (e.g. some forms of *Tectura* and *Scurria*) which possess, in addition to this marginal row of leaflets, a typical ctenidium corresponding in every way with that of the *Turbinidae*, *Trochidae*, etc. Other forms, such as *Acmaea*, have only the true ctenidium and no marginal branchial leaflets.

In the large second division of the *Prosobranchia*—the *Monotocardia*—the arrangement of the gills is, on the whole, remarkably uniform. There is only a single gill feathered on one side (Fig. 71, p. 73), united to the mantle along almost its whole length; this gill corresponds with the left gill in *Fissurella* and *Haliotis*, and the single gill in *Turbo* and *Trochus*. It generally lies quite to the left in the mantle cavity.

The rise of this gill can best be explained by recalling the arrangements already described in *Turbo* and *Trochus*. We have only to assume that the row of small leaflets turned towards the mantle in *Turbo* disappears, and that the branchial septum unites with the mantle across its whole width (Fig. 86, C, D).

A few anomalous forms alone require special mention.

1. In a series of terrestrial *Monotocardia*, aerial respiration has taken the place of aquatic respiration, and the ctenidium has disappeared (*Acicula*, *Cyclostoma*, *Cyclophorus*, etc.).

2. The *Ampullaria* are amphibian *Prosobranchia*. A doubling of the mantle gives rise to a very spacious pulmonary sac, on the inner surface of which the respiratory vascular network spreads out. The lower wall of this pulmonary sac, which forms at the same time the roof of the mantle cavity, is perforated by an aperture

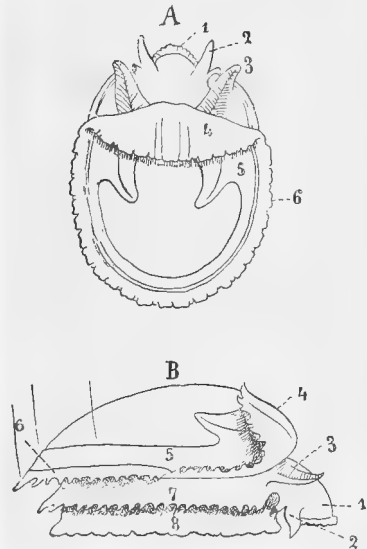

FIG. 85.—Submarginula after removal of the shell (after FISCHER). A, from above; B, from right side. The mantle cavity is exposed by bending back the mantle fold 4. 1, Snout; 2, tentacle, with the eye on its short stalk behind it; 3, right ctenidium; 4, mantle fold; 5, shell muscle; 6, edge of the mantle encircling the body; 7, epipodium; 8, foot.

for the inhalation and exhalation of air.¹ The ctenidium is placed to the extreme right of the mantle cavity, a position which is in some way connected with the great development of the pulmonary sac. It nevertheless answers to the left gill in other *Monotocardia*, as can be seen from its innervation.

3. The genus *Valvata* is unlike all other *Monotocardia*, in that its gill is feathered on both sides and projects freely. It can, further, be protruded from the pallial cavity.

4. In *Atlanta*, among the *Heteropoda*, the gill is well hidden in the spacious mantle cavity. In *Carinaria*, it is only slightly protected in consequence of the small development of the mantle fold. In *Pterotrachea* there is no mantle fold, and the filamentous branchial leaflets project free and uncovered. *Firololides* has no gills.

Opisthobranchia.—A true ctenidium is here found only in the *Tectibranchia* and

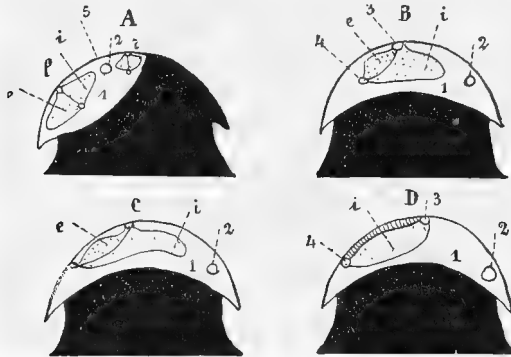

FIG. 86.—General Morphology of the gills of the Prosobranchia. Diagrammatic sections in the region of the mantle cavity, from behind. **A**, *Haliotis*; **B**, *Trochus*, anterior portion of the pallial cavity. **C**, *Trochus*, middle or posterior portion of the cavity. **D**, *Monotocardia*. 1, Mantle cavity; 2, rectum or anus, *r* right, *l* left gill of *Haliotis* (**A**), which latter is the only gill present in the *Azygobranchia* (**B**, **C**) and *Monotocardia* (**D**). *i*, Branchial leaflet of the inner row; *e*, ditto of the outer row, between them the branchial axis or septum with the afferent and efferent branchial vessels (3 and 4); 5, position of the mantle slit in *Haliotis* (cf. p. 43). Further explanations in the text.

in the *Steganobranchia* among the *Ascoglossa*. It lies, often incompletely covered, in the mantle cavity which is developed on the right, and is, in some cases at least (e.g. *Pleurobranchus*), distinctly feathered on both sides.

In the *Pteropoda*, which must be derived from the tectibranchiate Opisthobranchia, the ctenidium, when present, is little developed, and lies on the right side of the body. It answers to the tectibranchiate ctenidium.

In the *Gymnosomata*, this true gill is retained only in the *Pneumodermidæ* as a simple, or less frequently (*Pneumoderma*) fringed, process on the right side of the body (Fig. 76, p. 79). New gills, on the other hand, may develop at the posterior end of the body, occurring either together with the true ctenidium (*Spongiobranchæa*, *Pneumoderma*), or alone (*Clionopsis*, *Notobranchæa*), until they in their turn disappear (*Clione*, *Hulopsyche*).

Among the *Thecosomata*, the *Cavoliniidæ* alone (Fig. 87) possess a gill which

¹ In this and in the closely-allied *Lanistes* there is in addition a protrusible siphon on the left side (v. Fischer and Bouvier, *C. R.* cxi. p. 200).

risers in the form of a series of fold-like elevations of the body wall in the pallial

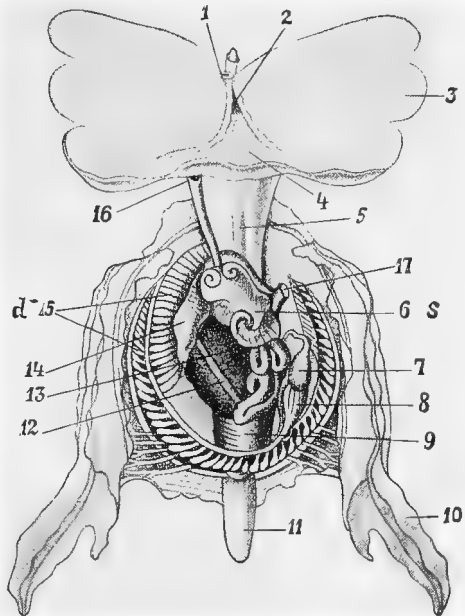

FIG. 87.—Anatomy of *Cavolinia tridentata* (after Souleyet). Shell and mantle removed, and visceral dome partly opened, seen from behind and below. *d*, Right; *s*, left; 1, aperture of the penis; 2, mouth; 3, left fin (parapodium); 4, foot; 5, œsophagus; 6, part of the efferent genital apparatus; 7, ventricle; 8, auricle; 9, hermaphrodite gland; 10, lateral processes of the mantle; 11, columellar muscle; 12, intestine; 13, digestive gland (liver); 14, stomach; 15, ctenidium; 16, genital aperture; 17, anus.

cavity, and which, running in a wavy line, forms a semicircle, open anteriorly, the greater portion of it, however, lying on the right side.

C. Lamellibranchia.

The Lamellibranchia also possess typically two symmetrically placed gills, each provided with two rows of branchial leaflets. The opinion which until lately was common, that the Lamellibranchia possessed two gills on each side of the mantle cavity, has been shown to be incorrect—these two gills in reality answering to the two rows of branchial leaflets of one typical gill.

It is worth while to follow, step by step, the interesting series of modifications undergone by the original gill in the Lamellibranchia.

(a) The primitive arrangement is found in the **Protobranchia**. Taking *Nucula* (Fig. 21, p. 14) as an example, we find a gill like that of *Fissurella*, consisting of an axis along which the branchial artery and the branchial vein run, and which is attached by a short membranous band to the posterior and upper portion of the body or visceral dome, and to the posterior adductor muscle. On this axis are attached two rows of short flat branchial leaflets. These two plumose gills converge posteriorly, and project with their free tips into the mantle cavity. The leaflets of both rows are directed somewhat downwards, so that they are at right angles to one another. In *Malletia* and *Solenomya*, on the contrary, they lie in the same plane, the two rows standing out on opposite sides of the axis. In *Malletia*, this plane is horizontal, but in *Solenomya* it trends downwards and inwards. The number of leaflets on the very slender gill of *Malletia* is much smaller than on that of *Nucula*; they are consequently neither so crowded nor so flattened. Each leaflet contains a blood

sinus, which is a continuation of the branchial artery. Two rods of connective tissue run along the lower edge of each leaflet from the axis to its tip, and serve for its support. Similar supports are found in almost all Lamellibranchia and in many *Gastropods*.

The epithelium of the branchial leaflets is beset with long cilia—(1) at the ventral edge; (2) on both (anterior and posterior) surfaces, near the ventral edge.

The first-named cilia form, with regard to the whole gill, a longitudinal row along the free ventral edge of each row of leaflets, and bring about a current in the water along this edge from behind forward. The other cilia mentioned above, mingling together like the bristles of two brushes which are pressed together, form a loose connection between the successive leaflets of the row.

(b) In the **Filibranchia** (Fig. 88 B) the leaflets in each of the two rows are very long and filamentous, and hang down far into the mantle cavity. The branchial filaments of the two rows are recurved and bent back upon themselves, so that in each filament a descending and an ascending portion can be distinguished. The prolongation of the filaments corresponds with a necessary increase of the respiratory

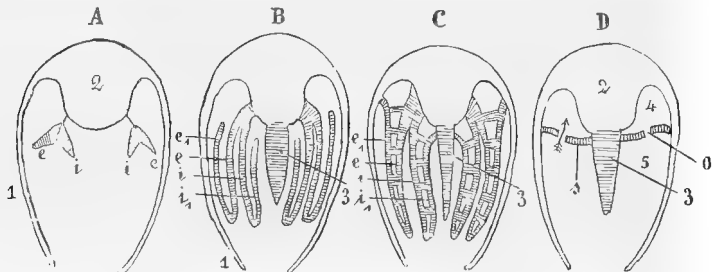

FIG. 88. Morphology of the gills of the Lamellibranchia, diagrammatic transverse sections. A, Protobranchia. B, Filibranchia. C, Eulamellibranchia. D, Septibranchia. 1, Mantle; 2, body (visceral dome); 3, foot; *e*, in A, branchial leaflets of the outer row in the feathered gill, in B, branchial filaments of the outer row, in C, outer branchial leaf; *i*, branchial leaflets or filaments of the inner row or inner branchial leaf; *e*₁, ascending branch of the outer filament, or lamella of the outer leaf; *i*₁, ascending branch of the inner filament, or lamella of the inner leaf; in D, *s*, signifies the gill which has become transformed into a muscular septum which divides the mantle cavity into an upper (4) and a lower (5) chamber, the two communicating by means of slits (*o*) in the septum. Further explanations in the text.

surface. By this bending back of the filaments, the gills make the most of the limited space afforded by the mantle cavity. Each filament of the outer row is bent outwards, and of the inner row inwards.

The filaments of each row may be so crowded together that the whole row looks like a leaf or fringe. This branchial leaf consists of two closely contiguous lamellæ, one the descending and the other the ascending, the two passing into one another at the lower edge of the leaf. The descending lamella is formed by the descending portions of the filaments, and the ascending by the ascending portions. On the outer leaf, the ascending lamella is the outer one, on the inner leaf the inner.

In the Filibranchia, the separate branchial filaments retain their independence—they are free, *i.e.* the separate filaments of a series are unconnected with one another, and the descending and ascending portions of one and the same filament are in no way united. There are, however, on both the anterior and posterior sides of the filaments places covered with long cilia closely crowded together. These ciliated tufts on adjoining filaments mingle, and so give rise to a sort of connection between the filaments of each leaf.

In the *Mgylidæ*, so-called interfoliar junctions or trabeculæ occur at certain

points between the ascending and descending portions of the branchial filaments, but no blood-vessels run into them.

In *Anomia*, the dorsal ends of the ascending portions of the outer lamella are free, but in the *Arcidae* united, although their internal cavities are not in communication. In such cases, the interior of each filament is divided by a longitudinal septum into two canals. In one of these the blood flows from base to tip, and in the other back from tip to base, *i.e.* to the axis. In the *Mytilidae*, the dorsal ends of the recurved portions of the filaments of each branch have grown together, and their blood-vessels communicate at the points of junction, *i.e.* along the upper edge of the ascending lamella.

(c) **Pseudolamellibranchia.**—Each leaf of the gill is here folded, to secure increase of surface. The plications run longitudinally with regard to the filaments, and are thus almost dorso-ventral. There are, therefore, distinct alternate ridges and furrows on each leaf, the ridges on the one surface corresponding with those on the other, and the furrows corresponding with furrows. Each ridge or furrow is formed by one filament; the filament forming the furrow is in some way, such as greater breadth, distinguished from the others. The two lamellæ of each leaf of the gill are united here and there by trabeculæ, which may or may not contain blood-vessels. They occur either between the opposite furrows or between the opposite ridges, *i.e.* between the ascending and descending portions of the filaments which lie either in the furrows or ridges. The upper edge of the ascending lamella of the outer leaf may unite with the mantle. The consecutive filaments of the same leaf are only connected by means of tufts of cilia.

(d) **Eulamellibranchia** (Figs. 89-91).—The branchial leaves are either smooth or folded, but there is always organic connection, by means of numerous vascularised junctions, not only between the ascending and descending lamellæ, but between the successive filaments. The junctions are therefore both interfoliar and interfilamentar. This leads to the entire disappearance of the original filamentous structure of each leaf, which now becomes an actual leaf or lamella with perforations or slits, the remains of the spaces between the original filaments, leading into an internal system of sinuses or canals, which in their turn are the remains of the spaces between the ascending and descending lamellæ. This peculiar arrangement was formerly considered typical of the Lamellibranchia, and was the origin of their name. It was supposed that the animals of this class had two leaf-like gills on each side of the mantle cavity, *i.e.* four altogether, but we now know how the two branchial leaves on each side arose, that they are in fact the two, modified, rows of leaflets of the original plumose gill of the *Protobranchia*. The Lamellibranchia in reality possess only one gill on each side in the mantle cavity.

The blood now no longer flows through the primitive filaments of the lamellæ of the gills and back again, but the afferent and efferent channels lie in the trabecular network between the two lamellæ of a branchial leaf.

Instead of the two leaves of a gill hanging down into the mantle cavity parallel to one another, the outer leaf may stand up dorsally in the cavity, so that the two come to lie in the same plane (*Tellinidae* and *Anatinacea*).

The ascending lamella of the outer leaf may be wanting (*Anatinacea*, *Lasca*), and in fact the entire outer leaf may be absent (*Lucina*, *Corbis*, *Montacuta*, *Cryptodon*).

In all Lamellibranchia, with the exception of the *Protobranchia*, and further, of the *Arcidae*, *Trigonidae*, and *Pectinidae*, the gill and mantle unite, the dorsal edge of the ascending (outer) lamella or, where this is wanting, the free edge of the single lamella of the outer leaf becoming fused with the mantle. In the same way, the dorsal edge of the ascending (inner) lamella of the inner leaf may become fused with the upper part of the foot (Fig. 88 C). If the two gills, which have fused with the foot,

fuse with each other behind the foot in the middle line of the mantle cavity, they form a septum which, uniting with the septum formed by the mantle between the inhalent and exhalent siphons, divides the cavity into an upper and a lower chamber. The water flows through the lower (inhalent) siphon into the large lower chamber, bathes the gills, and, streaming forward, conveys the particles of food it contains to the mouth. It then flows back along each side of the foot in the upper chamber of the mantle cavity (which is itself divided into two canals by the line of insertion of the

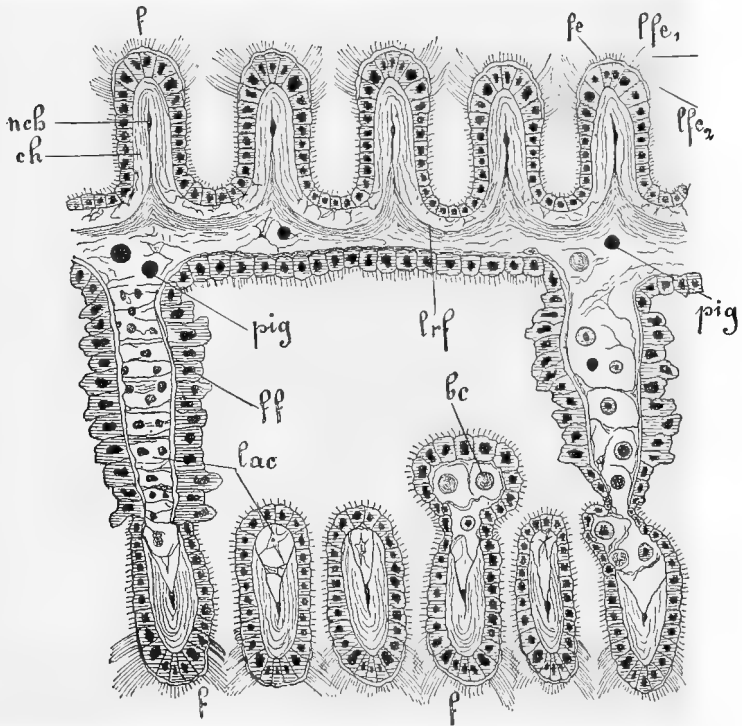

FIG. 89.—Part of a transverse section of the outer branchial leaf of *Dreissensia polymorpha* (after Peck). *f*, The separate filaments; *ff*, sub-epithelial fibres; *ch*, supporting substance of the filaments; *lac*, lacunar or alveolar tissue; *pig*, pigment cells; *bc*, blood corpuscles; *lfe*, epithelium of the free edge of the branchial filaments; *lfe*₁, *lfe*₂, two rows of lateral epithelial cells of the branchial filaments, carrying long cilia (ciliated tufts); *lrf*, tissue of the interfilamentar junctions. Two interfoliar junctions are shown in the figure.

gill) into the single posterior and upper chamber behind the foot, and escapes through the upper (exhalent) siphon (Fig. 26, p. 18).

(c) **Septibranchia** (Fig. 31 A and B, p. 21; and Fig. 88 D, p. 92).—These Mussels were formerly erroneously considered to be gill-less. As a matter of fact, the branchial septum just described has in them been much modified in structure, and has become a muscular septum, running across the mantle cavity in a horizontal direction and joining the siphonal septum posteriorly, while anteriorly it passes round the foot. This septum is broken through by various perforations and slits, which allow of communication between the upper and lower chambers of the mantle cavity, and vary in the different genera.

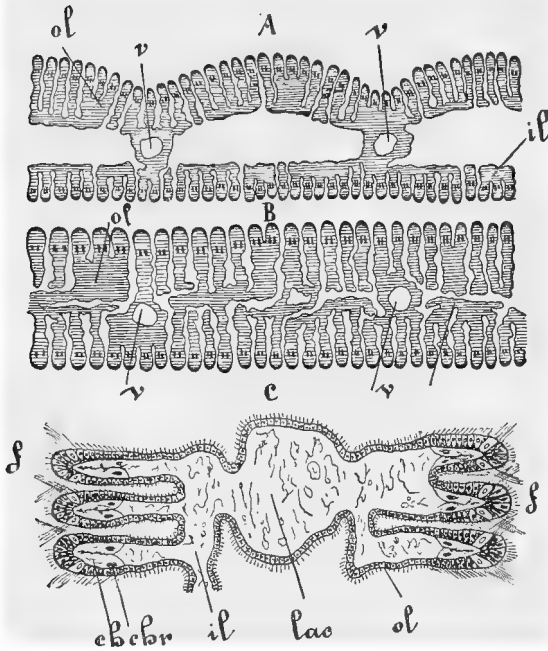

FIG. 90.—Portions of transverse sections of the branchial lamellæ of *Anodonta* (after Peck). **A**, Outer; **B**, inner lamella. In each leaf the cross sections of both lamellæ are seen, and also the interfoliar as well as the interfilamentar junctions. **C**, A part of **B** much magnified. *ol*, Outer; *il*, inner lamella of the same leaf; *v*, blood-vessels; *f*, the separate filaments of which the lamellæ consist; *lac*, lacunar tissue; *ch*, supporting tissue of the filaments, with firmer supporting rods, *chr*.

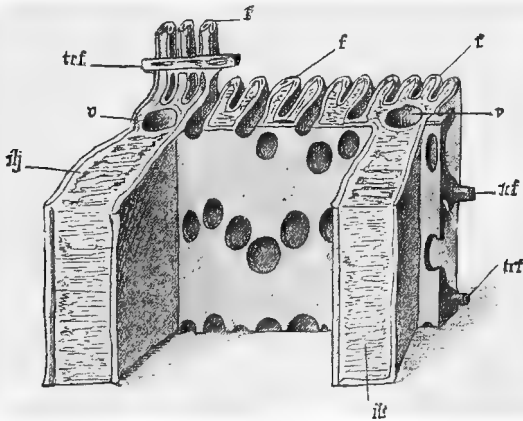

FIG. 91.—Portion of the ascending lamella of the outer branchial leaf of *Anodonta*, diagrammatic (after Peck). *f*, The separate filaments, connected by interfilamentar junctions; *trf*, connective tissue of the latter; *v*, blood-vessels; *ilj*, interlamellar junctions; the perforations in the lamella (of a darker shade) are the spaces remaining between the filaments and their junctions, through which the water needed for respiration can flow.

D. Cephalopoda.

The gills of the Cephalopoda are always feathered on both sides. Those of the *Dibranchia* have been the most thoroughly investigated. In *Sepia*, each gill has the shape of a slender cone, its whole length being applied to the visceral dome in the mantle cavity, in such a way that the base is directed dorsally towards the apex

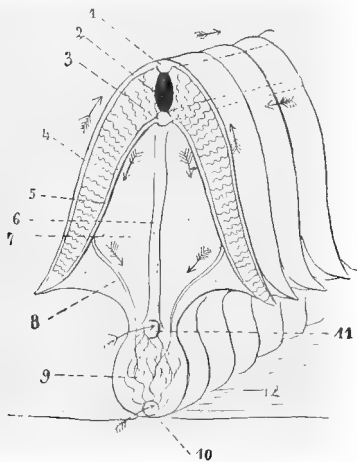

FIG. 92.—Diagram to illustrate the structure of the gill of *Sepia* (after Joubin). 1, Branchial vein (containing arterial blood); 2, branchial canal; 3, branchial artery (containing venous blood); 4, special branchial vein (vas efferens) of each leaflet; 5, special branchial artery (vas afferens) of each leaflet; 6, suspensor of the gill, which attaches the branchial artery (3) to the posterior integument of the visceral dome (12); 7, suspensor of each leaflet to the general suspensor (6); 8, one of the connecting vessels between the branchial artery and the "blood-making gland" (9), through which venous blood flows; 10, 11, vessels carrying the venous blood which has passed through the "blood-making" gland back to the venous sinus at the base of the gill. The arrows indicate the direction of the blood-stream.

of the visceral dome, and the point ventrally towards the free edge of the mantle fold or the mantle cleft (Fig. 80, p. 83). The points of the two gills diverge.

The two rows of flat triangular branchial leaflets (Fig. 92) are carried by the two branchial vessels, each leaflet being attached by one end of its base to the branchial artery and by the other to the branchial vein. In the axis of the gill between the two vessels, and also between the bases of the two rows of leaflets, a channel is formed which communicates by a slit between each successive pair of leaflets with the mantle cavity; through this canal the respiratory water freely flows. The slits in this axial channel are arranged alternately on each side, like the leaflets between whose bases they lie. The branchial vein forms the posterior support of the gill turned towards the mantle, and the branchial artery the anterior support turned towards the visceral dome. The artery is united along its entire length with the integument of the visceral dome by a membrane of connective tissue. The anterior edge of each leaflet (that facing the visceral dome) is connected with this membrane, which may be called the gill-suspensor, by means of another triangular membrane. A special vein runs along the posterior free edge of each leaflet, and enters the general branchial vein at its base; and a special artery runs along the anterior edge, *i.e.* along that edge of the leaflet which is fastened to the suspensor. Each leaflet is wrinkled in such a way that the folds on the two surfaces alternate, each fold being creased in its turn. These two systems of folds cross each other at right angles, and serve to increase the respiratory surface.

At the point where the suspensor of the gill passes into the integument of the visceral dome, it contains a cellular body, which is traversed by a system of intercellular blood-channels. This may perhaps be a blood-making gland. It receives venous blood from branches of the principal branchial artery and of the special arteries of the leaflets, and returns the same along two veins which run back to the base of the gill, there, with others, to open into the venous sinus of the renal organ; from this organ the blood passes for the second time along the branchial artery into the gill. We thus find that not all the venous blood which is conducted by the branchial artery towards the gills enters the leaflets for purposes of respiration; part

of it streams through the "blood-making" gland, and returns to the venous branchial heart still unpurified. There are, further, certain fine branchings of the branchial artery which serve for nourishing the gill and its suspending membranes. The blood in these returns to the venous sinus through a special vessel which runs parallel to the branchial artery on its anterior side.

A powerful nerve enters the gill at its base and ramifies through it. A muscle spreads over the surface of the "blood-making" gland, and a special musculature brings about the contractions of the principal branchial vein.

The gills of the *Octopoda* differ considerably, though not essentially, in structure from those of the *Decapoda*. The branchial channel is much larger, and the leaflets are not only folded, but have on each side alternating lamellæ, which in their turn may carry similar lamellæ of the second order, and so on till in some cases the seventh order of subsidiary lamellæ is reached. The leaflet is thus an extremely complicated, folded, or feathered structure with its surface increased to an extraordinary degree.

Adaptive Gills.

The *Scaphopoda* and many *Gastropoda* possess no true ctenidia. In the *Pulmonata* and the few air-breathing *Prosobranchia*, the ctenidia, as organs adapted for aquatic respiration, have disappeared. It is, however, at present difficult to determine the cause of their disappearance in *Opisthobranchia* which inhabit water, and in the gill-less forms of the *Pteropoda*, all the more so, as in most *Opisthobranchia* they are replaced by adaptive gills, which are new structures in no way comparable morphologically with ctenidia. These adaptive gills may even appear (*Pneumoderma*) before the true ctenidia have disappeared. The *Scaphopoda* and many *Opisthobranchia* have no gills whatever, and in these respiration evidently takes place at various suitable parts of the surface of the body. In many cases, also, where epipodial or parapodial processes are developed as well as gills, or the mantle possesses extensions, these may help the gills in the function of respiration.

Adaptive gills are found in most *Ascoglossa* and in the *Nudibranchia*; also, as mentioned above, in the *gymnosomatous Pteropoda*. In the latter, they consist of small fringed or plain ridges at the posterior end of the body; these may be of various shapes; a description of them would be of no special interest to the comparative anatomist.

The principal forms of adaptive gills of the *Nudibranchia* are: (1) the **anal gills** of the *Dorididæ*, (2) the **longitudinal rows of branchial leaflets** to the right and left under the mantle fold of the so-called *Phyllidiidæ*, (3) the **dorsal appendages** or **cerata** of the *Nudibranchia* and most *Ascoglossa*.

1. **The Anal Gills** (Fig. 93).—These take the form of delicate leaflets, generally feathered on both sides, which, in the *Dorididæ*, form a rosette round the anus, which has a median dorsal position towards the posterior half of the body. Cerata may occur with the anal gills (*Polyceridæ*). The view that these gills are ctenidia has as yet no sufficient foundation.

2. **The Longitudinal Rows of Branchial Leaflets** (Fig. 20, p. 13).—These organs, which lie to the right and left of the body in the *Phyllidiidae* and *Pleurophyllidiidae*, bear the same relation to the (lost) true etenidium as do the respiratory structures of the *Patellidae* above described to the same organ, which in them is sometimes present, sometimes wanting. The longitudinal rows consist of numerous small lamellæ which project from the lower side of the enveloping mantle fold into the shallow pallial cavity. There is either one long row of these lamellæ running along the whole length of the mantle fold and only interrupted anteriorly (*Phyllidia*), or a row interrupted posteriorly as well (*Pleurophyllidia*); or again, the rows of lamellæ are confined to the posterior end of the mantle fold (*Hypobranchiæ*). The genus *Dermatobranchius* has no gills.

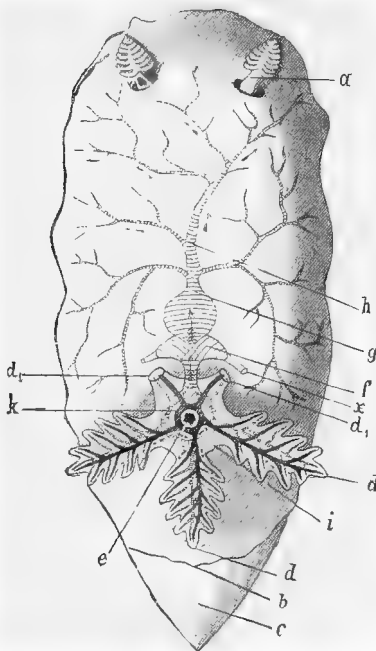

FIG. 193. — **Respiratory and circulatory system of *Doris***, after Leuckart ("Wandtafeln"). *a*, Rhinophore; *b*, posterior edge of the visceral dome; *c*, end of the foot; *d*, plumose gills; *d*₁, two gills cut off; *e*, anus; *f*, auricle; *g*, ventricle; *h*, aorta; *i*, circular vein around the anus, which receives the arterial blood from the gill, and sends it through the branchial vein into the auricle; *k*, circular artery, which receives the venous blood coming from the body; *x*, two vascular trunks, which conduct venous blood direct to the heart.

3. **Dorsal Appendages (Cerata)** (Fig. 18, p. 12).—These processes vary very much in form, being sometimes simple, and sometimes branched; they differ also greatly in number and arrangement. At their tips there are often cnidophore sacs; these are invaginations of the ectoderm in which stinging cells with stinging capsules are developed. Diverticula of the intestine (digestive gland) enter the cerata, and may open outward at their tips. The cerata are generally striking and beautiful both in colour and markings. In some cases they may serve for protection and concealment, in others, where the brilliant colouring is combined with stinging properties, they may serve as a warning. They often break off easily at the base (as a protective arrangement), and are always quickly regenerated. They no doubt assist, like the rest of the body surface, in respiration, especially where they are much branched and richly supplied with blood-vessels.

Certain *Opisthobranchia* are altogether gill-less, e.g. the *Elysiidae*, *Limapontidae*, and *Phyllirrhoidæ*.

Among the *Pulmonata*, the shell-less genus *Onchidium* has developed adaptive gills. The species of this genus are amphibious, living on the sea-coast, within reach of the tide. Their pulmonary cavity is very small; respiration therefore takes place by means of the richly vascularised dorsal integument, and especially of the simple or branched dorsal papillæ, in which there is a rich vascular network, which receives the blood from an afferent vessel and gives it off to an efferent vessel.

Lungs.

The total disappearance of the typical molluscan ctenidium is characteristic of the *Pulmonata*, and is connected with their terrestrial life and aerial respiration. Instead of water, air enters and escapes from the mantle cavity which lies either anteriorly or laterally on the visceral dome, and thus the mantle cavity becomes a **pulmonary cavity**.

The free edge of the mantle fold, which forms the roof of this cavity, unites with the nuchal integument beneath it, except at one point on the right, where the **respiratory aperture**, which can be closed at will, allows of the entrance and egress of air. Along the line of its concrescence with the integument, the edge of the mantle is much thickened, forming the mantle border, and is very rich in lime-secreting glands. The inner delicate surface of the mantle, which forms the roof of the cavity, is overspread by a close respiratory vascular network. A **circular vein** runs along the mantle collar. From it spring

numerous fine anastomosing vessels which ramify on the mantle. These vessels are again collected into larger trunks, which enter the large **pulmonary vein**. This vein runs upwards and backwards, along the right side of the pulmonary cavity, to the left of and almost parallel with the rectum, and enters the auricle. The circular vein contains venous blood, but the pulmonary vein conducts blood which has become arterial through respiration in the vascular network, to the heart.

Since, in most *Pulmonata*, as in the *Prosobranchia*, the respiratory organ and the pallial cavity in which it is found lie in front of the heart, this order is **prospneumonic**. An account of the **opisth-pneumonic** condition of certain *Pulmonata*, which results from the

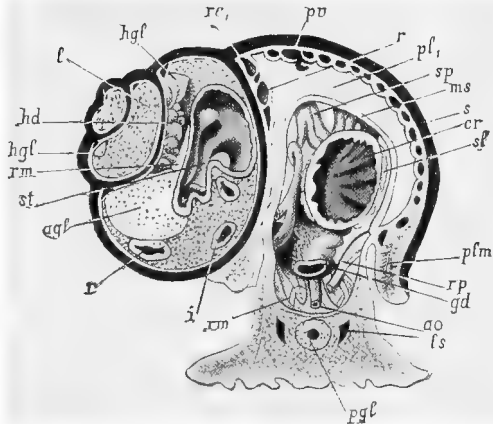

FIG. 94.—Slightly oblique transverse section through the body and shell of *Helix* taken just in front of the columella (after Howes). *pgl*, Pedal gland; *fs*, lateral pedal blood sinus; *ao*, cephalic aorta; *gd*, genital duct (uterus); *rp*, retractor muscle of penis; *plm*, pallial muscle, the pallial edge having united with the nuchal integument; *sl*, salivary gland; *cr*, crop, or widening of the oesophagus; *s*, shell; *ms*, floor of the pulmonary cavity = dorsal integument of the posterior nuchal region which is covered by the mantle; *sp*, spermatheca = stalk of the receptaculum seminis; *pl1*, pulmonary cavity; *pv*, afferent pulmonary vessels; *r1*, renal duct; *r*, rectum; *hg1*, hermaphrodite gland or ovotestis; *l*, digestive gland (liver); *hd*, hermaphrodite duct; *rm*, columellar muscle; *ag1*, albumen gland; *i*, intestine; *st*, stomach.

displacement of the visceral dome and mantle to the posterior end of the body, will be found in Section V., p. 76.

Certain *Pulmonata* (*Limnæidæ*) have become readapted to aquatic life, but their respiration is the same as that of the terrestrial forms, they rise periodically to the surface of the water to take in air. The respiratory cavity, is, however, filled with water when the animal is young, and it is then a water breather. In *Limnæa abyssicola*, a deep-water form found in the lake of Geneva, this form of aquatic

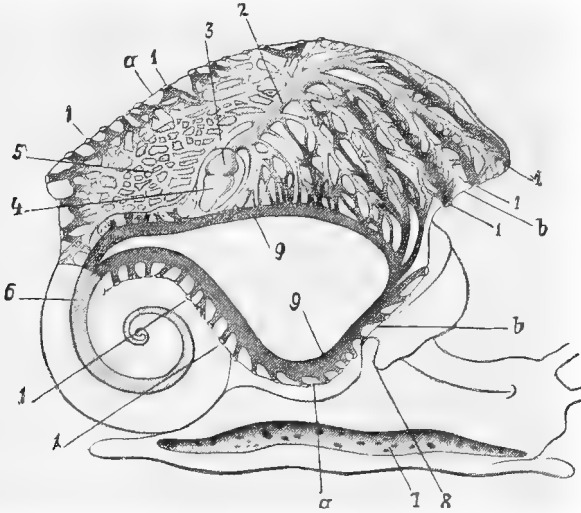

FIG. 95.—*Helix*. The roof of the pulmonary sac cut along the rectum, and along the edge uniting with the nuchal integument, and turned back to show the arrangement of the blood vascular system, after *Howes*. The pulmonary veins are of a lighter shade than the afferent pulmonary vessels and the venous sinuses; *aa*, *bb*, show the cut edges which belong to each other; 1, afferent pulmonary vessels which draw their venous blood from the large circular venous sinus (9); this latter receives its blood from the large sinuses of the body, two of which, that of the visceral dome (6) and that on the right side of the foot (7) are shown. The efferent pulmonary vessels collect the blood which has become arterial on the roof of the pulmonary chamber, and conduct it through the pulmonary vein (2) to the auricle (3); 4, ventricle; 5, renal circulatory system.

respiration continues throughout life, and the pulmonary chamber, in no way modified, is constantly filled with water.

In certain terrestrial *Prosobranchia* (*Cyclostoma*, *Cyclophorus*, etc.) the respiratory cavity becomes transformed, as in the *Pulmonata*, into a pulmonary chamber, and its roof is covered with a respiratory vascular network. But there is here no concrescence of the edge of the mantle with the nuchal integument. *Cyclostoma* still retains a rudiment of a prosobranchiate gill, but this is lost in *Cyclophorus*. The amphibian *Ampullariæ* possess both a gill and a pulmonary sac,¹ and can breathe either water or air.

¹ See note ante, p. 90.

VII. The Hypobranchial Gland.

(Slime gland of the *Prosobranchia*, epithelial shield of the *Pteropoda*, etc., anal gland, etc.)

This is an organ very commonly found on the molluscan mantle, always occurring near the ctenidium, at its base or between it and the rectum. Cf. on its position and occurrence Section V.

The hypobranchial gland varies considerably in shape, but is never a multicellular, acinose, or tubular gland with efferent ducts. It is originally a more or less extended area of the epithelium of the mantle cavity (generally of the inner surface of the mantle) in which epithelial glandular cells are particularly numerous. In this condition it is not very distinct from the parts around it, but it may become more definitely localised, and may assume a definite shape; and in this latter case, the glandular epithelium of which it consists may also become folded in order to obtain a larger secretory surface, the folds being more or less closely crowded together and projecting into the mantle cavity. This gland often secretes a large quantity of mucus. The **purple gland** of certain *Prosobranchia* (*Purpura*, *Murex*, *Mitra*) is a hypobranchial gland, the slimy secretion of which is, immediately after ejection, colourless or only slightly coloured, but under the influence of light becomes violet or red. In *Purpura*, the gland consists of two parts which differ slightly in structure.

VIII. The Head.

If by the word head is meant an anterior portion of the body more or less distinct from the rest, possessing a mouth and specific sensory organs, the *Lamellibranchia* must be considered headless, and as such have been distinguished as *Acephala* from other Mollusca. This absence of a head in the *Lamellibranchia* cannot be regarded as a primitive condition,¹ but is to be accounted for by their general habit of living in mud, and by the strong and peculiar development of the mantle and shell, which, by cutting off the anterior portion of the body (with the mouth) from direct contact with the outer world, renders specific sensory organs useless. In those Molluscs which have to seek, seize, and crush their food, a projecting head carrying sensory organs and furnished with buccal armature is of great use. Bivalves, however, feed on particles brought to the mouth by the water which by the motion of cilia is driven through the mantle cavity; buccal armatures are thus unnecessary.

In the *Cephalopoda*, the head is strengthened by the incorporation with it of the foot, here transformed into a circle of arm-like prolonga-

¹ Hence the term "Lipocephala," suggested by Lankester.

tions for seizing the prey. We thus have a combined head and foot (Kopffuss), on each side of which, anteriorly, lies a large highly-developed eye. This head is more or less separated from the rest of the body (the visceral dome) by a neck.

The *Gastropoda*, with very few exceptions, possess a head which on its anterior lower side is provided with an oral aperture, on its upper side with eyes and tentacles, and often asymmetrically (generally on the right side) with a genital aperture or a copulatory organ. This head is distinctly separated ventrally by means of a groove or furrow from the foot behind it; dorsally it passes gradually into the neck. Further details of this Gastropod head are given below.

A. Gastropoda.

1. Prosobranchia.

The head in this order always carries tentacles, which are solid, simply contractile (not invaginable) processes of the cephalic wall. It may be assumed that there were originally two pairs of tentacles, an anterior and a posterior pair. The posterior are called ommatophores and carry eyes at their tips. Most *Diotocardia* possess anterior tactile tentacles, and posterior and slightly lateral optic tentacles.

The cephalic tentacles are always innervated from the cerebral ganglion, and are thus distinguishable from the tentacular processes which may occur near them on the head or neck, but belong to the epipodium, and are innervated from the pedal or pleural ganglia.

In the *Docoglossa* and most *Monotocardia* the optic tentacles do not rise separately from the head, but are to a greater or lesser extent fused with the tactile tentacles. Starting with the tentacular arrangements existing in *Dolium*, *Strombus*, *Rostellaria*,

we find the tactile and optic tentacles fused for a certain distance from the base, but separating later, the tips projecting independently (Fig. 96, B).

If the two tentacles were of the same length, and were fused for their whole extent, there would only be one tentacle on each side of the head, which would carry the eye at its tip (*Terebra C*). But if the optic tentacle is shorter

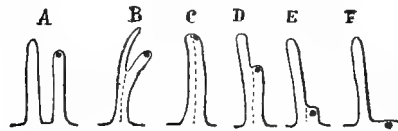

FIG. 96.—Relations of the tactile and optic tentacles in the Prosobranchia. Description in the text.

than the tactile, the eye might be met with at any point between the base and tip of the latter, on a projection which answers to the tip of the fused optic tentacle (D and E). Finally, the eye may be altogether sessile, *i.e.* it may lie near the base of the sensory tentacle in the integument of the head (F).

The snout, which carries the mouth and is anterior to the tentacles, is very variously developed in the Prosobranchia.

1. It is short and truncated in the *Diotocardia*, and especially in the herbivorous *Tanioglossa*.

2. It is prolonged like a proboscis (rostrum), but is only contractile, not invaginable (*Capulidae*, *Strombidae*, *Ctenopidae*, *Calyptreidae*), or else can be invaginated, commencing at the tip (*Cypræidae*, *Lamellaridae*, *Naticidae*, *Scularidae*, *Solaridae*).

3. It is transformed into a long proboscis with the mouth at its anterior end. This proboscis can be invaginated in such a way that the invaginated base forms a proboscidal sheath for the non-invaginated anterior portion or tip. Gastropods

with such proboscides are nearly all carnivorous (the *Tritonida*, *Doliida*, and *Cassidida*, among the *Stenoglossa* the *Rachiglossa*, and a number of *Toxiglossa*).

Most male *Monotocardia* have a non-invaginable penis, which varies in shape, on the right (rarely on the left) side of the head or neck, near the tentacle; this organ in most cases belongs morphologically to the foot, being innervated from the pedal ganglion; less frequently it is a cephalic appendage, and is then innervated from the cerebral ganglion (Fig. 71, p. 73).

The head of the *Heteropoda* carries two tentacles (occasionally rudimentary: *Pterotrachea*, *Firoloidea*). The eyes are sessile or placed on small prominences near the bases of the tentacles on their outer posterior sides. That part of the head which lies in front of the tentacles is prolonged to form a large proboscis-like non-invaginable snout.

2. Opisthobranchia.

The shape of the head in this order varies to an extraordinary degree, and can here be only generally described. It usually carries two pairs of tentacles; the posterior pair, which are called **rhinophores**, are perhaps olfactory. Their surface is often increased by the formation of circular folds. They frequently rise from the base of pits into which they can be withdrawn. The head is rarely prolonged into a proboscoidal snout. The eyes are sessile.

Among the **Tectibranchia**, the *Cephalaspidae* are distinguished by peculiarities of the head. It carries dorsally a flat fleshy disc, the **cephalic** or **tentacular disc** (Fig. 14, p. 10), which is regarded as the result of the fusion of the tentacles, and which, by its shape, recalls the propodium of the *Naticidae* or *Olividae* among the *Prosobranchia*. This cephalic disc carries the sessile eyes on its dorsal side, and its posterior lobe, which is sometimes produced in the shape of two lateral tentacular processes, shifts about over the anterior portion of the shell. The shape of this disc varies considerably in details.

Of the very numerous **Nudibranchia** we shall only notice two extreme forms: *Tethys* and *Phyllirrhoë*.

In *Tethys*, the head takes the form of a large flat disc, almost semicircular in shape and fringed at the edge; this carries on its upper surface two conical rhinophores, which can be retracted into large sheaths.

In *Phyllirrhoë* (Fig. 19, p. 12), the head is produced into a short proboscoidal snout, which carries only two very long curved tentacles; the bases of these are encircled by integumental folds, and they may be considered as rhinophores.

Pteropoda gymnosomata.—The head is distinct, and carries two pairs of tentacles, one labial and the other nuchal. The former answers to the anterior, and the latter to the posterior tentacles or rhinophores of the *Tectibranchia*, especially those of the *Aplysidae*. The nuchal tentacles are generally small or rudimentary, the rudiments of the eyes lying at their bases.

Nearly all the *Gymnosomata*, as highly-developed carnivorous animals, are provided with a proboscoidal snout which, commencing at its tip, can be completely invaginated, and carries at its base, when evaginated, buccal appendages innervated from the cerebral ganglion.

Definite compensatory relations exist between the proboscoidal snout and the buccal appendages:—

1. When the proboscis is specially long, the buccal appendages are wanting (*Clionopsis*).
2. When the proboscis is of median length, it carries suckers at its base, or a pair of long appendages provided with suckers (*Pneumodermitæ*, Fig. 76, p. 79).
3. When the proboscis is short, there are long anterior tentacles, and at the base

of the evaginated proboscis three pairs of conical processes (cephalic cones), with special nerve endings and glands whose sticky secretion helps in the capture of prey (*Clionidæ*).

4. The proboscis may be wanting. There is then on each side of the mouth a long extensible buccal appendage carrying at its base the labial tentacle.

Pteropoda thecosomata.—The head is, as a rule, not sharply separated from the body, and has no invaginable snout, but one pair of tentacles which answer to rhinophores, and sometimes lie in sheaths at their bases. The left tentacle may become rudimentary. In the Thecosomata the male copulatory organ lies on the upper side of the head, near the tentacle.

3. Pulmonata.

The head is here distinct from the foot ventrally, but passes dorsally into the neck. It carries two or four tentacles. The *Stylommatophora*, which are terrestrial, have four tentacles (Fig. 97), an anterior and a posterior pair. The posterior, which are usually the longer, carry the eyes on their tips. The tentacles are hollow tubes filled with blood and connected with the blood spaces of the head. They can be invaginated from the very tip into the head, special muscles acting as retractors which, when the tentacle is evaginated, run from the head to the tip of the tentacular cavity.

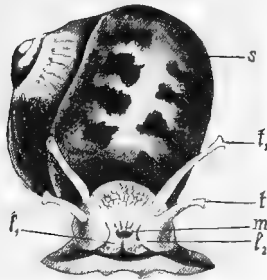

FIG. 97. *Helix*, front view, creeping with extended tentacles (after Howes). *s*, Shell; *t*₁, optic tentacle; *t*₂, anterior tentacle; *m*, mouth; *l*₁, *l*₂, lips.

The *Basommatophora*, which are aquatic, have only one pair of tentacles which are usually triangular and flat. They are solid, and not invaginable, but merely contractile. The eyes lie on the inner side of their bases.

In certain *Pulmonata* (*Glandina*, *Zonites*, *Oncidium*) the upper lip may be drawn out into a lobe or labial palp on each side. This **labial palp** in *Glandina* can move very freely, and is the seat of a fine sense of touch.

On the right, behind the right tentacle, lies the common genital aperture, or, in cases where the male and female apertures are distinct, the male aperture.

B. Scaphopoda (Fig. 101, p. 113).

In this order the non-invaginable snout is ovoid or barrel-shaped, and projects from the body, over and in front of the foot, downwards into the mantle cavity. At its extremity lies the mouth, surrounded by a circle of dentate oral lobes shaped like oak-leaves,—four on each side.

At the boundary between the bases of the foot and of the snout, to the right and left of the cerebral ganglion, a shield-shaped lobe rises from the body on each side; this is attached, at the centre of its inner side, by a short slender stalk to the body wall, concrescence also taking place at its lower edge. This shield carries numerous filamentous or vermiform glandular tentacles, which move very freely and can be protruded far beyond the mantle aperture.

The ends of the tentacles are swollen into the shape of a spoon, and can become attached to foreign objects like suckers. Each swelling has long ciliary hairs on

its concave surface, the cilia being continued in a band all along the tentacle to its base. Tentacles of this sort are found in all stages of development; they rise chiefly from the inner surface of the shield, and easily become detached or broken off, and are then regenerated. They are no doubt chiefly useful as organs of touch, and serve for seizing particles of food (Foraminifera, etc.). They may further assist respiration in the absence of localised gills, by causing increase of surface. The tentacles are innervated from the cerebral ganglion through the stalk of the shield on which they stand.

C. Cephalopoda.

In *Nautilus*, there are on each side one tentacle above and one below the eye. It is not improbable that these two tentacles correspond with the two pairs of tentacles in the *Gastropoda*.

IX. The Oral Lobes of the Lamellibranchia.

The oral aperture of the Lamellibranchia is produced right and left in the form of a groove, which runs backward along the surface of the body to the anterior end of the base of the gill, or to some point near it. This groove is bordered by two projecting ridges above and below it. The two upper ridges, at the point where they meet, form a sort of upper lip over the mouth, the lower ridges, in the same way, forming a lower lip. The groove between the ridges serves for conducting to the mouth the particles of food which are swept past the gills by the cilia.

The length of the groove is naturally determined by the distance between the anterior ends of the gills and the mouth.

The two ridges just described are continued posteriorly in the shape of thin lamellæ, which hang down into the mantle cavity. These lamellæ, between which the groove becomes a deep, narrow cleft, are the oral lobes or labial palps of the Lamellibranchia. They are more or less triangular, one side of the triangle forming the base by which the lobe is attached to the body.

In cases in which the gills lie far behind the oral aperture, the bases of these lobes are long, but in others, where they begin near the mouth, the bases are short, and each lobe then usually forms a long, free, pointed process. The surfaces of these two oral lobes are ciliated, and, further, the surfaces which face each other, *i.e.* which have the groove between them, are striated at right angles to their bases. This striation is caused by parallel ridges, and gives the lobes a superficial resemblance to gills. The lobes contain blood lacunæ, and it is probable that, besides their chief function of conducting food to the mouth, they may assist in respiration.

In certain forms, the free edge of the upper lip folds over that of the lower (*Ostrea*, *Tridacna*); in others, the two edges are closely apposed and interlocked by means of processes and folds (*Pecten*, *Spondylus*), so that a closed cavity rises in front of the mouth, into which the groove brings particles of food from each side. The edges of the upper and lower labial palps may even grow together (*Lima*).

Nucula (Fig. 21, p. 14), in which the ctenidium lies far back, and has a very small respiratory surface, may serve as an example of very highly developed oral lobes,

which were formerly considered to be gills. The base of the lobe here stretches along the whole length of the base of the foot, and is further prolonged posteriorly in the shape of a free appendage with a groove running along it. This process can be protruded beyond the shell, and probably assists in conducting food to the mouth.

X. The Foot and the Pedal Glands.

The ventral side of the body in the Mollusca is characterised by the pronounced development of its musculature, which enables the animal to creep, a fleshy foot, provided with a flat sole suited for creeping, distinct from the rest of the body and especially from the head, being developed. This strong ventral musculature must be considered as the remains of the dermo-muscular tube of the racial form, which attained greater development on the ventral side in adaptation to a creeping manner of life, while it degenerated on the dorsal side, being rendered functionless and useless by the hard shell.

The flat form of the foot with a sole for creeping must be considered the primitive form. Such a foot is found in the *Chitonida* among the *Amphineura*, in most *Gastropoda*, and in certain *Lamellibranchia*, especially in the *Protobranchia*, which for other reasons also must be considered the most primitive form of *Lamellibranchia*.

The musculature of the foot and of all parts which become differentiated from it are innervated from the pedal ganglia or pedal nerve cords.

The foot may become much modified in adaptation to various methods of life and of locomotion,—in fact, it may entirely lose all resemblance to the primitive organ. It may, by constriction or by the formation of lobes or folds, fall into several parts, of which the following are the most important :—

1. Proceeding from before backward we have the **propodium**, an anterior portion distinct from the rest, and the **metapodium** behind the former and seldom very distinct, which carries the operculum when this is present.

2. From below upward there are the **parapodia**, lobe-like extensions of the edge of the ventral sole, and the **epipodium**, a projecting ridge or fold round the base, *i.e.* round the upper portion of the foot. Tentacular processes are often developed on this ridge.

Taking the different groups in order, the following variations of the foot and the pedal glands (mucous glands and byssus gland) are to be noted.

A. *Amphineura*.

(*Cf.* Section II., p. 29). The foot is here not divided into separate consecutive portions, and there are no parapodia or epipodia.

B. Gastropoda.

1. Prosobranchia.

With rare exceptions, which will be described later, the foot, which is well developed in this order, has a simple (undivided) flat sole for creeping.

Propodium.—In a few cases, however, the anterior portion of the foot forms a propodium well marked off from the rest of the organ. This is especially the case in the *Monotocardia* (*Olividae*, *Harpidae*, certain species of *Pyruvidae*, *Strombidae*, *Strombus*, *Pterocera*, *Terebellum*, *Rostellaria* [Fig. 6, p. 6], *Xenophoridae* [Fig. 5, p. 5], *Naricidae*, *Naticidae* [Fig. 98]).

Among the above, the propodium is particularly well developed in *Oliva*, separated from the rest of the foot by a transverse furrow and forming a semicircular disc.

In the large foot of *Natica* (Fig. 98), the propodium is also very distinct. It has an anterior lobe which bends back over the shell, and so covers the head.

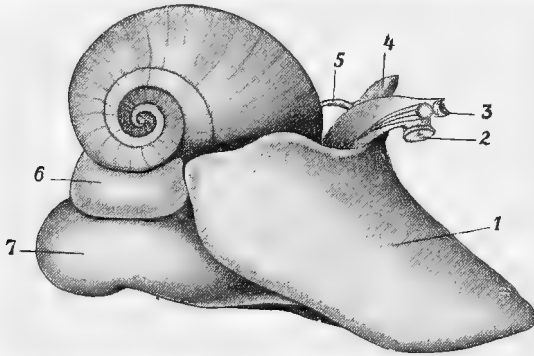

FIG. 98.—*Natica Josephina*, with protruded proboscis, from the right side (after Schiemenz). 1, Propodium; 2, sucker-like boring appendage of the proboscis (3) with boring gland; 4, siphon (here formed by the foot); 5, tentacle; 6, lobe of the metapodium, which usually covers a large part of the shell from behind, and carries the operculum on its inner side; 7, metapodium.

Sometimes the propodium forms a sort of siphon on the left side, and in other cases the lobe which bends back over the shell shows a bulging. Both these arrangements serve to conduct water to the respiratory cavity. The metapodium also, which, when swollen and expanded, spreads out widely, carries on its dorsal side a lobe which bends forward over the shell, and carries the operculum on the side nearest the shell.

In most Prosobranchia the metapodium carries, on its dorsal side, a horny or calcareous operculum which serves to close the shell.

Epipodium.—The epipodium is very commonly present in the *Diotocardia*. It is most strongly developed in *Haliotis* (Fig. 105, p. 121), where it surrounds the base of the foot in the form of a large integumental fold. This fold, which may aptly be called the ruff, has fringed or digitate appendages as well as long contractile tentacular processes. The tentacles here, as in other Prosobranchia, are organs of touch, and may be provided at their bases with so-called lateral organs. In the *Fissurellidae* this epipodial ruff is replaced by a row of numerous tentacles or papillæ, rising on each side from the base of the groove between the base of the foot and the visceral dome. Among the other *Diotocardia* also, the epipodium is well

developed as a simple or fringed border, which carries a few tentacles (usually four on each side) of varying length (Fig. 3, p. 4). At the base of each tentacle there is a lateral organ. Eyes are said to occur at the bases of the epipodial tentacles in *Eumurgcrita* and *Scissurella*.

The epipodium is, as a rule, wanting in *Docoglossa*, but one is found beset with papillæ in the genus *Helcion*, and in *Patinella* and *Nucella* it is fringed; these epipodia correspond in position with those of other *Diotocardia*.

A well-developed epipodium rarely occurs among the *Monotocardia*, but *Ianthina* has a typical epipodial border, and the *Litiopida* and many *Rissoideæ* have an epipodium with several (1-5) tentacles on each side. Many other *Monotocardia* have retained either the anterior or posterior portions of the epipodium.

(a) Anterior vestiges of the epipodium are found in *Formetus* in two anterior pedal tentacles, and in *Paludina* and *Ampullaria* in two nuchal lobes, which must not be confounded with true cephalic tentacles. In *Paludina*, the right nuchal lobe, and in *Ampullaria* the left, forming a longitudinal groove, becomes a sort of siphon. *Calyptrea* possesses on each side under the neck a semicircular epipodial fold.

(b) Posterior vestiges of the epipodium are found in *Lacuna* in the form of an epipodial fold with a process on each side above the foot. *Narica* has, above the metapodium on each side, a wing-like epipodial lobe.

(c) Median and posterior vestiges of the epipodium are found in *Choristes*, where there is a median papilla on each side, and posteriorly a pair of tentacles below the operculum.

The epipodium is always innervated from the pedal nerve cords or the homologous pedal ganglia, or from the pleural ganglia which separate off from the latter.

The foot of *Hipponyx* undergoes a curious transformation. *Hipponyx* is a *Monotocardian* genus, with a conical shell; the animal attaches itself firmly to rocks or the shells of other Molluscs, which it excavates, either directly or by means of a shell plate, which probably answers to the operculum. The median part of the sole of the foot has lost its muscle layer, and its edge has united with the edge of the mantle, leaving only an anterior aperture through which the head can be protruded. On the lower side of the foot, the columellar muscle which descends from the shell gives rise to a horseshoe-shaped muscular area surrounding the central non-muscular part.

Without going into details as to the method of locomotion of the *Prosobranchia*, it may be stated that most of them creep or attach themselves by means of the flat sole of the foot.

Heteropoda.—The *Heteropoda* are pelagic *Prosobranchia* (*Monotocardia*), which have exchanged the creeping for the swimming manner of life. The foot has in them become peculiarly adapted to this new method of locomotion. The propodium has become changed into a narrow vertical rowing fin (carinate foot), which when the animal is in its swimming position is turned upward.

The development of this vertical fin can be traced almost step by step within this division, starting with *Oxygyrus*, and proceeding through *Atlanta* and *Carinariæ* to *Pterotrachea*. In this series, the typical outer appearance of the *Prosobranchiate* (its shell, visceral dome, mantle, and gills, which are still retained in *Oxygyrus* and *Atlanta*), gradually disappears owing to development in another direction.

Oxygyrus (Fig. 99, A) still has the characteristics of a *Prosobranchiate*. The foot consists of (1) a propodium, the creeping sole of which has been somewhat hollowed out or deepened; anteriorly it possesses a fin-like outgrowth, which is used as a propelling organ in swimming; and (2) a distinct metapodium directed backwards like a tail, and bearing an operculum. The derivation of such a foot from that of certain *Prosobranchia*, which have distinct propodia and metapodia, such as the

saltatory *Strombidae*, is clear. The sole of the foot in *Oxygyrus*, although it can be used for creeping, is looked upon as a sucker.

In *Atlanta* (B), the arrangements of the foot are similar to those in *Oxygyrus*, but the fin-like outgrowth of the propodium has become its most important part, the comparatively reduced sole or sucker appearing merely as an appendage to it.

In *Carinaria* (C) both the foot and the general external appearance of the whole

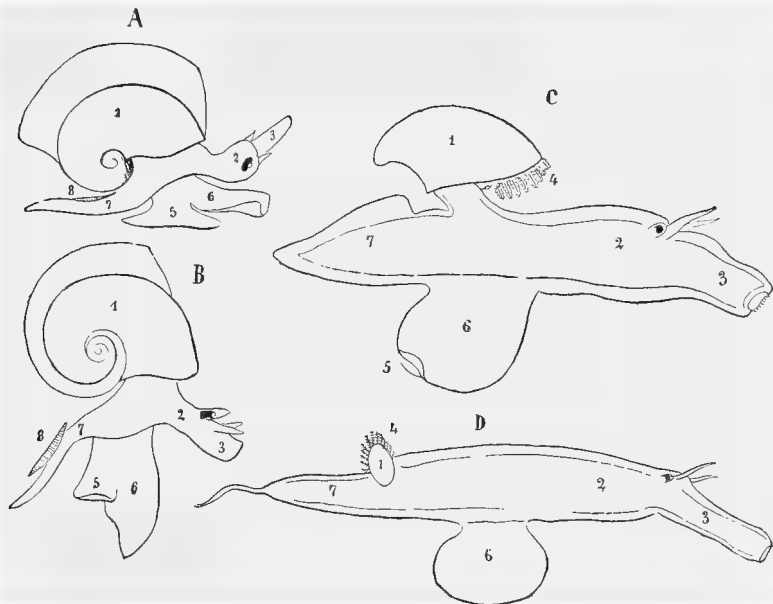

FIG. 99.—Comparative Morphology of the Heteropoda. A, *Oxygyrus*. B, *Atlanta*. C, *Carinaria*. D, *Pterotrachea* ♀, adapted from figures by Souleyet. 1, Visceral dome and shell; 2, head with eyes and tentacles and proboscis (3); 4, gills; 5, foot with sole, which latter in B and C is reduced to a sucker, and in D is wanting; 6, fin-like appendage of the foot; 7, metapodium with, 8, operculum.

animal are much changed. The metapodium, which here has no operculum, appears as a mere tail-like posterior prolongation of the body. The fin is much broader and longer, and the sucker seems to have shifted backward along its free edge.

Finally, in the *Pterotrachea* (D), the sucker (the original sole of the foot) is still further reduced, and only present in the male.

The Heteropoda are said to attach themselves occasionally by means of the sucker.

2. Pulmonata.

The foot is here almost always undivided, and provided with a large flat sole for creeping. In a few *Auriculidae*, however (*Melampus*, *Leuconia*, *Blauteria*, *Pedipes*), it is divided into two portions by a temporary or permanent transverse groove.

3. Opisthobranchia.

In almost all Opisthobranchia the foot has a well-developed sole for creep-

ing. There is no division into parts, and the adult rarely (*Actæon*) carries an operculum.

The epipodium is wanting.

The **parapodia**, on the contrary, *i.e.* lateral lobes or fold-like extensions of the edges of the sole, are highly developed in many Opisthobranchia (*e.g.* the *Elysiidae* among the *Ascoglossa*, and very many *Tectibranchia*, such as the *Scaphandridæ*, *Bullidæ*, *Aplys- tridæ*, *Gastropteridæ* (Fig. 14, p. 10), *Philinidæ*, *Doridiidæ*, *Aplysiidæ* (Fig. 75, p. 78), *Orynoceidæ*). The parapodia are often bent back over the shell, their edges sometimes touching, so that the shell may be entirely roofed over by them. In many forms which are provided with parapodia (*Gastropteridæ*, *Philinidæ*, *Doridiidæ*, *Aplysiidæ*) the mantle also bends back over the shell, more or less completely covering it. In these cases the shell is to some extent doubly internal, being covered first by the mantle and then (not in *Philinæ* and *Doridium*) by the parapodia (Fig. 100).

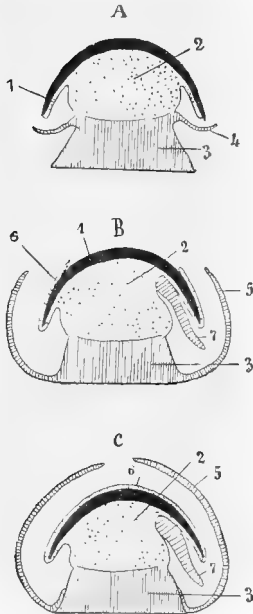

FIG. 100.—Diagrammatic transverse sections of Gastropods, to illustrate the arrangement of the shell (black, 1), visceral dome and mantle (dotted, 2), and foot (streaked, 3). A, *Prosobranchiate* with outer shell and epipodium (4). B, *Tectibranchiate* with lobes (6) of the mantle turned back over the outer surface of the shell. Dorsally the shell is still uncovered; 5, parapodia; 7, ctenidium. C, *Tectibranchiate* with internal shell, *i.e.* completely overgrown by the lobes of the mantle.

The parapodia may fuse posteriorly along their upturned edges (*Aplysiidæ*, *Orynoë*). In *Lobiger* each parapodium is transversely slit, so that two long wing-like processes are formed on each side. Many Opisthobranchia (*Aplysiidæ*, *Orynoë*, *Gastropteridæ*) can propel themselves through the water by means of the waving motion of their parapodia. *Phyllirhoë* is a *Nudibranch* which appears to have become adapted to a pelagic swimming manner of life by the compression of its body into the shape of a long narrow leaf with sharp dorsal and ventral edges; it travels through the water with an undulating motion (Fig. 19, p. 12). The foot has disappeared.

Pteropoda.—The Pteropoda, which are Tectibranchiate Opisthobranchs, have, like the *Prosobranchiate Heteropoda*, become pelagic animals adapted for swimming.

While in the *Heteropoda* the propodium becomes transformed into a medio-ventral vertical rowing fin, in the Pteropoda the paired Tectibranchiate parapodia which, as we have already seen, can be used for swimming, develop into the paired fins or wings of these animals (Figs. 16 and 17, p. 11; 87, p. 91).

In the *Thecosomata* (Fig. 87, p. 91), which must be derived from *Cephalaspidae* (*Bulloidea*), in which the parapodia lie on each side as direct prolongations of the reptant surface of the foot, this organ, *i.e.* the foot, has become confined to the anterior end of the body, and consists of three portions—the median unpaired mesopodium and the two lateral parapodia or fins. The mesopodium is small, and the ventral side of it (which corresponds with the sole of the *Cephalaspidae*, but can no longer be used for creeping) is strongly ciliated. The ciliary movement is from behind forward, *i.e.* towards the oral aperture which lies anteriorly on the foot, and no doubt serves for conveying to it the minute marine animals on which the creature feeds. On the dorsal side of the mesopodium, which projects freely backwards, the *Limaciniidæ* carry a delicate transparent operculum, which often becomes

detached.¹ The parapodia are large, fin- or wing-like, and anteriorly inserted on each side of the median portion of the foot; they unite in front of and above the mouth.

The *Gymnosomata* (Fig. 16, p. 11) are to be derived from the *Aplysiidae*, in which the parapodia are not exactly lateral extensions of the sole of the foot, but arise somewhat above the edge of the sole on each side. This may be explained by supposing that they are fused for a certain distance from their bases with the lateral wall of the body. In the *Gymnosomata*, also, the foot is distinctly separated from the two lateral fins or parapodia. The mesopodium and the fins lie anteriorly on the ventral side of the body, behind the head.

The foot itself, which is distinct from the head, consists of three parts—a pair of anterior lobes, which converge anteriorly till they unite, and a median posterior lobe drawn out to a point posteriorly. The fins never unite in front of or above the head.

Pedal glands of the Gastropoda.—Many Gastropods, and especially most *Prosobranchia* and *Pulmonata*, possess, besides the various unicellular glands scattered over the upper and lower sides of the foot, larger multicellular localised pedal glands. These belong to two morphologically distinct groups.

1. In the *Prosobranchia* an **anterior pedal gland** opens at the anterior edge of the foot. In those forms in which this anterior edge is divided into an upper and a lower lip, this “labial gland” opens between the lips. In the *Pulmonata* it opens externally between the head and the foot. It consists of an epithelial tube of varying length, not infrequently as long as the foot itself; this tube runs backward in the median line mostly through the base of the foot; less frequently it lies upon this base, projecting into the body cavity.

This tube serves both as reservoir and duct for the numerous unicellular mucous glands which lie in the surrounding tissue of the foot and open on its walls. It secretes mucus, though it has been incorrectly described as an olfactory organ. It undergoes considerable modifications with regard to its size, the form of its lumen, and the number and arrangement of its glandular cells.

2. Among the *Prosobranchia*, opening on the sole of the foot, there is commonly found an unpaired gland. Its outer slit-like aperture is median, and lies behind the anterior edge of the foot. It leads into a cavity in the foot which serves as a reservoir; the epithelial wall of this cavity projects in the form of folds into its lumen. As in the former case, unicellular glands pour their secretions into it through ducts which pass between the epithelial cells. This **sole gland** in the *Prosobranchia* has rightly been considered homologous with the byssus gland of the *Lamellibranchia*. It is developed in varying degrees, and not infrequently is altogether wanting. Its slimy secretion forms threads by means of which many *Prosobranchia* attach themselves to objects in the water. Some terrestrial *Pulmonata* also lower themselves from a height (from plants) by means of the tough threads which they secrete.

¹ With regard to the derivation of the *Thecosomata* from the *Cephalaspidae*, which, like other *Opisthobranchia*, have as a rule no operculum, it must be noted that *Acteon*, which is in many respects a primitive *Cephalaspid* genus, possesses an operculum.

Besides these two, other pedal glands are occasionally found. Only one need be mentioned, which is found in some *Opisthobranchia* (*Pleurobranchus*, *Pleurobranchæa*, *Pleurophyllidia*). It lies at the posterior end of the sole, and consists of glandular cæca, each of which opens separately.

C. Scaphopoda.

The foot of *Dentalium* (Fig. 101) is almost cylindrical; it projects downwards into the tubular mantle cavity, and can be protruded through its lower aperture. The free end of the foot is conical; the base of the cone carries on each side a fold or ridge which has been compared, with questionable propriety, to an epipodium. These two lateral folds or ridges encircle the base of the conical end without uniting either anteriorly or posteriorly. A groove runs along the anterior middle line of the foot.

In *Siphonodentalium* both this groove and the lateral lobes are wanting, and the anterior end of the foot is broadened into a round disc carrying on its edge small conical papillæ.

D. Lamellibranchia.

The foot in this class is, as a rule, laterally compressed, and has a sharp edge directed downwards and forwards, which can be stretched out beyond the shell. It may be called hatchet-shaped (*Pelecypoda*) or linguiform, and is especially suited for forcing its way into mud by means of alternate contraction and expansion.

This peculiar shape must be considered as acquired. Originally the foot of the Lamellibranchia also possessed a flat sole for creeping. The *Protobranchia*, in fact, have a foot with a ventral disc (Fig. 21, p. 14), and so has *Pectunculus*. The edge of this pedal disc is notched or toothed. When the foot is retracted, this disc folds down the middle line.

The foot in the Lamellibranchia varies much in details, according to the manner of life or of locomotion of the animal, and according to the development of the byssus. One of the special characteristics of the Lamellibranchiate foot is the gland which secretes the byssus, the latter being a bundle of tough threads varying in thickness, and resembling horn in their physical properties. The Lamellibranch, with these threads, anchors itself to foreign objects. The byssus can generally be thrown off and replaced by a new one, and many forms can move about on a smooth perpendicular pane of glass by means of alternate attachment and rejection of portions of the byssus applied by means of the foot.

Stationary bivalves, *i.e.* those attached by one of the shell valves, are in the first instance attached by means of the byssus, for a byssus is, as a rule, present in the young stages of those bivalves which do not possess it as adults.

FIG. 101.—Anatomy of *Dentalium entale*, after Leuckart (Wandtafeln) and Lacaze-Duthiers. The right half of the shell and the lower portion of the mantle are removed. *a*, Pallial nerve running up from the visceral ganglion; *b*, shell; *c*, space between the mantle and shell; *d*, anus; *e*, visceral ganglion; *f*, mantle cavity; *g*, mantle; *h*, lower, *i*, upper buccal ganglion; *i*, auditory organ; *k*, pedal ganglion, *m*, lateral folds of the foot; *n*, terminal pedal cone; *o*, filamentous tentacles; *l*, lower edge of the mantle; *p*, leaf-like oral appendages; *q*, snout; *r*, cerebral ganglion; *s*, shell or columellar muscle, cut through; *u*, right nephridial (and genital) aperture; *v*, digestive gland (liver); *w*, gonad; *x*, upper end of the columellar muscle; *y*, upper open end of the mantle.

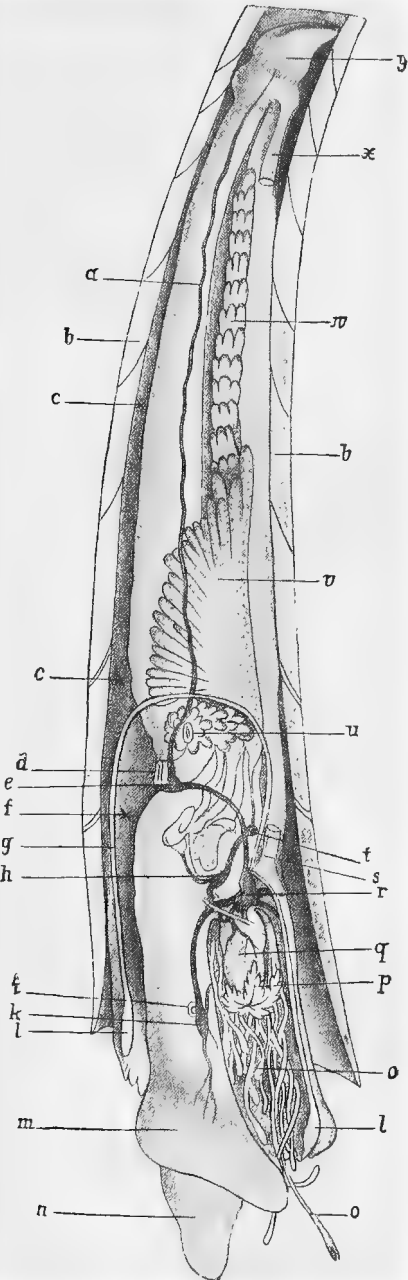

The complete byssus apparatus (Fig. 102) consists of: (1) a cavity in the foot, into which the byssus gland opens; (2) a duct connecting this cavity with the exterior; (3) a groove which runs from the aperture of the duct along the ventral edge of the foot to its anterior end; and (4) a crescent-shaped or cup-like widening of the groove at its anterior end.

(1) The byssus cavity is divided into narrow shelves by numerous folds, which project from each side into its lumen. A septum, descending from its roof, further divides it into two lateral parts. The byssus secretion is yielded partly by the cells of the epithelial walls, and partly by glandular cells which lie in the surrounding tissue, their ducts passing between the epithelial cells. The secretion takes the form of the cavity, and is thus held fast as with roots by the numerous lamellæ which occupy the shelves. As the amount of the secretion in the cavity increases, these lamellæ are pressed into the duct (2), where they unite to form the main stem of the byssus.

The walls of the groove (3) and its terminal expansion (4) are also glandular.

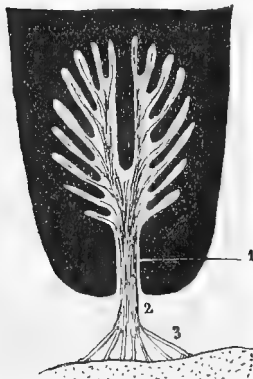

FIG. 102.—Byssus of a Lamelibranch with its cavity and duct. 1, Diagrammatic transverse section through the foot; 2, main stem; 3, terminal threads attaching the byssus to a foreign object.

When a bivalve attaches itself it forms a byssus thread in this groove, which fuses with the end of the main stem. The tip of the foot presses against some surface, such as a rock, and attaches the thread by means of a cement secreted by the widened terminal portion (4) of the groove. In this way the main stem of the byssus may be fastened to a rock by means of numerous threads successively secreted in the groove.

The relation existing between the development of the foot and that of the byssal apparatus may be sketched as follows:—

1. The foot in its primitive form, with a flat sole and no groove, has a simple invagination without byssus (*Solenomya*).

2. With the same foot, a small lamella rises from the base of the simple invagination; the byssus is very slightly developed (*Nucula*, *Leda*).

3. The invagination becomes differentiated into a cavity and a duct, and the byssus and its glands are strongly developed. In consequence of this the foot ceases to be a locomotory organ; its flat sole disappears, and it becomes finger- or tongue-shaped, often more or less reduced in size, and serves for

attaching the byssus. In very many cases the groove is formed from the end of the duct, widening at the tip of the foot as above described. This is especially the case in forms which anchor themselves by the byssus to stones, plants, or the shells of other Molluscs. This attachment may be more or less firm, and may be temporary or permanent (*Limidae*, *Spondyliidae*, *Pectinidae*,¹ *Mylididae*, *Arcaidae*,¹ *Carditidae*,¹ *Erycinidae*, *Galeommidae*, *Tridacnidae*, *Cyprinidae*,¹ *Veneridae*,¹ *Glycymeridae*, *Myidae*,¹ etc.)

When the byssus is very highly developed, some of the pedal muscles become attached to the byssus gland and form the retractors of the byssus.

4. Many Lamelibranchs, in the adult state, have neither byssus nor byssus glands, but the cavity, the duct, and even the retractors (*v.g.* *Trigonia*) may be

¹ *Pro parte.*

retained. The byssal apparatus may be found, in closely-related forms, sometimes with and sometimes without the byssus itself. In the latter case the foot is generally more strongly developed, and serves for locomotion, *i.e.* for forcing a way forward into sand or mud, which most of these forms inhabit, or for the saltatory motion of *Trigonia*. In these cases it is linguiform, or wedge- or hatchet-shaped (*Arcidae*,¹ *Carditidae*,¹ *Cyprinidae*,¹ *Tellinidae*, *Scrobiculariidae*, *Myida*,¹ *Cardiida*,¹ *Lucinidae* (foot vermiform), *Donacidae*, etc.).

5. When the linguiform, or hatchet-shaped, and often bent, foot becomes more strongly developed as a fleshy and extensible organ, every trace of the byssus and its apparatus disappears, at least in the adult (*Unionidae*, many *Veneridae*, *Cyrenidae*, *Psammobiidae*, *Mesodermatidae*, *Solenidae*, *Macluridae*). All these live in mud. The fleshy foot of the *Solenidae*, which is directed forwards, is so strongly developed that it can often no longer be wholly withdrawn into the shell, which therefore gapes anteriorly. The foot is thick and linguiform in *Solenocurtus*; club-shaped and truncated at the tip in *Pharus*, *Cultellus*, *Siliqua*, and *Ensis*; and cylindrical, with an egg-shaped tip, in *Solen*.

6. In forms where one of the valves has become firmly attached to some hard substance, the foot (the byssus being absent) may become rudimentary (*Chamaea*), or may altogether disappear (*Ostreidae*). In forms which inhabit mud or excavations made by themselves in stone, etc., and which surround the body with an accessory calcareous tube (*Gastrochaenidae*, *Clavagellidae*), the foot is also reduced to a small, usually finger-shaped rudiment. The series of boring *Pholadidae* is specially interesting. *Pholas* has a pestle- or sucker-shaped foot, which, projecting through the shell cleft, serves to attach the animal while boring. In *Pholadidea* and *Jouannetia* only the young while boring their habitations possess such a foot; as soon as they have finished this work the pedal aperture of the mantle closes, the anterior cleft of the shell is also closed by means of an accessory shell-piece called the callum, and the foot completely atrophies, so that the animals are no longer capable of locomotion.

In the attached *Anomia*, also, the foot is small: it is of great importance, however, as bearer of the byssal apparatus. The shelly plug (see p. 63), by means of which the animal is fastened to the ground, and which occupies the deep notch cut by the byssus into the right or under valve, must be regarded as a calcified byssus.

Many Lamellibranchs (*Crenella*, *Lima*, *Modiola*) weave a byssus web which they inhabit like a nest, and which they strengthen by the addition of foreign bodies attached by byssus threads.

E. Cephalopoda.

The question, what part of the body in Cephalopoda corresponds with the foot of other Mollusca, has led to much discussion and careful investigation. It may now be considered as pretty well established that the foot in Cephalopoda forms: (1) the arms, (2) the siphon.

The arms are considered as lateral processes of a Molluscan foot which have pushed past the head to the right and left, and have united in front, so that the head is entirely encircled by the foot, and the mouth has come to lie in the middle of the ventral pedal surface, *i.e.* at the centre of the circle of arms or brachial umbrella. That this circle of arms is a derivative of the foot is supported by important anatomical and ontogenetic facts: (1) The arms are innervated from

¹ *Pro parte*.

the brachial ganglion, which lies under the œsophagus, and is an anterior division of the pedal ganglion. (2) The arms do not occupy, in the embryo, their definitive position round the mouth, but rise on the ventral side behind the mouth, between it and the anus, in a row on each side. These two rows shift secondarily forward to form the circle of arms round the mouth. (According to another view, the arms are cephalic appendages, comparable with the cephalic tentacles of the *Pteropoda*.)

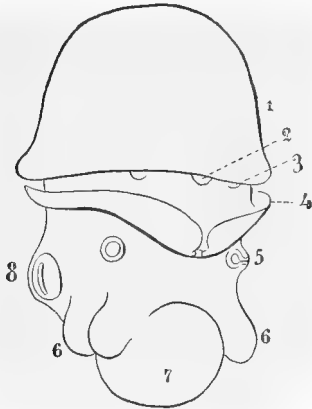

FIG. 103.—Embryo of a Cephalopod, seen obliquely from the left posterior side (after Grenacher). 1, Mantle; 2, anus; 3, right ctentidium; 4, rudimentary siphon; 5, auditory organ; 6, arms; 7, yolk-sac; 8, left eye.

The pedal nature of the siphon or funnel has rarely been doubted. It is innervated from the pedal ganglion. Its two lateral lobes, which in the *Nautilus* remain separate throughout life, but in the *Dibranchiata* overlap, may be considered as epipodia. The accompanying figure of a Cephalopod embryo confirms this opinion; the rudimentary siphon is seen in the typical position of epipodia in the shape of two lateral folds running backward above the foot and under the visceral dome.

In *Nautilus* and the *Decapoda* (excluding the *Loligopsidæ*) a valve is present within the siphon. For the form of the siphon, see p. 38.

1. The Arms of the Tetrabranchia (*Nautilus*).

The "head" of the *Nautilus* (Fig. 104) carries numerous tentacles placed in a circle round the mouth; these do not rise directly from the integument around the mouth, but stand upon special lobes which are differently developed in the two sexes. These lobes may be compared with the arms of the *Dibranchia*, and the tentacles they carry, perhaps, with the suckers on those arms. Each tentacle can be retracted into its own basal portion as into a sheath.

If the head be viewed from the ventral side, so that the mouth appears lying in the centre of the extended lobes and tentacles, we see in the female (lower figure) three inner lobes close to the mouth, two lateral and one posterior. The posterior inner lobe consists of two fused lateral lobes, the line of fusion being indicated by a lamellated (olfactory?) organ. It carries twenty-eight tentacles, fourteen on each side. Each lateral inner lobe carries twelve tentacles. Besides these three inner lobes, the foot develops a muscular circular fold; this is particularly thick anteriorly, and here forms a lobe, the so-called hood (Fig. 32, *a*, p. 22), which, when the head is retracted, covers the aperture of the shell like an operculum. The outer circular fold carries nineteen tentacles on each side.

Besides these tentacles which belong to the foot, there are two more on each side which probably belong to the head, one lying above and the other below the eye.

In the male *Nautilus* (upper figure) the posterior inner lobe is rudimentary. Each of the lateral inner lobes is divided into two portions. In the right lobe, the anterior portion carries eight tentacles and the posterior (antispadix) four, three of

which have a common sheath. The anterior portion of the left lobe also carries eight tentacles, and the posterior portion forms the conical spadix, which, instead

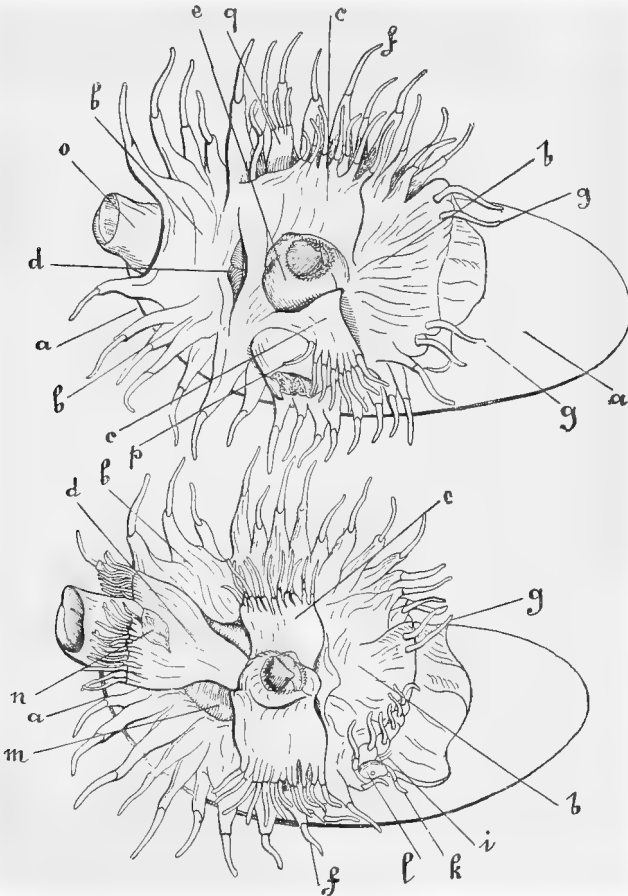

FIG. 104.—Circumoral ring of tentacles in *Nautilus pompilius* (after Lankester and Bourne). From the oral or ventral side. Upper figure male, lower female. *a*, Shell; *b*, circular fold or hood with its tentacles; *g*; *c*, the two lateral inner lobes, in the male the left inner lobe forms the spadix or hectocotylus *p*, and the right the antispadix *q*; *d*, the posterior inner lobe, reduced in the male; *n*, lamellated organ (olfactory?); *e*, jaws in the buccal cone; *f*, the tentacles of the outer muscular circular fold; *h*, eye; *m*, paired lamellated organ; *o*, siphon or funnel.

of tentacles, carries imbricated lamellæ. This spadix is looked upon as the hectocotyliised limb of the *Nautilus*, and probably takes some part in copulation (see the Copulatory Apparatus, p. 242).

2. The Arms of the Dibranchia.

The Dibranchia have either eight or ten arms, which stand in a circle round the mouth and carry two longitudinal rows of suckers (acetabula); rows of cirri may accompany the suckers, and the cirri may here and there become transformed into hooks or claws (*c.g.* *Onychoteuthis*).

In many *Octopoda*, the long arms are connected by means of membranes near their bases, and occasionally as far as their tips. In the latter case the circle of arms has the appearance of an umbrella, of which the arms are the ribs. The mouth lies in the centre. The *Octopoda* can creep by means of their circle of arms, the visceral dome standing erect. In this position they may best be compared with snails, the ventral side of the circle of arms functioning like the sole of the snail's foot.

The *Decapoda* have ten arms; eight of these correspond with the eight arms of the *Octopoda*, but are shorter and are never connected by membranes. The two others, the prehensile tentacles, are inserted between the third and fourth *Octopodan* arms on each side and differ from the latter in structure, being long and vermiform, with swollen ends armed with suckers, hooks, etc. The prehensile tentacles are very contractile, and in many *Decapoda* (e.g. *Sepia*) are concealed in special cavities of the head when the animal is at rest. These cavities probably correspond morphologically with the water pores, which often occur elsewhere at the bases of the arms or on the head. When pursuing prey the *Decapods* dart these tentacles out of their cavities with great force.

One (less frequently two) of the eight or ten arms of the male *Dibranchia* is almost always transformed (hectocotylised) to assist in copulation. In some *Octopoda* it even becomes detached from the body and is regenerated.

The hectocotylised arm is, in the *Octopoda*, usually the third arm on the right side, and in the *Decapoda* the fourth on the left. (The arms are counted from before backward.)

In the female *Argonaut*, each arm of the first pair is widened into a sail-like expansion, which stretches back over the outer surface of the shell.

All Cephalopods, even the more massive *Octopoda*, are good swimmers. In swimming, the mantle and funnel play the chief parts. Water is alternately taken into the mantle cavity through the mantle cleft, and expelled from it forcibly through the funnel, the reaction propelling the animal backwards. When the water is being ejected, the mantle cleft is closed by the locking apparatus, so that all the water in the mantle cavity has to pass out through the funnel. Many *Decapoda* can also swim with the head directed forward, the lower (distal) end of the funnel being bent round, so that the water is expelled in the direction of the visceral dome. In swimming the arms are apposed to one another, so as to diminish the friction as much as possible. Some *Octopoda*, especially those which have interbranchial membranes, assist themselves in swimming by opening and shutting their circle of arms like an umbrella.

XI. Swelling of the Foot (*Turgescence*).

Imbibition of Water.

The foot in many *Lamellibranchia* and *Gastropoda* may swell when it has to be protruded from the shell and used for locomotion. Until recently opinions varied very much as to the way in which this swelling or expansion took place. Many believed that water was taken up from without into the blood vascular system or into a special water vascular system, but there was difference of opinion as to the manner in which it was taken in. On the one hand it was said to enter through apertures or pores in the foot, which, however, do not exist, the only pores found being the apertures of the pedal glands

(byssus and sole glands). On the other hand, the water was supposed to enter the foot through intercellular ducts between the epithelial cells, but this theory has also been disproved.

Others, again, maintained that the water was conducted by the nephridia to the pericardium, and conveyed thence through the blood vascular system; but the pericardium has been shown to be entirely separated from the vascular system. Indeed, many theories on this subject have been put forward and disproved.

It is now the received opinion that, except in the case of one animal, which will be presently described, the foot is swelled by a rush of blood which, flowing into the foot, is prevented from returning to the body by sphincter muscles.

The exceptional case is that of *Natica Josephina*. In this animal there can be no doubt that water is taken in to swell the foot. The swelling takes place very quickly—in less than five minutes. When the foot is stimulated it gives out an amount of water which would fill the empty *Natica* shell two or three times. The water is taken in through very small slits, invisible to the naked eye (probably indeed through a single very narrow slit, lying at the edge of the foot), and finds its way to a system of water sinuses, quite distinct from all other cavities of the foot, and also distinct from the blood vascular system (which in *Natica* is closed). There can thus be no question of a direct taking in of water into the circulatory system. The water slits at the edge of the foot can be closed by muscles, which extend from their upper to their lower edges.

XII. Musculature and Endoskeleton.

This chapter has for its subject simply the general musculature of the body. It would be impossible to describe in detail the musculature of special organs, such as the intestine, the heart, and the copulatory organs, that of the cutis, or even that of the most muscular of all the organs—the foot; since, owing to the varied development and functions of this organ, its musculature is liable to innumerable modifications.

The character of the general body musculature of the Mollusca is determined by the degree of development of the shell, whose function is to protect the soft portions of the body. In order to make this protection complete, the Molluscan body is, as a rule, though differing greatly in details, so arranged that the soft parts can be entirely concealed in the shell, which can itself in many cases be closed. The shell thus functions as skeleton and passive locomotory organ, to which are attached such muscles as draw the body into the shell by their contraction, and such as partially or wholly close the shell.

It is obvious that the arrangement of the musculature becomes much modified secondarily in cases where the shell aborts or altogether disappears.

The musculature of the Mollusca is *not* transversely striated.

A. Amphineura.

The musculature of the *Chitonidæ* has neither been sufficiently investigated nor systematically described. According to the figures of various writers on the subject there are—(1) a large longitudinal muscle mass on each side above the foot; (2) numerous muscle fibres which run down from the latero-dorsal region and radiate into the sole; and (3) the special fibres of the foot, which run through it in various directions. The muscle fibres mentioned under (2) no doubt correspond with the shell muscles of the *Fissurellidæ*, etc., and the columellar muscle of other *Gastropods*. Some of the fibres descending from one side cross those from the opposite side. These crossings are very marked in the median plane between the two pedal nerve cords.

Among the *Solenogastres*, the muscular system of *Proneomenia* has been the most thoroughly investigated. In connection, no doubt, with the degeneration of the foot and the vermiform development of the body, a kind of dermo-muscular tube has been formed; its layers, consisting of muscle fibres running in various directions, are very thin in comparison with the thick epidermis. This muscular tube lies immediately under the epidermis. Its outer layer consists of circular muscle fibres, then follows a layer of diagonal fibres, crossing each other at right angles, but crossing the circular and longitudinal fibres at an angle of 45°. The innermost layer consists of longitudinal fibres, and is most strongly developed on the ventral surface on each side of the ventral groove. Groups of fibres are detached from the circular layer on both sides, and converge towards the base of the rudimentary foot, some of them crossing above it. The bundles which arise from the lateral and upper walls of the body run within the septa which separate the consecutive lateral diverticula of the intestinal canal.

So far as a comparison between these animals and the *Chitonidæ* is possible, the abortion of the foot and vermiform shape of the body being taken into account, and *Chitonellus* taken as the transition form, it may be assumed that the circular muscle layer, and in particular the groups of fibres converging towards the foot, correspond with the dorso-ventral muscles of *Chiton*, and the longitudinal layer with their lateral longitudinal muscle masses.

B. Gastropoda.

The only important muscle to be considered in this class is the columellar muscle. This muscle is attached inside the shell to the columella, along which it runs on the right side of the visceral dome and along the right edge of the mantle cavity; it then enters the dorsal side of the foot in which it spreads out. The columellar muscle acts as a retractor to withdraw the animal into its shell.

1. Prosobranchia.

The columellar muscle is here always developed in its typical form. It is attached at one end to the columella in the last coil of the shell, and at the other to the operculum, which lies on the dorsal side of the metapodium.

A few Prosobranchia, such as most *Fissurellidæ*, *Haliotidæ*, and *Docoglossa*, use their foot chiefly as a sucker for attaching themselves to some firm surface. These forms have no operculum. The columellar muscle descends vertically into the foot, and by its contraction presses the shell against the surface to which it is attached. In *Haliotis* (Fig. 105), the ear-shaped shell of which is coiled, this muscle is cylindrical and is very highly developed; it runs somewhat to the right of the median plane, at right angles to the pedal disc, thereby pushing the mantle cavity and the viscera to the left. In many *Fissurellidæ* and the *Docoglossa*, the shell has become cup-shaped and symmetrical; the columellar muscle, which is very much shortened, descends direct from the inner surface of the shell to the foot, and is no longer cylindrical. The whole muscle has the form of a short truncated hollow cone, open anteriorly, which is attached to the shell by its upper horseshoe-shaped sectional surface, and, by its base of the same shape, to the sucker-like foot. The viscera are contained in its hollow axis (Fig. 106). The same arrangement occurs in all cases where the shell is flatly conical, cup- or plate-shaped, as in the *Hipponcyidæ* and the *Capulidæ* among the *Monotocardia*.

Heteropoda.—In this order, in which the atrophy of the shell, the transformation of the foot, and the gradual obliteration of all resemblance to a *Gastropod* can be traced, step by step, the musculature deserves special attention.

In *Atlanta*, where the head and foot can still be completely withdrawn into the shell, the columellar muscle retains its typical form. It descends from the shell, dividing into three strands; the strongest median strand stretches out into the fin and the sucker, the posterior into the operculum-bearing metapodium, and the anterior, which is the smallest, into the head and snout.

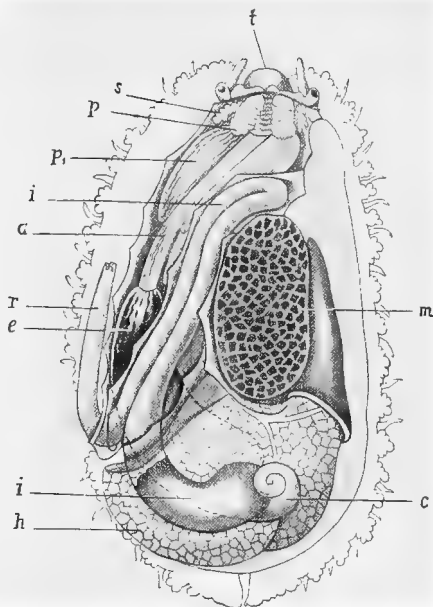

FIG. 105. *Haliotis*, from above, after removal of the shell, the mantle, and the entire dorsal integument (after Wegmann). *t*, Snout; *s* and *p*, salivary glands; *p*₁, lateral pockets of the oesophagus; *i*, mid-gut; *a*, oesophagus; *r*, rectum; *e*, stomach with caecum (*c*); *h*, digestive gland (liver), its right-hand portion which lies next the large columellar muscle (*m*) is covered by the genital gland. A fringed epipodium encircles the body.

The cutis in *Atlanta* is still comparatively thin. The network of muscles lying immediately beneath it is not more strongly developed than in other Gastropods. A special system of crossing muscle fibres independent of the other dermal musculature lies on each side under the cutis of the fin. This is the case in all *Heteropoda*.

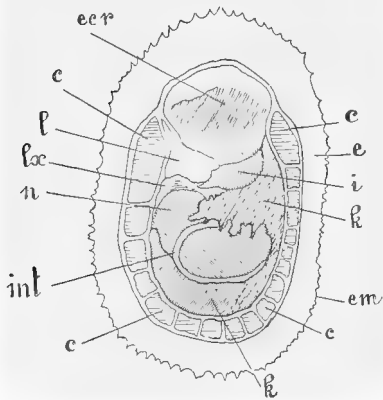

FIG. 106.—Patella, from above, after removal of the shell (after Lankester). *c*, The separate bundles of the shell muscle, the section of which is horseshoe-shaped; *l*, pericardium; *l*, fibrous septum behind the same; *n*, digestive gland; *int*, intestine; *k*, larger right nephridium; *i*, smaller left ditto; *e*, mantle border, widening anteriorly into the mantle fold; *cer*, *em*, edge of mantle.

The integument greatly increases in thickness in the typical *Heteropoda* (*Carinariaria*, *Pterotrachea*), and the subcutaneous muscular tube also grows thicker. Over the body the latter consists of two superimposed layers of fibres crossing one another diagonally. In the outer layer, the fibres run from above anteriorly downwards posteriorly, and in the inner from below anteriorly to above posteriorly. On the head and snout, the visceral dome and the tail-like metapodium, the diagonal fibres of both layers run longitudinally. In addition, an external circular musculature is found in *Carinariaria* nearly all over the body, in *Pterotrachea* only in the snout.

Turning now to *Carinariaria*, which still possesses a delicate, easily detachable shell covering the visceral dome, but unable to protect any other part of the body, we find the columellar muscle still persisting in the form of two bands descending from the visceral dome into the fin and radiating out to its edge.

In *Pterotrachea*, where the shell is wanting and the visceral dome rudimentary, the columellar muscle is also reduced. It has now no connection with the visceral dome, and commences half-way up the body wall as three short bands running down into the fin and radiating out to its edge.

The columellar muscle, which originally served for drawing the foot back into the shell, now serves chiefly to bring about the lateral movements of the vertical rowing fin into which the foot has been transformed.

2. Opisthobranchia.

The columellar muscle is well developed in forms possessing a shell into which the body can be partly or wholly withdrawn. Where, however, the shell is rudimentary or wanting, as is the case with most Opisthobranchia, the columellar muscle atrophies or perhaps forms part of the pedal musculature. The subcutaneous dermo-muscular tube, on the other hand, develops in proportion to the activity of the animal. It consists of longitudinal, circular, and diagonal muscle fibres, which occasionally form a regular network. The pedal musculature is merely a thickened portion of this dermo-muscular tube in which longitudinal fibres predominate. The development of the musculature varies much in detail. Where movable or contractile dorsal appendages, gills, oral lobes, oral discs, parapodia, etc., are developed, their musculature is detached from the dermo-muscular layer, and the latter, in combination with the occasionally tough skin, forms a passive organ of support for the former.

A columellar muscle is further found in the *Pteropoda thecosomata*. It is ventral

in the *Limaciniidæ*, but dorsal in the *Cavoliniidæ*, in which family the body, as compared with the head, seems to have been twisted through an angle of 180° (p. 80). The muscle divides anteriorly into two lateral branches, which radiate out into the fins.

3. Pulmonata.

In the shell-bearing Pulmonata, the columellar muscle is strongly developed. It is paired, and attached at one end by many roots to the foot, behind the buccal mass, and at the other to the columella of the first coil or whorl of the shell. It gives off three subsidiary branches—(1) the retractor muscles of the optic and other tentacles; (2) the retractors of the buccal mass; (3) muscles running to the viscera.

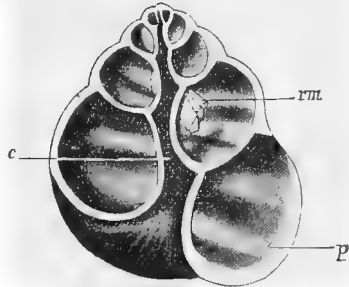

FIG. 107.—Shell of *Helix*, in longitudinal section through the columellar axis (after Howes). *c*, Columella; *rm*, columellar muscle; *p*, edge of oral aperture (peritreme).

In the *Daudebardia* and *Testacellidæ*, in which the dwindling visceral dome with the shell which covers it have shifted to the posterior end of the body, and in which all possibility of the retraction of the body into the shell has ceased, only parts of the columellar muscle are retained, and naturally those parts which are still functional. In the *Daudebardia* and *Testacellidæ* these are the retractors of the tentacles, and in *Daudebardia* the retractors of the pharynx. The tentacular and pharyngeal retractors are distinct.

The **retractors of the tentacles**, in *Daudebardia rufa*, run back separately to the base of the visceral dome, not entering it, but fusing with the body wall on each side of it. In *D. saulcyi* the retractors do not run so far back, but the two on the right fuse with the two on the left, and pass into the pedal musculature in the anterior half of the body. The same is the case in the *Testacellidæ*.

The **Retractors of the Pharynx**.—In *Daudebardia rufa* there are found, attached to the pharynx, two retractors, which, passing through the œsophageal nerve ring, fuse to form one muscle, which runs back along the base of the pharyngeal cavity somewhat to the left, then ascends in the visceral dome to be attached to the columella of the last coil of the shell. In *D. saulcyi*, where there is no projecting visceral dome, and the shell merely covers a mantle cavity, the œsophageal retractors, which are not in this case fused together, no longer run up into the shell, but end in the middle of the body, where they enter the pedal musculature.

The numerous œsophageal retractors which, in *Testacella*, are arranged in two asymmetrical rows, cannot for several reasons be considered as the remains of a columellar muscle.

Oncidium when adult has neither shell nor columellar muscle, but its shell-bearing larva also possesses a columellar muscle.

C. Scaphopoda.

In *Dentalium* (Fig. 101, p. 113) two closely contiguous muscle bands run on each side along the dorsal end of the tubular shell, and are attached anteriorly to the dorsal end of the tubular shell. At the

base of the foot these two bands unite to form a single muscle on each side, which enters the foot and radiates out through it in the form of numerous longitudinal bundles. This then is a **paired columellar muscle** which retracts the foot, and draws the whole of the lower portion of the body back into the upper part of the shell.

D. Lamellibranchia.

The two principal groups of muscles to be considered in this class are:—

1. The pallial musculature.
2. The pedal musculature.

The former is principally developed near the free edge of the mantle, and consists of three systems: (1) Fibres which run in the plane of the mantle fold towards and at right angles to its edge. These are, in the narrower sense, the **museles of the pallial edge**, and leave on the shell the scar known as the **pallial line**. (2) Fibres running parallel with the edge of the mantle. (3) Short transverse fibres running more or less straight between the inner and the outer surfaces of the mantle. In the siphons, which are formed from the mantle, these three systems become circular, longitudinal, and radial layers. The **retractors of the siphons** are a special differentiation of the pallial musculature; their development is in direct relation to the size of the siphons; their crests of attachment to the shell valves cause the scar known as the **pallial sinus** (*cf.* p. 64).

The important **adductor museles** for closing the shell must also be regarded as differentiations of the pallial musculature. These are exceedingly thick and powerful and run transversely from the inner surface of one valve to the corresponding surface of the other valve. They counteract the ligament at the hinge, their contraction causing the two valves to approach one another, till the shell is closed. These adductors leave scars on the inner surfaces of the valves. Typically, there are two adductors, an **anterior** and a **posterior** (**Dimyaria**), situated nearer the dorsal than the ventral edge of the valves. In the *Mytilacea*, the posterior adductor is larger than the anterior (**Heteromyaria** as opposed to **Isomyaria**). In one large series of forms the anterior adductor completely atrophies, and the posterior adductor, which is all the more strongly developed, shifts forwards towards the middle of the shell. These forms are grouped together as **Monomyaria**; but this is no natural group, since nearly-related forms (*e.g.* within the *Muelleriaceae*) may possess either one or two adductors, and widely different forms (*e.g.* *Triducna*, *Anomia*, *Muelleria*, *Aspergillum*) agree in having only one. The *Anomiidae*, *Ostreidae*, *Spondylidae*, *Limidae*, *Pectinidae*, *Aviculidae*, *Muelleridae*, etc., are Monomyarian.

The adductor often (*e.g.* *Pecten*, *Ostrea*, *Nucula*) consists of two apparently different parts, one containing smooth fibres and the other fibres which appear

transversely striated, although their striation does not correspond with that of Arthropod and Vertebrate muscles.

The **pedal musculature**, taken as a whole, answers to the columellar muscle of other Molluscs, especially of the *Gastropoda*. It consists of symmetrical pairs of muscles attached at one end to the inner surface of the shell on which they leave impressions, the other ends entering the foot. The correspondence of this musculature with the columellar muscle of the *Gastropoda* is best seen by comparing a *Protobranchiate* with *Patella* or *Fissurella*. In *Nucula* or *Leda*, for example, there is an almost continuous series of muscle bundles running down to the foot on each side between the anterior and posterior adductors. The two series taken together, seen from above or below, have an oval outline answering to the horseshoe-shaped or almost oval form of the section of the columellar muscle in *Patella* (Fig. 106) or *Fissurella*.

In most cases in which the foot is developed, the following muscles on each side are distinguished in order from before backwards (*cf.* Fig. 108): (1) the protractor

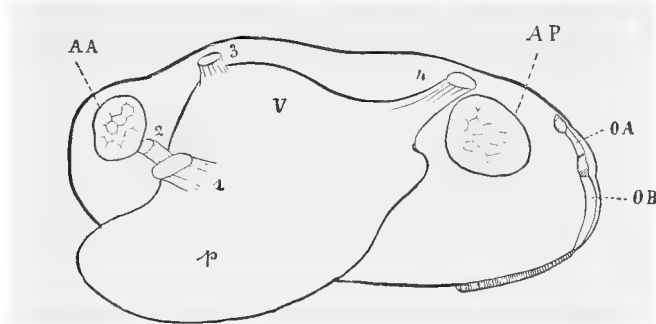

FIG. 108.—*Pliodon Spekei*, from the left (after Pelseneer). The shell, mantle, gills, and oral lobes of the left sides removed. AA, Anterior; AP, posterior adductor; OA, anal; OB, branchial aperture of the siphon; V, visceral mass; p, foot; 1, protractor pedis; 2, retractor pedis anterior; 3, elevator pedis; 4, retractor pedis posterior.

pedis; (2) the anterior retractor pedis; (3) the elevator pedis, and (4) the posterior retractor pedis.

Where there is a byssus, the posterior retractor becomes the byssus muscle. It is then usually highly developed, runs far forward, and may break up into several bundles.

In those cases in which the foot is rudimentary and the byssus wanting, the pedal muscles degenerate.

In *Pecten* the pedal retractors are asymmetrically attached, *i.e.* only to the left valve. The same is the case in *Anomia*, where the shelly plug which lies in the byssus notch of the right valve, and corresponds with the byssus, is attached to the left (or physiologically upper) valve by two highly-developed retractors. These two muscles leave scars near that of the adductors. This fact gave rise to the erroneous opinion that the *Anomia* were *Trinyaria*.

E. Cephalopoda.

In the Cephalopoda, a cartilaginous endoskeleton is developed. This not only serves for the attachment of various muscles and muscular membranes, but is also a protection for important organs, especially for the central portion of the nervous system and the eyes. Of the different cartilages forming this endoskeleton the only constant one is the **cephalic cartilage**.

1. Tetrabranchia (*Nautilus*).

Nautilus possesses only the cephalic cartilage. This is shaped somewhat like an X, with thick limbs. The œsophagus runs up between the one pair of limbs, the other pair serving as supports for the funnel and as surfaces of attachment for its muscles.

The most important of the muscles is the large paired shell muscle, which corresponds with the columellar muscle of other Molluscs. It arises from the cephalic cartilage, and runs on each side into the band (annulus), by which the body of the *Nautilus* is attached to the inner wall of the body-chamber (cf. Fig. 32, p. 22), and, like the band itself, is attached to the shell. The muscle leaves a deep scar on the shell (the lobate sutural line). From the lateral edges of the cephalic cartilage, especially that portion of it which supports the funnel, a broad muscle-band, the **musculus collaris**, runs forward on each side embracing the nuchal part of the body. The two unite on the neck to form the muscular **nuchal plate**. The ventral lower side of the cephalic cartilage serves for the attachment of the musculature of the tentacles.

2. Dibranchia.

The cartilaginous skeleton is much more developed than in

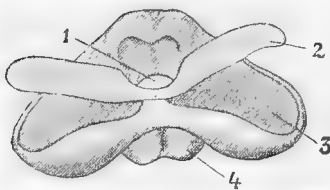

FIG. 109.—Cephalic cartilage of *Sepia*. 1. Central aperture through which the œsophagus passes; 2. preorbital cartilage; 3. chamber for the eye; 4. cartilaginous auditory capsule.

assist in supporting the eyes, and in conjunction with independent, preorbital cartilages form a kind of cartilaginous eye socket. A **basibrachial** cartilage is found at the base of the anterior arms in some *Decapoda*. We have further to

Nautilus, owing perhaps, to some extent, to the atrophy of the shell. Fins, with their supporting cartilages, for example, are developed only in those forms with internal, degenerated shells.

The cephalic cartilage (Fig. 109) is everywhere well developed. It encloses all those central portions of the nervous system which are crowded round the œsophagus, being in the form of a hollow circular capsule traversed by the œsophagus. Processes of this cartilage

assist in supporting the eyes, and in conjunction with independent, preorbital cartilages form a kind of cartilaginous eye socket. A **basibrachial** cartilage is found at the base of the anterior arms in some *Decapoda*. We have further to

mention the nuchal cartilage and the cartilages for locking the cleft of the mantle cavity (p. 55). In the **diaphragm**, *i.e.* in the posterior wall of the visceral dome, over which the mantle depends, there is in the Decapoda a cartilage near the funnel, the **diaphragm cartilage**. Finally must be mentioned a **dorsal cartilage**, which is specially strongly developed in *Scpia*. It lies, posteriorly, on the anterior border of the mantle, where the latter projects over the neck; it bears the same relation to the nuchal cartilage as does the cartilaginous projection on each side of the mantle to the cup-shaped socket at each side of the base of the funnel or siphon (*cf.* Fig. 80).

In *Scpia* the dorsal cartilage is continued in the shape of a cartilaginous rod running up on each edge of the shell. The inner edges of these rods have a groove into which the edge of the shell fits, and thus form a kind of fold round its lateral edges.

In the *Octopoda* there is a cartilaginous band on each side in the dorsal integument which may correspond with the dorsal cartilaginous rods in *Scpia*. It is possible that the "internal shell" of the only *Octopod* in which a shell is found, *viz.* *Cirrho-teuthis*, is not in reality homologous with the shell of the *Decapoda*, but corresponds with the cartilaginous bands of *Octopus* fused in the middle line.

The (basipterygial) cartilages, universally found at the bases of the fins in the *Decapoda*, complete the list.

With regard to the musculature of the Dibranchia, that of the mantle, the fins, and the arms cannot be described in detail. We note, however, that the pallial musculature is principally attached to the shell or to the dorsal cartilage, the fin-musculature to the fin-cartilages, and the brachial musculature to the anterior side of the cephalic cartilage, and partly to the basi-brachial cartilage when such is present.

The remaining musculature can be best explained with the assistance of the accompanying diagram (Fig. 110), which represents the musculature of *Enoploteuthis*.

The strong paired **depressor infundibuli** (1) rises from the shell on each side (or from the dorsal cartilage), and runs downwards and backwards to the base of the funnel and to the cartilaginous socket. From it spring most of the muscles of the anterior wall of the funnel.

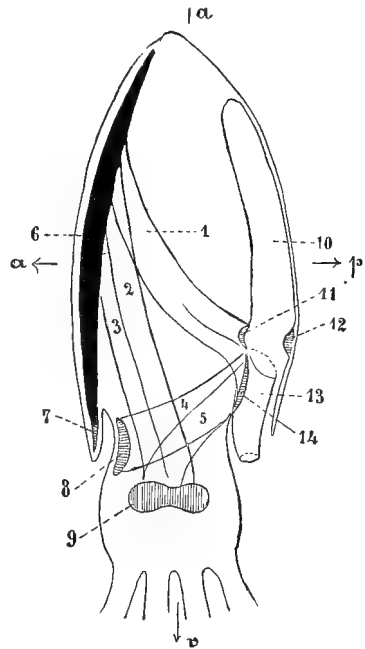

FIG. 110.—Diagram of the more important parts of the Dibranchiate musculature. Body seen from the left side. *v*, Ventral; *d*, dorsal; *a*, anterior; *p*, posterior; 1, depressor infundibuli; 2, retractor capitis lateralis; 3, retractor capitis medianus; 4, musculus collaris; 5, adductor infundibuli; 6, shell; 7, dorsal cartilage; 8, nuchal cartilage; 9, cephalic cartilage; 10, mantle cavity; 11, cartilaginous socket of the locking apparatus on the posterior wall of the visceral dome; 12, corresponding cartilaginous knob on the inner wall of the mantle, which fits into 11; 13, funnel or siphon (infundibulum); 14, diaphragm cartilage.

The **retractor capitis lateralis** (2), which is also paired, rises from the same point as the depressor infundibuli, runs into the head, and is attached to the cephalic cartilage. The **retractor capitis medianus** (3), originally paired, but usually become single by fusion, arises at the posterior (inner) side of the shell, and also runs into the head, and is attached to the cephalic cartilage.

In the Dibranchia, the first muscles which fuse are the two median retractors of the head (*Onychoteuthis*), these then fuse more completely with the lateral retractors (*Ommastrephes*, *Sepioteuthis*, *Loligo*, *Sepioloa*), so that finally (*Sepia*) the whole of the musculature running from the shell into the head forms a muscular sheath open posteriorly. This sheath encloses the lower portion of the visceral cavity, which is principally occupied by the digestive gland or liver, and thus forms a kind of muscular hepatic capsule. The posterior opening in this capsule may finally become completely closed by the depressor infundibuli, in that, on the one hand, its anterior edges fuse with the posterior and median edges of the capsule, and, on the other, it sends out numerous muscles to the diaphragm, forming the **diaphragma musculare**.

The muscular hepatic capsule, *i.e.* all the muscles forming it, the retractors of the head and the depressors of the siphon, may without doubt be accepted as the homologue of the columellar muscle of other Molluscs. Like the latter, they run down from the shell or its vicinity into the head and foot (represented by the siphon).

The **adductors of the funnel** (5) have still to be mentioned. They rise from the cephalic cartilage and run upwards and backwards to the funnel. Finally, the **collaris** (4) is a strong muscle which runs forwards right and left from the wall of the funnel, and is attached to the lateral edges of the nuchal cartilage. In the *Octopoda* and *Sepioloa*, where a pallio-nuchal conerescence (*cf.* pp. 54, 55) has rendered a nuchal locking cartilage unnecessary, the collaris passes uninterruptedly over the neck like a saddle, forming a closed circle round the nuchal portion of the body.

XIII. The Nervous System.

(As a general introduction to this section the reader may be referred to pp. 27, 28.)

A. Amphineura.

The nervous system of the Amphineura is very significant from the point of view of the comparative anatomist. Its most important peculiarities may be briefly described as follows:—

1. The ganglionic cells are either not at all or not exclusively localised in definite ganglia.

2. Four nerve cords run through the body from before backward. These contain not only nerve fibres, but ganglion cells distributed along their whole length. They might suitably be called medullary cords, and must be considered as belonging to the central nervous system.

One pair of these cords run along the body laterally, these are the lateral or pleurovisceral cords; the second lie ventrally, and are the pedal cords. The visceral and the pedal cords of each side unite anteriorly, and when so united become connected with those on the opposite side by a transverse commissure, which runs in front of and over the œsophagus and contains ganglion cells; this is the cerebral or upper half of the œsophageal ring. The pleurovisceral cords unite posteriorly above the rectum, forming a visceral loop. The pedal cords are connected both *inter se* and with the pleurovisceral cords by anastomoses, so that the whole nervous system strikingly recalls the ladder nervous system of the Turbellaria and Trematoda.

a. **Chitonidæ** (Figs. 111 and 51, p. 40).—The scheme just given is founded upon the nervous system of Chiton. The typical ganglia of the central nervous system of the Mollusca are not yet, in Chiton, found as distinct ganglia united by means of commissures and connectives, but the ganglion cells are equally distributed along the commissures and connectives, an arrangement which is probably primitive. The upper œsophageal ring thus corresponds with the cerebral ganglia and the commissures connecting them, and in the same way the pedal cords contain the whole central portion of the pedal nervous system, and the pleurovisceral cords the central portion of the visceral, pallial, and branchial nervous systems. Only in one single species of Chiton (*C. rubicundus*) two distinct (cerebral) ganglia occur near each other in the middle line in the upper half of the œsophageal ring.

Looking more closely at the nervous system of the Chitonidæ, we have to observe: (1) the arrangement of the œsophageal ring and the medullary cords; (2) the peripheral ganglia; (3) the nerves of the ladder-like nervous system; (4) the nerves running from the central nervous system (œsophageal ring and medullary cords).

1. **Form and arrangement of the central nervous system.**—The **visceral cords** run back one on each side in the lateral body wall above the branchial groove; these two cords unite above the anus. The **pedal cords** run in the dorsal part of the pedal musculature somewhat near one another, from before backward, to end without uniting where the rectum commences. The **œsophageal ring** consists, in the first place, of the semicircular portion mentioned above, which, on account of the peculiar shape of the body of the Chiton, lies in the same plane as the visceral cords. Posteriorly, each limb of this semicircle divides up into the pedal and visceral cords. At the point where the pedal cord rises from the ring, a cord with a thickened base separates from it and runs inwards; this, uniting below the mouth with a similar cord from the other side, forms the lower half of the œsophageal ring. The upper and lower halves together form the **closed œsophageal ring**.

2. Besides this central nervous system there are **peripheral ganglia** connected with it by nerve cords consisting only of nerve fibres.

(a) The **buccal ganglia** together form a horseshoe-shaped ganglionic mass below the œsophagus, which mass is connected on each side by the cerebrobuccal connective with the thickened portion of the lower œsophageal ring. The buccal ganglionic mass in *C. rubicundus* divides into two paired ganglia and one unpaired ganglion joined to one another by connectives. The buccal ganglia innervate the œsophagus as far as the stomach and also the oral aperture.

(b) On each side, from the lower half of the œsophageal ring, somewhat further

in than the buccal connective, a nerve (the **subradular connective**) rises and runs

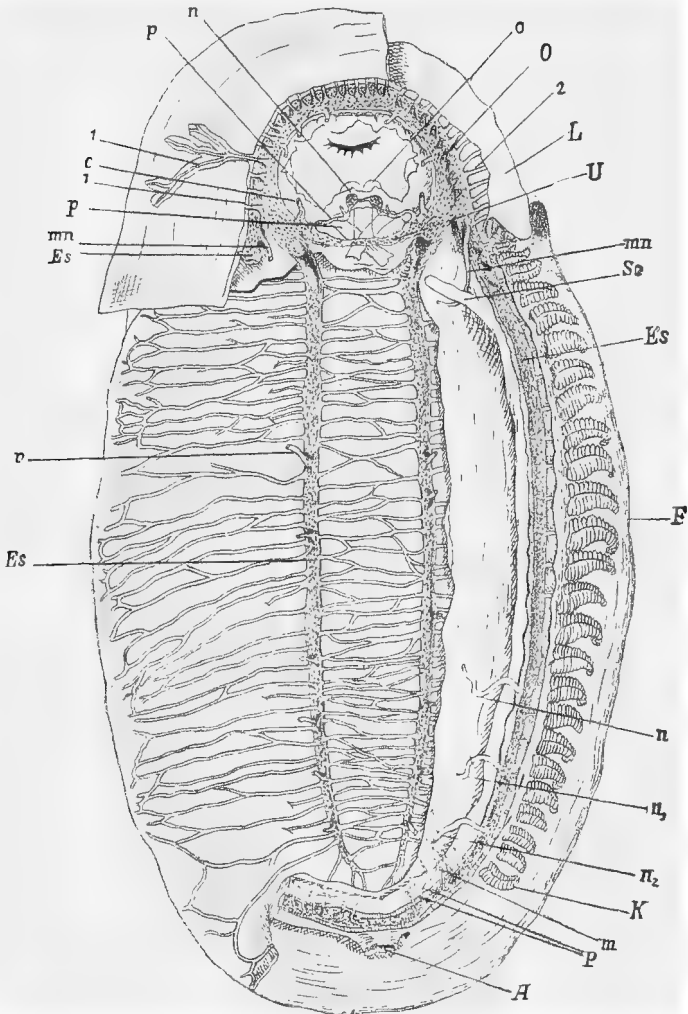

FIG. 111.—Diagram of the nervous system of *Chiton siculus* (after Béla Haller). The mantle removed on the right side. In the centre and to the left the upper part of the foot removed, to expose the pedal nervous system. *F*, Foot; *K*, last gill; *A*, anus; *O*, upper, *U*, lower half of the oesophageal ring; 1, 2, nerves of the oesophageal ring; *c*, connective to the anterior visceral ganglia; *p*, connective to the ganglia of the subradular organ *n* (above on the left); *Es*, pleurovisceral and pedal cords; *mn*, gastric nerve; *So*, point of attachment of the sphincter oris; *n* (below on the right), *n*₁, *n*₂, nephridial nerves; *m*, pallial nerves; *p* (to the right below), cardial nerves; *v*, a dorsal nerve of one of the pedal cords. The commissures between the pedal cords are seen, and the nerves running outwards from the latter.

forward and inward to the **subradular ganglion**. This ganglion lies in the **sub-**

radular organ which is situated on the floor of the buccal cavity. The two subradular ganglia are united by a short commissure.

(c) Two small **gastric ganglia**, connected by a fine commissure, lie at the anterior end of the stomach, and are joined on each side to the anterior end of the visceral cord by a long connective.

3. **The nerves of the ladder-like nervous system.**—The two pedal cords are connected by anastomosing commissures along their whole length, but no nerves are given off by these commissures to the pedal musculature. In *Chiton rubicundus* the visceral and pedal cords are united by numerous connectives, which, in other Chitonidae, appear either to be wanting or to be reduced to one single anterior or posterior anastomosis.

4. **The nerves running from the central nervous system:**—

(a) **Nerves of the œsophageal ring.**—Numerous nerves rise from the upper or cerebral portion of the œsophageal ring to innervate the cephalic part of the mantle, the snout, the upper and lower lips, the gustatory buds on the lower wall of the oral cavity, and the musculature of the buccal mass. The lower portion of the œsophageal ring, besides the connectives to the buccal and subradular ganglia, sends off from its median portion another pair of nerves, which run along the base of the buccal cavity.

(b) **Nerves of the pleurovisceral cords.**—Each of the pleurovisceral cords gives off two nerves to each gill. Besides these they send many nerves to the mantle, and, posteriorly, nerves which enter the body cavity, probably running to the kidneys and the heart.

(c) **Nerves of the pedal cords.**—The pedal cords give off on each side seven or eight nerves outwards to the lateral musculature of the body, and specially numerous nerves run down from it to the pedal musculature (inner and outer pedal nerves). These pedal nerves are richly branched, and, anastomosing with one another, form a complete neural network in the foot.

b. **Solenogastres.**—The central nervous system of the Solenogastres differs from that of the *Chitonidae* principally in a tendency to form distinct ganglia; the **pedal and pleurovisceral cords**, nevertheless, still retain their outer coating of ganglion cells along their whole length. Fig. 112 is a diagrammatic representation of the structure of the nervous system of *Proneomenia Shuiteri*. The fused cerebral ganglia in the middle line are very large. On both the pleurovisceral and the pedal cords ganglionic swellings can be distinguished: (1) **three pairs of posterior visceral ganglia**; (2) **two anterior pedal ganglia**.

The posterior visceral ganglia are connected by cords, which run transversely over the rectum and correspond, to some extent at least, with the loop by which the two visceral strands in *Chiton* are united.

The two anterior pedal ganglia are connected by a strong transverse commissure, which may correspond with the ventral half of the œsophageal ring of *Chiton*.

Further, the pleurovisceral cords are joined with the pedal cords, and the latter are also connected *inter se* by transverse connections along their whole length. The pleurovisceral cords likewise are connected by arched transverse commissures.¹

¹ These connectives and commissures, however, do not seem to run uninterruptedly from one cord to the other.

On each side of the cerebral ganglion, a nerve rises, which runs to a ganglion below the pharynx and behind the radular sheath, this is the **sublingual ganglion**; this latter is united with the corresponding ganglion on the other side by a short transverse commissure. These sublingual ganglia probably correspond with the buccal ganglia of *Chiton*.

Dondersia is specially noteworthy because distinct ganglionic swellings occur at regular intervals along the pedal cords; this is particularly marked in the anterior part of the body. The equally regularly repeated transverse commissures joining the pedal cords, and the connectives between the pedal and visceral cords, start from these distinct ganglia.

In *Lepidomenia hystrix*, one ganglion occurs posteriorly and one anteriorly in each longitudinal trunk (whether pleurovisceral or pedal), and each is connected with a similar ganglion of the opposite side by a transverse commissure.

In *Neomenia* and *Chatoderma*, no connectives between the visceral and pedal

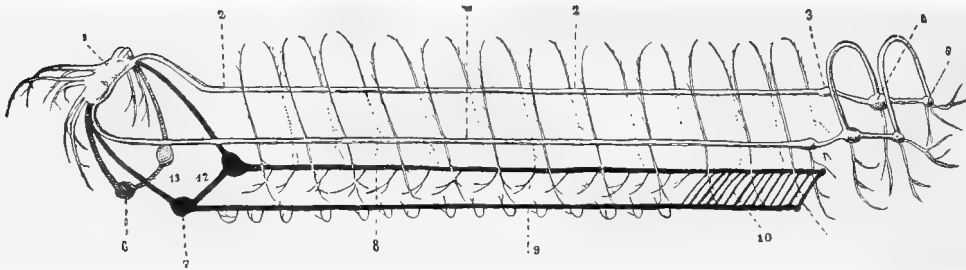

FIG. 112. —Nervous system of *Proneomenia Sluiteri* (original drawing by J. Heuscher). 1, Cerebral ganglia; 2, pleurovisceral cords; 3, 4, 5, posterior ganglia of the pleurovisceral cords; 6, sublingual ganglia; 7, anterior pedal ganglia; 8, right pedal cord; 9, left pedal cord; 10, 11, strong posterior commissures between the pedal cords; 12, anterior pedal commissure; 13, sublingual commissure.

cords have been observed, and, so far as is at present known, in *Chatoderma*, the commissures between the pedal cords are also wanting. Further, in *Chatoderma*, the visceral and pedal cords of each side unite together posteriorly to form one single cord, which becomes connected with the similar cord on the other side by a transverse cord which runs over the cloaca.¹

B. Gastropoda.

The nervous system of the Gastropoda is of great interest to the comparative anatomist on account of the crossing of the pleurovisceral connectives in the *Prosobranchia*, which will be further described in this section.

The nervous system of this class consists typically of those parts which we have already mentioned in our scheme of the organisation of the Mollusca, viz. :—

¹ For further details see Simroth's new edition of Broun's *Klassen und Ordnungen des Thier-reiches*, vol. iii.

1. Two **cerebral ganglia** near or above the œsophagus, which are connected by a **cerebral commissure**.

2. Two **pedal ganglia** below the œsophagus, connected with each other by a **pedal commissure**, and with the cerebral ganglia by two **cerebropedal connectives**.

The cerebral and pedal ganglia with the commissures and connectives belonging to them form a ring encircling the œsophagus, which may be compared with the œsophageal ring of the Annulata and Arthropoda.

3. Two **pleural or pallial ganglia** (between the cerebral and pedal ganglia), which are connected with the cerebral ganglia by two **cerebropleural**, and with the pedal ganglia by two **pleuropedal connectives**.

4. A simple or complex **visceral ganglion** lying below the intestine, united to the pleural ganglia by two **pleurovisceral connectives**.

5. A ganglion, which may be called **parietal**, almost always occurs in the course of each pleurovisceral connective. The parietal ganglion divides the connective into two parts, an anterior **pleuroparietal** and a posterior **visceroparietal connective**.

The cerebral, pedal, and pleural ganglia are (with unimportant exceptions) always arranged symmetrically to the median plane in all Gastropoda. The pleurovisceral connectives and their ganglia, however, are only found in such a position in some Gastropoda. In fact, only in the *Opisthobranchia* (including the *Pteropoda* but excepting *Actæon*) and the *Pulmonata* are they symmetrical, in the sense that the right connective and its ganglion lie entirely on the right, and the left connective and its ganglion entirely on the left side of the body. The *Opisthobranchia* and *Pulmonata* are therefore called **euthyneurous** Gastropoda.

In the *Prosobranchia* and *Actæon*, the pleurovisceral connectives are asymmetrical, inasmuch as they cross one another, the connective springing from the right pleural ganglion running *over* the intestine to the left before joining the visceral ganglion, while the connective from the left pleural ganglion runs *under* the intestine to the right side of the body. In consequence of this crossing, the parietal ganglion of the connective which springs from the right pleural ganglion becomes the **supraintestinal ganglion**, which lies on the left side, and the parietal ganglion of the connective springing from the left pleural ganglion becomes the **infra-intestinal ganglion** which lies on the right side. The *Prosobranchia* and *Actæon* are thus **streptoneurous** Gastropoda.

The Areas of Innervation of the various Ganglia.

1. The cerebral ganglia innervate the eyes, the auditory organs, the tentacles, the snout or proboscis, the lips, the motor muscles of the proboscis and buccal mass, and the body walls lying at the base of the

snout. Even when the auditory organs are found in close proximity to the pedal ganglia, or in close contact with them, they receive their nerves from the cerebral and not from the pedal ganglia.

2. The pedal ganglia supply nerves to the musculature of the foot, and occasionally to the columellar muscle also (*Patella*).

3. The pleural ganglia send nerves chiefly to the mantle, the columellar muscle, and the body walls lying behind the head.

4. The parietal ganglia innervate the ctenidia and osphradium, and also send some nerves to the mantle.

5. The visceral ganglia supply nerves to the viscera. The connectives and commissures also may give off nerves which belong to the areas innervated by the neighbouring ganglia.

6. The buccal ganglia, which will be described below, innervate the muscles of the pharynx, the salivary glands, the œsophagus, the anterior aorta, etc.

A comparison of the typical nervous system of the Gastropoda with that of the *Amphineura* reveals the following homologies:—

1. The cerebral ganglia of the Gastropoda correspond with the œsophageal ring of *Chiton*, with the exception of the central portion of its lower half; and further with the cerebral ganglia of the *Solenogastres*.

2. The pedal ganglia of the Gastropoda answer to the pedal cords in the *Amphineura*, concentrated each into a single ganglion. The arrangement in the *Diotocardia*, which are the more primitive *Prosobranchia*, is very interesting in this connection; **in the Diotocardia the pedal ganglia are continued posteriorly as two true pedal cords, which, like those of the Amphineura, are connected by transverse commissures.**

It is more difficult to compare the pleural, parietal, and visceral ganglia of the Gastropoda with nerves found in the *Amphineura*. The most satisfactory view seems to be that this whole complex of ganglia, together with its connectives, corresponds with the pleurovisceral cords of *Chiton*. The areas of innervation coincide, these being the mantle, ctenidia, osphradia (*Chiton*?), and viscera.

3. If this last assumption is correct, the pleural ganglion must be supposed to have arisen by the concentration into one ganglion of that part of the pleurovisceral cord of *Chiton* which contains the pallial ganglionic cells, this concentration having taken place at the anterior end of the cord, where it leaves the œsophageal ring. If, then, the two component portions of each side of the ring, the cerebropedal and the pleural, move further apart, and at the same time the cerebral and pedal ganglia of the ring become more individualised as ganglia, a double cerebropedal connective comes into existence on each side. One of these connectives shows no ganglion in its course, and is the true cerebropedal connective of the Gastropoda. The second, however, has the pleural ganglion in its course, and from this latter spring the visceral cords; this second connective is thus divided into a cerebroleural and a pleuropedal connective.

4. *Chiton* has numerous gills on each side, each of which receives two nerves from the pleurovisceral cord near it. The Gastropoda have at the most two gills, one on the right and one on the left. In correspondence with this reduction, the ganglionic cells of the pleurovisceral cords belonging to the branchial nerves of *Chiton* have become concentrated on each side into a single ganglion belonging to the single gill. The parietal ganglion is thus accounted for. That portion of each pleurovisceral cord which lies between the pleural and the parietal ganglia becomes the pleuroparietal connective, which consists of fibres only without ganglion cells.

5. There is no nerve in *Chiton* homologous with the visceral ganglion or ganglia of the Gastropoda; this is the chief difficulty in the comparison of the two nervous systems. In the *Amphineura*, the pleurovisceral cords unite *above* the intestine; in all other Molluscs the point of junction (which is the visceral ganglion) lies *below* the intestine.

In *Proneomenia* the posterior commissures between the pleurovisceral cords are merely a more strongly developed part of a general commissural system.

Origin of the Crossing of the Pleurovisceral Connective (Chiastoneury) (Figs. 113-116).

Several attempts have been made to explain the peculiar crossing of these connectives in the *Prosobranchia*. The one here given is in a high degree probable if not altogether satisfactory.

We must start with a supposed racial form which was perfectly symmetrical, even in its nervous system, and possessed an organisation somewhat like that of our hypothetical primitive Mollusc (p. 26). Such an organisation agrees in most important points with that of the extant *Chitonidae*, only one gill, however, was present on each side.

Further, the parietal ganglia innervated the gills and the osphradia, and were thus closely connected with these organs.

The racial form of the *Gastropoda* may have been surrounded by a mantle border which widened posteriorly, *i.e.* covered a somewhat deeper mantle cavity which contained the pallial complex, *viz.* the median anus, to the right and left of which were the ctenidia and osphradia, and between the ctenidium and anus on each side the nephridial aperture.

If we suppose this pallial complex to have changed its position, shifting gradually forward along the right mantle furrow, each ctenidium would drag along with it its parietal ganglion. The heart and its auricles which are connected with the ctenidium would also become shifted.

As long as the pallial complex had not moved far forward to the right, the pleurovisceral connectives would not cross, but would only be shifted to the right (Fig. 114). We find the *Tectibranchia* among the *Opisthobranchia* apparently at this stage, the only difference being that they have already lost the original left ctenidium and also the original left auricle (Fig. 43, p. 33).

If the pallial organs are still further shifted forward along the mantle furrow (Figs. 115, 116) till they come to lie quite anteriorly, and once more symmetrically, above and behind the neck, the original left ctenidium comes to lie on the right, and the original right ctenidium on the left in the anteriorly placed mantle cavity. The original right ctenidium has, however, dragged its parietal ganglion over the intestine to the left side, and the latter becomes the **supraintestinal ganglion**. The original left ctenidium, on the contrary, has dragged its ganglion below the intestine to the right

side, and this ganglion becomes the **infraintestinal ganglion**. The pleurovisceral connectives, in which these ganglia lie, now cross and give rise to the condition called **chiastoneury**. The visceral

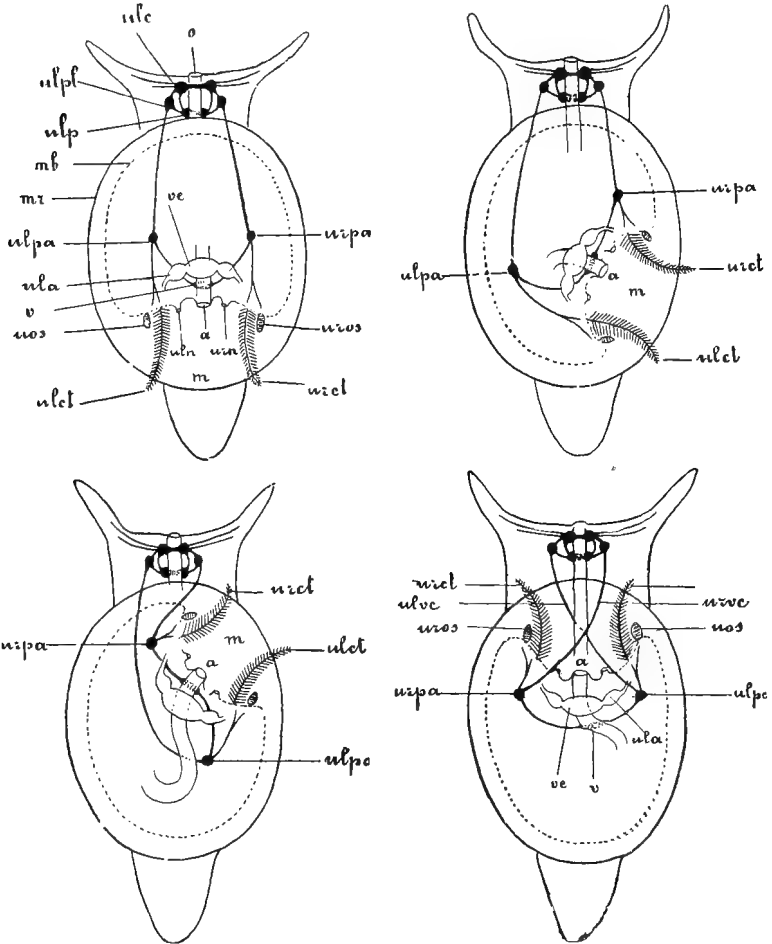

FIGS. 113, 114, 115, 116.—Diagrams to illustrate the shifting forward of the pallial complex along the right side of the body and the development of chiastoneury. *p*, Mouth; *ulc*, *ulpl*, *ulp*, original left cerebral-, pleural-, and pedal-ganglion; *ulpa*, *uipa*, original left and original right parietal ganglion; *ula*, original left auricle; *uos*, *uros*, original left and original right osphradium; *ulct*, *uict*, original left and original right ctenidium; *mb*, base of the mantle; *mr*, edge of the same; *m*, mantle cavity; *v*, visceral ganglion; *ve*, ventricle; *a*, anus.

ganglion in which these connectives terminate posteriorly lies as before under the intestine.

It is unnecessary to show in detail how this displacement also affects the heart and its auricles, the osphradia, and the nephridial apertures.

Although chiastoneury may be satisfactorily explained by this theory of displacement, the cause of the displacement itself has still to be sought (*cf.* § xiv. p. 149).

Special Remarks on the Nervous System of the Gastropoda.

I. Prosobranchia. (*a*) **Diotocardia.**—These are the most primitive Gastropoda. The ganglia are not yet very distinct, thus recalling the *Amphineura*. The **cerebral ganglia** are connected by two long commissures, the **cerebral commissure** running forward over the pharynx, and the **labial commissure** running under the œsophagus. The indistinctly separated **buccal ganglia** together form a horseshoe-shaped figure, and are united on each side by a connective with the thickened root of the labial commissure.

The **pleural ganglia** lie close to the **pedal ganglia**, so that no distinct pleuro-pedal connectives can be distinguished. The **pedal commissure** is very short, and contains ganglion cells. From each pedal ganglion, a long **pedal cord** runs back into the foot; these two pedal cords contain ganglion cells along their whole length, and are connected by transverse commissures. These cords and commissures thus exhibit the same arrangement as in the *Amphineura*. The pedal cords innervate the musculature of the foot and the epipodium. There is only one indistinct visceral ganglion, which is joined to the pleural ganglia by two pleurovisceral connectives, crossed in the typical way.

In *Fissurella* only does a ganglion occur on the suprainestinal pleurovisceral connective. In no other *Diotocardian* is there a ganglion at the point of departure of the strong branchial nerve from the pleurovisceral connective; this nerve, however, forms the **branchial ganglion** just below the osphradium at the base of the gill. Where a ctenidium, or merely an osphradium, is found on each side, there is a branchial ganglion close to it; where only the left (ur) gill is retained (*Turbinida*, *Trochida*), only the left branchial ganglion is found. Since, as a rule, the parietal ganglia are wanting in the *Diotocardia*, and the branchial ganglia in the *Monotocardia*, the branchial ganglia of the *Diotocardia* have been considered, with much probability, as intestinal ganglia, which have shifted away from the pleurovisceral connectives and towards the bases of the gills. As, however, *Fissurella* possesses both a suprainestinal and a left branchial ganglion, it would be necessary to assume that an originally single ganglion had here become divided into two.

The **symmetrical pallial nerve** is always connected by a **pallial anastomosis** with the **asymmetrical pallial nerves** on the same side of the body. The symmetrical pallial nerve rises out of the pleural ganglion, the asymmetrical nerves out of the parietal ganglion, or the pleuroparietal connective.

The nervous system of the *Neritidae* and *Helicinidae* are peculiar, in that the suprainestinal pleurovisceral connective and its corresponding ganglion are wanting.

Docoglossa.—The only essential difference between the nervous system of *Patella* (Fig. 117) and the typical system of other *Diotocardia* lies in the fact that the pleural and pedal ganglia are joined by a distinct pleuropedal connective.

(*b*) **Monotocardia** (Fig. 118).—The parietal ganglia are always present. The cerebral commissure is short, and lies behind the pharynx. The labial commissure is wanting (except in the *Paludinidae* and *Ampullaridae*). The pedal cords and transverse commissures are wanting (except in the *Architanioglossa: Paludinidae, Cyclophoridae, Cypracidae*). The number of visceral ganglia varies from one to three.

The progressive development of so-called **Zygoneury** is noteworthy. In the *Diotocardia*, a pallial anastomosis exists between the symmetrical and asymmetrical

pallial nerves on each side. If this anastomosis were to shift along the two pallial nerves of one side to their places of origin, *i.e.* the ganglia from which they spring, it would become a **pallial connective** uniting the pleural and parietal ganglia of the same side of the body. There would thus arise a new accessory pleurointestinal

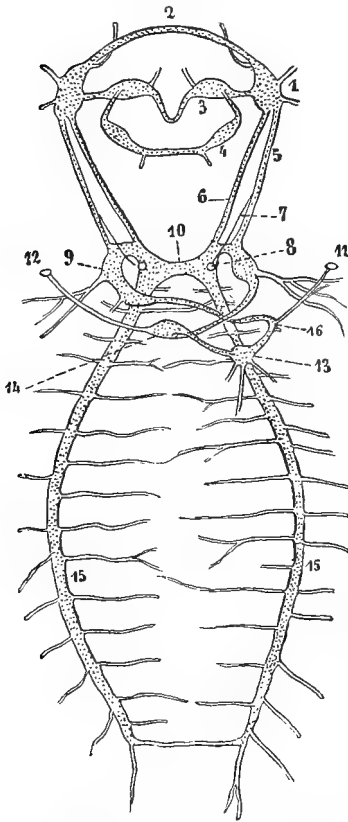

FIG. 117.—Nervous System of Patella (adapted from figures by Pelseneer and Bouvier). 1, Cerebral ganglion; 2, cerebral commissure; 3, labial ganglion; 4, buccal ganglion; 5, cerebropleural connective; 6, cerebro-pedal connective; 7, nervus acusticus; 8, auditory vesicle; 9, pleural ganglion; 10, pedal ganglion; 11, right, 12, left osphradium; 13, visceral ganglion; 14, supraintestinal ganglion; 15, pedal cords; 16, indication of an infraintestinal ganglion.

II. **Opisthobranchia.**—The nervous system of this order, in which the typical Gastropodan ganglia are developed, is further characterised: (1) by the absence of

zygoneury thus depends on the development of such a pallial connective. In the large majority of cases in which it occurs it takes place on the right side (a few *Rostrifera*, *viz.* some of the *Cerithiidae*, *Ampullariidae*, *Turritellidae*, *Xenophoridae*, *Struthiolariidae*, *Chenopidae*, *Strombidae*, *Calyptbrachidae*, and in all *Proboscifera siphonostomata* and all *Stenoglossa*). Less frequently, zygoneury takes place on the left side (*Ampullariidae*, a few *Crepidulidae*, *Naticidae*, *Lamellaridae Cypridae*). In other *Prosobranchia* there is only a pallial anastomosis on each side, as in the *Diotocardia*; the nervous system is then called **dialyneurous**.

The progressive concentration of the central nervous system of the *Monotocardia*, which keeps pace with the development of zygoneury, must be emphasised. The connectives uniting the various ganglia continually shorten, so that at last anteriorly on the oesophagus there is a collection of ganglia; these are the cerebral, pleural, pedal, infraintestinal, and supraintestinal ganglia, all lying close together, to which must be added the small buccal ganglia. Only the visceral ganglia remain far back in the visceral dome.

In *Natica*, where the anterior part of the foot is strongly developed, and is bent back over the head (Fig. 98), a propedal ganglion becomes differentiated from the pedal ganglion.

The nervous system of the *Heteropoda* requires fresh investigation. So far as we at present know, they certainly have crossed visceral connectives, and are therefore *Prosobranchia*, and, as the rest of their organisation shows, *Monotocardia*. The cerebral ganglia and the pedal ganglia (pleuropedal ganglia?) are far apart, so that the cerebro-pedal connectives are very long.¹

¹ Cf. Pelseneer's *Introduction à l'étude des Mollusques*, 8vo, Bruxelles, 1894, pp. 104, 105.

chiastoneury, *i.e.* the pleurovisceral connectives do not cross (except in *Actæon*); and (2) by a marked tendency to concentration of the ganglia around the posterior end of the pharynx.

(a) **Tectibranchia.**—As a rule only the right parietal ganglion is found (in *Actæon* the left is also present). A nerve rises from it which innervates the ctenidium, the osphradium, and the mantle, and forms a branchial ganglion at the base of the gill. A delicate lower cerebral commissure is often found, which runs along the pedal

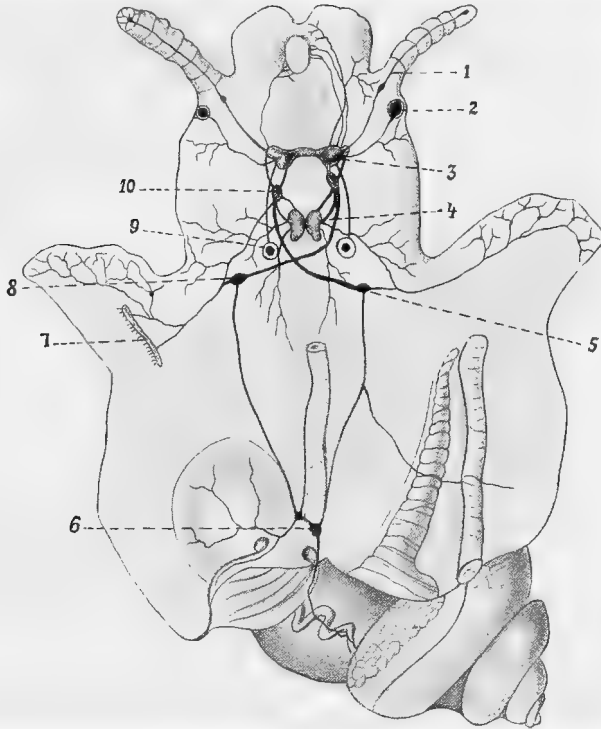

FIG. 118.—Nervous System of *Cyclostoma elegans* (after Lacaze-Duthiers). 1, Tentacular nerve; 2, eye; 3, cerebral ganglion; 4, pedal ganglion; 5, infraintestinal ganglion; 6, visceral ganglion; 7, osphradium; 8, supraintestinal ganglion; 9, auditory vesicle; 10, pleural ganglion.

commissure below the pharynx, and may be compared with the labial commissure of the *Diotocardia*.

As types of the *Tectibranchia* we may take *Bulla* as representative of the *Cephalaspidae*, and *Aplysia* as representative of the *Anaspidae* (*Aplysiidae*).

Fig. 119 gives the nervous system of *Bulla hydatis*; only three points concerning it need be mentioned: (1) The pleural ganglia have shifted till they lie close to the cerebral ganglia, the cerebropleural connectives becoming correspondingly shortened. (In *Actæon* these ganglia have even fused, and are no longer to be distinguished externally.) (2) There are three visceral ganglia. (3) The commissures are comparatively long. (4) The parapodia are innervated from the pedal ganglia.

In many *Cephalaspidae*, moreover, no distinct right parietal ganglion exists. It

seems to have moved up to the right pleural ganglion, or to have fused with it, so that the nerve running to the branchial ganglion rises direct from the right pleural ganglion.

The nervous system of the *Pteropoda thecosomata*, which we derive from *Cephalaspida*, bears a general correspondence to that of the latter, especially in the fact that the pleural ganglia shift near to or fuse with the cerebral ganglia. The pleurovisceral connectives are so much shortened that the ganglia occurring in their course lie close to the cerebral and pedal ganglia. There are usually two such

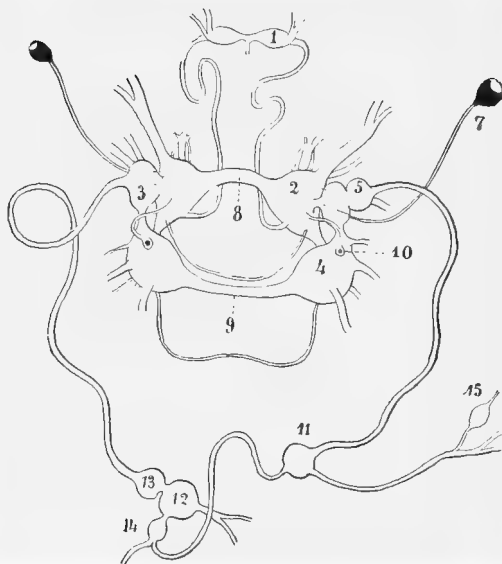

FIG. 119.—Nervous System of *Bulla hydatis* (after Vayssière). 1, Buccal ganglion; 2, cerebral ganglion; 3, pleural ganglion; 4, pedal ganglion; 5, part of the right pleural ganglion (?); 7, eye; 8, cerebral commissure; 9, pedal commissure; 10, auditory vesicle; 11, right parietal ganglion; 12, 13, 14, visceral; 15, branchial ganglia.



FIG. 120.—Nervous System of *Aplysia*, diagram, combined from several sources. 1, Buccal; 2, cerebral; 3, pleural; 4, pedal; 5, right parietal; 6, visceral ganglion; 7, osphradium; 8, genital ganglion; 9, branchial ganglion.

ganglia (the right parietal and a visceral ganglion ?), less frequently three (two intestinal and one visceral ganglion ?). The pedal ganglia also innervate the fins, which correspond with the parapodia of the *Cephalaspida*.

Fig. 120 represents the nervous system of *Aplysia*, one of the *Anaspida*. The two cerebral ganglia have moved close to each other in the middle line. The pleural ganglia here, unlike those of the *Cephalaspida*, lie close to the pedal ganglia, so that the pleuropedal connectives are much shortened. The pedal commissure is double, the anterior commissure is, relatively speaking, short and thick, the posterior long and thin. The long pleurovisceral connectives run back from the pleural

ganglia, and enter two ganglia lying side by side; that to the right represents the right parietal ganglion, innervating chiefly the gill and osphradium, the nerves running to these organs forming a ganglion at the base of each; that to the left is the visceral ganglion. One of the nerves which run from the latter forms a genital ganglion at the base of the accessory glands connected with the genital organs. In other *Anaspideæ*, such as *Notarchus* (Fig. 121), the pleurovisceral connectives are so much shortened that the parietal and visceral ganglia lie close to the peri-oesophageal group of ganglia, which then consists of two cerebral, two pedal, and two pleural ganglia, and further, the right parietal and the visceral ganglia. The two cerebral ganglia are further connected by a thin *lower* commissure. The parapodia are always innervated from the pedal ganglia. The nervous system of the *Pteropoda gymnosomata*, which are nearly related to the *Anaspideæ*, corresponds in all essential points with the nervous system of the latter, being of the same type as that of *Notarchus*.

(b) **Nudibranchia and Ascoglossa.**—The nervous system is here characterised by very great concentration of the typical Molluscan ganglia, and by a tendency to the formation of numerous accessory ganglia (at the bases of the tentacles and rhinophores, and at the roots of their nerves, in the course of the genital nerves, etc.). The pleural ganglion has moved close to the cerebral ganglion, and may fuse with it. The pedal

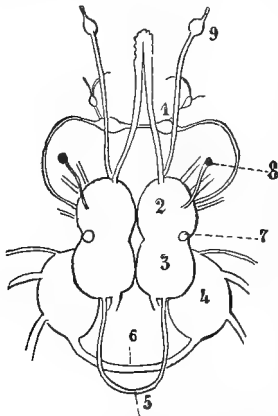

FIG. 122. — Nervous System of *Janus* (after Pelseneer simplified). 1, Buccal; 2, cerebral; 3, pleural; 4, pedal ganglia; 5, commissure between the two pleural ganglia, which corresponds with the two pleurovisceral connectives of other Mollusca; 6, pedal commissure; 7, auditory vesicle; 8, eye; 9, ganglion of the rhinophore.

ganglia have also moved towards the cerebral ganglia so that now the whole oesophageal complex of ganglia lies almost entirely on the dorsal side of the oesophagus. The pedal commissure which runs under the gullet, and is sometimes double, is thus very much lengthened. The pleurovisceral connectives are short, and occasionally enter an unpaired visceral ganglion, which has also been drawn into the oesophageal complex. This single ganglion of the visceral connectives may be wanting (Fig. 122); in that case the two visceral connectives appear like a commissure between the two pleural ganglia running under the oesophagus and parallel with the pedal commissure, sometimes even united with it. The fusion of all the ganglia belonging to the peri-oesophageal complex is carried very far in such animals as *Tethys*, where the pleural and pedal ganglia of each side may fuse with the cerebral ganglion. The pleuro-cerebro-pedal ganglion thus formed shifts towards the dorsal middle line close to the similar ganglion of the other side, with which it forms a large supra-oesophageal ganglionic mass. Its composition out of the six typical ganglia can, however, be made out by the grouping of the ganglion cells and the arrangements of the nerve tracts. A nerve leaves this mass on each side, the two uniting under the gullet. These

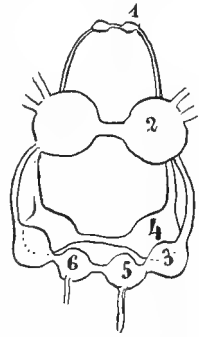

FIG. 121. — Nervous System of *Notarchus punctatus* (after Vaysière), diagrammatic. 1, Buccal; 2, cerebral; 3, pleural; 4, pedal ganglia; 5, right parietal ganglion; 6, visceral ganglion.

form the pedal commissure, which when closely examined is found to be double. A third delicate commissure running under the oesophagus connects the lateral portions

of the supra-oesophageal mass, and represents the visceral commissure, in which is found a small visceral ganglion.

Among the Nudibranchia the two buccal ganglia are always found on the posterior and lower wall of the pharynx. They are connected with each other by a buccal commissure, and with the brain by two cerebrobuccal connectives, in whose course accessory ganglia may be found.

The whole peri-oesophageal complex of ganglia is in the Nudibranchia enclosed in a capsule of connective tissue.

III. Pulmonata (Fig. 123).—

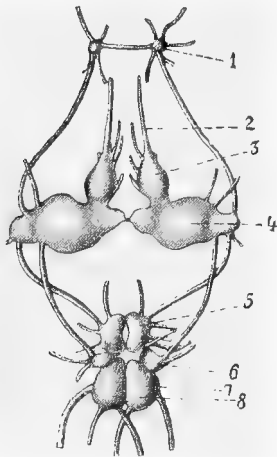

FIG. 123.—Central portion of the Nervous System of *Helix pomatia* (after Böhmig and Leuckart), somewhat diagrammatic, the ganglia being in reality less distinct. 1, Buccal ganglion; 2, optic nerve with thickened root (3) arising from the cerebral ganglion (4); 5, pedal; 6, pleural; 7, parietal; 8, visceral ganglion.

found. They lie posteriorly on the pharynx below the oesophagus, and are joined to one another by the buccal commissure and to the cerebral ganglia by cerebrobuccal connectives.

C. Scaphopoda.

The nervous system of the Scaphopoda (Fig. 101, p. 113) is symmetrical; the visceral connectives are not crossed. The two cerebral ganglia lie very near one another in front of (or, if the intestine is regarded as horizontal, above) the gullet over the snout; the two pedal ganglia, close to one another, lie on the anterior side of the foot, more or less at its centre, and are joined to the cerebral ganglia by two long cerebropedal connectives. The two pleural ganglia lie close to and above the cerebral ganglia, so that the cerebroleural connective is very short. The pleuropedal connective

at once fuses with the cerebropedal, the two entering the pedal ganglion as one connective. Posteriorly, to the right and left of the rectum, near the anus, there are two **visceral ganglia** of the pleuro-visceral connectives, joined to one another by a commissure running behind the intestine. There are no special parietal ganglia distinct from the visceral or the pleural ganglia.

There are four buccal ganglia, two behind the gullet or below it (if the intestine is supposed to be horizontal), and two lying laterally and anteriorly to (or above) the muscular mass of the radula. The anterior are connected with the posterior, and these to the cerebral ganglia by connectives, and the two posterior and two anterior *inter se* by commissures running behind (under) the œsophagus. Nerves run from the posterior buccal ganglia to the small ganglia of a subradular organ.

D. Lamellibranchia.

The nervous system (Fig. 124), like the whole organisation of the Lamellibranchia, is perfectly symmetrical, and consists typically of three pairs of ganglia: (1) the **cerebropleural**; (2) the **pedal**; and (3) the **visceroparietal** ganglia. These three pairs of ganglia lie, as a rule, far apart, and the connectives uniting them are therefore long. The two pedal ganglia lie close together, while the two cerebropleural and the two visceroparietal ganglia are connected by distinct commissures beset with ganglion cells.

1. The cerebropleural ganglia are the result of the fusion of the cerebral with the pleural ganglia. In the *Protobranchia*, however, the pleural ganglia are still distinct, and lie immediately behind the cerebral ganglia at the commencement of the visceral connectives. In *Nucula*, the pleuropedal connectives are distinct for some distance, and then unite with the cerebropedal connectives. In *Solenomya* they still have separate roots, but are otherwise fused along their whole length with the cerebropedal.

The cerebropleural ganglia are supraœsophageal, and are in contact with the anterior adductor muscle, when this is present. They send nerves into the oral lobes, the anterior adductor, and the mantle.

2. The pedal ganglia lie at the base of the foot.

3. The third pair of ganglia, which correspond with the ganglia of the visceral connectives in the *Gastropoda*, lie posteriorly beneath the rectum, behind the foot, and are generally in contact with the posterior adductor muscle; in the *Protobranchia*, however, they lie much further forward. Their area of innervation corresponds with that of the combined parietal and visceral ganglia of the *Gastropoda*, for these visceroparietal ganglia supply with nerves the two ctenidia, the two osphradia, the posterior portion of the mantle, the posterior adductor, and the viscera.

The **buccal or stomodæal nervous system** is much reduced; this reduction is connected with the absence of a muscular pharynx and of all buccal armature. The

anterior portion of the intestine receives nerves from the visceral connectives. Since the fibres of these nerves have been proved to originate in the cerebral ganglia, we may assume that, on the degeneration of the pharynx, the buccal connectives united with the visceral connectives, so that the intestinal nerves now rise from the latter and do not come direct from the brain. In the *Pholadidae* and *Teredinidae* the visceral connectives are united *in front of* the visceroparietal ganglia by a second

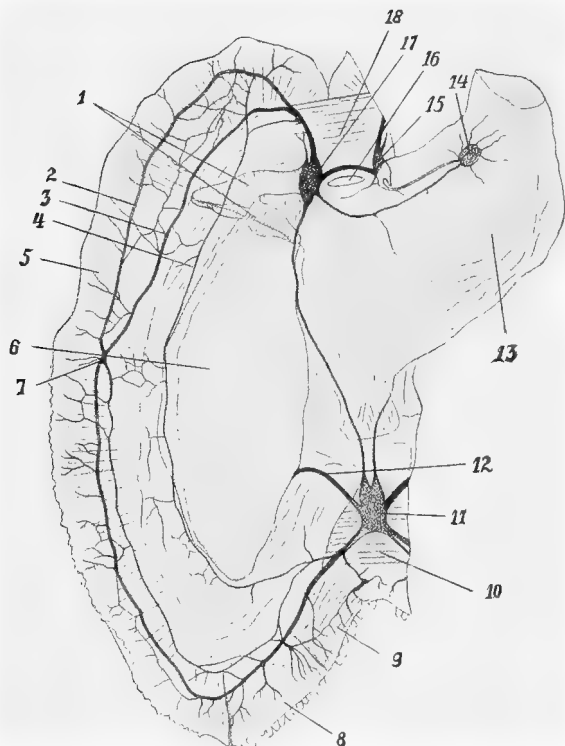

FIG. 124.—Nervous system of *Cardium edule* (after Drost), seen from the ventral side. The left mantle (the right in the figure) has been removed and the right bent back; the foot has been laid on one side. 1, Oral lobes; 2, 3, 4, pallial nerves, running nearly parallel to the edge; 2, the nerve of the pallial edge; 5, mantle; 6, gill; 7, point of junction of the principal pallial nerves; 8, mantle edge of the respiratory aperture; 9, ditto of the anal aperture; 10, posterior adductor; 11, visceroparietal ganglion; 12, branchial nerve; 13, foot; 14, pedal ganglion; 15, left cerebropleural ganglion; 16, mouth; 17, right cerebropleural ganglion; 18, anterior adductor.

commissure, which runs under the intestine, and may perhaps be considered as a buccal commissure shifted far back.

The mantle is innervated, as is clear from the above, partly from the cerebropleural, and partly from the visceroparietal ganglia.

The two anterior pallial nerves, which rise from the cerebropleural ganglia, run back along the edges of the mantle, to join the two posterior pallial nerves which originate in the visceroparietal ganglia. A nerve thus runs parallel to the edge of the mantle on each side (nerve of the pallial edge), and like a connective, unites the anterior cerebropleural ganglion with the posterior visceroparietal ganglion. This

pallial nerve gives off branches to the organs at the edge of the mantle and to the siphons, and is further connected with a rich nerve plexus in the mantle fold, in which certain connecting nerves, further from the edge of the mantle, but running parallel to it, are particularly strongly developed. A varying number of small peripheral ganglia attain development in the pallial plexus and in the siphonal nervous system.

E. Cephalopoda.

The symmetrical nervous system of all Cephalopoda is marked by the great concentration of the typical Molluscan ganglia, including those of the visceral connective.

In the following description of the nervous system, we shall consider the body in its physiological, not in its true morphological position, *i.e.* we shall imagine the pharynx and œsophagus to be running horizontally as in other Molluscs (*cf.* p. 36). The true morphological position will be given in brackets after the conventionally accepted position.

1. Tetrabranchia (Figs. 125, 126).

In the complex of ganglia which in *Nautilus* surrounds the œsophagus behind the great buccal mass, and which is not yet completely enclosed in the cephalic cartilage, the ganglia are not very distinct from the commissures and connectives. The **cerebral ganglia** (14, in Figs.) are represented by a broad band-like nerve cord running over (morphologically in front of) the œsophagus, and from them run two ganglionic cords, one anterior (lower) and one posterior (upper), which pass just below (behind) the œsophagus. The anterior (3) represents the **pedal**, and the posterior (15) the combined **pleural and visceral ganglia**.

The cerebral cord gives rise laterally to the large optic nerves (each of which at once swells into an optic ganglion), numerous nerves to the lips, the nerves for the optic tentacles, the auditory and olfactory nerves, and the cerebrobuccal connectives.

From the pedal cord, nerves run to the tentacles round the mouth and to the funnel. In the female, the nerves for the inner circle of

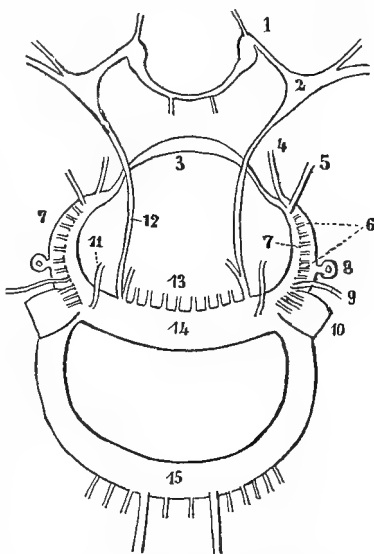

FIG. 125.—Nervous system of *Nautilus* (after Jhering). 1, Buccal ganglion; 2, pharyngeal ganglia; 3, pedal commissure; 4, infundibular nerve; 5, nerve in the female for the tentacles of the posterior and inner lobes; this nerve soon swells to form a ganglion (*cf.* Fig. 126); 6, nerves for the other tentacles; 7, pedal cord (=pedal ganglia); 8, auditory organ; 9, olfactory nerve; 10, optic ganglion; 11, nerve of the optic tentacles; 12, connective to the pharyngeal ganglion; 13, labial nerves; 14, cerebral cord (=cerebral ganglia); 15, pleurovisceral cord.

tentacles come from a **brachial ganglion**, which, however, does not supply all the tentacles (Fig. 126, *a*); this is joined to the pedal ring by a brachiopedal connective.

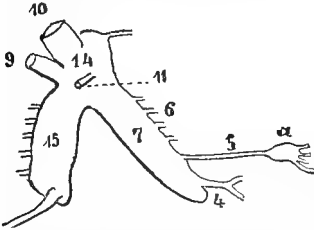

FIG. 126.—Nervous system of *Nautilus*, from the right side. Numbering the same as in Fig. 125. *α*, Ganglion for the tentacles of the posterior and inner lobes in the female.

The **pleurovisceral cord** gives off numerous pallial nerves (there is no stellate ganglion), and two strong visceral nerves which run near the middle line accompanying the vena cava, innervate the gills, the osphradia, and the blood-vessels, and form a genital ganglion high up in the visceral dome.

The **sympathetic nervous system** consists of an infra-oesophageal commissure, which rises from the cerebral ganglion, and passes close under the oesophagus in the musculature of the buccal mass; two ganglia, a pharyngeal and a buccal ganglion, are found on each side in its course.

2. Dibranchia (Figs. 127, 128).

The peri-oesophageal mass of ganglia, comprising the whole of the central nervous system, is entirely enclosed in the cephalic cartilage. The large typical ganglia are so crowded together that it is extremely difficult to distinguish them one from another, and the connectives and commissures are not visible externally. The whole complex has a continuous cortical layer of ganglion cells.

The more or less distinct separation of each pedal ganglion into two, one anterior (lower) and one posterior (upper), is characteristic of the Dibranchia. The former of these is the **brachial ganglion**, and innervates the arms, which must be considered as parts of the foot; and the latter is the **infundibular ganglion**, and innervates the siphon, which may be regarded as the epipodium. This differentiation of the pedal ganglia can be traced to the great development of that part of the foot (viz. the arms) which surrounds the head. In the same way in *Natica*, where the anterior part of the foot is strongly developed, and is bent back over the head, a propedal ganglion becomes differentiated from the pedal ganglion. The brachial ganglia become joined in the *Dibranchia* to the cerebral ganglia by cerebrobrachial connectives. In *Eledone* and *Octopus*, they are further connected with one another by a thin supraoesophageal commissure.

The pleural ganglia lie laterally in the periesophageal mass, while the ganglia of the visceral connectives, *i.e.* the **parietal** and **visceral** ganglia which lie close together, their connectives having shortened as much as is possible, form the posterior (upper) portion of the infra-oesophageal mass.

The following are the connectives which are revealed by sections through the peri-oesophageal mass:—

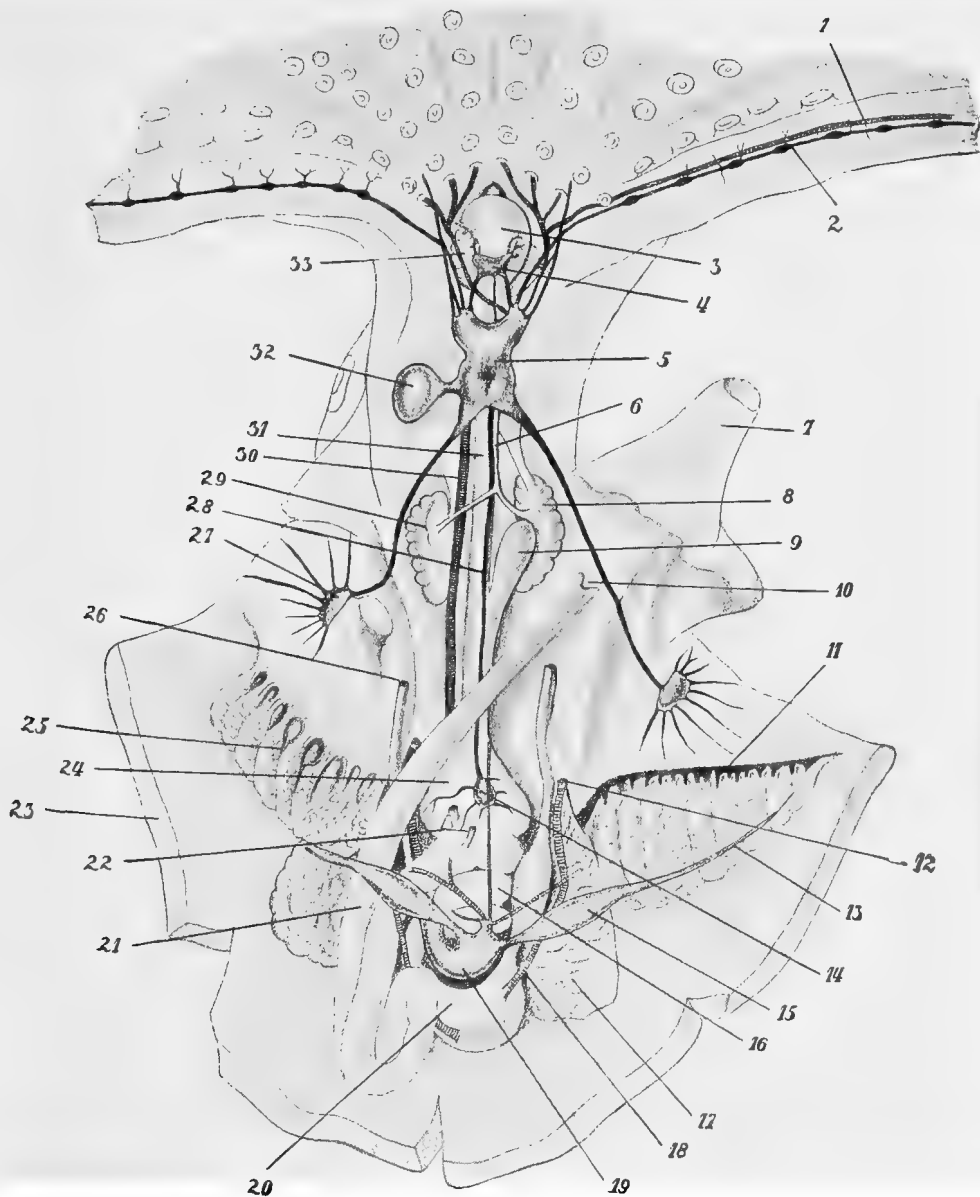

FIG. 127.—Anatomy of Octopus (after Leuckart and Milne Edwards). The body is cut open posteriorly, the mantle laid back to the right and left, and the liver removed. 1, Brachial artery; 2, brachial nerve; 3, pharynx; 4, buccal; 5, cerebral ganglion; 6, efferent duct of the upper salivary glands; 7, funnel; 8, upper salivary glands; 9, crop; 10, anus; 11, afferent branchial vessel (branchial artery); 12, left renal aperture; 13, efferent branchial vessel (branchial vein); 14, gastric ganglion; 15, left auricle; 16, spiral caecum of the stomach; 17, renal sac; 18, water canal; 19, ventricle; 20, ovary; 21, rectum; 22, efferent ducts of the digestive gland (liver), cut through near its opening into the intestine; 23, mantle; 24, stomach; 25, right tentidium; 26, aperture of the right oviduct; 27, stellate ganglion; 28, nerve to the gastric ganglion; 29, upper salivary gland; 30, aorta; 31, oesophagus; 32, optic ganglion; 33, lower salivary glands.

(1) Two cerebro-brachial; (2) two cerebro-infundibular; (3) two cerebropleural; (4) two brachio-infundibular; (5) two pleuro-infundibular; (6) two pleurobrachial connectives. The close proximity of the visceral ganglia to the peri-oesophageal mass makes it impossible any longer to distinguish the visceral connectives.

The **cerebral ganglia** give rise to the two optic nerves (which soon swell into the enormous optic ganglia at the bases of the eyes), the auditory nerves, the olfactory nerves (which for a certain distance fuse with the optic nerves), and the connectives of the buccal ganglia.

The **brachial ganglia** send off separate nerves to the arms, which nerves are connected by a hoop-like commissure round the base of the circle of arms. Running through the arms, the nerves swell into successive ganglia which correspond with the transverse rows of acetabula.

The separation of the pedal ganglion into a brachial and an infundibular ganglion can be proved ontogenetically and anatomically. There is no such separation in the male *Nautilus*, the brachial and infundibular nerves springing from one and the same ganglion. In *Argonauta* (Fig. 128, F) the separation is not externally visible, but in *Octopus* (E) we see the first traces of it; in *Sepia* (D), *Loligo* (C), and *Sepiolo* (B), it becomes more and more evident, till finally in *Ommatostrephes*

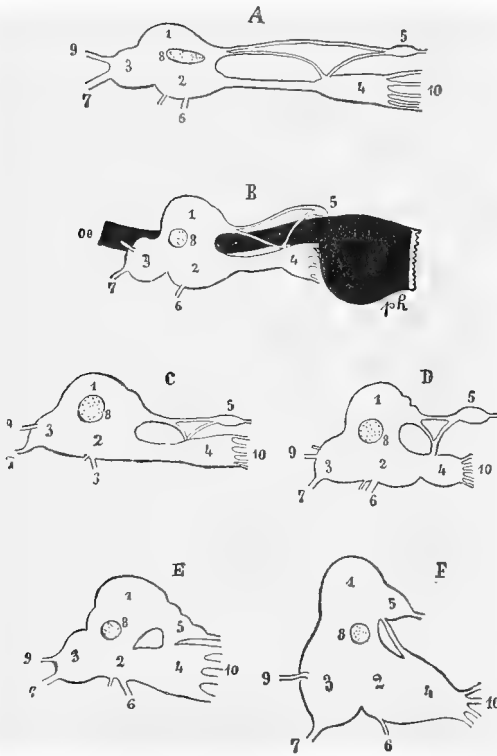

FIG. 128.—Central nervous system of various Dibranchia, from the right side. All the figures after Pelseneer. A, *Ommatostrephes*; B, *Sepiolo*; C, *Loligo*; D, *Sepia*; E, *Octopus*; F, *Argonauta*. 1, Cerebral; 2, pedal; 3, visceral; 4, brachial; 5, upper buccal ganglion; 6, infundibular nerve; 7, visceral nerve; 8, optic nerve cut through; 9, pallial nerve; 10, brachial nerves; and in Fig. B the pharynx (*ph*), and oesophagus (*oe*) are drawn in black.

(A) the distinct brachial ganglion has moved away from the infundibular ganglion, with which it is joined by a slender externally visible connective.

In this same series, the separation of the so-called upper buccal ganglion from the cerebral ganglion also takes place, the buccal remaining united to the brachial ganglion by the brachio-buccal connective.

The **parietal ganglia** give rise to the two large pallial nerves. Each of these runs backward and upward, and enters the **stellate ganglion** on the inner surface of the

mantle. Numerous nerves radiate into the mantle from this ganglion, one of them, which runs dorsally, looking like the direct continuation of the pallial nerve through the ganglion. The pallial nerve often divides into two branches sooner or later after it has left the parietal ganglion; one of the branches running to and through the stellate ganglion, to unite beyond it with the other branch which runs past the ganglion. The two stellate ganglia are often connected by a transverse commissure.

The **visceral ganglia** give off, near the middle line, two visceral nerves, which innervate the rectum, the ink-bag, the gills, the heart, the genital apparatus, the kidneys, and certain parts of the vascular system. The two genital branches of these nerves are connected by a commissure.

The **sympathetic nervous system** consists of a buccal ganglion lying beneath (behind) the œsophagus in the buccal mass; this ganglion is joined to the upper buccal or pharyngeal ganglion by a buccal connective. Two nerves run up along the œsophagus from the lower buccal ganglion to the gastric ganglion, which lies on the stomach, and innervates the greater portion of the intestine and the digestive gland (liver).

XIV. An Attempt to explain the Asymmetry of the Gastropoda.

1.

Chiastoneury, *i.e.* the crossing of the two pleuro-visceral connectives in the *Prosobranchia*, may be explained on the three following assumptions.

1. The ancestors of the *Prosobranchia* were symmetrical animals; the mantle cavity lay behind the visceral dome and in it the pallial complex, that is, the ctenidia, osphradia, nephridial apertures, genital apertures, and, in the centre, the median anus.

2. The visceral commissure or ganglion lay beneath the intestine.

3. The pallial complex shifted gradually from behind forward, along the right side of the body (*cf.* p. 136).

The position of the pallial complex in the *Tectibranchia*, among the *Opisthobranchia* on the right side, can also be thus explained. The pallial complex in its forward movement in these animals has either not yet reached the anterior position or, having reached it, has shifted back again.¹ The visceral connectives are therefore not crossed.

The above assumptions do not, however, explain—

1. The asymmetry which is brought about in some Gastropoda by the disappearance of one ctenidium, one osphradium, and one renal aperture.

2. The coiling of the visceral dome and shell, especially the dextral or sinistral spiral twist.

3. The relation existing between the manner in which the visceral dome and shell are coiled, on the one hand, and the special asymmetry of the asymmetrical organs (ctenidia, osphradia, nephridia, anus, genital organs) on the other.

4. The cause of the shifting forward of the pallial complex.

2.

It is unnecessary to discuss the first of the above assumptions, *viz.* that the ancestors of the Gastropoda were symmetrical animals, since all Molluscs except the Gastropoda are symmetrical, *i.e.* the *Amphineura*, the *Lamellibranchia*, the *Scaphopoda*, and the *Cephalopoda*.

¹ See note to § 13, p. 158.

The assumption that the pallial complex originally lay posteriorly is also well founded. In all symmetrical Molluscs, the anus lies as the centre of the complex posteriorly in the middle line, and further, in all symmetrical Molluscs, the nephridial and genital apertures lie posteriorly at the sides of the anus. When the ctenidia and osphradia have been retained in symmetrical Molluscs, they lie symmetrically on the posterior side of the visceral dome. This is the case in the *Cephalopoda*, and in the most primitive *Lamellibranchia*, the *Protobranchia* (*Nucula*, *Leda*, *Solenomya*), and even in some *Chitonidae*, and those *Solenogastres* which still have rudiments of gills.

In keeping with the posterior position of the pallial complex, the mantle fold which hangs down round the base of the visceral dome is, in symmetrical Molluscs, widest posteriorly where it has to cover the complex; at this part the mantle furrow deepens into a mantle cavity.

In connection with the second assumption, it still remains unexplained why in the *Amphineura* the commissure between the pleuro-visceral cords runs **over** the intestine; whereas on the other hand, in **all other symmetrical Molluscs**, the visceral ganglion lies, as in the *Gastropoda*, **below** the intestine.

3.

The third assumption, that the pallial complex has shifted forward, requires separate discussion.

If the pallial complex did thus shift forward, chistoneury must necessarily have taken place; the original left half of the complex must necessarily have become the present right half, and *vice versa*. Further, the right pleuro-visceral connective would have to become the supra-intestinal connective and the left the infra-intestinal connective; the original right parietal ganglion the supra-intestinal ganglion, and the original left parietal the infra-intestinal ganglion. But *why* did such a shifting take place? We shall here attempt to answer this question.

Cause of the shifting forward of the pallial complex.—We have assumed the symmetrical racial form of the *Gastropoda* (with posterior mantle cavity and sym-

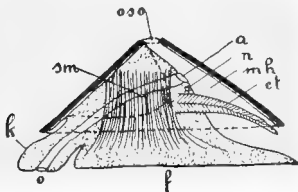

FIG. 129.—Hypothetical primitive *Gastropod*, from the side. *o*, Mouth; *f*, head; *sm*, shell muscle; *oso*, apical shell aperture; *a*, anus; *n*, renal aperture; *mh*, mantle cavity; *ct*, ctenidium; *f*, foot.

metrical pallial complex) to be a dorso-ventrally flattened animal with a broad creeping sole, a snout-like head with tentacles and eyes, and a somewhat flat cup-shaped shell covering the dorsal side of the body (Fig. 129). It therefore resembled in outward appearance a *Fissurella*, a *Patella*, or a *Chiton*, if we assume the imbricated shell of the last to be replaced by a single shell. The body of such a racial form was only protected dorsally by the shell. The hard surface along which the animal slowly crept served to protect its lower side, the dorsal shell being pressed firmly against the substratum, when necessary, by the contraction of a powerful shell muscle (cf. Fig. 106, p. 122). When the shell was thus pressed down, communication between the pallial cavity and the exterior (for the purpose of inhaling and exhaling the respiratory water, and ejecting the excreta, excrement, and genital products) was rendered possible by means of a cleft in the posterior edges of the mantle and shell.

Unlike their racial form, all known *Gastropoda* (except those whose body form has been secondarily modified, generally in connection with the rudimentation of the shell) are distinguished by the fact that the viscera with their dorsal integumental

covering protrude hernia-like in the form of a high spire-like visceral dome, with which the shell corresponds in shape. The uncoiled shell of every snail is as a matter of fact spire-shaped.

The development of such a shell and dome has already been recognised as due to the increased protection needed by the body when the capacity for creeping becomes developed. The whole of the softer part of the body can be withdrawn into such a shell, and, further to increase the protection, an operculum is often developed on the foot for closing the aperture of the shell, when the animal has retired into it. The shell muscle of the racial form no longer serves for pressing the shell against the surface on which it rests, but for withdrawing the head and foot into the shell. It becomes the columellar muscle (Fig. 131, *sm*).

Taking in turn the different stages in the development of the Gastropod

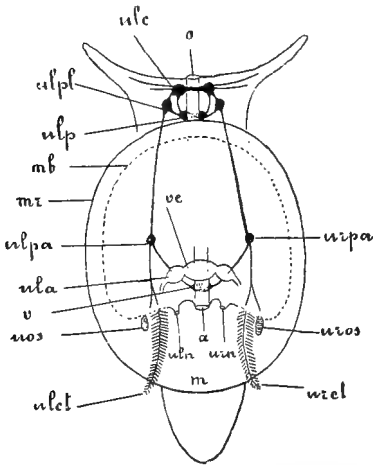

FIG. 130.—Hypothetical primitive Gastropod, from above. *o*, Mouth; *ulc*, *ulpl*, *ulp*, original left cerebral, pleural and pedal ganglia; *ulpa*, *urpa*, original left and right parietal ganglia; *ula*, original left auricles; *uos*, *uros*, original left and right osphradia (Spengel's organs); *ulet*, *urct*, original left and right ctenidia (gills); *mb*, base of the mantle; *mr*, edge of the mantle; *m*, mantle cavity; *v*, visceral ganglion; *ve*, ventricle; *a*, anus.

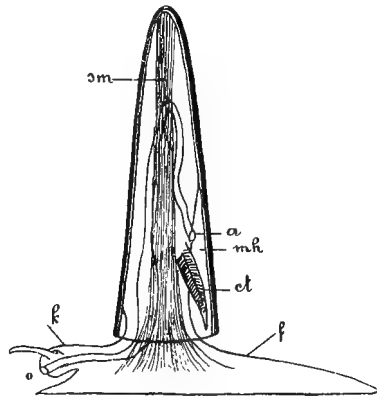

FIG. 131.

(Lettering in this and in the following three figures the same as in Fig. 129.)

shell, we have as the first and most important its dorsal spire-like prolongation. In this way the cup-shaped shell of the racial form becomes a high conical shell like that of *Dentalium*.

Such a shell carried vertically by the animal (Fig. 131) would, when the latter is at rest, be in a state of unstable equilibrium, which would be upset by movement or by the slightest pressure from without. It is also evident that when the animal is in motion a vertically placed spire-like shell would be extremely awkward.

If we assume the shell to be carried at some other angle to the body, we have the following possible positions:—

1. The shell might be carried inclined forward (Fig. 132). Such a position is the most unfavourable imaginable for locomotion, for the functions of the mouth, and for the sensory organs on the head.

On the other hand, such a position is the most favourable imaginable for the functions of the organs belonging to the posteriorly placed pallial complex, which now lie dorsally, since in this position the mantle cavity is subjected to least pressure

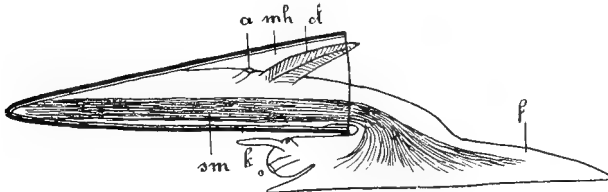

FIG. 132.

from the viscera and from the columellar muscles. The downward pressure of the visceral mass which now takes place would tend indeed to widen the cavity.

2. The shell might be carried inclined backwards (Fig. 133). This position is the most favourable imaginable for locomotion and for the functions of the organs

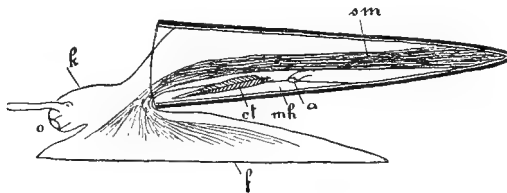

FIG. 133.

of the head, which would thus be free on all sides. It is, however, the most unfavourable imaginable for the functions of the organs of the pallial complex, which now lie *beneath* the visceral dome. The mantle cavity has to bear the whole pressure of the visceral mass, and especially that of the columellar muscle; it would

be squeezed together, so that the circulation of the respiratory water would be prevented or at least rendered more difficult, as would also the ejection of the excreta, excrement, and sexual products.

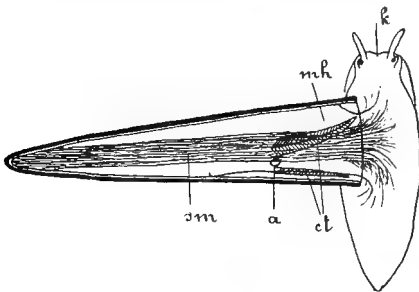

FIG. 134.

3. Finally, the shell may be carried inclined to the right or left (Fig. 134). This is neither the most favourable nor the most unfavourable position for locomotion, for the head, and for the pallial complex. It is an imaginable intermediate position.

In this position there is no dead point, as shifting of the parts would always be possible, and the shell be enabled to take up the position most suitable for locomotion and for the functions of the cephalic organs, and the mantle cavity that best suited for the exercise of the functions of the pallial complex lying within it.

Assuming that the shell is inclined to the left (Fig. 135), the pressure brought to bear on the mantle cavity would vary in amount in different areas of that cavity. It would be greatest on the left side, and would continually decrease towards the

right. On the left there would be a pressure from the front which would, so to speak, squeeze out the pallial complex backwards over to the right. It must further be noted that the point subjected to least lateral pressure and to the greatest downward pull lies on the right, which has become the upper side of the visceral dome. At this point the mantle furrow will most easily deepen, and become more spacious. Into such a deepening the organs of the pallial complex which are being pressed from the left have room to move forward to the right. Here we have the first step in the shifting forward of the pallial complex along the right mantle furrow. Further, as soon as the least shifting of this sort has taken place, the shell and visceral dome can move slightly from their present position on the left, towards that backward position which we have seen to be the most favourable imaginable for locomotion and for the functions of the cephalic organs.

If we suppose this process gradually to be completed, the shell and visceral dome finally gain the most favourable backward position, and the pallial complex is gradually shifted forwards along the right mantle furrow. The pallial complex thus lies anteriorly on the upper side of the visceral dome, which now points backwards. This anterior position is that of the least upward pressure, or rather of the greatest downward pull, *i.e.* it is the point at which the mantle cavity can most easily deepen and widen, and where the pallial organs can best fulfil their functions.

The position of the shell and the pallial complex characteristic of the Gastropoda is now attained, and with it chiastoneury and the inverse position of the organs of the pallial complex.

4.

The second stage in the development of the Gastropod shell is the coiling in one plane of the visceral dome and shell.

If the Gastropod visceral dome assumes the most favourable inclined position above described, it will, under normal conditions, change its conical shape. The side which lies uppermost will become arched and the lower side concave. This change of form is caused by the stronger growth of the integument of the visceral dome and mantle on that side, which, in the inclined position of the visceral dome, is the most stretched or pulled. The visceral dome also becomes curved in one plane, and the shell naturally adapts itself to the changes of shape of the dome. Again, the shell could not remain conical, because a large part of the dorsal integument (base of the visceral dome) would then be uncovered, and in consequence of the increase of those

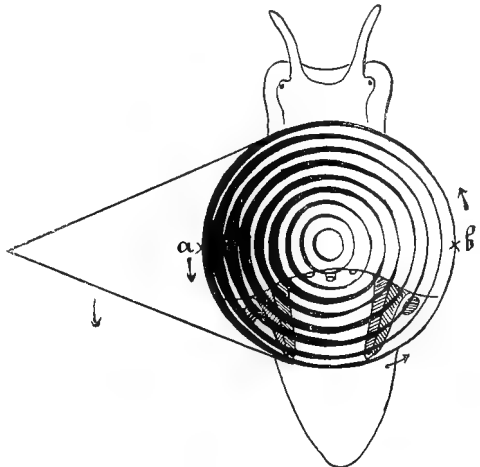

FIG. 135.—Diagram illustrating the variations of pressure to which the shell and visceral dome are subjected when inclined to the left. The thickness of the concentric lines indicates the amount of the pressure. *a*, Point of greatest pressure; *b*, point of least pressure. The arrows give the direction in which shifting takes place. It is evident that the left side of the pallial complex is subjected to greater pressure than the right.

parts of the body not covered by the shell there would come a time when the body could no longer be completely withdrawn into it.

5.

Before discussing the third stage in the development of the Gastropod shell, we must consider its growth. This, from a geometrical point of view, is of three kinds: growth in height, peripheral growth, and radial growth or increased thickness of the shell wall. This last does not here concern us.

Supposing, for simplicity's sake, the shell to be conical, growth in height occurs at the base (or aperture of the shell), and takes place by means of continual deposits of bands of new material at the edge of the aperture, by the growing edge of the mantle.

Peripheral growth is the enlargement of the circumference of the base or aperture of the shell.

If the height and the peripheral growth remain uniform round the whole aperture of the cone (which is assumed to be round), the cone increases without altering its shape.

If, however, the growth in height is not uniform, but steadily and symmetrically increases along each side from an imaginary minimum point to a diametrically opposite maximum point, the peripheral growth, however, remaining uniform, a spirally twisted hollow cone is produced.

If the minimum and maximum points in this growth continue throughout in one and the same plane, a symmetrical shell coiled in this plane of symmetry results.

If, however, as growth increases, the maximum point shifts from the symmetrical plane, say to the left (the minimum point shifting in the opposite direction to the right), the maximum and minimum points no longer trace on the spirally coiled shell straight but spirally twisted lines, and the conical shell is then not coiled symmetrically in one plane, but asymmetrically in a screw-like spiral. We then have what conchologists call a dextrally twisted shell.

The growth of the Gastropod shell actually takes place in this last manner.

6.

This, the dextral (or sinistral) coiling of the Gastropod shell, is the last stage to be discussed. If the visceral dome and shell which are twisted in one plane pass, in growth, from an incline to the left to a backward incline, this is equivalent to the continual shifting of the point of maximum growth to the left and that of minimum growth to the right; the necessary consequence being a dextral screw-like spiral twist.

It must be borne in mind—

1. That the peripheral growth remains constant, *i.e.* that the outline of the growing edge of the mantle remaining uniform, the increasing aperture of the shell also retains the same form.

2. That the additions to the shell by the mantle edge are made in the form of bands of new material, the already formed firm shell not altering in shape.

3. That the growing edge of the mantle, which secretes the shell substance, does not, in the course of the gradual change from the left to the backward incline, itself become twisted, but retains its position in relation to the rest of the body. It is thus only the maximum and minimum points of growth in height which become shifted along the edge of the mantle.

4. It must be noted that this description of the manner in which a dextrally twisted shell arose only applies to that stage in the ontogenetic or phylogenetic

development of the shell during which its displacement in a backward direction and the shifting forward of the pallial complex occur. When once the result most favourable to the animal, *i.e.* the anterior position of the mantle cavity and the backward direction of the shell, are attained, further displacement, which would be disadvantageous, does not take place. It is, then, not at first sight evident why, when the need for displacement ceases, its action still continues, *i.e.* why, though displacement ceases, the visceral dome and shell continue to grow in a dextral twist and not symmetrically. This point will be explained below.

7.

For the sake of clearness we have treated separately the three important factors in the development of the Gastropod shell, viz. (1) the formation of a tall conical shell, (2) the spiral coiling of the same, and (3) the special manner of coiling in a dextral twist. In reality these three factors do not denote special stages, but all operate simultaneously. The continually increasing protrusion of the visceral dome was accompanied by the dextral twist, as a consequence of the twisting of the visceral dome from its incline to the left to the most favourable backward incline, by which the pallial complex was shifted forward.

8.

The results of ontogenetic research favour the theory here advanced. We have first to note the fact that the anus (the centre of the pallial complex) and the mantle fold originally lie posteriorly. They come to lie anteriorly in the embryo not by active shifting, but by the cessation of growth on the right side between the mouth and anus, and its continuation on the left side. There is, however, no difficulty in harmonising this ontogenetic method of gaining the object with the phylogenetic method.

9.

So far we have placed mechanical and geometrical considerations in the foreground. But these necessarily coincide with utilitarian considerations. Every alteration in the direction we have been considering means an improvement in the organisation of the animal, an advantage to enable it the better to maintain the struggle for existence. The formation of a spire-like shell, which has been recognised as the starting-point in the development of the asymmetry of reptant Gastropods, was the only method by which complete protection of the whole body could be attained, and must therefore be considered to have been advantageous under the circumstances. We might further conclude this from the fact that the possession of such a shell actually distinguishes the Gastropoda from the primitive Mollusca, which the *Chitonidae* are rightly considered most nearly to represent.

10.

One apparently important objection to the theory here set forth must be mentioned. If the first factor in the asymmetry of the Gastropod body is the development of a high spire-like shell, and if the arrangement of the nervous system is necessarily connected with the coiling of the shell in a definite direction, how can we account for forms such as *Fissurella*? This Diotocardian genus actually belongs to the most primitive Gastropods, because the symmetry of the pallial complex is still retained. But it possesses an asymmetrical nervous system and the typical chistoneury of the *Prosobranchia*, and nevertheless a flat cup-shaped symmetrical shell. We thus have secondary characteristics of the inner organisation combined with an

apparently primitive shell. The latter is, however, only *apparently* primitive, as can be proved systematically and ontogenetically. The forms most nearly related to *Fissurella*, such as the primitive genus *Pleurotomaria* (Fig. 136 A), *Polytremaria* (Fig. 136 B), and *Scissurella*, have spacious spirally coiled dextrally twisted shells. In *Haliotis* (Fig. 136 D) the shell becomes flat and the coiling indistinct, as is also the case to some extent in *Emarginula* (Fig. 136 C), till finally in *Fissurella* (Fig.

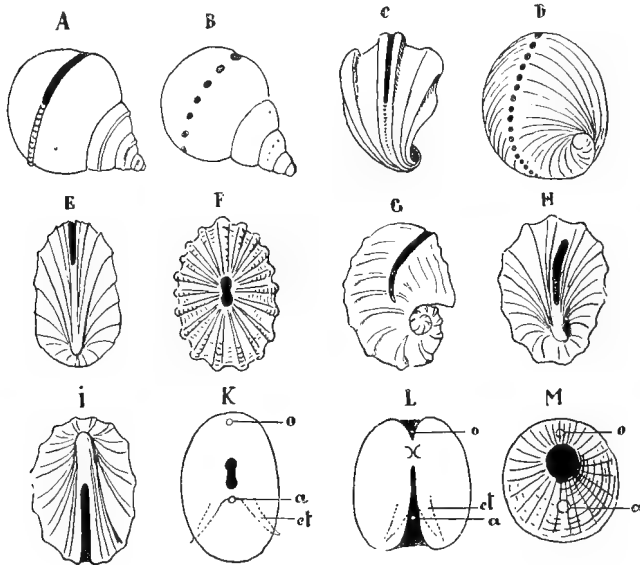

FIG. 136.—Shells of A, *Pleurotomaria*; B, *Polytremaria*; C, E, *Emarginula*; D, *Haliotis*; F, *Fissurella*; G, H, stages in the development of the shell of *Fissurella*; I, shell of the Gastropod racial form, with marginal cleft; K, the same, with apical perforation; L, *Lamellibranch* shell; M, shell of *Dentalium*, seen from the apical cleft. The shell clefts and perforations are black. o, Mouth; a, anus; ct, etenidium.

136 F) it again secondarily becomes flattened or cup-shaped and symmetrical. *Fissurella* even passes ontogenetically through an *Emarginula* stage, in which the shell is distinctly spirally coiled (Fig. 136 G, H). We may therefore conclude, with as much certainty as is possible in morphological questions, that the outwardly symmetrical *Fissurella* descends from forms with high spirally coiled shells. Its return to a flat symmetrical shell may have been determined, as in the *Patellidae*, *Capulidae*, etc., by adaptation to certain biological conditions.

11.

The explanation given above seems to throw new light on many as yet unsolved problems in the morphology of the Mollusca, such as the asymmetry of the pallial complex in most Gastropoda. Many *Diotocardia*, all *Monotocardia*, all *Opisthobranchia*, and all *Pulmonata* show marked asymmetry in the pallial complex. The asymmetry consists principally in the absence of one gill, one osphradium, and one nephridial aperture. The inner organisation also shows reflections of this asymmetry in the nervous system, and the absence of one kidney and one auricle. On closer inspection, it is found that it is the original left half of the pallial complex

(which in a *Prosobranch* would lie to the right in the mantle cavity near the anus) which is wanting. The anus is no longer the centre of the pallial group of organs, but lies outermost on one side. While in the *Prosobranchia*, for example, the original left half of the pallial complex (which would now lie on the right) has disappeared, those organs of the complex (the original right) which are retained, shift from the left to occupy the empty space. Consequently, we find the anus no longer anteriorly in the middle line, but on the right side, close to the extreme right of the mantle cavity.

But what is the reason of the disappearance of the left half of the pallial complex in the *Monotocardia*, *Opisthobranchia*, and *Pulmonata*?

In answering this question we must refer back to paragraph 3, where it was seen that if the spire-like shell assumes the only possible lateral inclination, the mantle cavity and the pallial complex within it are subjected to unequal pressure. If the shell is inclined to the left, the side of the posterior mantle cavity subjected to the greatest pressure is the left, and the pressure continually decreases towards the right. These variations of pressure are also retained during the whole time in which the backward displacement of the shell and the forward displacement of the pallial complex takes place. In other words, *i.e.* described in terms of our theory, from the very commencement of the development of the Gastropod organisation, the original left organs of the pallial complex were subjected to unfavourable conditions. In this left-sided compression of the mantle cavity the ctenidium especially would necessarily be reduced in size and become rudimentary, and might entirely disappear.

As a matter of fact, the original left half of the pallial complex (which would now lie on the right) has entirely disappeared in many *Diotocardia* (the so-called *Azygobranchia*), in all *Monotocardia*, and in the *Opisthobranchia*. The fact that the original right gill, the only one remaining, has also disappeared in the *Pulmonata* is accounted for by the change to aerial respiration. It is an interesting fact that in the *Basommatophora* the original right osphradium is retained.

If, however, the original left gill did not quite disappear, but only became smaller, we should have to expect that in such *Diotocardia* as still possess two gills, the original left (now the right) would be the smaller. This would be the case at least in the more primitive forms with shells still twisted. *Haliotis* and *Fissurella* are the only Molluscs to which this applies. In *Haliotis*, whose shell is still twisted, the right (originally left) gill is in reality the smaller. But in *Fissurella* and *Submarginula*, where the asymmetry of the mantle cavity has been secondarily lost, the inequality in the size of the gills has also disappeared.

12.

Another unsolved problem remains. Why does the shell continue to grow asymmetrically coiled with a dextral twist, after the cause of this asymmetry, *viz.* the change from the incline to the left to the backward incline of the shell, simultaneously with the shifting forward of the mantle cavity and pallial complex, has ceased to act, *i.e.* when the shell has definitely assumed the posterior, and the pallial complex the anterior, position? The explanation of this lies in the asymmetry so early apparent in the mantle cavity, which from the beginning is more spacious to the right (now left) than to the left, the consequence being that the left half of the pallial complex atrophied. This asymmetry of the pallial complex and mantle cavity remained after the displacements of shell and pallial complex had been definitely accomplished in the *Prosobranchia*, *i.e.* the asymmetrical growth, and therefore the continuous coiling of the visceral dome and shell in a spiral twist, continued.

In altogether exceptional conditions, which rendered a flat cup-shaped shell

useful, the return to symmetry in the pallial complex and mantle cavity or fold would be advantageous, since then symmetrical growth of the shell could take place. If the difference between the maximum and minimum growth in height is but slight the shell would be but slightly coiled, and if the peripheral growth is pronounced, while the growth in height is insignificant, a flat cup-shaped shell would result (*Haliotis*, *Emarginula*, *Fissurella*, *Patella*, etc.).

13.

Chiastoneury only takes place when the original right half of the pallial complex crosses over to the left of the median line anteriorly.

This crossing of the line of symmetry has actually taken place in the *Prosobranchia*. The original right gill in them lies quite to the left of the mantle cavity. In the *Azygobranchia* and *Monotocardia* the hind-gut with the anus has at the same time become displaced into the right (original left) narrower gill-less half of the mantle cavity, which, however, is still spacious enough to contain the rectum. The *Prosobranchia* are **streptoneurous**.

In the *Tectibranchia* and *Opisthobranchia* the pallial complex is found on the right side of the body, and has nowhere crossed the median line anteriorly. There is therefore no chiastoneury among the *Opisthobranchia*, i.e. their visceral connectives are never crossed.¹

In the *Pulmonata* the pallial complex has shifted far forward, but it has not passed the middle line with any organ which, drawing the parietal ganglion and the visceral connective with it, could have brought about chiastoneury. For the left (original right) gill, the only one elsewhere retained, disappeared (apparently very early) in the *Pulmonata*. The osphradium, which is retained in aquatic *Pulmonata*, is the original right, and still lies on the right side. In considering the arrangement of the nervous system, it is really immaterial whether we assume that the hind-gut

has shifted back to the right secondarily, and the osphradium moved to near the respiratory aperture, or that the hind-gut never reached the median line, and that the osphradium never passed over it. The *Pulmonata* are thus **euthyneurous**.

14.

We saw, in paragraph 3, that with a strongly developed visceral dome and posteriorly placed pallial complex, a shell inclined forward or coiled forward is an impossibility for a reptant Gastropod. But such

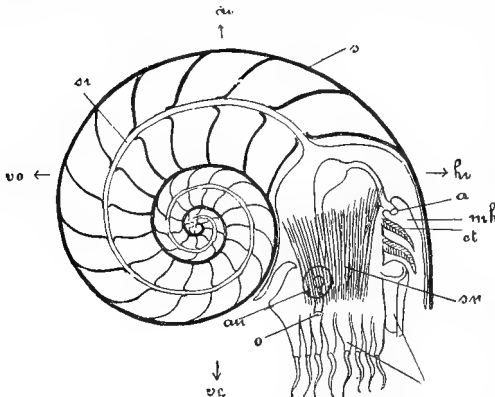

FIG. 137.—*Nautilus*, diagram. *do*, Dorsal; *ve*, ventral; *vo*, anterior; *hi*, posterior.

a shell is not an impossibility for an animal which does not creep. For example, in a swimming animal, whose shell, partly filled with air, serves as a hydrostatic apparatus, there is no reason why a much developed visceral dome and shell should

¹ Except in *Acteon*, an exception which makes it probable that in the *Opisthobranchia* the pallial complex has secondarily returned from an anterior position.

not become coiled forward, the original posterior position of the pallial complex being retained as the most favourable under such circumstances. As an example of this we have the *Nautilus*, all *Nautiloidea* and *Ammonoidea*, with their **exogastrically** (anteriorly) coiled shells and posteriorly placed pallial complexes (Fig. 137).

The coiling of the shell of *Spirula* forms an exception to that of all other *Mollusca*, being **endogastric**. With regard to this we have to consider first, that the shell of *Spirula* is internal and rudimentary, and that the backward coiling does not in any way affect the posteriorly placed mantle cavity; and second, that only the *modern* genus *Spirula* has such a shell. The Miocene genus *Spirulirostra* has its phragmacone endogastrically bent but not coiled, and the older *Belemnitida* never have either curved or coiled shells. Moreover, the shell of this whole group, being internal and, as far as the original purpose of a shell, protection of the body, is concerned, rudimentary, does not come under consideration in the present discussion.

15.

In an animal living in mud, like a limicolous bivalve, there appears no reason

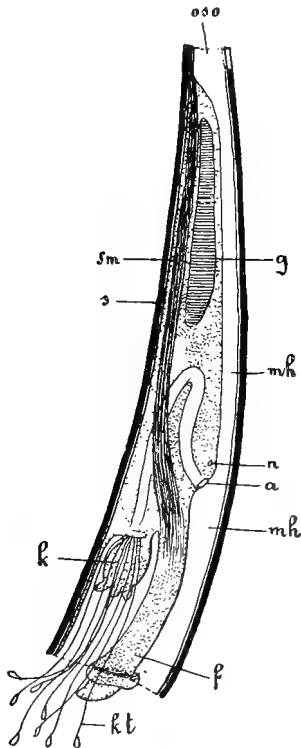

FIG. 138.—*Dentalium*, diagram from the left side. *g*, Genital gland; *kt*, cephalic tentacles.

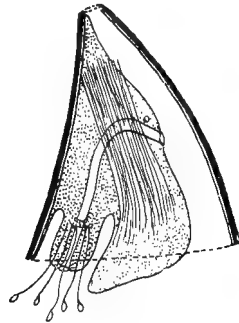

FIG. 139.—Hypothetical transition form between *Dentalium* (Fig. 138) and the racial form of the Gastropoda (Fig. 140), from the left side.

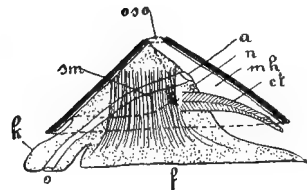

FIG. 140.—Hypothetical racial form of the Gastropoda, from the left side.

why the shell should not simply become elongated, and why the mantle cavity and pallial complex should not retain the posterior position. *Dentalium* (Fig. 138) is

distinctly in this condition, being the symmetrical primitive Gastropod adapted to life in mud, and provided with a turret-like shell and posterior pallial complex. The perforation at the upper end of the shell, which freely projects from the mud, is of great morphological importance, corresponding physiologically with the siphons of the limicolous *Lamellibranchia*. A comparison between *Dentalium* and a *Fissurella* with its pallial complex twisted back, and with a long and turret-like shell, is, from our point of view, very appropriate. A *Fissurella*, so transformed, would almost exactly resemble the hypothetical symmetrical racial form of the Gastropoda, in which, however, we should have to assume a mantle- and shell-cleft reaching to their edges (*cf.* Fig. 136, I).

The anatomy of the *Protobranchia*, which has recently been more closely studied, and especially the posterior position of the two gills, the flat sole for creeping, and the presence of the pleural ganglia, justify us in deriving the *Lamellibranchia* also from the racial form of the Gastropoda, in which the cleft edge of the mantle would correspond with the posterior or siphonal edge of the mantle in the former. This edge of the mantle, having a similar physiological function, often possesses tentacles, papillae, etc., in both groups.

Dentalium further fits in with our theory, for the forward curve and the position of the columellar muscle on the anterior side of the visceral dome which would be disadvantageous to a freely reptant, is not so to a limicolous, animal.

16.

The Dextral and Sinistral Twists.

Most Gastropods have the visceral dome and shell twisted dextrally. The direction of the twist has been determined by the fact that the visceral dome and shell originally inclined to the left, and then more and more backward, thus pushing the pallial complex along the right mantle furrow. It cannot be determined why the incline to the left was originally chosen. The shell might just as well have inclined to the right at first, and then more and more backward, pushing the pallial complex along the left mantle furrow. The consequent asymmetry would then have been exactly reversed. To take a concrete example: in a *Monotocardian*, with visceral dome and shell twisted sinistrally, the original left parietal ganglion would become the supra-intestinal ganglion on the right. The original right half of the pallial complex would disappear, and the left half which persisted would lie to the right of the anus or rectum, which would take up its position to the left of the median line.

Gastropoda with sinistrally twisted shells are actually known, many of them having the asymmetrical organs in the inverse position which corresponds with this twist. Such are, among the *Prosobranchia*, *Neptunca contraria*, *Triforis*, and occasional specimens of *Buccinum*; among the *Pulmonata*, *Physa*, *Clausilia*, *Heliceter*, *Amphidromus*, and occasional specimens of *Helix* and *Limnaea*. In *Bulinus per-versus*, individual specimens with either sort of shell are found, with the special asymmetry of the organs belonging to it.

17.

There are, however, snails whose shells are dextrally twisted, but which possess the organisation of animals with sinistrally twisted shells. This is the case among the *Prosobranchia* in the sinistrally twisted sub-genus *Lanistes* of the genus *Ampullaria*; among the *Pulmonata*, in *Choanomphalus Maacki* and *Pompholyx solida*; among the *Opisthobranchia*, in those *Pteropoda* which, whether as adults (*Limacinae*) or larvæ (*Cymbuliidae*), have a twisted shell. This fact is entirely against our theory in explanation of the asymmetry of the Gastropoda, for this theory

points to a causal connection between the spiral coiling of the visceral dome and shell on the one hand and the special asymmetry of the asymmetrical organs on the other. The above-mentioned exceptions to the rule can, however, be explained as follows. The spiral of a dextrally twisted shell can by degrees become flattened in such a way that the shell may be simply coiled in one plane or may nearly approach that condition. In this case the spiral might again assert itself, but on the side

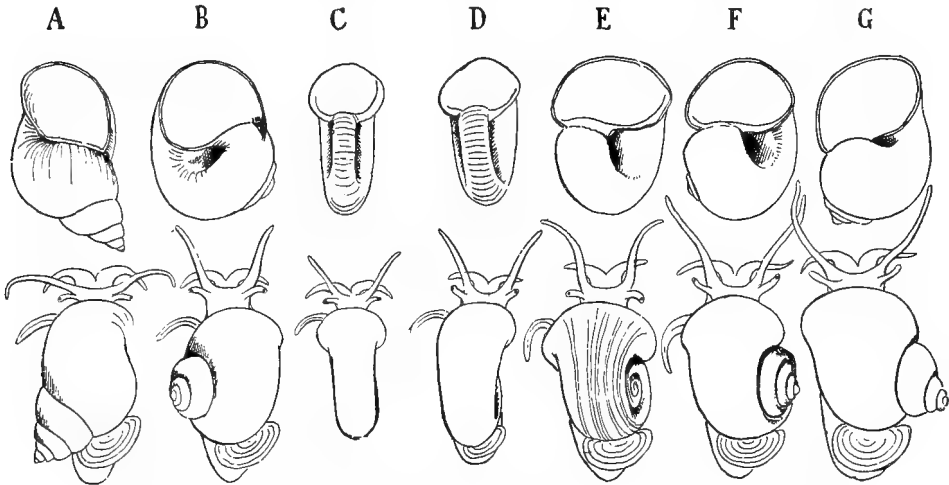

FIG. 141.—Seven forms of *Ampullaria* shells (diminished in various degrees), seen in the upper row from the aperture of the shell, in the lower from the dorsal side. The head, foot, and operculum are arbitrarily drawn merely for the purpose of facilitating a comparison between dextrally and sinistrally twisted shells.

opposite to that on which the umbilicus originally lay, and in this way a false spiral might form on the umbilical side and a false umbilicus on the spiral side.

The transition from a dextrally twisted to a falsely sinistrally twisted shell, which latter was, however, genetically dextrally twisted, is illustrated in Fig. 141 by means of the shells of seven species of the genus *Ampullaria*. *Ampullaria Swainsoni* Ph? (G) and *A. Geveana* Sam (F) are dextrally twisted with distinctly projecting spiral. In *A. crocastoma* Ph (E) the spiral is flat, in *A. (Ceratodes) rotula* Mss. (D) and *A. (Ceratodes) chiquitensis* d'Orb (C) the spiral is already pushed through or sunk, yet we find a true umbilicus on the umbilical side. In *A. (Lanistes) Boltieniana* Chemn. (B), and still more in *A. purpurea* Jon. (A), the false spiral appears on the umbilical side, and on the spiral side a false umbilicus is found.

However plausible this explanation may appear, it can only be proved to be correct if it is found that where a spiral operculum occurs, the direction of its spiral is opposite to that of the spiral of the shell (Fig. 142, A, B, C), and the commencement of the spiral is always turned to the umbilical side of the shell.

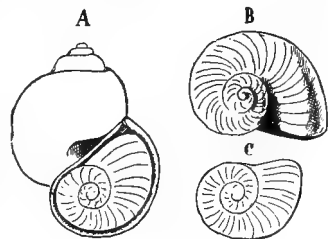

FIG. 142.

Lanistes has not a spirally twisted In those *Pteropods* which combine a

sinistrally twisted shell with the organisation belonging to a dextrally twisted Gastropod, the operculum exactly corresponds with that of a dextrally twisted shell. In *Peractis*, in the larvæ of the *Cymbuliidae* and in *Limacina retroversa* Flemming, the operculum (the free surface of which must be viewed) is sinistrally twisted, and the starting-point of the twist faces the (false) spiral, which in these falsely sinistrally twisted Gastropods lies in the place of the original umbilicus.

This apparent exception is thus shown to be quite in keeping with the rule above established.

XV. The Sensory Organs.

A. Integumental Sensory Organs.

In the integument of the Mollusca there are epithelial sensory cells (**Flemming's cells**), which vary in number and arrangement, and may be scattered over large areas. Two kinds of these cells may be distinguished according to their form. One kind, which is found only in *Lamellibranchs*, consists of large epithelial cells with large terminal plates which form part of the body surface and carry tufts of projecting sensory hairs ("paint-brush cells," Pinsel-Zellen). The second kind of cells are found in all classes of Mollusca. They are long, filiform, or spindle-shaped, swelling at one point where the nucleus lies. They sometimes carry a tuft of sensory hairs, sometimes none. Each kind of cell is continued at its base into a nerve fibre, which runs into the nervous system. A distinct specific function can hardly be attributed to these epithelial cells. They may respond to very various stimuli, chiefly mechanical and chemical, and thus may act in an indefinite way as tactile, olfactory, and gustatory cells.

They may become more specialised in function, when crowded together in certain areas of the body, and may then represent special sensory organs. Between the individual cells composing such a sensory organ, however, other epithelial cells (glandular, ciliated, and supporting cells) are always found.

1. Tactile Organs.

The tactile function of the integumental sensory cells is likely to assert itself at exposed parts of the body surface, such as the tentacles, epipodial processes, siphons, at the edge of the mantle in the *Lamellibranchia*, and at the edge of the foot, etc. We cannot, however, assume that even in these places the sensory cells are sensitive *only* to mechanical stimuli.

2. Olfactory Organs.

(a) The Osphradium.

As has been proved to be the case in the *Prosobranchia*, sensory cells occur scattered among the other epithelial cells throughout the whole

epithelial lining of the mantle cavity. Here, as in other parts of the body, three kinds of epithelial cells can be distinguished: (1) undifferentiated cells, which may contain pigment, and are usually ciliated; (2) glandular cells; (3) sensory cells. The proportions in which these three kinds of cells appear varies in different regions of the mantle. If glandular cells prevail on a certain area, that area assumes a glandular character, and may even develop into a sharply localised epithelial gland (*e.g.* the hypobranchial gland). On the gills, undifferentiated ciliated cells predominate. Where sensory cells predominate a sensory character is given to the region; such a region, if sharply circumscribed, the sensory cells continually increasing in number, becomes a pallial sensory organ. The gradual development and continuous differentiation of such an organ may be particularly well traced in the *Prosobranchia*, the sensory organ developed being the osphradium. In consequence of its position in the mantle cavity, and especially on account of its proximity to the gill, it has been assumed that its principal function is to test the condition of the respiratory water, or, in other words, that it is an olfactory organ.

The osphradium among the *Prosobranchia* is least differentiated in the *Diotocardia*. In the *Fissurellide* it does not exist as a sharply localised organ. In the *Monotocardia* it becomes more and more differentiated, and has a special ganglion, and finally in the *Toxiglossa*, it reaches the maximum of its development.

A review of the position and number of the osphradia has already been given in another place (§ V. p. 71). As an example of the special form and structure of this organ we select the highly developed osphradium of a *Toxiglossa*, *Cassidaria tyrrhena*.

The **osphradium of Cassidaria** is a long organ, pointed at both ends, which lies to the left of the ctenidium on the mantle in the mantle cavity. As in other highly specialised *Monotocardia* (Fig. 71, p. 73) it looks like a gill feathered on both sides, and has on that account been regarded and described as an accessory gill. It consists of a ridge rising from the mantle, which in transverse section is almost square, and carries on each side 125 to 150 flat leaflets, which stand at right angles to the surface of the mantle, and are so closely crowded that their surfaces are in contact. The ridge consists almost exclusively of the long osphradial ganglion. Each leaflet receives from this ganglion a special nerve, which runs along its lower projecting edge, and sends off four principal branches into it. In its dorsal pallial side each leaflet contains blood sinuses, which communicate with a sinus lying above the ganglion in the ridge.

These principal nerves in the leaflets branch, and their last and finest ramifications penetrate the supporting membrane between the epithelium and the sub-epithelial tissues. These become connected with the branches of the interepithelial ganglion cells, each of which again is connected with a spindle-shaped epithelial sensory cell. The branched interepithelial cells are connected together by their processes.

The sensory epithelium above described is developed on the lower surfaces of the osphradial leaflets, *i.e.* those turned to the mantle cavity, the indifferent, non-ciliated cells on these surfaces being filled with granules of yellow pigment, while in the upper surfaces of the leaflets these cells are devoid of pigment and ciliated. Glandular cells are also found definitely arranged in the epithelium of the osphradial leaflets.

The osphradial nerve usually springs from the pleuro-visceral connective (from the parietal ganglion when this is present); in the *Lamellibranchia* it comes from the parieto-visceral ganglion. The osphradial nerve is generally a lateral branch of the branchial nerve.

In the *Lamellibranchia*, the important fact has been demonstrated that, although the osphradial nerve comes from the parieto-visceral ganglion, its fibres do not actually rise from this ganglion; but they pass along the pleuro-visceral connective and have their roots in the cerebral ganglion.

(b) Olfactory Tentacles.

Certain experiments, to which, however, some exception might be taken, seem to show that the large optic tentacles of terrestrial *Pulmonata* are also olfactory. It is also generally accepted, though still not certainly established, that the posterior or dorsal tentacles (rhizophores) of the *Opisthobranchia* are olfactory organs. These rhizophores (Fig. 93, p. 98) often show increase of surface, usually in the shape of more or less numerous circular lamellæ surrounding the tentacle like a collar. The rhizophores are also often ear-shaped or rolled up conically. Not infrequently they can be retracted into special pits or sheaths. They are innervated from the cerebral ganglion by means of a nerve which forms a ganglion at the base of each.

At the lateral and lower edge of the cephalic disc of the *Cephalaspidea*, an organ which is considered to have arisen by the fusion of the labial and cephalic tentacles, there are structures which are thought to be olfactory, and which, where most developed, take the form of several parallel "olfactory lamellæ" standing up on the disc.

(c) Olfactory Pits of the Cephalopoda.

In the *Dibranchia* there is on each side, above the eye, a pit which is considered to be olfactory. Its epithelial base consists of ciliated and sensory cells, and underneath it lies, close to the optic ganglion, an olfactory ganglion. The nerves running to this ganglion come from the ganglion opticum, but really originate in the cerebral ganglion. It looks as if these olfactory organs were the remains of the posterior tentacles of the *Gastropoda*, and were comparable with the rhizophores of the *Opisthobranchia*. In *Nautilus* the place of the olfactory pit is occupied by the upper optic tentacle. We have already seen that *Nautilus* still retains true osphradia.

(d) The Pallial Sensory Organs of the Lamellibranchia.

Several *Asiphoniata* have, in addition to the osphradia, epithelial sensory organs, which lie on small folds or papillæ to the right and left of the anus, between it and the posterior end of the gill. These are innervated by a branch of the posterior pallial nerve.

Epithelial sensory organs of various forms (plates of sensory epithelium, sensory lamellæ, or papillæ, tufts of small tentacles) are found on the mantle in the

Siphoniata; these lie on the retractor muscles of the siphons and at the base of the branchial siphon. These pallial sensory organs also are innervated by the posterior pallial nerves, and may correspond with the anal sensory organs of the *Asiphoniata*. Their function is unknown, but is supposed to be analogous to that of the osphradia.

(e) Olfactory Organs of the Chitonidæ.

In the mantle furrow of the *Chitonidæ* there are epithelial sensory organs which are considered to be olfactory. These are ridges and prominences with extraordinarily high epithelium, consisting of glandular cells and thread-like sensory cells. In *Chiton lævis* and *C. cajetanus* there are, on each side of the mantle furrow, two sensory ridges extending along the whole length of the row of gills; one of these, the **parietal** ridge, belongs to the outer wall of the furrow, while the **paraneural** ridge runs along the base of the furrow, above the bases of the gills and under the pleuro-visceral cord. The paraneural ridge is continued a short distance along the inner surface of each gill, so that each gill has an epibranchial sensory prominence. In front of the first pair of gills and near the last the sensory cells in the paraneural ridge become far more numerous in comparison with the glandular cells. *Chiton siculus*, *C. Polii*, and *Acanthochiton* (in which the numerous gills reach far forward) have no parietal and paraneural ridges. The sensory epithelium in these animals is confined to two prominences, paraneural in position, behind the last pair of gills, and connected with a high epithelium covering the pallial wall of the most posterior part of the furrow.

All these sensory epithelia seem to be innervated from the pleuro-visceral cords.

The question as to the relation of these sensory epithelia in the *Chitonidæ* to the osphradia of other Molluscs, which here presents itself, is difficult to answer. In position the osphradia best correspond with the epibranchial prolongations of the paraneural ridges in *Chiton lævis* and *C. cajetanus*.

3. The "Lateral Organs" of the Diotocardia.

At the bases of the epipodial tentacles of *Fissurella* and the *Trochidae*, and at the base of the lower tentacles of the epipodial ruff of *Haliotis*, and also in other parts near the ruff, sensory organs are found which have been compared with the lateral organs of Annelids. They consist of patches of sensory epithelium, which may form either spherical projections or pit-like depressions. The epithelium of these sensory organs which lie at the lower side of the bases of the epipodial tentacles, consists of sensory cells, each of which is provided with a sensory seta, and pigmented supporting cells. Each of these sensory organs is innervated by the nerve of the tentacle near it, which nerve originates in the pedal cord and forms a ganglion in the base of each epipodial tentacle.

4. Gustatory Organs.

Folds and prominences found in the mouth in some divisions of the Mollusca have been taken for gustatory organs, although there are no physiological and hardly any histological grounds for this opinion. The existence of so-called gustatory pits on a prominence in the buccal cavity has been proved only in a few *Chitonidae* and *Diotocardia* (*Haliotis*, *Fissurella*, *Trochus*, *Turbo*, and *Patella*). This "gustatory prominence" (which has been best examined in *Chiton*) lies on the floor of the buccal cavity, close behind the lip. A few gustatory pits are found in its epithelium, sunk somewhat below the surrounding epithelium. They consist of sensory cells with freely projecting sensory cones, and of supporting cells.

On each side of the mouth in the *Pulmonata* lies an oral lobe, and under its deep epithelium, which is covered by a thick cuticle, lies a ganglion. Smaller ganglia are found in the small lobes at the upper edge of the mouth. All these ganglia receive nerves which radiate from a branch of the anterior tentacle nerve. These oral lobes (Semper's organ) are considered to be gustatory organs.

5. Subradular Sensory Organ of Chiton.

In the buccal cavity of *Chiton* a subradular organ of unknown physiological significance has been found. It is described as "a prominence lying below and in front of the radula," and in shape resembles two beans with their concave edges turned to one another, the ends touching; the space between them forms a channel into which a small gland opens. Below this organ lie two ganglia, the subradular or lingual ganglia (*cf.* section on the nervous system). The epithelium of the subradular organ consists of green pigmented ciliated cells and two kinds of sensory cells. A similar organ occurs in *Patella*, but has not been thoroughly examined, and at the same part in various *Diotocardia* there is a prominence, which, however, has no sensory cells. The *Scaphopoda* also possess a subradular organ.

6. The Sensory Organs on the Shell of Chiton.

There are numerous organs definitely arranged on the shell of the *Chitonidae* which have, no doubt correctly, been considered as sensory, *i.e.* tactile organs (Fig. 143). They are called *æsthetes*, and lie in pores on the tegmentum (*cf.* p. 39); they are club-shaped or cylindrical, and each carries a deep cup-like chitinous cap. Each *megal-æsthete* gives off all round numerous fine branches or *micro-æsthetes*, each of which ends in a swelling which carries a small chitinous cap. The body of the *æsthetes* consists principally of long cells like glandular cells; it is produced into a fibre which runs along the base of the tegmentum, and from here passes together with the

fibres of the other æsthetes of the shell-plate, between the tegmentum and articulamentum to the surrounding pallial tissue, or else penetrates the articulamentum.

The significance of the separate constituent parts of the æsthetes and their fibrous strands is not yet certainly known. It is probable that they are innervated from the dorsal lateral branches of the pleuro-visceral cords. It is even not known whether the fibrous strands are their nerves, or whether the clear fibres running through them are long sensory cells whose nuclei may lie between the glandular cells, and in connection with nerve fibres.

We are perhaps justified in assuming that the æsthetes are merely modifications

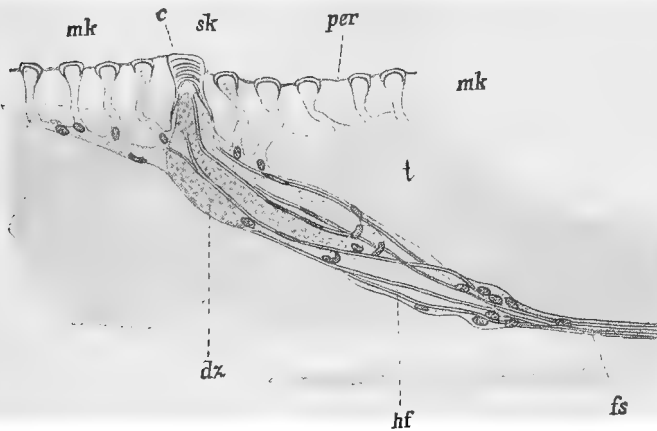

FIG. 143.—Section of the tegmentum of *Chiton lævis* showing an æsthete (after Blumrich). *mk*, Micræsthete; *per*, periostracum; *sk*, principal æsthete; *t*, tegmentum; *dz*, cells resembling glandular cells; *hf*, clear fibres; *fs*, fibrous strand; *c*, chitinous cap.

of the spines with their papillæ and formative cells, which are so common in the integument of the *Chitonida*. The chitinous cap would then represent part of the chitinogenous base of the spine.

The sensory nature of the æsthetes is rendered highly probable by the circumstance that in a few species of *Chiton* individual megal-æsthetes are transformed into eyes.

Each eye is furnished with a **pigmented envelope**, which is penetrated by the micræsthetes, and outwardly covered by an arched layer of the tegmentum which forms the cornea. Under this is a lens, and under this again a cell layer, which is regarded as a **retina**, and to which is attached a fibrous strand (optic nerve?) corresponding with the fibrous strands of the ordinary æsthetes.

B. Auditory Organs.

All Mollusca except the *Amphineura* possess auditory organs, which appear very rarely in the embryo. They take the form of two almost

closed auditory vesicles (**otocysts**), whose epithelial walls usually consist of ciliated and sensory cells. The interior of the otocyst is filled with fluid and contains a varying number of **otoliths** (1 to over 100). These vary in size, form, and chemical constitution, and in the living animal oscillate in the fluid in which they are suspended.

The otocysts are usually found on or near the pedal ganglia, rarely far from it. It is, however, well established that the auditory nerve does not originate in this ganglion but in the cerebral ganglion, though it often runs along close to and even in contact with the fibres of the cerebropedal connective.

In most cases the otocysts arise as invaginations of the outer epithelium. An interesting discovery has recently been made, that in primitive *Lamellibranchs* (*Nucula*, *Leda*, *Yoldia*) each

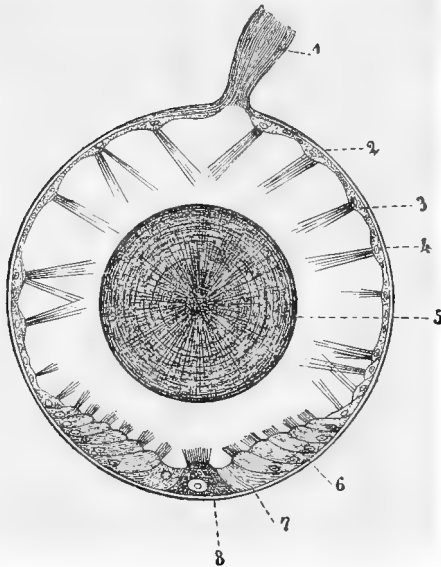

FIG. 144. Auditory organ of *Pterotrachea* (after Claus). 1, Auditory nerve; 2, structureless membrane; 3 and 4, ciliated cells; 5, otolith; 6, auditory cells; 7, supporting or isolating cells; 8, large central auditory cell.

of the otocysts even in the adult still opens by means of a long canal on the surface of the foot. In such cases the otoliths are particles of sand or other foreign matter taken in from outside. In *Cephalopods*, the remains of the canal of invagination is retained (**Kölliker's canal**), but it ends blindly.

The auditory organs are most highly developed in those Molluscs which are good swimmers, especially in the *Cephalopoda* and *Heteropoda*. Among these, **maculæ** and **cristæ acusticæ** are developed.

Heteropoda.—The structure of the auditory organ of *Pterotrachea* (Fig. 144), which has been thoroughly examined, is as follows:—

The wall of the otocyst consists in the first place of a structureless membrane surrounded by muscle and connective tissue. Inside the vesicle, which is filled with fluid, a calcareous otolith, built up of concentric layers, is suspended. The inner surface of the vesicle is lined by an epithelium, containing three different sorts of cells: auditory, ciliated, and supporting cells. The auditory cells, which carry immobile sensory hairs, are found on the wall of the otocyst at a point (**macula acustica**) diametrically opposite to the place where the auditory nerve enters. At this spot there is a patch formed of

numerous auditory cells, and in their midst, separated from the rest by four supporting or isolating cells, one large **central auditory cell**. On the larger remaining surface of the wall of the otocyst, separated by undifferentiated cells, are found flatter ciliated cells, which carry very long cilia or setæ, exhibiting peculiar movements. They sometimes lie flat along the inner wall of the vesicle, and at other times (it is said in response to strong auditory stimuli) stand upright, projecting towards the centre of the vesicle, and supporting the otolith.

The auditory nerve, which enters the otocyst at a point exactly opposite the central cell, at once radiates in the form of fibres over the whole wall of the vesicle "as meridians radiate from the pole on a globe," finally innervating the bases of the auditory cells.

The two otocysts of the *Cephalopoda* are still more complicated; they lie in two spacious cavities of the cephalic cartilage. The sensory epithelium is here found on a macula acustica and on a kind of ridge, the crista acustica, which projects inwards. Otoliths are only found on the macula acustica. The auditory nerve divides into two branches, one going to the macula, and the other to the crista acustica. Kölliker's canal, above mentioned, which is internally ciliated and ends blindly, runs out of the otocyst as the remains of the aperture of the original invagination.

Experiments made on *Cephalopods* have shown that one of the functions of the otocysts is to regulate the position of the animal while swimming.

C. Visual Organs.

1. Optic Pits.

These are the simplest form of visual organ. They are cup-shaped depressions of the body epithelium, which at the base of the cup forms the retina. The depression is sometimes very shallow, at other times deep, and like a wide bottle with a short narrow neck. The **optic nerve** enters at the base of the depression and spreads out over it. The epithelial wall or retina consists, apparently in all *Gastropoda*, of two kinds of long thread-like cells: (1) **clear cells without pigment**, and (2) **pigmented cells**. Whether either or possibly both of these kinds can be considered as retinal cells

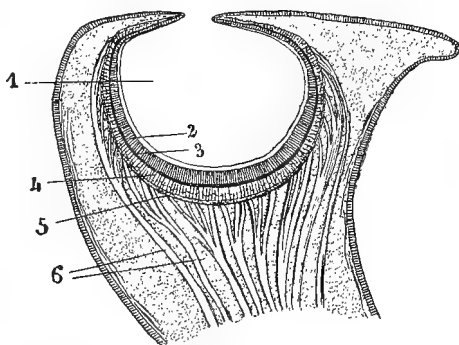

FIG. 145.—Eye of *Nautilus* (after Hensen). 1, Optic cavity (pit); 2, layers of rods; 3, pigment layer; 4, layer of visual cells; 5, layer of ganglion cells; 6, branches of the optic nerve.

either or possibly both of these kinds can be considered as retinal cells

is still a disputed question. In certain cases it has been proved that the pigment in the second kind lies peripherally; the axis is free from pigment, and may perhaps be considered as the sensitive portion of the cell. In this case, the clear cells would be undifferentiated supporting cells, or secreting cells. The retina is covered, on that side of it which faces the cavity, by a thick gelatinous cuticle, or the whole cavity is filled by a gelatinous body often called a **lens**. The clear or secreting cells have been thought to yield this gelatinous mass, but there is a tendency to regard them now rather as retinal cells.

Optic pits are, among the *Gastropoda*, only found in such *Diotocardia* as show primitive characteristics, e.g. *Haliotidae*, *Patellidae*, *Trochidae*, *Delphinulidae*, and *Stomatidae*.

In connection with the claim that *Nautilus* (Fig. 145) is the most primitive form among extant *Cephalopoda*, it is interesting to find that both its eyes are optic pits. Each sensory cell of the retina, i.e. of the epithelial wall of the depression, possesses a cuticular rod projecting towards the cavity, and a layer of ganglion cells is intercalated between the ramifications of the optic nerve and the retina.

2. Optic Vesicles or Vesicular Eyes.

Optic vesicles are developed from optic pits both ontogenetically and phylogenetically by the approximation of the edges of the pit, which finally fuse. A vesicle is thus formed, over which there is a continuous layer of epithelium (Fig. 146). The outer epithelium is free from pigment over the eye, and is called the outer cornea, while the immediately subjacent, and also unpigmented, epithelial wall of the vesicle forms the inner cornea. The epithelial base of the original depression here again forms the retina; its cells contain distinct rods projecting towards the cavity of the vesicle, which is filled with a gelatinous mass. The optic nerve usually swells into a peripheral ganglion opticum before reaching the retina.

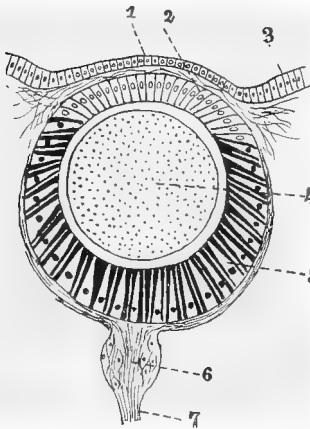

FIG. 146.—Eye of a Pulmonate. 1, Outer, 2, inner cornea; 3, body epithelium; 4, vitreous body; 5, retina; 6, ganglion opticum; 7, optic nerve.

The tentacular eyes of most *Gastropoda*, except those *Diotocardia* which have cup-like eyes, are of this simple character.

3. The Eye of the Dibranchiate Cephalopoda.

This is one of the most highly-developed eyes in the whole animal kingdom. It is a further development of the cup-shaped and vesicular

eyes. In the *Tetrabranchiate Nautilus*, as we have seen, the cup-shaped eye persists throughout life.

These lower stages (*i.e.* the cup-shaped and vesicular stages) of the eye are passed through ontogenetically. First a cup-like depression is formed (primary optic pit), then this becomes constricted to form a vesicle (primary optic vesicle), the inner wall of which becomes the retina, while the outer (which corresponds with the inner cornea of the vesicular eye) becomes the **inner corpus epitheliale**. This embryonic optic vesicle then becomes further complicated; the integument over it (the outer cornea of the vesicular eye) rises in the form

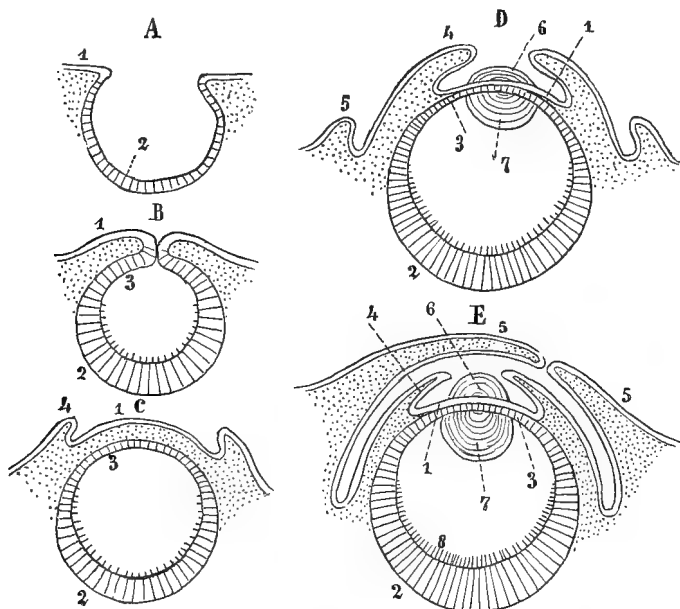

FIG. 147.—Development of the eye of the dibranchiate Cephalopoda. 1, Body epithelium, which becomes the outer corpus epitheliale; 2, inner wall of the optic depression, which becomes the retina; 3, outer wall of the optic vesicle, which becomes the inner corpus epitheliale; 4, fold which forms the iris; 5, fold which forms the secondary cornea; 6, portion of the lens formed by the outer corpus epitheliale; 7, portion of the same formed by the inner corpus epitheliale; 8, rod layer of the retina.

of a circular rampart, and then grows forward towards the axis of the eye like a diaphragm, which forms the **iris**, the aperture left in the same being the **pupil**. The integument which spreads out over the circular base of the iris is in close contact with the inner corpus epitheliale, and becomes the outer corpus epitheliale.

The inner corpus epitheliale forms towards the cavity of the primary vesicle an almost hemispherical lens, the outer corpus epitheliale forming a similar lens outwards towards the pupil. The two hemispheres lie in such a way as to form something like a complete sphere; its

two-fold origin, however, always remains evident, its equatorial plane being traversed by the double lamella of the corpus epitheliale.

A new circular fold grows over the eye, forming a fresh cavity over it; this is the **secondary cornea** of the dibranchiate eye, which must not be confounded with the primary cornea of the optic vesicle here represented by the corpus epitheliale. In most forms the circular fold (cornea) does not altogether close over the eye; an aperture remains through which the water can enter the anterior chamber of

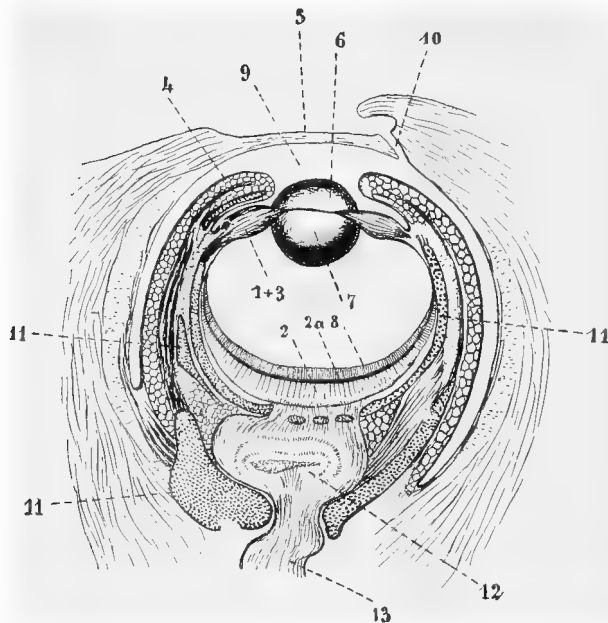

FIG. 148.—Section of the eye of *Sepia officinalis*, somewhat diagrammatic (after Hensen). 1-8, As in Fig. 147; 1+3, corpus epitheliale; 9, anterior chamber of the eye opening outward at 10; 11, cartilaginous capsule; 12, ganglion opticum=retinal ganglion; 13, nervus opticus; 2^a, pigment layer of the retina.

the eye. In some animals, however, the secondary cornea closes completely.

We thus obtain, ontogenetically, some idea of the general structure of the dibranchiate eye. A few details of the structure of the adult eye are given below (Figs. 148 and 149).

1. **The retina** (Fig. 149) consists of two kinds of cells—(1) **pigmented visual or rod cells**, and (2) **limiting cells**. Since the nuclei of the visual cells form, with relation to the centre of the vesicle, an outer, and the nuclei of the limiting cells an inner layer, and since, between these two layers, a limiting membrane traverses the interstices between the retinal cells, the retina appears to be laminated, whereas it in reality consists of one layer of cells. The rods of the

retinal cells lie on the inner side of the limiting membrane, and are thus turned to the source of light and at the same time to the cavity of the primary vesicle. The retina is covered on its inner side by a somewhat thick membrana limitans.

2. The eye is surrounded, except on the side turned to the surface of the body, by a **cartilaginous capsule**, which resembles the sclerotica in the vertebrate eye; this cartilage, where it covers the retina, is perforated like a sieve, so that the optic nerves can pass through it.

3. Immediately underneath the cartilaginous floor of the retina lies a very large ganglion opticum, in the form of a massive cerebral lobe. From this rise the nerves which run to the retina through the perforations of the cartilaginous capsule.

4. The two halves of the lens, which are unequal in size (the outer being the smaller), consist of homogeneous concentric laminae.

5. The cavity of the primary vesicle (between the retina and the lens) is filled with perfectly transparent fluid.

It has been proved that, as in the Arthropoda and Vertebrata, the pigment granules of the rod cells, which in the dark lie at the base of the cell, under the influence of light travel towards its free end.

4. The Dorsal Eyes of *Oncidium* and the Eyes at the edge of the Mantle in *Pecten* (Fig. 150) and *Spondylus*.

These eyes have been said to resemble vertebrate eyes in structure, because in them the **visual rods are turned away from the light, being directed inwards towards the body.**

They are vesicular eyes, but in them it is the outer wall of the vesicle, that turned to the light, which becomes the retina, while the inner wall (which in other Molluscs forms the retina) is a pigmented epithelium. At the same time the outer or retinal wall is invaginated towards the inner pigmented wall, as is the endoderm towards the ectoderm in the formation of the gastrula. The consequence of this is, that the cavity which in other Mollusca is filled by the gelatinous mass (lens) disappears, and the vesicle becomes a flattened thick-walled plate (*Pecten*) or cup (*Oncidium*), consisting of a pigment layer and a retina. The body epithelium which passes over the eye is unpigmented and transparent, and here becomes the cornea. Beneath

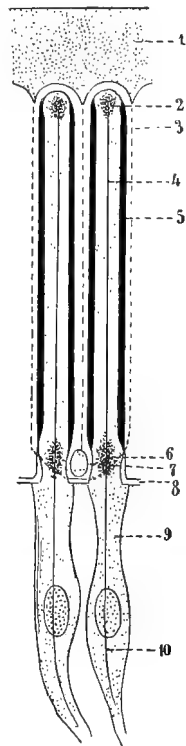

FIG. 149.—Two retinal cells of a Cephalopod, much magnified (after Grenacher). 1, Membrana limitans; 2, pigment; 3, secreted threads; 4, nerve fibre; 5, rod; 6, pigment; 7, limiting cell; 8, retinal membrane; 9, retinal cell; 10, nerve fibre.

the cornea, within the optic cup or on the plate, lies a cellular lens, which in the dorsal eyes of *Oncidium* consists of a few (5) large cells, but in the pallial eyes of *Pecten* and *Spondylus* of very numerous cells.

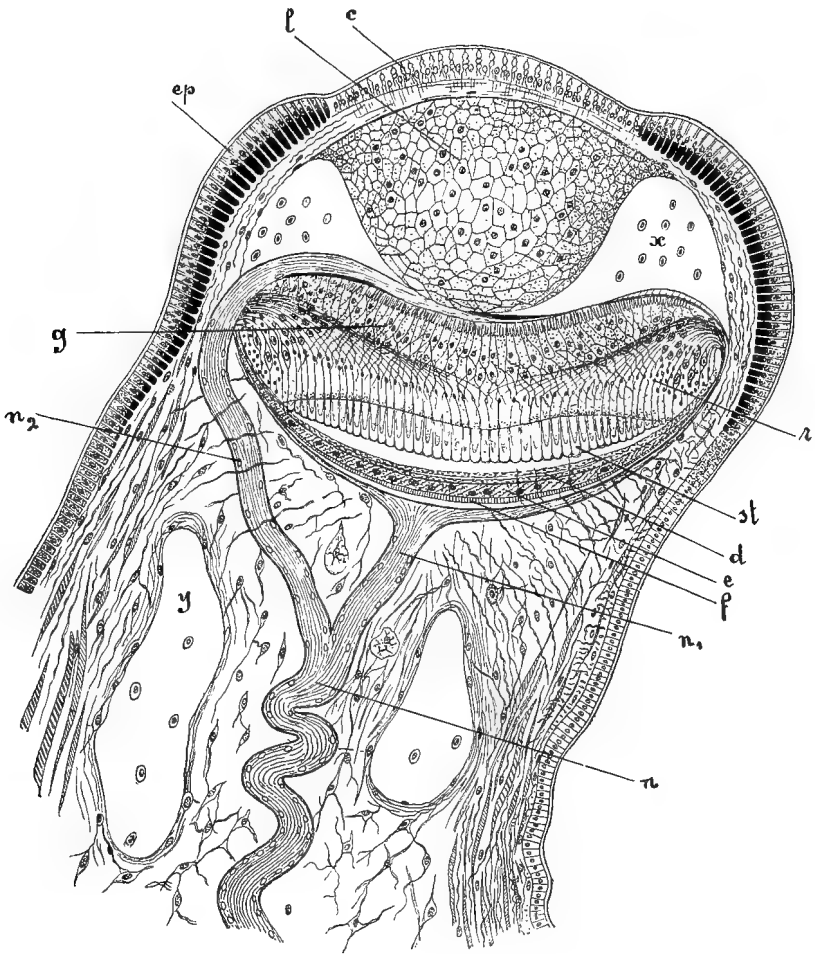

FIG. 150.—Section through the eye of *Pecten* (after Patten). *c*, Cornea; *l*, lens; *ep*, pigmented body epithelium; *g*, layer of ganglion cells; *r*, retina; *st*, rod layer of the retina; *d*, tapetum; *e*, pigmented epithelium; *f*, sclerotica; *n*, optic nerve; *n*₁ and *n*₂, its two branches.

The development of this lens is unknown; it is perhaps formed by a thickening or invagination of the embryonic ectoderm which covers the eye.

In *Oncidium*, the optic nerve penetrates the wall of the optic cup, as in the vertebrate eye, to spread out on the inner surface (with regard to the centre of the vesicle) of the retina, and to innervate the retinal cells.

In *Pecten*, the optic nerve which runs to each eye from the nerve for the pallial edge, divides, close to the eye, into two branches. One of these runs to the base of the optic plate, and there breaks up into fibres, which radiate on all sides to the edge of the plate, then bend over towards the retina to innervate some of its cells. The other branch runs direct to the edge of the plate, there bends round at a right angle and supplies nerves to the rest of the nerve cells. The fibres of this branch are not, however, directly connected with the retinal or rod cells, as there is a layer of anastomosing ganglion cells interposed between the two. Between the pigmented epithelium and the rod layer of the retina, a **tapetum lucidum** is found, which gives the eye of the *Pecten* its metallic lustre.

Dorsal eyes are found in many species of *Oncidium*. They lie at the tips of the contractile papillæ found on the dorsal integument of this curious *Pulmonate*; on each papilla three or four such eyes occur. Besides these, *Oncidium* has the two normal cephalic eyes usually found in *Gastropods*.

The pallial eyes of the *Lamellibranchiates*, *Pecten* and *Spondylus*, are found in large numbers on the edge of the mantle, between the longer tentacles, and on the tips of shorter tentacles. The rods of the retina in *Pecten*, when fresh, are of a very evanescent red colour (visual purple?).

5. The Eyes on the Shell of Chiton.

These have already been described (p. 167). Their morphological significance cannot be determined as long as their development is unknown and their histological structure imperfectly investigated.

6. The Compound Eyes of *Arca* (Fig. 151) and *Pectunculus*.

These are found in great numbers at the edge of the mantle, and are epithelial organs which do not in any way agree in structure with the other visual organs found in Mollusca, but rather resemble certain simple Arthropodan eyes.

In form they resemble an externally convex shell. The unilaminar epithelial wall of the shell passes, at its edge, into the surrounding pallial epithelium. In section, its component elements appear to be arranged like a fan ("Fächerauge"). These elements are of three kinds: (1) conical visual cells, with their bases turned outwards; (2) a sheath of six cylindrical pigment shells surrounding each visual cell. Each group, consisting of one visual cell and its surrounding pigment cells, may be considered as a single eye or ommatidium of the simplest structure, in which the retinula is represented by one single visual cell. (3) Slender, almost thread-like interstitial cells which stand between the ommatidia.

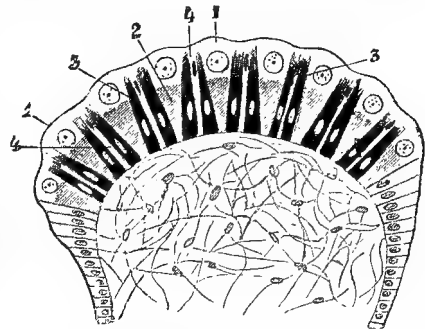

FIG. 151.—Section of the eye of *Arca barbata* (adapted from Rawitz). 1, Retinal cells with rod-like bodies (2); 3, pigment cells; 4, slender interstitial cells.

7. Degeneration of the Cephalic Eyes.

It is becoming more and more probable that the cephalic eyes of the various Mollusca are homologous structures, and that they primitively occurred in all forms. They may, however, under certain biological conditions become rudimentary, and even disappear, as in boring animals and those living in mud or in the deep sea and in parasitic Molluscs. The *Lamellibranchia* and *Chitonida* (?) even have cephalic eyes appearing temporarily during development; they disappear later, when, covered by the shell, they are useless. They may be replaced by secondarily acquired visual organs arising at more suitable parts of the body, and thus we have eyes on the mantle edge in some bivalves and on the shell of some *Chitonida*.

XVI. The Alimentary Canal.

The alimentary canal is well developed in all Molluscs, and is composed of (1) the **buccal cavity**; (2) the **pharynx or œsophageal bulb**; (3) the **œsophagus or fore-gut**; (4) the **mid-gut with the stomach**; (5) the **rectum or hind-gut with the anal aperture**. The mouth originally lies at the anterior, and the anus at the posterior end or side of the body, the latter in the mantle furrow or cavity. The former always retains its original position, but the latter, as central organ in the pallial complex, becomes shifted more or less far forward along the right (less frequently the left) side, in the mantle furrow.

When the visceral dome grows out dorsally in such a way that the longitudinal axis becomes shorter than the dorso-ventral axis, as is the case in many *Gastropods* and *Cephalopods* and in *Dentalium*, the mid-gut at least, with its accessory gland, the so-called liver, runs up into this dome, filling the greater part of it. The intestine then forms a dorsal loop, consisting of an ascending portion running up from the fore-gut and a descending portion running down to the anus. In the *Gastropoda*, where the anus is shifted more or less forward, the descending portion bends forward to the right (rarely to the left) to reach it.

Besides this principal visceral loop, which is caused by the development of the visceral dome and modified by the displacement of the pallial complex, the intestine, in nearly all Molluscs, forms secondary loops or coils which add to its length. These loops are found principally in the tubular portion of the mid-gut which follows the stomach. They are as a rule most pronounced in herbivorous animals, which thus have longer alimentary canals than carnivorous forms.

The large digestive gland, usually called the **liver**, enters the stomachal division of the mid-gut. Functionally, this organ only very slightly corresponds with the vertebrate liver, if indeed it may be said to correspond at all with that organ. It agrees more nearly

with the pancreas, and perhaps combines the functions of the different specialised digestive glands of Vertebrates.

There is a radical difference between *Lamellibranchs* and other Molluscs,¹ in the fact that in the latter the anterior portion of the fore-gut which follows the buccal cavity is developed as a muscular pharynx (œsophageal bulb, buccal mass), and carries at its base on a movable lingual cushion a file-like organ, the **radula**, which is beset with numerous hard teeth composed of conchyolin or chitin. The radula serves chiefly for mastication, but is sometimes used in seizing, holding, and swallowing prey.

None of the *Lamellibranchs* have a pharynx provided with a radula, they are therefore called *Aglossa* as opposed to all other *Molluscs*, which are *Glossophora*.

Hard **jaws**, composed of conchyolin, are almost always found in varying number and arrangement in the buccal cavity of the *Glossophora*, but are wanting in all *Lamellibranchs*.

One or two pairs of glands open into the pharynx in the *Glossophora*; these are usually called salivary or buccal glands, although they vary slightly if at all correspond physiologically with the glands so named in the Vertebrata. Glands may also open into the buccal cavity. The *Lamellibranchs* have no salivary glands.

The absence of the pharynx, tongue, jaws, and salivary glands in the *Lamellibranchia* is accounted for by their manner of life. They do not have to seek their food. Some of them are attached and others feed in the same way as attached animals on small particles suspended in the respiratory water (animalculæ, microscopic algæ, and particles of detritus) which are brought to the mouth by means of ciliary movement. These fine particles require no mastication before being swallowed.

This method of feeding also affects the outer organisation of the *Lamellibranchia*, which have lost the cephalic portion of the body with the tentacles and eyes: **Aglossa = Acephala = Lipocephala**, and **Glossophora = Cephalophora**.

In some Gastropoda (*Murex*, *Purpura*) and in *Dentalium* there is in connection with the last part of the hind-gut an **anal gland**, and in the *Cephalopoda* (excepting *Nautilus*) a gland known as the **ink-bag**.

The alimentary canal of the Mollusca runs through the primary and often also through the secondary body cavity, attached in various ways by fibres or bands of connective tissue. Its walls consist of an inner epithelium usually to a great extent ciliated, an outer muscular layer in which longitudinal and circular fibres occur, not always in regular layers, and, where it passes through the primary body cavity, an outer envelope of connective tissue.

The pharynx and perhaps sometimes part of the œsophagus, and a part, in all cases very short, of the hind-gut, arise ontogenetically out of the ectodermal stomodæum and proctodæum. But the exact limits

¹ For the rare exceptions to this rule, see p. 183.

of the ectodermal and the endodermal portions of the intestine are difficult to determine.

A. Buccal Cavity, Snout, Proboscis.

The alimentary canal has an oral aperture bordered by variously-shaped lips, and in many *Glossophora* (in nearly all *Gastropoda*) leads into a vestibule or anterior cavity roofed over by the lips and lined by a continuation of the outer wall of the head. The dermal glands are not unfrequently (many *Opisthobranchia* and a few *Prosobranchia*) more strongly developed on the lips as **labial glands**. In many *Gastropods*, when the lips open, the mouth is able to seize and hold prey like a sucker.

Where the **snout** is short it is simply contractile (the *Chitonidae*, the *Diocardia*, most herbivorous *Tœnioglossa*, and many *Pulmonata* and *Nudibranchia*). In this case the parts immediately surrounding the mouth are so strongly contractile that when contraction takes place the mouth is drawn in somewhat so as to lie at the base of a depression. An exaggeration of this arrangement, combined with the prolongation of the snout, leads to the formation of the retractile or **proboscidal snout**. The snout can in such cases be invaginated from its tip, *i.e.* from the oral aperture into the cephalic cavity, the mouth then lying at the base of the invagination (many *Tectibranchia*, *Capulidae*, *Strombidae*, *Chenopidae*, *Calyptraeidae*, *Cypraeidae*, *Lamellaridae*, *Naticidae*, *Scalaridae*, *Solariidae*).

Finally, in many carnivorous *Prosobranchia* (*Tritoniidae*, *Doliidae*, *Cassididae*, *Rachiglossa*, and a few *Toxoglossa*) a **proboscis**, often very long and enclosed in a special **proboscidal sheath**, is developed (Figs. 71 and 152); this sheath lies in the cavity of the head, which is often prolonged like a snout, and may even stretch back into the body cavity. The oral aperture lies at the free anterior end of the cylindrical proboscis, and we have to regard the proboscis with its sheath as a very long snout, the base of which, however, is permanently invaginated into itself. In this way the proximal portion of the snout forms the permanent proboscidal sheath, while the distal portion with its terminal oral aperture forms the proboscis. Neither of these portions can be invaginated or evaginated; it is merely a zone lying between them which takes part in the retraction of the proboscis into the body cavity. This zone, when so invaginated, forms a temporary backward prolongation of the proboscidal sheath, but when the proboscis is protruded forms the basal portion of the latter. The permanent portion of the proboscidal sheath is connected with the wall of the head by bands which make its evagination impossible, and the inner wall of the permanent proboscis is connected by muscles or bands with the œsophagus lying within it, so that this portion of the organ cannot be invaginated; the oral aperture can thus never lie at the base of the proboscidal sheath.

When the proboscis is retracted, there is therefore an aperture at the anterior end of the snout or the head, which is not the oral aperture, but that of the proboscidal sheath. When the proboscis is protruded, it projects beyond the aperture of the sheath and carries at its point the oral aperture.

The proboscis is retracted by means of muscles attached at the one end to the body wall and at the other to its (invaginable) base. In its protrusion, a flow of blood towards the snout probably plays the chief part, accompanied by contraction of the circular muscles of the head and proboscis.

The (carnivorous) *Ptropa* *gymnosomata* also have a protrusible proboscis (Fig. 17, p. 11) provided with so-called buccal appendages. The same is present in the allied *Aplysiidae*, but is weakly developed. The *Thecosomata* have no proboscis.

The buccal cavity of *Dentalium* is noteworthy. It extends throughout the

whole length of the freely-projecting egg-shaped snout, which carries leaf-like labial appendages. On each side of the buccal cavity there is a pouch, the so-called cheek pouch, which is lined with glandular epithelium and opens into the cavity anteriorly.

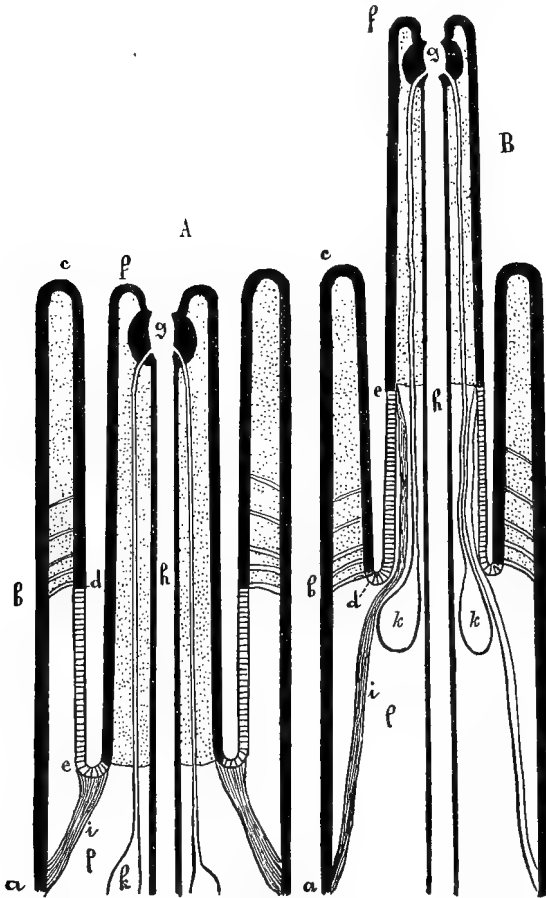

FIG. 152.—Diagram of the proboscis apparatus of the Prosobranchia. A, proboscis retracted. B, The same protruded. *a-c*, Cephalic integument; *c*, edge of the aperture of the proboscis; *d-e*, immovable wall of the proboscis; *e-f*, movable (evaginable and invaginable) wall of the same; *f*, edge of the oral aperture, at the anterior end of the proboscis; *g*, pharynx; *h*, cesophagus; *i*, retractor muscle; *k*, salivary glands; *l*, cephalic cavity.

An exact comparative investigation of the mechanism of the proboscis apparatus, the contractile snout, etc. of the Prosobranchia is still a desideratum.

There are other forms of proboscis, differing greatly from the one just described (e.g. that in the *Terebridae*).

In the *Heteropoda*, the head forms a long snout which is often described as a proboscis. The name is inappropriate, as this snout is not retractile and the mouth is always found at its anterior end.

B. The Pharynx and Jaws, the Tongue and Salivary Glands.

The mouth or buccal cavity is followed in all Molluscs except the *Lamellibranchia* by the pharynx or œsophageal bulb (buccal mass). The pharyngeal cavity opens anteriorly into the buccal cavity, and posteriorly into the œsophagus. The pharynx is characterised by the possession of (1) **jaws**, which lie anteriorly at the boundary between the buccal and pharyngeal cavities; (2) a **lingual apparatus** at its base, and (3) **salivary glands**, which usually open laterally near its posterior boundary.

1. Jaws are almost universal, and are sometimes, especially in carnivorous animals, very highly developed; less frequently they are rudimentary or wanting. They are hard cuticular formations of the epithelium of the anterior pharyngeal region, and no doubt composed of conchyolin or some related substance, in a few cases hardened by calcareous deposits (*e.g.* *Nautilus*).

The jaws serve for seizing prey or particles of food. The great variations in number, form, and arrangement of the jaws can best be understood by assuming that they originally extended completely round the entrance to the pharynx; and that of this ring sometimes only upper and lower or sometimes only lateral portions have been retained.

Such a complete circle of jaws is found at the entrance to the pharynx in some forms, such as *Umbrella* and *Tyrodina* (*Opisthobranchia*).

The fresh-water *Pulmonates* have an upper and two lateral jaws.

Most *Prosobranchia* and *Opisthobranchia* have two lateral jaws. These may approach so near one another as almost to touch (*Haliotis*, *Fissurella*). Terrestrial *Pulmonata* have an upper jaw and occasionally a weak lower jaw as well.

The jaws are particularly strongly developed in the *Cephalopoda*, which have an upper and a lower jaw, the two together resembling in shape the beak of a parrot.

In the *Opisthobranchiate* family *Aphysiidae*, *Notarchus*, *Acera*, *Dolabella*, and *Aphysiella* have, besides the lateral jaws, numerous hooks or small teeth on the roof of the pharyngeal cavity. The **hook sacs** (Fig. 17, p. 11) of the *Pteropoda gymnosomata*, which are wanting only in *Halopsyche*, are perhaps to be derived from these pharyngeal teeth.

The hook sacs are paired dorsal outgrowths of the pharyngeal cavity, which vary in length and lie in front of the radula. The walls of the sacs carry hooks projecting inward. When the proboscis of these carnivorous animals is protruded, the sacs are completely evaginated, so that the hooks come to lie outside (Fig. 17, p. 11).

Jaws are wanting or rudimentary in the *Amphincura* and the *Scaphopoda*; among the *Prosobranchia*, in the *Toxoglossa*, *Pyramidellidae*, *Eulimidae*, many *Trochidae*, the *Heteropoda*, and in many *Nudibranchia* (*Tethys*, *Melibe*, *Doridopsis*, *Phyllidia*); in the *Ascoglossa*, and in certain *Tectibranchia* (*Actæon*, *Doridium*, *Philine*, *Utriculus*, *Scaphander*, *Lobiger*). Among the *Pulmonata* they disappear in a series of *Testacellidae*, being present in *Daudbardaria rufa*, rudimentary in *D. Scutleyi*, and wanting in *Testacella*.

2. The **lingual apparatus** (Figs. 153, 154) is highly characteristic of all Molluscs except the *Lamellibranchia*, *i.e.* of all *Glossophora*. It may be said that every animal with a radula is a Mollusc.

The ventral and lateral walls of the pharynx are thickened and very muscular. On the floor of the cavity rises a tough longitudinal muscular cushion, the **tongue**. Its surface, which projects into the

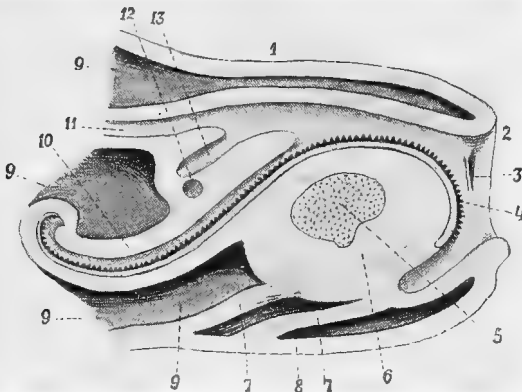

FIG. 153.—Longitudinal section (not quite median) through the snout of a Prosobranchiate, to illustrate the pharyngeal apparatus. 1, Dorsal wall of the head; 2, mouth; 3, jaw; 4, radula; 5, lingual cartilage; 6, muscular wall of the pharynx; 7, muscles attached at one end to the pharynx and at the other to the ventral wall of the head (8); 9, cavity of the head; 10, radular sheath; 11, oesophagus; 12, aperture of the salivary gland; 13, infolding behind the radular sheath.

pharyngeal cavity, is covered by a rough cuticle consisting of chitin (or conchyolin?); on this **basal membrane** are found very numerous hard chitinous teeth, often many thousands, arranged in close transverse

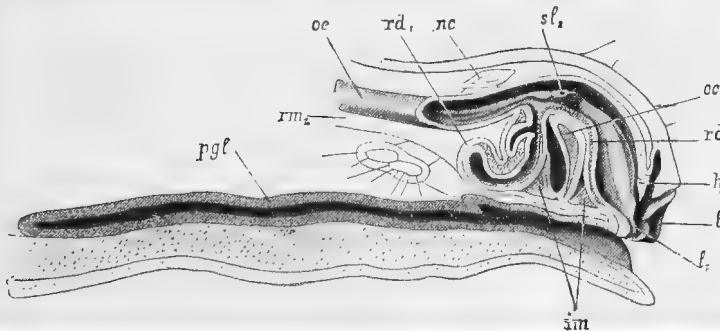

FIG. 154.—Median longitudinal section through the anterior part of the body of *Helix* (after Howes). *oc*, Oesophagus; *rd*, radular sheath; *nc*, cerebral ganglion; *sl*₂, aperture of the salivary gland; *oc*, muscle mass in the ventral pharyngeal wall; *rd*, radula; *hj*, upper jaw; *l*₁, *l*₂, lips of the oral aperture; *im*, pharyngeal muscles; *rm*₂, retractors of the pharynx; *pgl*, pedal gland.

and longitudinal rows. The basal membrane and the teeth together form the **radula** of the tongue.

The anterior end of the tongue projects freely into the pharyngeal cavity, the radula bending down over this end so as to cover for a

certain distance its lower surface. Immediately in front of the tongue there is always a depression in the ventral pharyngeal wall, forming a sort of pocket. The radula, at the posterior extremity of the tongue, sinks into a narrow more or less long tube, the radular sheath, which is an outgrowth of the pharyngeal cavity running downward and backward. The radula, always lying upon the anterior or ventral wall of this sheath, which is anteriorly thickened to form the tongue, extends to the base of the sheath, which is the place of its formation.

The tongue with the radula on it is movable, and in most cases its movements can be compared with those of the cat's tongue when licking, but are usually slower. This action helps to rasp the food which has been seized, and often also broken up, by the jaws. The tongue can either move inside the pharyngeal or buccal cavities, or can be extended to the oral aperture or even protruded more or less far beyond it.

In or under the fleshy tongue, a **lingual cartilage** is very commonly found, consisting of two or four or even more pieces. This cartilage forms a support for the radula, and affords firm points of attachment for certain muscles belonging to the lingual apparatus.

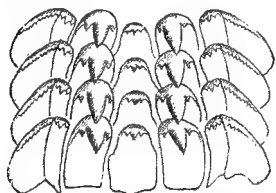

FIG. 155.—Four transverse rows of the radular teeth of *Cyclostoma Elegans* (after Claparède).

The musculature of the pharynx, which can be separated into bundles or strands, and is often very complicated, consists first of the muscles which form the wall of the pharynx, and which, being principally developed ventrally and laterally round the radula, determine the special licking movements of the tongue; secondly, of muscles which move the whole pharynx or the whole of the lingual apparatus, evaginating or protruding them.

The second group consists, speaking generally, of protractors and retractors, attached at the one end to the pharynx and at the other to the body wall after running through the cephalic or body cavity. Pressure of blood may also take some part in the protrusion of the pharynx.

The tongue and radula further often serve for seizing prey (*e.g.* in the carnivorous *Heteropoda*, in *Testacella*, etc.).

The radula is of great importance in classification. Further details concerning it must be sought in special works and in text-books of conchology. The points to be specially noticed are (1) the size and form of the whole radula, (2) the number of longitudinal and transverse rows of teeth, and (3) the form of the teeth in each of these rows. As a rule the transverse rows resemble one another, but exceptional rows differently constituted from those immediately preceding or following them recur at intervals.

Three kinds of teeth have been, as a rule, distinguished. First, there is usually a single median longitudinal row of **central** or **rachial** teeth. On each side of this row are several rows of more or less similar **lateral** teeth or **pleuræ**. Finally, at the lateral edges of the radula, there are single or very numerous longitudinal rows of **marginal** teeth or **uncini**.

Dental formulæ are used for the radular teeth, in the same way as for the teeth of mammals; in these the number of central, lateral, and marginal teeth in a transverse row are given.

The reader will find the dental formulæ of some of the Molluscs in the Systematic Review.

The total number of radular teeth varies very greatly, from 16 in *Eolis Drummondii* to 39,596 in *Helix Ghiesbreghtii*.

As a rule, the teeth are most numerous and finest in herbivorous animals. In carnivorous Molluscs we have two extremes: (1) great development of the proboscis, with weak development of the pharynx and radula, and a comparatively small number of teeth (carnivorous *Prosobranchia*); (2) absence of a protrusible proboscis, with great development of the pharyngeal apparatus and the radula, and numerous, often large, teeth (*Heteropoda*, carnivorous *Pulmonata* and *Cephalopoda*).

The muscular pharynx is most developed in carnivorous *Pulmonates*. In these it may be half (*Daulebardia*) or even more than half as long (*Testacella*) as the whole body, and may occupy a very large part of the body cavity. It is protruded in such a way that the tongue with the radula occupy the anterior end of the evaginated pharynx (Fig. 54, A, p. 44).

In very rare cases (apart from the *Lamellibranchia*) the radula completely atrophies; this is the case in parasitic *Gastropoda* (*Stilifer*, *Eulina*, *Thyca*, *Entoconcha*), in the *Coralliophilidae* (*Coralliophila*, *Leptoconchus*, *Magilus*, *Rhizochilus*), among the *Nudibranchia* in *Tethys* and *Melibe*, among the *Amphineura* in *Neomenia*, and certain species of the genera *Dondersia* and *Pronconenia*. In *Chaetoderma*, a single tooth of the radula is retained.

Even in certain carnivorous *Prosobranchia* which are furnished with a proboscis, the above-mentioned reduction of the whole pharyngeal apparatus goes so far that the radula disappears (certain species of *Terebra*).

Formation of the Radula.

The teeth of the anterior transverse rows of the radula become worn out by use, and are continually being replaced by new teeth which are pushed forward. The formation of new transverse rows of teeth is constantly taking place at the posterior blind end of the radular sheath. In *Pulmonata* and *Opisthobranchia* they appear as cuticular formations secreted by several transverse rows of large epithelial cells—the odontoblasts (Fig. 156); the basal membrane which carries the teeth is secreted by the anterior row or rows, the teeth themselves by the posterior rows.

Each group of odontoblasts which has formed a tooth is not replaced by another, but continues to produce new teeth behind those already formed, so that for each longitudinal row of teeth there is at the base of the radular sheath a group of odontoblasts which has produced all the teeth belonging to that row. A layer of "enamel" is deposited on the teeth so formed by the epithelial roof of the radular sheath.

In the *Chitonidae*, *Prosobranchia*, and *Cephalopoda*, the odontoblasts are very numerous narrow cells, which form, at the base of the sheath, a cushion divided into as many parts as there are teeth in a transverse row of the radula.

The radular sheath in the *Pulmonata*, *Scaphopoda*, *Opisthobranchia*, and *Cephalopoda* is short, and is contained in the ventral and posterior muscular wall of the pharynx, very seldom projecting posteriorly beyond it; but in many *Prosobranchia* it is long and narrow, and reaches back into the cephalic cavity or even right into the body cavity. This latter is especially the case in the *Diotocardia*; in the

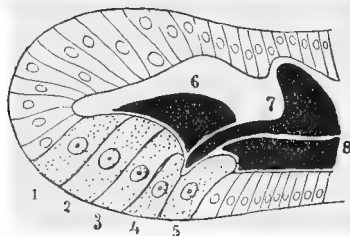

FIG. 156.—Longitudinal section through the posterior end of the radular sheath of a *Pulmonate* (after Rössler), diagram. 1, 2, 3, 4, Formative cells of the radular teeth; 5, formative cells of the basal membrane; 6, 7, teeth of the radula; 8, basal membrane.

Docoglossa (Patella) the sheath, which lies above the foot on the floor of the body cavity, is even longer than the body (Fig. 158).

3. **Salivary glands** (buccal glands, pharyngeal glands) are universally found in *Glossophora*, i.e. in Molluscs which have a pharynx and lingual apparatus. They are universally absent in *Lamellibranchs*. They may occur in one or two pairs. The posterior or in other cases the only pair often lies on the wall of the œsophagus, and sends forward two ducts which enter the pharynx laterally, usually somewhat behind the point where the radular sheath opens into the pharyngeal cavity. Very little is known of the function of these glands; an exact morphological comparison of the various pharyngeal glands of the *Gastropoda* is at present hardly possible.

Amphineura. (a) **Chiton.**—Two small delicate buccal glands lie on the roof of the buccal cavity and open into the mouth. They can therefore hardly be regarded as pharyngeal or salivary glands.

(b) **Solenogastres.**—Salivary glands are here found in all genera except *Neomenia*, and in *Chaetoderma*. They are present in some species but appear to be absent in others. A pair of long glandular tubes with high glandular cells¹ and strong muscular walls lie anteriorly under the intestine and are produced in the form of two narrow ducts, which enter the pharyngeal cavity on the tongue either separately or through a common terminal portion. Besides these there is another pair in some species (*Paramenia impera*, *Param. palifera*, *Proneomenia vagans*, *Dondersia flavens*); the ducts of these open together through an unpaired terminal portion on the dorsal wall of the pharyngeal cavity, at the point of a papilla which rises from the base of a pit-like depression.

Gastropoda. (a) **Prosobranchia.**—In most cases there is only one pair of salivary glands. These are usually lobed or branched glandular masses, which lie, in the *Diotocardia*, at the sides of the pharynx, in the *Monotocardia*, at the sides of the œsophagus. In the former case, the ducts are short and do not pass through the œsophageal ring formed by the nerve centres and their connectives and commissures, which in these forms surrounds the anterior end of the pharynx. In the *Monotocardia*, the ducts are long, and generally accompany the œsophagus through the œsophageal ring (which lies *behind* the pharynx), and open on the posterior lateral wall of the latter.

Two pairs of salivary glands are found in certain *Diotocardia* (e.g. *Haliotis*, *Fissurella*), and further in *Patella*, the *Scalariidae*, *Ianthinidae*, certain *Purpuridae*, *Muricidae*, and in the *Cancellariidae*.

One of the two pairs of glands in *Haliotis* is developed in the form of large lateral glandular sacs covering the pharynx on the right and left (Fig. 105, p. 121).

In the *Ampullariidae*, the ducts of the salivary glands do not pass

¹ This differs somewhat from the description found in Simroth (Bronn's *Klassen und Ordnungen*, vol. iii. pp. 183-185).

through the œsophageal ring, which here, as in the *Diotocardia*, surrounds the anterior end of the pharynx.

Whereas the salivary glands are, as a rule, branched tubes or acinose, they are sometimes (*Scalariidae*, *Ianthinidae*, *Cancellariidae*) simply tubular or (*Doliidae*, *Xenophoridae*, etc.) sac-like.

The passage of the ducts of the salivary glands through the œsophageal ring in the *Monotocardia* may have come about by the shifting back of the ring along the pharynx from its former position in the *Diotocardia*, where it encircles the anterior end of the pharynx in front of the apertures of these ducts. The salivary ducts would thus necessarily become surrounded by the ring.

The ducts in the *Monotocardia* become the longer the further the nerve ring shifts back from the mouth and pharynx. They are very long in animals provided with a protrusible proboscis, where the ring lies far back on the œsophagus, behind the non-evaginable portion of the proboscis. The ducts here run along the whole length of the latter. But in those cases in which the œsophageal ring has shifted back more quickly than the ducts have lengthened, the glands lie in front of the ring. In the event of the subsequent lengthening of their ducts, the glands might stretch back outside the ring. The arrangement of the glands in the *Toxoglossa* and *Rachiglossa* would thus be explained; here the greater part of the glands lies behind the ring, although the ducts are said not to pass through it.

The acid secretion of the salivary glands of certain *Prosobranchia* (species of *Dolium*, *Cassis*, *Cassidaria*, *Tritonium*, *Murex*) and *Opisthobranchia* (*Pleurobranchus*, *Pleurobranchidium*) contains 2·18-4·25 per cent of free sulphuric acid. These carnivorous animals are able, by means of their proboscides, to bore into other Molluscs and *Echinoderms* which are protected by calcareous skeletons. The sulphuric acid in their glands probably serves for transmuting the carbonate of lime into sulphate of lime, which can then easily be worked through by the radula.

(b) **Pulmonata**.—Two salivary glands (Fig. 157, 10) are always found, their ducts entering the pharynx to the right and left of the boundary between it and the œsophagus. The glands lie on the œsophagus and the anterior part of the stomach in the shape of long, lobate, jagged leaves. In some cases they are acinose or round and compact.

(c) **Opisthobranchia**.—The salivary glands, of which only one pair is almost always found, here vary in size and shape still more than in the *Pulmonata*. These glands, which enter the pharynx, must not be confounded with other glands which in many *Opisthobranchia* enter the buccal cavity, and are sometimes more strongly developed than the salivary glands.

Dentalium has no salivary glands opening into the pharynx, for the glandular "cheek pouches" enter the buccal cavity, and two diverticula which lie further back belong to the œsophagus.

The **Cephalopoda** have a posterior and an anterior pair of salivary glands. Were the fore-gut, which here rises vertically in the visceral dome, to occupy the horizontal position it has in the *Gastropoda*, the anterior pair would lie dorsally and the posterior ventrally with regard to it. The two posterior glands (Fig. 127, 29, p. 147) are always present (except in *Cirrhoteuthis* and *Loligopsis*, in which they are said to be wanting), and lie on the cesophagus. Each gland has a duct, which soon unites with that from the other gland, forming a terminal portion which accompanies the cesophagus through the cephalic cartilage, and opens above the radula into the pharyngeal cavity. The posterior

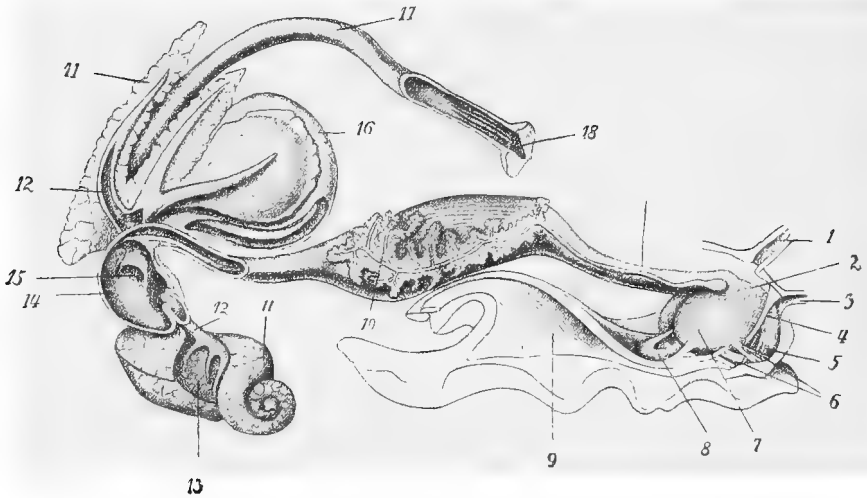

FIG. 157.—Alimentary canal of *Helix*, dissected out and seen from the right side (after Howes). 1, 3, Tentacles; 2, constrictor pharyngis; 4, levator pharyngis; 5, depressor; 6, protractor pharyngis; 7, pharyngeal bulb; 8, radular sheath; 9, columellar muscle, divided into a retractor pedis and retractor pharyngis; 10, salivary glands; 11, digestive gland (liver); 12, ducts of the same (gall ducts) partly cut open; 13, hermaphrodite gland; 14, stomach cut open, in its base are seen the apertures of the gall ducts 15; 16, mid-gut; 17, hind-gut; 18, anus.

glands occasionally (*e.g.* in *Oegopsidae*) fuse behind the gullet, in which case the duct is single throughout its whole length.

The anterior salivary glands are specially well developed in the *Octopoda* (Fig. 127, 33, p. 147), and lie on the pharynx, into which they empty their secretions by a duct, which seems always to be unpaired. In the *Decapoda* the anterior glands are much smaller or rudimentary; they are generally represented by a single gland hidden within the muscular wall of the pharynx.

Nautilus has no posterior salivary glands, but there are glandular outgrowths of the pharyngeal cavity on each side of the tongue, which perhaps correspond with the anterior salivary glands of other Cephalopods.

The Cephalopoda (? without exception) have an additional acinose

lingual gland, opening into that part of the pharyngeal cavity which lies between the tongue and jaws.

The *Lamellibranchia*, as already mentioned, have neither pharynx, jaws, tongue, nor salivary glands. In the *Nuculidae*, however, which are rightly considered to be primitive forms, the mouth leads into a widening of the intestine, on each side of which a glandular pouch opens. These pouches perhaps correspond with the œsophageal pouches of the *Chitonidae* and *Rhipidoglossa*, which will be described later.

Natica, which bores through the shells of living *Lamellibranchs* and feeds on their bodies, has a sucker-like organ on its proboscis (Fig. 98, p. 107). The epithelium of the concave side of this organ, which is applied to the shell attacked, forms a gland for secreting acid—probably sulphuric acid—which serves for dissolving the carbonate of lime of the bivalve shell, which is then at once thrown out in the form of powdered sulphate of lime.

C. The Œsophagus.

That portion of the intestine which lies between the pharynx (or the mouth in *Lamellibranchs*) and the stomach is called the œsophagus, the stomach being here used as the name of that widening of the intestine into which the gland of the mid-gut opens. It is always easy to detect the anterior boundary of the œsophagus. In *Lamellibranchs* it lies at the mouth, but in the *Glossophora* at the posterior and upper end of the pharynx. The posterior boundary, however, can often only arbitrarily be defined, as the œsophagus, which is usually narrow and tubular, often widens very gradually into the stomach, the structure of its walls at the same time gradually changing. In other cases, widenings of the alimentary canal occur before the stomach, and it is difficult to decide whether these are anterior divisions of the stomach or posterior widenings of the œsophagus.

In *Lamellibranchia*, terrestrial *Pulmonata*, most *Opisthobranchia*, and the *Cephalopoda Decapoda* the œsophagus is a simple ciliated tube running to the stomach, being often provided with longitudinal folds, and therefore extensible; in other divisions, however, complications occur, which are caused by glandular outgrowths or muscular enlargements.

In a few *Solenogastres* (e.g. *Proneomenia*), on the boundary between the short œsophagus and the mid-gut, a more or less long blind diverticulum occurs; this is single, and runs forward dorsally to the pharynx, and may extend over the cerebral ganglion to the end of the head.

In *Chiton* there are two lateral glandular sacs (**sugar glands**) connected with the short œsophagus; their inner glandular walls project into the lumen in the form of villi, and their secretion changes boiled starch into sugar.

Similar glands, which communicate with the anterior part of the œsophagus, are found in the *Rhipidoglossa* (e.g. *Haliotis*, *Fissurella*, *Turbo*). The glandular epithelium in these also projects in the form of villi or folds into the lumen.

The so-called crop of the *Docoglossa* (*Patella*) no doubt corresponds with the two lateral œsophageal sacs in the *Chitonidæ* and *Rhipidoglossa*. This is a saccular widening of the œsophagus (Fig. 158, *m*), which, on account of the constitution of its walls, has been compared with the psalterium of a Ruminant. A similar widening of the œsophagus is found in *Cypridæ* and *Naticidæ*, which must be counted among the most primitive of the *Monotocardia*.

In those *Monotocardia* which are provided with a proboscis, the length of the thin œsophagus is in proportion to that of the proboscis.

The mouth lies at the tip of the proboscis, then follows a short and often rudimentary pharynx, and then the long œsophagus, which runs through the whole length of the non-protrusible portion of the proboscis, passes through the œsophageal

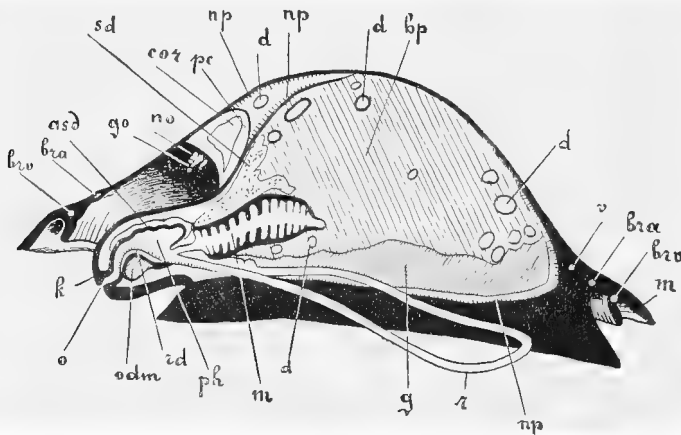

FIG. 158.—Median longitudinal section through *Patella* (after Ray Lankester). *brv*, Efferent branchial vessel; *bra*, afferent ditto; *asd*, duct of salivary gland *sd*; *go*, anus; *no*, right nephridial aperture; *sd*, salivary gland; *cor*, heart; *pe*, pericardium; *np*, kidney; *d*, intestine; *hp*, hepatic gland (liver); *v*, blood vessel; *m* (to the right), border of mantle covering the gills; *r*, radular sheath; *g*, gonads; *m*, crop; *ph*, pharynx; *rd*, radula; *odm*, masses of muscle and cartilage of the lingual apparatus; *o*, mouth; *k*, head or snout.

ring, and may be even further prolonged posteriorly. When the proboscis is retracted, the posterior portion of the œsophagus becomes coiled; when the proboscis is extended, it lies in the protruded or evaginated basal portion.

Not infrequently in carnivorous *Monotocardia* there is a glandular widening in that section of the œsophagus which follows the long proboscis. The œsophagus is most complicated in the *Rachiglossa* and many *Toxoglossa*, where this widening, in the form of a large compact accessory gland, can become separated from the intestine (**Leiblein's gland, poison gland**), and where other glands and widenings may occur (Fig. 159). It seems probable that in certain *Prosobranchia* digestion and resorption takes place even in the fore-gut.

In the *Pulmonata* and *Opisthobranchia*, there is sometimes a widening (crop, fore-stomach) anteriorly to the stomach, and in the same way the short œsophagus of the *Scaphopoda* has a glandular widening, or two lateral glandular diverticula.

Among the *Cephalopoda*, the *Decapoda* have a simple thin tubular œsophagus;

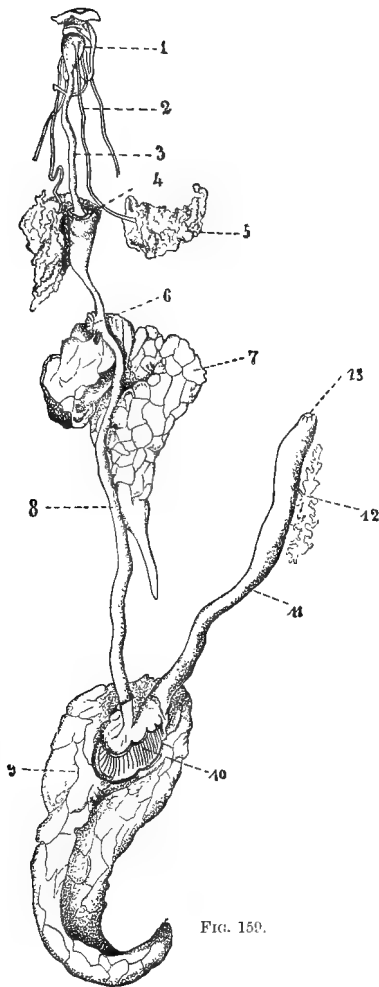

FIG. 159.

FIG. 159.—Alimentary canal of *Murex trunculus* (after Béla Haller). 1, Pharynx; 2, ducts of the salivary glands (5); 3, oesophagus; 4, 6, and 7, glands of the fore-gut (8); 9, digestive gland (liver); 10, stomach; 11, hind-gut; 12, gland of the hind-gut; 13, anus.

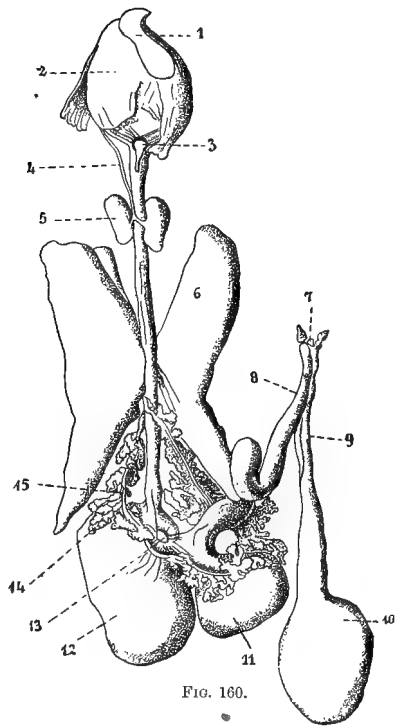

FIG. 160.

FIG. 160.—Alimentary canal of *Sepia*. 1, Jaw; 2, pharynx; 3, posterior buccal ganglion; 4, duct of the salivary gland (5); 6, digestive gland (liver); 7, anus; 8, rectum; 9, efferent duct of the pigment gland (ink-bag); 10, 11, stomachal coenm; 12, stomach; 13, ganglion gastricum; 14, "pancreatic appendages" of the gall ducts of the digestive gland.

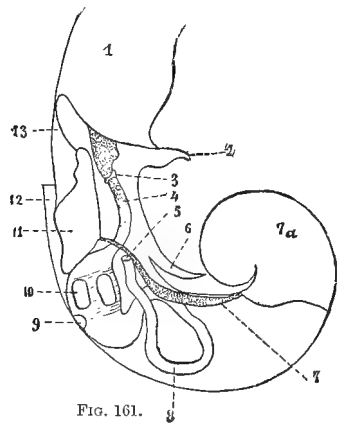

FIG. 161.

FIG. 161.—Sketch of the anatomy of *Limacina helicina*, from the right side, after removal of the mantle, heart, and kidney (after Pelseneer). 1, Fin (parapodium); 2, foot; 3, central nervous system (oesophageal ring); 4, oesophagus; 5, anus; 6, columellar muscle; 7, duct of the hermaphrodite gland, 7a; 8, intestine; 9 and 10, dental plates of the stomach; 11, accessory glands of the genital apparatus; 12, mantle cavity; 13, seminal groove or furrow.

the œsophagus of the *Octopoda*, however, is provided with a lateral pouch, the crop (Fig. 127, p. 147), whose walls are not glandular. This may serve as a reservoir of food when the stomach is already full. In *Nautilus*, the crop is a very large saccular widening of the œsophagus, larger than the stomach itself.

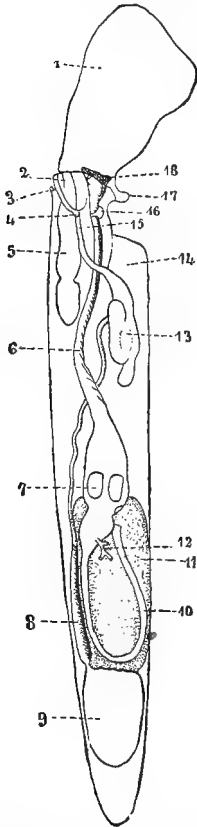

FIG. 162.—Diagram of the anatomy of *Clio striata*, from the right side; the heart, kidney, and mantle of this side removed (after Pelseneer). 1, Fin (parapodium); 2, aperture of the penis; 3, right tentacle; 4, genital aperture; 5, penis; 6, œsophagus; 7, dental plates of the stomach; 8, ducts of the gonad; 9, gonad; 10, intestine; 11, digestive gland; 12, ducts of the same (cut off); 13, accessory glands of the genital apparatus; 14, mantle cavity; 15, terminal portion of the genital ducts; 16, central nervous system (ganglion ring); 17, foot; 18, pharynx.

D. The Mid-gut with the Stomach and Digestive Gland (Liver).

The œsophagus leads into a wider portion of the alimentary canal, the stomach. Into this the ducts of a gland open; this gland is strongly developed in nearly all Molluscs, and is usually called the liver, but may be more appropriately named the digestive gland, since it in no way fulfils the functions of the vertebrate liver. As far as is at present known, it functions rather as a pancreas, or it combines the functions of the various digestive glands of the vertebrate intestine, no such thorough division of labour as is found in the Vertebrates having taken place. The digestive gland is, in most cases, a richly-branched tubular or acinose gland, which to the naked eye appears a compact lobate body of a brown, brownish-yellow, or reddish colour. Its glandular epithelium consists of three sorts of cells—**hepatic, ferment, and calcareous cells**. In many *Nudibranchia* the gland breaks up into branching intestinal diverticula, which spread through the body almost like the gastro-canals or intestinal branches in the *Turbellaria*, and run up into the dorsal appendages of the body (cladohepatic *Nudibranchia*).

Chaetoderma, among the *Solenogastres*, has a simple midgut diverticulum, which may correspond morphologically with the digestive gland of other Molluscs; but in *Proneomenia*, *Neomenia*, etc., the straight mid-gut is provided throughout its whole length with narrow lateral glandular sacs arranged closely one behind the other at right angles to it.

A part of the mid-gut gland (the part nearest to the point where the duct leaves it) and the glandular epithelium of the duct may be specially differentiated in *Cephalopoda*, and may, finally, form a distinct system of glands called the pancreas (Fig. 160).

The stomach is not infrequently a lateral outgrowth of the mesenteric wall, so that the aperture (cardia) leading into it from the oesophagus and that leading out of it into the small intestine (pylorus) are more or less near one another. A sort of connection between these apertures may arise, a ciliated furrow or channel bounded by longitudinal folds running between them, and in some cases continued into the adjoining sections of the alimentary canal.

In the *Cephalopoda*, the duct of the digestive gland (the so-called hepatic or gall duct) does not open direct into the stomach, but into a coecal outgrowth of the stomach, the **spiral cœcum**.

In very many *Lamellibranchia* there is a diverticulum of the stomach which contains within its lumen a rod-shaped gelatinous cuticular formation, called the **crystalline stylet**. Similar structures occur in the *Prosobranchia*, and especially in the *Rhipidoglossa* and *Toxoglossa*.

In many *Opisthobranchia*, the inner wall of the stomach carries variously-arranged cuticular teeth, dental plates, jaw plates, etc., which serve for triturating the food. In such cases the muscular wall of the stomach is strongly developed.

The stomach is succeeded by a narrower tubular section of the mid-gut, called the **small intestine** (intestinum), which usually forms coils or loops; these are more numerous in herbivorous or detritivorous than in carnivorous Molluscs.

The stomach, small intestine, and digestive gland, together with part of the sexual organs, compose the whole or by far the largest portion of the visceral dome, where this is present.

1. Amphineura.

The Chitonidæ show the typical division of the mid-gut into stomach, digestive gland, and small intestine. The stomach lies far forward, and has a wide outgrowth on one side, which is, functionally, a reservoir of secreted matter. The cardia and the pylorus lie near one another. The digestive gland is paired; the larger liver to the right has four apertures, while the smaller one to the left has only one principal aperture into the stomach. The small intestine is more than four times as long as the body, and it forms many loops which are constant in their arrangement. *Chiton* feeds on small or even microscopic algae.

Unlike the *Chitonidæ*, the *Solenogastres* show no separation of the mid-gut into stomach and small intestine. The mid-gut runs straight through the body, the greater part of which it fills. The glandular lateral cœca found in *Neomenia*, *Proneomenia*, etc., and called hepatic diverticula, are caused by the projection into the lumen from

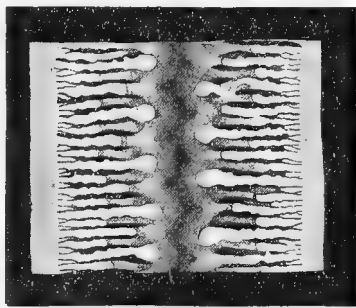

FIG. 163.—Part of a horizontal median section through *Proneomenia Sluiteri*. Septa of the first, second, third, and fourth order are seen projecting from the right and left into the lumen of the mid-gut. In the background is the dorsal wall of the gut, with the groove which cuts into the hermaphrodite gland (cf. Fig. 53, p. 42).

each side of narrow septa arranged at right angles to the gut, or transversely (Fig. 163); in these septa, muscle fibres run down to the rudimentary foot, and blood lacunae abound. In *Pronemena Sluiteri*, septa of the first, second, third, or fourth order can be distinguished, as seen in the figure. The septa on the right alternate with those on the left side of the body. In the dorsal middle line the mid-gut forms a narrow ciliated longitudinal groove which cuts deep into the gonad, cilia are also found on its medio-ventral surface.

2. Gastropoda.

The digestive gland of the Gastropoda falls into two or more lobes, between which the stomach and the coils of the small intestine lie embedded. One, two, or more ducts of the gland may open into the stomach. The walls of the digestive gland show the same division into layers as the wall of the alimentary canal. For details as to the ferment, hepatic, and calcareous cells forming the epithelium of the gland, and their physiological constitution, the reader must be referred to special histological and physiological treatises.

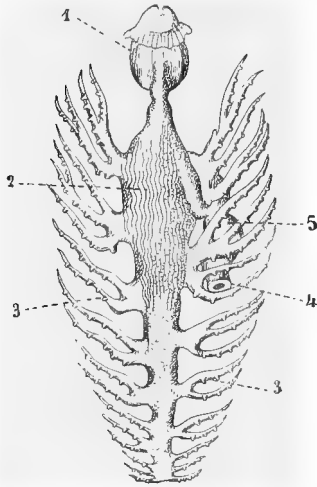

FIG. 164.—Alimentary canal of *Aeolis* (after Souleyet). 1, Pharynx; 2, stomach; 3, branched digestive gland (liver); 4, anus; 5, rectum.

In the *Nudibranchia*, as already mentioned, the digestive gland breaks up into a system of glandular diverticula (the so-called "diffuse liver"). The *Aeolidiadae* (e.g. *Tergipes*) afford an instructive instance of this. Three diverticula rise from the stomach, two anterior and lateral, and one posterior and unpaired. These ramify in the body cavity, and finally send up their last ramifications or lobes into the dorsal appendages. The contents of the intestine can penetrate into these last ramifications of the "diffuse liver" (Fig. 164).

Further, within the *Nudibranchia* the breaking up of the compact digestive gland to form a "diffuse liver," i.e. the loosening from one another, and the spreading out of the glandular tubes which are in close contact in the compact gland, can be followed almost step by step. In the *Tritonidae* the gland is a great compact mass. In other families, such as the *Tethymelibidae*, *Lomanotidae*, *Dendronotidae*, *Bornelliidae*, *Scyllaridae*, it divides into two anterior accessory livers and a posterior principal liver, from which diverticula run up into the dorsal appendages. Finally, the accessory and principal livers break up into separate "hepatic branches" (*Acolidae*), which in some cases anastomose. The posterior principal branch of the "diffuse liver" gives off specially numerous lateral branches; it often widens out to a pouch, and may then be compared to an extended gall bag, or a posterior diverticulum of the stomach. In *Phyllirhoë*, a pelagic form, without dorsal appendages, the "diffuse liver" is simplified, consisting of four unbranched blind tubes, the two anterior opening into the stomach separately, the two posterior entering it together (Fig. 19, p. 12).

The stomach of many *Opisthobranchia* consists of two divisions separated by a constriction. In some forms, such as the *Bullidae* among the *Tectibranchia*, the *Pteropoda thecosomata*, and the *Tethymelibidae*, *Bornelliidae*, *Scyllaridae*, among the *Nudibranchia*, it is armed with hard chitinous plates, spines, teeth, etc., occurring in varying number and arrangement on its inner wall (Figs. 161 and 162)

3. Scaphopoda.

The mid-gut of *Dentalium* (Fig. 165) consists of a looped stomachal tube bent

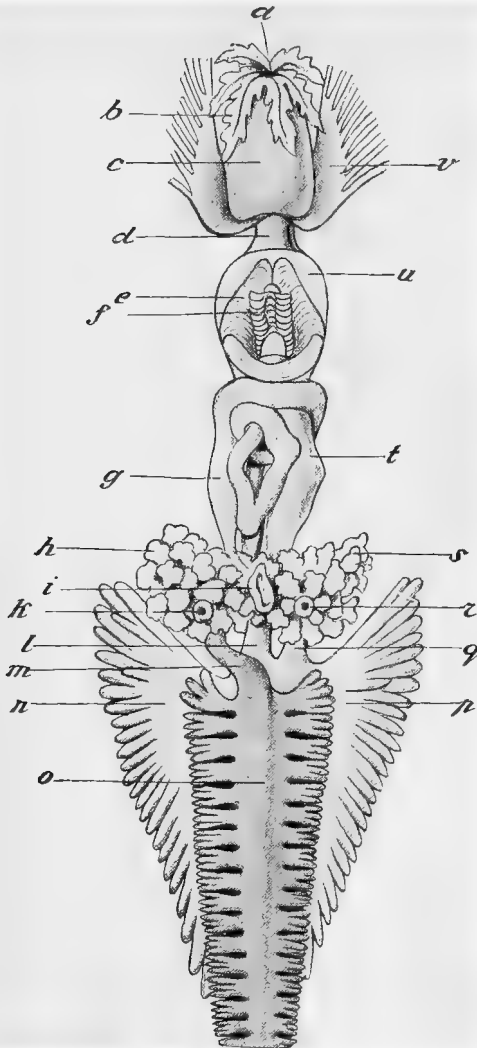

FIG. 165.—Alimentary canal, kidney, and sexual organs of *Dentalium*, from behind (after Lacaze-Duthiers and Leuckart combined). *a*, Mouth; *b*, leaf-like oral tentacles; *c*, snout; *d*, entrance to pharynx; *e*, pharynx with radula, *f*; *g*, hind-gut; *h*, right kidney; *i*, anus; *k*, right nephridial aperture; *l* and *q*, ducts of the digestive gland, *n*; *m* and *o*, gonad; *n* and *p*, digestive gland (liver); *r*, left nephridial aperture; *s*, left kidney; *t*, stomach; *u*, pharynx; *v*, lobes or sails on which the filamentous tentacles are placed.

back on itself, and of a small intestine lying in a tangled coil behind the cesophagus.

Two digestive glands, lying in the upper part of the body, open through wide apertures into the stomach. Their form can be gathered from Fig. 165.

4. Lamellibranchia.

In the Lamellibranchia the cesophagus, which lies under the anterior adductor, widens at the anterior base of the foot to form the stomach. This descends somewhat into the foot. At the posterior base of the stomach lie two apertures; one of these is the pylorus, and leads into the small intestine which runs more or less coiled within the base of the foot; the other leads into a tubular diverticulum, the sheath of the crystalline stylet. The large richly-branched acinose digestive gland (liver) opens through several apertures into the stomach, with which it lies in the anterior part of the pedal cavity. In *Pholas*, *Jouannetia*, and *Teredo*, the stomach has another cœcum besides the sheath of the crystalline stylet. In all bivalves there is, on the inner wall of the stomach, a gelatinous cuticular structure (dreizackiger Körper, flèche tricuspidé), which varies in thickness, and is continued into the gelatinous crystalline stylet. This latter is secreted in concentric layers as a cuticular structure by the epithelium of the sac in which it lies. A plausible suggestion has recently been made as to the use of these gelatinous structures, viz. that they serve for surrounding with a slimy envelope foreign particles, such as sharply-pointed grains of sand, which enter the alimentary canal with the food; injury to the delicate walls of the intestine is thus avoided, and the travelling of such particles along the digestive tract is facilitated. The point of the crystalline stylet projects freely into the lumen of the intestine. In some forms it does not lie in a separate sac, but in a groove (*Najada*, *Cardium*, *Mytilus*, *Pecten*, etc.). The tricuspid body and the crystalline stylet appear temporarily, and are renewed periodically. Similar structures have been observed in the stomachs of various *Gastropods*. *Haliotis* has a stomachal cœcum which can be compared with the sheath of the crystalline stylet.

In the lower *Lamellibranchs*, the *Nuculidæ* and *Solenomyidæ*, the stylet is either very slightly developed or wanting. In the *Arcidæ* also, it is only slightly developed.

The *Septibranchia* (*Poromya*, *Cuspidaria*) are distinguished from all other *Lamellibranchia* by the absence of coils, and the consequent shortening of the small intestine (cf. on the intestine of the *Lamellibranchia*, Figs. 24, 25, 26, 27, 28, pp. 16, 17, 18, 19).

5. Cephalopoda.

The stomach in the Cephalopoda always lies in the dorsal portion of the visceral dome in the shape of a sac with a strong muscular wall. It always has a cœcal appendage (stomachal or spiral cœcum, Figs. 166, 160), which varies in shape and size; into this the digestive gland (liver) opens. This cœcum is a reservoir for the secretion of the digestive gland. Food never enters it, there are even valves at the point of entrance into the stomach, which allow the secretion collected in the cœcum to pass into the stomach, but prevent the entrance of the contents of the latter into the cœcum.

In *Nautilus*, the cœcum does not open into the stomach, but into the commencement of the small intestine, and is in the form of a small round vesicle with lamellæ projecting into its lumen. In *Sepia* and *Sepioteuthis* also, the cœcum is more or less round; in *Rossia*, it is slightly developed; in *Loligo* and *Sepioteuthis*, very long and ending in a point; in all *Oegopsidæ* and *Octopoda*, more or less spirally coiled at the blind end.

The well-developed digestive gland seems to arise as a paired organ, even when

unpaired in the adult. The whole of the much branched gland is surrounded by a common integument, and it thus outwardly appears to be compact.

The digestive gland of *Nautilus* consists of five lobes (four paired and one unpaired), which lie around the crop. They have two ducts, which enter the cœcum through a short common terminal portion.

In the *Dibranchia* also, the digestive gland always lies on the ventral side of the stomach, close to the ascending œsophagus. It is undivided, and round or oviform in the *Octopoda*, *Oegopsida*, and *Sepiolo*. In *Loligo* and *Sepioteuthis*, it is traversed by the œsophagus and the aorta; in *Enoploteuthis*, its dorsal half is cut into two points by these organs; and the same is the case in *Rossia*. In *Sepia* and *Spirula*, the gland forms two lateral lobes which are distinct in *Sepia*, but connected along the middle line in *Spirula*.

There are always two ducts (gall ducts) which rise near the median plane from the upper part of the gland, and open into the stomachal cœcum separately or through a common terminal portion.

The following facts have been ascertained as to the function of the so-called **pancreas** of the Cephalopoda. It is originally a specially differentiated portion of the digestive gland, and is easily distinguishable in the *Octopoda* by its different colour; it lies near that part of the gland from which the ducts spring. In *Loligo*, the pancreas is found in the much thickened wall of the ducts themselves. In this case it consists of numerous glandular anastomosing outgrowths of the epithelium of the ducts into their wall. In other *Decapoda*, these glandular outgrowths pass from the wall of the ducts into the surrounding body cavity, and then each duct appears throughout its whole length to be covered with acinose or ramified "pancreatic appendages." The pancreatic secretion contains diastase, and appears to carry out only one part of the functions of the digestive gland, viz. that part which corresponds with the digestive functions of the salivary glands in the higher Vertebrates.

The small intestine, in which among all Molluscs the resorption of the digested food chiefly (if not exclusively) takes place, is short in the carnivorous *Cephalopoda*, and forms several coils only in *Tremoctopus violaceus*.

E. Hind-gut (Rectum).

This is generally short in Molluscs. Where it is sharply marked off from the small intestine, it usually differs from the latter in being thicker and more muscular.

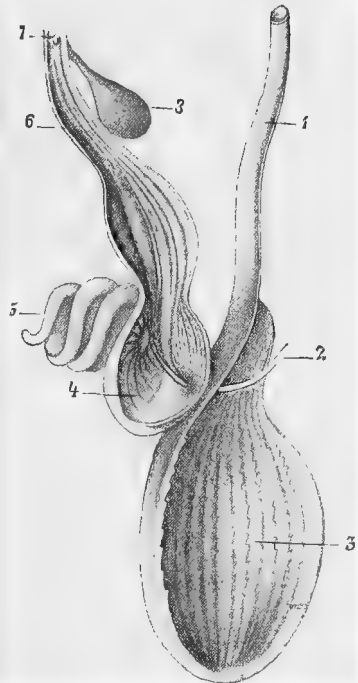

FIG. 166. — Alimentary canal of *Loligo sagittata* (without pharynx and salivary glands) partly cut open (after **Gegenbauer**). 1, œsophagus; 2, probe, inserted into the pylorus; 3, stomach; 4, stomachal cœcum with spiral cœcum 5; 6, hind-gut; 8, ink-bag; 7, aperture of the same into the hind-gut.

In the majority of *Lamellibranchs*, and in nearly all *Diotocardia*, the **rectum traverses the ventricle**; this fact, with many others, supports the relationship of these two groups.

In certain Molluscs, viz. the *Scaphopoda*, a few *Prosobranchia* (*Muricida*, *Purpuridae*), and the *Cephalopoda*, the hind-gut has an accessory (anal) gland, which is well known in the *Cephalopoda* as the **ink-bag**.

The rectal gland in *Dentalium* is a branched acinose gland opening into the hind-gut, according to one account through six separate ducts, and according to another through one single duct. Eggs and spermatozoa have been met with in the lumen of this gland, and it has been supposed that they have been accidentally drawn out of the mantle cavity by the swallowing-like action of the hind-gut, which has been observed in *Dentalium*.

The anal gland found in some *Rachiglossa* (*Monoceros*, *Purpura*, *Murex*) is always dark in colour (brown or violet), and is either tubular with many bulgings of its wall, or acinose with an axial duct. It always enters the hind-gut near the anus.

A gland has been found near the rectum in the *Pteropoda thecosomata* (*Clio*, *Cavolinia*) and the *Bulloida*, and has been described as an anal gland, but this requires further investigation.

The **ink-bag** of the *Cephalopoda* (Fig. 167), which is wanting only in *Nautilus*, is a much developed anal gland. It enters the hind-gut near the anus. The ink or sepia pigment secreted by it consists of extremely minute particles which are ejected with vehemence from the bag and discharged through the funnel. The pigment quickly mixes with the water, and envelops the animal in a pigment cloud, thus screening it from its enemies.

Form and position of the ink-bag (cf. Figs. 160, p. 189; 177, p. 213; 178, p. 214).—The typical position of the ink-bag is in front of the rectum, *i.e.* in the loop formed by the intestine in ascending from the mouth and then descending to the anus. In *Spirula*, *Enoploteuthis*, and *Sepioteuthis*, the ink-bag is very small; it progressively increases in size in series both of *Decapoda* and of *Octopoda*, its division into a saccular portion and a duct opening into the hind-gut in front of the anus becoming more and more distinct. In the *Octopoda*, it lies embedded in the upper part of the liver within the muscular hepatic capsule (cf. p. 128). It is still found in this position (between the liver and the rectum) in *Sepiola*. In other *Decapoda*, however, the ink-bag is found shifting higher and higher in the visceral dome, its duct at the same time increasing in length. Finally, in *Sepia* (and the fossil *Dibranchia*), it is found at the top of the visceral dome, behind the gonad. Its duct runs along the right side of the hind-gut, bending round somewhat before reaching the anal section of the rectum so as to enter the latter anteriorly. Ontogenetically, however, even in *Sepia*, the ink-bag arises as an *anterior* outgrowth of the rectum.

Structure of the ink-bag in Sepia (Fig. 167 A).—The ink-bag in this instance consists of three parts: (1) the pigment gland which secretes the "ink"; (2) the pigment reservoir and the duct, which forms (3) an ampulla with a glandular wall near its aperture. The pigment gland is a sac at the base of the ink-bag on its anterior wall (that turned towards the gonad). It projects into the cavity of the ink-bag,

which serves as reservoir and duct for the pigment. The latter, after being formed in the gland, passes through an aperture in its wall into this reservoir. The cavity of the gland is traversed by numerous perforated and richly vascularised lamellæ of connective tissue, which are inter-connected in such a way as to form a kind of sponge-like structure. New lamellæ are continually being put forth by the formative zone of the gland, which is a narrowed portion bent back downwards, while the oldest lamellæ, which lie nearest the aperture of the gland, become detached and degenerate. All the lamellæ are covered by a glandular epithelium and the formation of the pigment can be traced in all its stages from its appearance in the epithelial cells of the formative zone to its condition in those of the oldest lamellæ. In the formative zone, the young glandular cells are at first colourless. In the succeeding lamellæ, however, pigment granules increase in number and from the older lamellæ are emptied into the cavity of the gland, the epithelial cells then becoming detached and breaking up.

Both the gland and the reservoir are surrounded by a vascularised integument of connective tissue; the same integument forms the framework of connective tissue running through the lamellæ or trabeculæ within the gland.

The ink-bag is further enveloped as a whole in a tough integument consisting of three layers: (1) an inner glittering silvery layer (argentea), similar to the corresponding layer in the outer integument; (2) a central muscle layer (inner longitudinal and outer circular muscles; and (3) an external layer of connective tissue.

The terminal ampulla has, at its two narrow ends, folds projecting inward and functioning as valves; it can be closed at these parts by sphincter muscles. The

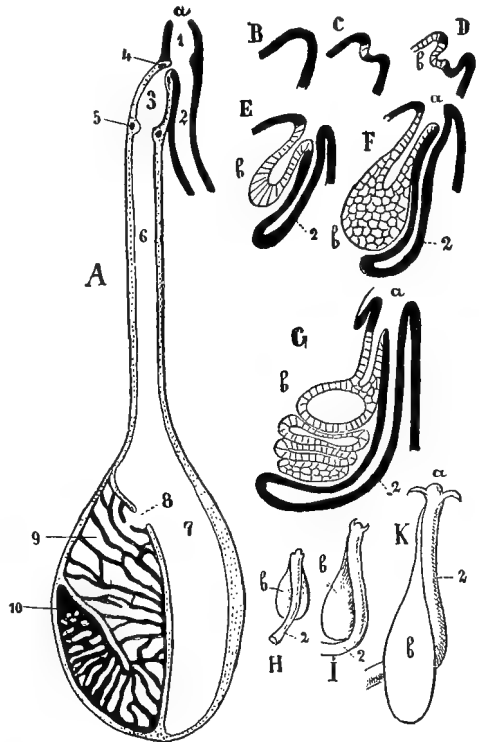

FIG. 167.—Morphology of the pigment gland (ink-bag) of the Cephalopoda (after P. Girod). A, Median longitudinal section through the ink-bag of an adult. α , Anus; 1, terminal portion common to the rectum (2) and the duct of the ink-bag; 3, ampulla; 4 and 5, sphincter muscles of the ampulla; 6, duct of the ink-bag; 7, pigment reservoir; 8, opening of the pigment gland into the reservoir; 9, portion of the gland traversed by lamellæ; 10, formative zone of the lamellæ. B-G, Various stages in the development of the pigment gland; B, anal papilla; C, invagination in the same; D, appearance of two new depressions at the base of C; these increase in depth, the one becoming the pigment gland b , the other the rectum 2. In F, the formative zone has appeared in the gland, in G, the first lamellæ and the duct. H, I, K, changes in the relative positions of the rectum and gland in the course of development, seen from the posterior (mantle) side. In H, the rectum lies behind the ink-bag. In I, the latter has shifted, and in K lies behind the rectum (on the mantle side).

ampulla itself also forms longitudinal folds on its inner surface, between which glandular tubes open.

The anus, in the Cephalopoda, always carries two lateral projecting appendages, which are often lancet-shaped.

The short and narrow hind-gut of the *Solenogastres* opens into the dorsal portion of a cavity, the **cloaca**, which lies at the posterior end of the body; this, again, communicates with the exterior by means of a ventral and very extensible longitudinal slit. Into this cloaca the ducts of the genital organs, which are morphologically to be regarded as nephridia, also open.

In the *Lamellibranchia*, after the hind-gut has traversed the heart, it runs straight backward over the posterior adductor, to open through the anus into the posterior and upper portion of the mantle cavity (anal chamber).

On the position of the anus, cf. Section V. on the arrangement of the organs in the mantle cavity.

XVII. The Circulatory System.

A. General.

All Mollusca have a circulatory system; in some divisions, especially in the *Cephalopoda* and some *Prosobranchia*, this may attain a high level of complication by the development of a closed arterial and venous vascular system. The **heart**, as the central organ of propulsion, is never wanting. It lies enclosed in the **pericardium**, a division of the secondary body cavity; its primitive position is median, above the hind-gut. In the *Lamellibranchia* and *Diotocardia*, it is traversed by the hind-gut, in other *Gastropoda* it lies near it. It is always arterial, *i.e.* it pumps the blood flowing from the respiratory organs back into the body.

In those symmetrical Molluscs in which the dorsal portion of the body rises as a high visceral dome, the intestine first ascending into the dome and then descending to the anus, the heart comes to lie behind the hind-gut (*Dentalium*, *Cephalopoda*).

In asymmetrical *Gastropoda*, its position depends upon that of the pallial complex. Where the hind-gut and anus have shifted with the pallial organs to the anterior side of the visceral dome, the heart also lies anteriorly (*Prosobranchia*, *Pulmonata*, a few *Tectibranchia*).

The heart gives rise, as a rule, to **two large arteries (aorta)**, one of which runs to the head, the other to the visceral dome, to supply blood to the viscera. Not infrequently they leave the heart as one large vessel. Where the circulatory system is not closed, the arteries sooner or later convey the blood to the primary body cavity or cœlom, *i.e.* into the lacunar system. The venous blood is sometimes conveyed along distinct vessels, sometimes in channels without proper walls into

the gills, where it becomes arterial and flows back through the **auricles** (**atria**) into the heart.

There is, typically, one pair of auricles, one on each side of the ventricle. This is the case in all Molluscs provided with two symmetrical gills. The arterial blood flows out of the left gill into the left auricle and thence into the ventricle, and out of the right gill into the right auricle and thence into the ventricle (*Diotocardia*, *Zeugobranchia*, *Lamellibranchia*, *Cephalopoda Dibranchia*). Again, where a longitudinal

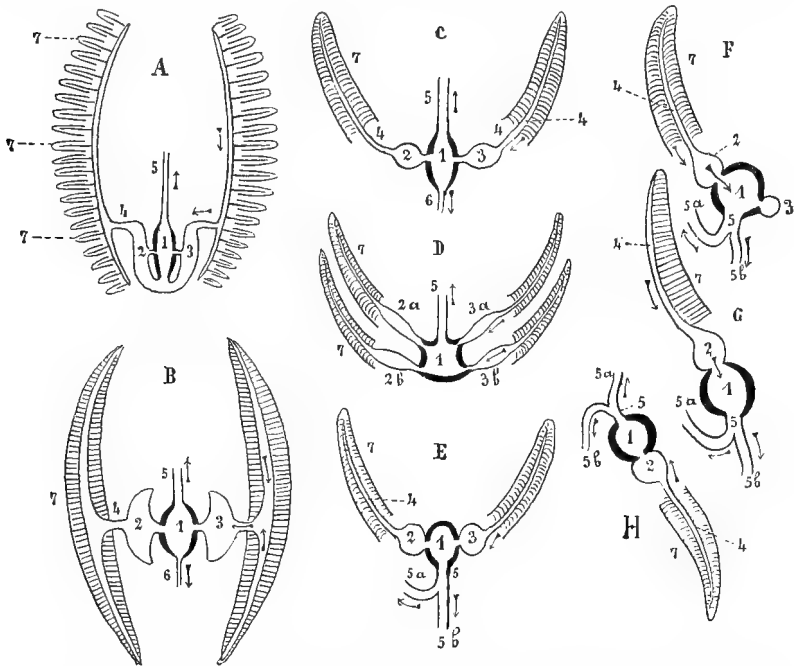

FIG. 168.—A-H, Diagrams illustrating the relation between the ctenidia, the heart, and the aorta. A, *Chiton*; B, *Lamellibranchia*; C, *Dibranchiate Cephalopoda*; D, *Tetrabranchiate Cephalopoda*; E, *Prosobranchia Diotocardia Zeugobranchia*; F, *Prosobranchia Diotocardia Azygobranchia*; G, *Prosobranchia Monotocardia*; H, *Opisthobranchia Tectibranchia*. 1, Ventricle; 2, 3, 2 α , 2 β , 3 α , 3 β , auricles; 4, vena branchialis—effluent branchial vessel; 5, aorta; 5 α , aorta cephalica; 5 β , aorta visceralis; 6, aorta posterior vel superior; 7, ctenida.

row of numerous gills is found on each side in the mantle furrow (*Chitonidae*), the heart lies posteriorly above the hind-gut, and has one auricle on each side of the ventricle. This fact appears quite as much to support the view that one pair of gills and one pair of auricles were present in primitive Molluscs, as does the arrangement in *Nautilus* (*Cephalopoda Tetrabranchia*) the other view, that there were two pairs of gills and also two pairs of auricles.

In the majority of *Gastropoda*, where one of the two original gills has disappeared, the auricle belonging to it has usually also disappeared.

The original right gill and right auricle are usually retained in *Gastropods* with shells dextrally twisted. In *Gastropods* with a true sinistrally twisted shell, the left gill and left auricle are retained.

There is, however, a whole division of the *Prosobranchia*, the *Diotocardia*, in which both auricles are retained. It is evident that the gills are more liable to disappear than the auricles, since in some groups both auricles remain when one gill has disappeared (for details see opposite page).

When, in *Gastropoda* with only one auricle, the pallial complex has shifted to the anterior side of the visceral dome, the respiratory organs lie in front of the heart, and the single auricle in front of the ventricle (*Prosobranchia*, *Monotocardia*, most *Pulmonata*, a few *Opisthobranchia*). In those *Gastropoda*, however, in which the pallial complex lies on one (usually the right) side of the body, the gill is placed behind the heart and the auricle behind the ventricle. This is the case in nearly all the *Opisthobranchia*. In a few *Pulmonates* also, such as *Testacella*, *Oncidium*, etc., the auricle lies behind the ventricle, as a consequence of special organic modifications.

The blood, or rather the hæmolymp, is a fluid rich in dissolved albumen (hæmocyanine), which assists in nourishing the body and in respiration. Amœboid cells, the lymph cells or amœbocytes, are suspended in the hæmolymp. Hæmoglobin is occasionally found dissolved in the hæmolymp or combined with special blood corpuscles. The lymph cells either become detached from the wall of localised **blood-making glands**, which may vary in position, or, in a more diffused manner, from large vascular areas. They seem, from their origin, to be cells of connective tissue.

The walls of the heart and of the walled vessels consist of smooth muscle fibres thickly felted, and (on the heart) of an external endothelium which belongs to the pericardium. An inner endothelium is wanting, so that the muscle fibres are directly bathed by the blood.

The wall of the ventricle is always more muscular than those of the auricles. At the point where the auricles open into the ventricle, valves projecting into the lumen are always found, which, when the latter contracts, prevent the return of blood into the auricle. Besides these atrio-ventricular valves, there are occasionally other valves between the ventricle and the aorta. Valves may also occur in the peripheral blood channels, when these form contractile enlargements (*e.g.* the valve between the branchial heart and the afferent branchial vessels of the *Cephalopoda*).

In various *Gastropods* and in *Chiton* a network of ganglion cells and nerve fibres has been found in the wall of the heart, innervated by two nerves of different origin. The nerve which runs to the ventricular plexus originates, in the *Prosobranchia*, in the left parietal ganglion, that running to the auricle from the left parieto-visceral connective. Where there are two auricles, they are innervated from the branchial ganglia.

B. Special.

1. Amphineura.

a. Chitonidæ (Polyplacophora).—The heart is symmetrical, with two lateral auricles.

The ventricle and the two auricles are long tubes. The auricles are in open communication with the ventricle about the middle of their length. Besides this, the two auricles pass into one another posteriorly, the posterior end of the ventricle also opening into them at this point.

The ventricle lies against the dorsal wall of the pericardium, to which it is attached by a median band of endothelium. The ventricle passes into an aorta which allows the blood to flow into the cœlom through apertures in its wall. With the exception of the pedal arteries, the rest of the circulatory system is lacunar; there are no vessels with walls of their own.

The venous blood is collected from the lacunar system of the body (primary cœlom) into longitudinal channels which run on each side under the pleurovisceral cords. From these channels it flows into the gills, where it becomes arterial, and returns through other longitudinal channels which run above the pleurovisceral cords. Two transverse channels in the region of the heart (*cf.* Fig. 51, p. 40) convey the arterial blood into the auricles.

The two pedal arteries lie laterally and ventrally with regard to the pedal cords; they probably draw their blood from the aorta and pass it on to the lacunar system of the foot.

b. Solenogastres.—The heart lies above the hind-gut on the dorsal side of the pericardium. It does not lie freely in the latter, nor is it suspended by an endothelial band, but simply projects into the pericardium from above, so that only its under surface is covered by the pericardial endothelium. The presence of two auricles has not been proved. The rest of the circulatory system is purely lacunar. Specially large blood channels lie in the depths of the principal septa which project into the mid-gut, and bulge these out. Large blood sacs are also occasionally found in folds which project into the pharyngeal cavity from its wall, and there are more or less large sinuses in the folds, which, in *Neomenia* and *Chetoderma*, project into the cloaca and may be regarded as gills. In all these parts the intestinal epithelium separating the sinus from the intestine is ciliated, and respiration no doubt takes place.

2. Gastropoda.

Relation of the auricles to the ventricle.—The lowest Gastropods, *i.e.* the *Diotocardia* among the *Prosobranchia*, have a heart with two auricles. This is not only the case in the *Zeugobranchia* (*Fissurella*, *Haliotis*, etc.), which have two gills, but also in the *Azygobranchia* (*Turbinidæ*, *Trochidæ*, *Neritidæ*), in which only the left (originally the right) gill has been retained. No branchial vein then enters the smaller (rudimentary) auricle on the right, the veins having atrophied with the gill. In the *Zeugobranchia*, the long ventricle lies in a line with the hind-gut, which runs length-wise through it. In the *Azygobranchia*, the ventricle lies transversely with respect to the hind-gut which runs through it, the left auricle lying in front of the ventricle, and the right auricle behind it. The left branchial vein enters the anterior (left) auricle. If we suppose the posterior (right) auricle to have disappeared altogether, as is the case in all other Gastropoda, the heart consists of a ventricle and one auricle lying in front of it, which receives the branchial or pulmonary vein from the gill or lung in front of it.

This serial order of the ventricle, auricle, branchial or pulmonary vein and respiratory organs is characteristic of the *Azygobranchia*, *Monotocardia*, and most *Pulmonata*.

The *Docoglossa* (*Patella* and allied forms) have only one auricle; the ventricle in *Patella* (not in *Acmea*), however, is divided into two parts.

Among the *Monotocardia*, only *Cypræa* (as far as is at present known) has a rudimentary right auricle, closed on all sides except at its aperture into the ventricle.

Among the *Pulmonata* there are forms in which **the auricle lies behind the ventricle**. This must be regarded as a secondarily acquired position, determined by the shifting back of the anus and the mantle cavity to the posterior end of the body (*Testacella*, *Oncidium*). In *Daudebardia*, the auricle still lies in front of the ventricle; nevertheless this genus, like several other shell-less *Pulmonates*, is opisthopneumonic, *i.e.* its respiratory network lies chiefly behind the heart. In *Testacella*, the auricle also lies behind the heart (*cf.* p. 77).

In the *Opisthobranchia*, the auricle lies behind the ventricle; this is connected with the position of the gill at the posterior end of the body, or where no true ctenidium is found, but where respiration takes place by means of anal gills, or dorsal appendages, or through the integument, with the point of entrance of the branchial vein into the heart from behind.

In a few *Tectibranchia*, *e.g.* *Actæon*, *Aceva*, *Gastropteron*, the gill lies somewhat far forward, and the auricle is then placed laterally, to the right of the ventricle rather than behind it.

It is of great importance, with regard to the position of these organs in the *Lamellibranchia*, to note the fact that, in many *Diotocardia* (*e.g.* *Fissurella*, *Haliotes*, *Turbinidæ*, *Trochidæ*, *Neritidæ*, *Neritopsidæ*, etc.) the ventricle is traversed by the hind-gut, while in all other *Gastropods* the intestine merely runs past it.

Circulation. (*a*) **Prosobranchia.**—A large vessel, the aorta, springs from the ventricle. This soon divides into two branches: (1) the anterior or cephalic aorta (**A. cephalica**), and (2) the posterior aorta (**A. visceralis**).

The anterior aorta conveys blood to the anterior part of the body (head, pharynx, proboscis, cesophagus, stomach, copulatory organs) and to the mantle, and gives off among others the important **arteria pedalis**; this latter soon breaks up into separate arteries, which run longitudinally through the foot. In some cases the cephalic aorta is richly branched, breaking up into numerous fine vessels which spread out in and on the above-mentioned organs; in others, the arteries, without branching, open into arterial sinuses. Among these, the large cephalic sinus into which the anterior aorta opens (*e.g.* in *Haliotis*) deserves special mention. Where the cephalic aorta runs beyond the cesophageal ring formed by the central ganglia and their commissures, it passes through this ring.

The aorta *visceralis* supplies the organs which lie in the visceral dome, especially the digestive gland, the genital glands, and the mid-gut.

The venous blood collects in the lacunar spaces of all parts of the body, and flows into a large **venous sinus**, *i.e.* into the space in which the stomach, salivary glands, intestine, digestive gland, and genital organs lie. This space or primary body cavity is somewhat spacious round the stomach, but very limited in the visceral dome, where the lobes of the digestive gland, the walls of the intestine, and the genital glands with their accessory parts are so crowded together as to leave very narrow spaces between them.

The blood passes out of the large venous sinus back into the heart by three channels.

1. A large part of it flows through lacunæ or vessels into the paired or unpaired branchial artery (afferent branchial vessel). In the course of branchial respiration the blood becomes arterial, and collects in an efferent branchial vessel (*cf.* section on the respiratory organs, p. 84), which, as branchial vein, conducts it to the auricle of the heart. Where there are two gills, there are naturally two branchial arteries and two branchial veins, the latter conducting the arterial blood to the two auricles.

2. Another part of the venous blood flows through the kidney, then again collects in lacunæ or vessels which lead to the gills, and finally reaches the heart

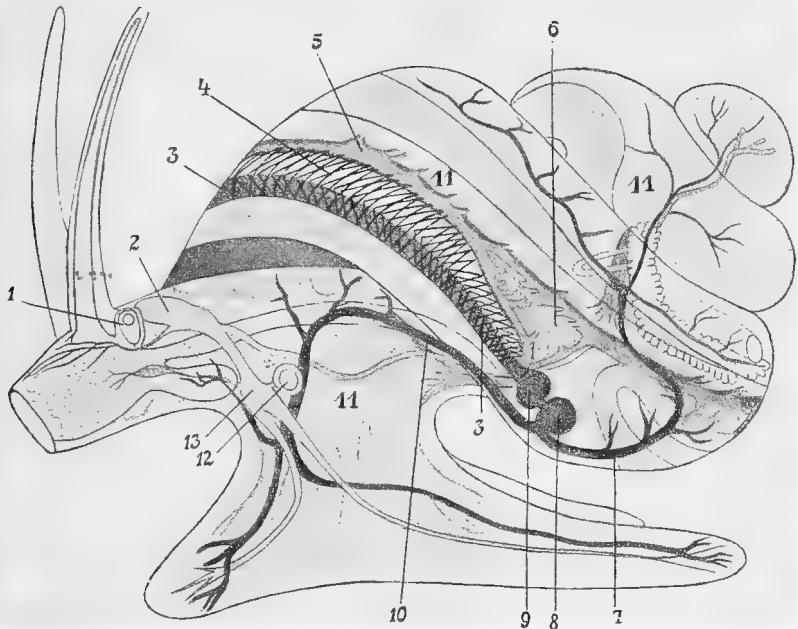

FIG. 169.—Circulatory system of *Paludina vivipara* (after Leydig). The animal is seen from the left side. 1, Eye; 2, cerebral ganglion; 3, efferent branchial vessel (branchial vein); 4, gill (ctenidium); 5, afferent branchial vessel; 6, kidney; 7, aorta visceralis, winding up close to the columella; 8, ventricle; 9, auricle; 10, aorta cephalica; 11, venous sinuses of the body; 12, auditory vesicle; 13, pedal ganglion.

through the branchial veins. Less frequently, the venous blood, after passing through the kidney, enters the auricle more or less directly, *i.e.* without passing through the gills, and there mixes with the arterial blood coming from the gills.

3. A certain part of the venous blood, passing by both the kidney and the gill, flows direct into the branchial veins leading to the auricle.

The arterial blood in the heart is thus mixed with venous blood.

(b) **Pulmonata**.—(Examples: *Helix pomatia*, *Limax*, Figs. 170, 171, 95, p. 100). The blood vascular system is like that of the *Monotocardia*. The only important deviation is caused by the occurrence of pulmonary respiration. Various veins collect the venous blood out of the large body sinus and the lacunar system, and unite to form one large vein, which accompanies the hind-gut, and, as **vena circularis**,

runs along the thickened edge of the mantle which coneresces with the nuchal integument. From this vein spring numerous venous vessels which spread out on the

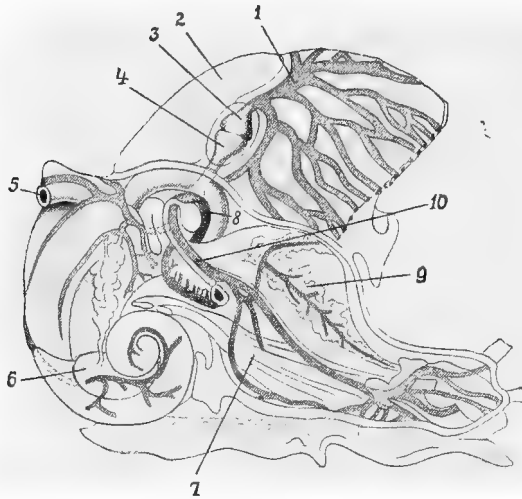

FIG. 170.—Pulmonary veins, heart, and arterial system of *Helix* (after Howes). The mantle (roof of pulmonary cavity) is cut open and turned back. 1, Pulmonary vein (efferent pulmonary vessel); 2, kidney; 3, auricle; 4, ventricle; 5, rectum; 6, hermaphrodite gland; 7, columellar muscle; 8, aorta visceralis; 9, salivary glands; 10, aorta cephalica.

under surface of the mantle, *i.e.* on the roof of the mantle cavity, and there form a delicate respiratory network. In this network the blood becomes arterial, and is

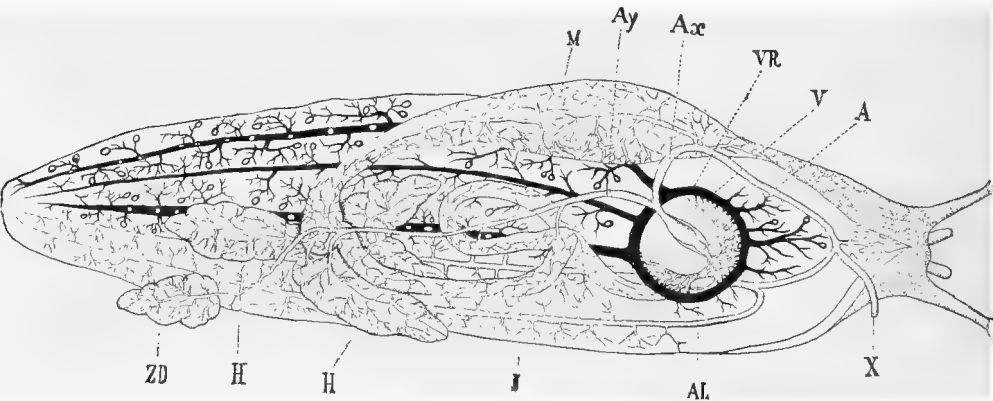

FIG. 171.—Vascular system of *Limax*, after drawings combined by Leuckart from Delle Chiaje and Simroth. The veins carrying the venous blood out of the body into the lungs are black. A, auricle; V, ventricle; VR, venous circular sinus of the pulmonary cavity; Ax, aorta cephalica; Ay, aorta visceralis; M, muscular stomach; ZD, hermaphrodite gland; H, digestive gland; I, intestine; AL, respiratory aperture; X, arteria genitalis.

next conducted through many vessels into the large pulmonary vein (**vena pulmonaris**), which runs back almost parallel to the rectum along the roof of the mantle

cavity, to enter the auricle. The vessels of the respiratory network form projecting ribs on the surface of the mantle. The pallial epithelium in the mantle cavity is ciliated.

The efferent pulmonary vessels, which, near the kidney, run along the right side of the pulmonary vein, first enter the kidney and break into a fine vascular network before passing into that vein.

The cephalic aorta does not pass through the œsophageal ring, but runs between the pedal and visceral ganglia; this is said to be the case in most *Opisthobranchia*.

In *Opisthopyneumonice Pulmonata* (e.g. *Daudebardia*, *Testacella*), in which the small or rudimentary visceral dome has shifted to the posterior end of the body, and the organs elsewhere found in the dome (liver and genital organs) now lie in the body cavity above the foot, and thus in front of the posteriorly placed heart, the posterior aorta (A. visceralis) is much reduced, but the anterior aorta (A. cephalica) is strongly developed. The posterior aorta supplies only the posterior lobes of the liver and the hermaphrodite gland, and the anterior aorta (cephalic aorta, A. ascendens) has thus to supply the anterior lobes and even part of the genital organs, which usually receive their blood from the posterior aorta.

In *Oncidium*, there is an arteria visceralis corresponding with the posterior aorta, which branches off soon after the aorta leaves the heart, but it here runs anteriorly.

(c) **Opisthobranchia.**—Here also the arrangement is essentially the same as in the *Prosobranchia*, though modified by the different position of the gills, as has been already briefly noted.

Gastropteron affords a good illustration of the circulatory system of the *Tectibranchia*. The heart, which is enclosed in a spacious pericardium, lies to the right, in front of and above the base of the gill. It lies transversely, the larger and more muscular ventricle to the left, the auricle to the right. Out of the ventricle springs the aorta, which at once divides into a posterior and an anterior aorta. The anterior aorta enters the cephalic cavity, giving off as its principal arteries: (1) the artery of the copulatory organ. (2) The two large pedal arteries, each of which again soon divides into two branches, viz. (a) an anterior artery, which branches richly in the parapodia; (b) a posterior artery, which runs back on each side parallel to the median line of the foot. (3) The arteries of the cephalic disc. (4) The arteries of the œsophageal bulb and of the œsophagus. (5) The anterior end of the aorta itself branches in the tissues surrounding the mouth. The following are the chief branches of the posterior aorta: (1) The gastric artery. (2) The hepatic arteries. (3) The genital arteries. The venous blood flows back from all parts of the body through richly-branched channels into two large venous sinuses, one of which represents the cephalic and the other the body cavity. Wide but short vessels convey the venous blood out of these sinuses into the kidney, which contains a rich venous lacunar system. From the kidney it flows direct into the afferent branchial vessel, becomes arterial in the gills, and collects in the efferent branchial vessel, which, as the branchial vein, soon enters the auricle.

All the venous blood in *Gastropteron*, therefore, on its way back to the heart, passes first through the kidney and then through the gill, so that only arterial blood flows through the heart.

This is, however, not by any means the case in all *Tectibranchia*. For example, in *Pleurobranchus*, a large part of the venous blood passes from a dorsal circular sinus through a very short but wide passage direct into the branchial vein close to its point of entrance into the auricle, passing by both the kidney and the gill.

Dorididæ.—Without going into details as to the circulatory system of this group, it may be mentioned that part of the venous blood passes directly through two lateral vessels into the auricle. Another part flows into an **inner venous circumanal**

sinus, which lies at the base of the circle of gills. From this the blood rises into the gills, becomes arterial, flows back into an **outer circumanal vessel**, and thence back through the branchial vein into the auricle (Fig. 93, p. 98).

Nudibranchia.—The heart, enclosed in the pericardium, almost always lies in front of the centre of the body, in the median line. The aorta, which springs from the ventricle, divides into an anterior and a posterior aorta, each of which breaks up into an arterial system, the arteries having walls of their own. The finer branches of these arteries open into the lacunar system of the body, which occasionally forms canals resembling vessels, and is connected with the large cephalic and visceral sinuses. Veins, apparently with walls of their own, run from the lacunar system of the dorsal appendages or the integument, and carry the arterial blood back to the auricle. The blood usually finally enters the heart through three “branchial” veins, —two lateral and one median posterior,—which open into the posteriorly-placed auricle.

3. Scaphopoda.

The circulatory system of *Dentalium*, but for the recently-discovered rudimentary heart, is entirely lacunar, consisting of systems of canals, sinuses, and spaces, the special arrangement of which cannot here be described.

The pericardium with the heart lies on the posterior side of the body, dorsally to the anus. If we imagine the intestine of *Dentalium* straight and horizontal, the heart would occupy the typical position on the dorsal side of the hind-gut. It has no auricles, and is merely a sac-like bulging into the pericardial cavity of its anterior wall. It is connected by fine slits with the surrounding sinuses of the body.

4. Lamellibranchia.

The Heart.—In nearly all bivalves, the heart, which is traversed by the hind-gut, possesses two lateral auricles, and lies in a pericardium.

There are, however, isolated exceptions to this rule. In *Nucula*, *Arca*, and *Anomia*, the ventricle lies over (dorsally to) the hind-gut. This dorsal position must be regarded as the primitive position of the Lamellibranchiate heart, since the above genera are among the most primitive bivalves, and, further, since the heart of the *Amphineura*, the *Scaphopoda*, and the *Cephalopoda* also lies over or behind the hind-gut. The perforation of the heart by the hind-gut must have arisen by the bending of the ventricle down round the latter.

The heart in the above-mentioned genera is further distinguished by the fact that the ventricle is more or less elongated in the transverse direction, its lateral ends being swollen, while the central part, which lies above the intestine, becomes narrower and thinner. This modification goes furthest in *Arca Nox*, where there seem to be two lateral ventricles unconnected by a central portion. This separation of the ventricle into two lateral parts has here brought about a separation of the two aorta. The two anterior as well as the two posterior branches, however, after a comparatively short separate course, unite to form an unpaired anterior and an unpaired posterior aorta.

Although these genera have, as a rule, a heart lying above the hind-gut, in some specialised forms the heart is placed under the hind-gut, e.g. *Meleagrina*, *Ostrea*, *Teredo*. The cause of this modification must lie in the increasing distance between the base of the gills and the original region of the heart, the auricles and the ventricle having shifted with the latter. The auricles, however, no longer lie laterally to the

ventricle, but are drawn down to its lower side, where they grow together, communicating through a more or less large aperture. *Pinna*, *Avicula*, and *Perna* exhibit the consecutive stages in the displacement of the heart to the lower side of the hind-gut. The shifting of the gills from the original region of the heart just mentioned is caused by the shifting forward of the posterior adductor, which grows more and more massive and finally reaches a median position on the shell valve. It has already been mentioned that this posterior adductor, by the continuous reduction and final disappearance of the anterior adductor, becomes the one adductor of the *Momyaria*.

In *Teredo* also, the heart lies on the under side of the hind-gut. This is connected with the approximation of the hind-gut with the anus to the mouth dorsally,

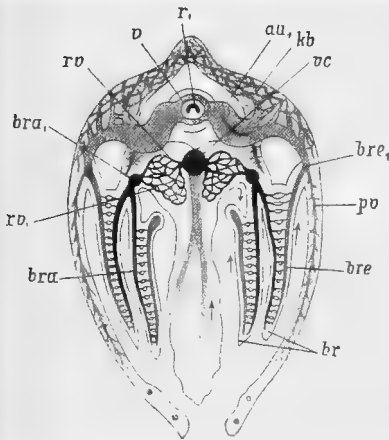

FIG. 172.

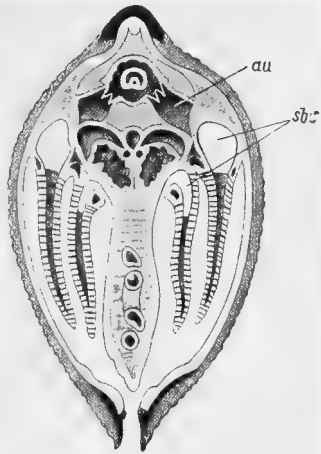

FIG. 173.

FIG. 172.—Transverse section through *Anodonta*, to illustrate the course of the circulation of the gills and the kidneys, and the branchial veins (after Howes). *br*, Gills; *bre*, efferent branchial vessel (branchial vein) which opens into the large branchial vein *bre₁*, running along the base of the gills, and here cut through transversely; *pv*, pallial vein; *vc*, large venous sinus of the body; *kb*, pericardial gland; *au₁*, auricle; *r₁*, rectum; *v*, ventricle; *rv* and *rv₁*, renal vessels; *bra₁*, afferent branchial vessel (branchial artery), running along the base of the gills; *bra*, lateral branches of the same running in the gills. The veins or sinuses conveying venous blood are black.

FIG. 173.—Another section through *Anodonta* (after Howes). Lettering as in Fig. 172. *au*, auricle; *sb*, spaces at the base of the gills, bathed by the water and communicating with the mantle cavity, between the ascending and descending branchial lamellae.

while the gills, remaining in their original position, retain the heart on the lower side of the hind-gut.

Circulation (Fig. 25, p. 17).—The arteries have walls of their own, and branch into fine vessels, which discharge the blood into the lacunar system of the body. The venous system seems to have no distinct vessels with walls of their own, although it forms more or less wide channels resembling true vessels.

An **anterior** and a **posterior aorta** spring, as a rule, from the ventricle. The anterior aorta runs forward above the intestine and breaks up into various arteries. The **arteria visceralis** supplies the intestine, the digestive gland, and the genital gland; the **pedal artery** supplies the foot; the **anterior pallial artery** spreads out over the anterior part of the mantle and the oral lobes (labial palps).

The posterior aorta leaves the ventricle posteriorly and runs along the lower side of the hind-gut. It soon divides into two large lateral arteries,—the **posterior pallial arteries**. The principal branches of the anterior and posterior pallial arteries run along the free edge of the mantle on each side and then unite, forming together the arteries of the pallial edge. From the roots of the posterior pallial artery smaller arteries spring, which supply with blood the hind-gut, the pericardium, the posterior adductor, the retractors of the siphons, etc. The venous blood is collected out of the lacunar system of the body through converging channels into one longitudinal venous sinus; this lies under the pericardium (Fig. 172).

From this sinus, the greater part of the blood flows through the complicated system of venous canals in the kidneys, after which it is collected on each side into a branchial artery which runs along the base of the gills, and thence enters the two branchial lamellæ. It becomes arterial through respiration in the gills, flows as arterial blood into a branchial vein parallel with the branchial artery, and thence into the auricle.

Part of the venous blood, however, passes by direct channels out of the venous sinus into the branchial artery (passing by the kidneys), and part even flows direct into the pericardium. In this way some venous blood comes to be mixed with the arterial blood flowing through the heart from the gills.

Not all Lamellibranchia have an anterior and a posterior aorta springing out of the heart. In the lower groups of the *Protobranchia* and *Filibranchia* there are numerous forms (*Nacula*, *Solenomya*, *Anomia*, *Mytilidæ*) in which only one anterior aorta leaves the ventricle; this soon, however, gives off the arteria visceralis, which supplies blood to those parts which, in other *Lamellibranchia*, are fed by the aorta posterior. In their possession of a single aorta rising from the ventricle, the above lower Lamellibranchiates agree with *Chiton* and the *Gastropoda*. The rise of this aorta from the posterior end of the ventricle in the *Prosobranchia* and in most *Pulmonata* is a secondarily acquired arrangement, caused by the shifting forward of the pallial complex.

It must further be noted that in a very specialised bivalve, *Teredo*, the posterior aorta fuses with the anterior, and thus the two leave the heart as one vessel.

In those Lamellibranchiates which have siphons, a muscular and contractile widening occurs in the posterior aorta near the point where it leaves the ventricle; this is called the **bulbus arteriosus**. Its special function is perhaps that of bringing about pressure of blood, to assist in the extension of the siphons. The backward flow of the blood into the ventricle in the contraction of the bulbus arteriosus (systole) is prevented by a linguiform valve which projects from its anterior wall.

5. Cephalopoda.

Heart (Figs. 127, 168, pl. 147, 199, and 174).—We must here again point out the important fact that *Nautilus* has a heart with four auricles, while the *Decapoda* and *Octopoda* a heart with only two auricles. This difference is connected with the difference in the number of the tentacles: four in *Nautilus* (*Tetrabranchia*), two in the *Decapoda* and *Octopoda* (*Dibranchia*).

In *Nautilus*, the heart is an almost square sac drawn out to two points on each side; the four auricles which open into the four points of the ventricle are long tubes, more like widened branchial veins than auricles.

The strongly muscular ventricle of the *Dibranchia* is almost always elongated into a tube. In the *Octopoda* it lies transversely, the two auricles being in the same plane with the ventricle. In the *Oegopsidæ*, the ventricle lies along the longitudinal axis of the body, *i.e.* it is elongated dorso-ventrally, and the auricles are at right

angles to it. The heart of the *Myopsida* occupies a position halfway between those just mentioned.

The heart here described is the **arterial heart**, which corresponds with the heart of the other Mollusca. It is called arterial to distinguish it from the **venous hearts**, which will be described below.

Circulation.—It is important to note that the circulatory system is at least partially closed. There is not only a richly-branched arterial, but a richly-branched venous system, the vessels of which have walls of their own. These two systems pass into one another in certain parts of the body, e.g. the integument and certain muscle layers, through a system of capillary vessels. In other parts, however, the arterial branches conduct the blood into a lacunar system; when it has become

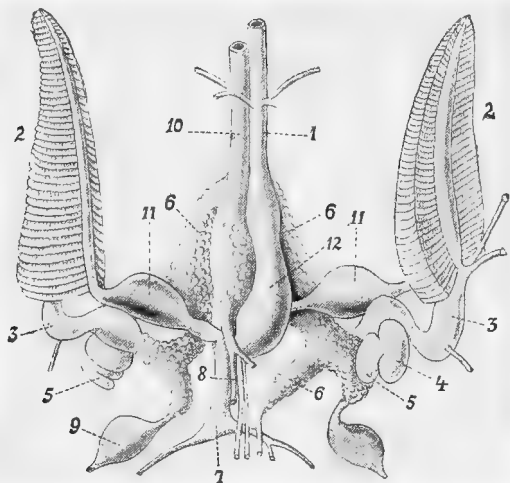

FIG. 174.—Circulatory system, venous appendages of the nephridial system, and gills of *Sepia officinalis*, anterior view (after Hunter). 1, Aorta cephalica; 2, ctenidium; 3, vein leading to the ctenidium; 4, branchial heart (pericardial gland); 5, appendage of the branchial heart; 6, venous appendages of the nephridial system; 7, aorta abdominalis; 8, vena abdominalis; 9, lateral veins; 10, vena cephalica; 11, auricles; 12, ventricle (cf. Fig. 186).

venous, the blood collects out of this into sinuses (especially into a peripharyngeal cephalic sinus), and flows to the gills through veins with walls of their own.

Two aorta rise from the ventricle: (1) the **aorta cephalica**, which runs downward (upwards in the figure) to the head, and (2) the **aorta abdominalis**, which runs up towards the apex of the visceral dome. The former is much stronger than the latter. The aorta cephalica first gives off branches to the mantle and to the anterior wall of the body, and then provides the stomach, the pancreas, the digestive gland, the œsophagus, the salivary glands, and the funnel with arteries. After accompanying the œsophagus, it divides in the head into two branches, which run to the bases of the arms, and there break up into as many arteriæ brachiales as there are arms.

The aorta abdominalis supplies with arteries the hind-gut, the ink-bag, the genital organs, the dorsal part of the body wall, and the fins, when these latter are present.

Only in the *Oegopsida* are the aorta limited to the two, above described, springing from the heart. In the *Octopoda* and the *Myopsida*, there are other arteries rising out of the ventricle, and running to the same part of the body as the aorta abdominalis

in the *Oegopsidæ*; among these are the **arteria genitalis**, which runs to the genital glands, and, in the *Myopsidæ*, a fine vessel called the **arteria anterior**.

At certain places, the arteries may swell out to form small muscular and contractile widenings, called peripheral arterial hearts.

In the venous system of *Sepia*, the venous blood in each arm collects (partly through capillaries and partly through lacunæ) into a vein running down the inner side of the arm. All the brachial veins convey their blood to a circular cephalic sinus surrounding the buccal mass, which is the reservoir for collecting the venous blood from the whole head region. Out of this sinus springs the large **vena cephalica**, which runs up along the posterior side of the œsophagus and the liver into the visceral dome, collecting on the way venous blood from the liver, the funnel, etc. A little below the stomach it forks, forming the two **venæ cavæ**, which open into the two contractile venous hearts at the bases of the gills. From the upper part of the visceral dome the blood collects into several abdominal veins, the most important of which are an unpaired vena abdominalis, opening into the vena cephalica exactly at the point where it divides into the venæ cavæ, and two lateral abdominal veins, which open into the latter near their point of entrance into the branchial hearts.

In the region of the heart, all these veins carry acinose or lobate appendages (**venous appendages**), which are hollow, and communicate at many points with the veins, so that they are richly supplied with blood. The cavity into which these appendages project is that of the **renal sacs**, and the epithelium which covers them belongs to the epithelial wall of the kidneys (*cf.* Fig. 186, p. 224). We thus see that here the blood flowing back from the body has abundant opportunity of giving off its excretory constituents to the kidneys.

Appendages are found on both the branchial hearts; these are the **pericardial glands**, which will be further described later. The two branchial hearts, by their contraction, drive the venous blood into the afferent branchial vessel. The blood, which has become arterial in the gills, flows through the efferent branchial vessel (the so-called **branchial veins**) into the auricles of the heart, and thence into the ventricle (on the branchial circulation, *cf.* p. 96).

In the Cephalopoda, unlike the other Mollusca, the whole of the blood, in returning from the body, flows through the gills, so that the heart contains only arterial blood. By far the greater part of the blood, before entering the gills, comes into contact with the kidneys in the venous appendages.

In the *Octopoda*, the venous system shows some not unimportant modifications. In *Octopus*, two veins, connected with one another by anastomoses, run along the outer side of each arm and collect the venous blood. At the bases of the arms these veins become connected in pairs, and unite later in such a way as to form on each side a lateral cephalic vein.

These two veins unite to form the large **vena cephalica**, which runs up in front of the funnel and behind the œsophagus. The brachial veins do not here, as in *Sepia*, convey their blood first to the venous cephalic circular sinus, but are directly connected with the cephalic vein. A cephalic sinus nevertheless exists in *Octopus*; it is not, however, connected with the vena cephalica, but with a large sinus which fills the whole visceral dome, and is, in fact, the primary body cavity, in which the viscera lie bathed by the venous blood. The latter flows out of this large venous sinus through two wide veins, the so-called **peritoneal tubes**, into the upper part of the vena cephalica, near the point where this divides into the two venæ cavæ.

Nautilus is chiefly distinguished by the **absence of the branchial hearts**. Further, each of the two venæ cavæ divides into two branches, which run, as afferent vessels, to the gills.

XVIII. The Body Cavity.

Primary and Secondary Body Cavity, Pericardium, Pericardial Gland.

The Mollusca are said to have a primary and a secondary body cavity. The former is the **system of lacunæ and sinuses**, into which the arteries open, and out of which the veins, where these are present, draw their blood. It has **no epithelial walls of its own**, its boundaries are formed by connective, nerve, or muscle tissue, or by epithelia, which, however, belong to other organs, such as the intestine, the kidneys, or the body wall.

The so-called **secondary body cavity** or **cœlom** is, in most Mollusca, very much reduced, usually consisting of only two small cavities, the **pericardium** and the **cavity of the gonads** (testes, ovaries, or hermaphrodite glands). The cœlom is always lined by an epithelium of its own, the cœlomic epithelium, and corresponds with the true cœlom of the Annelida, which also possesses such an epithelium. Like the latter, it is connected, by means of the nephridial funnel, with the nephridia, which lead to the exterior, and in Molluscs are usually found only in one pair. A probe can therefore be introduced through the kidney into the cœlom, *i.e.* into that part of it which, containing the heart, is called the pericardium. The germinal layers must be considered as proliferations of the cœlomic endothelium. The epithelium of the pericardium is, in very many Molluscs, differentiated into glands, called the pericardial glands; these probably may be classed together with the kidney as excretory.

We should be justified in assuming, *a priori*, that the lumen of the genital glands of the Mollusca is part of a true cœlom, and that the germinal layers themselves, *i.e.* that complex of cells which yields the eggs and spermatozoa, are outgrowths of the endothelial wall of this cœlom. Direct support is, however, given to this assumption by the fact that in the *Solenogastres*, *Sepia*, and *Nautilus*, the sac of the genital glands is in open communication with the rest of the cœlom, forming, in fact, an only partly distinct division of the same.

In the *Solenogastres* (*e.g.* *Proneomenia*), the hermaphrodite gland lies above the mid-gut as a long tube, which in transverse section appears heart- or kidney-shaped, as its lower part bulges out on each side. Its shape is determined by the fact that the mid-gut forms dorsally a narrow but deep furrow, which cuts into this glandular tube from below. The tubular gland is divided into two lateral spaces by a partition, whose endothelial wall is the place of formation of the eggs; these lateral chambers may again be traversed by septa, on which the genital products develop. This division is especially distinct at the posterior part of the tube, the two chambers being there completely isolated, and entering the pericardium separately as genital ducts.

If the secondary body cavity of *Proneomenia* is compared with that of an Annelid, we find the following differences :

In *Pronoemia*, the dorsal vessel is wanting in the region of the mid-gut. The coelom is much less spacious, and instead of surrounding the intestine lies only on its dorsal side. It is developed merely as a hermaphrodite glandular sac, its endothelial wall yielding the genital products.

In the region of the hind-gut, the vessel lying in the dorsal mesentery is developed as a heart, the coelom being here represented by the pericardium.

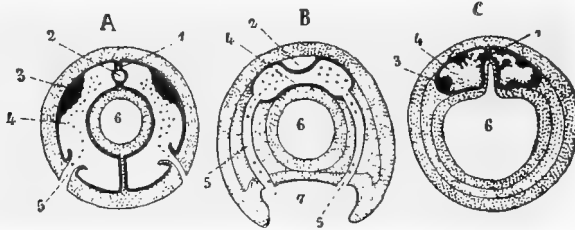

FIG. 175.—Diagrammatic sections through an Annelid (A) and a Solenogastrid (B and C), to illustrate the relation of the coelom to the genital glands and nephridia. B, Region of the cloaca; C, region of the mid-gut; 1, dorsal mesentery; 2, dorsal vessel or heart; 3, germinal epithelium; 4, coelom—in B=pericardium, in C=hermaphrodite gland (in the coelom are genital products); 5, nephridia; 6, intestine; 7, cloaca.

The pericardium is connected with the cloaca by two canals; these may be considered as the morphological equivalents of nephridia (cf. Fig. 175).

As the genital glands have been recognised as part of the coelom in the *Solenogastres*, *Nautilus*, and *Sepia*, they must necessarily fall under the same category in all other Molluscs, even when no longer in direct connection or in open communication with the same.

In the *Chitonida*, the coelom is large, and falls into three distinct divisions. One contains the intestine and digestive gland (liver), which are accordingly outwardly

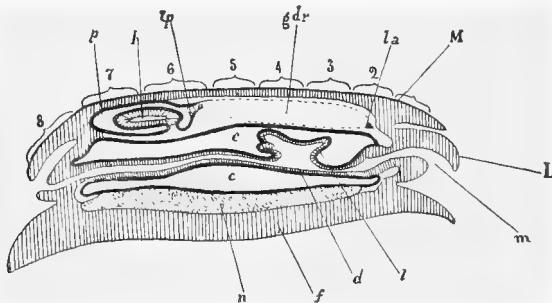

FIG. 176.—Diagrammatic longitudinal section through *Chiton*, to illustrate the relation between the various parts of the coelom (after Haller). 1-8, Position of the eight dorsal shell-plates; M, anterior portion of the dorsal integument; L, snout; m, mouth; l, digestive gland (liver); d, intestine; f, foot; n, kidney; p, pericardium; c, portion of the coelom surrounding the intestine; h, heart; lp, band connecting pericardium and genital gland; gdr, genital gland; la, band connecting the genital gland and the posterior portion of the coelom which surrounds the intestine.

(i.e. on the side turned to the coelom) covered with an endothelium. The mesenteries, however, which originally attached the intestine to the body wall, and along which the parietal endothelium passed into the visceral endothelium of the intestine and liver, have disappeared, with the exception of portions retained on the hind-gut. The two other divisions of the coelom are: (1) the pericardium, and

(2) the genital gland. Certain bands, by means of which the three divisions are connected together, have been regarded as the constricted remains of communications between the three divisions of the originally single cœlom (Fig. 176).

The *Cephalopoda* may with advantage be considered in connection with the *Amphincura*. In *Nautilus* and the *Decapoda* (e.g. *Sepia*, Fig. 177) a spacious secondary body cavity is found in the dorsal part of the visceral dome. It is incompletely divided by a projecting dorsal septum into two cavities, one lying above the other; the lower of these contains, as pericardium, the heart with the arteries and veins running out of and into it, the branchial hearts, and the pericardial glands; while the upper holds the stomach and the genital glands. This double cavity,

FIG. 177.—Diagram showing the secondary body cavity of *Sepia* (after Grobben). Median longitudinal section through the body, in which, however, some organs are represented which, being paired and symmetrical, do not properly come into the plane of the section. The outlines of the cœlom are indicated by thicker lines. 1, Female germinal body, with eggs (2) projecting into the genital cavity (the ovalar division of the cœlom); 3, shell; 4b, anterior portion of the renal sac; 5, pancreatic appendage of the efferent duct (bile duct) of the digestive gland (liver); 4a, anterior venous appendage of the renal system; 6, aperture (funnel) of the kidney into the cœlom; 7, outer or pallial aperture of the kidney; 8, digestive gland (liver); 9, "head" (Kopffuss); 10, funnel; 11, end of the oviduct with female genital aperture; 12, mantle cavity; 13, mantle; 14, posterior portion of the renal sac; 15, intestine; 14₁, posterior venous appendage of the renal system (pericardial gland); 18, fold, incompletely dividing the cœlom into an upper and a lower portion; 19, stomach; 20, upper division of the cœlom (principally genital cavity); 21, pigment gland (ink-bag); 22, aperture of the oviduct into the genital cavity; d, dorsal; v, ventral; a, anterior; p, posterior.

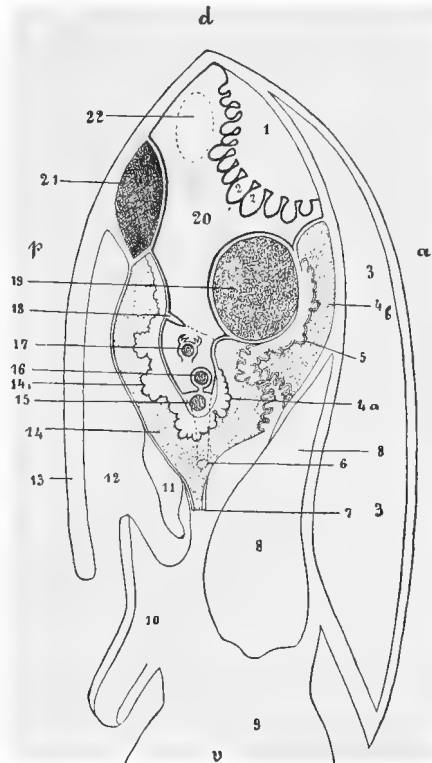

which is called the visceropericardial cavity, is covered by endothelium, which also covers the organs within it. It is connected by two ciliated funnels with the two renal sacs. In *Nautilus* it also opens direct into the mantle cavity by two canals, whose apertures lie close to the renal apertures.

While the cœlom in *Nautilus* and the *Decapoda* is very spacious, in the *Octopoda*, on the contrary, it is very much reduced. It consists merely of a narrow system of canals, which, however, have thick walls; this was formerly called the water vascular system. The organs, which in *Nautilus* and the *Decapoda* lie in the cœlom, viz. the arterial heart with its afferent and efferent vessels, the branchial hearts and the stomach, are no longer found within the body cavity, but outside of it, and are

therefore no longer covered with endothelium. Nevertheless this canal system of the *Octopoda* shows the same morphologically important characteristics as the cœlom of the *Decapoda*. There are, for instance, on each side three canals which open together, one entering the renal sac, the second widening round the pericardial gland (appendage of the branchial heart) to form a flask-shaped capsule, and the third running to the genital gland to be continued into its wall. In so far as in the *Octopoda* the heart is excluded from the cœlom, which has been reduced to the "water canal system," the reduction of this cavity has gone further in these Mollusca than in any others, which all retain at least the heart in one portion of the cœlom, the pericardium.

In the *Lamellibranchia* and *Gastropoda*, the only part of the cœlom retained, besides the genital glands, is the pericardium. The pericardium and the gonad are,

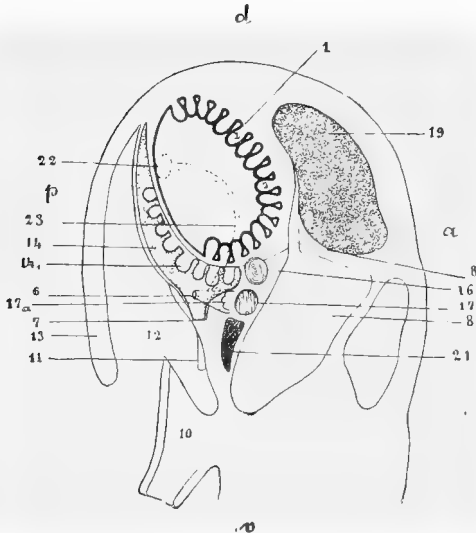

FIG. 178. *Eleidone moschata*. This figure corresponds with Fig. 177 of *Sepia* (after Grobben). 8₁, Efferent duct of the digestive gland; 17a, pericardial gland (appendage of the branchial heart); 23, water canals.

secretions or excretions must be discharged into the pericardium, and thence outwards through the kidney.

Among the *Prosobranchia*, in the *Diotocardia*, the pericardial gland is found on the auricle, its walls forming dendriform branched outgrowths into the pericardial cavity, these being covered with pericardial endothelium. Where pericardial glands are found in the *Monotocardia*, they lie on the wall of the pericardium itself. Similar lobate formations occur among the *Opisthobranchia*, in *Aplysia*, and *Notarchus*, on the anterior aorta which runs along the pericardial wall; in *Pleurobranchus* and *Pleurobranchæa* on the lower, in *Doridopsis* and *Phyllidæa* on the dorsal pericardial wall. The lateral furrows of the pericardium of *Doris* form niches, which may again have accessory niches. These enlargements of the surface of the pericardial epithelium have also been considered as pericardial glands.

Pericardial glands are much more common among the *Lamellibranchia* than among the *Gastropoda*, but are wanting in the most primitive forms (*Nucula*, *Solenomya*, *Anomia*). The gland is usually of a rusty red colour, and occurs in two

however, entirely separated from one another. In *Lamellibranchs*, there is in the pericardium, besides the heart, a part of the hind-gut which traverses it; in the *Gastropoda* (except in those *Diotocardia* in which the hind-gut penetrates the heart), only this latter organ. Rarely (e.g. *Phyllirhoë*) the auricle also is excluded from the pericardium.

The pericardial gland is found in most Mollusca. It is a glandular differentiation of the endothelial wall of the pericardium, and perhaps, as already suggested, shares the excretory functions of the kidney. Its position in the pericardium varies, but it seems in all cases shut off from the blood vascular system, with which it is, however, functionally connected. Its

forms, consisting either of glandular protrusions of the endothelial wall of the auricles into the pericardial cavity, or of glandular tubes protruding from the anterior corner of the pericardium into the mantle (**Keber's organ, red-brown organ**). The first form is found specially strongly developed in *Mytilus*, *Lithodomus*, and *Saxicava*, more or less developed in *Dreissena*, *Unio*, *Anodonta*, *Venus*, *Cardium*, *Scrobicularia*, *Solen*, *Pholas*, and *Teredo*, and more or less rudimentary in *Pecten*, *Spondylus*, *Lima*, *Ostrea*. The second form has been observed in *Unio*, *Anodonta*, *Venus*, *Cardium*, *Scrobicularia*, *Solen*, *Pholas*, *Montacuta*, and *Dreissensia*. Pericardial glands may also occur singly in other parts of the pericardium, as in *Meleagrina* (as a projecting ruff in the posterior base of the pericardium), and in *Chama* on the ventricle, etc.

The pericardial gland of the *Cephalopoda* is the so-called appendage of the branchial hearts. This is a structure connected with the branchial heart, and covered with peritoneal endothelium, which projects into the visceropericardial cavity, or, in the *Octopoda*, into a flask-like widening of the water-canal system (which has been recognised as a division of the cœlom). In *Sepia* this appendage is conical. A deep furrow on the surface which projects into the visceropericardial cavity leads into a richly-branched system of canals, the glandular epithelium of which is a continuation of the peritoneal epithelium. Blood sinuses from the branchial heart penetrate in between the canals of this system. In other *Cephalopoda*, the pericardial gland varies in form and structure; details of these variations cannot, however, be here given. *Nautilus* possesses two pairs of pericardial glands; this fact is connected with its possession of two pairs of gills, with their two pairs of afferent vessels, and on these the two pairs of pericardial glands occupy positions corresponding with those of the branchial hearts.

XIX. The Nephridia.

Kidney, Organ of Bojanus.

The organs which serve for excretion are homologous in all Mollusca.

They consist typically of two symmetrical sacs, which, on the one hand, open into the mantle cavity, through the two outer renal apertures, and on the other are connected by two inner apertures (renal funnels, ciliated funnels) with the pericardium or cœlom. The nephridia always lie near the pericardium. Their walls are richly vascularised, indeed a large part of the venous blood, in returning from the body, flows through the renal walls and gives off excretory matter before it enters the respiratory organs. The renal walls are traversed exclusively by venous blood.

The nephridia are paired in all symmetrical Molluscs, and also in those *Gastropoda* which have paired gills and two auricles (*Diotocardia*).

In all other *Gastropoda*, along with the original right ctænidium (which, in the *Prosobranchia*, lies to the left), and the corresponding auricle, only one kidney (the corresponding one) is retained.

Nautilus, which has four gills and four auricles, has also four kidneys; only two of these, however, communicate with the visceropericardial cavity.

A relation between the nephridial and genital systems similar to that found in the Annelida exists in the *Solenogastridae*, the nephridia functioning as ducts for the genital products, the latter passing from the hermaphrodite gland (genital chamber of the coelom) into the pericardium.

In a few *Lamellibranchia*, *Diotocardia*, and in the *Scaphopoda*, there is a relation between the genital glands and the nephridia, the former opening into the latter; so that a certain part of the nephridium functions not only as renal or urinary duct, but also as efferent genital duct. In all *Diotocardia*, it is the right nephridium which functions as genital duct. In the *Monotocardia*, in which the right nephridium of the *Diotocardia* has atrophied as such, its duct persists as genital duct. In all other Molluscs the genital ducts are entirely distinct from the urinary passages.

A. Amphineura.

The kidneys of the *Solenogastridae* and the *Chitonidae* differ greatly from one another in structure.

1. In the *Solenogastridae*, two canals spring from the pericardium, embrace the hind-gut, and open into the cloaca beneath it through a common terminal portion

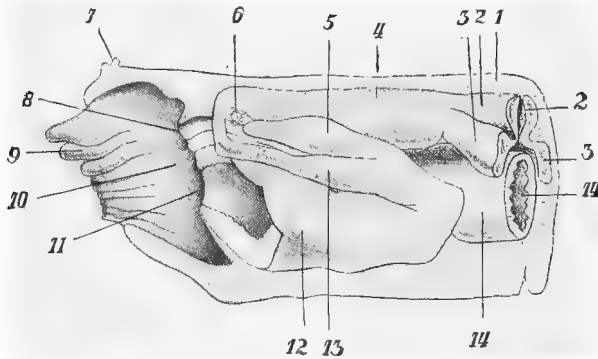

FIG. 179.—*Paramenia impeza*. Posterior end of the body; the integument must be supposed to be removed on the right side, and also a piece of the wall of the right nephridium; diagram (after Pruvot). 1, Integument; 2, ovarian portion of the hermaphrodite gland; 3, testicular portion of the same, near the point where the latter opens into the pericardium (4); 5, glandular appendage of the right nephridium; 6, dorsal commissure of the pleurovisceral cords; 7, organ called the sensory bud; 8, aperture of the hind-gut into the cloaca; 9, gill; 10, cloaca; 11, common aperture of the nephridia into the cloaca; 12, lower portion of the nephridium; 13, upper portion of the right nephridium, which opens above into the pericardium; 14, hind-gut.

(Fig. 179). These canals function as ducts for the genital products. It is also certain that they correspond morphologically with the kidneys of other Molluscs, even though their excretory activity has not been proved. They are covered with an extraordinarily deep epithelium of long filiform glandular cells.

In some *Solenogastridae*, an accessory gland opens into each nephridial canal.

2. In the *Chitonidae*, the strongly-developed paired nephridia function exclusively as excretory organs.

Each nephridium (Fig. 180) consists of a wide canal shaped like a long Y,

the diverging portions being directed backward, and the undivided portion forward. These Y-shaped kidneys run longitudinally along each side of the body through its whole length. One of the paired limbs of the Y opens outward into the posterior part of the mantle cavity, the other into the pericardium, which also lies in the posterior part of the body. In this way the pericardial and outer aper-

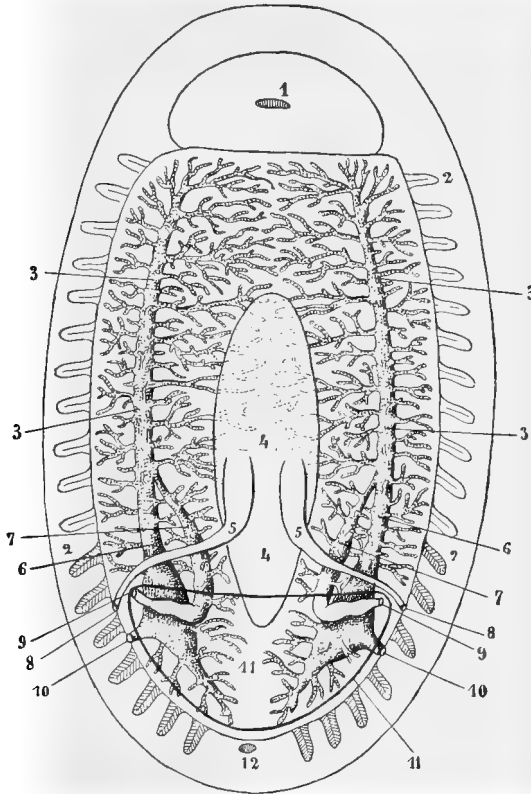

FIG. 180.—Nephridial and genital systems of *Chiton*, diagrammatic, from above, after the figures and accounts of various authors. 1, Mouth; 2, gills; 3, unpaired-portion of the nephridium which runs forward, with its lateral branches; 4, gonad; 5, efferent ducts of the gonad; 6, portion of the nephridium running to the outer aperture (10); 7, portion running to the reno-pericardial aperture (9); 8, genital apertures; 9, reno-pericardial funnel; 10, nephridial aperture; 11, pericardium, indicated only in outline; 12, anus.

tures of the kidney lie near one another. The third limb of the Y ends blindly anteriorly. Secondary lobules or lobed canals open into all the three parts of the kidney, and are specially abundant in its anterior portion. Except in the terminal portion of the efferent branch, the epithelium of the limbs as well as that of the lobes is cubical and ciliated.

B. Gastropoda.

1. **Prosobranchia.** (a) **Diotocardia.**—Among all the Gastropoda, *Fissurella* alone possesses a symmetrical excretory apparatus, in the sense of having two

nephridia opening into the mantle cavity to the right and left of the anus. The left nephridium is, however, much reduced, while the right, which is strongly developed, sends its lobes everywhere into the spaces between the lobes of the liver, the intestine, and the genital organs. There are no reno-pericardial openings. The genital gland does not open direct into the mantle cavity, but through the right kidney.

In *Haliotis*, *Turbo*, and *Trochus*, both nephridia are present. The left nephridium has, however, almost entirely lost its excretory function, but is still connected both with the pericardium and the mantle cavity. It is called the papillar sac, its walls projecting into its cavity in the form of numerous large papillæ. The blood lacunæ which penetrate into the papillæ communicate direct with the auricles, and are thus supplied with arterial blood. In these lacunæ of the papillæ a crystalloid substance (albumen?) is deposited. It has been thought that these papillar sacs serve as reservoirs of nutritive material (in the form of the crystalloids just mentioned), and when needed yield it up to the blood.

The right nephridium is exclusively excretory in function. It is divided into two lobes, one behind the other, which communicate by means of a wide aperture; the anterior lobe lies under the floor of the mantle cavity, bulging it upward. A spongy network, covered with excretory epithelium, rises from part of its wall into the cavity of the nephridial sac. The meshes of the network are penetrated by a system of vessels with walls of their own. Nearly all the venous blood, before reaching the gills, passes through the vascular system thus developed on the walls of the kidneys. The right nephridium is in no way connected with the pericardium.

The *Neritidæ* have only one nephridium to the right of the heart, which opens through a slit in the base of the mantle cavity. The renal sac is traversed by trabeculæ, many of which reach from one wall to the other, forming a spongy structure. The trabeculæ are covered by a glandular epithelium on the surfaces turned to the spaces of the sac.

Patella (Fig. 181) still has two nephridia, both functioning as excretory organs. The apertures lie at the two sides of the anus. The right kidney is, however, much larger than the left. They both lie to the right of the pericardium, but there are no reno-pericardial apertures. The internal structure of the right kidney is spongy, but the left forms a simple cavity, into which folds project from the walls. A lacunar system without special walls traverses the trabecular network of the right kidney, but is completely cut off from its cavity; the venous blood from the body passes through this

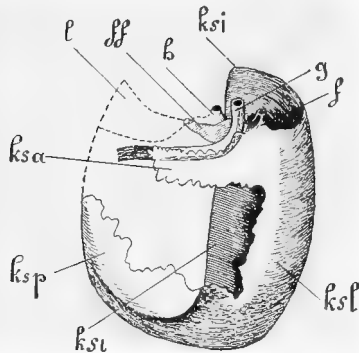

FIG. 181.—Diagram of the two nephridia of *Patella* (after Lankester). *ksa*, Anterior and upper lobe of the large right kidney *ksl*; *ksi*, lower subvisceral; *ksp*, posterior lobe of the same; *ff*, subanal tract of the large right kidney; *g*, anal papilla with the portion of the rectum which runs to it; *h*, papilla with the aperture of the left kidney (which is not drawn); *f*, the same of the right kidney; *l*, pericardium, indicated by a dotted outline; the existence of the reno-pericardial aperture figured near *ff*, is now denied.

system before entering the gills. The lacunar system of the left kidney communicates directly with the auricle.

In *Haliotis* and *Patella* also the genital products pass, as in *Fissurella* and the *Diotocardia* generally, out of the genital gland into the right kidney, and are ejected through the right renal aperture.

(b) **Monotocardia.**—The Monotocardia have only one nephridium functioning as an excretory organ, viz. the left of the *Diotocardia*. This takes the form of a sac lying immediately below the mantle cavity on the right side of the pericardium, directly under the integument. It is generally found to the left of the hind-gut; less frequently (*Cassidaria*, *Tritoniidae*) the kidney is traversed by the rectum, or the latter runs forward below it. The slit-like pallial aperture of the kidney, however, is always found to the left of the hind-gut, quite at the base of the mantle cavity. This position of the kidney, and especially of its outer apertures, had already led to the assumption that the Monotocardian nephridium corresponds with the left kidney of the *Diotocardia*, before this fact was established. The assumption was all the more plausible because of the occurrence of a gland called the anal kidney in a few *Monotocardia* (e.g. *Dolium*); this gland opens to the right near the anus, and might represent the right kidney of the *Diotocardia*.

The kidney is always connected by means of a canal (the reno-pericardial canal) with the pericardium.

Lamellæ or trabeculæ, covered with the glandular epithelium of the kidney, project inward from the lateral walls of the renal sac. These are especially strongly developed in fresh-water Prosobranchia (excepting *Valvata*), traverse the whole kidney, and impart to it a spongy structure. The venous blood always flows through the whole of the glandular part of the kidney, either in special vessels or in lacunæ, before passing on to the gills; but an open communication with the renal cavity is never found.

In the *Tænioglossa Proboscidiifera* the kidney forms two lobes similar in structure. In *Natica* and *Cypræa* the lobes begin to differ, and among the *Stenoglossa* this difference becomes more and more marked in a way which need not here be described.

In *Paludina* and *Valvata* the kidney no longer opens into the posterior base of the mantle cavity, but is continued as a urinary duct (ureter), which runs forward in the mantle and opens at its edge.

The above-mentioned theory that the single kidney of the Monotocardia corresponds with the left kidney of the *Diotocardia* has recently been ably opposed, another theory being put forward in its place. Attention is specially drawn to the fact that in the *Diotocardia* the left kidney is always the smaller, that in *Patella* it is shifted to the right side of the pericardium, and that in *Haliotis*, *Turbo*, and *Trochus* (as papillar sac) it is not excretory in function. In *Haliotis*, *Turbo*, *Trochus*, and *Patella* the lacunar system developed in the wall of the left kidney is in direct communication with the auricles.

In most Monotocardia there is a differentiated part of the kidney, viz. that which is called the **nephridial gland**. This consists of two principal parts: (1) canals, covered with ciliated epithelial cells and opening into the kidney. These are merely protrusions of the renal wall, which project into the organ; their epithelium is a continuation of the renal epithelium. (2) Between these canals, the organ is filled with cells of connective tissue and muscles, and contains blood lacunæ, one of these being specially large and communicating with the auricle. This latter portion of the organ perhaps plays the part of a blood-forming gland.

This nephridial gland may perhaps be the persistent excretory portion of the lost nephridium, i.e. the right of the *Diotocardia*. The duct of this lost nephridium is now known to persist as genital duct. As we saw above, all *Diotocardia* discharge the genital products through the right nephridium.

2. **Pulmonata** (Fig. 182).—The Pulmonata have only one kidney, which lies in the mantle at the base of the pallial cavity, between the rectum and the pericardium. The renal sac is of the so-called parenchymatous type, the excretory epithelium of its wall projecting into the cavity in the form of numerous

folds and lamellæ in such a way as to leave hardly any central free space. The kidney always communicates by means of a ciliated canal (renal funnel or renal syringe, "Nieren-Spritze") with the pericardium. The position of the kidney and the morphology of the urinary duct have already been explained (pp. 74-78).

3. **Opisthobranchia—Tectibranchia.**—Only one kidney is found in the usual position on the right side of the body, with the pericardium in front of it and the hind-gut behind it. It is of the parenchymatous type, and is connected by a ciliated canal with the pericardium. It opens at the base of the gill in front of the anus.

In the *Pteropoda* the delicate-walled kidney is not parenchymatous, but is a

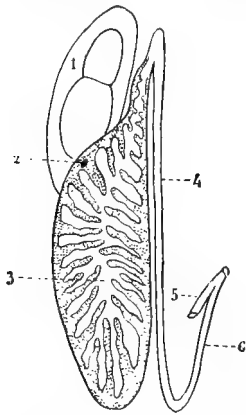

FIG. 182.—Nephridium and pericardium of *Daudebardia rufa*, from above, diagram (after Plate). 1, Pericardium; 2, reno-pericardial aperture (renal funnel); 3, nephridium; 4, primary ureter; 5, rectum; 6, secondary ureter (cf. Fig. 74, p. 77).

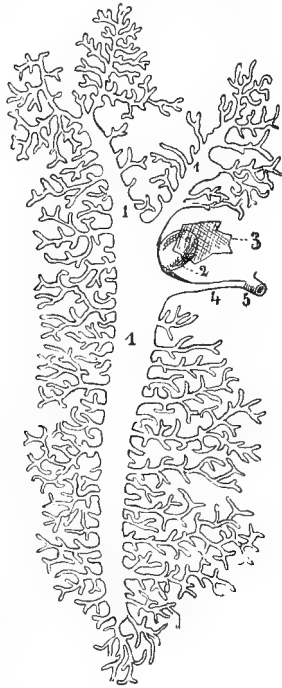

FIG. 183.—Nephridium of *Bornella* (after Hancock). 1, Kidney; 2, part connecting it with the reno-pericardial aperture (pyriform vesicle, renal syringe); 3, part of the pericardial wall; 4, ureter; 5, nephridial aperture.

simple hollow cavity lined with epithelium, and always communicates with the pericardium, against which it lies.

Nudibranchia (Fig. 183).—The kidneys of the Nudibranchia are strikingly different in form from those of the *Tectibranchia*. The unpaired kidney is here somewhat similar to the paired kidney of the *Chitonida*. It is a somewhat wide tube (renal chamber) traversing the cavity of the body, to a greater or less extent; branches entering it from all sides. This tube is connected at one end with the pericardium by a duct (renal syringe, pyriform vessel), which varies in length, and at the other opens outward through a ureter at the base of or near the anal papilla.

It is said that *Pleurobranchaea*, a *Tectibranchiate*, from which the Nudibranchia may perhaps be derived, possesses a Nudibranchiate kidney.

In *Phyllirhoë*, the urinary chamber has no branchings; it runs back from the

pericardium as a simple median tube. Anteriorly it is connected with the pericardium by a funnel, and near the middle communicates with the exterior by means of a lateral urinary duct (Fig. 19, p. 12).

C. Scaphopoda (Fig. 165, p. 193).

Dentalium has a pair of symmetrical kidneys, one on each side of the hind-gut. Each nephridium consists of a sac provided with short diverticula. The two nephridia are connected by a tube above the anus, and open into the mantle cavity by two apertures at the sides of the anus. If, as maintained by all authorities, there are no reno-pericardial apertures, the Scaphopoda would be the only group of Molluscs in which these apertures are entirely absent. Apart from the symmetry of the kidneys, a fact to be specially noted is that the genital products pass out of the genital gland into the right kidney (either by the bursting of the wall between the two organs or through an aperture), and only reach the exterior, *i.e.* the mantle-cavity, through the right renal aperture.

It must, further, be noted that near the anus on each side, between it and the renal aperture, a pore, the water-pore, occurs, the function of which is still doubtful. If these pores really lead into the blood lacunar system of the body, as was formerly maintained, and is still held to be possible, this would be the only known case of the direct imbibition of water into the blood.

D. Lamellibranchia.

The nephridium (**organ of Bojanus**) is always paired and symmetrical, and lies below the pericardium and in front of the posterior adductor. Each nephridium is tubular or sac-like, opening at one end through a funnel into the pericardium, and at the other into the mantle cavity. This communication of the kidney with the mantle cavity always takes place **above** the cerebrovisceral connective.

The lowest Lamellibranchia (*Protobranchia*, *Nucula*, *Leda*, *Solenomya*) are distinguished in two ways. (1) Each nephridium is a simple tube, with a free cavity not traversed by trabeculae or lamellae. This tube consists of two portions which unite posteriorly at an angle; the anterior end of one of these portions enters the pericardium through the renal funnel, the other end opens into the mantle cavity. (2) The paired genital glands do not open outward directly, but enter the kidneys near their pericardial funnel—a fact which is very important in

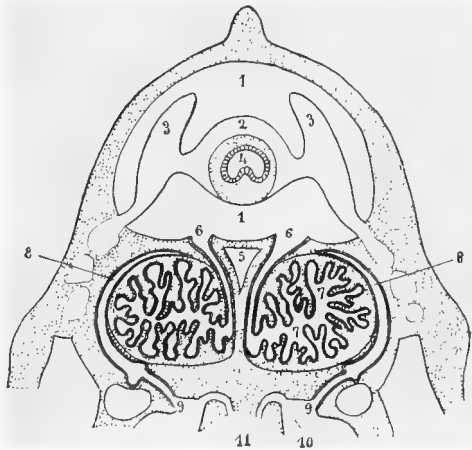

FIG. 184.—Transverse section through the body of *Anodonta*, showing the pericardium, the heart, and the kidneys, combined and diagrammatised from figures by Griesbach. Not all the parts represented occur on the same section. 1, Pericardium; 2, ventricle; 3, auricles; 4, hind-gut; 5, venous sinus; 6, reno-pericardial aperture (funnel); 7, renal sac or cavity; 8, vestibular cavity, which at 9 enters the mantle cavity through the nephridial aperture; 10, genital aperture; 11, base of the foot.

enter the kidneys near their pericardial funnel—a fact which is very important in

connection with the arrangement in the *Solenogastridae*, the lower *Prosobranchia* (i.e. the *Diotocardia*), and the *Scaphopoda*.

In other Lamellibranchia also there is a relation between the genital glands and the kidneys. In the *Pectinidae* and the *Anomiidae* the genital gland opens into the kidney, but near its outer aperture. In *Arca*, *Ostrica*, *Cyclas*, and *Montacuta*, the kidney and the genital gland open on each side into the base of a common depression (urogenital cloaca); in all other bivalves the outer nephridial and genital apertures are separate.

The simple structure of the Protobranchiate kidney becomes complicated in other Lamellibranchia in the following manner:—

1. That portion of the renal tube which opens outward forms an external cavity (vestibular cavity, external sac); this cavity has no excretory epithelium; it encircles the outer side of the pericardial portion of the kidney, the renal sac (Fig. 184). The latter alone is developed as an excretory organ. Folds or trabeculae, covered with glandular epithelium, project inward from its walls, forming a parenchymatous or spongy structure. The renal sac is connected with the pericardium by means of a nephridial funnel of varying length.

2. The two renal sacs communicate freely in the median plane. The connecting part is widest in the most specialised bivalves (*Pholadacca*, *Myacea*, *Anatinacea*, *Septibranchia*).

In *Anomia*, where all the parts are asymmetrical, the two kidneys, which do not communicate with one another, are also asymmetrical.

Venous blood flows through the kidneys on its way to the gills. The afferent renal vessels seem to have walls of their own, but the efferent vessels appear to be lacunar. Open communication between the blood vascular system and the kidneys is nowhere found.

E. Cephalopoda.

(Cf. Figs. 185, 186, and the sections on the cœlom and the blood vascular system, pp. 213 and 208).

The Cephalopoda have two (*Dibranchia*) or four (*Tetrabranchia*) spacious symmetrical renal sacs, in the posterior and upper part of the visceral dome. These communicate in the typical way at the one end with the cœlom, and at the other with the exterior (mantle cavity). Only one of the two pairs of kidneys in *Nautilus*, however, possesses cœlomic funnels.

The large veins returning from the body to the heart run along the anterior wall of the urinary sac. These veins bulge out into the cavity of the sac to form the venous appendages already mentioned. The epithelium of the urinary sac which covers these appendages is no doubt the seat of the excretory function. The excretory matter is discharged into the urinary sac (the wall of which is otherwise smooth), and passes out thence through a ureter of varying length into the mantle cavity. The renal aperture is found on the median side of the base of the gill, and in *Nautilus*, the *Oegopsidae*, and *Septoteuthis* among the *Myopsidae*, it is simple and slit-like; in the other *Myopsidae* and in the *Octopoda*, however, it lies at the end of a renal papilla which projects freely into the mantle cavity.

The two renal sacs in the *Octopoda* are entirely distinct. Near the point where the renal sac passes into the ureter lies the renal funnel, which corresponds with the pericardial aperture of other Molluscs, and which here leads to the cœlomic cavity, now reduced to the "water vascular system."

In the *Decapoda*, the two renal sacs communicate with one another in the median plane. In *Sepia*, there are two points of communication, one above and the other below. The lower junction is bulged out to form a large sac, which rises towards

the apex of the visceral dome on the anterior side of the paired renal sacs (*cf.* Fig. 177, p. 213). The veins returning from the body to the heart run in the partition between the unpaired anterior and the paired posterior sacs, and may here bulge out to form venous appendages, not only posteriorly, *i.e.* into the cavities of the two paired renal sacs, but also anteriorly, into that of the unpaired connecting sac. Near

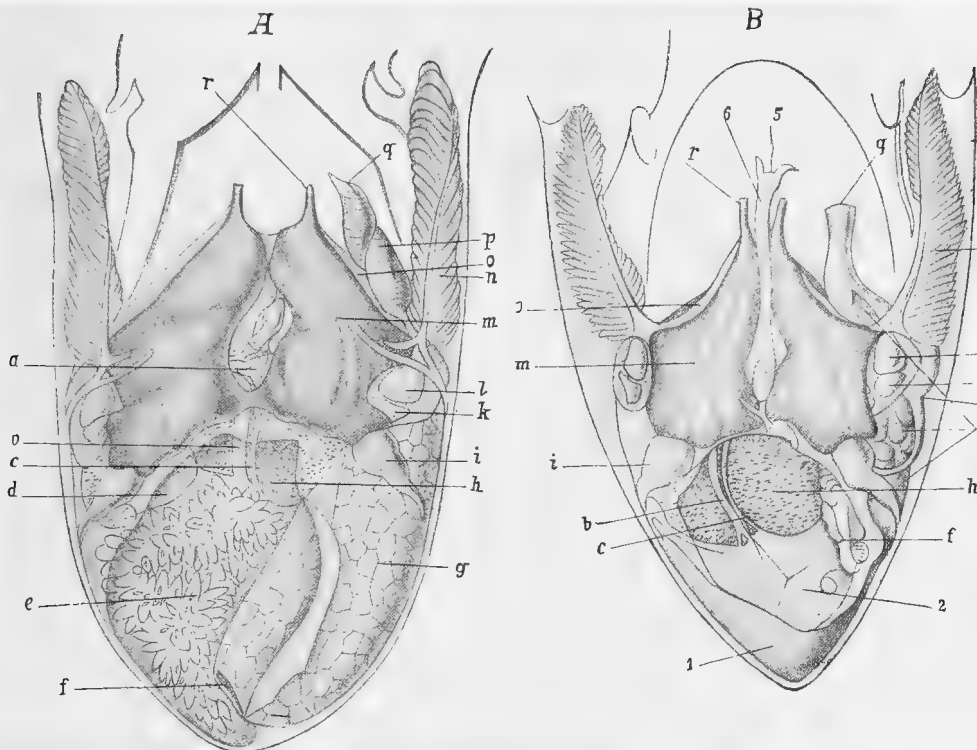

FIG. 185.—Renal sac, coelom, genital organs, etc., of *Sepia*. **A**, female; **B**, male. The visceral dome is seen from behind; the mantle, the body wall, the ink-bag, and in **A** the hind-gut and the nidamental gland are removed (after **Grobben**). *a*, Heart; *b*, genital vein; *c*, genital artery; *d*, stomach; *e*, female germinal body; *f*, aperture of the oviduct in the ovarian cavity; *g*, oviduct; *h*, unpaired anterior renal sac; *i*, abdominal vein; *k*, appendage of the branchial heart (pericardial gland); *l*, branchial heart; *m*, paired posterior renal sac; *n*, gill; *o*, canals of the coelom leading to the kidneys; *p*, gland of the oviduct; *q*, female genital aperture; *r*, renal aperture. In **B**, 1, testes; 2 (the indicator points rather beyond the right place), aperture of the male germinal body into the genital cavity or capsule; *f*, aperture of the seminal duct into the male genital capsule; 3, section of the coelom containing the vas deferens (peritoneal sac); 5, anus; 6, rectum; *g*, male genital aperture.

the point where each renal sac is produced into the ureter, the reno-pericardial canal springs from it, opening into the secondary body cavity which contains the heart, and corresponds with the pericardium of other Molluscs.

The form of the renal sac is at least partly determined by the form and position of the surrounding viscera, the stage of maturity of the genital organs, and the different shape of these organs in the two sexes. All viscera which press against the renal wall from without, bulging it inward, are naturally covered at the points of

contact with the epithelium of the renal sacs. The same is the case with all organs which, like the stomach, the gastric cecum, and the efferent ducts of the digestive glands in the *Decapoda* (*Sepia*), apparently lie inside the spacious renal sacs. These organs really lie outside of them, being only suspended into them, like the intestine of an Annelid, which apparently lies within the body cavity, but is entirely separated from it by the peritoneal endothelium.

It has been already mentioned that only one of the two pairs of renal sacs of *Nautilus*, viz. the upper pair, has retro-pericardial apertures. This fact was

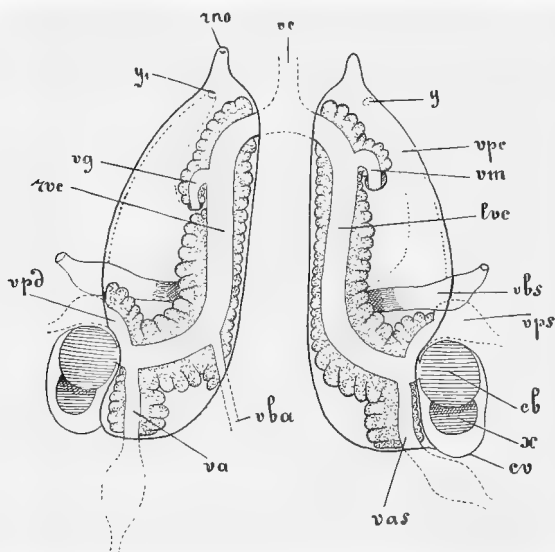

FIG. 186.—Diagram showing the posterior paired renal sacs of *Sepia officinalis*, and the vein running along its anterior wall with its venous appendages, from behind (after Vigelius). *vc*, Vena cava; *vno*, right nephridial aperture; *y*₁, left reno-pericardial aperture, the outlines of the secondary body cavity are indicated by a dotted line; *vg*, vena genitilis; *vvc*, right branch of the vena cava; *vpa*, right pallial vein; *va*, right vena abdominalis; *vba*, vein of the ink-bag; *vas*, left vena abdominalis; *vc*, section of the secondary body cavity (capsule of the branchial heart), which surrounds the branchial heart *cb*, and the appendage of the same (pericardial gland) *ac*; *vps*, left pallial vein; *lvc*, left branch of the vena cava cephalica; *vm*, left vena genitilis; *vpc*, secondary body cavity (viscero-pericardial sac); *y*, left reno-pericardial aperture (renal funnel) (cf. Fig. 174).

brought forward in support of the view that the two pairs of renal sacs arose by the division of one single pair, corresponding with that of the *Dibranchia*. According to this view, the lower pair of gills, and the two auricles are also to be considered to be new acquisitions. Indeed, the whole question of the original metamerism of the Molluscan body, which has so often been asserted, rests on very weak foundations. It gains no support from the *Chitonida*, where, in spite of large numbers of pairs of gills, only two auricles occur, and where no relation exists between the number of the shell plates and that of the gills.

XX. Genital Organs.

A. General.

In treating of the genital organs of the Mollusca, we shall have to consider—(1) the **gonads** or germinal glands, those most important organs, in which the reproductive cells (eggs and spermatozoa) are formed; (2) the **ducts** through which these cells reach the exterior; and (3) the **copulatory organs**.

1. The gonads or germinal glands have already, in Section XVIII., been recognised as completely or incompletely demarcated portions of the secondary body cavity, and have been described in their relation to the other divisions of that cavity.

The gonads are paired and symmetrical in the *Lamellibranchia* and *Solenogastres*, occurring in one pair. In all other Mollusca, only one unpaired gonad is found. In very rare cases, such as that of some hermaphrodite *Lamellibranchs*, which will be described later, there are two pairs of gonads, one female and one male.

The sexes are separate, among the *Amphineura* in the *Chitonida* and *Chaetoderma*, in many *Lamellibranchs*, in the *Scaphopoda*, among the *Gastropoda* in the *Prosobranchia* (excepting a few *Marseniade* and the *Valvata*), and in all *Cephalopoda*. Hermaphroditism prevails among the *Amphineura* in *Proneomenia*, *Neomenia*, and allied forms; in many *Lamellibranchs*, among the *Gastropoda* in the *Pulmonata*, *Opisthobranchia*, and in the *Prosobranchiate* family of the *Marseniade*.

In hermaphrodite animals, it is the rule that the same gland, the **hermaphrodite gland**, produces both eggs and spermatozoa, but in exceptional cases there are in the same individual distinct male and female gonads (testes and ovaries). This is the case, as already mentioned, in certain bivalves, viz. the *Anatinacea* and the *Septibranchia*, which possess two testes and two ovaries.

Position of the gonads.—The long tubular hermaphrodite glands of the *Solenogastres*, which are separated from one another by a median septum, lie in the anterior prolongation of the pericardium, over the intestine. In the *Chitonida*, the gonads are found in a similar position, but are not in open communication with the pericardium. In the *Gastropoda* they lie in the visceral dome, usually in its uppermost part, between the lobes of the digestive gland. Where the visceral dome has disappeared, the gonad with the intestine and the digestive gland shift back into the primary body cavity above the foot. The gonads in the *Scaphopoda* occupy a position similar to that of the *Gastropodan* gonads, lying dorsally in the high visceral dome, above the anus and the kidneys. The same is the case in the *Cephalopoda*. The paired much-lobed genital glands of the *Lamellibranchia* lie in the typical position in the primary body cavity, above

the muscular part of the foot, between the coils of the intestine. They may lie behind the "liver," or else, passing between its lobes, spread out at the sides of and below the kidney.

The epithelium which lines the gonads is, morphologically, the endothelium of the secondary body cavity. The reproductive cells may either be produced from any part of the epithelium of the gonad, or from definite areas of this epithelium (*Cephalopoda*), which areas may then be called germinal epithelium or germinal layers. It may then appear as if the germinal gland lay in or on a special sac, whereas this sac is, in reality, the gonad itself, and the germinal gland is only the much-developed germinal layer of the gonad.

The ripe reproductive cells become detached from their place of formation, and fall into the cavity of the gonad, *i.e.* into a part of the secondary body cavity, from which they pass out in various ways.

2. The gonads either have separate ducts (*Chitonidæ*, *Monotocardia*, *Pulmonata*, *Opisthobranchia*, *Cephalopoda*, many *Lamellibranchia*) or they utilise the nephridia as ducts. In the latter case the genital products either pass direct into the kidney, and reach the exterior through the nephridial aperture (all *Diotocardia*, the *Scaphopoda*, and many *Lamellibranchia*), or they first pass into the pericardium, and then are ejected through the nephridia (*Solenogastres*). Where the gonads open into the kidneys, their apertures may lie in various parts of these organs; either in the proximal part, which communicates with the pericardium by means of the renal funnel, and is usually widened into the renal sac, or in the distal part (ureter) which opens externally, or into a shallow urogenital cloaca.

The gonads therefore open into:—

- a. The pericardium (*Solenogastres*).
- b. The proximal or pericardial part of the kidney.
- c. The distal part or ureter of the kidney.
- d. The urogenital cloaca. Or:—
- e. They open externally, quite apart from the kidney.

Paired gonads have paired ducts (*Solenogastres*, *Lamellibranchia*). Where there is a single unpaired gonad, there is either a single efferent renal duct, or a single renal duct is made use of (*Gastropoda*, *Scaphopoda*, *Cephalopoda*, etc.); the duct is then always asymmetrical and usually lies on the right side. A paired duct, belonging to an unpaired genital gland, is, however, found in the *Chitonidæ* and in many *Cephalopoda*.

When the genital glands have special efferent ducts, various sections of the latter may be differentiated into accessory sacs and glands, copulatory apparatus, etc., which, especially in the *Pulmonata*, *Opisthobranchia*, and *Cephalopoda*, transform the ducts into a very complicated apparatus. In males, this complication arises through the development of copulatory organs, and of special glands which form the capsules of the spermatophores, and of seminal vesicles, etc.; in females, through the development of albuminous glands, shell

glands, receptacula seminis, vagina, etc. Since, in hermaphrodite Molluscs, both kinds of complication occur simultaneously in the same genital apparatus, the most complicated arrangement is found in the (hermaphrodite) *Pulmonata* and *Opisthobranchia*.

3. **Copulatory organs** are wanting in many Molluscs, such as the *Amphineura* (see below), nearly all *Diotocardia*, the *Scaphopoda*, and all *Lamellibranchia*. They are present in the *Monotocardia*, the *Pulmonata*, *Opisthobranchia*, and *Cephalopoda*. In the *Gastropoda*, in the nuchal region, to the right, there is a male apparatus, consisting sometimes of a freely projecting muscular penis, sometimes of an organ which can be protruded or evaginated through the genital aperture. In the *Cephalopoda*, this is a definite arm in the male, which is specially modified (**hectocotilised**), sometimes in a very remarkable manner, and which plays a more or less important part in copulation.

B. Special.

a. **Gonads.** (1) **Amphineura.**—The long hermaphrodite gland of *Proneomenia* and allied forms has been called paired. As a matter of fact it is divided into two more or less distinct lateral tubes, by a median much-folded septum. In the lower portion of each tube, that which lies next the intestine, the germinal epithelium produces spermatozoa, in the upper portion eggs. Posteriorly, these tubes separate for a certain distance, and open as a pair of distinct ducts into the anterior end of the pericardium.

The male or female gonad of the *Chitonidae* lies as a long unpaired sac on the dorsal side of the intestine, in front of and partly under the pericardium. In the ovary, numerous pear-shaped tubes (Fig. 187) project from the epithelial wall into the cavity. Each of these tubes is a stalked follicle, with egg cells surrounded by follicular cells. These follicles are

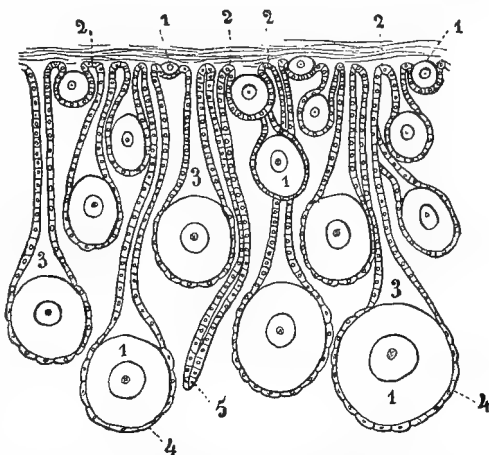

FIG. 187.—Section through the wall of the ovary of *Chiton* (diagram after Haller). 1, Eggs at different stages of development; 2, germinal epithelium; 3, egg sac or tubes; 4, follicular epithelium; 5, egg tube after the discharge of the egg.

found in all sizes and at all stages of development. Each egg is at first a simple ovarian epithelial cell, which is distinguished by its size from the surrounding epithelial cells. As it grows and becomes more and more rich in yolk, it sinks down under the ovarian epithelium, bulging out this latter towards the ovarian cavity, and thus forming a young follicle. The wall of the pear-shaped testicle also rises into its cavity in the form of numerous folds, in which the epithelium becomes multilaminar, and produces the mother cells of the spermatozoa.

The fact that the gonad of *Chiton* has two ducts makes it probable that it was

originally paired. The two ducts, *i.e.* the two seminal ducts in the male and the two ovarian ducts in the female, open into the mantle furrow on each side, somewhat in front of the renal aperture (Fig. 180, p. 217).

(2) **Gastropoda.**—The gonads of the *Prosobranchia* offer but few points of interest to the comparative anatomist. In the *Pulmonata* and *Opisthobranchia*, the germinal gland is a hermaphrodite gland, in which spermatozoa and eggs are produced simultaneously. This gland is much lobed, or else consists of numerous converging diverticula; the spermatozoa and eggs arise intermingled on the walls, become detached at one of the stages of their development, and then lie free in the cavity of the gonad. The same applies to the large hermaphrodite gland of the *Tectibranchia*, which varies much in its outer form. It lies in the posterior part of the body, on the digestive gland, penetrating at times between its lobes; it is itself more or less lobed, its lobes consisting of secondary lobes (vesicles or acini). In all these acini, spermatozoa and eggs are simultaneously produced. It is only in the *Pleurobranchia* and allied forms that the parts of the gland which produce spermatozoa and those which produce eggs are localised; this arrangement resembles that in the *Nudibranchia*, which will presently be described. The constituent lobes or vesicles are either male or female, the former producing only spermatozoa, the latter only eggs. This is the arrangement found also in some *Nudibranchia* (*Amphorina*, *Capellinia*), but in most *Nudibranchs* the male and the female germinal regions become separated in such a way that the terminal acini yield eggs only, but open in groups into lobes of the gland which produce only spermatozoa. Each lobe has its duct; these ducts, uniting together, finally form the duct of the hermaphrodite gland. This gland thus forms an extensive organ spread out in the larger posterior part of the primary body cavity; where there is a compact digestive gland it covers this organ. *Phyllirhoë* has 2 to 6 (usually 3) separate globular acini whose long and thin ducts combine to form a hermaphrodite duct (Fig. 195, p. 238).

The hermaphrodite gland of the *Pteropoda* (*Tectibranchia natantia*) always lies in the upper (dorsal) portion of the visceral dome; it is sometimes acinose and sometimes consists of converging tubular follicles or of laminae closely crowded together. The eggs are always produced at the peripheral part of the acini, tubes, or lamellae, while the spermatozoa arise in the central parts, near the ducts. These two parts are generally separated by a membrane, which the eggs have to break through to reach the hermaphrodite duct. The *Pteropoda* are protandrously hermaphrodite, *i.e.* the spermatozoa are produced before the eggs, an arrangement found in many hermaphrodite Molluscs.

(3) **Scaphopoda.**—The gonad (testis, ovary) in these animals is a long spacious sac, provided with lateral diverticula; it lies above the anus, rising high up into the visceral dome along the posterior side of the body. In the *Solenopoda* (*Siphonodentalium*, etc.) a large part of the gonad stretches into the mantle. In young animals, the gonad is closed on all sides, but in adults its wall appears to fuse with the right kidney, and in the partition wall so formed an aperture arises which establishes communication between the gonad and the right nephridium.

(4) **Lamellibranchia.**—The gonads are here found in the form of much-branched tubular or lobate masses lying on each side in the primary body cavity, surrounding and partly penetrating between the other internal organs. In some cases (*Anomida*, *Mytilida*), the gonad on each side stretches into the mantle. In others (*Axinus*, *Montacuta*), it bulges out the body wall in such a way that branched outgrowths, containing the germinal tubes, project from the body into the mantle cavity.

In most Lamellibranchia the sexes are separate, but hermaphroditism sometimes occurs. There are (1) whole groups of bivalves which are hermaphrodite; *e.g.* the most specialised forms, such as the *Anatinacca* and *Septibranchia*; (2) families

with a few hermaphrodite genera: *Cyclus*, *Pisidium*, *Entovalva*; (3) genera (*Ostræa*, *Pecten*, *Cardium*) with a few hermaphrodite species; (4) occasional cases of hermaphroditism in species the sexes of which are usually separate: *Anodonta*. The hermaphroditism of the Lamellibranchia is, however, always incomplete in the sense that the spermatozoa and the eggs do not ripen simultaneously.

In the *Anatinacea* and *Septibranchia*, there are on each side entirely separate male and female gonads, whereas all other hermaphrodite Lamellibranchs have a hermaphrodite gland on each side.

(5) **Cephalopoda**.—The sexes are always separate in this class. It has already been mentioned that the germinal sacs form a part of the secondary body cavity, with which they are in open communication.

One single unpaired gonad is always found, lying in the uppermost part of the visceral dome. It is a variously-formed sac (peritoneal sac or genital capsule), lined on all sides by an epithelium often to a great extent ciliated, which is in reality the peritoneal epithelium of the secondary body cavity. The whole of the epithelium covering the wall of the gonad is not, however, germinal, but only that on its anterior side (that turned to the shell). The germinal layer here forms what may be called, in the narrower sense, the ovary or the testis, which is then said to be contained in a peritoneal sac or an ovarian or testicular capsule, or else to project into or be suspended in such sac or capsule. The whole apparatus is really a gonad, in which the places of formation of the reproductive cells are localised on the anterior wall.

From this it is clear why the testes and ovaries do not appear to possess efferent ducts of their own, but to empty their products into their respective capsules, these products passing out into the mantle cavity through the ducts of these capsules (oviducts and seminal ducts). Since, however, the entire germinal sac corresponds with the genital gland of a *Gastropod* or a *Lamellibranch*, the reproductive products in reality merely fall into the cavity of this gland (the testicular and ovarian capsules), and pass out through the ovarian and seminal ducts, which exactly correspond with the same ducts in the *Gastropoda*, *Lamellibranchia*, and *Chitonida*.

The genital cavity has also another means of communication with the exterior, since, in the Cephalopoda, it is in open communication with the remaining part of the secondary body cavity, whether the latter forms a visceropericardial cavity (*Decapoda*) or is reduced to the "water canal system" (*Octopoda*). This latter part of the body cavity again is connected, by means of the nephridia, with the mantle cavity.

In this way, the genital cavity communicates with the mantle cavity directly by means of the oviduct or seminal duct, and indirectly through (1) the visceropericardial cavity or the "water canal system," and (2) the nephridia. This second way of communication, however, is never used for discharging the genital products.

The female germinal layer or ovarian layer (the ovary in the narrower sense) is always found on the anterior wall of the gonad, and varies considerably in structure (Fig. 188). We can always distinguish (1) the eggs, and (2) the ovigerous wall. The former are stalked, and project from the wall into the cavity of the gonad (the cavity of the ovarian capsule). The largest and oldest eggs are covered by a follicular epithelium, and this latter by the general epithelium of the wall of the gonad, which also covers the stalk. Each egg has a separate stalk. The youngest eggs are mere prominences on the wall, which in the process of growth acquire a stalk, by means of which they remain connected with the wall from which they project. This arrangement is exactly like that in the *Chiton*. When the eggs are mature, the follicle bursts, they fall into the genital cavity, and thence reach the exterior through the oviduct.

In *Nautilus* (Fig. 188, *A*) and *Eledone* the whole wall of the gonad, with the exception of the posterior surface, can produce eggs; these stand out from it all over on simple stalks. In *Argonautæ* (Fig. 188, *B*) and *Tremoctopus* also, the whole ovarian capsule except the posterior wall produces eggs, but the egg-bearing region (to

obtain increase of surface) projects into the genital cavity in the form of numerous dendriform processes, the eggs being attached by simple stalks to the stems and branches. In *Parasira* (*Tremoctopus*) *catenulata* there is a central region containing more than twenty large "egg trees" surrounded by a circle of smaller "trees." On the anterior wall of the gonad in *Octopus* there is a single but very richly-branched "egg tree" (*C*). In *Sepia*, *Sepiolo*, and *Rossia* the egg-bearing surface bulges out in the shape of a ridge on the anterior wall of the gonad. This ridge, in *Loligo*, becomes a narrow fold, the free edge of which is produced into filaments, which carry on all sides simply-stalked eggs. In the *Oegopsida* (*Ommastrephes*, Fig. 188, *D*, *Onychoteuthis*, *Thysanoteuthis*) the region which carries the eggs is only attached by its upper and lower ends to the wall of the gonad, and forms an otherwise free spindle-shaped body traversing the genital cavity, and beset all over with stalked eggs.

In *Octopus* and *Eledone* all the eggs in a given ovary are found at the same stage of maturity.

A peculiar transformation of the follicular epithelium takes place in the ovarian eggs of the Cephalopoda when nearly mature. An extraordinary increase of surface occurs in the shape of numerous folds, which run longitudinally along the egg, either reticulating or remaining parallel to one another, and projecting far into the yolk

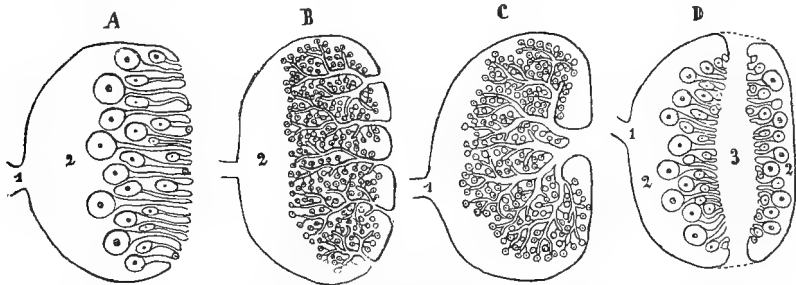

FIG. 188.—*A-D*, Four diagrams of the female gonads of the Cephalopoda. *A*, *Nautilus* type. *B*, *Argonaut* type. *C*, *Octopus* type. *D*, *Ommastrephes* type. 1, Aperture of the oviduct into the gonad; 2, cavity of the gonad (a section of the secondary body cavity); 3, egg-carrier.

of the egg which they surround. This arrangement may be connected with the nutrition of the egg.

The male germinal layer (germinal body, or testis in the narrower sense) is a variously-shaped (often globular or oviform) compact organ, which usually lies free in the genital cavity, suspended to its anterior wall by a thin ligament (**mesorchium**) in which the genital artery runs. The germinal body is everywhere covered with epithelium, which is continued over the mesorchium into the epithelium of the wall of the gonad (endothelium of the testicular capsule). On the surface of the germinal body which is turned away from the mesorchium, there is a funnel-shaped depression (Fig. 189, *A*); towards this, from all sides, the tubular testicular canals which form the male germinal body converge, in order to open into it. In these testicular canals, between which there is a slight framework of connective tissue, the spermatozoa are produced, and are passed on to the genital cavity through the depression into which all the canals open; they reach the exterior by means of the seminal duct. The testicular canals originally possess a multilaminar germinal epithelium, which yields the spermatozoa, and which passes at the common aperture into the outer epithelium of the germinal body, and so into the epithelium of the germinal sac.

This description applies to the male germinal body of most Cephalopoda. In

Loligo (B), however, the funnel-shaped depression into which all the testicular canals open is replaced by a longitudinal furrow, into which these converging canals open. In *Sepia* (C), the germinal body has no ligament, but lies immediately in front of the anterior wall of the gonad, and is thus outside the genital cavity. The germinal body here has a central channel towards which the radially arranged seminal canals converge from all sides, and which they enter. This channel, again, opens through an efferent duct into the genital cavity, from which the spermatozoa are conducted to the exterior by the seminal duct.

The spermatozoa of the Mollusca are of the common pin shape. In many species of *Prosobranchia* two different forms of spermatozoa, the hair-shaped and the vermiform, occur in one and the same individual. This phenomenon has by some been taken as an indication of developing hermaphroditism, and by others as pointing to a former hermaphrodite condition; in the first case the vermiform spermatozoa would be the eggs beginning to form, in the second the rudiments of eggs. There is, however, no solid foundation for either of these views.

With regard to the question whether the hermaphrodite or the dioecious condition is the original condition, the latter alternative may be considered as the more probable. Of the five classes of the Mollusca, two, the *Scaphopoda* and the *Cephalopoda*,

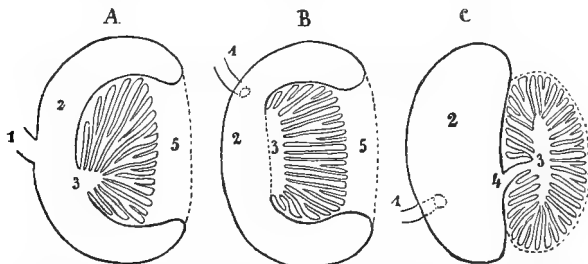

FIG. 189.—A, B, C, Three diagrams of the male gonads of the Cephalopoda. A, ordinary type. B, *Loligo*. C, *Sepia*. 1, Seminal duct; 2, cavity of the gonad; 3, space into which all the canals of the testis open, and which itself opens into the cavity of the gonad, in *Sepia*, by means of a canal (4); 5, suspensor of the male germinal body, attaching it to the anterior wall of the gonad.

are altogether dioecious. Among the *Amphineura*, the *Chitonidae*, which most recent observers hold to be less specialised than the *Solenogastres*, are sexually separate. Among the *Lamellibranchia*, the sexes are separate in the *Protobranchia*, which are rightly considered as primitive forms; and most other bivalves are also dioecious. Among the *Gastropoda*, the sexes are separate in the *Prosobranchia*, especially in the *Diotocardia*, which are universally considered to be the lowest and least specialised *Gastropods*.

b. The ducts.—The manner in which the sexual products are conducted to the exterior in the *Amphineura*, *Scaphopoda*, and *Lamellibranchia* need not again be discussed, as it has already been described in the general part of this section, and in the section on the nephridial system. We thus have now only to treat of the very complicated ducts of the *Gastropoda* and the *Cephalopoda*.

(1) *Gastropoda*.—It has been seen that in all *Diotocardia* (*Haliotis*, *Fissurella*, *Patella*, etc.) the genital products are ejected through the right kidney. In the *Monotocardia*, the right kidney has atrophied as such, but, according to the most recent investigations, its duct persists as genital duct. In the *Pulmonata* and *Opisthobranchia*, the genital aperture is no longer in the mantle cavity,

but has shifted far forward along the right side of the neck, probably in connection with the development of the copulatory apparatus. The position of this aperture is thus not necessarily affected by any further displacement of the pallial complex, or indeed of the whole visceral dome, which explains the fact that, in *Daudebardia* and *Testacella*, the common genital aperture, and in *Oncidium*, the male aperture, lies far forward on the right side of the body, although the pallial complex has shifted completely to the posterior end of the body.

In the *Opisthobranchia* also, the single or (secondarily) double genital aperture lies to the right in front of the anus and even in front of the kidney. This position seems inexplicable except by the supposition of a shifting back of the pallial complex in which the genital aperture, emancipated from the complex, took no part, thus coming to lie in front of the shifted anal and renal apertures.

Monotocardia.—Unlike the *Diotocardia*, which, with the exception of the *Neritida*, have no copulatory organs, the Monotocardia possess a penis, which, however, does not lie in the mantle cavity where the genital aperture originally lay. It would be unable to function in this position, and is therefore placed on the right side of the head or neck (Fig 71, p. 73), and forms a freely projecting, extensible, muscular appendage, which often attains a considerable size. The male genital aperture, however, in very many, perhaps in most, Monotocardia, remains in its original position in the mantle cavity, to the right, near the rectum. In such cases, a ciliated furrow runs forward on the floor of the respiratory cavity, along the right side of the neck, to the base of the penis, to the tip of which it is continued as a deep groove. This furrow conducts the semen to the penis from the genital aperture. In some cases the furrow closes, and forms a canal; the penis then becomes tubular, and the seminal duct enters into it. The genital aperture is thus shifted far forward from its original position. The seminal duct, which arises from the testis, usually forms coils as it runs along the columellar side of the shell. The vas deferens has no special appendages, although it may widen into a vesicle at some point in its course.

In the female, the genital aperture remains in the mantle cavity, lying to the right near the rectum, behind the anus. The duct remains, as a rule, more or less simple; it is divided into the following consecutive sections: (1) an **oviduct**, rising from the ovary, which may bulge out to form one or more **receptacula seminis**; (2) the **uterus**, a wider section with thick glandular walls, in which the eggs are provided with albumen and a shell; (3) a muscular sheath, the **vagina**, which leads to the outer genital aperture. In *Paludina*, there is a special **albuminous gland** opening into the oviduct.

In hermaphrodite *Prosobranchia* (*Valvata*, a few *Marseniadae*, e.g. *Marsenina*, *Onchidiopsis*) a hermaphrodite gland is found. This gland gives rise either to one duct, which divides later into a vas deferens and an oviduct, or to a vas deferens and an oviduct which are from the first distinct. The vas deferens runs to the penis as in the males of dioecious *Prosobranchiata*; the oviduct runs to the female genital aperture. Both these ducts are, owing to the occurrence of accessory glands, etc., more complicated than in other *Prosobranchiata*.

Opisthobranchia and Pulmonata.—The ducts in these orders are extremely complicated, both by division into many consecutive sections and by the development of various accessory organs.

In the following descriptions of several types of genital ducts only the most important points can be mentioned. We give first the type of duct commonly found in the *Cephalaspidea* (*Tectibranchia*).

1st Type.—The hermaphrodite gland has a single undivided efferent duct, opening out through a single genital aperture. From this aperture the fertilised eggs pass out direct, but the spermatozoa pass into a ciliated seminal furrow which runs along in the mantle cavity, and by which they are conducted to the penis.

This lies more or less far forward in front of the genital aperture, near the right tentacle.

If we imagine the testis of a male Monotocardian transformed into a hermaphrodite gland, and the vas deferens into a hermaphrodite duct, the above condition would be realised.

Gastropteron may be chosen as a good example of this arrangement (Fig. 190), which is further found in other *Cephalaspidae* (*Doridium*, *Philine*, *Scaphander*, *Bulla*) and all *Pteropoda*.

The hermaphrodite gland or ovoiduct, which lies between the lobes of the liver in the posterior part of the body, gives rise to a hermaphrodite duct, which, after a long coiled course, enters a short but much widened terminal section known as the uterus or genital cloaca. This cloaca opens outward in front of the base of the gills through the genital aperture. Into the cloaca open: (1) the common efferent duct of two glands, one of which, the albuminous gland, supplies the egg with albumen, while the other, the nidamental or shell gland, yields its outer protective envelope; (2) the duct of a globular vesicle (receptaculum seminis, Schwammerdam's vesicle), which receives the spermatozoa during copulation. From the genital aperture, which has a more or less median position on the right side of the body, the seminal furrow runs forward to the penis. The latter is enclosed in a special sheath, out of which it can be protruded, and into which it is withdrawn by means of a retractor muscle. A gland called the prostata opens into the penis. The penis itself lies on the right anteriorly, on the boundary between the head and the foot. When it is at rest its sheath lies in the cephalic cavity, near the buccal mass.

The very complicated ducts of *Aplysia* and *Accra* do not essentially differ from that above described. The hermaphrodite duct, on reaching the region of the albuminous gland, coils back upon itself, the ascending and descending portions of this coil surrounding the albumen gland with their spiral coils. The penis has no prostata.

2nd Type.—The hermaphrodite gland gives rise to a hermaphrodite duct, which soon divides into two parts, the vas deferens or seminal duct, and the oviduct. The former runs to the male copulatory apparatus, the latter to the female genital

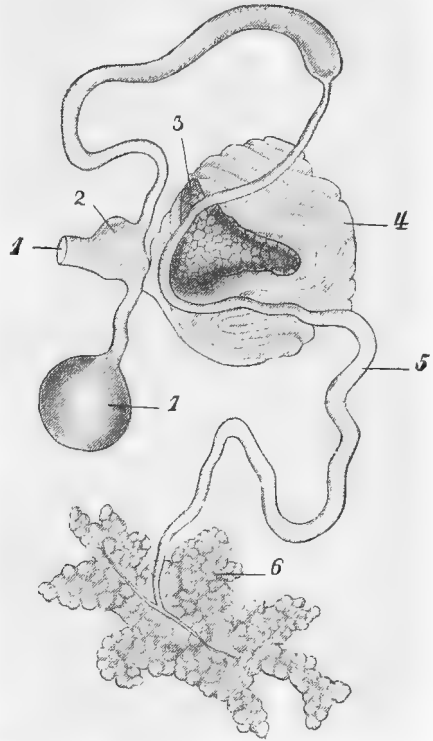

FIG. 190.—Genital organs of *Gastropteron Meckelii* (after *Vayssière*). The penis and the seminal furrow are not drawn. 1, Common genital aperture; 2, genital cloaca; 3, albuminous gland; 4, nidamental gland; 5, hermaphrodite duct; 6, hermaphrodite gland; 7, receptaculum seminis.

aperture. The male aperture and the penis lie in front of the female, far forward on the head or neck; the two apertures are quite distinct, and both lie on the right.

This second type may be deduced from the first, if we assume not only that the common duct of the hermaphrodite gland divided into a male and a female duct, but also that the seminal furrow closed to form a canal in continuation of the male duct.

When the duct of this second type split into a male and a female duct, the accessory organs also so divided that the male opened into the vas deferens, the female into the oviduct.

To this type belong, among the *Pulmonata*, the *Basommatophora*, a few species of *Daudebardia* (*D. Saulcyi*, in which the two apertures lie close together), the *Oncidia*, and *Vaginulide*. In both these latter groups, the female aperture has followed that part of the pallial complex which shifted to the posterior end of the body, and lies near the anus. The male aperture has, however, retained its anterior position on the head, behind the right cephalic tentacle. The two apertures thus lie at the opposite ends of the body. Among the *Opisthobranchia*, this second type is exemplified in *Oscinius* (*Tectibranchia*).

Taking *Limnæa stagnalis* and *Oncidium* as examples, we find in the former (Fig. 191) that the hermaphrodite gland which lies embedded in the "liver," high up in the visceral dome, gives rise to a thin hermaphrodite duct; this soon divides into a male and a female duct. The male duct first widens into a flattened sac, then into a large pear-shaped glandular vesicle (prostata). From this vesicle it runs as a long thin vas deferens through part of the pedal musculature, and finally enters the male copulatory apparatus, which is, in fact, merely the widened muscular and protrusible end of the vas deferens. A small penis tube is first formed by the vas deferens, and this projects on a papilla into a subsequent larger tube (the penis sheath), which is evaginated during copulation. Protractors are attached to the sheath, and retractors to the small tube; the latter alone with its papilla enters the vulva during copulation.

An albuminous gland opens into the female duct immediately after its separation from the male duct. It then forms a uterus consisting of wavy folds, and is continued into a large pear-shaped body as oviduct, the narrow end of which is the vagina and leads to the female genital aperture. The oviduct receives a lateral accessory gland called the nidamental gland, and the vagina the efferent duct of the globular receptaculum seminis.

In *Oncidium celticum* (Fig. 192) the hermaphrodite gland and female accessory glands lie in the posterior part of the body, between the lobes of the liver and the coils of the intestine. From the gland rises a hermaphrodite duct, which at one point carries a small lateral cæcum, and opens into an irregularly-shaped organ, the uterus. Within the uterus two projecting folds border a channel; if these folds become apposed, the channel becomes a tube. This channel runs from the point of entrance of the hermaphrodite duct to the point where the seminal duct leaves the uterus, and serves for conducting the semen. The remaining wider portion of the uterus serves as oviduct and egg-reservoir, and carries a large caecal appendage; the ducts of the two much-lobed albuminous glands also enter the uterus.

A comparison of *Limnæa* and *Oncidium* shows that in the latter the male and female ducts separate from one another further back than in the former. The vas deferens in *Oncidium* is only incompletely separated as a groove in the uterus. Its differentiation into a separate duct takes place here, as in terrestrial *Pulmonates*, at the distal end of the uterus. The thin seminal duct (vas deferens) passes into the body wall to the right, and runs forward along the longitudinal furrow between the foot and back, passing again at the anterior end of the body into the primary body cavity, where it forms numerous coils, and finally enters the copulatory apparatus.

This apparatus, in *Limnaea*, consists of a large evaginable terminal widening, into which the vas deferens projects in the form of a papilla. Blood pressure causes the penis sheath or præputium to be evaginated through the genital aperture, into which

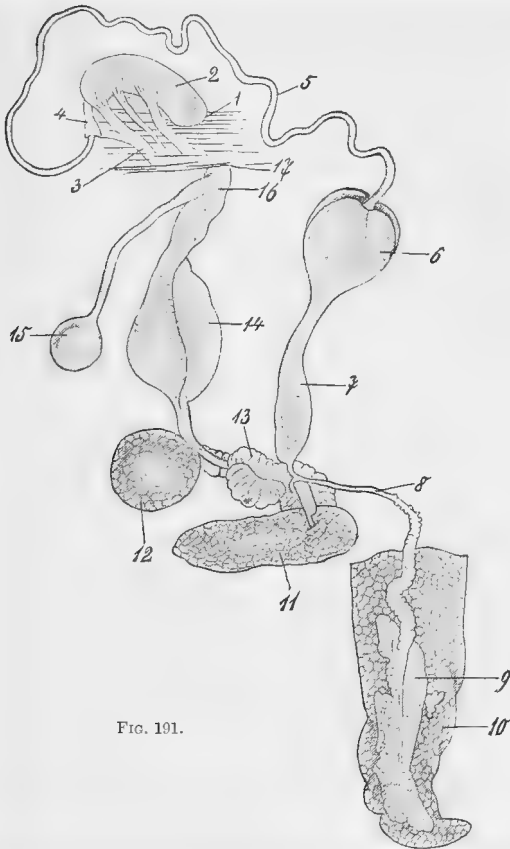

FIG. 191.

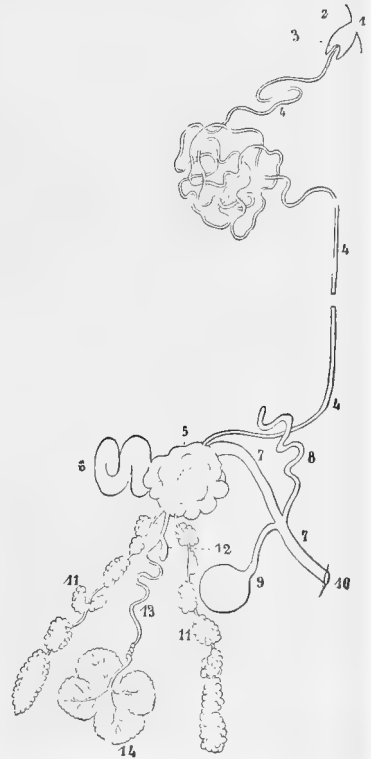

FIG. 192.

FIG. 191.—Genital organs of *Limnaea stagnalis* (after Baudelot). 1, Male genital aperture; 2, larger penis tube (penis sheath); 3, protractors; 4, smaller penis tube; 5, vas deferens; 6, pro-stata; 7, flattened widening of the vas deferens; 8, hermaphrodite duct; 9, hermaphrodite gland; 10, part of the digestive gland (liver); 11, albuminous gland; 12, nidamental gland; 13, uterus; 14, pear-shaped body; 15, receptaculum seminis; 16, vagina; 17, female genital aperture.

FIG. 192.—Genital organs of *Oncidium celticum* (combined from the figures of Joyeux-Laffuie), somewhat diagrammatic; only part of the vas deferens is drawn. 1, Male genital aperture; 2, penis sheath (præputium); 3, penis papilla; 4, vas deferens; 5, uterus, the seminal furrow in the uterus is indicated by dotted lines; 6, caecum of the uterus; 7, oviduct and vagina; 8, caecal appendage; 9, receptaculum seminis; 10, female genital aperture; 11, albuminous glands; 12, caecum of the hermaphrodite duct; 13; 14, hermaphrodite gland.

it is again withdrawn by means of a retractor. In other species of *Oncidium*, the copulatory apparatus is complicated by the occurrence of accessory penis glands and variously-shaped cartilaginous armature.

The oviduct which separates from the vas deferens at the end of the uterus is also a vagina. It is a simple tube which opens outward to the right near the anus through the genital aperture. Near the middle of its course it is joined by the stalk-like duct of a globular vesicle, the receptaculum seminis (bursa copulatrix), and by a long glandular cæcal appendage.

3rd Type.—We find this in the *Stylommatophora* among the *Pulmonata*, and also

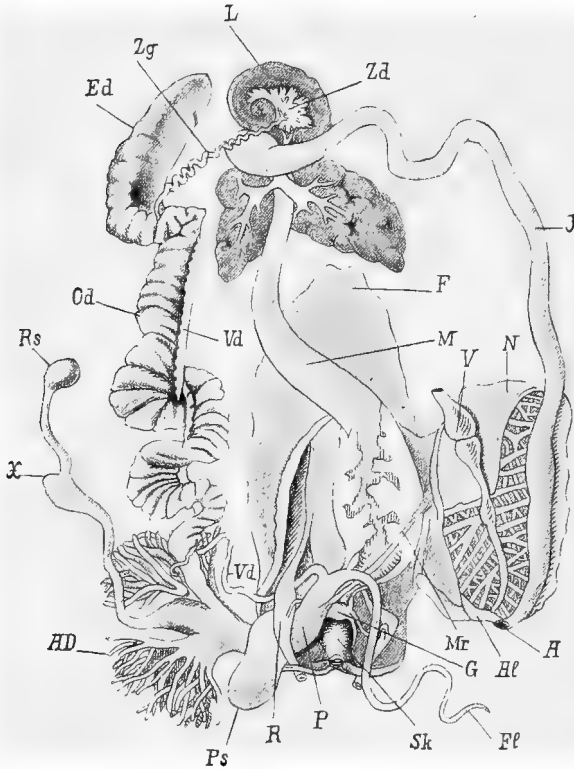

FIG. 193. -Anatomy of *Helix pomatia* (after Leuckart, Wandtafeln). The shell is removed and the mantle laid back to the left, the organs of the visceral dome and head are isolated and separated. To the left (in the figure) are the genital organs. *L*, Digestive gland (liver); *Zd*, hermaphrodite gland; *J*, intestine; *N*, kidney; *V*, ventricle; *M*, fore-stomach; *F*, foot; *A*, anus; *Al*, edge of the mantle near the respiratory aperture; *Mr*, retractor muscle; *G*, cerebral ganglion; *Fl*, flagellum; *Sk*, oesophageal bulb (pharynx); *P*, penis; *R*, retractor of the tentacle; *Ps*, dart sac; *AD*, digitate glands; *Vd*, vas deferens; *X*, lateral bulging of the stalk of the receptaculum seminis (*Rs*); *Od*, portion of the uterus belonging to the oviduct; *Ed*, albuminous gland; *Zg*, hermaphrodite duct.

in all *Nudibranchia* and a few *Tectibranchia* (e.g. *Pleurobranchæa*). The hermaphrodite gland gives rise to a hermaphrodite duct, which, as in the second type, sooner or later divides into a male and a female duct. These, however, do not open out through distinct apertures, but again unite to form a common atrium genitale or a genital cloaca. This third type may be deduced from the second by supposing that the male and female apertures became approximated, and finally opened together.

Helix pomatia and *Pleurobranchæa Meckelii* afford good examples of this arrangement.

Helix pomatia (Fig. 193).—From the hermaphrodite gland a hermaphrodite duct, in zigzag coils, passes into the long folded uterus. The straight band which passes along the folds of the uterus is that portion of it which belongs to the seminal duct; the folds belonging to the female ducts. The seminal channel, however, is merely a furrow within the uterus, divided from the cavity of the latter by two projecting folds, the edges of which become superimposed. A longitudinal glandular band, which is regarded as a prostata, accompanies this duct. At the point where the hermaphrodite duct passes into the uterus, the large linguiform albuminous gland opens into it. At the end of the uterus, the male and female ducts become entirely distinct. The thin vas deferens runs in coils to the copulatory apparatus, which again opens into the genital cloaca. The copulatory apparatus consists of a protrusible penis; at the point where the vas deferens enters this organ, the latter carries a long hollow appendage, the flagellum, the glandular epithelium of which perhaps yields the substance of the spermatophoral capsules. At the same point a retractor muscle is attached to the penis. The short oviduct widens before opening into the genital cloaca. The widened portion has the following appendages: (1) a long stalked pear-shaped receptaculum seminis, lying close to the uterus,—the stalk has a lateral bulging, which is sometimes rudimentary; (2) two tassel-shaped organs, the digitate glands, the milky secretion of which contains calcareous concretions, and no doubt assists in the formation of the outer envelope of the egg; (3) the dart sac, which lies close to the cloaca, and contains a pointed calcareous rod, the *spiculum amoris*, which is thrust by each individual into the tissue of the other as an excitant during copulation.

The common outer genital aperture lies in the nuchal region behind the right optic tentacle.

Pleurobranchæa Meckelii (Fig. 194).—The hermaphrodite duct, which rises from the gland, forms a long ampulla or widening, and then divides into a male and a female duct. The vas deferens runs in coils to the penis sheath, which it enters, coiling up in it almost like a watch-spring, and then forms the evaginable widened end portion which is called the penis, and which can be invaginated by a retractor muscle. The oviduct has a shorter course, and receives the short efferent duct of a globular receptaculum seminis. The widened terminal portion of the oviduct (the vagina), which enters the genital cloaca with the penis, receives the ducts of the albuminous and nidamental glands (shell and slime glands); the second of these may be regarded as the homologue of the digitate gland of *Helix*.

There is a general agreement between the ducts of the *Nudibranchia* and those just described; in details, however, extraordinary variety prevails. The male and

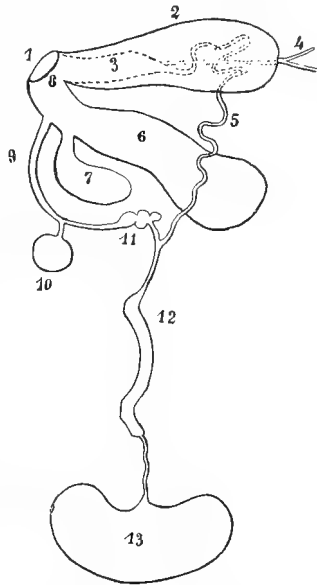

FIG. 194.—Genital organs of *Pleurobranchæa Meckelii* (after Mazzarelli). 1, Common genital aperture; 2, penis sheath; 3, penis; 4, retractor muscle of the same; 5, vas deferens; 6, nidamental gland; 7, albuminous gland; 8, genital cloaca; 9, oviduct; 10, receptaculum seminis; 11, widening and caecal appendage of the oviduct; 12, hermaphrodite duct; 13, hermaphrodite gland.

female ducts nearly always unite in the base of a genital cloaca, which often lies anteriorly on the right, on a papilla. The male and female apertures are rarely separate; when they are so, they lie close together (cf. Fig. 195 of *Phyllirhoë*). The penis is often armed in various ways.

The important subject of the mutual relations of the three types of genital ducts in hermaphrodite Gastropoda has been much discussed, but no satisfactory conclusion has been reached. Ontogenetic research has been appealed to so far in vain.

It is thus not at present known whether the single hermaphrodite duct has arisen by the fusing of separate male and female ducts, or whether the separate ducts have come into existence by the splitting of an originally single hermaphrodite duct. The difficulty is increased by the fact that the genetic significance of the hermaphrodite gland is uncertain.



FIG. 195.—Genital organs of *Phyllirhoë* (after Souleyet). 1, Vas deferens; 2, penis; 3, oviduct; 4, male, 5, female genital aperture; 6, vagina; 7, hermaphrodite gland; 8, hermaphrodite duct; 9, receptaculum seminis.

Fertilisation is mutual in hermaphrodite Gastropods. It is, however, certain that, in the *Pulmonata* at least, when copulation does not take place, self-fertilisation can occur. The hermaphrodite duct not infrequently carries one or two lateral cæca or vesiculæ seminales, in which an animal can store up its own sperm to be used in fertilising its own eggs if cross-fertilisation does not take place. The eggs and the sperm are often not ripe at the same time.

(2) **Cephalopoda.**—Although the gonad in all extant Cephalopoda is unpaired, the ducts are originally paired in both sexes. In *Nautilus*, the *Oegopsidæ*, and the *Octopoda*, there is one pair of ducts in the female; but in the males a paired seminal duct occurs only in *Nautilus* and *Philonexis carene* (*Tremoctopus*).

In *Nautilus*, in which both sexes possess paired ducts, the left duct is in both cases rudimentary and no longer functions. It is the so-called pear-shaped vesicle, which is attached on one side to the heart and the lower end of the gonad, and on the other opens into the mantle cavity at the base of the lower gills.

Where only one duct is retained, it is, in both sexes, the one on the left, as in *Loligo*, *Sepia*, *Sepioteuthis*, *Rossia*, *Sepioteuthis*, *Chiroteuthis*, *Cirrhoteuthis*, etc.

The genital ducts rise on the wall of that part of the secondary body cavity which is known as the genital cavity (peritoneal sac, genital capsule), and open into the mantle cavity at the sides of the anus, between the nephridial aperture and the base of the gills.

Male ducts, seminal duct.—In the more complicated form of male duct, such as that of *Sepia* (Fig. 196), four principal divisions may be distinguished. From the testicular capsule rises a vas deferens, which runs along in close coils, and then widens into a vesicula seminalis, the highly developed and much folded epithelium of which plays an important part in the formation of the spermatophores. The vesicula seminalis is continued as a thin vas deferens to the last division, the **spermatophoral pouch** (Needham's pouch), which serves as a reservoir for the

spermatophores. This pouch is flask-shaped and projects freely, with the end which corresponds to the neck of the flask, at which the male genital aperture lies, into the mantle cavity. The vas efferens receives (1) the short duct of an oviform gland, the *prostata*, and (2) a simple, lateral, non-glandular *cæcum*. The *prostata* takes part, like the *vesicula seminalis*, in the formation of the spermatophores. The *prostata*, *cæcum*, and *vesicula seminalis*, in their natural position, form a coil,

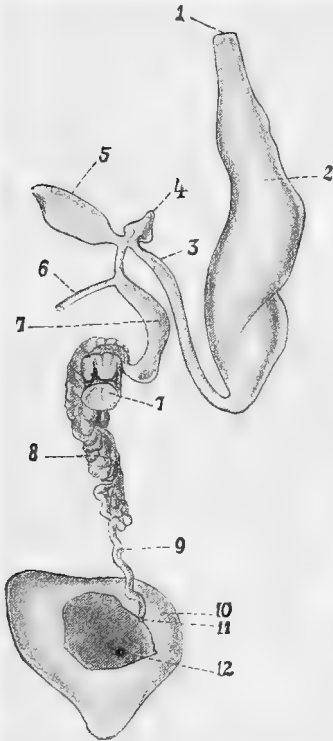

FIG. 196.

FIG. 196.—Male genital organs of *Sepia officinalis*. 1, Genital aperture; 2, spermatophoral pouch; 3, vas efferens; 4, *cæcum*; 5, *prostata*; 6, canalicule, opening into that part of the body cavity which surrounds the male duct; 7, *vesicula seminalis*; 8, 9, vas deferens; 10, gonad, a portion of the posterior wall is removed, the genital cavity is revealed, and on its anterior wall is seen the aperture of the male germinal body (12); 11, aperture of the seminal duct into the genital cavity.

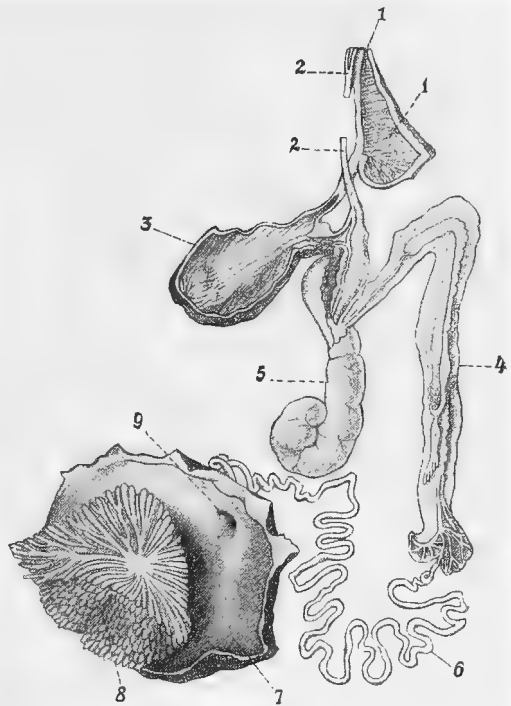

FIG. 197.

FIG. 197.—Male genital organs of *Octopus vulgaris* (after Cuvier). 1, Penis; 2, muscle, cut through; 3, spermatophoral pouch; 4, *vesicula seminalis*; 5, *prostata*; 6, vas deferens; 7, opened genital cavity, on whose anterior wall the testicular canals of the germinal body (8) are seen; 9, aperture of the seminal duct into the genital sac.

which lies in a special division of the secondary body cavity, the peritoneal sac. It is remarkable that the vas deferens is in open communication with this peritoneal sac by means of a narrow tube.

The male efferent apparatus of *Octopus* (Fig. 197), as compared with that of *Sepia*, is distinguished chiefly by the absence of a separate vas efferens. The long

vesicula seminalis opens into the large prostata near the point where the latter enters the spermatophoral pouch. This point lies, not in the base, but in the neck of the pouch, where the latter is produced into the long fleshy penis, the point of which projects into the mantle cavity. The penis is provided with a lateral cæcum.

It has already been mentioned that, as far as we know at present, only two living

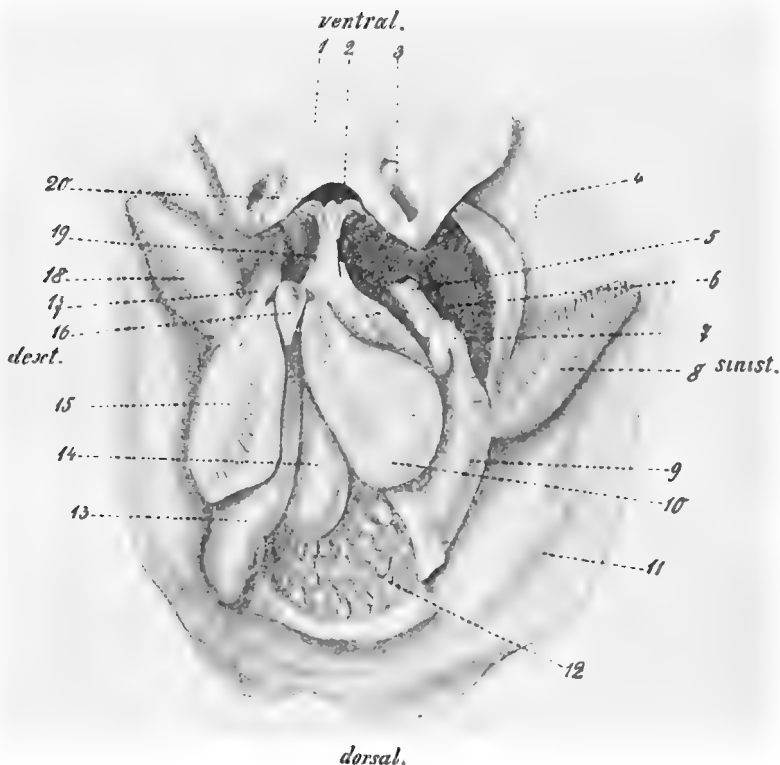

FIG. 198.—Female genital organs of *Sepia officinalis* (chiefly after Brock). The mantle cavity is opened, the posterior integument of the visceral dome removed, the ink-bag laid somewhat to one side, and the oviduct uncovered. The complex of organs thus exposed is seen from behind. 1, Funnel; 2, edge of the aperture of the funnel; 3, cartilaginous locking apparatus; 4, left ganglion stellare; 5, glandular terminal portion of the oviduct with the female genital aperture; 6, left lateral lobe of the accessory nidamental gland; 7, gland of the oviduct; 8, left gill; 9, oviduct filled with eggs which are seen through its wall; 10, left nidamental gland; 11, mantle; 12, stalked ovarian sac, opened from behind, the stalked ovarian eggs are seen on its anterior wall; 13, ink-bag (pigment gland); 14, stomach; 15, right nidamental gland; 16, central portion of the accessory nidamental gland; 17, right lateral lobe of the same; 18, right gill; 19, right renal aperture; 20, anus.

Cephalopods, *Nautilus* and *Philonexis carena*, have paired male ducts. In *Nautilus*, the left duct is rudimentary. Whether the two ducts of *Philonexis carena* correspond with the two ducts which we may assume that the Cephalopoda originally possessed is very doubtful. The two vasa deferentia of *Philonexis*, which arise out of the testicular capsule, and differ considerably in structure, unite together later, and

both lie on the left side. It is also remarkable that the spermatophoral pouch has two apertures, and that there are thus two genital apertures.

Female genital organs—Sepia (Fig. 198).—The complicated female efferent apparatus consists of two entirely distinct parts, opening separately into the mantle cavity: (1) an unpaired oviduct (to the left), the position and aperture of which correspond with those of the seminal duct in the male; and (2) the **nidamental glands**. The two large nidamental glands are pear-shaped organs, lying just beneath the integument in the posterior part of the visceral dome, symmetrically, at the sides of and anterior to the descending efferent duct of the ink-bag. They open into the mantle cavity at their ventral ends. Each gland appears symmetrically divided by a series of glandular lamellæ, traversing it from side to side. The spaces between the lamellæ open into the central slit-like duct; this structure is to be seen even on the exterior of the gland. Besides these two nidamental glands there is an **accessory nidamental gland** lying below and in front of the former. It is of a brick-red colour, and consists of a central part and two lateral lobes. It consists of numerous coiled glandular canalicules, which open into a glandular area in the mantle cavity. This glandular area forms a depression between the central and lateral lobes. As the aperture of the large nidamental gland also lies in this depression, the secretions of the two glands here mingle.

The oviduct which rises from the ovarian sac is, during the reproductive season, so full of eggs, that it becomes much distended, especially at the part which opens into the ovarian sac. Before this duct opens outward into the mantle cavity at the same point and in a similar manner as the seminal duct in the male, it becomes connected by means of a freely projecting portion with a doubly-lobed or heart-shaped accessory gland, the **gland of the oviduct**, which repeats the structure of the nidamental gland. The terminal portion also (from the point of entrance of this gland to the aperture of the oviduct) is glandular, two symmetrical rows of perpendicular glandular leaflets projecting from its wall into its lumen.

The secretions of the nidamental glands, accessory nidamental glands, and the glands of the oviducts yield the outer envelopes of the ovarian eggs.

Nidamental glands occur, among the Cephalopoda, (1) in the *Tetrabranchia* (*Nautilus*); (2) in the *Dibranchia*, among the *Decapoda*, in the *Myopsidæ* (*Sepia*, *Sepioteuthis*, *Rossia*, *Loligo*, *Sepioteuthis*, etc.); in a few *Oegopsidæ* (*Omnastrephes*, *Onyctoteuthis*, *Thysanoteuthis*). They are wanting in the *Octopoda* and in some *Oegopsidæ* (*Enoploteuthis*, *Chiroteuthis*, *Owenia*).

Nautilus is distinguished from all other living Cephalopoda (1) by the possession of only one nidamental gland, and (2) by the fact that this gland does not lie in the visceral dome but in the mantle.

Accessory nidamental glands are found only in the *Myopsidæ*. The two glands are either separate (*Rossia*, *Loligo*, *Sepioteuthis*) or fused together (*Sepia*, *Sepioteuthis*).

Glands of the oviduct occur in all Cephalopoda, but vary in position and in structure.

Outgrowths of the oviduct, which function as receptacula seminis, occasionally occur (*Tremoctopus*, *Parasira*).

In all Cephalopoda, certain quantities of spermatozoa are collected in extremely complicated envelopes, the **spermatophores**. The substance of these large filamentous spermatophores is yielded by the prostata and the vesicula seminalis, but the mechanism by which so complicated a case is produced is still unknown. When touched, or when they reach water, the spermatophores burst at definite points, and scatter their contents. At the reproductive season the spermatophoral pouch is entirely filled with spermatophores. In *Philonexis carenæ*, however, only one very long spermatophore is produced.

c. **The copulatory apparatus—Hectocotylation in the Cephalopoda.**—The copulatory apparatus of the *Gastropoda*, and the penis which projects into the mantle cavity in certain Cephalopoda have already been described.

One of the most remarkable and enigmatical phenomena in connection with the Cephalopoda is their hectocotylation. This consists in the transformation of one of the oral arms of the male into a copulatory organ and spermatophore-carrier. This arm is said to be hectocotylied; during copulation it becomes detached, and finds its way into the mantle cavity of the female.

Typical hectocotylation (Fig. 200) is found only in the Octopodan genera *Argonauta*, *Philonexis*, and *Tremoctopus*. In *Tremoctopus* and *Philonexis* (*Parasira*) the third arm on the right is the one transformed, in *Argonauta* the third on the left. The arm is at first enclosed in an outwardly pigmented sac (Fig. 200 A), when this bursts, the arm becomes free, and then its special form can be recognised (B). The folds which formed the sac bend back so as to form a new sac, which receives the spermatophores and is now inwardly pigmented. An aperture leads from this sac into a seminal vesicle inside the hectocotylied arm; this vesicle is continued into a long thin efferent duct, which runs the whole length of the arm and opens outwardly at its end. The end of the arm is transformed into a long filamentous penis, which at first is also enclosed in a special sac. When the penis is evaginated the sac remains as an appendage at its base.

The spermatophores then pass from the pigmented sac into the seminal vesicle, and are ejected through the efferent duct which opens at the tip of the penis.

It is probable that Cephalopods grasp one another, during copulation, with their arms, in such a way that their mouths face each other. In this position the hectocotylied arm of the male becomes detached, and in some way or other forces its way into the mantle cavity of the female. Detached arms are often found in the mantle cavity of the female, as many as four have been found at one time.

We still do not know (1) how the hectocotylied arm fertilises the eggs of the female, or (2) how the spermatophores reach the hectocotylied arm.

The males and females in the above-mentioned genera differ from one another, apart from the sexual dimorphism caused by the development of the hectocotylied arm. The males are much smaller, and in *Argonauta* the female only has a shell.

It is very probable that the detached hectocotylied arm can be replaced by a new one.

Although a true hectocotylied arm, which can be detached, is only developed in the three genera above mentioned, it has been proved that in all other Cephalopoda (even *Nautilus*, cf. p. 117), a certain arm or portion of the head in the male is in some way modified, differing in some (often unimportant) manner from the other arms. Such an arm is said to be hectocotylied, and it is assumed that it plays some part in copulation, although its exact function is unknown. In *Sepia* and *Nautilus* it is even difficult to imagine what part it can take in copulation. The constant occurrence of a hectocotylied arm is the more remarkable as it is by no means always the



FIG. 199.—Spermatophore of *Sepia* (after Milne Edwards). *u*, Outer case; *b*, inner case; *c*, spermatozoal sac; *d*, *e*, *f*, *g*, various parts of the ejaculatory apparatus.

same arm that is thus transformed. In the *Octopoda*, as a rule, it is the third on the right side, but in the Octopodan subgenus *Scæurgus* and in *Argonauta*

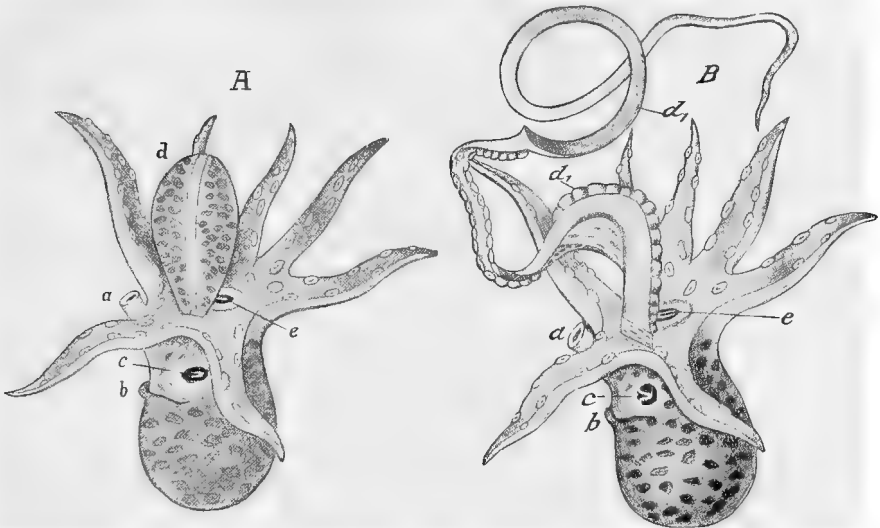
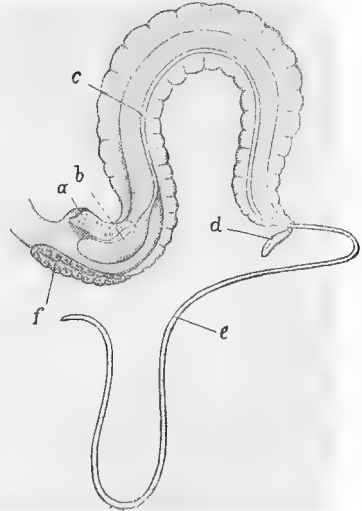

FIG. 200.—Male of *Argonauta argo* (after H. Müller). (Female, Figs. 35, 36, pp. 24, 25.) A, With the hectocotylied arm enclosed in the sac (*d*). B, with the arm free. *a*, Funnel; *b*, edge of the mantle fold; *c*, left eye; *d*, sac; *d*₁, hectocotylied arm; *e*, mouth.

it is the third on the left. In the *Decapoda* the hectocotylied arm is generally the fourth on the left, but in the genus *Enoploteuthis* it may be the fourth on

FIG. 201.—Hectocotylus of *Philonexis (Octopus) carenæ* (after Leuckart). *a*, Spermatophoral pouch; *b*, seminal vesicle; *c*, efferent duct of the same; *d*, appendage = remains of the penis sac; *e*, penis; *f*, sucker.



the right, or even in one and the same species of *Ommastrephes*, it is sometimes the fourth on the left and sometimes the fourth on the right. In *Sepiola* and

Rossia, it is the first arm which is hectocotylished. Finally, both the arms of one pair may be thus transformed; in *Idiosepiion* and *Spirula* this is the case with the fourth pair, in *Rossia* with the first.

The difference in size between the male and the female, which has been mentioned as occurring in those forms which have true hectocotylished arms, is also found, though not to the same degree, in many other Cephalopoda, in which the male is slightly smaller than the female.

XXI. Parasitic Gastropoda.

1. *Thyca ectoconcha* (Fig. 202) is a Prosobranchiate Gastropod which is parasitic on the Star-fish *Linckia multiformis*. The chief points in its organisation are shown in Fig. 202, a longitudinal section in which, however, several organs which lie laterally to the section are also represented. The organisation of the Gastropod is as yet little influenced by its parasitic manner of life. It possesses a shell, shaped

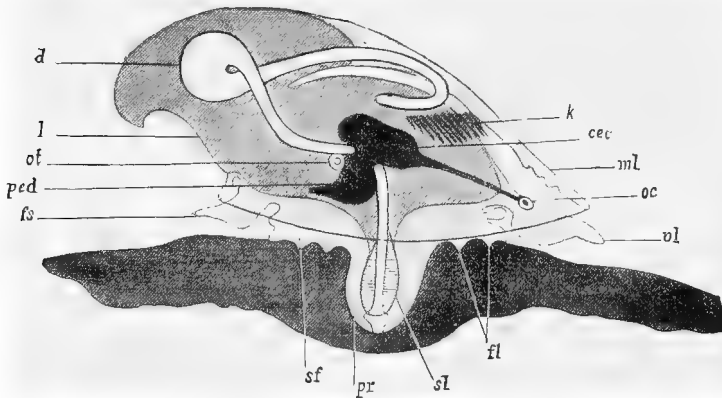

FIG. 202.—Longitudinal section through *Thyca ectoconcha* (after P. and F. Sarasin). Some organs not actually belonging to the section are included. *cec*, Cerebral ganglion; *d*, alimentary canal; *fl*, folds; *fs*, foot; *k*, gill; *l*, liver; *ml*, mantle; *oc*, eye; *ot*, otocyst; *ped*, pedal ganglion; *pr*, proboscis; *sf*, false foot; *st*, œsophageal bulb; *vl*, cephalic fold.

somewhat like a Phrygian cap. In the mantle cavity lies the gill. The alimentary and nervous systems also are in no way remarkable. It has eyes and auditory organs, and a short powerful snout, and muscular œsophageal bulb, which penetrates the Star-fish between the calcareous parts of its integument into the tissues. There is no radula. The base of the snout is surrounded by a muscular disc consisting of an anterior and a posterior part. This disc, the so-called false foot, is the grasping organ by which the animal attaches itself to the integument of its host so firmly that it cannot be torn away without injury. The rudiment of a foot (*fs*) occurs without an operculum.

2. The Gastropodan organisation is somewhat more strongly modified in *Stilifer Linckiae* (Fig. 203), which is parasitic on the male *Linckia*. The whole body of this parasite penetrates into the calcareous layer of the integument of the host, on which it raises pathological globular swellings, and further causes the peritoneum to bulge inwards towards the body cavity. The parasite communicates

with the outer world only by means of a small aperture at the tip of the swelling. The parasite, thus established in the integument of its host, is surrounded on all sides by a fleshy envelope (*sm*). This envelope is only broken through by an aperture at the point where the apex of the dextrally twisted shell lies; this aperture corresponds in position with the aperture above mentioned as occurring at the tip of the pathological swelling. This envelope is called the false mantle, and corresponds morphologically with the false foot of *Thyca*, much increased in size and bent back on to the shell. There occur besides a true mantle, a gill, a rudimentary foot without an operculum, eyes, auditory organs, and a typical Prosobranchiate nervous system. The development of the remarkable false mantle

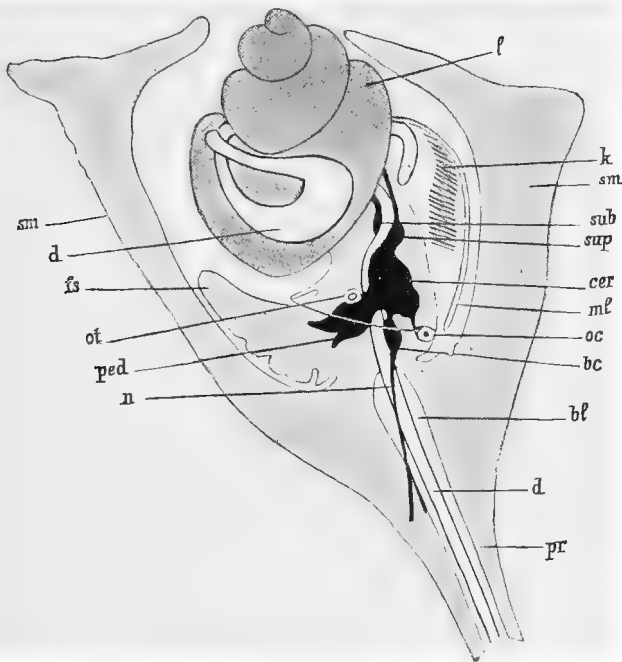

FIG. 203.—Longitudinal section through *Stilifer Linckia* (after P. and F. Sarasin). *bc*, Buccal ganglion; *bl*, blood sinus; *cer*, cerebral ganglion; *d*, alimentary canal; *fs*, foot; *k*, gill; *l*, liver; *ml*, mantle; *n*, proboscidal nerve; *oc*, eye; *ot*, otocyst; *ped*, pedal ganglion; *pr*, proboscis; *sm*, false mantle; *sub*, subintestinal ganglion; *sup*, supraintestinal ganglion.

no doubt signifies that, although the animal is embedded deep in the integument of the host, communication with the exterior is retained. Water for respiration can enter and flow out of the mantle cavity, and the faecal masses and genital products, and perhaps also the larvæ can pass into the cavity of the false mantle and be ejected through its aperture. The sexes are separate. The snout has lengthened into a very long proboscidal tube which pierces the tissues of the integument of the Star-fish, which are rich in blood, and draws from them the necessary nourishment. Both cesophageal bulb and radula are wanting.

3. The two parasites just described are typical Gastropods, and are easily recognised as such when carefully examined; there are, however, two other parasitic Gastropods in which the typical organisation is so much modified that it

would be difficult to recognise them as Gastropods, or even as Molluscs, were it not proved that the larvæ of one of these forms at least are distinctly Gastropodan larvæ. The incomplete state of our knowledge of the development of these two parasites, and the absence of any transition forms between them and the typical organisation, make them very difficult to understand.

Entocolax Ludwigi inhabits endoparasitically the body cavity of a *Holothurian* (*Myriotrechus Rinkii*), one end of its vermiform body being attached to the body wall of its host. Its organisation, a scheme of which is given in Fig. 205, can be best studied with the help of some hypothetical transition forms, through which a

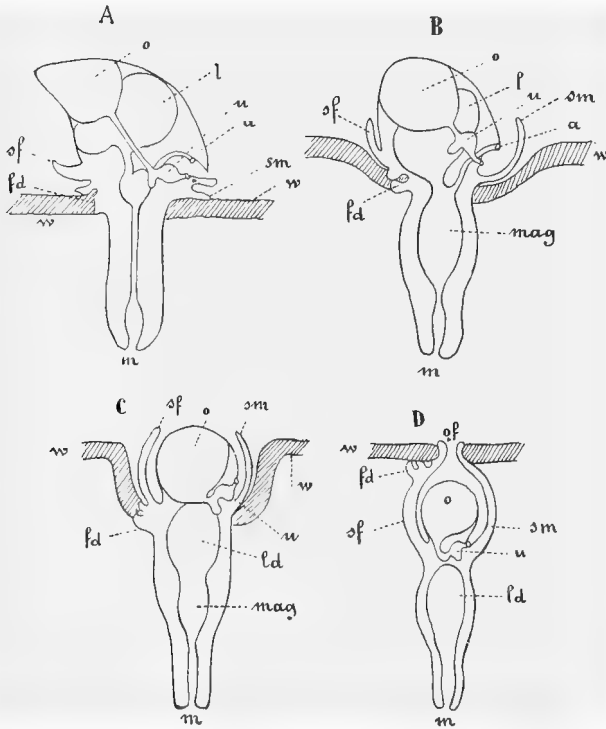

FIG. 204.—A, B, C, D, Hypothetical transition stages between *Thyca* and *Stilifer* on the one side and *Entocolax* (Fig. 205) on the other (after Schiemenz). *a*, Anus; *fd*, pedal gland; *l*, liver (digestive gland); *ld*, hepatic intestine; *m*, mouth; *mag*, stomach; *o*, ovary; *of*, aperture of the false mantle; *sf*, false foot; *sm*, false mantle; *u*, uterus; *w*, body wall of the host.

Gastropod of the type of *Thyca* or *Stilifer* might pass in developing into an endoparasitic parasite like *Entocolax*. Fig. 204 A shows the first stage, which still much resembles *Thyca*, and is still ectoparasitic; Fig. 204 B, C, D are further stages in development. In proportion as the animal becomes endoparasitic, and gives up its relations to the external world, do the sensory organs, the shell, and the mantle cavity with the gill disappear. The stomach, as a separate section of the intestine, degenerates, the digestive gland (liver) becomes a simple unbranched diverticulum of the intestine, which loses the rectum and anus. All organs for the purpose of mastication at the anterior end of the alimentary canal are lost. The

false mantle becomes larger and larger, and envelops the small visceral dome, which gradually becomes rudimentary, and finally contains merely the genital organs. At the stage D the whole animal already projects freely into the body cavity of the host, attached to its wall by a displaced portion of the false foot, and connected with the exterior only by the aperture of the false mantle. If this last means of communication with the exterior is also abandoned, *i.e.* if the whole false mantle with its aperture becomes enclosed in the body cavity of the host, we have a form corresponding with the endoparasite *Entocolax Ludwigii* (Fig. 205). In this form, the cavity enclosed by the false mantle, into which the ovary and its receptacula

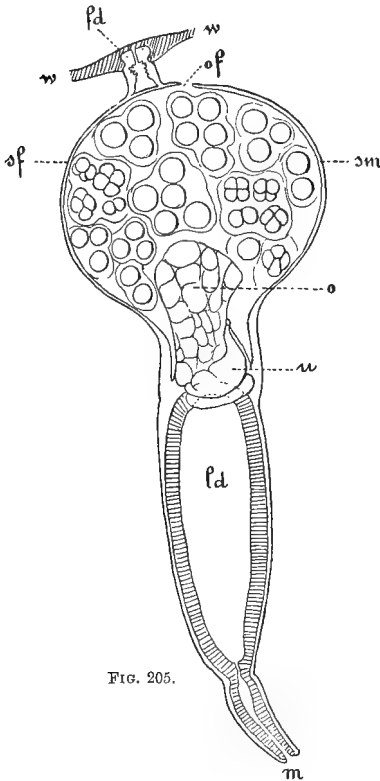

FIG. 205.

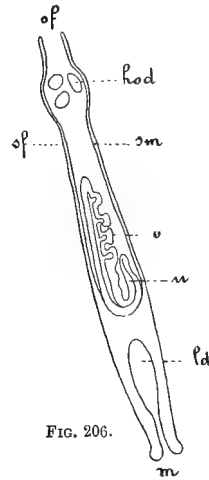

FIG. 206.

FIG. 205.—*Entocolax Ludwigii*, sketch after Voigt. Lettering the same as that in the preceding figure.

FIG. 206.—*Entoconcha mirabilis*, sketch by Schiemenz (after Baur). Lettering as in Fig. 204. *hod*, Testes?

seminis open, serves as a receptacle for the fertilised eggs, which were found in it in their first stage of segmentation in the one (female) specimen discovered.

Entoconcha mirabilis, an endoparasite which has been found in a *Holothurian*, *Synapta digitata*, is even more deformed than *Entocolax*. The body of this parasite is a long vermiform coiled tube, attached by one end to the intestine of the host, while the rest of the tube floats freely in the body cavity of the latter. Its organisation has as yet been imperfectly investigated. Fig. 206 is a very simple diagram, which is introduced for comparison with Fig. 205 of *Entocolax*. It is impossible to say how far such a comparison, which the lettering is intended to facilitate, is justifiable. Up to the present time, no aperture leading from the ovary into the brood-chamber, which is thought to be the cavity of the false mantle, and is

filled with embryos (not represented in the figure), has been observed. In a widening of the tube near its attached end, a number of free "testicular vesicles" have been found, but their real significance can only be discovered by further research.

The embryos found in the brood cavity of *Entoconcha* have the same general structure as Gastropodan larvæ. They have a spirally twisted shell, into which the body can be withdrawn; an operculum, a small velum, the rudiments of two tentacles, two auditory vesicles, a foot, and an intestine, which, according to one observer (the most recent), consists of only a mouth, pharynx, œsophagus, and the rudiment of a liver, but according to an older authority is complete. There is, further, a branchial cavity with a transverse row of long cilia. Nothing further is known of the development and life history of *Entoconcha*.

Some details of parasitic Lamellibranchiate larvæ (*Unionidæ*) will be given in the section on Ontogeny.

XXII. Attached Gastropoda.

Of the several forms of attached Gastropods known, only *Vermetus*, whose inner organisation has been carefully investigated, can be shortly described in this place. *Vermetus* has a shell which, instead of being coiled like the well-known shell of the snail, is a calcareous tube, which rises freely from the bottom of the sea, to which its tip is cemented. This shell is very like the calcareous tubes of tubicolous worms such as *Serpula*. The larva of this form, however, possesses a typically coiled shell, and even the young animal, after it has attached itself, has such a shell. In the course of growth, however, the coils become loosened, and the shell finally grows out as a tube.

The typical organisation of the *Monotocardian Prosobranchiates*, to which *Vermetus* belongs, is little affected by the attached manner of life. The visceral dome, like the shell, is much elongated and almost vermiform. The intestine, the circulatory system, the kidneys, the mantle, the gill, and the nervous system are typically developed. The sexes are separate, and copulatory organs, which could not be used by attached animals, are wanting. The head is well developed, and the pharynx well armed. When the animal is slightly irritated, it is said not to withdraw at once into its shell, like other Gastropods, but to bite. The foot has the form of a truncated cylinder, and is directed anteriorly, ventrally to the head. It cannot, of course, function as a locomotory organ, but carries the operculum for closing the shell, and, by means of the pedal gland, secretes mucus. *Vermetus* is said to produce great quantities of this secretion, which it allows to float in the water for a time like a veil, and then swallows together with all that has become attached to it. In this way it fishes for the small organisms which form its food.

XXIII. Ontogeny.

A. Amphineura.

1. **Ontogeny of *Chiton Polii*** (Fig. 207). The egg possesses little nutritive yolk. The segmentation is total and somewhat unequal; a cecogastrula is formed by invagination.

(a) The blastopore of the gastrula larva marks its posterior end. A pair of endoderm cells near the dorsal edge of the blastopore are specially large. A longitudinal section shows two dorsal and two ventral ectodermal cells with larger

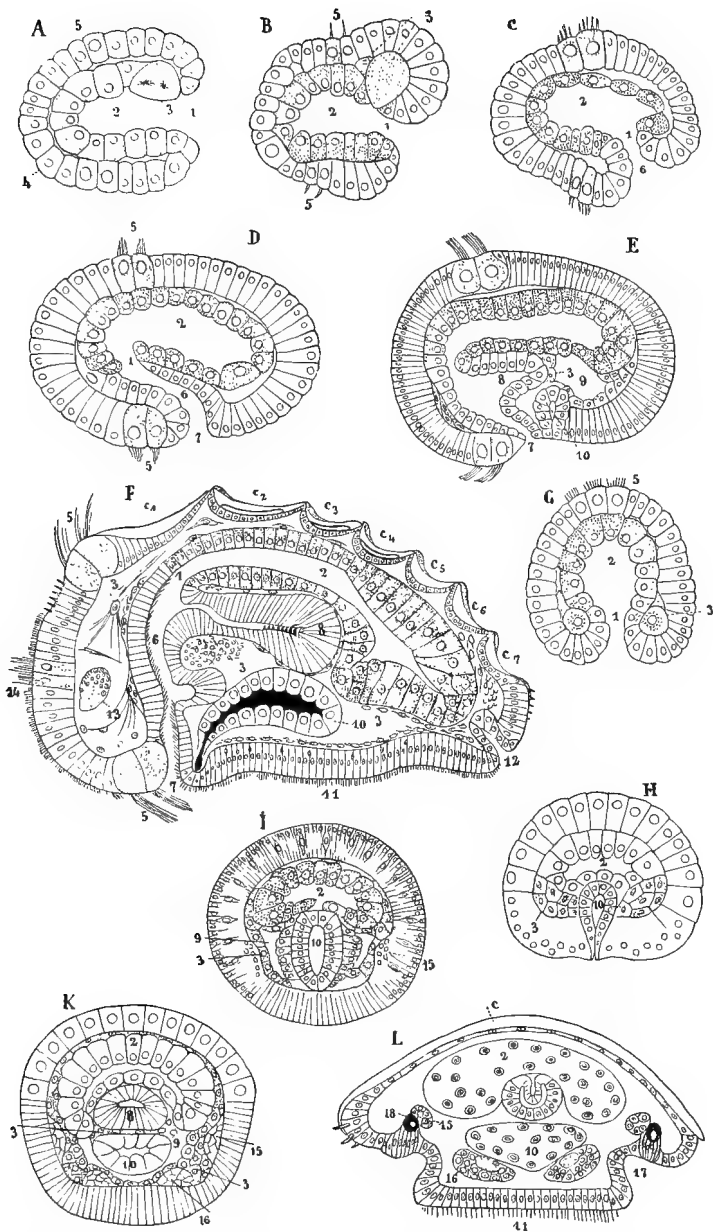

FIG. 207.—Development of *Chiton Polii* (after Kowalevsky). A-F, Six stages in the development of the gastrula into the young *Chiton*; sections nearly median. G, frontal section through stage C, oblique, from the upper part of the velum to the blastopore. H, I, K, L, transverse sections of four stages of development behind the mouth. 1, Blastopore; 2, archenteron or midgut; 3, mesoderm; 4, ectoderm; 5, velum or preoral ciliated ring; 6, stomodæum or œsophagus; 7, mouth; 8, radular sac; 9, body cavity; 10, pedal gland, in I œsophagus; 11, foot; 12, anus with proctodæum; 13, cerebral ganglion; 14, pretracheal tuft; 15, pleurovisceral cords; 16, pedal cords; 17, mantle furrow; 18, eye; c, shell; c₁-c₇, the seven shell plates first formed.

nuclei; these belong to a double row of cells on which is developed the **preoral ciliated ring** which, in Molluscs, is called the **velum** (Fig. 207 A).

(b) At a later stage, the blastopore appears shifted somewhat towards the ventral side, and an inward growth of ectodermal cells begins at its edge; this is the commencement of the formation of the ectodermal **stomodæum**. At the posterior and upper edge of the blastopore, there is, in the figure, a cell lying between the endoderm and the ectoderm; this is, no doubt, a **mesodermal cell** (B).

(c) The larva elongates; a distinct stomodæum (embryonic œsophagus), leading through the blastopore into the archenteron, is formed by the continuous growth inward of the ectodermal cells; this organ becomes shifted still further forward along the ventral surface (C).

(d) Fig. 207 G is an oblique section from an anterior upper to a posterior lower point through a slightly older larva, which shows the stomodæum, and, at the sides of the blastopore, the **first mesoderm cells**. These are probably derived from the endoderm, and are symmetrically placed at the two sides of the blastopore.

(e) A median section through the next stage (D) shows no mesoderm cells as yet in the median plane. The mouth, however, appears shifted forward along the ventral side as far as the ciliated ring or velum, the double row of cells in the latter being very clear.

(f) Transverse section of an older stage (H). The mesoderm cells have increased in number, and are arranged in two groups at the sides of the stomodæum, between the ectoderm and the endoderm.

(g) At a later stage, a longitudinal section of which is given in Fig. 207 E, the principal feature is a stronger development of the mesoderm, in which a space, the **body cavity**, now appears. A bulging backward of the stomodæum forms the first rudiment of the **radular sac**. Behind the mouth, a sac-like depression is formed, evidently by the ectoderm; this has been called the **pedal gland**, although it has not yet been discovered what becomes of it in the adult animal.

(h) When the body cavity forms, the cells of the mesoderm become divided into two layers, the inner **visceral layer** becoming applied to the intestine, and the outer **parietal layer** to the ectoderm (*cf.* Fig. 207 I). In the transverse section, we see, deep down in the ectoderm, the first rudiments of the **pleurovisceral cords**. The **pedal cords** arise in the same way, and anteriorly, in the cephalic area, which is encircled by the preoral ciliated ring, the rudiments of the **supra-œsophageal central nervous system** form as a neural plate, *i.e.* as a thickening of the ectoderm, which carries a tuft of long cilia.

(i) At later stages (F, K, L), the central nervous system with the pleurovisceral and pedal cords become detached from the ectoderm and take up their mesodermal position. The rudiments of seven shell-plates appear on the back as cuticular formations; the eighth only appears later. A posterior invagination of the ectoderm represents the rudiment of the proctodeum (the embryonic hind-gut with the anus). The first teeth appear in the radular sac. The whole of the cephalic area and the region of the foot become covered with cilia. On the dorsal ectoderm, on the parts that are not covered by the shell-plates, the first calcareous spines appear. In the posterior part of the body, a great accumulation of mesodermal elements evidently marks the position of a formative mesodermal zone.

At this stage, the larva leaves the egg envelope, and swims about freely, and, on the degeneration of the ciliated ring, sinks to the bottom transformed into a young *Chiton*. During this last transformation two lateral larval eyes appear on the anterior ventral side of the body. The development of the circulatory system, the nephridia, the genital organs and the ctenidia has not been followed.

2. **Solenogastres**.—The ontogeny of this order is as yet only known through a very incomplete account of the development of *Dondersia banyulensis*. The

segmentation is unequal and total, and takes place through the formation of micromeres. The process of gastrulation seems to occur in a manner half way between epibole and invagination. The blastopore marks the posterior end of the larval body, which is divided by two circular furrows into three consecutive regions. The anterior region consists of two circles of cells, and evidently corresponds with the pretracheal area. It is partially ciliated, and carries in the middle a group of longer cilia, one of which is sometimes to be distinguished from the rest as a flagellum. The second region, which consists of a single row of cells, carries a circle of long cilia, and evidently represents the velum. The third region consists of two rows of cells carrying short cilia; the second row edges the blastopore. At an older stage, the posterior part of the larva appears to be withdrawn into an invagination of the anterior part. The whole or by far the greater part of the body of *Dondersia* is said to be produced from this posterior part (the "embryonic cone") alone. On this embryonic cone, there appear, first of all, on the two sides of the middle line, three pairs of consecutive imbricated spiculæ, still retained in their formative cells.

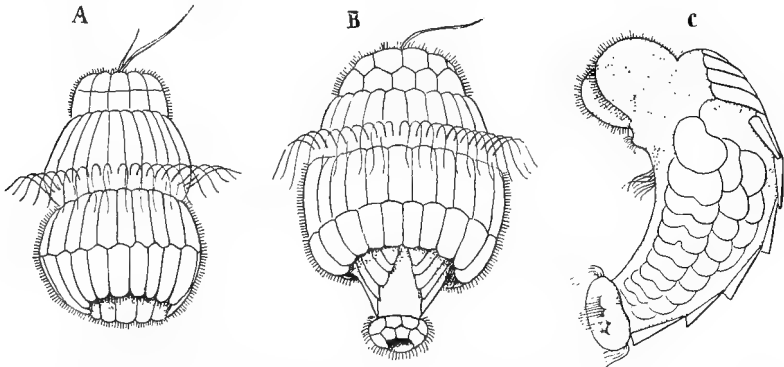

Fig. 208.—*Dondersia banyulensis*. A, Larva 36 hours old. B, Larva 100 hours old. C, Young *Dondersia* immediately after transformation (7th day), after Pruvot.

They soon break through these cells, and their number is increased by the appearance of new ones anteriorly. The embryonic cone lengthens, becomes curved ventrally. The anterior part of the body with the velum and the pretracheal area becomes reduced and finally appears as a sort of collar at the anterior end of the body. The larva sinks to the bottom, and throws off the whole anterior part of the body with the velum and the pretracheal area. Such throwing off or resorption of parts of the body which have been of great physiological importance in the larva is very common in the animal kingdom; see sections on the ontogeny of the Worms (e.g. *Nemertina*, *Phoronis*, etc., vol. i. p. 272), of the *Arthropoda* (Metamorphosis of Insects, vol. i. p. 490), and of the *Echinodermata*.

On the dorsal region of the young *Dondersia*, seven consecutive, imbricated, but only slightly overlapping, calcareous plates can now be distinguished, consisting of rectangular rods lying close alongside of one another (Fig. 208, C). This fact is very significant with regard to the shell of the *Chiton*, which in the adult consists of eight, but in the larva of only seven plates. If it could be proved that the *Solenogastridae* pass through a *Chiton* stage, the view that they are more specialised animals than the *Polyplacophora*, and are to be derived from *Chiton*-like forms, would receive almost decisive support.

Besides the seven dorsal calcareous plates, the young *Dondersia* has numerous

circular calcareous spicules, covering it laterally; the ventral side is, however, naked. A mouth is still wanting, the endodermal mass is not yet hollow, and on each side, between the endoderm and the integument, there is a solid mesodermal streak.

B. Gastropoda.

As a type of the development of the Gastropoda, we may take *Paludina vivipara* (Figs. 209 and 210), the ontogeny of which has recently been again very carefully investigated. Development here takes place within the body of the mother. The egg is comparatively poor in yolk. A **cœlogastrula** is formed by invagination, the **blastopore** of which marks the posterior end of the germ, and **becomes the anus**. No proctodæum is formed. The whole of the intestine from the stomach to the

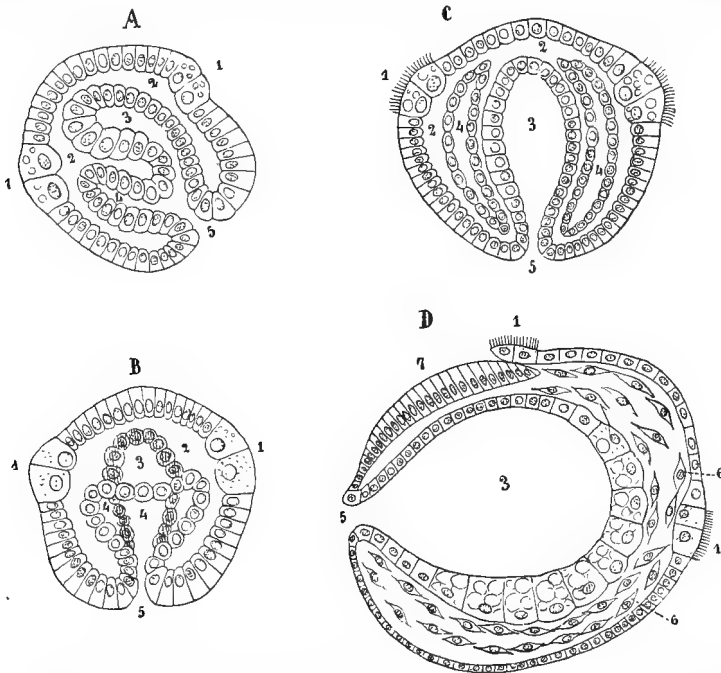

FIG. 209.—Development of *Paludina vivipara* (after v. Erlanger). **A** and **B**, Stage after gastrulation, with the rudiments of the mesoderm and the cœlom as outgrowths of the archenteron. **A**, Median optical longitudinal section. **B**, Horizontal optical longitudinal section. **C**, Horizontal optical longitudinal section through the embryo, after the entire separation of the cœlom sac from the intestine. **D**, Sagittal optical longitudinal section through an embryo, in which the mesoderm has broken up, the cells becoming spindle-shaped. 1, Velum; 2, segmentation cavity; 3, archenteron; 4, cœlom; 5, blastopore; 6, mesoderm cells; 7, shell-land.

anus proceeds from the endoderm. The mesoderm arises as a ventral hollow outgrowth of the archenteron, which soon becomes constricted from the intestine, and lies between the intestine and the ectoderm in the segmentation cavity as a vesicle with two points directed forward (Fig. 209 A, B, C). This vesicle spreads out to the right and left dorsally round the intestine, finally closing round it dorsally. Its outer wall of cells, which becomes applied to the ectoderm, forms the **parietal**

layer, while its inner wall, which is applied to the intestine, forms the **visceral layer** of the mesoderm. The cells of the mesoderm soon become detached from one another (Fig. 209, D); they assume the spindle shape and finally fill the segmentation cavity like a network.

In the meantime the **velum** has appeared, and, between it and the anus, the **shell-gland** forms. The œsophagus arises as an invagination of the ectoderm, which soon becomes connected with the midgut. By the addition of a paired **primitive kidney**, the typical **Molluscan Trocophora** is formed; this at first is quite symmetrical, the anus lying posteriorly in the middle line.

After the development of the œsophagus, a mass of mesoderm cells collects on each side of and below the intestine, this mass soon becoming hollow. In this way two mesodermal sacs are formed which approximate towards the middle line till they touch, and then fuse to form one sac, the double origin of which is still, for a time, evidenced by the presence of a median septum. The sac which thus arises is the **pericardium**. Fig. 210 A shows a somewhat further developed embryo seen from the right side. Below and behind the mouth are seen the projecting **rudiment of the foot**, on which to the right and left the **auditory vesicles** have arisen as invaginations of the ectoderm. In the pretracheal area, protuberances to right and left represent the rudiments of the **tentacles**, at the bases of which the **eyes** have appeared as ectodermal pits. The shell gland has secreted a **shell**. The greater growth of that side of the body which is covered by the shell has caused a bending by which the anus is shifted towards the ventral side. Immediately behind the anus, the ectoderm bulges out to form the rudiment of the mantle fold, so that the anus comes to lie in a shallow depression, the rudiment of the **pallial or respiratory cavity**. It is important to note that at this outwardly symmetrical stage, the mantle cavity and the anus lie posteriorly. The fore-gut (œsophagus) has greatly lengthened. The **digestive gland** has grown out from the stomach ventrally in the form of a wide sac, but is still connected with the latter by a wide aperture. The **pericardium**, in which the septum is still visible, has already somewhat shifted from below the stomach to its right side. The rudiments of the definite nephridia next form in the following way (Fig. 210, D). In each division of the pericardium (the left division being smaller than the right) the wall bulges out; the right outgrowth becomes the **secreting portion of the permanent kidney**; the left degenerates, but must be regarded as a temporarily appearing **rudiment of the (original) left kidney**. The mantle cavity, which lies beneath the pericardium, presses into it to the right and left in the form of two projections. The right projection, continuing to grow, becomes connected with the rudiment of the right kidney and forms its **effluent duct**. The left projection does not grow further, nor does it become connected with the rudiment of the left kidney.

A further stage is depicted from the right side in Fig. 210 B. The following are the most important alterations. The optic pit has become constricted into an optic vesicle. The **mantle fold** has grown further forward, and has become **deeper to the right**. The undivided pericardium has shifted altogether to the right of the stomach, and lies above the rectum, which bends forward and downward. The body is already asymmetrical.

At the following stage (Fig. 210, C) the posterior and dorsal region of the body rises distinctly from the rest as a visceral dome; the shell covering this part of the body has increased considerably in size. The mantle fold has become much broader, and the mantle cavity much deeper; the latter now lies chiefly on the right side of the body. The looping of the intestine is far more marked. On the posterior and dorsal side of the pericardium, the pericardial wall sinks in the form of a channel, which soon closes and forms a tube; this is the **rudiment of the heart**. The two apertures of the tube, where the wall of the heart passes into that of the pericardium,

communicate with the body cavity. The heart tube becomes constricted in the middle, the anterior division forming the auricle and the beginning of the branchial vein, the posterior, the ventricle and the rudiment of the body aorta.

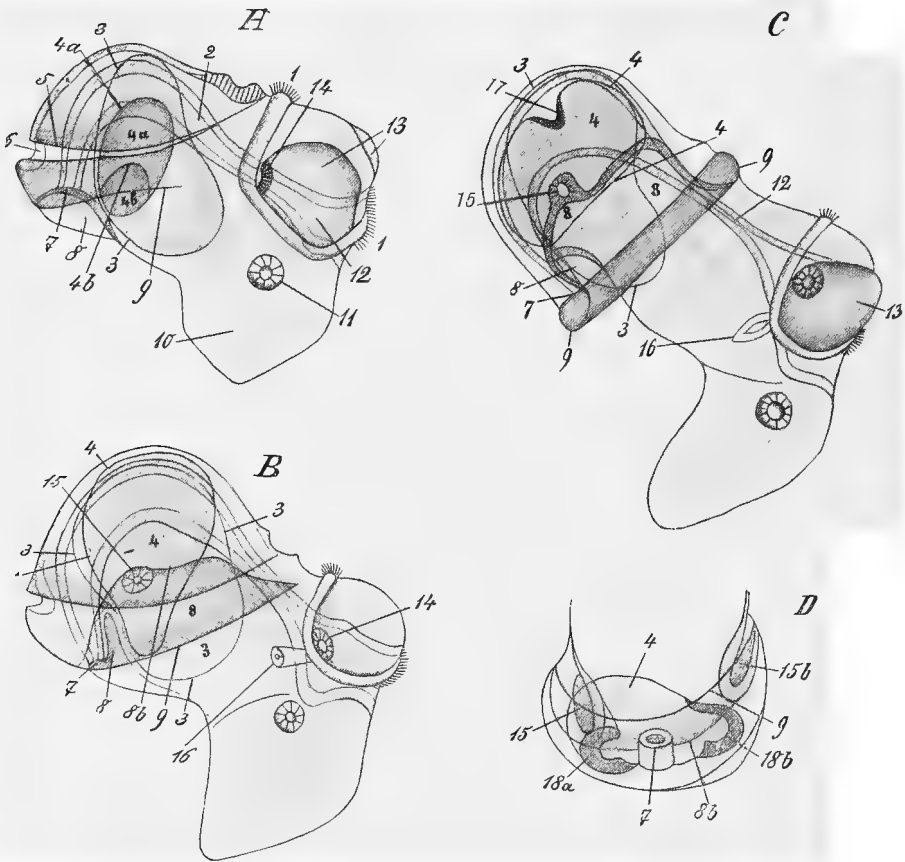

FIG. 210.—Development of *Paludina vivipara* (after v. Erlanger) **A**, Right aspect of an embryo, in which the pericardium is divided into two parts by a septum. **B**, The same of a somewhat older embryo, with an undivided pericardium. **C**, The same of an older embryo, in which the first rudiment of the heart has appeared. **D**, Ventral aspect of the posterior end of an embryo, in which the asymmetry of the visceral dome begins to appear. The anus is still median, but the mantle cavity is already deeper on the right (the left in the figure). 1, Velum; 2, mid-gut; 3, digestive gland (liver); 4, pericardium; 4a and 4b, divisions of the same formed by a septum; 5, free edge of the shell; 6, shell groove; 7, anus; 8, mantle cavity; 8b, base of the mantle cavity = base of the mantle fold; 9, free edge of the mantle; 10, foot; 11, auditory organ; 12, oesophagus; 13, cephalic tentacle; 14, eye; 15, efferent duct of the (originally) right nephridium; 15b, rudimentary efferent duct of the (originally) left nephridium; 16, primitive kidney; 17, rudiment of the heart; 18a, right nephridium; 18b, rudimentary left nephridium.

Fig. 211 A shows a somewhat older embryo which already resembles in form the adult animal. The velum is reduced, and a ventral bulging of the anterior division of the oesophagus represents the rudiment of the radular sac. The ventricle and

the **auricle** are distinct. An ectodermal depression on the foot forms the **operculum**. The mantle cavity which lies on the right side, and into which the rectum opens, now also stretches to the left on the anterior and dorsal side of the sharply demarcated visceral dome. The gill appears in the form of a protuberance on the

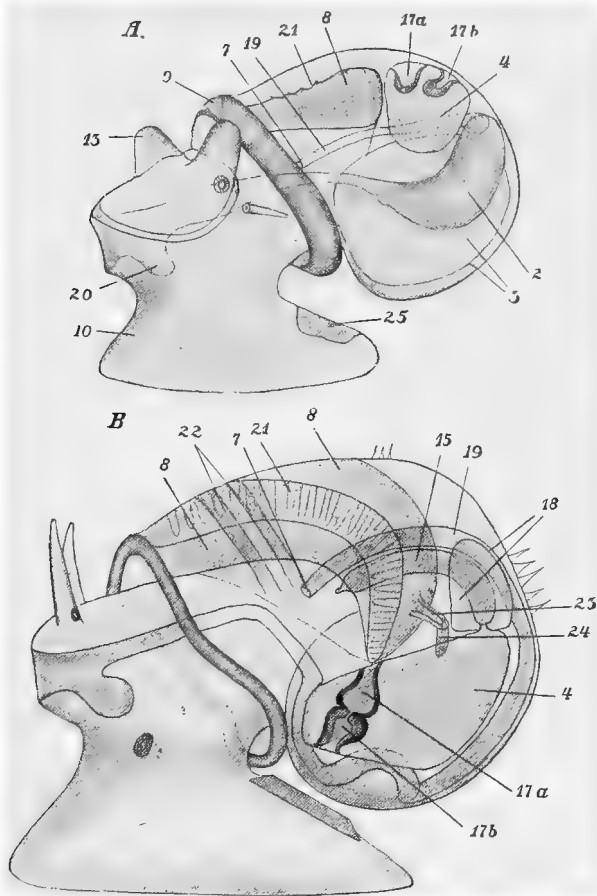

FIG. 211.—Development of *Paludina vivipara* (after v. Erlanger). **A**, An embryo in which the first rudiment of the gill has appeared. **B**, A nearly mature embryo. Both are seen from the left side. Lettering as in Fig. 210. In addition, 17a, Auricle; 17b, ventricle; 18, nephridium; 19, rectum; 20, rudiment of the radular sac; 21, rudiment of the gill; 22, osphradium (Spengel's organ); 23, rudiment of the genital duct; 24, rudiment of the gonad; 25, operculum.

inner surface of the mantle cavity, and the osphradium at the left of the gill as an ectodermal protuberance.

Fig. 211 B finally shows us an embryo in which the mantle cavity has assumed the anterior position on the visceral dome. The ctenidium and osphradium have developed further. The velum is very much reduced and can only be seen in sections. This stage is important on account of the appearance of the rudiment of the **genital organs**, which is identical in the two sexes. A depression of the (meso-

dermal) pericardial wall, which becomes separated from the pericardium, forms the rudiment of the gonad, while an ingrowth from the base of the mantle cavity runs towards this, and is the (ectodermal) rudiment of the genital duct. The latter arises on one side of the anus, just as the efferent duct of the permanent kidney rises on its other side; this ontogenetic fact confirms what was stated above (p. 219) that the genital duct of the *Monotocardia* corresponds with a part of the right (which originally, and in the young embryo, is the left) kidney of the *Diotocardia* (apparently wanting in the *Monotocardia*).

The vascular system arises very early in the form of spaces between the mesoderm and ectoderm or entoderm, round which the mesoderm cells grow, and which become secondarily connected with the heart.

All the ganglia of the nervous system, the cerebral, pleural, pedal, parietal, and visceral ganglia arise separately as ectodermal thickenings, which become constricted off from the ectoderm by delamination. They only secondarily become connected with one another through the growing out of the nerve fibres. The parietal ganglia arise to right and left in the middle region of the body, but soon become shifted by the displacement of the organs of the visceral dome, one above the intestine and the other below it. The rudiment of the visceral ganglion is said to appear dorsally to the hind-gut and to move later to its position beneath the same.

The observations on the development of *Paludina vivipara*, here briefly described, are in many ways of great importance, and confirm in the most unmistakable manner the results arrived at by comparative anatomy. The following are specially noteworthy.

1. The manner in which the pericardium originates favours the opinion that it is a secondary body cavity. It is important to note that the pericardium is at

first paired, being divided into two lateral halves by a septum, which afterwards disappears.

2. The fact that the gonad arises as an outgrowth of the pericardium, confirms the view arrived at by comparative anatomy, that the genital cavity also is a secondary body cavity.

3. The anus and the mantle cavity originally lie symmetrically at the posterior end of the body, but, through asymmetrical growth, come to lie first on the right side of the visceral dome, and finally on its anterior side.

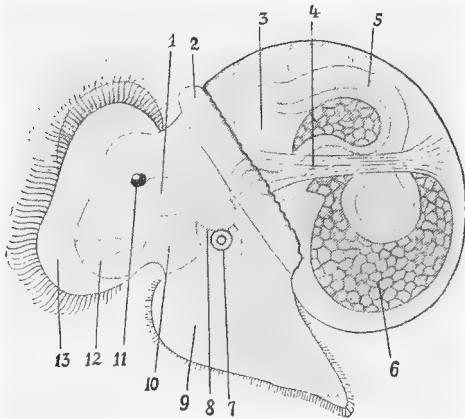

FIG. 212.—Larva of *Oncidium celticum*, from the left side (after Joyeux Laffaie). 1, Cerebral ganglion; 2, edge of the mantle; 3, rudiment of the gonad; 4, larval shell-muscle; 5, hind-gut; 6, rudiment of the digestive gland; 7, auditory organ; 8, pedal ganglion; 9, foot; 10, oesophagus; 11, eye; 12, branched muscle cells of the velum; 13, velum.

quantities than in the viviparous *Paludina*, in which the small provision of yolk is evidently connected with the favourable conditions of nutrition of the embryo.

The blastopore generally corresponds in position with the future mouth; it often,

The development of other Gastropods cannot here be described in detail. We refer the reader to the bibliography at the end. As a rule, nutritive yolk is present in larger

conditions of nutrition of the

perhaps usually, remains open; notwithstanding this, the œsophagus arises by the sinking in of ectoderm cells.

Paludina is, as far as is known, the only Mollusc in which the mesoderm originates as an outgrowth of the archenteron. This fact is no doubt connected with its poverty in nutritive yolk. In other Gastropods, the mesoderm arises in the manner already described for other Molluscs, as two large symmetrical primitive cells, at the posterior edge of the blastopore; these cells look more like endodermal than ectodermal cells, and soon pass into the segmentation cavity.

A **Veliger larva**, *i. e.* a Trochophora with Molluscan characteristics, always forms (1) a dorsal shell gland with the embryonic shell, and (2) a ventral rudiment of the foot.

The outward appearance of the Veliger larva, however, varies much in different groups, the variations being connected with the manner of life and of feeding of the embryo.

In the marine Gastropods, *i. e.* in the majority of the *Prosobranchia* (including the *Heteropoda*), the Pulmonate genus *Oncidium*, and all *Opisthobranchia*, the embryo leaves the egg envelope early, as a free-swimming Veliger larva. In all these forms, the preoral ciliated ring is well developed. The ectodermal floor of the ciliated ring usually bulges out anteriorly, so that the cilia appear to be carried by a distinct circular ridge. This ridge even grows out laterally to form a lobe of varying size, which carries at its edge long and strong cilia, and is occasionally itself produced into an upper and a lower lobe. This is the true velum of the free-swimming Gastropod larva, and is its only organ of locomotion. It is internally traversed from wall to wall by contractile mesoderm cells (muscle cells), which make it highly contractile. In the older larvæ, the head with the velum can be withdrawn into the shell.

It is probable that the velum of the larva also serves for respiration, and perhaps for bringing about a circulation of the body fluid by means of its contractility.

The embryos of fresh-water and terrestrial Gastropods, where these animals are not viviparous, remain longer in the egg, and leave it only after their transformation into young Gastropods, the larval organs (the velum, the primitive kidney, the cephalic vesicle, and the pedal vesicle or podocyst) having degenerated within the egg envelope. Even in these forms, the mass of nutritive yolk contained in the egg is not very great, but there is a large quantity of albumen stored up within the egg capsule, which serves as food for the developing embryo; this is either absorbed through the body wall or swallowed. The egg capsules are always large, in some cases (in tropical terrestrial Gastropods) as large as the egg of a small bird; but their size is not, as in the *Cephalopoda*, determined by that of the egg contained, but by the quantity of albumen in which the small egg is embedded. The mature egg capsule contains a young Gastropod of considerable size with a well-developed shell.

In terrestrial and fresh-water forms, the velum is not needed as a locomotory organ, and is therefore reduced to a single ring of cilia or to two lateral ciliated streaks. It is entirely wanting in the embryos of a few terrestrial *Gastropod* snails. The respiratory and circulatory functions, which were originally merely accessory functions of the velum, here become of greater importance. The nuchal region becomes much bulged forward, and forms a **cephalic vesicle** (Fig. 214), which is sometimes very large, and undergoes regular pulsations. The posterior division

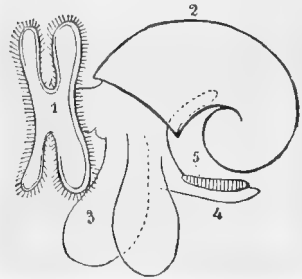

FIG. 213. — Larva of *Cymbulia* (Pteropod), from the left side (after Gegenbaur). 1, Velum; 2, shell; 3, parapodia (fins); 4, foot with operculum (5).

of the foot, in the same way, is often widened into a pulsating **pedal vesicle** or **podocyst**. Towards the end of larval life the cephalic and pedal vesicles and other similar "larval hearts" degenerate.

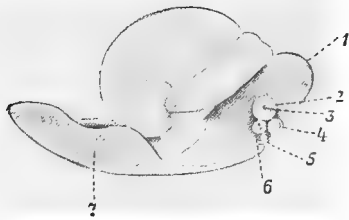

FIG. 214.—Embryo of *Helix Waltoni* (4 mm. long), from the right side (after P. and F. Sarasin). 1, Cephalic vesicle; 2, upper (optic) tentacle; 3, eye; 4, lower tentacle; 5, oral lobe; 6, sensory plate; 7, podocyst.

The embryonic shell is either retained throughout life or is thrown off at an early stage, and replaced by the rudiment of the definitive shell. Even a **second temporary shell** occasionally attains development.

It must again be noted that shell-less Gastropods, to whatever natural division they belong, pass through a typical Veliger stage, and at the older Veliger stage have a distinctly demarcated coiled visceral dome, with a corresponding shell, and usually an operculum on the metapodium.

In the larva of the gymnosomatous *Pteropoda* three postoral accessory ciliated rings are developed on the body.

C. Scaphopoda.

Ontogeny of Dentalium.—Segmentation, in these animals, leads to the formation of a cecloblastula, from which a cecloastrula arises by invagination. The blastopore at first lies posteriorly on the ventral side, but gradually shifts, as in *Chiton*, more and more forward along the ventral side. The stomodæum arises as an ingrowth of the ectoderm, the blastopore nevertheless remaining open. A typical Molluscan Trocophora is developed, although no primitive kidney has been found. The velum is a thick ridge round the body of the long oviform larva. This ridge consists of three rings of very large ectoderm cells, each row carrying a circle of long cilia. The shell gland spreads out at an early stage, its lateral edge soon growing out ventrally and posteriorly as the mantle fold. The free edges of the two folds fuse at a later stage below the body. The anus forms very late. The development of the cerebral and pedal ganglia and of the auditory organ has been specially carefully observed. On the ventral side of the pretracheal area, in front of the velum and behind the tuft of cilia, two symmetrical invaginations of the ectoderm form the cephalic sacs or tubes. These become constricted from the ectoderm at a later stage, their lumen gradually narrows and finally disappears, while their walls become thick and multilaminar by the continuous growth of the cells. The two cell masses which thus arise become connected in the middle line above and below the œsophagus, and form the cerebral ganglion. The otocysts arise at the base of the pedal rudiment on each side as ectodermal epithelial pits, which soon become detached from the ectoderm in the form of epithelial vesicles. Immediately beneath these auditory vesicles, certain ectoderm

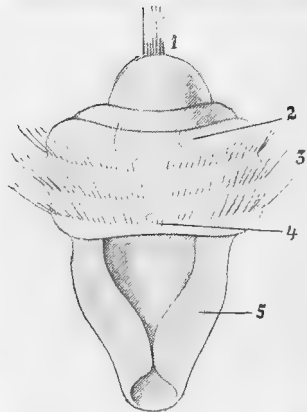

FIG. 215.—Larva of *Dentalium*, 37 hours old, posterior and lower aspect (after Kowalevsky). 1, Cephalic tuft; 2, rudiments of the cerebral ganglion (cephalic tubes); 3, velum, consisting of three rows of cilia; 4, mouth, hidden under the ridge of the velum; 5, mantle fold.

cells sink below the surface, and form on each side an ectodermal cell mass, which becomes detached from the rest of the ectoderm, sinks into the mesoderm of the foot, and fuses with the similar mass on the other side to form the pedal ganglion.

D. Lamellibranchia.

1. **Development of Tereido** (Figs. 216 and 217). Segmentation is here total and unequal. The gastrula, formed by epibole (Fig. 216 A, B) consists of (1) two large endoderm cells (macromeres), a thick cap of ectoderm cells (micromeres) closely covering these, and two symmetrical primitive mesoderm cells of medium size at the posterior edge of the blastopore. The blastopore closes from behind forward, the ectoderm cells by continual division growing entirely round the endoderm cells; during this process the two mesoderm cells become covered by the ectoderm and come to lie between the latter and the endoderm (Fig. 216 C). Somewhat anteriorly on the ventral side, a depression of the ectoderm forms a pit, the **stomodæum** (D). The ectoderm separates off from the two-celled mesoderm, thus giving rise to a segmentation cavity, or primary body cavity. A double **preoral ciliated band** is formed (D, E). The two large endoderm cells, by fission, produce other smaller cells. Cilia appear over the whole surface of the germ, with the exception of the posterior dorsal surface, where the ectoderm cells, which have become cylindrical, sink in to form the shell gland (F). The latter secretes the first rudiment of the shell in the form of a simple cuticular membrane. The endoderm cells begin to collect to form the intestinal wall. After the formation of the first rudiment of the shell, the shell gland flattens and spreads out; its edge can still be found as a ridge running under the edge of the shell. The endoderm now forms a large globular hollow mid-gut, into which the œsophagus breaks through. Each of the primitive mesoderm cells

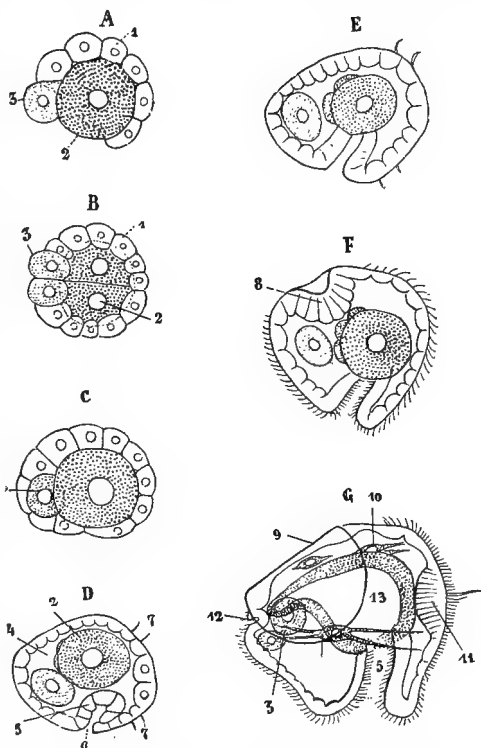

FIG. 216.—A-G, Stages in the development of *Tereido* (after Hatschek). A, C, D, E, F, G, from the right side, B in optical horizontal section. 1, Ectoderm; 2, macromeres=endoderm cells; 3, primitive mesoderm cells; 4, segmentation cavity; 5, stomodæum (œsophagus); 6, mouth; 7, preoral ciliated band; 8, shell gland; 9, shell; 10, larval muscle cells; 11, cephalic plate with tuft; 12, anal invagination, anus; 13, endodermal mid-gut.

has given rise to two or three smaller cells. The thin cuticular shell becomes bivalvular by the appearance of a mediodorsal boundary line.

A further stage is distinguished first by the appearance of a small posterior ectodermal invagination, the **proctodæum**, which produces the rectum and anus. An ectodermal thickening, the neural plate, appears in the pretracheal area, carrying three flagella. Some of the mesoderm cells become muscle cells (Fig. 216 G).

The next stage may be called that of the Trochophora larva. This larva differs from a typical Annelidan Trochophora only by possessing a shell, which now covers the greater part of the body, and by a mantle which appears, at first, posteriorly, and

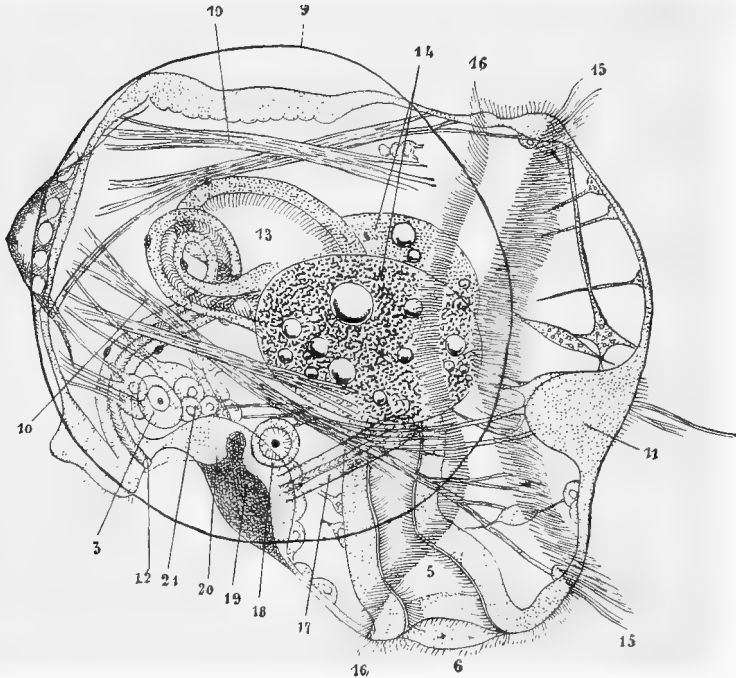

FIG. 217.—Older Larva of *Teredo*, from the right side (after Hatschek). Lettering as in Fig. 216. In addition, 14, rudiment of the digestive gland (liver); 15, preoral ciliated band (velum); 16, postoral ciliated band; 17, primitive kidney; 18, auditory vesicle; 19, rudiment of the pedal ganglion; 20, rudiment of the gill; 21, mesodermal streak.

then at the sides, as a fold, and continues to grow from behind forward. The region of the body which lies behind the cephalic area has spread out on each side to form a broad fold, which becomes outwardly applied to the shell. The neural plate has become multilaminar, and the proctodæum has broken through into the mid-gut. The primitive mesoderm cells have given rise to a short mesoderm streak on each side. At the anterior end of each mesoderm streak a somewhat long body, the **primitive kidney**, has formed; this contains a channel which opens externally, and whose lumen is ciliated at a later stage. The rudiment of the digestive gland appears in the mid-gut as a paired semi-spherical outgrowth. The body is no longer ciliated all over; cilia are retained only on the neural plate and in the anal region. The double preoral ciliated band now becomes very distinct, and a **postoral band** is

now added. The region between the two ciliated bands also carries cilia and forms an **adoral ciliated zone**.

A further stage of development is depicted in Fig. 217. The rudiment of the pedal ganglion can be recognised as an ectodermal thickening on the ventral side, and that of the gill as a thick epithelial ridge. The stomach has formed a cæcum posteriorly, and the narrow mid-gut has formed a loop. The two auditory vesicles containing otoliths have arisen between the mouth and anus as ingrowths of the ectoderm which have become detached. The mesoderm consists of branched muscle cells, branched cells of connective tissue, the primitive kidney and the still undifferentiated cells of the mesoderm streaks.

The ectodermal thickening, which represents the rudiment of the pedal ganglion at a later stage, becomes rounded off and detached from the ectoderm, at the same time becoming surrounded by the cells of the mesoderm streak, which have rapidly multiplied, and which unite in front of it to form a median mass of cells. This median mass of mesoderm cells increases greatly by rapid division, bulging forward the ectoderm in the anterior ventral region, and thus forming the rudiment of the foot. In the growing branchial fold slits occur, a single slit appearing first, and another soon following in front of the first. The further development of this larva is unknown.

The development of other marine bivalves runs very much the same course as that of *Teredo*, the same larva being formed. The ciliated band is very strongly developed in all marine bivalves (*Teredo*, *Ostrea*, *Modiolaria*, *Cardium*, *Montacuta*, etc.), and is generally carried by a collar-like expansion of the integument, or velum, which is often divided into two lateral lobes. The velum, which on account of the band of strong cilia it carries is the locomotory organ of the free-swimming larvæ of these Lamellibranchs, can be protruded out of and withdrawn into the shell.

Among fresh-water Lamellibranchs there is one form, *Dreissensia polymorpha*, whose larva is free-swimming and carries a well-developed velum. This form is said to have migrated from salt to fresh water in (geologically speaking) recent times.

Special arrangements are found among the other fresh-water forms. The eggs of *Pisidium* and *Cyclas*, for instance, develop in special brood capsules in the gills of the mother animal, and leave these as young bivalves. The Trochophora stage is, nevertheless, passed through, but the velum, not being used for locomotion, remains rudimentary.

2. **Ontogeny of *Cyclas cornea*** (Figs. 218 and 219).—We shall here only mention the points in which the development of *Cyclas* differs from that of *Teredo*, and describe such observations as complete those made on the latter. The blastula consists of a cap of small cells (ectoderm cells) and a floor made of three large cells, one very large primitive endoderm cell and two symmetrical primitive mesoderm cells. The primitive endoderm cell yields through fission a disc of endodermal cells. The two primitive mesoderm cells become overgrown by the ectoderm cells, and thus reach the segmentation cavity. The endoderm invaginates in such a way that a slit-like blastopore arises, which reaches from the region of the future mouth to that of the future anus. This blastopore closes completely. The œsophagus arises as an ingrowth of the ectoderm. A Molluscan Trochophora is formed with a shell gland, a rudimentary foot, a mid-gut, a stomach, anus, primitive kidney, and a neural plate. The velum is reduced to a ciliated area lying at the sides of the mouth (Fig. 218); this reduction is connected with the fact that the Trochophora of *Cyclas* is not a free-swimming larva, for the eggs of *Cyclas* pass through the whole course of their development within the gills of the mother animal. Above the neural plate the ectoderm cells are large and flat, and form a projecting **cephalic vesicle**. The **mesoderm** consists of (1) **scattered cells**, which lie under

the ectoderm of the cephalic cavity, in the foot and on the intestine (especially on the œsophagus, where they are already changed into muscle cells); and (2) two **mesoderm streaks** lying at the sides of the intestine. The **pedal ganglia** arise together with the paired rudiment of the **byssus gland**, as thickenings of the ectoderm at the posterior end of the foot. The **auditory vesicles** originate as ingrowths of the ectoderm. The **mantle** forms by degrees from behind forward as a ridge, which grows more and more ventrally downwards. At the same time the

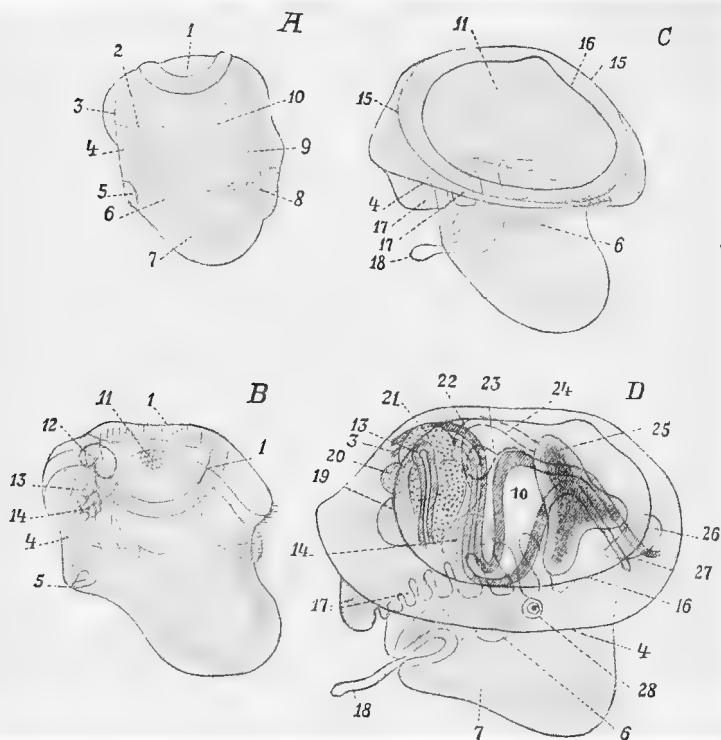

FIG. 218.—A-D, Four stages in the development of *Cyclas cornea*, from the right side (after Ziegler). 1, Membranous shell; 2, rectum; 3, anus; 4, free edge of the mantle ridge or fold; 5, rudimentary byssus cavity with gland; 6, rudiment of the pedal ganglion; 7, foot; 8, velar region; 9, œsophagus; 10, stomach; 11, calcareous shell; 12, pericardium; 13, kidney; 14, rudiment of the gonad; 15, edge of the membranous shell; 16, edge of the calcareous shell; 17, rudiment of the gill; 18, byssus thread; 19, visceral ganglion; 20, posterior adductor; 21, glandular part of the kidney; 22, lateral wall of the pericardial vesicle; 24, median wall of the same; 25, digestive gland (liver); 26, cerebral ganglion; 27, mouth; 28, auditory vesicle.

shell gland, which at its edge secretes the delicate shell membrane, spreads out and becomes flattened. Beneath the shell-membrane the rudiments of the permanent shell valves are produced from two small round areas lying to the right and left of the dorsal middle line (B). The digestive gland (liver) develops from two lateral globular outgrowths of the wall of the stomach. The gonads arise from cells of the mesoderm streaks, which are larger than the rest and also in other ways differentiated, so that they can very early be distinguished. In the anterior and dorsal

part of each mesoderm streak a group of cells surrounds a cavity, which at first is very small, but becomes continually larger. The two vesicles thus formed, the cavities of which represent the **secondary body cavity**, form the pericardium. Behind these the mesoderm cells collect in such a way as to form on each side a strand, which becomes hollow; this is the rudiment of the **nephridium**, which at once becomes connected with the pericardial vesicle, and, growing further towards the ectoderm, soon opens outward. The two pericardial vesicles lengthen posteriorly and upward, each becoming divided into two parts, one lying behind the other, by a constriction, the parts still communicating dorsally with one another (Fig. 219 A). The two double vesicles grow towards one another above the rectum, and finally fuse in the dorsal middle line (B). In a similar manner they fuse below the rectum. The inner wall of the pericardial vesicle becomes the wall of the ventricle (C), and its lateral wall becomes that of the auricle. At the points where the lateral vesicles were constricted lie the slits through which the auricles communicate with the ventricle, and the atrioventricular valves.

The visceral ganglion arises at the posterior end of the mantle furrow from an ectodermal thickening. The pleurovisceral connectives form, in all probability, throughout their whole length, through constriction from the ectoderm. The gill arises on each side as a fold on the dorsal edge of the inner surface of the mantle. It develops from behind forward. In the contrary direction furrows form on the branchial fold, commencing from below upwards; these are found on the inner as well as the outer surface, and exactly correspond. The inner furrows join the outer right through the gill, and thus give rise to the branchial slits.

3. **The development of the Unionidae** (*Anodonta*, *Unio*) is much influenced by the **parasitic manner of life** of the larva. The fertilised eggs reach the outer leaf of the gill of the female, and there run through the first stages of their development. Segmentation leads to the formation of a cœloblastula, in which the rudiment of the **shell gland** appears very early as an incurved plate of large and high cells of the blastula wall. The archenteron forms by invagination at a very late stage; this is no doubt connected with the later parasitism of the larva. Before this invagination occurs the mesoderm has begun to form; its two primitive cells lie in the blastocoel at the part where, later, the enteric invagination appears.

The embryo known as **Glochidium parasiticum** has, in the last stage of its development, which is passed through in the gills of the mother animal but within the egg-shell, the following structure (Fig. 220). It is bilaterally symmetrical, and has a **bivalve shell**. Each valve has, at its ventral edge, a triangular process, the exterior of which is beset with short spines and thorns. Between the two valves, which are markedly concave, lies the soft body, which lines the shell internally in such a way that its ventral epithelial layer might, incorrectly, be called a mantle. It may be called the **false mantle**. If this false mantle is examined from below, when the shell is open, it is seen to have on each side four sensory cells furnished

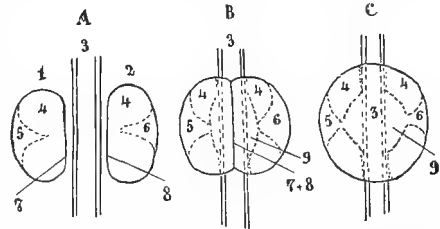

FIG. 219.—A-C, Diagrams illustrating the development of the pericardium and heart of *Cyclas cornea* (after Ziegler). 1 and 2, The two lateral pericardial vesicles; 3, rectum; 4, pericardial cavity; 5 and 6, invaginations of the lateral walls of the pericardium=rudiments of the two lateral auricles; 7 and 8, median walls of the two lateral pericardial vesicles, in B partly fused to form a median septum (above and below the intestine), which in C has disappeared; 9, rudiment of the ventricle.

with long sensory hairs; three of these cells lie near the shell process, and the fourth near the middle line. Between the two more median sensory cells a long **adhesive filament** projects from the opening of the gland which secretes it. Behind this gland are found—(1) the **oral sinus**; (2) a small prominence, the **pedal swelling**;

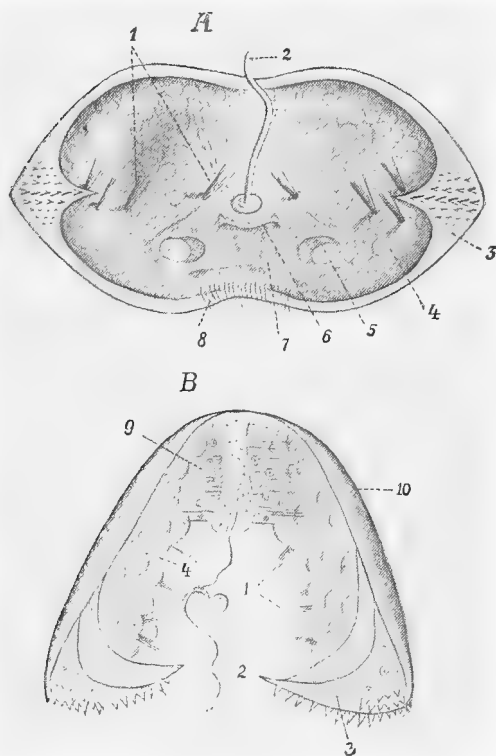

FIG. 220.—*Glochidium larva of Anodonta*, from the outer leaf of the gill of a female. **A**, from below, the shell being open (after Schierholz). **B**, in optical transverse section (after Flemming). 1, Sensory setae; 2, adhesive filament; 3, shell process; 4, false mantle; 5, lateral pits; 6, oral sinus; 7, pedal swelling; 8, ciliated patch; 9, embryonic adductor; 10, shell.

as in a few hours to surround the parasite completely. The embryonic false mantle grows out from each valve of the shell as a fungus-like body to penetrate the tissues of the host, and probably serves for nourishing the embryo. During this endoparasitic life, which lasts for several weeks, the transformation of the embryo into the young Mussel is completed. In the course of this process of transformation some larval organs are resorbed, and also serve for nutrition; first the sensory cells disappear in this way, then the gland of the adhesive filament with the remains of the filament itself, then the adductor, and finally the false mantle. The rudiment of the definitive mantle and shell then appear. The vesicular mid-gut joins the oral sinus; the pedal swelling grows into the linguiform foot, and, in this, the rudimentary byssus gland appears as an ingrowth of the epithelium. The rudiments of the inner branchial leaves, the digestive gland, the nephridium, the heart, the

(3) the **ciliated lateral pits**, one on each side; and (4) furthest back of all, the **ciliated shield or patch**. Between the mantle and shell the **embryonic adductor** runs across from the one valve to the other. Besides these are only found a few isolated muscle fibres, and the **rudiment of the mid-gut**, the latter as an epithelial vesicle, which becomes entirely separated from the ectoderm, and in no way communicates with the exterior.

The embryo at this stage leaves the gills, at the same time emerging from the egg shell. Its adhesive filament floats in the water. If a passing fish comes in contact with such an embryo, the latter can, by closing its shell, attach itself by means of the triangular processes mentioned above, to its integument, into which the spines on these processes penetrate. The embryo of *Anodonta* attaches itself chiefly to the fins, that of *Unio* to the gills of the fish.

The epithelium of the part of the fish attacked grows very rapidly in such a way that the embryo is completely surrounded. The embryonic false mantle grows out from each valve of the shell as a fungus-like body to penetrate the tissues of the host, and probably serves for nourishing the embryo. During this endoparasitic life, which lasts for several weeks, the transformation of the embryo into the young Mussel is completed. In the course of this process of transformation some larval organs are resorbed, and also serve for nutrition; first the sensory cells disappear in this way, then the gland of the adhesive filament with the remains of the filament itself, then the adductor, and finally the false mantle. The rudiment of the definitive mantle and shell then appear. The vesicular mid-gut joins the oral sinus; the pedal swelling grows into the linguiform foot, and, in this, the rudimentary byssus gland appears as an ingrowth of the epithelium. The rudiments of the inner branchial leaves, the digestive gland, the nephridium, the heart, the

cerebral, pedal, and visceral ganglia, and the auditory vesicle appear during the parasitic stage, in the same way as in other Lamellibranchs.

During the last week of parasitic life the capsule formed by a growth of the tissue of the host which surrounds the embryo becomes thinner; the parasite breaks through it, and falls to the bottom of the water as a young Mussel. The only organs still wanting are the genital organs, the outer leaves of the gills, and the oral lobes.

E. Cephalopoda.

Tetrabranchia.—Nothing is known of the development of *Nautilus*.

Dibranchia.—The egg is usually very large, and contains, like that of the sharks, reptiles, and birds, a great quantity of nutritive yolk. It belongs to the telolecithal meroblastic type, and is enclosed in a capsule. A number of such capsules may become cemented together to form strings. The partial segmentation takes place at the animal pole of the egg, and leads to the formation at that point of a germinal disc (blastoderm).

Ontogeny of Sepia.—The blastoderm grows so very slowly round the yolk, that long after all the outer organs of the embryo are quite recognisable in the region of the original germinal disc, the opposite pole is still occupied by the yolk. The germ lies in such a way that the centre of the germinal disc or animal pole is placed dorsally, and corresponds with the uppermost point of the visceral dome of the adult animal, while the mass of nutritive yolk lies ventrally.

1st Stage (Fig. 221 A).—In the centre of the germinal disc there appears an oval-rhombic bulging; this is the rudiment of the **visceral dome** and the **mantle**. On each side of this there arises a bean-shaped prominence, the rudiment of the **eye**. Behind the eye, on each side, a long narrow ridge runs backward in a curve; about half way down this ridge a small prominence, the rudiment of the **funnel cartilage**, forms close to its outer side. The part of the ridge lying in front of this prominence becomes the **muscle** which runs **from the funnel to the nuchal cartilage**; the posterior part (which lies behind the rudiment of the visceral dome and mantle) forms the paired rudiment of the **funnel** itself. Between the two rudiments of the funnel two other prominences rise symmetrically—the rudiments of the **gills**. A pit in the centre of the rudiment of the visceral dome has been indicated as the rudiment of a shell gland (?).

2nd Stage (Figs. 221 B and 222 A).—The rudiments just described stand out more prominently. On the outer and posterior sides of the rudiments of the funnel the rudiments of the two posterior **pairs of arms** first appear as prominences, then those of the third and fourth pairs. The first indications of the **head** are seen in the form of a large double swelling on each side, the outer and anterior part of which carries on each side the rudiment of the eye. The embryo becomes covered with cilia. At the extreme anterior end the **mouth** appears in the middle line, forming the opening of the oesophagus, which begins to sink inwards.

3rd Stage (Fig. 221 C).—The whole embryo has become more arched dorsally, and more marked off from the yolk. On the latter, the blastoderm, which consists of two layers, an external ectoderm and an internal yolk membrane, has spread out further towards the ventral (vegetative) pole of the egg. At the posterior edge of the rudiment of the visceral dome, the **mantle fold** has grown out forward in such a way as to form a small **mantle cavity**, which already partly covers the rudiments of the gills. In the space between the rudiments of the funnel and the gills the **proctodæum** has formed by invagination, and its aperture, the **anus**, can be seen. The rudiment of the fifth pair of arms appears.

4th Stage (Figs. 221 D and 222 F, G).—The visceral dome projects further,

and has a free mantle edge all round its base. The gills have shifted further into the mantle cavity, which is now larger, and lies posteriorly. The rudiments of the funnel also now lie close to the mantle, and are so approximated posteriorly as nearly to touch. **The rudiments of the arms have shifted from behind further forward round the rudiments of the head.** As the whole embryo projects more distinctly from the yolk, the rudiments of the arms shift nearer to

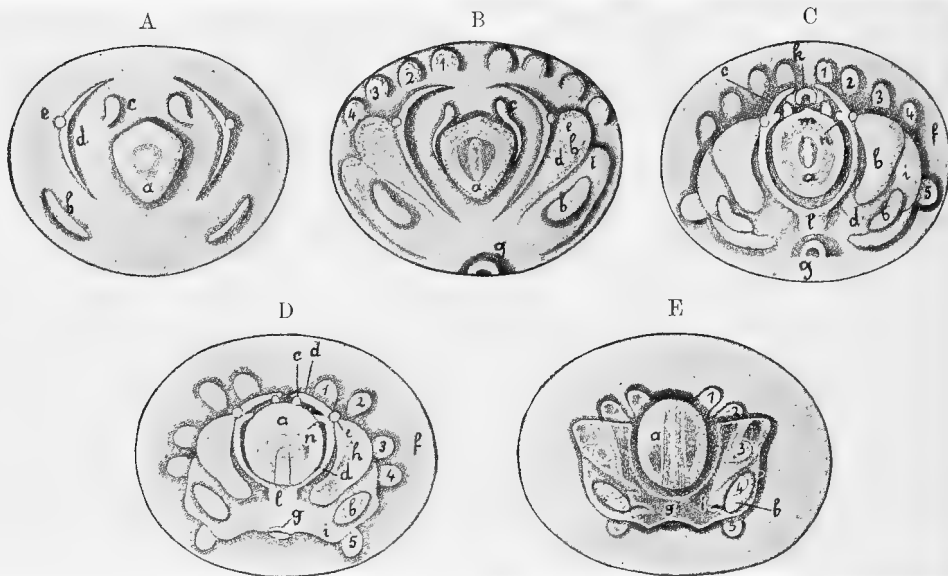

FIG. 221.—**Ontogeny of Sepia** (after Koelliker). A-E, Five stages of development. The free surface of the germinal disc which lies on the yolk is seen, its centre corresponding with the dorsal point of the visceral dome of the adult *Sepia*. The anterior side of the embryo lies lowest in the figures. a, Visceral dome with mantle; b, rudiment of eye; c, rudiment of gill; d, halves of the funnel; e, rudiment of the funnel cartilage belonging to the apparatus for closing the mantle; f, peripheral part of the blastoderm, which, growing all round the yolk, forms the yolk-sac; g, mouth; h, posterior cephalic lobe; i, anterior cephalic lobe; k, anus; 5, anterior or first pair of arms; 4, 3, 2, 1, second, third, fourth, and posterior pairs of arms.

one another and under the rudiments of the head. The anus is already covered by the mantle fold.

5th Stage (Figs. 221 E and 222 B, H).—The arms shift still nearer to one another (*i.e.* towards the axis of the embryo), grouping below the rudiments of the head (which have become fused), and form a somewhat narrow circle on the ventral side in such a way that, when the embryo is seen from the dorsal side, some of them are hidden by the head. As a consequence of this the embryo, which is already recognisable as a young *Sepia*, now becomes sharply constricted from the yolk beneath it. The free edges of the rudiments of the funnel fuse and move to a position within the mantle cavity.

6th Stage (Fig. 222 C).—The rudiments of the head and arms have now assumed the typical position to form the "head" (Kopffuss). The embryo is now altogether distinct from the yolk, to which it merely hangs instead of, as before, lying upon it. The blastoderm finally grows round the yolk and so forms a yolk sac. At first this sac is four or five times the size of the embryo, but in proportion

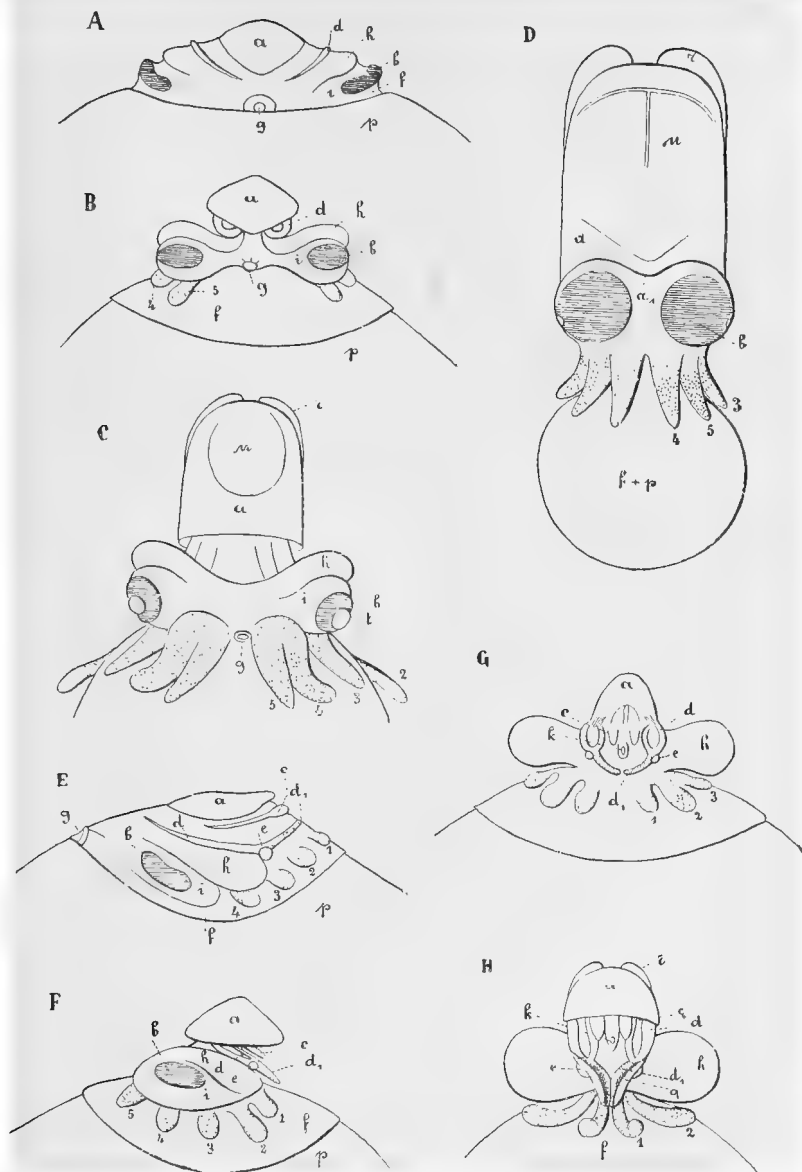

FIG. 222.—Various stages in the development of *Sepia* (after Koelliker). A, B, C, D, Anterior view; E and F, from the left side; G and H, from behind. Lettering as in Fig. 221. In addition: *d*, rudiment of the funnel-nuchal muscle (collaris); *d*₁, paired rudiment of the funnel proper; *p*, yolk; *a*₁, edge of the mantle; *t*, optic invagination (?); *u*, region of the shell; *g*, edges of the two rudiments of the funnel bent round; *r*, fins. In G the mantle fold is raised up in H cut off.

as the latter grows at the expense of the yolk and develops further, the sac becomes smaller, so that when the embryo is hatched the size of the yolk-sac is only one third of that of the young animal (Fig. 222 D). It must further be mentioned with regard to the yolk sac that it is at no time in communication with the intestine. As the embryo becomes constricted from the yolk the latter divides into two parts—an inner part, lying inside the embryo, and an outer part, filling the sac. These two parts are connected by means of the stalk of the yolk sac, which projects downward from the “head.” The yolk within the embryo is divided into three unequal parts, the largest of which fills the visceral dome; another mass of considerable size fills the “head,” and these two masses are connected with a smaller portion lying in the nuchal region.

Loligo and *Argonauta* have a smaller yolk sac, round which the blastopore grows at an earlier stage than in *Sepia*. The yolk sac of *Argonauta* is entirely taken into the body before the latter has completely closed ventrally.

The quantity of nutritive yolk is still less in a *Cephalopod* (*Ommatostrephes*?), the spawn of which floats in the sea. Segmentation is in this case also partial and discoidal, but the blastoderm almost completely encloses the yolk before any organ develops on the germ, and no external yolk sac is formed.

The results of the investigations hitherto made with regard to the germinal layers, the development of the inner organs, and the inner differentiations of the outwardly visible organs are so contradictory and in many cases so incomplete, that no description of them is here attempted. Further investigation is much needed. The development of the eye has already been described (p. 171), and that of the hind-gut and ink-bag was illustrated (p. 197).

Two important facts in the ontogeny of the *Dibranchia* should be noted. (1) In considering the arms as parts of the foot, it is important to notice that they arise behind the rudiments of the head, and only secondarily come to lie round and below the latter. The mouth, at quite a late stage, lies at the anterior end of the circle of arms (Fig. 222 C). (2) The funnel consists of two separate lateral rudiments, the free edges of which fuse secondarily. This point is important in connection with the separation of the two lobes of the funnel, which lasts throughout life in *Nautilus*. For the view of the funnel as epipodium, cf. p. 116.

The fact that the velum is wanting in the Cephalopod embryo must also be noted. The absence of this organ is explained by the direct development of the *Cephalopoda* within the egg capsule at the expense of a large quantity of nutritive yolk.

Investigations as to the development of the shell, and as to the nature of the organ which has been called the shell gland, are much needed.

XXIV. Phylogeny.

No actual points of connection between the Molluscan phylum and any other division of the animal kingdom have as yet been found; the origin of the *Mollusca* is therefore merely a matter of speculation. The present writer favours the view that the *Mollusca* descended from animals like the *Turbellaria*, which had become differentiated from the modern *Platodes* by the acquisition of a hind-gut and a heart, and the (at least partial) transformation of the genital cavity into a secondary and primitively paired body cavity. There is a striking agreement in the nervous system of the lower *Molluscs* (*Chiton*, *Solenogastres*, and in some respects the *Dioto-cardia*) and that of the *Platodes*; in both there is a ladder-like nervous system with the principal trunks beset along their whole length with ganglion cells; the

pleurovisceral cords answer to the lateral trunks of the *Platodes*, and the pedal cords to the ventral longitudinal trunks of the latter. If such a hypothetical racial form were to secrete a dorsal shell, perhaps at first in the form of a thick cuticle containing calcareous particles, a typical Molluscan organisation would be produced. The development of a shell would deprive the greater part of the surface of the body of its original respiratory function, and would lead to the formation of localised gills. By means of the development of a mantle fold these delicate-skinned organs could be brought under the protection of the shell. The musculature on the dorsal side, which the shell covered, would disappear, and with it the dorsal longitudinal nerve trunks. The musculature on the ventral side, which was already strongly developed in the *Planaria*, would become strengthened in the development of the foot with its sole for creeping. A part of the dorsoventral musculature would be changed into the shell muscle.

In this derivation of the *Mollusca* their characteristic larval form might be explained, without any need for tracing it to the Annelidan Trocophora, in the following way. It would correspond to a Turbellarian larva (Müller's Polyclade larva, etc.), on to which certain Molluscan characteristics such as the shell gland, the shell, the anus, and the foot had been shifted back. The preoral ciliated band (the velum) of the Molluscan larva would correspond with the same structure in the Turbellarian larva. The primitive kidney of the former would answer to a simplified water vascular system, while the permanent nephridia as ovarial and seminal ducts might be homologised morphologically with the ducts of the genital products in the *Turbellaria*.

Review of the most important Literature.

Comprehensive Works. Text-Books. General Works. Investigations treating of all or several Classes.

- Boll.** *Beiträge zur Vergleich. Histologie des Molluskentypus.* Arch. für mikr. Anat. Supplementband. 1869.
- H. G. Bronn.** *Die Klassen und Ordnungen des Thierreiches.* 3 Bd. Malacozoa. I. Malacozoa acephala. 1862. II. Malacozoa cephalophora, von W. Keferstein. 1862-1866. (New edition now appearing, v. Simroth.)
- G. Cuvier.** *Mémoires pour servir à l'histoire et à l'anatomie des Mollusques.* Paris, 1817.
- G. B. Deshayes.** *Traité élémentaire de Conchyliologie.* 3 vols. Paris, 1839-1857.
— *Histoire naturelle des Mollusques (Exploration de l'Algérie).* 1848.
- Eydoux and Souleyet.** *Voyage autour du monde sur la corvette la Bonite.* Histoire naturelle. Zoologie. Paris, 1852.
- Paul Fischer.** *Manuel de Conchyliologie et de Paléontologie conchyliologique.* Histoire naturelle des Mollusques vivants et fossiles. 2 vols. Paris, 1887.
- H. von Jhering.** *Vergleichende Anatomie des Nervensystems, und Phylogenie der Mollusken.* Leipzig, 1877.
- Keber.** *Beiträge zur Anatomie und Physiologie der Weichthiere.* Königsberg, 1851.
- E. Ray Lankester.** *Mollusca.* *Encyclopædia Britannica.* 9th edit. Vol. XVI. 1883.
- R. Leuckart.** *Zoologische Untersuchungen.* Heft 3. Giessen, 1854.
- Pelseneer.** *Introduction à l'étude des Mollusques.* Bruxelles, 1894.
- Poli.** *Testacea utriusque Siciliae eorumque historia et anatome.* 3 Bd. 1791-1795.

- H. Simroth.** *Ueber einige Tagesfragen der Malacozologie, hauptsächlich Convergenzerscheinungen betreffend.* Zeitschrift Naturwiss. Halle. 62 Bd. 1889.
- The early parts of the new edition of vol. iii. of Bronn's *Klassen und Ordnungen des Thierreichs*.
- J. Thiele.** *Die Stammesverwandschaft der Mollusken. Ein Beitrag zur Phylogenie der Thiere.* Jenaische Zeitschr. f. Naturwissensch. 25 Bd. 1891.
- S. P. Woodward.** *A Manual of the Mollusca.* 4th edit. 1880.

Amphineura.

- L. Graff.** *Anatomie des Chaetoderma nitidulum.* Zeitschr. f. wissen. Zoologie. 26 Bd. 1876.
- *Neomenia und Chaetoderma.* Zeitschr. f. wissen. Zoologie. 28 Bd. 1877.
- B. Haller.** *Die organisation der Chitonen der Adria.* Arb. aus dem Zool. Institut. in Wien. I. Theil. 4 Bd. 1882. II. Theil. 5 Bd. 1883.
- G. A. Hansen.** *Anatom. Beskrivelse of Chaetoderma nitidulum.* Nyt magaz. for naturvidenskab. Vol. XXII. 1877.
- *Neomenia, Proneomenia und Chaetoderma.* Bergen Mus. Aarster. f. 1888.
- J. Heuscher.** *Zur Anatomie und Histologie von Proneomenia Stultzeri.* Jena. Zeitsch. Vol. XXVII. 1893.
- A. A. W. Hubrecht.** *Proneomenia Stultzeri.* Nederl. Arch. Zool. Suppl. I. 1881.
- *A Contribution to the Morphology of Amphineura.* Quart. Journ. Micr. Science. Vol. XXII. 1882.
- *Dondersia festiva gen. et spec. nov.* Donders Festbundel. Nederl. Tijdschr. Geneesk. 1888.
- J. Koren and D. C. Danielssen.** *Descriptions of new species belonging to the genus Solenopus, with some observations on their organisation.* Ann. Nat. Hist. (5). Vol. III. 1879.
- A. Kowalevsky and A. F. Marion.** *Contributions à l'histoire des Solenogastres ou Aplacophores.* Ann. Mus. H. N. Marseilles. Tome III. 1889.
- A. Th. v. Middendorff.** *Beiträge zu einer Malacozologia rossica. I. Beschreibung und Anatomie neuer oder für Russland neuer Chitonen.* Mém. de l'Académie St. Petersburg. Tome VI. 1849.
- G. Pruvot.** *Sur l'organisation de quelques Néoméniens des côtes de France.* Arch. Zool. expér. 2^o. Vol. IX. 1891.
- A. Sedgwick.** *On certain points in the anatomy of Chiton.* Proceed. Roy. Soc. No. 217. Dec. 1881.
- Simroth.** See above.
- T. Tullberg.** *Neomenia, a new genus of invertebrate animals.* Svenska Vet. Akad. Handl. Bd. III. 1875.
- Axel Wiren.** *Studien über die Solenogastres. I. Monographie des Chaetoderma nitidulum Lovén.* Königl. Svenska Vetenskaps - Akademiens Handlingar. Vol. XXIV. Stockholm, 1892.
- In addition, works of Van Bemmelen, Dall, Pelseener, etc.

Gastropoda.

- Alder and Hancock.** *A monograph of the British Nudibranchiate Mollusca.* London, 1850-1851.
- R. Bergh.** *Beiträge zu einer Monographie der Polyceraden, I., II., III.* Verhandl. der k. k. Zool. Botan. Gesellschaft zu Wien. 29, 30, 33 Bd. 1879-1883.

- R. Bergh.** *Ueber die Verwandtschaftsbeziehungen der Onchidien.* *Morph. Jahrb.* 10 Bd. 1884.
- *Report on the Nudibranchiata of the "Challenger" Expedition.* *Chall. Report Zool.* Vol. X. 1884.
- *Die Titiscanien, eine Familie der rhipidoglossen Gastropoden.* With three Plates. *Morphol. Jahrb.* 16 Bd. 1890.
- *Die Marseniaden.* *Zool. Jahrb.* 1 Bd. 1886; compare also Semper's *Reisen im Archipel der Philippinen.* 2 Theile. *Wissensch. Resultate. Suppl.* Heft 3. 1886.
- *Die cladohepatischen Nudibranchien.* *Zool. Jahrb. Abth. für Systematik.* 5 Bd. 1891.
- *Die cryptobranchiaten Dorididen.* *Zool. Jahrb. Abth. für Systematik.* 6 Bd. 1891.
- In addition, numerous monographs of various families, genera, and species of the Opisthobranchia in various journals.
- J. E. V. Boas.** *Spolia atlantica. Bidrag til Pteropodernes Morfologi og Systematik samt til Kundskaben om deres geografiske Udbredelse.* *Danske Vid. Selsk. Skr.* (6). 4 Bd. 1886.
- *Zur Systematik und Biologie der Pteropoden.* *Zool. Jahrb.* 1 Bd. 1886.
- L. Boutan.** *Recherches sur l'anatomie et le développement de la Fissurelle.* *Arch. Zool. expér.* (2). Tome III. 1886.
- E. L. Bouvier.** *Système nerveux, morphologie générale et classification des Gastropodes prosobranches.* *Ann. des Sciences Nat.* (7). Tome III. 1877.
- E. Claparède.** *Anatomie und Entwicklungsgeschichte der Neritina fluviatilis.* *Müller's Archiv.* 1857.
- P. Garnault.** *Recherches anatomiques et histologiques sur le Cyclostoma elegans.* *Arch. Soc. Linn.* Bordeaux, 1887.
- C. Gegenbaur.** *Untersuchungen über Pteropoden und Heteropoden.* Leipzig, 1853.
- R. J. Harvey Gibson.** *Anatomy and physiology of Patella vulgata.* Part I. *Anatomy.* *Trans. Roy. Soc. Edinburgh.* Vol. XXXII. 1887.
- B. Haller.** *Untersuchungen über marine Rhipidoglossen. I. Studie.* *Morph. Jahrb.* 9 Bd. 1883. *II. Studie.* 11 Bd. 1886.
- *Die Morphologie der Prosobranchier, gesammelt auf einer Erdumseglung durch die Königl. ital. corvette "Vettor Pisani."* *I. Morph. Jahrb.* 14 Bd. 1888. *II. ibid.* 16 Bd. 1890.
- Huxley.** *On the morphology of the cephalous Mollusca as illustrated by the anatomy of certain Heteropoda and Pteropoda, etc.* *Philos. Transactions.* 1853.
- J. Joyeux-Laffaie.** *Organisation et développement de l'Onchidie (Onchidium celticum Cuv.).* *Arch. Zool. expér.* Tome X. 1882.
- H. de Lacaze-Duthiers.** *Histoire et monographie du Pleurobranche orangé.* *Annales des Sciences Nat.* (4). Tome XI. 1859.
- *Mémoire sur la Pourpre.* *Annales des Sciences Nat.* (4). Tome XII. 1859.
- *Mémoire sur le système nerveux de l'Haliotide.* *Ann. des Sciences Nat.* (4). Tome XII. 1859.
- *Mémoire sur l'anatomie et l'embryogénie des Vermets.* *Ann. des Sciences Nat.* (4). Tome XIII. 1860.
- *Histoire de la Testacella.* *Arch. Zool. expér.* (2). Tome V. 1888.
- A. Lang.** *Versuch einer Erklärung der Asymmetrie der Gastropoden.* *Vierteljahrsschrift d. Naturf. Gesellsch. Zürich.* 36 Bd. 1891.
- F. Leydig.** *Ueber Paludina vivipara.* *Zeitschr. f. wiss. Zool.* 2 Bd. 1850.
- Milne Edwards.** *Note sur la classification naturelle des Mollusques Gastropodes.* *Ann. des Sciences Nat.* 1848.

- G. Moquin-Tandon.** *Recherches anatomiques sur l'ombrelle de la méditerranée.* *Ann. des Sciences Nat.* (5). Vol. XIV. 1875.
- H. Müller and C. Gegenbaur.** *Ueber Phyllirhoë bucephalum.* *Müll. Arch.* 1858.
- A. Nalepa.** *Beiträge zur Anatomie der Styломmatophoren.* *Sitz.-Ber. Akad. Wien.* 87 Bd. 1883.
- Nordmann.** *Monographie de Tergipes Edwardsii.* *Mém. Acad. Imp. St. Pétersbourg.* Tome IV. 1843.
- J. Paneth.** *Beiträge zur Histologie der Pteropoden und Heteropoden.* *Archiv. für mikrosk. Anat.* 24 Bd. 1884.
- J. I. Peck.** *On the anatomy and histology of Cymbuliopsis calceola.* 4 Plates. *Studies Biol. Labor. Johns Hopk. Univ.* Vol. IV.
- Paul Pelseuer.** *Report on the Pteropoda collected by H.M.S. "Challenger" during, etc.* Parts I. II. III. *Chall. Report Zool.* Part LVIII. 1887; Part LVI. 1888; Part LXV. 1888.
- *The cephalic appendages of the gymnosomatous Pteropoda, and especially of Clione.* *Quart. Journ. Microsc. Science* (2). Vol. XXV. 1885.
- L. Plate.** *Studien über opisthobranchische Lungenschnecken. I. Daudebardia und Testacella.* *Zool. Jahrbücher. Abth. für Anatomie und Ontogenie.* 4 Bd. 1891.
- Quatrefages.** *Mémoire sur les Gastropodes phlébentères.* *Ann. des Sciences Nat.* Tomes III. and IV. 1844 and 1845.
- Rang and Souleyet.** *Histoire naturelle des Mollusques Pteropodes.* Paris, 1852.
- B. Sharp.** *Beiträge zur Anatomie von Ancyclus fluviatilis (O. F. Müll) und Ancyclus lacustris (Geoffroy).* *Inaug.-Dissert.* Würzburg, 1883.
- H. Simroth.** *Ueber die Bewegung und das Bewegungsorgan des Cyclostoma elegans und der einheimischen Schnecken überhaupt.* *Zeitschr. f. Wiss. Zool.* 36 Bd. 1881.
- *Versuch einer Naturgeschichte der deutschen Nacktschnecken und ihrer europäischen Verwandten.* *Zeitschr. f. wiss. Zoologie.* 42 Bd. 1885.
- In addition, many other treatises on the Pulmonata in various journals.
- S. Trinchese.** *Materiali per la fauna marittima italiana. Aeolididae e famigliae affini.* *Atti accad. Lincei* (3). *Mem.* Vol. XI. 1883.
- Troschel.** *Beiträge zur Kenntniss der Pteropoden.* *Arch. f. Naturg.* Tome XX. 1854.
- M. Vayssiére.** *Recherches anatomiques sur les Mollusques de la famille des Bullidés.* *Ann. Hist. Nat. Zool.* (6). Tome IX. 1880.
- *Recherches anatomiques sur les genres Pelta (Runcina) et Tyloclina.* *Ann. des Sciences Nat.* (6). Tome XV. 1883.
- *Recherches zoologiques et anatomiques sur les Mollusques opisthobranches du golfe de Marseilles.* Part I. *Tectibranches.* *Ann. Mus. Hist. N. Marseilles.* Tome II. *Mém.* 3. 1885. Part II. *Ibid.* Tome III. *Mém.* No. 4. 1888.
- Nicolas Wagner.** *Die wirbellosen Thiere des weissen Meeres.* 1 Bd. Leipzig. Fol. 1885.
- H. Wegmann.** *Contribution à l'histoire naturelle des Haliotides.* *Arch. Zool. expér.* (2). Tome II. 1884.
- *Note sur l'organisation de la Patella vulgata L.* *Recueil. Z. Suisse.* Tome IV. 1887.
- Émile Yung.** *Contributions à l'histoire physiologique de l'escargot (Helix pomatia).* *Mém. Cour. Acad. Belg.* Tome XLIX. 1887.

Scaphopoda.

- Herm. Fol.** *Sur l'anatomie microscopique du Dentale.* 4 Pl. *Arch. Zool. expér.* (2). Tome VII. 1889.

- H. de Lacaze-Duthiers.** *Histoire de l'organisation et du développement du Dentale.* *Ann. des Sciences Nat.* (4). Tomes VI., VII., and VIII. 1856-57-58.
- L. Plate.** *Bemerkungen zur Organisation der Dentalien.* *Z. Anzeiger.* 11 Jahrg. 1888. *Ueber das Herz der Dentalien.* *Ibid.* 14 Jahrg. 1891.
- M. Sars.** *Om Siphonodentalium vitreum, etc.* Christiania, 1861.

Lamellibranchia.

- Ernst Egger.** *Jouannetia Cumingi* Son. *Eine morphol. Untersuchung.* *Arbeit. Zool. Instit. Würzburg.* 8 Bd. 1887.
- Garner.** *On the anatomy of the Lamellibranchiate Conchifera.* *Transact. Zool. Soc. London.* Vol. II. 1841.
- H. de Lacaze-Duthiers.** *Mémoire sur l'organisation de l'Anomie.* *Ann. des Sciences Nat.* (4). Tome II. 1854.
- *Morphologie des Acéphales.* 1 Mém. *Anatomie de l'Arrosoir (Aspergillum dichotomum).* *Arch. Zool. expér.* (2). Tome I. 1883.
- Leydig.** *Anatomie und Entwicklung von Cyclas.* *Müller's Archiv.* 1835.
- H. A. Meyer and Moebius.** *Fauna der Kieler Bucht.* Leipzig, 1865.
- Paul Pelseener.** *Report on the anatomy of the deep-sea Mollusca collected by H.M.S. "Challenger."* *Report Chall. Zool.* Part 74. 1888.
- *Contribution à l'étude des Lamellibranches.* *Archives de Biologie.* Tome XI. 1891.
- A. de Quatrefages.** *Mémoire sur le genre Taret.* *Ann. des Sciences Nat.* (3). Tome XI. 1849.

Cephalopoda.

- A. G. Bourne.** *The differences between the males and females of the pearly Nautilus.* *Nature.* Vol. XXVIII. 1883.
- J. Brock.** *Studien über die Verwandtschaftsverhältnisse der dibranchiaten Cephalopoden.* Erlangen, 1879.
- *Versuch einer Phylogenie der dibranchiaten Cephalopoden.* *Morph. Jahrbuch.* 6 Bd. 1880.
- *Zur Anatomie und Systematik der Cephalopoden.* *Zeitschr. f. wiss. Zool.* 36 Bd. 1882.
- Delle Chiaje.** *Memorie su' Cefalopodi. Memorie sulla storia e notomia degli animali senza vertebre del regno di Napoli.* Napoli, 1829.
- Férussac and d'Orbigny.** *Histoire naturelle générale et particulière des Céphalopodes acétabulifères vivants et fossiles.* Paris, 1835-1845.
- Léon Fredericq.** *Recherches sur la physiologie du Poulpe commun (Octopus vulgaris).* *Arch. Zool. expér.* Tome VII. 1879.
- Carl Grobben.** *Zur Kenntniss der Morphologie und Verwandtschaftsverhältnisse der Cephalopoden.* *Arb. Z. Inst. Wien.* 7 Bd. 1886.
- B. Haller.** *Beiträge zur Kenntniss der Morphologie Nautilus Pompilius.* *Zool. d. Semon's Forschungsreise in Australien.* Vol. V. 1895.
- H. von Jhering.** *Ueber die Verwandtschaftsbeziehungen der Cephalopoden.* *Zeitschr. f. wiss. Zool.* 35 Bd. 1880.
- Van der Hoeven.** *Beitrag zur Kenntniss von Nautilus.* Amsterdam, 1856.
- Will. E. Hoyle.** *Observations on the anatomy of a rare Cephalopod (Gonatus Fabricii).* *Proc. Z. Soc. London.* II. 1889.
- H. Müller.** *Ueber das Männchen von Argonauta argo und die Hectocotylen.* *Zeitschr. f. wiss. Zool.* 1855.
- R. Owen.** *Memoir on the pearly Nautilus, etc.* London, 1832.

- R. Owen.** *Description of some new and rare Cephalopoda.* *Trans. Zool. Soc. London.* Vol. II. 1841.
- *Cephalopoda.* *Todd's Cyclopædia,* etc. Vol. I. London, 1836.
- *Supplementary Observations on the Anatomy of Spirula australis Lam.* *Ann. of Nat. Hist.* (5). Vol. III. No. 13. 1879.
- J. B. Verany.** *Mollusques méditerranéens observés, décrits, figurés et chromolithographiés d'après le vivant.* Part I. *Céphalopodes de la Méditerranée.* Gênes, 1847-1851.
- Verany and Vogt.** *Mémoires sur les Hectocotyles, etc.* *Ann. des Sciences Nat.* Tome 17. 1852.
- W. J. Vigelius.** *Untersuchungen an Thysanoteuthis rhombus Frosch.* *Ein Beitrag zur Anatomie der Cephalopoden.* *Mith. Zool. Station zu Neapel.* 2 Bd. 1880.
- F. Ernest Weiss.** *On some oigopsid cuttle-fishes.* *Quart. Journ. Micr. Science.* Vol. XXIX. 1889.

**Treatises on Single Organs or Groups of Organs,—Integument, Mantle, Shell,
Oral Lobes.**

- Félix Bernard.** *Recherches sur les organes palléaux des Gastropodes prosobranches.* *Thèse.* Paris, 1890. Also in *Annales des Sciences Nat.* VII. 1889.
- F. Blochmann.** *Ueber die Drüsen des Mantelrandes bei Apysia und verwandten Formen.* *Zeitschr. f. wissenschaft. Zool.* 38 Bd. 1883.
- Jos Blumrich.** *Das Integument der Chitonen.* *Mit einer Vorbemerkung von Prof. Hatschek.* *Zeitschr. f. wiss. Zoologie.* 52 Bd. 1891.
- Bowerbank.** *On the structure of the shells of molluscous and conchiferous animals.* *Trans. of Micr. Soc.* I. London, 1844.
- W. Carpenter.** *On the microscopic structure of shells.* Report British Assoc. 1843 and 1847. London, 1844 and 1848.
- E. Ehrenbaum.** *Untersuchungen über die Structur und Bildung der Schale der in der Kieler Bucht häufig vorkommenden Muscheln.* *Zeitschr. f. wiss. Zool.* 41 Bd. 1884.
- P. Girod.** *Recherches sur la peau des Cephalopodes.* *Arch. Zool. expériment (2).* Tome I. 1883.
- H. Meckel.** *Mikrographie einiger Drüsenapparate der niederen Thiere.* *Müller's Archiv.* 1846.
- Felix Müller.** *Ueber die Schalenbildung bei Lamellibranchiaten.* *Zool. Beiträge Schneider.* 1 Bd. 1885.
- R. Owen.** *On the relative positions to their Constructors of the chambered shells of Cephalopods.* *Proc. Zool. Soc. London.* 1878.
- Bernhard Rawitz.** *Der Mantelrand der Acephalen.* 1. *Ostracea.* *Jenaische Zeitschr. f. Naturwiss.* 22 Bd. 1888. 2. *Arcacea, Mytilacea, Unionacea.* *Ibid.* 24 Bd. 1890.
- G. Steinmann.** *Vorläufige Mittheilung über die Organisation der Ammoniten.* *Ber. Nat. Ges. Freiburg.* 4 Bd. 1889.
- G. Steinmann and L. Döderlein.** *Elemente der Paläontologie.* Leipzig, 1890.
- Johannes Thiele.** *Die Mundlappen der Lamellibranchiaten.* *Zeitschr. f. wiss. Zoologie.* 44 Bd. 1886.
- T. Tullberg.** *Studien über den Bau und das Wachsthum des Hummerpanzers und der Molluskenschalen.* *Kongl. Svensk. Vetensk. Akad. Handling.* 19 Bd. 1882.
- Karl A. Zittel.** *Handbuch der Paläontologie.* I. Abth. *Paläozoologie.* II. Band. *Mollusca und Arthropoda.* München and Leipzig, 1881-1885.

Musculature, Foot, Pedal Glands, the Taking in of Water.

- Th. Barrois.** *Les glandes du pied et les pores aquifères des Lamellibranches.* Lille, 1885.
- J. Carrière.** *Die Drüsen im Fusse der Lamellibranchiaten.* Arbeit. aus d. zool. Institut Würzburg. 5 Bd. 1879.
- *Die Fussdrüsen der Prosobranchier und das Wassergefäß-system der Lamellibranchier und Gastropoden.* Archiv. f. mikrosk. Anatomie. 21 Bd. 1882.
- C. Grobben.** *Zur Morphologie des Fusses der Heteropoden.* Arb. Zool. Inst. Wien. 7 Bd. 1887.
- A. Fleischmann.** *Die Bewegung des Fusses der Lamellibranchiaten.* Zeitschr. f. wiss. Zoologie. 42 Bd. 1885.
- Georg Kalide.** *Beitrag zur Kenntniss der Musculatur der Heteropoden und Pteropoden, zugleich ein Beitrag zur Morphologie des Molluskenfusses.* Zeitschr. f. wiss. Zool. 46 Bd. 1888.
- J. H. List.** *Zur Kenntniss der Drüsen im Fusse von Tethys fimbriata L.* Zeitschr. f. wiss. Zool. 45 Bd. 1887.
- Paul Pelseener.** *Sur la valeur morphologique des bras et la composition du système nerveux central des Céphalopodes.* Arch. Biol. Tome VIII. 1888.
- *Sur l'épipodium des Mollusques.* Bull. Scientif. France et Belg. Tome 19. 1888. Tome 22. 1890. Tome 23. 1891.
- Bernhard Rawitz.** *Die Fussdrüse der Opisthobranchier.* Abhandl. Akad. Berlin. 1887.
- Ludwig Reichel.** *Ueber die Bildung des Byssus der Lamellibranchiaten.* Zool. Beiträge, Schneider. 2 Bd. 1888.
- P. Schiemenz.** *Ueber die Wasseraufnahme bei Lamellibranchiaten und Gastropoden (einschliesslich Pteropoden).* Mitth. Zool. Station Neapel. 5 Bd. 1884. 2 Theil. 7 Bd. 1887. This paper contains the further literature on this subject.
- Jap. Steenstrup.** *Hectocotylus dannelsen hos Octopods, etc.* K. Dansk. Vidensk. Selskabs Skrifter. 1856.

Nervous System.

- L. Böhmig.** *Beiträge zur Kenntniss des Centralnervensystems einiger pulmonaten Gastropoden.* Inaug.-Diss. Leipzig, 1883.
- E. L. Bouvier.** *Système nerveux, morphologie générale et classification des Gastropodes prosobranches.* Annales des Sciences Nat. (7). Tome III. 1887.
- Louis Boutan.** *Contribution à l'étude de la masse nerveuse ventrale (cordons palléovisceraux) et de la collerette de la Fissurelle.* Arch. Zool. expériment. (2). Tome VI. 1889.
- J. Brock.** *Zur Neurologie der Prosobranchier.* Zeitschr. f. wiss. Zool. 48 Bd. 1889.
- O. Bütschli.** *Bemerkungen über die wahrscheinliche Herleitung der Asymmetrie der Gastropoden, spec. der Asymmetrie im Nervensystem der Prosobranchier.* Morph. Jahrb. 12 Bd. 1886.
- Chéron.** *Recherches sur le système nerveux des Céphalopodes dibranchiaux.* Annales des Sciences Nat. (5). Tome V. 1866.
- Karl Drost.** *Ueber das Nervensystem und die Sinnesepithelien der Herzmuschel (Cardium edule), etc.* Morph. Jahrbuch. 12 Bd. 1886.
- Duvernoy.** *Mémoires sur le système nerveux des Mollusques acéphales.* Mémoires de l'Académie des Sciences. Tome XXIV. 1854.

- B. Haller.** *Zur Kenntniss der Muriciden. Eine vergl.-anat. Studie. I. Theil. Anatomie des Nervensystems. Denkschr. math.-naturw. Klasse Akad. Wissensch. Wien.* 45 Bd. 1882.
- *Untersuchungen über marine Rhipidoglossen. II. Textur des Central-nervensystems und seiner Hüllen. Morph. Jahrb.* 11 Bd. 1885.
- H. von Jhering.** *Vergleichende Anatomie des Nervensystems und Phylogenie der Mollusken.* Leipzig, 1877.
- Lacaze-Duthiers.** *Du système nerveux des Mollusques gastropodes pulmonés aquatiques. Arch. de Zool. exp.* Tome I. 1872.
- Bernhard Rawitz.** *Das centrale Nervensystem der Acephtalen. Jenaische Zeitschr. f. Naturwiss.* 20 Bd. 1887.
- Paul Pelseener.** *Sur la valeur morphologique des bras et la composition du système nerveur central des Céphalopodes. Arch. Biol.* Tome VIII. 1888.
- *Recherches sur le système nerveux des Pteropodes. Arch. Biol.* Tome VII. 1887.
- C. Semper.** *Ueber Sehorgane vom Typus der Wirbelthieraugen.* Wiesbaden, 1877.
- H. Simroth.** *Das Fussnervensystem von Paludina vivipara. Zeitschr. f. wiss. Zool.* 35 Bd. 1880.
- *Ueber das Nervensystem und die Bewegung der deutschen Binnenschnecken. Progr. d. Realschule.* 2 Ordnung. Leipzig. No. 503. 1882.
- J. W. Spengel.** *Die Geruchsorgane und das Nervensystem der Mollusken. Zeitschr. f. wiss. Zool.* 35 Bd. 1881.

Sensory Organs.

- Félix Bernard.** *Recherches sur les organes palléaux des Gastropodes prosobranches. Ann. des Sciences Nat.* (7). Tome IX. 1890. Containing researches on the osphradia of the Gastropoda.
- J. Brock.** *Ueber die sogenannten Augen von Tridacna und das Vorkommen von Pseudochlorophyllkörpern im Gefäss-system der Muscheln. Zeitschr. f. wiss. Zool.* 46 Bd. 1888.
- O. Bütschli.** *Notiz zur Morphologie des Auges der Muscheln. Festschr. 500-jährig. Bestehens der Ruperto-Carola dargeb. v. Nat.-Med. Ver. Heidelberg. Nat. Theil.* 1886.
- Justus Carrière.** *Die Sehorgane der Thiere vergleichend-anatomisch dargestellt.* München and Leipzig, 1885.
- *Ueber Molluskenaugen. Arch. f. mikrosk. Anat.* 33 Bd. 1889.
- C. Claus.** *Das Gehörorgan der Heteropoden. Arch. f. mikrosk. Anat.* 12 Bd. 1875.
- P. Fraisse.** *Ueber Molluskenaugen mit embryonalem Typus. Zeitschr. f. wiss. Zool.* 35 Bd. 1881.
- W. Flemming.** *Untersuchungen über Sinnesepithelien der Mollusken. Arch. f. mikr. Anat.* Tome VI. 1870.
- H. Grenacher.** *Abhandlungen zur vergleichenden Anatomie des Auges. I. Die Retina der Cephalopoden. Abhandl. Naturf. Gesellsch. z. Halle.* 16 Bd. 1884.
- II. Das Auge der Heteropoden. Ibid.* 17 Bd. 1886.
- V. Hensen.** *Ueber das Auge einiger Cephalophoren. Zeitschr. f. wiss. Zool.* 15 Bd. 1865.
- C. Hilger.** *Beiträge zur Kenntniss des Gastropodenauges. Morph. Jahrb.* 10 Bd. 1884.
- Lacaze-Duthiers.** *Otocystes ou capsules auditives des Mollusques (Gastropodes). Arch. d. Zool. exp.* Tome I. 1872.
- E. Ray Lankester and A. G. Bourne.** *On the existence of Sprunge's olfactory organ and of paired genital ducts in the pearly Nautilus. Quart. Jour. Micr. Science.* Vol. XXIII. 1883.

- F. Leydig.** *Ueber das Gehörorgan der Gastropoden.* *Archiv. f. mikrosk. Anatomie.* 7 Bd. 1871.
- H. N. Moseley.** *On the presence of eyes in the shells of certain Chitonidæ and on the structure of these organs.* *Quart. Journ. Micr. Science* (2). Vol. XXV. 1885.
- Ph. Owsjannikow and Kowalevsky.** *Ueber das Centralorgan und das Gehörorgan der Cephalopoden.* St. Petersburg, 1867.
- W. Patten.** *Eyes of Molluscs and Arthropods.* *Mith. Zool. Stat. Neapel.* 6 Bd. 1886.
- Paul Pelseneer.** *Sur l'œil de quelques Mollusques gastropodes, et Les organes des sens chez les Mollusques.* *Annales Société Belge Microsc. (Mémoires).* Tome XVI. 1891.
- Rawitz.** See above under heading *Integument.*
- P. B. Sarasin.** *Ueber drei Sinnesorgane und die Füllsdrüse einiger Gastropoden.* *Arbeit. Zool.-zoot. Inst. Würzburg.* 6 Bd. 1883.
- B. Sharp.** *On the visual organs in Lamellibranchiata.* *Mith. Zool. Stat. in Neapel.* 5 Bd. 1884.
- D. Sochaczewer.** *Das Riechorgan der Landpulmonaten.* *Zeitschr. f. wiss. Zool.* 35 Bd. 1880.
- J. E. Tenison-Woods.** *On the anatomy and life history of Mollusca peculiar to Australia.* *Proc. Roy. Soc. N.S. Wales.* Vol. XXII. 1889.
- Johs. Thiele.** *Die abdominalen Sinnesorgane der Lamellibranchier.* *Zeitschr. f. wiss. Zool.* 48 Bd. 1889.

Intestine, Ink-bag.

- D. Barfurth.** *Ueber den Bau und die Thätigkeit der Gastropodenleber.* *Archiv. f. mikr. Anatomie.* 22 Bd. 1883.
- Th. Barrois.** *Le stylet cristallin des Lamellibranches.* *Revue biol. du Nord de la France.* Tome II. 1890.
- Em. Bourquelot.** *Recherches sur les phénomènes de la digestion chez les Mollusques céphalopodes.* *Arch. de Zool. exp.* (2). Tome III. 1885.
- J. Frenzel.** *Mikrographie der Mitteldarmdrüse (Leber) der Mollusken.* I. *Allgemeine Morphologie und Physiologie des Drüsenepithels.* *Nova acta Acad. Coes. Leop.-Carol.* 48 Bd. 1886.
- Heinrich Maria Gartenauer.** *Ueber den Darmkanal einiger einheimischen Gastropoden.* *Inaug.-Diss.* Strassburg, 1875.
- Patrick Geddes.** *On the mechanism of the odontophore in certain Mollusca.* *Trans. Zool. Soc. London.* Vol. X. Part II. 1879.
- Paul Girod.** *Recherches sur la poche du noir des Céphalopodes des côtes de France.* *Arch. de Zool. experim.* Tome X. 1882.
- Macdonald.** *General classification of the Gastropoda.* *Trans. of the Linn. Soc. of London.* Tome XXIII. 1860.
- Panceri.** *Gli organi e la secrezione dell' acido solforico nei Gastropodi con un appendice, etc.* *Atti della R. Accad. delle scienze fisiche.* Tome IV. 1869.
- Rössler.** *Die Bildung der Radula bei den cephalophoren Mollusken.* *Zeitschr. f. wiss. Zool.* Bd. XLI. 1885.
- C. Semper.** *Zum feineren Bau der Molluskenzunge.* *Zeitschr. f. wiss. Zool.* 9 Bd. 1868.
- H. Troschel.** *Das Gebiss der Schnecken.* 1 Bd. Berlin, 1856-1863.
- W. J. Vigelius.** *Vergleichend-anatomische Untersuchungen über das sogenannte Panceras der Cephalopoden.* *Verhandl. k. Akad. Wetensch. Amsterdam.* Deel 22. 1881.

Respiratory Organs, Circulatory System.

- Félix Bernard.** *Recherches sur les organes palléaux des Gastropodes prosobranches.* Thèse. Paris, 1890.
- Bojanus.** *Ueber die Athem- und Kreislaufwerkszeuge der zweischaligen Muscheln.* Isis, 1817, 1820, 1827.
- L. Cuenot.** *Études sur le sang et les glandes lymphatiques dans la série animale.* 2 Partie. Invertébrés. Arch. de Zool. expériment. (2). Vol. IX. 1891.
- Carl Grobben.** *Ueber den vultus arteriosus und die Aortenklappen der Lamellibranchiaten.* Arbeiten a. d. Zoologischen Institute der Universität Wien. 9 Bd. 1891.
- W. A. Herdmann.** *On the structure and function of the cerata or dorsal papillæ in some Nudibranchiate Mollusca.* Quart. Journ. Microsc. Science. Vol. XXXI. Part I. 1891.
- L. Joubin.** *Structure et développement de la branchie de quelques Céphalopodes des côtes de France.* Arch. de Zool. expériment. (2). Vol. III. 1885.
- Langer.** *Ueber das Gefäss-system der Teichmuschel.* Denkschriften der Wiener Akademie. 1855 and 1856.
- A. Menagaux.** *Recherches sur la circulation des Lamellibranches marins.* Besançon, 1890.
- K. Mitsukuri.** *On the structure and significance of some aberrant forms of Lamellibranchiate gills.* Quart. Journ. Microsc. Science. N. S. 21. 1881.
- H. L. Osborn.** *On the gill in some forms of prosobranchiate Mollusca.* Stud. biol. labor. J. Hopkins Univ. Vol. III. 1884.
- R. Holman Peck.** *The structure of the Lamellibranchiate gill.* Quart. Journ. Microsc. Science. Vol. XVII. 1877.
- C. Posner.** *Ueber der Bau der Najadenkieme.* Arch. f. mikrosk. Anat. Bd. XI. 1875.

Secondary Body Cavity, Nephridia, Genital Organs.

- Baudelot.** *Recherches sur l'appareil génér. des Mollusques gastropodes.* Ann. Sci. Nat. (4). Tome XIX. 1862.
- Th. Behme.** *Beiträge zur Anatomie und Entwicklungsgeschichte des Harnapparates der Lungenschnecken.* Arch. Naturg. Jahrg. 55. 1889.
- J. Brock.** *Ueber die Geschlechtsorgane der Cephalopoden.* Erster Beitrag. Zeitschr. f. wiss. Zool. 32 Bd. 1879.
- J. T. Cuninghame.** *The renal organs (nephridia) of Patella.* Quart. Journ. Microsc. Science. Vol. XXIII. 1883.
- *Note on the structure and relations of the kidney in Aplysia.* Mith. Zool. Station in Neapel. 4 Bd. 1883.
- R. von Erlanger.** *On the paired Nephridia of the Prosobranchs, the homologies of the only remaining nephridium of most Prosobranchs, and the relations of the nephridia to the gonad and genital duct.* Quart. Journ. Microsc. Science. Vol. XXXIII. 1892.
- C. Grobben.** *Morpholog. Studien über den Harn- und Geschlechtsapparat, sowie die Leibeshöhle der Cephalopoden.* Arb. Zool. Inst. Wien. 5 Bd. 1884.
- *Ueber die pericardialdrüse der Lamellibranchiaten.* Ein Beitrag zur Kenntniss der Anatomie dieser Molluskenklassen. Arb. Zool. Inst. Wien. 7 Bd. 1888.
- *Die pericardialdrüsen der Gastropoden.* Arbeit. Zool. Inst. der Univ. Wien. 9 Bd. 1890.

- A. C. Haddon.** *On the generative and urinary ducts in Chiton.* *Proceed. Royal Dublin Soc.* (2). Vol. IV. 1885.
- B. Haller.** *Beiträge zur Kenntniss der Niere der Prosobranchier.* *Morph. Jahrb.* 11 Bd. 1885.
- A. Hancock.** *On the structure and homologies of the renal organ in the Molluscs.* *Trans. of the Linn. Soc.* Vol. XXIV.
- P. P. C. Hoek.** *Les organes de la génération de l'huître.* *Tijdschr. Nederl. Dierk. Vereen.* Suppl. D. 1. 1883.
- H. von Jhering.** *Ueber den uropneustischen Apparat der Heliceen.* *Zeitschr. f. wiss. Zool.* 41 Bd. 1884.
- J. Kollmann.** *Ueber Verbindungen zwischen Cölon und Nephridien.* *Baseler Festschrift zum Würtzburger Jubiläum.* 1882.
- A. Kowalevsky.** *Ein Beitrag zur Kenntniss der Excretionsorgane.* *Biol. Centralblatt.* 9 Bd. 1889.
- E. Ray Lankester.** *On the originally bilateral character of the renal organs of Prosobranchia, and on the homologies of the yolk sac of Cephalopoda.* *Ann. of Nat. Hist.* (5). Vol. VII. 1881.
- *Observations on the Pondsnail, etc.* *Quart. Journ. Micr. Science.* Vol. XIV. 1874.
- E. Ray Lankester and A. G. Bourne.** *On the existence of Spengel's olfactory organ and of paired genital ducts in the pearly Nautilus.* *Quart. Journ. Micr. Science.* Vol. XXIII. 1883.
- G. F. Mazarelli.** *Intorno all' anatomia dell' apparato riproduttore delle Aplysiæ del golfo di Napoli.* *Z. Anz.* 12 Bd. 1889.
- *Intorno all' apparato riproduttore di alcuni Tectibranchi (Pleurobranchæa, Oscanius, Acera).* *Zool. Anz.* 14 Jahrg. 1891.
- O. Nüsslin.** *Beiträge zur Anatomie und Physiologie der Pulmonaten.* *Habilitationschrift (Carlsruhe).* Tübingen, 1879.
- R. Owen.** *On the external and structural characters of the male Spirula australis.* *Proceed. Zool. Soc. London.* 1880.
- Rémy Perrier.** *Recherches sur l'anatomie et l'histologie du rein des Gastropodes prosobranches.* *Annales des Sciences Nat.* (7). Tome VIII. 1890.
- Walter Rankin.** *Ueber das Bojanus'sche Organ der Teichmuschel (Anodonta cygnea Lam.).* *Jenaische Zeitschr. für Naturwissensch.* 24 Bd. 1890.
- A. Schmidt.** *Der Geschlechtsapparat der Stylommatophoren, etc.* *Abh. des Nat. Vereins für Sachsen und Thüringen.* 1 Bd. 1885.
- P. Stepanoff.** *Ueber Geschlechtsorgane und Entwicklung von Ancyclus fluviatilis.* *St. Petersburg,* 1886.
- W. J. Vigelius.** *Bijdrage tot de Kennis van het excretorisch Systeem der Cephalopoden.* *Acad. Proefschrift.* Leiden, 1879.
- *Ueber das excretionssystem der Cephalopoden.* *Niederl. Arch. f. Zool.* 5 Bd. 1880.

Parasitic Gastropoda.

- Albert Bauer.** *Beiträge zur Naturgeschichte der Synapta. III. Die Eingeweideschnecke in der Leibeshöhle der Synapta digitata.* *Nova Acta Academ. Cæs. Leop.-Carol.* Tome XXXI. 1864.
- Max Braun.** *Ueber parasitische Schnecken. Zusammenfassender Bericht im Centralbl. f. Bakteriologie u. Parasitenkunde.* 5 Bd. 1889.
- Johannes Müller.** *Ueber Synapta digitata und die Erzeugung von Schnecken in Holothuriën.* Berlin, 1852.
- Paul and Fritz Sarasin.** *Ueber zwei parasitische Schnecken. Ergebn. Naturw. Forsch. auf Ceylon in 1884-1886.* 1 Bd. Wiesbaden, 1887.

- P. Schiemenz.** *Parasitische Schnecken. Kritisches Referat. Biol. Centralblatt.* 9 Bd. 1889-1890.
- Walter Voigt.** *Entocolax Ludwigi, ein neuer seltsamer Parasit aus einer Holothurie.* *Zeitschr. f. wiss. Zool.* 47 Bd. 1888.

Ontogeny.

- F. Blochmann.** *Ueber die Entwicklung von Neritina fluviatilis, Müll. Zeitschr. f. wiss. Zool.* 36 Bd. 1881.
- *Beiträge zur Kenntniss der Entwicklung der Gastropoden. Zeitschr. f. wiss. Zool.* 38 Bd. 1883.
- W. K. Brooks.** *The development of the Squid (Loligo Pealii, Lesueur). Annivers. Mem. Boston Soc. Nat. Hist. Boston, 1880.*
- R. von Erlanger.** *Zur Entwicklung von Paludina vivipara. I. and II. Morphologisches Jahrbuch von Gegenbauer.* 17 Bd. 1891.
- Hermann Fol.** *Études sur le développement des Mollusques. I. Sur le développement des Ptéropodes. Archives de Zool. expériment. Tome IV. 1875. II. Sur le développement embryonnaire et larvaire des Hétopodes. Tome V. 1876. III. Sur le développement des Gastropodes pulmones. Tome VIII. 1879-1880.*
- H. Grenacher.** *Zur Entwicklungsgeschichte der Cephalopoden, zugleich ein Beitrag zur Morphologie der höheren Mollusken. Zeitschr. f. wiss. Zool.* 24 Bd. 1874.
- A. C. Haddon.** *Notes on the development of Mollusca. Quart. Journ. Micr. Science.* Vol. XXII. 1882.
- B. Hatschek.** *Ueber Entwicklungsgeschichte von Tereido. Arb. a. d. Zool. Institut. Universität Wien. Tome III. Heft 1. 1880.*
- R. Horst.** *Embryogénie de l'huître. Tijdschr. Nederl. Dierk. Ver. Suppl. Deel. 1. 1884.*
- *Development of the European Oyster. Quart. Journ. Micr. Science.* Vol. XXII. 1882.
- A. Kolliker.** *Entwicklungsgeschichte der Cephalopoden. Zürich, 1884.*
- A. Kowalevsky.** *Étude sur l'embryogénie du Dentale. Annales du Musé d'histoire naturelle de Marseille. Zoologie. Tome I. 1883.*
- *Embryogénie du Chiton Polii (Philippi) avec quelques remarques sur le développement des autres Chitons. Ann. Mus. N. H. Marseille. Tome I. No. 5.*
- A. Krohn.** *Beiträge zur Entwicklungsgeschichte der Ptéropoden und Heteropoden. Leipzig, 1860.*
- E. Ray Lankester.** *On the developmental history of the Mollusca. Philos. Transact. London. 1875.*
- *Observations on the development of the Cephalopoda. Quart. Jour. Micr. Science.* Vol. XV. N.S. 1875.
- S. Lovén.** *Beiträge zur Kenntniss der Mollusca acephala lamellibranchiata. Stockholm, 1879.*
- J. Playfair MacMurrich.** *A contribution to the embryology of the prosobranch Gastropods. Stud. Biol. Lab. J. Hopkins Univ. Vol. III. 1886.*
- William Patten.** *The embryology of Patella. Arbeit. Zool. Inst. Wien. 6 Bd. 1885.*
- G. Pruvot.** *Sur le développement d'un Solénogastre. Comptes rend. Paris. Tome CXI. 1890.*
- Carl Rabl.** *Ueber die Entwicklung der Tellerschnecke. Morph. Jahrb. 5 Bd. 1879.*
- *Die Ontogenie der Süsswasserpulmonaten. Jenaische Zeitschrift. 9 Bd. 1875.*
- *Ueber die Entwicklungsgeschichte der Malermuschel. Jenaische Zeitschrift. 10 Bd. 1876.*

- W. Salensky.** *Études sur le développement du Vernet.* Arch. Biol. Tome VI. 1887.
- *Beiträge zur Entwicklungsgeschichte der Prosobranchierr.* Zeitschr. f. wiss. Zool. 22 Bd. 1872.
- P. B. Sarasin.** *Entwicklungsgeschichte der Bithynia tentaculata.* Arb. Zool-Zoot. Instit. Würzburg. 6 Bd. 1882.
- Paul and Fritz Sarasin.** *Aus der Entwicklungsgeschichte von Helix Waltonii.* *Ergebn. Nat. Forsch. Ceylon*, 1884-1886. 1 Bd. Wiesbaden, 1888.
- P. Schiemenz.** *Zusammenfassende Darstellung der Beobachtungen von Eisig, Rouzaul, Jourdain, Brock, etc., über die Entwicklung der Genitalorgane der Gastropoden.* Biol. Centralblatt. 7 Bd. 1888.
- C. Schierholz.** *Ueber Entwicklung der Unioniden.* Denkschr. Akad. Wien. 55 Bd. 1888.
- F. Schmidt.** *Beitrag zur Kenntniss der postembryonalen Entwicklung der Najaden.* Archiv. für Naturgeschichte. 51 Jahrg. 1885.
- M. Ussow.** *Untersuchungen über die Entwicklung der Cephalopoden.* Arch. Biol. Tome II. 1881.
- L. Vialleton.** *Recherches sur les première phases du développement de la Seiche.* *Annal. Sc. Nat.* (7). Tome VI. 1888.
- Wladimir Wolfson.** *Die embryonale Entwicklung des Lymnaeus stagnalis.* *Bull. Acad. Imp. Sc. St. Pétersbourg.* 26 Jahrg. 1880.
- H. E. Ziegler.** *Die Entwicklung von Cycas cornea, Lam.* Zeitschr. f. wiss. Zool. 41 Bd. 1885.

Appendage.

Rhodope Veranii.

This small animal (circ. 4 mm. in length) is long and spindle-shaped, and outwardly bilaterally symmetrical. The body epithelium is ciliated all over. There is a **dermo-muscular tube**, inside which, embedded in the connective tissue (parenchyma), are found numerous irregularly shaped calcareous particles.

Alimentary Canal.—The mouth lies at the anterior end of this canal, and leads into a wide buccal or oesophageal cavity, into the first part of which two acinose salivary glands open. A radula and jaws are wanting. A narrow oesophagus connects the oesophageal cavity with the tube-like mid-gut, which runs through the whole length of the body. The midgut possesses a well-developed muscular wall, and is continued anteriorly, above the point where the oesophagus enters it, in the form of a diverticulum, which runs forward over the brain. There is no separate digestive gland. The right side of the mid-gut gives rise to a short, thin, ciliated rectum, which runs through the posterior third of the body, and opens through the anus to the right.

The **nervous system** consists of two pairs of ganglia lying so close together above the oesophagus as almost to form one mass, and of one infra-oesophageal ganglion, which lies somewhat asymmetrically to the left. The two ganglia of each of the upper pairs are connected by **transverse commissures**, and the posterior dorsal pair with the lower ganglion by two **connectives** which embrace the oesophagus. Two lateral nerves which run backward are the most strongly developed. They arise out of the posterior upper pair of ganglia, close to which lie a pair of eyes and a pair of ciliated auditory vesicles, each of the latter containing an otolith.

Genital Organs.—Rhodope is hermaphrodite. The **gonads** consist of about 20 follicles which lie ventrally in the median and posterior thirds of the body; the anterior follicles produce eggs and the posterior spermatozoa. The ducts of all the

follicles are said to unite to form a common duct. If this is really the case, then the gonadial follicles together form a **hermaphrodite gland**. The hermaphrodite duct, which runs forward, is said to divide into an **oviduct** and a **vas deferens**. The latter leads to the muscular **penis**, which can be protruded from the **male genital aperture on the right anteriorly**. With the oviduct are connected a **receptaculum seminis** and a gland (albuminous or nidamental gland). The **female genital aperture** is said to lie on the right side, behind, and distinct from, the male aperture.

A differentiated blood vascular system has not been found. A well-developed body cavity is, however, present, filled with colourless nutritive fluid, in which blood corpuscles are suspended.

Special respiratory organs are wanting.

The nephridial system has been described as follows. To the right, in front of the anus, between the latter and the genital aperture, lies the **outer nephridial aperture**. It leads through a short ciliated canal into a spacious **renal chamber**, which is a widening of a longitudinal canal. The renal chamber bulges out at several points to form short cæca. Into this chamber nine or ten small flask-like organs open; these resemble the excretory ciliated cells of the *Platodes*, inasmuch as "flames"¹ arise at the base of each flask, the neck of which opens into the chamber.

Development is direct. At no stage are there any indications of a shell gland, a shell, or a foot.

Systematic Position.—*Rhodope* is by some classified among the *Turbellaria* (near the *Rhabdocælidæ*), by others among the *Mollusca* (near the *Nudibranchia*), while others again are inclined to see in it a transition form between these two phyla.

There is apparently only one single point to support the theory of the relation of *Rhodope* to the *Turbellaria*, viz. the presence of the ciliated excretory cells in the nephridial system. On the other hand, the derivation of the nephridial system of *Rhodope*, with its renal chamber and aperture to the right, from that of the *Nudibranchia* appears far more probable than its derivation from the water vascular system of the *Platodes*. The presence of a rectum and anus, and of an infra-oesophageal ganglion (pedal ganglion), is difficult to reconcile with a relationship to the *Turbellaria*. The occurrence of an infra-oesophageal commissure in one isolated case, that of *Microstoma lineare* (cf. vol. i. p. 166), is hardly a convincing argument. The genital apparatus of *Rhodope* is much nearer to the *Nudibranchiate* than to the *Turbellarian* type.

There are, no doubt, serious obstacles in the way of those who seek to establish the relationship of these animals with the *Mollusca*. The chief of these is the want of a heart and the entire absence of a shell and a foot, even in the embryo. The question to be decided is whether it would be possible for a *Mollusc* which had lost foot, gills, and shell (e.g. *Phyllirhoë*) by the further loss of the heart, so far to depart from the typical organisation of the *Mollusca*, that these organs would not appear, even temporarily, in the course of development. If this question is answered in the affirmative, then the asymmetry of *Rhodope*, and especially the position of the genital, nephridial, and anal apertures on the right side, which entirely agrees with their position in the *Nudibranchia*, affords strong support to its claim to be related with the *Mollusca*.

The view that *Rhodope* is a transition form between the *Turbellaria* and the *Mollusca* need hardly be treated seriously.

¹ Cf. vol. i. p. 152, where flame cells are described.

Literature.

- L. von Graff.** *Ueber Rhodope Veranii.* Koell. (= *Sidonia elegans*, M. Schulze). *Morph. Jahrbuch.* 8 Bd. 1883.
- A. Koelliker.** *Rhodope, nuovo genere di Gastropodi.* *Giornale dell' Istituto R. Lombardo di scienze e.c.* Tome 16. Milano, 1847.
- S. Trinchese.** *Nuovo osservazione sulla Rhodope Veranii.* Koell. *Rendic. dell' Accad. di Napoli.* 1887.

CHAPTER VIII

SEVENTH RACE OR PHYLUM OF THE ANIMAL KINGDOM

ECHINODERMATA.

THE Echinodermata are, as a rule, essentially radiate in structure. They, however, always deviate from strict radial symmetry in minor points, both in the skeletal system and in the arrangement of the inner organs; sometimes they may become almost bilaterally symmetrical. The Echinodermata possess a skeleton of calcareous matter deposited in the deeper connective tissue layers of the integument. This skeleton is in texture a fine rigid sponge-work. It consists either of microscopically small isolated calcareous bodies (*Holothurioidea*) or of larger plates which often carry spines, and are connected together either movably or immovably (other Echinoderms). The cœlom is spacious. There is a blood vascular system. The intestine, which is provided with a mouth and anus, is completely separated from the cœlom. The Echinodermata possess a peculiar system of canals or tubes—the water vascular system. This system, on the one hand, takes in water from the exterior through a stone canal (sometimes several such canals are present), which primitively opens outwards, and, on the other hand, sends out terminal canals to external extensible appendages arranged in the radii or ambulacra. These are the ambulacral feet or tentacles, which in free forms serve principally for locomotion, but also for respiration; in attached forms, for respiration, and also perhaps for conducting food. The sexes are almost always separate. Development is accompanied by metamorphosis. The larvæ are free-swimming and pelagic; they are bilaterally symmetrical, with ciliated bands, generally produced on processes. The Echinodermata are exclusively marine, and contain a great number of fossil forms; certain extinct types attained a great development during the palæozoic age.

The race of the Echinodermata is divided into five classes—*Holothurioidea*, *Echinoidea*, *Asteroidea*, *Ophiuroidea*, and *Pelmatozoa*.

Systematic Review.

CLASS I. Holothurioidea.

The body is elongated along its principal axis ; it is cylindrical or vermiform. It shows more or less distinct bilateral symmetry. The integument is soft or leathery, and contains irregularly arranged, generally microscopically small, calcareous bodies. The mouth lies at the oral (anterior) end of the principal axis of the body, and is surrounded by feelers. The anus lies at the apical (posterior) end of the principal axis. Ambulacral or tube-feet are either present or wanting. An external madreporite is usually not found.

ORDER 1. Actinopoda.

All the outer appendages of the water vascular system arise from the radial canals, and take the form of feelers round the mouth and of tube-feet (and ambulacral papillæ) in other parts of the body ; such feelers are always present, the feet and papillæ, however, may be wanting.

Family 1. Aspidochirotæ.

Tube-feet present. Mouth often more or less ventral in position. Body usually shows distinct flattening of the ventral surface. 18-30 peltate tentacles. Tentacular ampullæ well developed. Stone canals often numerous. Retractor muscles wanting. Respiratory trees present. Cuvier's organs often present. *Mülleria*, *Holothuria*, *Stichopus*.

Family 2. Elaspoda.

Tube-feet present. Mouth more or less ventral in position. Body almost always distinctly flattened on the ventral surface. 10, 15, or 20 tentacles, more or less peltate in shape. Stone canal always single, and not infrequently in direct communication with the exterior through the integument. Retractor muscles wanting. Respiratory trees wanting or quite rudimentary. Cuvier's organs wanting. Sub-fam. **Psychropotidæ**: *Psychropotes* (Fig. 223), *Benthodytes*. Sub-fam. **Deimatidæ**: *Deima*, *Pan-nychia*, *Laetmogone*. Sub-fam. **Elpidiidæ**: *Elpidia*, *Kolga*, *Peniagone*.

Family 3. Pelagothuriidæ.

Tube-feet wanting. Mouth and anus terminal. Body cylindrical ; round the crown of tentacles it widens out into a thin disc, the edge of which is produced into long rays. 13-16 tentacles. Retractor muscles wanting. Neither respiratory trees, nor ciliated organs, nor Cuvier's organs present. Calcareous bodies altogether wanting. Pelagic, swimming by means of the disc. Single genus and species: *Pelagothuria natatrix* (Figs. 224 and 225).

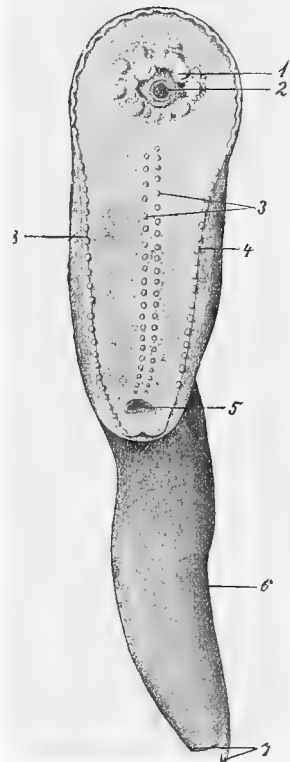

FIG. 223.—*Psychropotes longicauda* (after Théel). 1, Oral tentacle; 2, mouth; 3, 4, 8, ambulacral appendages of the (ventral) trivium; 5, anus; 6, dorsal appendage with its two posterior processes (7).

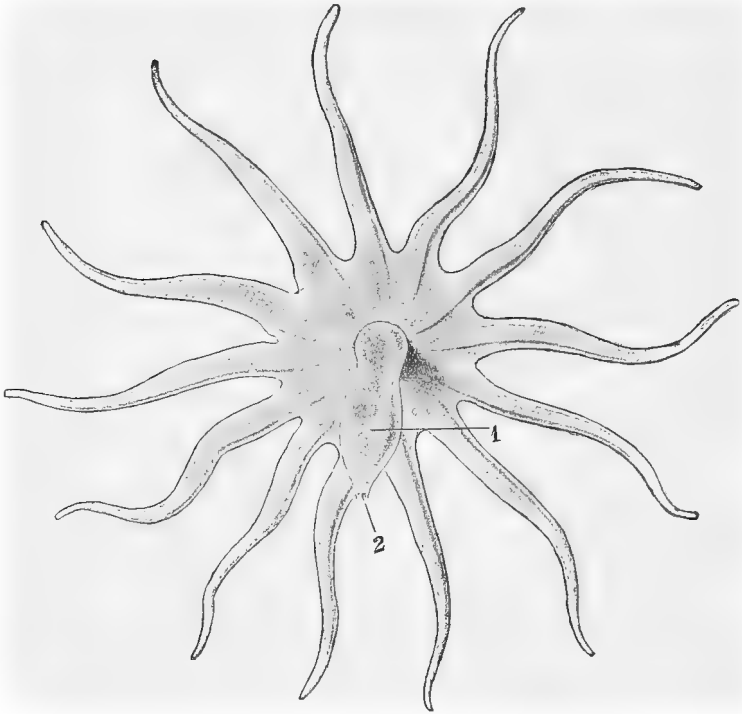

FIG. 224.—*Pelagothuria natatrix* (after Ludwig), completed; from above. 1, Body; 2, anus.

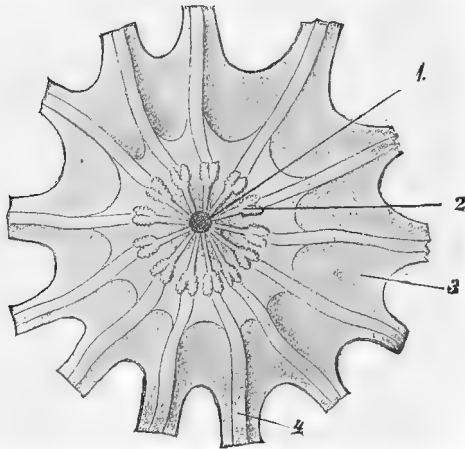

FIG. 225.—*Pelagothuria natatrix* (after Ludwig); front view, i.e. from the oral pole. 1, Mouth; 2, oral tentacles; 3, disc; 4, canals of the disc.

Family 4. *Dendrochirota*.

Tube-feet present. Mouth dorsal or terminal. Anus also often dorsal. Body cylindrical, or pentagonal, or with a distinctly marked creeping sole. 10-30 arbor-

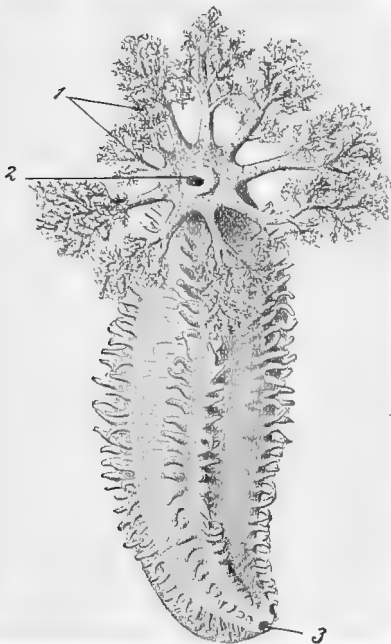

FIG. 226.—*Cucumaria planci* (original). 1, The two smaller ventral oral tentacles; 2, mouth; 3, anus.

escent tentacles, often of unequal size. Tentacular ampullæ not distinct. Not infrequently more than one stone canal. Retractor muscles well developed. Respiratory trees present; Cuvier's organs only occasionally found. *Cucumaria* (Fig. 226), *Thyone*, *Phyllophorus*, *Colochirus*, *Théelia*, *Psolus* (Figs. 227 and 228), *Rhopalodina*.

Family 5. *Molpadiidæ*.

Tube-feet wanting. Mouth terminal. The posterior end of the cylindrical body often narrowed to a shorter or longer tail-like piece, which is more or less distinct from the trunk. 15 tubular or digitate tentacles normally present. Tentacular ampullæ present. A single stone canal. Retractor muscles distinct only in the genus *Molpadia*. Respiratory trees present. Cuvier's organs almost always absent. *Molpadia*, *Caudina*, *Trochostoma*, *Ankyroderma*.



FIG. 227.—*Psolus ephippifer*, young female, from the dorsal side (after Théel). 1, Oral valves; 2, anus.

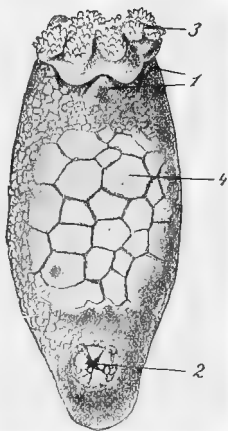

FIG. 228.—*Psolus ephippifer*, female, dorsal aspect (after Théel). 1, Oral valves, opened; 2, anus; 3, oral tentacles; 4, dorsal calcareous scales.

ORDER 2. Paractinopoda.

Only some of the outer appendages of the water vascular system arise from the radial canals, the rest from the circular canal, and the only form taken by them is that of tentacles round the mouth.

Family 1. Synaptidæ.

Tube-feet wanting. Mouth terminal. Body cylindrical, more or less elongated and vermiform. 10-27 feathered or digitate tentacles. Stone canals occasionally numerous. Retractor muscles sometimes present. Respiratory trees and Cuvier's organs wanting. Sexual glands often hermaphrodite. *Synapta* (Fig. 229), *Chirodota*, *Myriotrochus*.¹



FIG. 229.—*Synapta digitata* (original).

CLASS II. Echinoidea (Sea-urchins).

The body of these Echinoderms is covered by a usually firm but sometimes flexible test, which contains the cœlomic cavity and the viscera. The test varies in shape, from spherical to a form which is flatly compressed in the direction of the principal axis. It consists of numerous pentagonal or hexagonal closely contiguous plates, which, arranged in meridional rows, form five ambulacral and five interambulacral areas. It is covered by the outer layer of the integument, and carries spines articulating with it. At the apical pole there is a system of plates, consisting of five basal plates, five radials, and the anal plate. The mouth is usually in the middle of the oral surface, less frequently shifted towards the edge in what is called the anterior direction. An anus is always present, either at the apical pole or at some part of the posterior interambulacral area. The apertures of the madreporite lie in the apical system, generally in one of the basal plates; they are connected not only with the stone canal but with the so-called dorsal organ. The ambulacral vascular system has outer appendages developed as tube-feet and gills. Mouth with or without teeth. In the former case a complicated masticatory apparatus is developed within the test for the movement of the teeth; the muscles moving this apparatus are attached to a perignathous apophysial ring developed at the edge of the oral aperture of the test (*i.e.* round the peristome). Sexually separate or hermaphrodite. The genital ducts open externally through pores in the basal plates or outside these latter. Development direct (with care of the brood), or with metamorphosis (free-swimming larvæ).

SUB-CLASS 1. Palæchinoidea.

Either only one row or more than two rows of plates in each interambulacral area. Two or more meridional rows of plates in each ambulacral area. Plates of the test do or do not imbricate. Oral aperture of the test (with peristome) in the middle of the oral surface. Jaws

¹ The arrangement of the classes and families of the Holothuriodea by Ludwig in Bronn's *Klassen und Ordnungen des Thierreichs*, 1892, is here followed.

present. Anal area either within the apical system, or outside it, in the posterior interambulacral area. Palæozoic forms.

Order 1. *Bothriocidaroida*.

Regular Echinoidea, with a more or less spherical, firm test. In each inter-radius there is only one meridional row of plates; in each ambulacral area there are two. Anal area, with anus within the apical system. Mouth in the centre of the oral surface. *Bothriocidaris*.

Order 2. *Perischoëchinoida*.

Regular Echinoidea. More than two meridional rows of plates in each inter-radius. Two or many meridional rows in each radius. Test thick and rigid, or

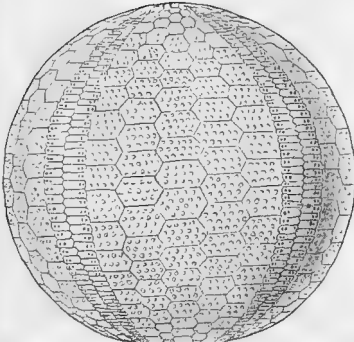

FIG. 230.—*Palæechinus elegans* M'Coy
(after Baily).

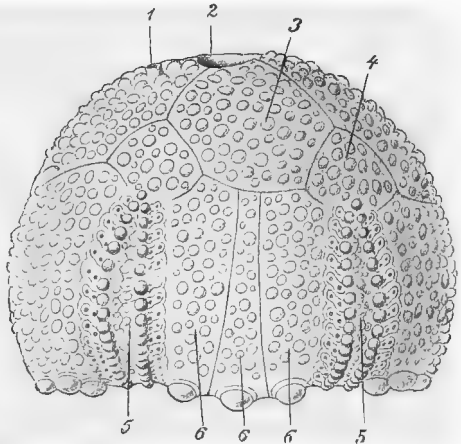

FIG. 231.—*Tiarechinus princeps* Laube (after Lovén).
1, Genital aperture; 2, anus; 3, basal; 4, radial; 5, ambulacrum; 6, the 3 upper plates of an interambulacrum.

thin; in this latter case more or less imbricated. Jaws present. Fam. *Archæocidaridæ*: *Lepidocentrus*, *Archæocidaris* (= *Echinocrinus*), *Palæechinus* (Fig. 230) Fam. *Melonitidæ*: *Melonites*.

Order 3. *Plesiocidaroida*.

Test small and rigid, almost hemispherical. Apical system very large, with large united basal plates and central anal area. Ambulacra narrow, with two meridional or vertical rows of plates. Interambulacra with one single peristome plate, followed by three plates separated by vertical sutures. *Tiarechinus* (Fig. 231).

Order 4. *Cystocidaroida*.

Test irregular (exocyclic), spherical or ovoid, thin and flexible. Madreporite central. Ambulacral areas narrow, with two vertical rows of plates. Interambulacral areas broad, with numerous vertical rows of scale-like movable plates. Anus in the posterior interambulacrum above the ambitus. *Echinocystis* (= *Cystocidaris*).

SUB-CLASS 2. **Euechinoidea.**

Echinoidea with two vertical rows of plates in each ambulacral and in each interambulacral area. Mouth on the oral side, rarely shifted towards the edge (anteriorly). Teeth and jaws present or wanting. Anus either within the apical system, or outside it, *i.e.* somewhere in the posterior interradius.

Order 1. **Cidaroida.**

Mouth central, anus within the apical system. No external gills. With jaws and almost perpendicularly placed teeth. Perignathous apophysial ring interrupted. Both the ambulacral and the interambulacral plates are continued over the peristome on to the oral area as far as the mouth. On the oral area they are imbricated. Ambulacra narrow. Large principal and small accessory spines. Sphæridia wanting. *Cidaris*.

Order 2. **Diadematoïda.**

Mouth central, anus within the apical system. So-called internal gills well developed, or rudimentary, or wanting. With external gills, and incisions in the peristome. With jaws and teeth. Perignathous circular apophysial ring closed. Only the ambulacral plates are continued over the peristome on to the oral area, where they often appear as separate buccal plates. Sphæridia present.

Sub-Order 1. **Streptosomata.**

Test more or less flexible, with inner dorso-ventral longitudinal muscles. Both external and internal gills present. The ambulacral plates (and only these) are continued over the peristome on to the oral area. Fam. **Echinothuridæ**: *Pelanechinus*, *Echinothuria*, *Phormosoma*, *Asthenosoma*.

Sub-Order 2. **Stereosomata.**

Test rigid, without internal longitudinal muscles. External gills present, internal gills rudimentary or wanting. The ambulacral plates on the oral area are replaced by isolated buccal plates. Fam. 1. **Saleniidæ**: *Peltastes*, *Salenia* (almost exclusively fossil). Fam. 2. **Hemicidaridæ**: *Hemicidaris*, *Acrocidaris*, *Gonioptygus*, etc. (fossil). Fam. 3. **Aspidodiadematoïdæ**: *Aspidodiadema*. Fam. 4. **Diadematoïdæ**: *Diadema*, *Diplopodia*, *Pedina*, *Echinothrix*, *Astropyga*, *Codechinus*, *Orthopsis*, *Peronia*, *Echinopsis*, etc. (fossil and extant). Fam. 5. **Cyphosomatidæ**, *Cyphosoma*, etc. (almost exclusively fossil). Fam. 6. **Arbaciidæ**: *Arbacia*, *Echinocidaris* (Fig. 232), *Cœlopleurus*, *Podocidaris* (extant and fossil). Fam. 7. **Temnopleuridæ**: *Glyphocyphus*, *Temnopleurus*, etc. (extant and fossil). Fam. 8. **Echinometridæ**: *Echinometra*, *Parasalenia*, etc., *Spongylocentrotus*, *Sphærechinus* (mostly extant). Fam. 9. **Echinidæ**: *Echinus*, *Toxopneustes*, *Triopneustes* (extant and fossil).

Order 3. **Holactypoida.**

Mouth central. Anus outside of the apical system in the posterior interradius (exocyclic). With external gills. Only one pair of pores or a single pore on each ambulacral plate. Jaws weak; teeth perpendicular; both jaws and teeth may be wanting. Sphæridia present. (a) Ambulacral apophyses present: *Holactypus*,

Pygaster, etc. (principally fossil). (b) Ambulacral apophyses rudimentary or wanting: *Discoidea*, *Conoclypeus* (fossil).

Order 4. Clypeastroida.

Mouth central or sub-central. Anus outside of the apical system in the posterior interambulacrum. With external gills. With tentacle pores in the interradial.

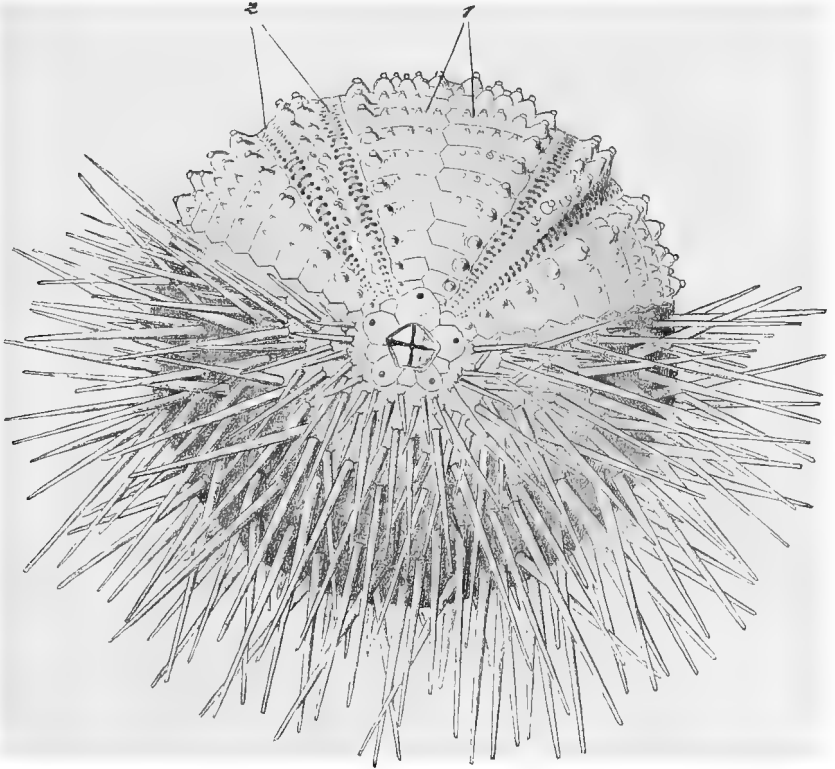

FIG. 232.—*Echinocidaris (Arbacia) pustulosa*, from the apical side (original). The spines have been removed from part of the shell. 1, Interambulacrum; 2, ambulacrum.

More than one pair of pores on each ambulacral plate. Tentacles differ in one and the same animal. Teeth usually almost horizontal, rarely vertical. The jaws lie above the apophysial ring, which is interrupted. Sphæridia present.

The test is seldom much arched; it is usually more or less flattened, and often even disc-like. It often has many incisions and perforations, and is usually bilaterally symmetrical. Its dorsal wall is connected internally with its ventral wall by means of pillars, needles, septa, etc. Basal plates of the apical system fused. The ambulacra form petaloids in the apical region.

Fam. 1. **Fibulariidae**: *Echinocyamus*, *Fibularia*, etc. (extant and fossil). Fam. 2. **Clypeastriidae**: *Clypeaster* (Fig. 233), etc. (extant and fossil). Fam. 3. **Laganidae**: *Laganum* (extant and fossil). Fam. 4. **Scutellidae**. In all the genera of this family

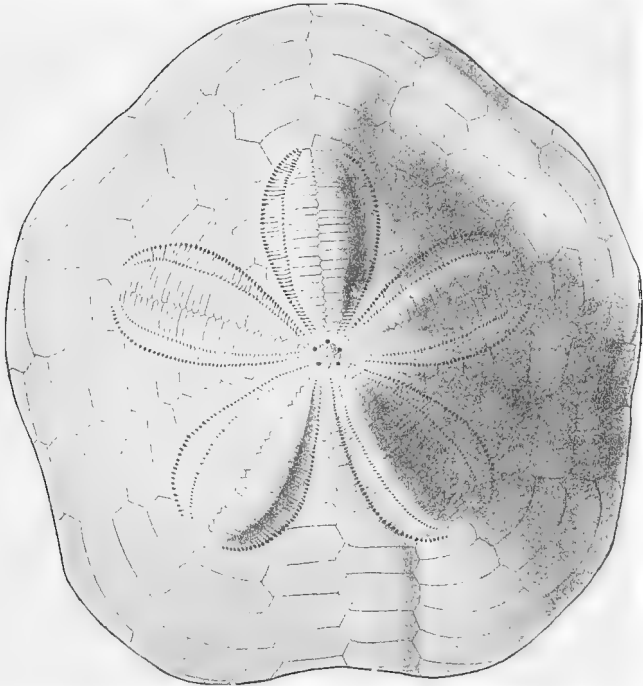

FIG. 233.—*Clypeaster* sp., test from the apical side (original).

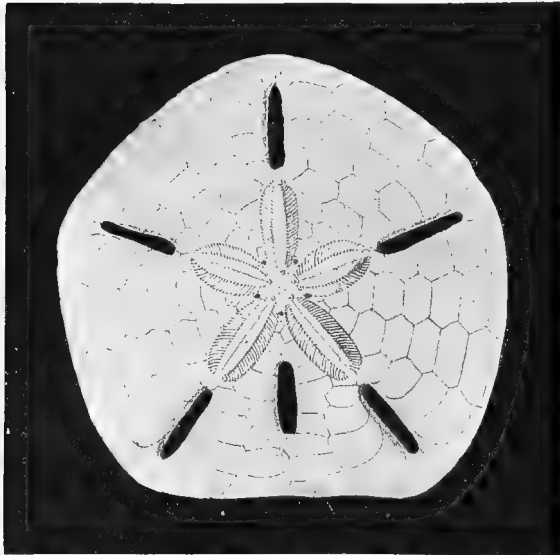

FIG. 234.—*Scutella sexforis*, test from the apical side (original).

the shell is very flat: *Scutella* (Fig. 234), *Echinodiscus*, *Encope*, *Mollita* (Fig. 235), *Rotula*, *Arachnoid's*, etc. (extant and fossil).

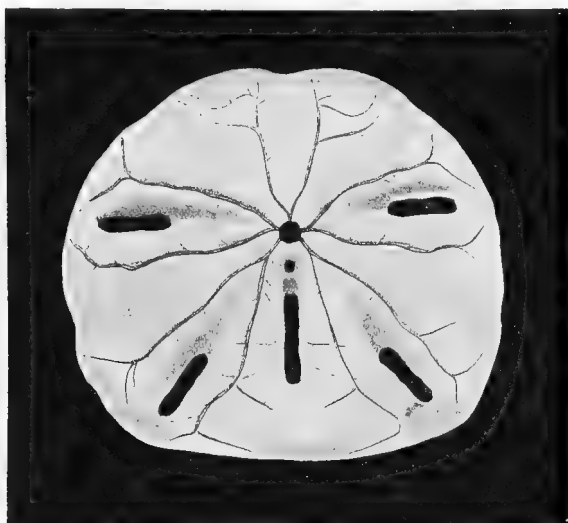

FIG. 235.—*Mollita testudinata?* from the oral side (original).

Order 5. **Spatangoida.**

Mouth central, sub-central, or on the anterior edge of the oral surface of the test. Anus outside the apical system, in the posterior interradius. External gills, jaws, teeth, and perignathous apophysial ring wanting. Sphaeridia present. The ambulacra generally form apical petaloids. The test is bilaterally symmetrical, arched, often heart-shaped.

Sub-Order 1. **Cassiduloidea.**

Fam. 1. **Echinoneidæ**: *Echinoconus*, *Echinoneus*, *Oligopygus*, *Echinobrissus*, etc. (extant and fossil). Fam. 2. **Cassidulidæ**: *Cassidulus*, *Catopygus*, *Clypeus*, *Pygurus*, *Echinolampas*, etc. (mostly fossil). Fam. 3. **Collyritidæ**: *Collyrites*, *Dysaster*, etc. (fossil). Fam. 4. **Plesiospatangidæ**: *Eolampas*, *Archiacia*, etc. (fossil).

Sub-Order 2. **Spatangoidea.**

Fam. 1. **Anan-chytidæ**: *Echinocorys*, *Holaster*, *Hemipneustes*, *Cardiaster*, *Urchinus*, *Cystechinus*, *Calymne*, etc. (the last three genera extant, the rest fossil). Fam. 2. **Spatangidæ**—Group 1, **Adetes**: *Isaster*, *Echinospatagus*, *Heterolampas*, *Hemipatagus*, etc. (almost exclusively fossil); Group 2, **Prymnodesmias**: *Hemiaster*, *Faorina*, *Linthia*, *Schizaster* (Fig. 236), *Agassizia* (extant and fossil); Group 3, **Prymnodesmia**: *Micraster*, *Brissus*, *Spatangomorpha*, *Brissopsis*, *Spatangus*, *Palaeopneustes* (Fig. 237), *Echinocardium*, *Lovenia*, etc. (extant and fossil); Group 4. **Apetala**: *Gonicopatagus*, *Palaeobrissus*, *Acete*, *Aerope*, etc. (extant and fossil).

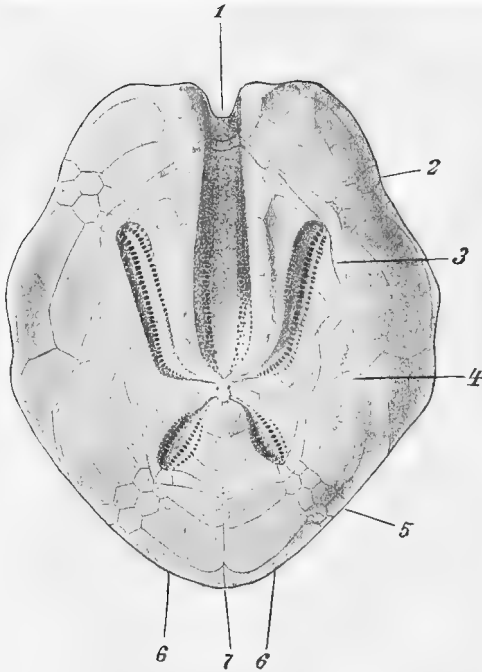

FIG. 236.—*Schizaster lacunosus*? from the apical side (original). The spines, and the protuberances on which they stand, are not depicted. 1, The anterior unpaired ambulacrum; 2, the right anterior ambulacrum; 3, fasciole; 4, the right posterior interambulacrum; 5, the right posterior ambulacrum; 6, the unpaired posterior interambulacrum; 7, anal region.

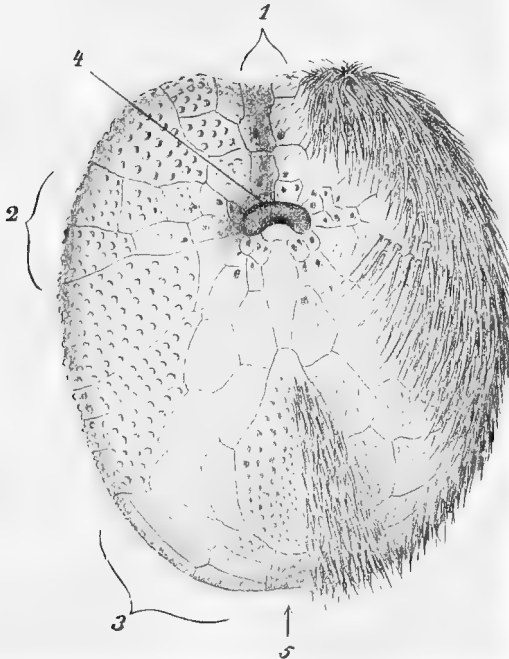

FIG. 237.—*Palæopneustes Murrayi* (after Agassiz), from the oral side. 1, The anterior ambulacrum; 2, 3, the anterior right and the posterior right ambulacra; 4, peristome; 5, anal region.

Fam. 3. *Leskiidæ*: *Palæostoma* (extant). Fam. 4. *Pourtalesiidæ*: *Pourtalesia* (Fig. 238), *Spatagocystis*, *Echinocrepis* (extant).¹

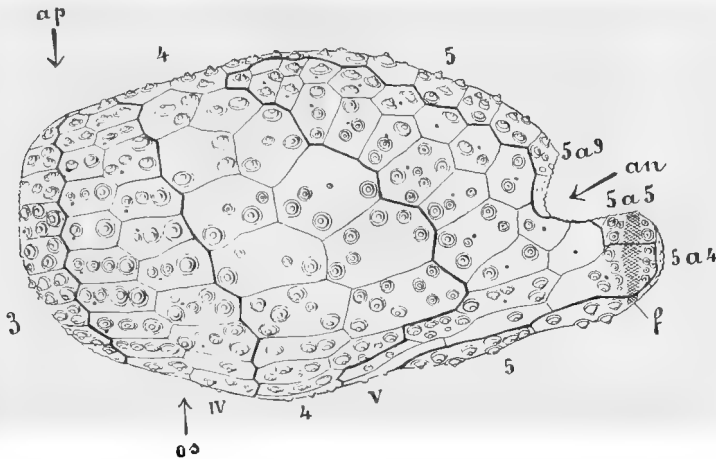

FIG. 238.—*Pourtalesia Jeffreysi*, from the side (after Lovén). The smaller tubercles are not depicted. *ap*, Apex; *os*, oral pole; *an*, anal region. The numbers are explained in the text, in the section on the perisomatic skeleton of the Echinoidea, p. 342.

CLASS III. Asteroidea (Stelleridea), Star-fish.

Echinodermata, with body flattened in the direction of the principal axis, the radii being produced laterally into longer or shorter arms. The arms are usually five in number, but their number may be increased to forty or more. They are not distinctly marked off from the central part of the body (the disc); and besides the radial blood vessels, nerves, and ambulacral vessels, diverticula of the intestine and continuations of the genital organs run into the coelomic cavities of the arms. The body is usually covered with calcareous plates, but is flexible. The calcareous plates carry spines, and often pedicellariæ as well. Along each arm runs a ventral furrow, within which there is a longitudinal row of paired ambulacral plates. The consecutive pairs are movably articulated with one another. Besides these, there are, on the arms, adambulacral, inframarginal, supramarginal, and dorsal plates. The ambulacral grooves run from the central mouth on to the arms, and along these on their oral (ventral) side, below the ambulacral plates, to their tips. The tube-feet (tentacles) rise from the base of this groove, to which they are limited. Anus apical (*i.e.* in the centre of the upper side), rarely wanting. Madreporite also on the apical side of the disc. The sexes are separate. Development is in most cases with metamorphosis (free-swimming pelagic larvæ); when the brood is protected development is direct.

SUB-CLASS 1. Palæasteroidea.

Palæozoic Asteroidea, in which the ambulacral plates in the two longitudinal rows in each arm, at least in the middle of the arm, are arranged alternately (not opposite or in pairs). *Aspidosoma*, *Palæaster*, *Palæocoona*, etc. (all Palæozoic forms).

¹ The classification of the Echinoidea here given is after Martin Duncan, *A Revision of the Genera and Great Groups of the Echinoidea*. London, 1889.

SUB-CLASS 2. **Euasteroidea.**

Asteroidea with paired, *i.e.* opposite ambulacral plates or "vertebre."

Order 1. **Phanerozonia.**

Asteroidea with large, strongly developed, marginal plates. The inframarginal and supramarginal plates are closely fitted together. Papulae (branchial vesicles) only occur on that surface of the body which is surrounded by the supramarginal

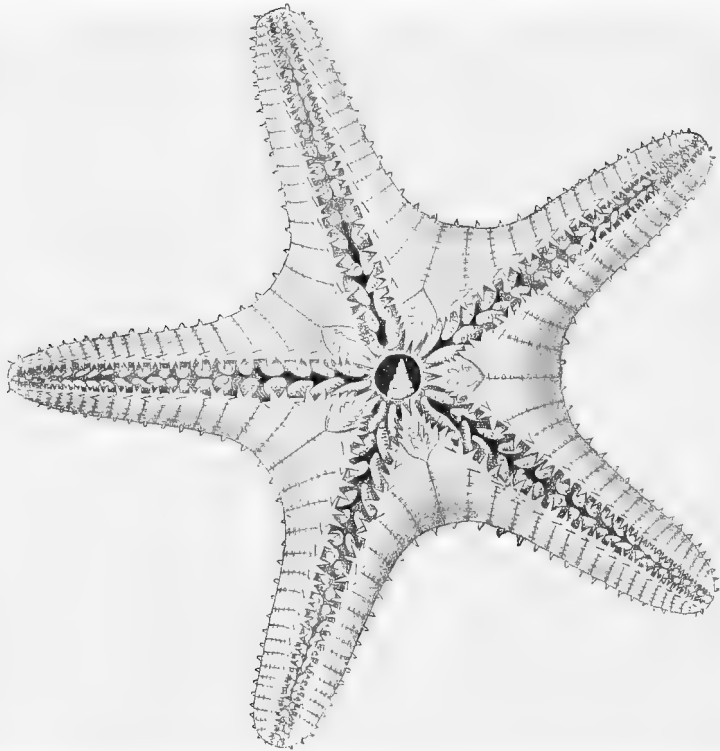

FIG. 239.—*Ctenodiscus procurator* (after Sladen), from the oral side. A Gastropod in the stomach is visible through the mouth.

plates, *i.e.* on the apical or upper side. Ambulacral plates broad. In each ambulacral furrow there are two longitudinal rows of tube-feet. The adambulacral plates are prominent in the oral skeleton. Where pedicellariæ occur they are sessile.

Fam. 1. **Archasteridæ**: *Pararchaster*, *Dytaster*, *Plutonaster*, *Pseudarchaster*, *Archaster*, etc. Fam. 2. **Porcellanasteridæ**, the centre of the apical system produced into a more or less long outgrowth: *Porcellanaster*, *Hyphalaster*, *Ctenodiscus* (Fig. 239), etc. Fam. 3. **Astropectinidæ**, without anus and usually without pedicellariæ: *Astropecten*, *Bathybiaster*, *Hyaster*, *Luidia*, etc. Fam. 4. **Pentagonasteridæ**: *Pentagonaster*, *Astrogonium*, *Nectria*, *Calliaster*, *Stellaster*, *Goniidiscus*, *Mimaster*, etc. Fam. 5. **Antheneidæ**: *Anthenea* (Fig. 240), *Goniaster*, etc. Fam. 6. **Pentacerotidæ**:

Pentaceros, *Amphiaster*, *Culcita*, *Asterodiscus*, etc. Fam. 7. **Gymnasteriida**: *Gymnasteria*, *Tylaster*, *Astropsis*, *Marginaster*, etc. Fam. 8. **Asterinida**: *Ganacia*, *Asterina*, *Palmipes*, etc.

Order 2. **Cryptozonia.**

Asteroidea, in which the marginal plates are indistinct and more or less rudimentary in the adult. The supramarginal plates are often separated from the inframarginal by intermediate plates. The papulae are not limited to the apical surface, but often occur also between the marginal plates and on the oral (lower)

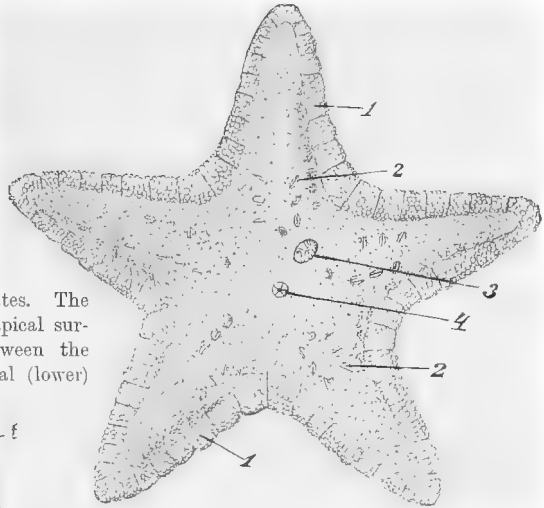

FIG. 240.—*Anthenea tuberculosa*, Gray? juv. (after Sladen). 1, Supramarginal plates; 2, pedicellariae; 3, madreporite; 4, anus.

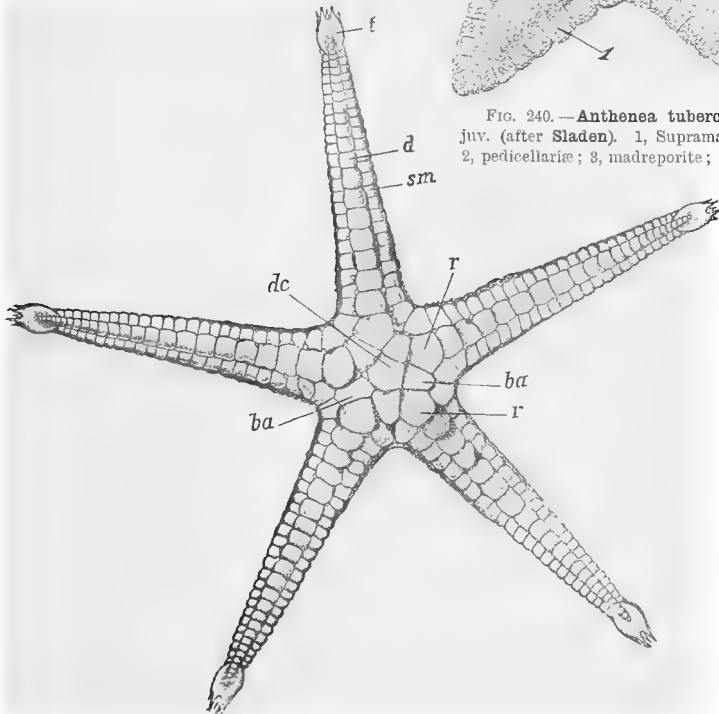

FIG. 241.—*Cnemidaster Wyvillii* (after Sladen). *dc*, Dorsocentral; *r*, radials; *ba*, basals; *sm*, supramarginals; *d*, dorsals; *t*, terminals.

surface of the body. Ambulacral plates narrow, closely crowded. Tube-feet often in four rows. In the oral skeleton the ambulacral or interambulacral plates are prominent. Pedicellariae sessile or pedunculate.

Fam. 1. **Linckiidæ**: *Chaetaster*, *Ophidiaster*, *Linckia*, *Metrodora*, etc. Fam. 2.

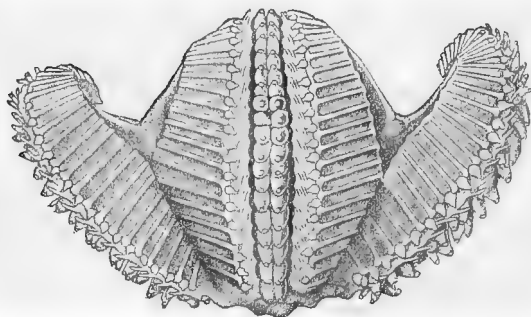

FIG. 242.—*Hymenaster cælatus* (after Sladen), with arms bent back.

Zoroasteridæ: *Zoroaster*, *Cnemidaster* (Fig. 241). Fam. 3. **Stichasteridæ**: *Stichaster*, etc. Fam. 4. **Solasteridæ**: *Solaster*, *Crossaster*, *Corethraster*, etc. Fam. 5.

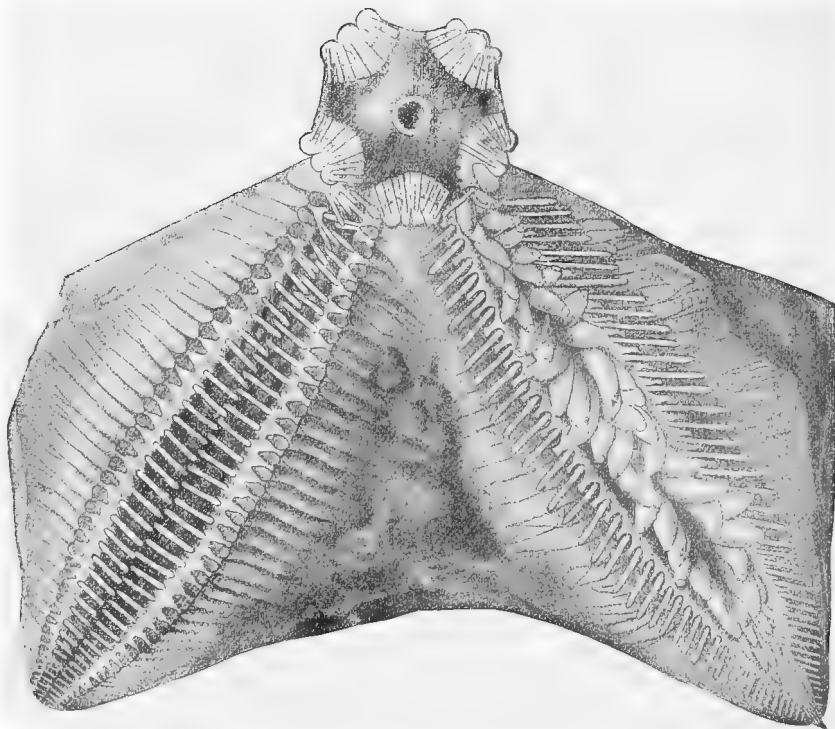

FIG. 243.—*Hymenaster nobilis* (after Sladen), from the oral side, $\frac{2}{3}$ natural size.

Pterasteridæ, with brood cavity on the apical side of the disc: *Pteraster*, *Retaster*, *Hymenaster* (Figs. 242 and 243), *Myxaster*, *Benthaster*, *Pythonaster*, etc. Fam. 6.

Echinasteridæ: *Acanthaster* (numerous arms), *Mithrodia*, *Cribrella*, *Echinaster*, *Valvaster*, etc. Fam. 7. **Heliasteridæ**, with numerous short arms: *Heliaster*. Fam. 8. **Pedicellasteridæ**: *Pedicellaster*. Fam. 9. **Asteriidæ**, tube-feet in four rows: *Asterias*, *Uniophora*, *Coronaster*, etc. Fam. 10. **Brisingidæ**, with numerous very long arms, marked off from the small disc: *Brisinga*, *Labidiaster*, etc.¹

CLASS IV. Ophiuroidea.

Echinodermata flattened in the direction of the principal axis of the body, the radii of which are produced into five long, round, simple or much branched slender arms. The arms are sharply marked off from the central part of the body, and do not contain either cæca of the intestine or extensions of the genital organs. The

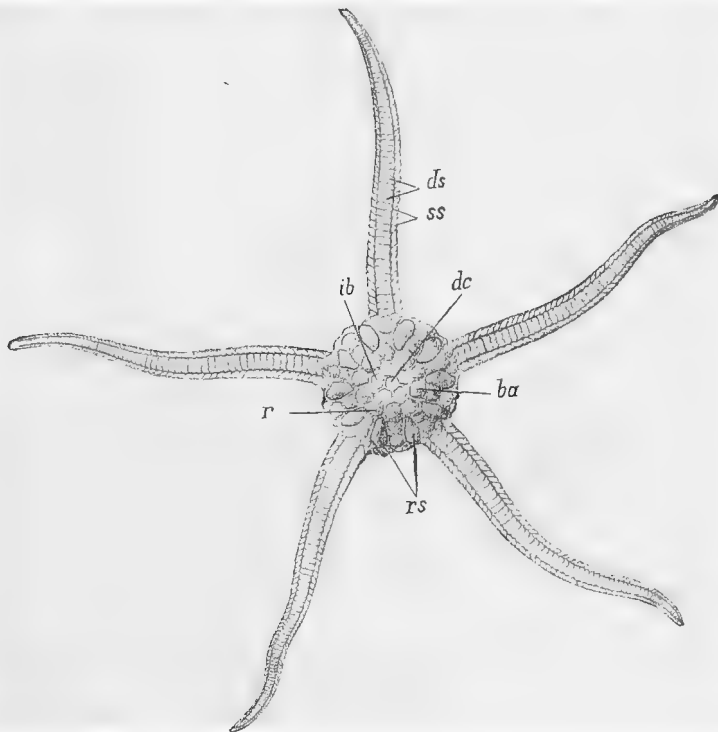

FIG. 244.—*Ophiolepis elegans*, Lütken (after Lyman). *ds*, Dorsal shields; *ss*, lateral shields; *dc*, dorsocentral; *ib*, infrabasal; *ba*, basal; *rs*, radial shields; *r*, radial.

axial part of the arms is occupied by a longitudinal row of vertebral ossicles, articulated together, and consisting of two fused lateral ambulacral plates or ossicles. The body is usually covered with calcareous plates. On the arms we can distinguish a longitudinal row of ventral shields on the oral side, two longitudinal rows of

¹ The classification of the two orders of the Euasteroidea is that of W. Percy Sladen, *Report on the Asteroidea collected by H. M. S. Challenger*. London, 1889.

lateral spine-bearing shields, and a longitudinal row of dorsal shields. On the apical surface of the disc larger radial shields are found at the sides of the bases of the arms: thus ten in all. On the oral side of the disc there are five interradial plates which are distinguished by their great size; these are the buccal shields. One of these plates is at the same time the madreporitic plate. Mouth at the centre of the lower side. Anus wanting. The ambulacral tube-feet appear on each side on the arms between the ventral and lateral shields. On the lower side of the disc, close to the bases of the arms laterally, there are in all ten or twenty slit-like apertures—the bursal apertures. These lead into blind sacs projecting into the cœlum; these are the burse, which serve for respiration and for the reception and ejection of the genital products. Development direct (viviparous and with care of the brood), or with metamorphosis (free-swimming pelagic larvæ).

Order 1. Ophiuræ.

Arms unbranched, movable in the horizontal plane, usually distinctly plated. Buccal shields, one of them at the same time the madreporitic plate, distinctly developed.

Fam. 1. **Ophioglyphidæ**: *Ophiura*, *Pectinura*, *Ophiolepis* (Fig. 244), *Ophiozona*, *Ophioglypha*, *Ophioceten*, *Ophiomusium*. Fam. 2. **Amphiuridæ**: *Ophiactis* (Fig. 245),

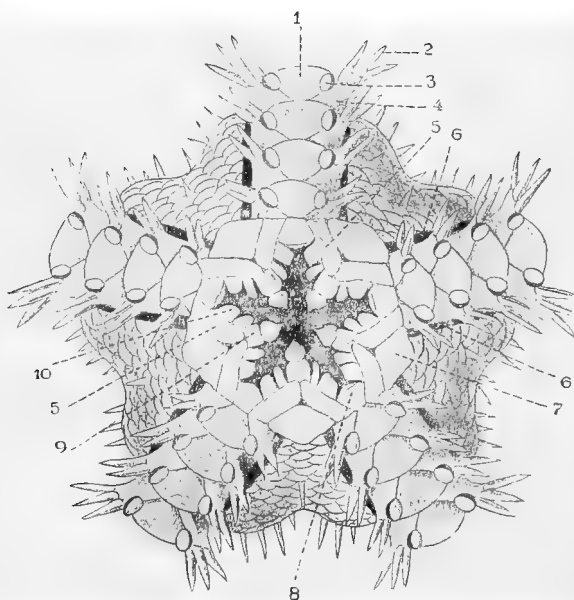

FIG. 245.—*Ophiactis poa*, Lym. (after Lyman). Disc and basal portions of the arms; from the oral side. 1, Ventral shields; 2, spines on the lateral shields (4); 3, tentacle scales; 5, lateral buccal shields; 6, bursal apertures; 7, buccal shields; 8, first ventral shield of the arm; 9, torus angularis; 10, oral papillae.

Amphiura, *Ophiocnida*, *Ophiocoma*, *Ophiacantha*, *Ophiothrix*. Fam. 3. **Ophiomyxidæ**, disc and arms covered by a thick naked integument: *Ophiomyxa*, *Hermi-curyale*.

Order 2. **Euryalæ.**

Arms simple or branched, can be rolled up vertically towards the mouth. Only rudimentary shields are found below the soft but thick outer integument. Without spines. In forms with unbranched arms there are usually 5 buccal shields, one of which is the madreporitic plate. Most of the forms with branched arms have no

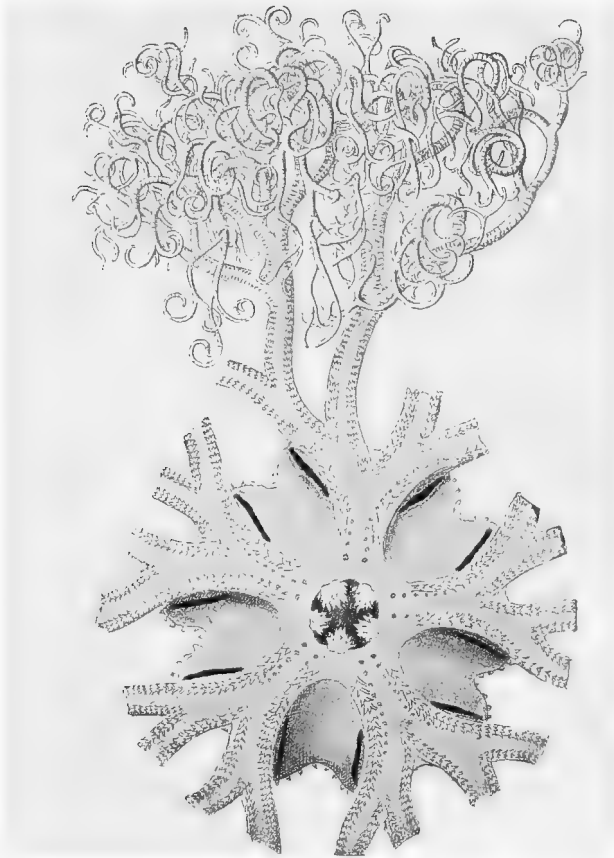

FIG. 246.—*Astrophyton Lincki* (Müller and Troschel), from the oral side (original).

distinct buccal plates. There is then either a single madreporite in an oral inter-brachial area or else there are 5 interbrachial madreporites.

Single Fam. **Astrophytidae**: *Astrophyton* (Fig. 246), *Gorgonocephalus*, *Euryalæ*, *Trichaster* (arms slightly and only at their tips, dichotomously branched), *Astroclon* (the same), *Astrocnida* (the same), *Astroporpa* (arms undivided), *Astrogomphus* (the same), *Astrochele* (the same), *Astrotoma* (the same), *Astrochema* (the same), *Ophiocreas* (the same), etc.¹

¹ For a more recent classification of Ophiuroidea, see F. J. Bell, *Proc. Zool. Soc. London*, 1892, pp. 175-183.

CLASS V. **Pelmatozoa.**

Echinodermata which are either permanently or temporarily¹ attached by the centre of the apical surface, so that the oral surface (with the mouth, as a rule, in its centre) looks upward. The body is usually raised upon a jointed stem attached to it at the apex. An axial canal, in which are blood vessels and nerves, runs through the stem. This stem is sometimes found only in the young, the body becoming detached later, and further in a few attached forms no stem at all is developed. The apical system of plates consists of 5 basals and 5 radials, to which 5 infra-basals and a varying number of interradials are often added. The plate in the embryo *Antedon*, which becomes fixed to the ground and is subsequently lost, is called "dorsocentral," and is supposed to belong to the apical system. The number of the principal rays is rarely 4 or 6. The plates just mentioned form a cup (dorsal cup), which either simply carries or else more or less completely encloses the visceral mass. The cup carries jointed appendages,—arms or pinnule or both.

The oral side (in these animals turned uppermost) is often provided with 5 oral plates, which surround or cover the central mouth, and it may further be protected in very various ways by radially and interradially situated plates (ambulacral, interambulacral, and oral), which together form the **tegmen calycis**. Or again this cover of the calyx may be either naked or set with very small isolated calcareous pieces. The anus lies usually at the end of a longer or shorter tube, excentrically in an interradius of the tegmen, occasionally, however, at the boundary between the cup and the tegmen. The circumoesophageal canal of the water vascular system does not communicate direct with the exterior. The radial canals of this system run into the arms. Each of the latter has a food groove on its oral (uppermost) side. The tube-feet, which rise from the edge of this furrow, are tentacular, and do not serve for locomotion, but for respiration, and possibly for conducting food. Development, so far as is known, with metamorphosis.

SUB-CLASS 1. **Crinoidea.**

Pelmatozoa with long usually branched arms. The arms are jointed, the consecutive ossicles being connected by muscles and bands. The arms can be expanded, and closed up together, or again can roll up orally. They may carry jointed, unbranched appendages, the pinnulæ, which are probably modified branches. The nervous system is generally said to be "double," *i.e.* there is an abactinal and an oral system. The abactinal nervous system consists of a central portion lying in the apex of the dorsal cup and of radiating strands which run through the skeletons of the stem, the arms, and the pinnulæ. The oral nervous system consists of a circumoral nerve ring, and radiating strands which run into the arms through the epithelium at the base of the food grooves, and which branch with the arms. The food grooves of the arms pass at their bases on to the tegmen, running in it to the central mouth. Ambulacral tentacles may be wanting. The circular canal of the water vascular system is connected with the body cavity by means of several stone canals, and the body cavity is in open communication with the exterior by means of water pores. The mouth is in the centre of the tegmen (*exc. Actinometra*). The sexual organs extend right into the basal parts of the arms, and even into their pinnulæ. In pinnulate crinoids, so far as is known, however, the genital products only ripen in the pinnulæ.

¹ There is, however, no evidence to show that *Marsupites* was attached even in the larval stage; unlike *Antedonidæ*, it has no trace of a stem.

The old division into *Palæocrinoides* and *Neocrinoides* seems artificial; that here adopted also cannot be considered as definitive.¹

Order 1. *Inadunata*.

Calyx comparatively small; dorsal cup with monocyclic or dicyclic base; the basals in the former, and infrabasals in the latter case may be fused to 4, 3, 2, or 1. The only other plates in the apical capsule are 5 radials. In the posterior interradius there are very often 1-3 asymmetrically placed anal plates, but no plates in the other interradia.

The tegmen calycis varies. In some *Inadunata* (*Larviformia*) there are 5 large oral plates, which, rising at the edge of the calyx directly above the radials, form a closed pyramid covering the food grooves of the disc, and the mouth. In many other forms the orals (which may be partly resorbed) lie at the centre of the tegmen calycis. The posterior oral plate is often larger than the others, and is shifted forward between them. The ambulacra appear at the surface of the tegmen calycis between the oral plates and the edge; they are bordered on each side by rows of small lateral pieces, the ambulacral groove being also roofed in by small covering pieces. Plates of various shapes, size, and arrangement are found in the interambulacral regions. In the posterior ambulacral region the tegmen calycis often bulges out in the form of a plated sac, the so-called ventral sac (*Fistulata*); this varies in form and size (sometimes reaching beyond the arms), and may sometimes have contained, besides the rectum, a large part of the body cavity. The anus lies at its tip or on its anterior side.

Arms free, *i.e.* not included in the dorsal cup (hence the name *Inadunata*), simple or branched, with or without pinnulæ. The food grooves of the arms are roofed in by two or more rows of alternating, wedge-shaped, interlocking, ambulacral plates; these plates could probably be erected.

Almost exclusively palæozoic forms.

A. *Monocyclica*.

With monocyclic basis (without infrabasals; several radials often horizontally

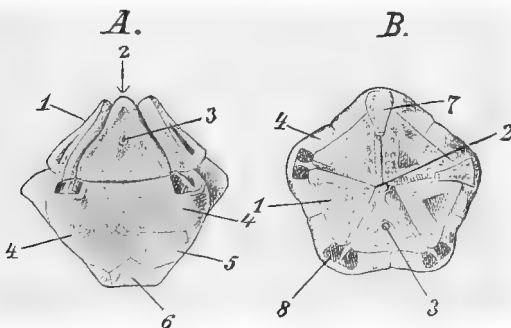

FIG. 247.—*Haplocrinus mespiliformis* (after Wachsmuth and Springer). **A**, from the oral side; **B**, from the oral side. 1, Orals; 2, oral pole; 3, anus; 4, radials; 5, right posterior infer-radial or radianal; 6, basals; 7, first brachial; 8, facet for attachment of the arm.

bisected). *Haplocrinus* (type of the so-called *Larviformia*, without anal plate) (Fig.

¹ Classification chiefly after the recent works of Wachsmuth and Springer and Herbert Carpenter. See *Bibliography*, p. 551.

247). *Heterocrinus*, *Hypocrinus*, *Calceocrinus*, *Catillocrinus*, *Pisocrinus*, *Hybocrinus*, *Ioerinus*, *Symbathocrinus*, *Belemnocrinus*, *Gastrocoma* (?), *Cupressocrinus*.

B. Dicyclica.

With dicyclic base (with infrabasals). Fam. **Dendrocrinidæ**: *Dendrocrinus*, *Homocrinus*, *Poteriocrinus*. Fam. **Decadocrinidæ**: *Botryocrinus*, *Barycrinus*,

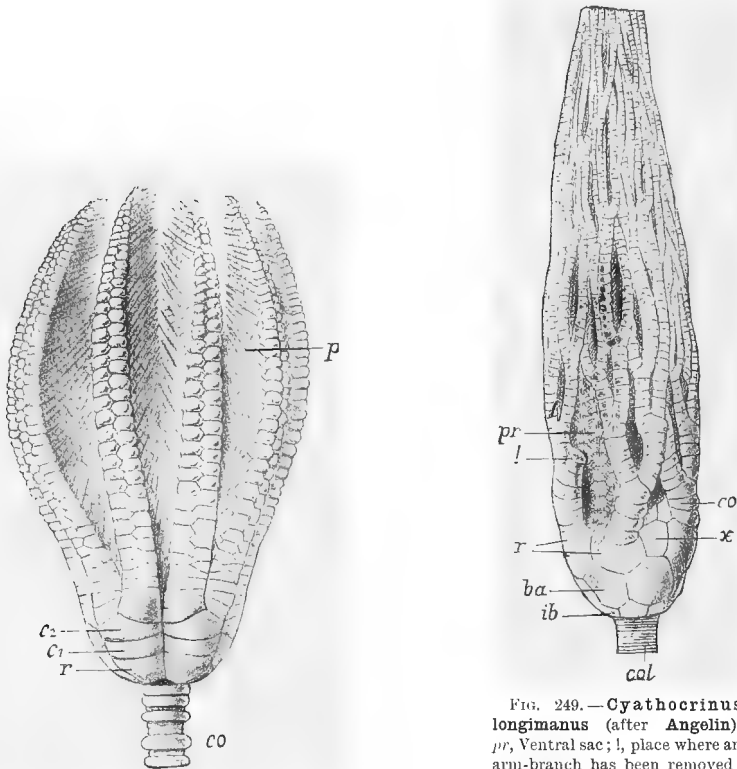

FIG. 248.—*Encrinurus liliiformis* (original).
 c_1 , c_2 , Costals or primibrachials; r , radials;
 co , stem; p , pinnule.

FIG. 249.—*Cyathocrinus longimanus* (after Angelin).
 pr , Ventral sac; l , place where an arm-branch has been removed;
 r , radials; ba , basals; ib , infrabasals; col , stem; x , anal plates;
 co , costals or primibrachials.

Atelestocrinus, *Decadocrinus*, *Graphiocrinus*, *Encrinurus* (Fig. 248), (without anal plates, ventral sac reduced to a short cone, Trias), *Cromyocrinus*, *Agassizocrinus*. Fam. **Cyathocrinidæ**: *Cyathocrinus* (Fig. 249), *Gissocrinus*, *Lecythocrinus*, *Hypocrinus*.

The genus *Marsupites* from the Chalk, and the following extant families are perhaps to be classed near the *Inadunata*; in these latter five large separate orals occur, the ventral sac being reduced to an anal tube, and no anals appearing in the dorsal cup. *Holopitæ* (Fig. 250) (Lias, to present time), *Hyocrinidæ* (Fig. 251) (Lias, present time), *Bathyerinidæ* (extant).



FIG. 250.—*Holopus Rangii* d'Orbigny, from the trivial side (after P. H. Carpenter).

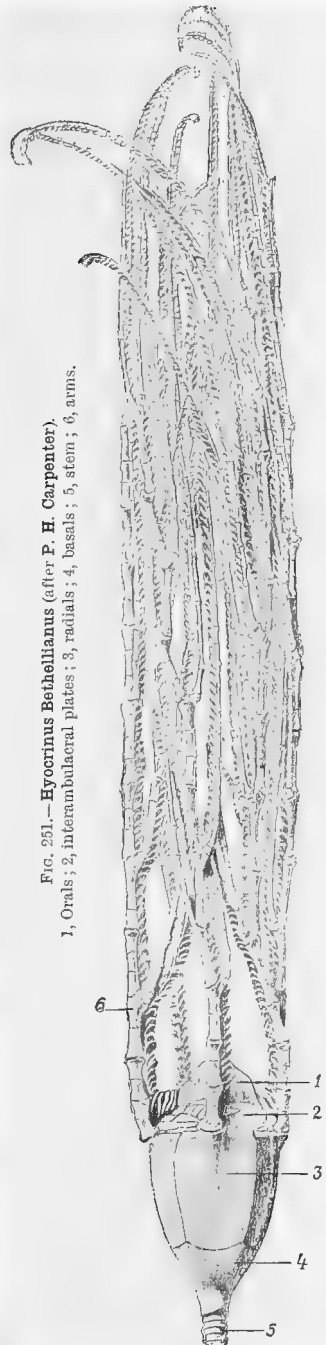

FIG. 251.—*Hyocrinus Bethelii* (after P. H. Carpenter).
1, Orals; 2, interambulacral plates; 3, radials; 4, basals; 5, stom; 6, arms.

Order 2. **Camerata.**

Plates of the calyx firmly connected by means of sutures. The apical capsule shows a tendency to develop a very rich system of plates, incorporating the proximal brachials to a greater or lesser extent. These brachials are connected together in the interradial by interradial plates, which vary in number, and to which, in the anal interradius, special anal plates may be added. In those cases in which the arms are incorporated in the calyx to such an extent that they branch in the latter before they become free from it, their branches may be connected by intercalated plates. Each of the five radials is usually followed by two brachial plates, formerly called 2nd and 3rd radials. The tegmen calycis is richly plated with firmly connected pieces, and is often much arched, forming a so-called vault. The mouth, which lies in the centre of the tegmen, is covered with five firmly united oral plates; the hindermost of these, which is often the largest, projects in between the four others. The ambulacra, with their lateral and covering plates, are mostly not visible from outside, as the interambulacral plates which border them laterally, and which are often very numerous, close together over them by means of processes, and thus cover them externally. The ambulacra, in their course on to the bases of the free arms, divide as many times as the arms have already divided on the dorsal cup. The interradials of the dorsal cup often pass, without any sharp boundary, into the interradially arranged interambulacral plates of the tegmen calycis. The subcentral (less frequently central) anus, which is surrounded by firm anal plates, is either sessile or else comes to lie at the tip of a chimney-like prolongation of the tegmen; this anal tube, formerly thought to be a proboscis, may project beyond the arms. Arms branched; in adults, almost without exception, the brachials become arranged in a double row with primitive articulation, and pinnules closely folded together. Dorsal canals (in the brachials) have never been observed. Exclusively palæozoic forms.

Family 1. **Reteocrinidæ.**

Apical capsule, with monocyclic or dicyclic base. Four or five basals. Interradial and interaxillary regions deeply sunk, plated with a large number of irregular immovable pieces, which are continued on to the interambulacral areas of the tegmen calycis. Posterior interradial region broader, and divided by a perpendicular row of somewhat large anal plates. Anus subcentral. Arms composed of a single row of calcareous joints. Pinnules strong. *Reteocrinus*, *Xenocrinus*.

Family 2. **Rhodocrinidæ.**

Apical capsule with dicyclic base. The circle of the five radials interrupted by that of the five first interradials, which are in direct contact with the basals. Interradial area plated with regular definitely arranged pieces. Posterior interradial area differs but slightly. Tegmen calycis thickly plated. The plating of the apical interradial region passes without break into that of the tegmen calycis. Ambulacra not externally visible. Orals often indistinct. Anus subcentral. *Rhodocrinus*, *Gilbertocrinus*, *Rhipidocrinus*.

Family 3. **Glyptasteridæ.**

Base dicyclic. With the exception of the first anal plate, which is in contact with the posterior basal, the interradials do not touch the basals. Interradial region of the apical capsule and tegmen calycis as in the *Rhodocrinidæ*. Oral plates distinct. Anus subcentral. *Glyptaster*.

Family 4. *Melocrinidæ*.

Base monocyclic, 3-5 basals. The basals in contact only with the radials. Interradial areas of the apical capsule with numerous large regularly arranged plates. Plates of the tegmen calycis often small and regular. Orals distinct. Anus subcentral. *Melocrinus* (Fig. 252), *Mariacrinus*, *Glyptocrinus*, *Stelidiocrinus*.

Family 5. *Actinocrinidæ*.

Base monocyclic, 3, rarely 4, basals. The first anal plate rests upon the circle of basals; the first interradials otherwise being in contact only with the circle of

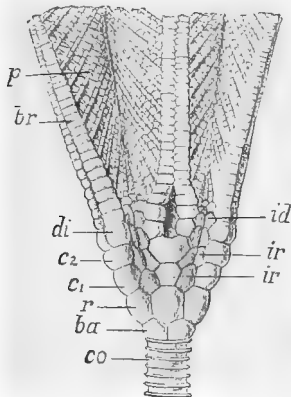

FIG. 252.—*Melocrinus typus*, Br. *p*, Pinnulæ; *br*, arms; *di*, distichals; *c*₁, *c*₂, first and second costal; *r*, radial; *ba*, basal; *co*, stem; *ir* and *id*, interradials.

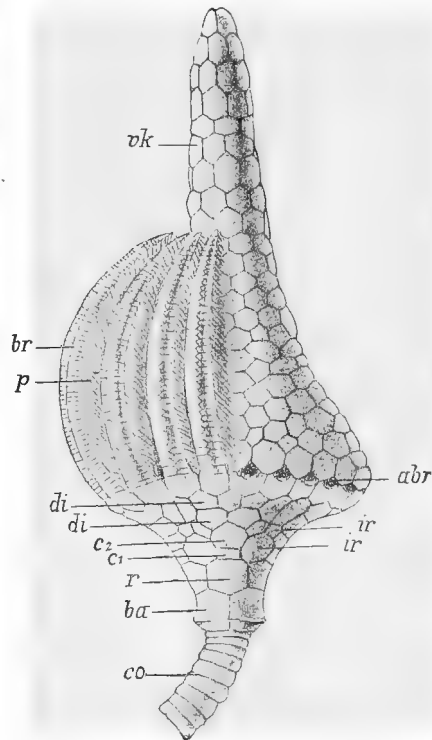

FIG. 253.—*Batocrinus pyriformis*, Shum. (after Meek and Worthen). *vk*, Ventral capsule; *br*, arms; *p*, pinnulæ; *di*, distichals; *c*₁, *c*₂, costals; *r*, radials; *ba*, basals; *co*, stem; *ir*, interradials; *abr*, points of insertion of the arms.

radials. Tegmen calycis usually much arched, consisting of numerous firmly connected plates, some of which at least are large, arranged in definite order. The ambulacra of the tegmen calycis with their skeleton hidden, or only visible in forms with flat tegmina. Anus subcentral. Orals usually distinct. *Carpocrinus*, *Agaricocrinus*, *Periechocrinus*, *Megistocrinus*, *Actinocrinus*, *Teleocrinus*, *Steganocrinus*, *Amphoracrinus*, *Physetocrinus*, *Strotocrinus*, *Batocrinus* (Fig. 253), *Eretmocrinus*, *Dorycrinus*.

Family 6. *Platycrinidæ*.

Base monocyclic, 3 basals, which are unequal. Anal and interradial plates not in contact with the basals. The very large radials together with the basals form

almost the whole of the apical capsule. Each radial is connected with a short and small costal plate. The various brachials which follow (distichals, palmars, etc.)

are free, *i.e.* belong to the freely outstanding arms. In each interradius there are at least three interradials, which, however, appear more or less shifted on to the oral side. In the proximal (apical) interradial ring there are no special anal plates, this ring consisting in each interradius of 3-5 transversely placed plates, the central one being the largest. Orals large. Tegmen calycis mostly much arched. The ambulacra and their covering plates often appear at the surface. Anus subcentral. *Platyercinus* (Fig. 254), *Mursupiocrinus*, *Eucladocrinus*.

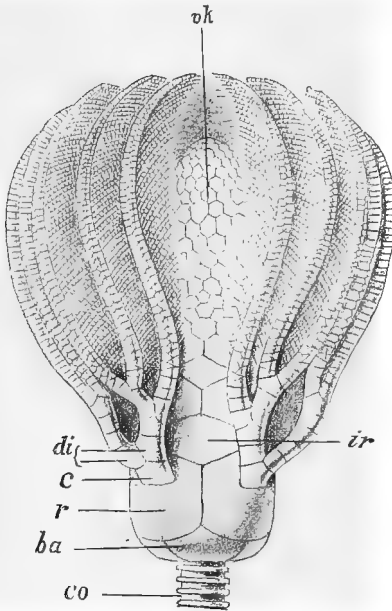

FIG. 254.—*Platyercinus triacontadactylus* (after M'Coy). *di*, Distichals; *c*, costals; *r*, radial; *ba*, basal; *co*, stem; *ir*, interradials; *vk*, ventral capsule.

Family 7. *Crotalocrinidæ*.¹

Base dicyclic. The apical capsule consists exclusively of the typical plates of the apical system (infrabasals, basals, and radials), to which is added an anal plate. The brachials of the separate rays (to the fourth order) firmly united by sutures. Arms very mobile, uniserial, long and much branched; branches free or connected together in such a way as to form a network around the calyx; this network is either continuous or else divided into

five leaf-like lobes corresponding with the rays. Arms and their branches traversed by large axial canals. Tegmen calycis flat, richly plated with distinct orals, interradials, and anals; ambulacra externally visible, with large rigid covering plates, which combine with the other plates to form the solid tegmen. Anus subcentral.

(This family is distinguished from all other Camerata by the presence of axial canals, and by the mobility of the free joints of the arms.) *Crotalocrinus*, *Enalloocrinus*.

Family 8. *Hexacrinidæ*.

Base monocyclic. 2 or 3 basals. The first anal plate rests on the circle of basals, and resembles the radials in shape. In other respects like the *Platyercinidæ*. *Hexacrinus*, *Talarocrinus*, *Dichoecrinus*.

Family 9. *Acrocrinidæ*.

Base monocyclic. 2 basals, separated from the radials by a broad zone of small plates arranged in circles round the basals; these form the largest part of the apical capsule. Each radial is followed by 2 costals. The radials and

¹ This family, originally placed near *Cyathocrinus*, was referred by Wachsmuth and Springer, first to the *Ichthyocrinoidæ* and then to the *Camerata*; Bather, however, would refer it to its original position in the *Inadunata*.

costals of the 5 rays laterally distinct. Interradials in two circles; in the first circle there are two plates to each interradius, and in the second circle only one, which, however, is larger than the former two. Posterior interradius much larger, with twice as many interradials, between which there is, further, an intercalated vertical row of anal plates. *Aerocrinus*.

Family 10. *Barrandeocrinidæ*.

Base monocyclic. 3 basals. The first anal plate rests on the circle of basals. The interradials rest upon the sloping oral ends of the radials. Arms bent back on the calyx, fusing laterally with one another by means of their pinnulæ in such a way as to form a firm envelope around the calyx. *Barrandeocrinus*.

Family 11. *Eucalyptocrinidæ*.

Base monocyclic. The apical capsule consists of 4 basals, 5 radials, 2×5 costals, 2×10 distichals, 3×5 interradials, and 1×5 interbrachials. No anal plates. The tegmen calycis consists of 5 large interradials, 5 large and 10 small interbrachials, the oral plates, and two other plates lying further up towards the apex. Anus shifted quite to the centre. The plates of the tegmen form 10 niches; in the bases of these niches ambulacral grooves (two in each) run to the bases of the 10 pairs of arm-branches, which are received into the niches. *Eucalyptocrinus*. *Callicrinus*.

Order 3. *Articulata* (*Ichthyocrinidæ*).

Skeleton flexible. Anal plates often occur in the posterior interradius of the calyx. Base dicyclic. Three infrabasals of unequal size, which are usually hidden by the uppermost joint of the stem. Radials perforated, with one or more primary brachials. The circle of the combined radials and primary brachials is closed, or else interrupted by one or more plates in each interradius. The brachials of the first, second, and often also of the third order are incorporated in the calyx. The radials and the separate brachials are articulated together. Arms uniserial. Pinnulæ appear to be wanting. Interradials irregular and varying in shape, size, and arrangement, inconstant (may be either present or wanting in one and the same species). In the posterior interradius there is often one asymmetrical plate. Tegmen calycis only known in a few forms, soft and flexible, the plates lying in it not being firmly fused together. Five separate orals of unequal size grouped round the open mouth, the posterior oral being the largest. Ambulacra with their covering plates appear at the surface. Between them, there are interambulacral plates which are occasionally distinguished by their remarkable size. Interambulacral areas often sunk. Food grooves of the arms enclosed by movable covering plates. A plated process (anal tube with anus?) is found excentrically in the posterior interradius of the tegmen.

Fam. *Ichthyocrinidæ*—Palæozoic forms: *Ichthyocrinus*, *Forbesiocrinus*, *Cleio-crinus*, *Taxocrinus* (Fig. 255), etc.

The unstalked genus *Uintacrinus*, from the upper Chalk, and the extant unstalked genus *Thaumacrinus* (Fig. 256), ought probably to be classed here. In the latter the uppermost ossicle of the stem is retained as centrodorsal. The dorsal cup consists, apart from the centrodorsal, of 5 basals, 5 radials, and 5 interradials, which last rest on the circle of basals, and alternate with the radials. Tegmen with central open mouth, which is protected by a pyramid of 5 large separate orals. Between the orals and the edge of the calyx (or the oral edge of the interradials of the dorsal cup) the tegmen is covered with small irregular plates

indistinctly arranged in two to three rows. The anal interradiar carries a short

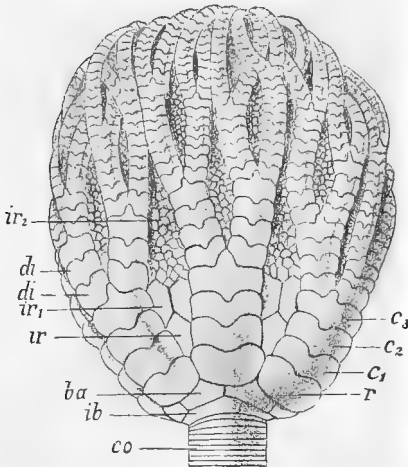

FIG. 255.—*Taxocrinus multibrachiatus*, Ly. and Cass. *ir*, *ir₁*, and *ir₂*, Interradials; *di*, distichals; *ba*, basals; *ib*, infrabasals; *co*, stem; *r*, radials; *c₁*, *c₂*, and *c₃*, primary brachials.

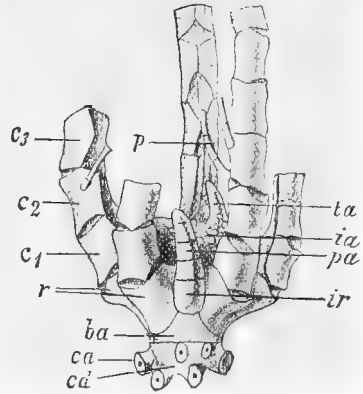

FIG. 256.—*Thaumatoocrinus renovatus*, P. H. C. (after P. H. Carpenter). Calyx from the anal side. *c₁*, *c₂*, and *c₃*, Primary brachials; *r*, radials; *ca*, points of insertion of the cirri; *cd*, centrodorsal; *ir*, interradians; *ia*, interradialia analia; *pa*, procesus analis; *ta*, tubus analis; *p*, pinnulae.

jointed appendage. Besides this there is a short anal tube. Five unbranched arms with pinnulae.

Order 4. Canaliculata.

Calyx symmetrically five-rayed. Base dicyclic, the infrabasals usually not separate, but atrophied or fused with the proximal columnal 5 basals, occasionally not externally visible. Each radial is followed by 2 costals. Anal plates always wanting (hence the regularity of the calyx). Interradials with few exceptions wanting. Arms simple or divided (one to ten times). Tegmen calycis usually flat, with open mouth and ambulacra appearing at the surface. Orals rarely present. Tegmen calycis often plated with small loose-lying plates. Stem present either only in young forms or also in adults. Basals and radials perforated by dorsal canals. To this order belong, besides Mesozoic and Tertiary forms, most of the extant Crinoids.

Family 1. Apiocrinidæ.

Calyx consists of 5 basals of equal size, 5 radials and 2×5 primary brachials. Distichals may also take part in its formation. Interbrachials and interdistichals may occur. Tegmen flexible, with small plates. Arms more or less branched, consisting of a single row of joints. Stem without cirri, usually expanding in its proximal region to the same width as the calyx, but *not* containing the viscera. Jurassic, to present. *Apiocrinus*, *Millerocrinus*, and the extant *Calamocrinus*.

Family 2. Bourgueticrinidæ.

Calyx consists of 5 basals and 5 radials. Brachials connected in pairs by syzygial sutures. Five orals in the tegmen calycis. Interambulacral region otherwise not plated. Ambulacra with covering plates, but without lateral plates. Stem,

with root-like processes at its base, or with irregularly arranged cirri; its proximal

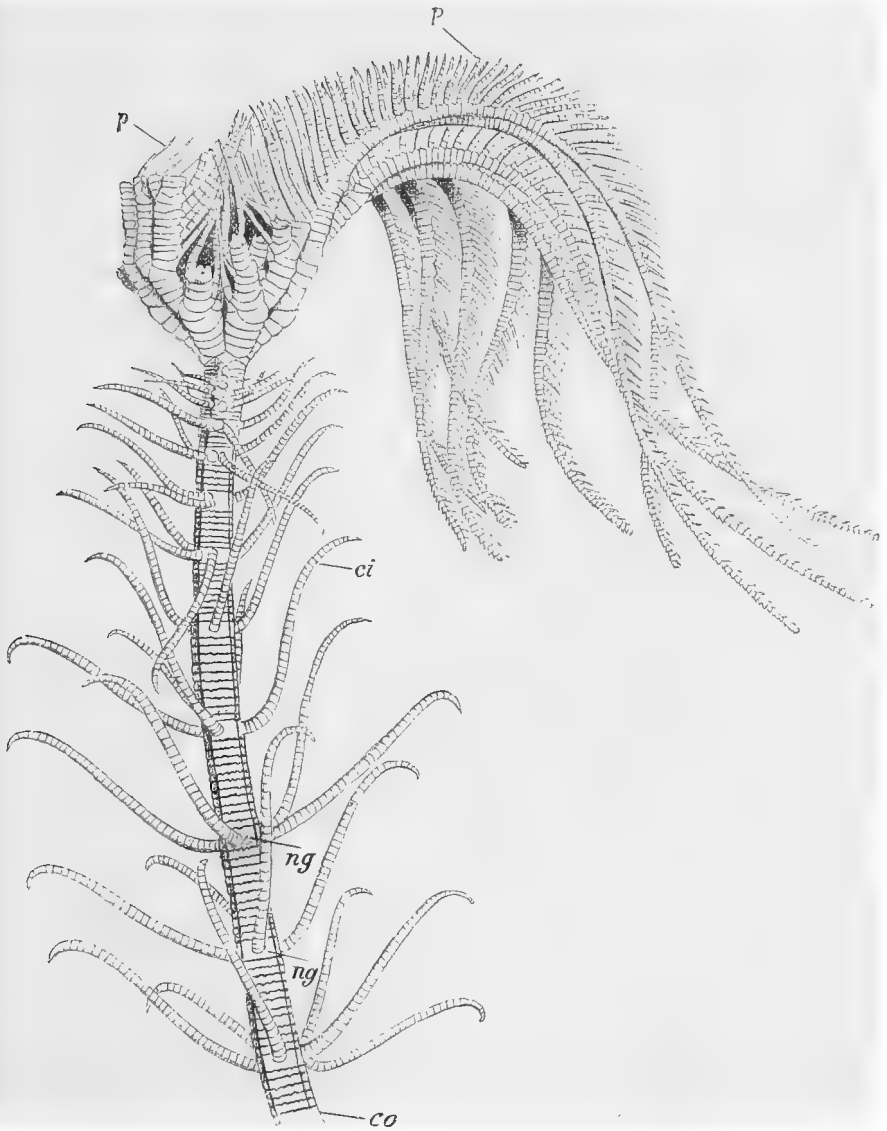

FIG. 257.—*Metacrinus Murrayi* (after P. H. Carpenter). Most of the arms and the larger part of the stem broken off. *p*, Pinnulæ; *ci*, cirri; *ng*, node.

ossicle usually enlarged. Upper Jurassic, Chalk, Tertiary, Recent. *Rhizocrinus*, *Bourgueticrinus*.



FIG. 258.—*Antedon incisa* (after P. H. Carpenter). 1. Arms; 2. cirri.

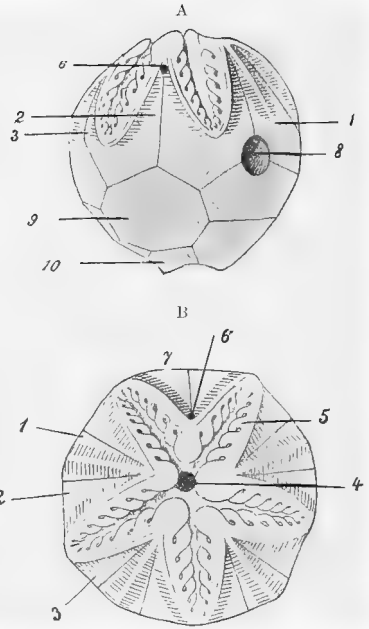

FIG. 259. A, *Cystoblastus Leuchtenbergi*. 1, Interradial; 2, 3, radial; 9, basal; 10, infra-basal; 8, anus; 6, genital aperture. B, From the oral side (after Volborth). 4, Mouth; 5, ambulacrum. Fig. 295, p. 332, shows the apical side.

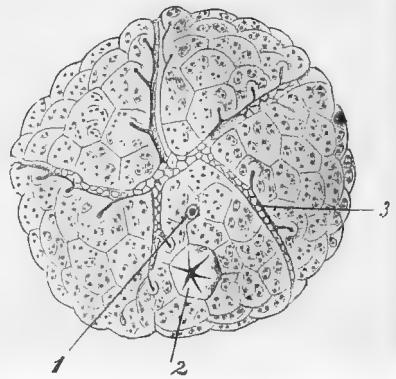

FIG. 260.—*Protoerinus oviformis*, Eichwald (after Volborth). 2, Anus; 1, third aperture; 3, ambulacrum.

Family 3. **Pentacrinidæ.**

Calyx small as compared with the stem and the arms; it consists of 5 basals and 5 radials. (In the genus *Ectacrinus* the infrabasals are separate). Rays divided one to ten times. Stem surrounded at intervals by whorls of cirri. No root-like processes on the stem. One or more free primary brachials. Orals wanting in the adult. Trias, to Recent. *Pentacrinus*, *Metaecrinus* (Fig. 257), *Ectacrinus*, *Balanocrinus*.

Family 4. **Comatulidæ.**

Adult free, larva stalked. The calyx is closed apically by the uppermost ossicle of the larval stem, which is fused with the larval infrabasals; this ossicle carries cirri and becomes detached from the rest of the stem. It is called "centrodorsal." The basals are externally visible, or else form an internal hidden rosette. Five or ten simple or branched rays. The radials of the radial circle are usually followed, in forms with divided arms, by two fixed primary brachials. Interradials wanting. Orals wanting in the adult. *Atelocrinus* (basals externally visible), *Eudiocrinus*, *Antedon* (Fig. 258), *Promachocrinus*, *Actinometra* (the only *Crinoid* genus with excentric mouth). Since Jurassic times, many living species.

SUB-CLASS 2. **Cystidea.**

Body (calyx) oviform or spherical, plated with numerous very variously shaped pieces, which are rarely quite regularly, and often irregularly arranged; stalked, sessile, or (rarely) free. Arms in many cases unknown, perhaps wanting in many forms; when present, weakly developed, resembling pinnules, and rising near the mouth. Food

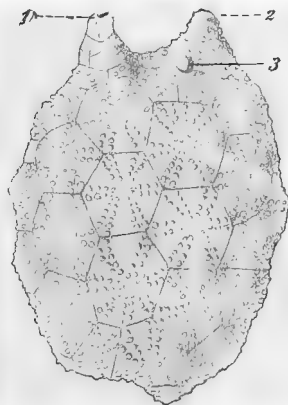

FIG. 261.—*Orocystis Helmhackeri*, Baur (after Barrande). 1-3, The three apertures.

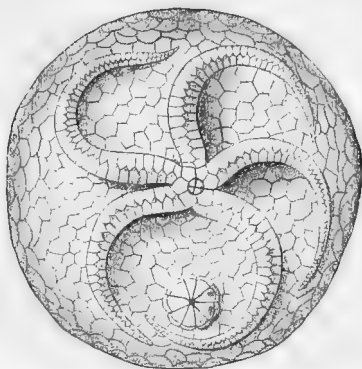

FIG. 262.—*Agelacrinus cincinnatensis*.

grooves, arranged irregularly on the calyx, radiate from the mouth. At some distance from the mouth a second aperture (anal aperture), and between the two a third aperture of unknown significance. Double pores or "pectinated rhombs" on some or all of the plates. Paleozoic *Pelmatozoo*, whose organisation is still little understood.

Order 1. **Cystocrinoidea** (cf. the section on the perisomatic skeleton of the *Cystidea*): *Peroecrinus*, *Caryocrinus*, *Echinocrinus*, *Cystoblastus* (Fig. 259 A and B).

Order 2. **Eucystidea**: *Protoecrinus* (Fig. 260), *Glyptosphaerites*, *Orocystis* (Fig. 261), *Echinosphaera*, *Aristocystis*, *Ascocystis*, *Mesites*, *Agelacrinus* (Fig. 262).

SUB-CLASS 3. **Blastoidea.**

Armless Pelmatozoa, either pear-shaped, club-shaped, oviform, or spherical. Body usually regularly radiate. Base monocyclic. Three basals, one small and

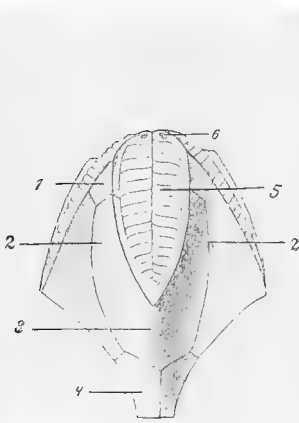

FIG. 263.—*Pentremites*, from the side, without pinnules. 1, Interradial=deltoid; 2, 3, radials; 4, basal; 5, ambulacrum; 6, spiracle.

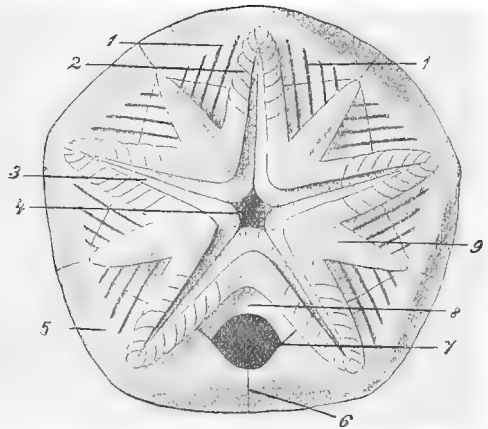

FIG. 265.—*Codaster bilobatus*, M'Coy, from the oral side (after Etheridge and Carpenter). 1, Hydrospire slits; 2, lateral plates; 3, ambulacral groove; 4, mouth; 5, radial; 6, suture between two radials; 7, anus; 8, interradial; 9, ridge on an interradial.

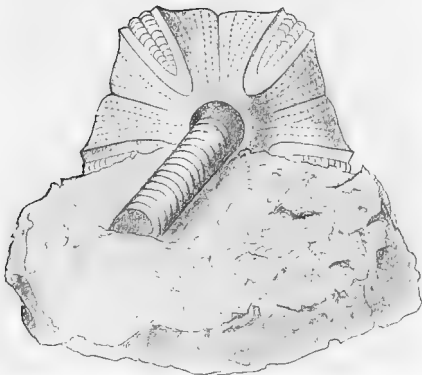

FIG. 264.—*Granatocrinus* Norwoodi (after Etheridge and Carpenter); from the apical side, with stem.

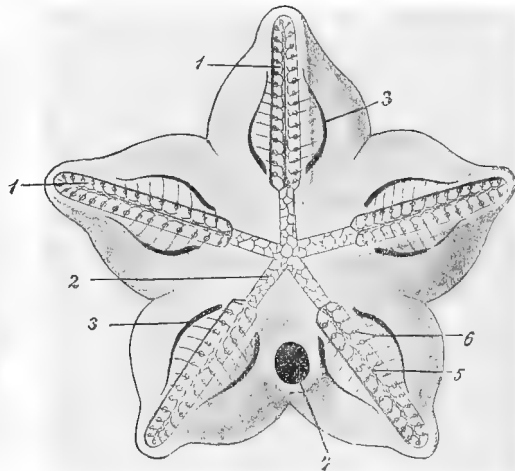

FIG. 266.—*Orophocrinus stelliformis* (after Etheridge and Carpenter); from the oral side. 1, Lateral plates; 2, covering plates of the ambulacra; 3, hydrospire slits; 4, anus; 5, ambulacral groove; 6, points of attachment of the pinnules.

two larger. Five radials, more or less deeply cut out for the reception of the five ambulacra. Five interradials lying above the five radials, and surrounding the

peristome. One of these is perforated by the anus. The ambulacra are bordered along each side by a single or double longitudinal row of jointed pinnule-like appendages. Ambulacra with lateral and accessory lateral plates. In each ambulacrum, under the lateral plates, there is a lancet-like piece, which is penetrated lengthwise by a canal, and in which a radial ambulacral vascular trunk probably ran. Ten groups of "hydrospires" on the radials and interradials. Peristome covered by small plates, which are continued into the covering plates of the ambulacra. For details *cf.* the section on the Skeletal System, p. 328. Paleozoic forms.

Order 1. *Regulares.*

Stalked Blastoids with symmetrical base. The radials resemble one another, as do the ambulacra.

Fam. 1. *Pentremitidæ*: *Pentremites* (Fig. 263), *Pentremitidea*, *Misoblastus*. Fam. 2. *Troostoblastidæ*: *Troostocrinus*, *Metablastus*, etc. Fam. 3. *Nucleoblastidæ*: *Elaeocrinus*, *Schizoblastus*, *Cryptoblastus*. Fam. 4. *Granatoblastidæ*: *Granatocrinus* (Fig. 264), *Heteroblastus*. Fam. 5. *Codasteridæ*: *Codaster* (Fig. 265), *Plucnoschisma*, *Cryptoschisma*, *Orophocrinus* (Fig. 266).

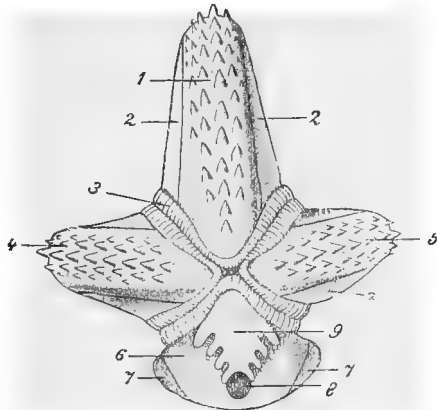

FIG. 267.—*Astrocrinus Bennieii* (after Etheridge and Carpenter). 1, 4, 5, Interradials or deltoid plates; 2, radials; 6, the modified radial; 3, ambulacrum; 9, the modified ambulacrum; 7, basal; 8, notch-like sinus.

Order 2. *Irregulares.*

Unstalked Blastoids, in which one ambulacrum with its radial is differently developed from the rest.

Single family, *Astrocrinidæ*: *Eleutherocrinus*, *Astrocrinus* (Fig. 267), *Pentephyllum*.

I. General Morphology of the Echinoderm Body.

The body of most Echinoderms, superficially observed, appears to be of strictly radiate structure, but more careful examination reveals that even in apparently perfectly radiate forms, *e.g.* regular Sea-urchins and Star-fish, strict radiate symmetry is not found either in the external or in the internal organisation; in the latter, indeed, the asymmetry is evident. Nevertheless, in order to facilitate a simple description of the position and arrangement of the organs, terms are habitually used which assume a strictly radiate structure. For the purposes of description we may imagine the Echinoderm body to be spherical or egg-shaped. Two poles may be distinguished in it. At the oral, adactinal, or ventral pole there lies, in most Echinoderms, the oral aperture, while at the other apical, abactinal, or dorsal pole in many forms is found the anal aperture. The line which connects the oral and apical poles is called the principal axis.

Round this principal axis many important parts of the body are grouped in a radiate manner. The typical number of the rays is, with few exceptions, five. In the Echinoderms, as in the radiate Cœlenterates, rays of the first, second, and third order may be distinguished. The radii or radial regions of the first order, in which the principal organs lie, are called **perradii**, **ambulacral radii**, or simply **radii**. The five radii of the second order, which regularly alternate with these five principal radii, are the **interradii** or **interambulacral**

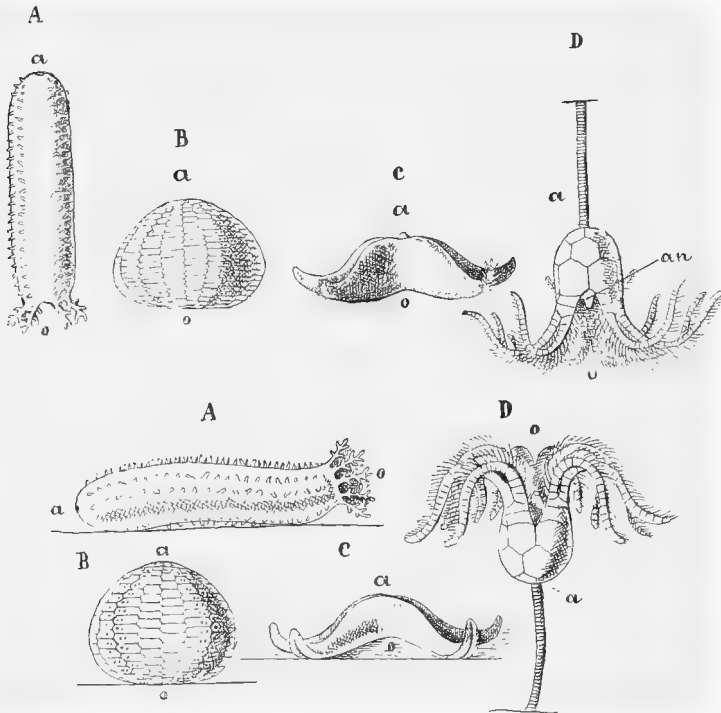

FIGS. 268 and 269.—Representatives of the principal divisions of the Echinodermata. In Fig. 268, in the morphological position; in Fig. 269, in the natural position with regard to the sea-floor. A, Holothurian. B, Sea-urchin. C, Star-fish. D, Crinoid— α , Apical pole; o, oral pole; an, anus.

radii. The far less important ten radii of the third order, each of which lies between a perradius and an interradius, may be called **adradii**. Between the two poles, at right angles to the principal axis, we have the **equator**. In those Echinoderms which are provided with large skeletal plates, the body and skeleton is further divided into two zones, separated from one another by the equator; these are the **oral, adactinal, or ventral zone**, and the **apical, abactinal, or dorsal zone**. In the centre of the former lies the mouth.

While these terms facilitate the **morphological** description of the body they do not take into account its position in the water, or with regard to the sea-floor, which is assumed to be horizontal. Thus the normal position of the Star-fish and Sea-urchin is such that the oral zone is directed downwards and the apical zone upwards; while the very reverse is the case in the Crinoids, where the oral zone faces upwards and the body is attached to the substratum by a stem which is inserted at the apical pole. In the Holothurians, again, the principal axis of the body lies parallel to the substratum, and the oral pole forms its anterior, the apical pole its posterior end.

For particulars as to the form of the body and the external organisation of the various classes and orders of the Echinodermata, cf. the Systematic Review, and also specially the two sections which treat of the skeletal and ambulacral systems.

II. Morphology of the Skeletal System.

Meaning of the Most Important Lettering of the Figures.

<i>a</i>	Apical pole.	<i>ian</i>	Anal interradials or anals.
<i>am</i>	Ambulacral plates.	<i>ib</i>	Infrabasals.
<i>an</i>	Anus or anal area.	<i>id</i>	Interdistichals or intersecundi- brachs.
<i>ap</i>	Ambulacral pores.	<i>ir</i>	Interradials.
<i>B</i>	Buccal plates.	<i>m</i>	Madreporite, pore-openings of the stone canal.
<i>ba</i>	Basals.	<i>n</i>	Nodal columnal.
<i>br</i>	Brachials, arms.	<i>o</i>	Oral pole, mouth.
<i>c₁</i>	First costal or primibrach.	<i>or</i>	Orals, or mouth-plates.
<i>c₂</i>	Second costal or primibrach.	<i>p</i>	Pinnules.
<i>ca</i>	Points of insertion of the cirri.	<i>pa</i>	Anal.
<i>cd</i>	Centrodorsal.	<i>rs</i>	Radial shields.
<i>ce</i> or <i>c</i>	Central plate.	<i>r</i>	Radials.
<i>ci</i>	Cirri.	<i>ss</i>	Lateral shields.
<i>co</i>	Column, stem.	<i>t</i>	Terminals.
<i>cpu</i>	Covering plates of the ambulacral grooves.	<i>ta</i>	Anal tube or ventral sac.
<i>D</i>	Dentes, teeth.	<i>vk</i>	Tegmen calycis.
<i>dc</i>	Dorsocentral.	1-5	Interradii or interambulacral areas of the <i>Echinoidea</i> .
<i>di</i>	Distichal or secundibrach.	I-V	Radial or ambulacral areas of the <i>Echinoidæ</i> .
<i>ds</i>	Dorsal shields.		
<i>go</i>	Genital aperture.		
<i>iu</i>	Interambulacral plates.		

(In many of the diagrams of the apical system of various Echinoderms the **infrabasals** are dotted, the **basals** shaded with **concentric lines**, and the **radials** marked **black**. The **brachials** of the *Crinoids* are shaded with **radial lines**.)

Introduction.

The extensive comparative and ontogenetic researches which have been made on the Echinoderms have shown that it is to some degree

probable that certain pieces or plates of the skeleton are homologous in all the divisions. It may be assumed that these plates composed the **primitive Echinoderm skeleton**. From this primitive arrangement, the skeletons of all known Echinoderms, whether extant or extinct, appear to be derived, on the one hand, through the loss of certain pieces of this primitive skeleton, and, on the other hand, by the acquisition of new or secondary pieces of varied form, number, and arrangement.

The hypothetical primitive Echinoderm skeleton consists of two principal groups or systems of plates: (1) the oral, and (2) the apical.

The oral system has five **interradially** placed oral plates, arranged radially round the oral pole. This oral system develops

round the left coelomic vesicle, out of which the oral portion of the coelom rises.

In the **apical system** the following plates occur: (1) a **central plate** at the apical pole; (2) a circle of five **radially** placed plates, the **infrabasals**; (3) alternating with these, five **interradially** placed plates, the **basals**; and (4) around these, five **radially** placed plates, the **radials**. The apical system develops on the right coelomic vesicle, from which the apical portion of the coelom is derived.

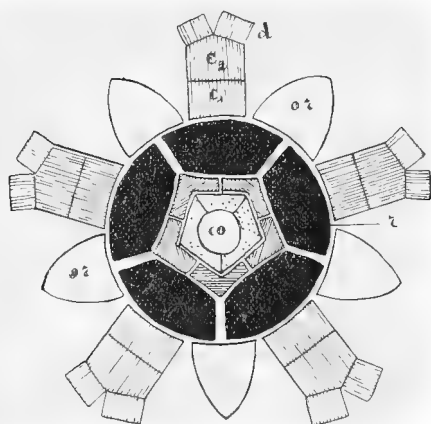

FIG. 270.—Diagram of the apical system of the *Antedon* larva, combined from various stages. Explanation of the lettering on p. 317. The number of infrabasals is here shown as 3, but these are produced by fusion of 5, which number has also been seen.

The stalked larva of *Antedon* (Fig. 270) has retained this system of plates less altered than in any

known Echinoderm. It has all the typical pieces of the oral and apical (or aboral) system of plates.

All the skeletal plates of the Echinodermata consist of carbonate of lime. Their microscopical structure is very characteristic, so that small fragments can at all times be recognised and distinguished from similar fragments belonging to the skeletons of other animals. The structure is a sponge-work; and thin sections of the skeletal plates or of the microscopic calcareous bodies appear to be perforated in a lattice-like manner. The finer structure, especially of the spines of Sea-urchins, is of great systematic importance.

A. The Apical System (Calyx).

I. Echinoidea.

The part of the test which in the Sea-urchins is formed by the apical system varies greatly in size. In the older and more primitive forms, the **regular** Echinoidea, it is still somewhat extensive as compared with the rest of the test (Fig. 271), but in modern, especially irregular forms (*Clypeastridae* and *Spatangidae*), it continually diminishes in relative size till it is nothing more than a minute region at the apical pole. It is possible to deduce the apical system of the Echinoidea directly from the hypothetical primitive form by the help of certain *Saleniidae* (Fig. 272). It is true that in the apical system of this family, as in that

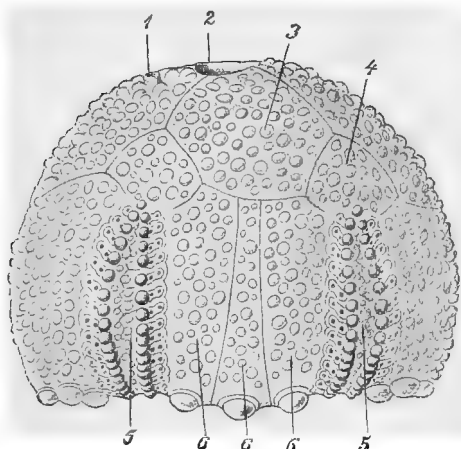

FIG. 271.—*Tiarechinus princeps*, Laube (after Lovèn). 1, Genital aperture; 2, anus; 3, basal; 4, radial; 5, ambulacrum; 6, the three upper plates of an interambulacrum.

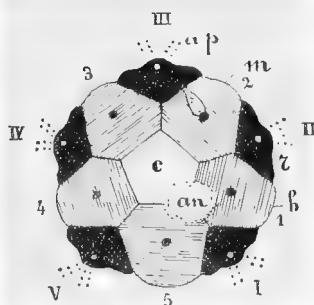

FIG. 272.—*Salenia* sp. Apical system (after Lovèn). For lettering see p. 317.

of all other Echinoidea, the infrabasals are entirely wanting, but all the other typical plates are present: *i.e.* a central plate, and round it five basals, and outside these, alternating with them, five radials. In the right posterior interradius each of the three plates, the central and the two basals, is incomplete at the point where they meet. A circular region, the anal region, in which the anus lies, is thus formed. The anus, therefore, here lies asymmetrically in the apical system, and this is the case in most *Palæchinoidea* and in most regular *Euechinoidea*. According to the universally accepted terminology, it lies in the right posterior interradius.

The typical system above described for the adult *Saleniidae* has been found to be repeated in very young specimens of other Sea-urchins examined for this purpose (*Echinus*, Fig. 273; *Toxopneustes*, Fig. 274).

Apart from these cases, where a primitive condition is shown by

the presence of the central plate, most regular Echinoidea show the following typical composition of the apical system: In the centre of

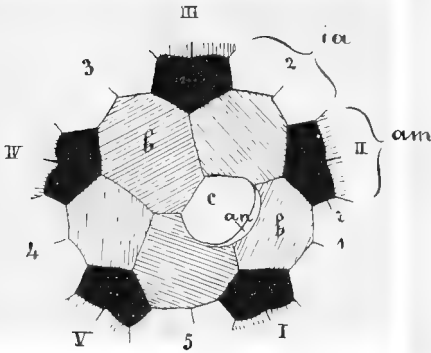

FIG. 273. — *Echinus* sp. (1 to 2 mm. long). Apical system (after Lovén). For lettering see p. 317.

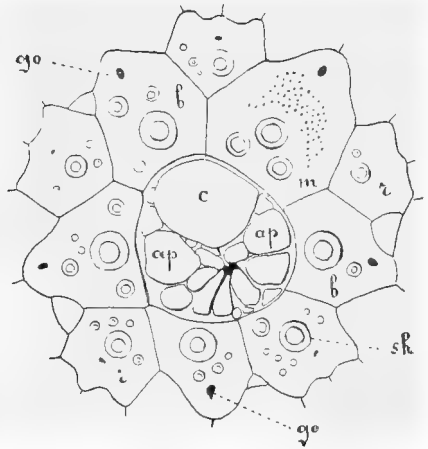

FIG. 274. — *Toxopneustes dröbachiensis*, O.F.M. (10 mm. long). Apical system (after Lovén). For lettering see p. 317. *sh*, Tubercles carrying spines; *ap*, anal plates.

the system lies the anal area, with a few large, or many small, calcareous plates. A central plate cannot be distinguished. Within the anal

area lies the anal aperture, usually excentric, less frequently central. Round the anal area are found the circles of plates present in all Echinoids, viz. the proximal circle of five basal plates, and the distal circle of five radial plates (Fig. 275). One, or several, or even all of the radials may, however, become wedged in between the basals apically, and finally may take part in the limitation of the anal area.

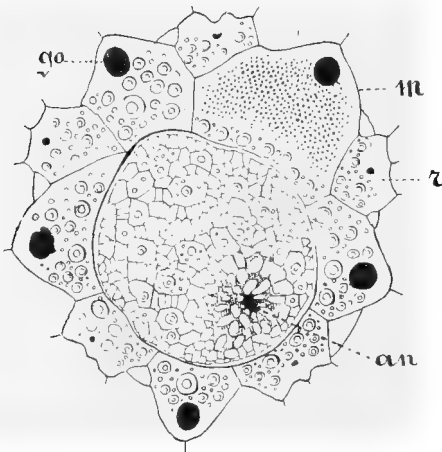

FIG. 275. — *Toxopneustes dröbachiensis*, O.F.M. Apical system of the adult (after Lovén). For lettering see p. 317.

large central plate (Fig. 274). Near this central plate, which ceases to grow and degenerates, accessory plates appear. Among these

The ontogeny of *Toxopneustes* shows that there is at first in the anal area of very young Echinoidea one

accessory plates, which continually increase in number, the anal aperture then forms, somewhat excentrically (Fig. 274). After a time the central plate can no longer be distinguished from the accessory plates.

As a rule, *i.e.* in the greater number of cases, the basals and radials attain, in Echinoidea, the following special significance:

1. Each basal is perforated by a large pore or hole, through which one of the five genital glands opens externally. On this account the basals of the Echinoidea have long and almost universally been called **genital plates**.

2. Each radial is also perforated by a narrow canal, which opens at its surface through a single (rarely double) aperture. In this canal lies the **terminal tentacle** of the water vascular system, the frequently pigmented end of which projects somewhat beyond the aperture. Since these collections of pigment were formerly considered to be eyes, the plates (radials) carrying them were called the **ocular plates**.

3. The fine, and usually very numerous, apertures of the water-vascular system perforate one of the five basals (genital plates), which becomes the **madreporite** (*m*). This is the right anterior plate.

It must, however, be noted that (1) the genital apertures are not **necessarily** connected with the basal (genital) plates. The latter must not be regarded as terminal appendages of the genital ducts, but as independent portions of the test. For (*a*) the basals are solid when first developed, and are only perforated by the genital pores after the genital ducts have completely developed; (*b*) the genital apertures in some Echinoidea lie outside the basals. For example, among the *Clypeastroida*, in some species of the genera *Laganum*, *Encope*, *Mellita*, etc., the genital pores lie outside the apical system, between its edge and the first two interradial plates which border it; in *Clypeaster rosaceus*, they lie in the five sutures between the interradial plates, and are separated from the apical system by two or three pairs of interambulacral plates (Fig. 277); and further, in another true Echinoid, *Goniopygus*, the genital apertures lie interradially quite outside the whole apical system. (2) The madreporite, through which water flows into the stone canal, is not **necessarily** exclusively connected with the right anterior basal (genital) plate. On the contrary, the neighbouring genital plates, indeed, all the five plates, and in isolated cases, even the neighbouring interradial plates of the corona may be perforated by the afferent ducts of the stone canal. In *Palaeochinus* each basal plate is perforated by three pores, which are perhaps apertures of the stone canal, perhaps genital apertures, or else partly the one and partly the other. In no case, however, do the madreporic apertures extend to the radials (ocular plates).

In the Echinoidea the primitive character and especially the radiate structure of the apical system may be more or less strongly modified. The original cause of such modification is principally to

be sought in the shifting of the anus and anal area out of the apical system into the posterior interradius; by this shifting the anus may come to lie at any point between the (aboral or dorsal) apical system and the oral (or ventral) area. In its posterior and downward shifting the anus thus does not carry the apical system with it, but the latter remains on the dorsal side, although it is often shifted somewhat excentrically anteriorly, rarely posteriorly. The whole body is then bilaterally symmetrical, and when seen from above it is oval or heart-shaped, etc., in outline. The line connecting the mouth with the anus, which in the regular endocyclic Echinoidea altogether or nearly

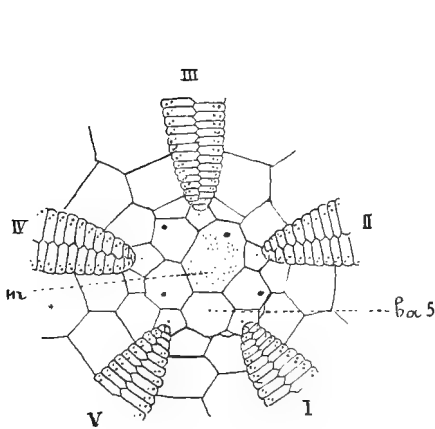

FIG. 276.—*Holectypus depressus*, Cotteau. Apical system and neighbouring parts of the perisome (after Lovén). For lettering see p. 317.

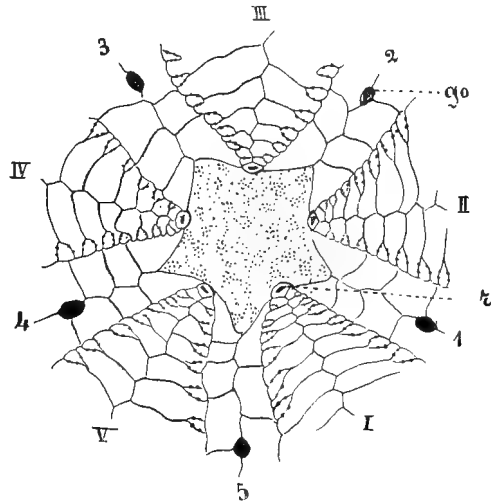

FIG. 277.—*Clypeaster rosaceus*, L. Apical system and neighbouring parts of the perisome (after Lovén). For lettering see p. 317.

coincides with the vertical (principal) axis, now becomes the more inclined, *i.e.* approaches the more nearly to the horizontal, the further the anal aperture is removed from the apical system into the posterior interradius, and is shifted on to the under side (into the oral or actinal region). Those Echinoidea in which the anal aperture has been shifted outside the apical system are called **exocyclic** or **irregular**.

Among the *Palæoechinoidea* the genus *Echinocystis* (*Cystocidaris*) alone is exocyclic. It appears that in this form the whole apical system consisted merely of one madreporic plate.

Among the *Euechinoidea* the three orders *Holectypoida*, *Clypeastroida*, and *Spatangoida* are exocyclic.

a. Holectypoida (Fig. 276). In consequence of the wandering of the anus out of the apical system, the posterior basal plate has lost its genital aperture, probably in connection with the disappearance of the related genital gland (the place of which has been taken by the rectum); in *Conoclypeus* and *Galacropygus* this plate has even

altogether disappeared. In some more recent species of the genus *Holactyppus* the genital pore of the posterior basal plate reappears secondarily. The space in the apical system, vacated by the anal area, is occupied by the madreporite (the right anterior basal plate), which greatly increases in size, or else all the five basal plates shift together towards the apical pole, the pores of the stone canal being then distributed over several or all of them. The plates of the apical system may fuse to a greater or less extent.

b. Clypeastroida (Figs. 277 and 278). The whole apical system is here extraordinarily reduced in extent; it is, indeed, very minute. All the five basals are fused together, and sometimes also fused with the radials. At least four genital pores are retained. Where there are only four, it is always the posterior which is wanting. The pores of the stone canal open in very various ways in the region of the fused basals. Many scattered pores are sometimes found, or one single large pore, or the pores open into irregular pits or grooves. In the family of the *Clypeastroida* the

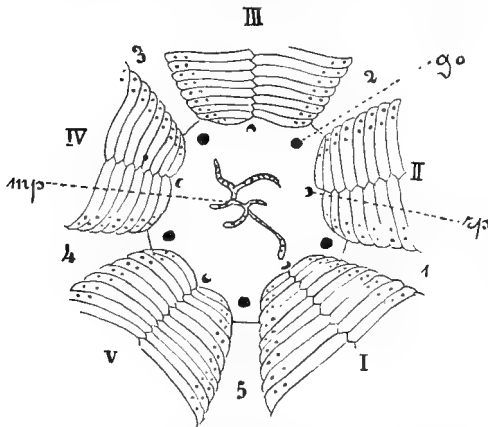

FIG. 278.—*Laganum depressum*, Less. Apical system and neighbouring parts of the perisome (after Lovén). *mp*, Ocellar pores in the fused radials; *m*, pores of the madreporite in a branched furrow. For lettering see p. 317.

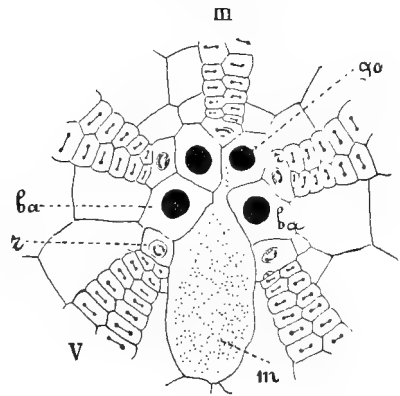

FIG. 279.—Apical system and neighbouring parts of the perisome of *Meoma ventricosa*, Lamk. (after Lovén). For lettering see p. 317.

genital pores have wandered out of the apical system; they lie either at its edge, or further removed in the sutures between the (paired) rows of interradial plates.

c. Spatangoida. The apical system of these exocyclic Echinoids is much reduced in extent, although not so much so as that of the *Clypeastroida*. It varies much in detail, and in a few extreme forms (*c.g.* *Pourtalesia*) the primitive condition is to a very great extent obliterated and destroyed.

1. In many geologically ancient forms the influence of the wandering of the anus out of the apical system is seen in the disappearance of the posterior basal plate (together with the genital pore belonging to it), and in the absence of a central plate. The other basals and the radials (each of which has its pore) have all shifted, and occupy an area which is sometimes circular or almost regularly pentagonal, sometimes lengthened in the direction of the plane of symmetry. In the latter case (Fig. 283), the two middle radials touch in the median line, separating the two anterior from the two posterior basals. The apertures of the stone canal are found in the right anterior basal, which is occasionally somewhat enlarged.

2. In most recent fossil forms and in the great majority of the extant *Spatangoida*,

when their development is also taken into account, we find the following conditions. The posterior basal plate again appears, but never has a genital pore. The central plate also reappears. The apertures of the stone canal spread out from the right anterior basal towards the centre, *i.e.* on to the central plate. From this they

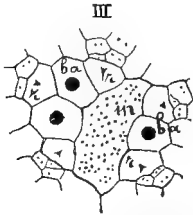

FIG. 280.—Apical system of *Abatus cavernosus*, Phil. (after Lovén). For lettering see p. 317.

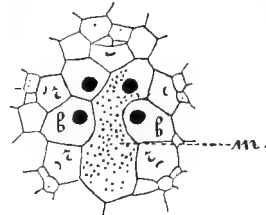

FIG. 281.—Apical system of *Spatangus purpureus*, ♀♀ imm. in size (after Lovén). For lettering see p. 317.

pass on to the posterior basal plate, and the three plates fuse together. The sutures between them disappear, and so a large central madreporic plate is formed, which in very many forms shows a tendency to increase in size and to spread out in the direction of the posterior interradius, and thus more or less to press asunder the two

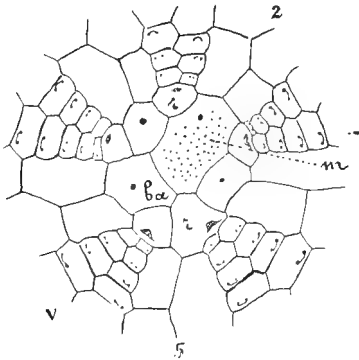

FIG. 282.—Apical system and neighbouring parts of the perisome of *Micraster coranquinum* (after Lovén). For lettering see p. 317.

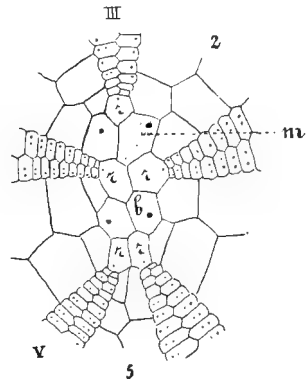

FIG. 283.—Apical system and neighbouring parts of the perisome of *Holaster suborbicularis*, Defr. (after Lovén). For lettering see p. 317.

posterior radials (Figs. 279-281). The genital aperture on the right anterior basal may disappear, in which case only three genital pores remain. In isolated cases, the left anterior basal plate may also lose its genital pore.

3. A method of dissolution of the apical system, unique among the Echinoidea, is found in many *Collyritidae* (Fig. 284). If we imagine that the elongated apical system, described under heading 1 (Fig. 283), becomes very much more elongated in the direction of the plane of symmetry, and breaks into two groups, one anterior and the other posterior, we have the condition in these animals. The anterior group contains the four basals, of which the right anterior is the madreporic plate, and three radials, *viz.* the anterior unpaired, and the right and left anterior.

The posterior group consists of the two posterior radial plates; the posterior unpaired (fifth basal) plate is wanting. The anterior group is separated from the posterior by a row of plates which belong to the right and left posterior interradia, as can be seen by comparing the figures. This arrangement is found in no other Echinoid. As in all Echinoids, however, the radials remain connected with the apical ends of the five double rows of ambulacral plates, so that these latter divide in a

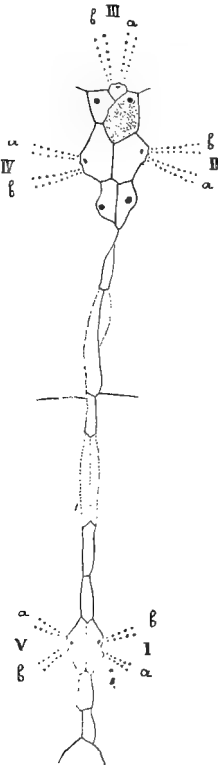

FIG. 284.—Apical system of *Collyrites elliptica*, Lam. (after Lovén). For lettering see p. 317.

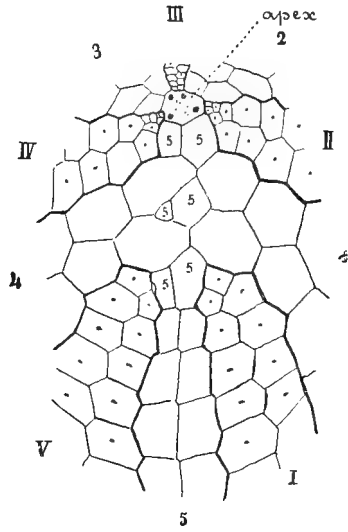

FIG. 285.—Apical system and neighbouring part of the perisome of *Pourtalesia Jeffreyi*, W. Th. (after Lovén). For lettering see p. 317.

remarkable manner into three anterior ambulacra (**trivium**), the anterior unpaired and the anterior right and left, and two posterior ambulacra (**bivium**).

4. The apical system is most of all reduced and obliterated in the peculiar Spatangoid family of the *Pourtalesidae* (Fig. 285). Let us take as an example *P. Jeffreyi*. The whole system, which is irregularly pentagonal in outline, is shifted forward, and separated from the apical ends of the two posterior ambulacra by the uppermost plates of the posterior unpaired and of the right and left posterior interradia. It, almost certainly, consists of four basal plates, each perforated by a genital pore, but fused together into one single piece in which no suture can be seen. In the central and anterior portion of this plate lie the scattered pores of the stone canal. **No radials can be recognised.**

Although there are good palaeontological reasons for the generally accepted belief that all known **exocyclic (irregular)** Echinoidea are descended from **endocyclic (regular)** forms, it has been conjectured that these latter may themselves have had exocyclic ancestors (which, indeed, are unknown to us). Thus the modern *Spatangoida* and *Clypeastroida*, for example, by the position of the anus in the posterior unpaired interradius, may secondarily have attained a primitive condition. The anus would then have wandered first from the posterior unpaired interradius to the centre of the apical area, and then, in the exocyclic forms known to us, have shifted back again in the same direction. This suggestion, which is of special significance with reference to the primitive *Pilmatozoa*, receives some (not very satisfactory) support from the fact that in the very old family of the *Saleniidae* among the regular Echinoidea, the anus lies at the posterior edge of the apical system in the oldest forms, but during geological development approaches more and more near the centre of the system, near which it is found asymmetrically (posteriorly to the right) in the modern forms.

II. Asteroidea.

The typical plates of the apical system are not present in most adult Star-fish, or at any rate cannot be made out among the numerous calcareous pieces embedded in the dorsal area of the disc. There are, however, exceptions to this rule. For

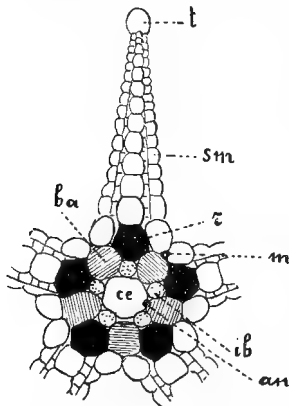

FIG. 286.—Apical system of plates in a young specimen of *Zoroaster fulgens* (after Sladen). For lettering see p. 317.

instance, in species of the genera *Pentagonaster*, *Tosia*, *Astrogonium*, *Stellaster*, *Nectria*, *Ferdina*, *Pentaceros*, *Gymnasteria*, *Seytaster*, *Ophidiaster*, *Zoroaster*, the central plate, the five basals and the five radials can still be more or less clearly recognised in the adults. Occasionally (in species of *Pentagonaster*, *Gymnasteria*, *Pentaceros*, and many *Goniasteridae*) there are even to be found plates which in position correspond with the infrabasals. The whole apical system is specially well developed in young specimens of the deep-sea Star-fish *Zoroaster fulgens* (Fig. 286). The aperture of the stone canal lies in the right anterior interradius, outside the basal; the anus in the right posterior interradius, inside the basal. In all

Asteroids, the madreporic plate and anus lie in these interradii of the apical region (*cf.* the Echinoidea, Figs. 272-275).

The typical apical system can also be proved ontogenetically in Star-fishes, even in forms in which it is absent or unrecognisable in the adult. Five basals, a central plate and five radials are actually among the first plates formed in the embryo Star-fish, in the very order in which they are here named, though always after the terminals, presently to be described, which appear first of all. Small plates, appearing radially within the circle of basals, have been considered to

be infrabasals. This view is, however, not certain, because other new and also radially arranged plates may be added to these, which may thus also themselves possibly be accessory structures.

III. Ophiuroidea.

In this class, the plates of the apical system do not appear in the embryo in exactly the same order as in the *Asteroidea*. First the five radials and the central plate form, and, somewhat later, between the circle of radials and the central plate, the five basals and the five infrabasals appear. In many Ophiuroidea, an embryonic condition of the apical system is retained in the adult, the central plate being surrounded by the circle of five radials, while the basals and infrabasals are wanting

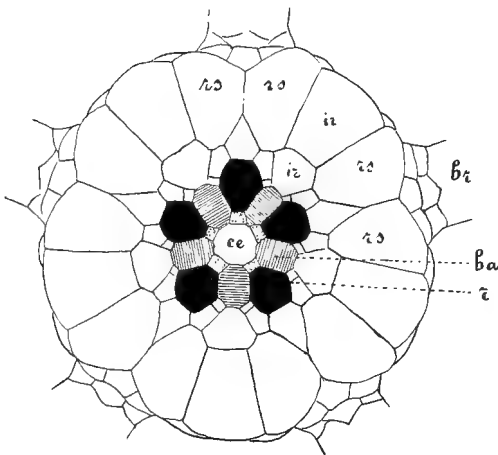

FIG. 287.—Plates of the apical system of the disc of *Ophiomusium validum* (after P. H. Carpenter). For lettering see p. 317.

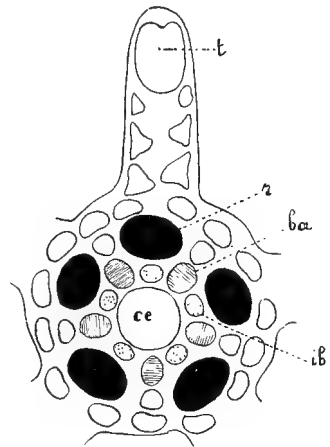

FIG. 288.—Apical system of a young *Amphiuira squamata* (after P. H. Carpenter). For lettering see p. 317.

(species of the genera *Ophioglypha*, *Ophiomastix*, *Ophiopyrgus*, *Ophiura*, *Hemipholis*, *Ophioceramis*, *Ophiopholis*, *Ophiotrochus*). In many others, however, there are, besides the radials, the five basals, which may vary greatly in size (species of the genera *Ophioglypha*, *Ophiomastix*, *Ophiomusium*, *Ophiura*, *Ophiopholis*, *Ophiozona*, *Ophiactis*, *Ophiolepis*). In *Ophiomitra exigua* there is only the central plate with five basals around it. In some Ophiuroidea a complete apical system is developed, infrabasals being added to the basals, the radials and the central plate (isolated species of *Ophioceramis*, *Ophioglypha*, *Ophiozona*, *Ophiomusium* (Fig. 287), *Ophiolepis*). In very many Ophiuroidea the calcareous plates developed at the apical surface of the disc are so numerous that it is then impossible to recognise among them the typical plates of the apical system. The adult Ophiuroidea have no

anus. The apertures of the stone canal are not found on any of the apical plates, but ventrally, on one of the oral shields.

IV. Pelmatozoa.

In no other class of the Echinodermata do the plates of the apical system form so large a part of the skeleton of the body wall (apart from the arms) as in the Pelmatozoa. The body of these Echinoderms consists of a central **calyx**, which contains the viscera, and usually carries jointed appendages, radially arranged at its edge; these are the arms and pinnulæ. Typically the Pelmatozoa are attached to the sea-floor by their apical poles, with or without the intervention of a stem; in some the stem becomes separated from its attachment (*Pentacrinus*), and may dwindle in size (*Millericrinus*), or may be present only in the embryonic stages (*Antedon*), or there may be no trace of either stem or attachment (*Marsupites*). The oral side of the calyx (and also of the arms) is thus turned upwards, while the apical side of the calyx (the **dorsal cup**) is turned downwards and either surrounds the viscera like a bowl or carries them like a dish. The plated test of this bowl or dish consists exclusively, or for the greater part, of the plates of the apical system: the basals and the radials, to which infrabasals may be added. The anal aperture always lies interradially, usually on the oral side of the body and not connected with the apical system.

Sub-Class 1. Crinoidea.

There are a good many Crinoids in which the apical system is completely developed. The five radials and the basals are constant, although the latter may be hidden. The infrabasals are inconstant. The Crinoids in which the latter are present are said to have a **dicyclie** base, those in which they are absent have a **monocyclic** base.

A central plate has been observed in the larva of *Antedon*. It occurs at the distal or root end of the larval stem, and ultimately becomes severed from the animal.

The part taken by the plates of the apical system in the construction of the apical capsule varies greatly. In the stalked larva of *Antedon* they alone form the skeleton of the apical side of the calyx; although an anal interradiation has a transitory existence. The same is the case also in many other adult Crinoids, which in this respect show a primitive or an embryonic character (many *Inalunata larviformia* and many *Inalunata fistulata*, *Encrinus*, *Marsupites*, *Holopus*, *Hyocrinus*, *Bathyocrinus*, and a few *Cunaticulata*. *Rhizocrinus*, *Pentacrinus*).

In most Crinoids, on the other hand, the plates of the typical apical system, *i.e.* the infrabasals (where these occur), basals and radials do not form the whole skeleton of the apical capsule, but only a certain

(often even very small) part of it; other plates take part in its structure, as we shall see more in detail when describing the perisomatic skeleton. The border of radials round the apical capsule becomes more or less markedly disturbed by the appearance of

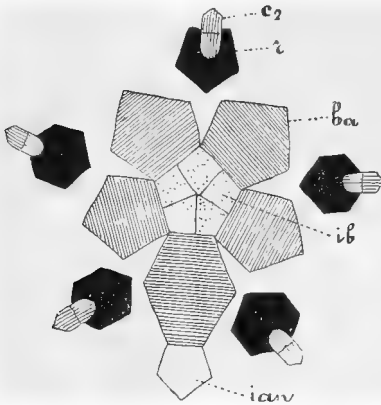

FIG. 289.—Apical system of *Cyathocrinus*. For lettering see p. 317. *ian*, Anal interradial.

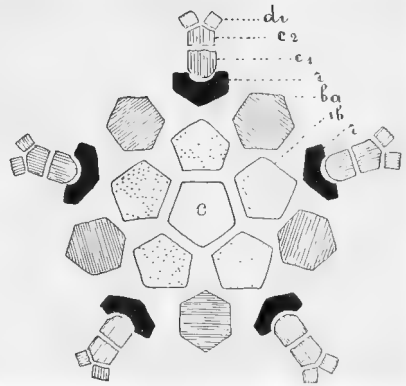

FIG. 290.—*Marsupites ornatus*. Plates of the dorsal cup. For lettering see p. 317.

special “anal plates” in the posterior unpaired interradius; these specialised anal occur very frequently in palaeozoic Crinoids (Fig. 291).

The Crinoids with dieyclic base (with infrabasals, Figs. 289 and 290) are: (a) most *Inadunata*, (b) among the *Camerata*, the families of the *Reteocrinidae* p. p., *Rhodocrinidae*, *Glyptasteridae*, and *Crotalocrinidae*, (c) the *Articulata* (*Ichthyocrinidae*); (d) the *Cunaliculata*, in which, it is true, the infrabasals are often either fused with the uppermost joint of the stem or atrophied, at least in the adult; such are conveniently termed *Pseudomonocyclic*.

The Crinoids with monocyclic base (without infrabasals, Fig. 291) are, apart from a few *Inadunata*, the *Camerate* families of the *Melocrinidae*, *Actinocrinidae*, *Platycrinidae*, *Hexocrinidae*, *Acrocrinidae*, *Barrandeocrinidae*, *Eucalyptocrinidae*.

Instead of the typical five infrabasals and five basals there are very often found four, three, or even only two plates in these rings; this is especially the case in extinct Crinoids belonging to the orders *Inadunata*, *Camerata*, and *Articulata*. The plates are then almost

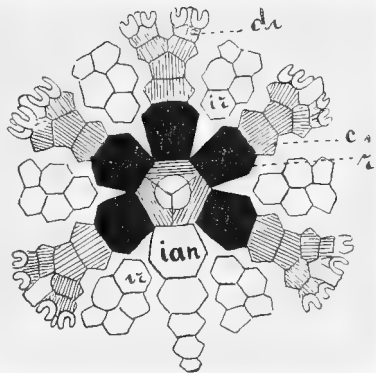

FIG. 291.—*Actinocrinus proboscidalis*. Plates of the dorsal cup. For lettering see p. 317.

always of unequal size, and it appears not unlikely that the reduction of their number was caused by the fusing of neighbouring plates. These characteristics necessarily destroy the strictly radial symmetry of the dorsal cup.

Still further fusions may occur (among the *Cunaticulata*).

The relative sizes of the plates of the infrabasal, basal and radial circles vary greatly, but this is of no great interest to the comparative anatomist.

Sub-Class 2. Blastoidea.

The Blastoidea are palæozoic Pelmatozoa, whose stalked armless body very often has the appearance of a bud (Fig. 263, p. 314). Seen from the side, the body is an oval, truncated sometimes at the apical, sometimes at the oral end. Seen from the oral or aboral pole, its outline is in by far the greater number of (regular) forms regularly pentagonal with rounded projecting angles, some-



FIG. 292.—Apical system of *Pentremites*. *aa-bb*, Axis passing through mouth and anus; *x*, the smaller; *y*, and *z*, the two larger basals; *ir*, interradials; *r*, radials.

times not unlike a short-armed Star-fish (Figs. 265 and 266, p. 314). In the irregular Blastoids, on the contrary (*Eleutheroocrinus*, *Astrocrinus*, Fig. 267, p. 315), the radiate structure is disturbed by the modified form of one of the ambulacra. The outline of the ovoid body of *Eleutheroocrinus*, seen from the apical or oral pole, is irregularly pentagonal, with three shorter and two longer sides, the latter belonging to the left posterior and the unpaired posterior interradial. In *Astrocrinus*, the body is flattened in the direction of its principal axis, and, when seen from the oral or aboral pole, almost symmetrically four-lobed, the lobes being of unequal size. The largest of the lobes lies diametrically opposite the abnormally shaped ambulacrum, which is on the smallest truncated lobe. The two other middle-sized lobes are almost alike in form (Fig. 267, p. 315).

The whole body of the Blastoids is plated. The test consists, apart from the ambulacra, of three circles of plates (Fig. 292), two of which belong to the typical apical system of the Echinodermata, while

the third consists of perisomatic plates, which, in all probability, correspond with the primary interradial plates of the *Crinoids*.

The first circle at the apex is that of the (interradial) basal plates. There are always three of these, one smaller and two larger of equal size, as also occurs in the *Crinoids*. The monocyclic base of the *Blastoidea* is thus symmetrical. But the line of symmetry (the so-called **dorsal axis**), which passes between the two larger plates and through the small unpaired plate, does not coincide with the symmetrical (ventral) axis of the body, which passes through the mouth and the anus, the latter lying in the posterior interradius on the oral surface. The smaller unpaired basal plate lies in the left anterior interradius. If we imagine the two larger basal plates cut into two similar parts by radial lines of division, we obtain the five equal-sized, strictly radially arranged, and interradially placed basals of most other Echinoderms. The uppermost ossicle of the stem is inserted at the point where the three basals of the Blastoids meet.

The circle of the basals is immediately surrounded by that of the radials. The typical number of five is always retained in these, which, in regular Blastoids, are strictly radiate in their arrangement. These are called **fork-pieces**, because each of them is produced upwards, *i.e.* orally, in the shape of a tuning-fork, the two limbs holding between them the distal end of an ambulacrum. The radials form a closed circle, their lateral edges being contiguous.

The third circle of plates is in immediate contact with the radials, and surrounds the peristome. It consists of five interradial plates, which, in regular Blastoids, are strictly radial; these are the interradials or **deltoid** plates. These plates do not form a closed circle, as they are separated from one another by the five ambulacra. The apical edges of each deltoid plate rest on the oral edges of the contiguous forks of two consecutive radials or fork-pieces. The relative sizes of the basals, radials, and interradials of the Blastoids vary greatly (*cf.* figures). One of the five interradials, which is distinguished as the posterior, is perforated by the anus.

In the irregular Blastoids (Fig. 293), which are without stems, all the plates of the regular forms are found, but are, naturally, irregularly developed. The radial which supports the modified ambulacrum is smaller than the other radials and differently shaped. It appears shifted quite on to the oral surface. At the same time, the pair of basals (*y* and *z*) which flank this radial are much prolonged orally as narrow plates.

It cannot at present be decided whether there are skeletal pieces

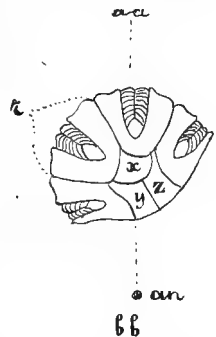

FIG. 293. — *Eluthero-*crinus Cassedayi**, from the apical side (after Etheridge and Carpenter). *aa-bb*, Axis passing through the mouth and the anus; *x*, the smaller, *y* and *z*, the two larger basals; *r*, radials; *an*, anal side.

in other Echinodermata homologous with the interradials of the *Crinoidea* and the *Blastoidea*. In all endeavours to answer this question the following plates should be kept in mind. in the *Ophiuroidea* the interradially placed plates between the circle of radials and the oral side (Fig. 287, p. 327), and among the *Echinoidea*, in *Tiarechinus* (Fig. 271, p. 319), the central of the three interradial plates of an interambulacral area.

Sub-Class 3. Cystidea.

The spherical, pear-shaped, egg-shaped, or cup-shaped body of the Cystidea is also enclosed in calcareous plates. In one of the principal groups, that of the *Eucystidea*, the plating consists of numerous contiguous plates arranged without any recognisable order. In this case

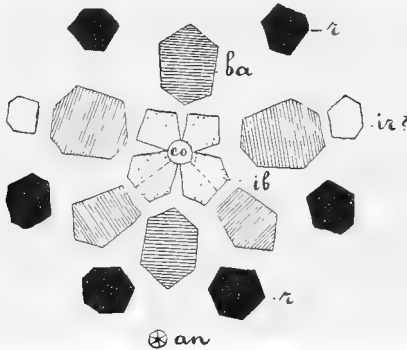

FIG. 294.—System of plates of the apical capsule of *Caryocrinus ornatus*, spread out (after Hall). For lettering see p. 317.

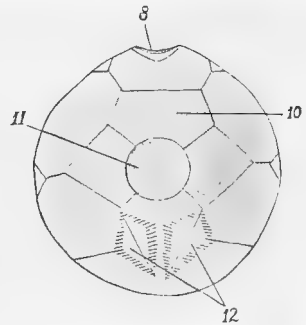

FIG. 295.—*Cystoblastus Leuchtenbergi*, from the apical side. 11, Point of insertion of the stem; 8, anus; 10, infrabasals; 12, pectinated rhombs.

a typical apical system of plates cannot be distinguished. In the other principal group, the *Cystocrinoidea*, certain forms of which show near relationship to the *Crinoidea* and *Blastoidea*, the test consists of a relatively small number of plates, and a true apical system can be found round the apical pole.

The forms assumed by this apical system may be grouped around two central types: *Caryocrinus* and *Echinoencrinus*. The group *Caryocrinus* (*Corylocrinus*, *Hemicosmites*, *Juglandocrinus*) has its plates arranged in six rays; while the group *Echinoencrinus* (*Callocystis*, *Lepalocrinus*, *Apiocystis*, *Cystoblastus*, *Glyptocystis*, *Pleurocystis*, *Prunocystis*, *Pseudocrinus*, etc.) shows the typical five-rayed arrangement of the plates. In both groups the base is dicyclic, *i.e.* there is a circle of infrabasals inside the circle of basals.

Caryocrinus, six-rayed (Fig. 294).—The circle of infrabasals consists of four plates, two larger (which are contiguous) and two smaller. Each of the two larger plates is double. Outside the circle of the infrabasals lies a closed circle of six interradial basals, and

this is surrounded by a closed circle of **six radials**. These plates, together with two accessory plates (interradials?), form the whole test of the cup of the attached *Caryocrinus*, from the point of insertion of the stem to the base of the arms. The anus lies eccentrically on the oral surface, in the (interradial) prolongation of the suture between the two larger infrabasals (cf. Figs. 294, 295).

Echinoencrinus, five-rayed (Fig. 296).—The **circle of infrabasals** consists of four plates, one large posterior plate and three smaller ones. The larger plate is double (i.e. consists of two fused plates). Outside the circle of infrabasals comes the closed circle of the **five basals**, and outside this that of the **five radials**, between which accessory pieces are intercalated, the homologies of which cannot be made out. The anus lies posteriorly to the right. In *Cystoblastus* the radials, like the radials or fork-pieces of the *Blastoidea*, have deep incisions on the oral side for the reception of the ambulacra (cf. Fig. 259, A and B, p. 312, and Fig. 295).

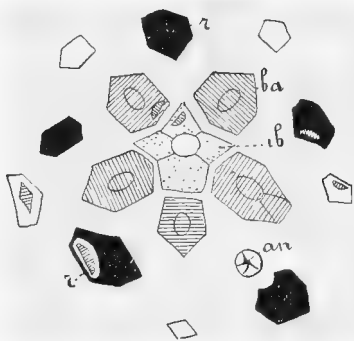

FIG. 296.—System of plates of the dorsal cup of *Echinoencrinus armatus*, spread out (after Forbes). For lettering see p. 317.

B. The Oral System of Plates.

In certain Echinodermata (*Pelmatozoa* and *Ophiuroidea*) there is a system of plates surrounding the oral (ventral, actinal) pole, and thus diametrically opposite to the apical system. This system develops round the left coelomic vesicle of the larva in a way similar to that in which the apical system develops round the right vesicle. The oral system is, however, much simpler than the apical, and consists of one single circle of five plates (less frequently six, in the six-rayed arrangement of the whole system); these plates, placed interradially, correspond in the oral system with the basal plates of the apical system, and are called **oral plates**.

In our considerations of this oral system we again find the best starting-point to be the stalked larva of *Antedon* (*Pentacrinus* stage). In a young stage of this larva the oral surface of the calyx appears vaulted over by a roof closed on all sides. The surface of the calyx thus forms the floor, and the vault the roof, of a closed cavity, which is called the **oral or tentacular vestibule**. At the centre of the floor the oral aperture breaks through, connecting the intestine with the vestibule. The mouth is thus at this stage not connected with the exterior. The fifteen primary tentacles, which rise on the disc of the calyx, also cannot project externally, but are covered over by the

roof of the vestibule. This roof is formed of five interradial lobes, supported by five interradial skeletal plates, the **oral plates**. An aperture only arises secondarily at the apex of the roof, and the five oral lobes separate in such a manner that the tentacles can project through the clefts between them. The mouth is now in open communication with the exterior.

At first the five oral plates rest directly on the oral edges of the basal plates of the apical system. But in proportion as the calyx increases in size, and the arms grow out, the distance between the basals and the newly-formed radials, which support the arms, on the one hand, and the oral plates on the other, becomes greater and greater, since the latter remain at the centre of the tegmen calycis, surrounding the mouth. There thus arises, between the bases of the arms and the circle of the oral plates, which in comparison with the continually

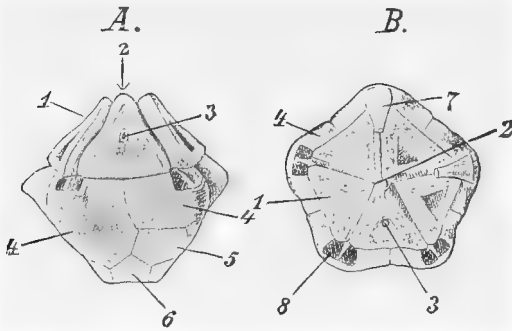

FIG. 297.—*Haplocrinus mespiliformis* (after Wachsmuth and Springer). A, From the anal side; B, from the oral side. 1, Orals; 2, oral pole; 3, anus; 4, radials; 5, inferradial; 6, basals; 7, first brachial; 8, point of attachment of the arm.

growing calyx becomes more and more insignificant, a circular zone, the peripheral zone of the tegmen calycis. The food grooves running out from the mouth, passing between the five oral lobes, traverse this peripheral zone of the tegmen to the bases of the arms. This peripheral zone continually increases in size, while the central part, surrounded by the five oral lobes, does not grow further, and forms an ever-diminishing central region of the tegmen calycis. Finally, the oral plates, with the lobes, are entirely resorbed, and the minute central zone can no more be distinguished; the whole oral surface of the *Antedon* calyx is a free disc, by far the greater part of which has been formed **outside** the base of the oral pyramid. In the centre of this oral disc the mouth lies uncovered, and on the surface of the disc the food grooves are visible running out radially to the bases of the arms.

Among the immense array of forms comprised under the crinoids we find a few groups with five oral plates forming, as in the larva of *Antedon*, the whole skeleton of the tegmen calycis. In the *Inadunata larviformia*, type *Haplocrinus* (Fig. 297), there is actually a closed pyramid of five oral plates, which, at the edge of the calyx, rest on the radials of the dorsal cup. Only at the bases of the arms do the five oral plates separate to form five radial apertures, through

which the food-grooves pass out on to the arms. The posterior oral plate is somewhat larger than the others, and has a perforation which may be the anus (?).

The same condition is found in the extant genera *Holopus* and *Hyocrinus* (Fig. 298), the extant unstalked genus *Thaumatoerinus*,

and the extant canaliculate genus *Rhizocrinus*. All these genera possess five oral plates, which, however, are separate, and do not form a closed pyramid; the mouth, therefore, is in open communication with the exterior between them. Compared with the larva of *Antedon* and with *Hyplocrinus*, *Holopus* shows the most primitive (or embryonic) condition, since in it the oral pyramid is large, covering nearly the whole of the tegmen, so that between its base and the edge of the calyx only a very small peripheral zone remains. In *Hyocrinus* (Fig. 298) also, and *Thaumatoerinus* the orals are

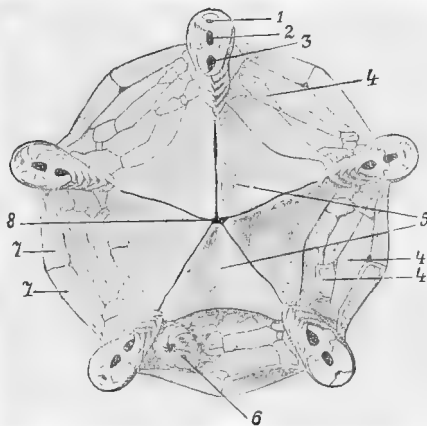

FIG. 298.—*Hyocrinus Bethellianus* (after P. H. Carpenter). Tegmen calycis. 1, Axial canal of the brachials; 2, extension of body cavity in the arm; 3, food groove of the arm; 4, smaller plates of the tegmen; 5, orals; 6, anal cone; 7, oral edges of the radials.

still of considerable size, but the peripheral zone, which is beset with small closely-crowded plates, is somewhat broader than in *Holopus*

(about one-fifth the diameter of the whole tegmen). In *Rhizocrinus lofotensis* the orals are smaller, and in *Rhizocrinus Rawsoni* they are almost rudimentary, so that the zone which surrounds them forms the greater part of the tegmen.

In the *Cyathocrinidae* (*Inadumata fistulata*), five large plates can sometimes be distinctly made out in the centre of the plated tegmen; sometimes, however, irregular pieces are found in their places. When they are distinct, the posterior plate is the largest, and is sometimes shifted anteriorly between the others. In all cases they cover the mouth in

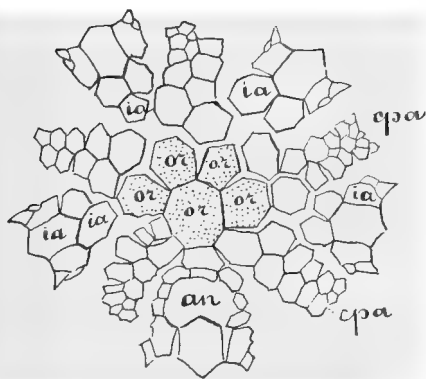

FIG. 299.—System of plates of the tegmen of *Platyocrinus tuberosus* (after Wachsmuth and Springer). For lettering see p. 317.

the peripheral zone, which is beset with small closely-crowded plates, is somewhat broader than in *Holopus*

such a way as to hide it. These plates are by some regarded as orals.

In the *Camerata* (Fig. 299) five supposed oral plates (*or*) can almost always be distinguished in the centre of the richly and rigidly plated, often highly arched, tegmen. They close together firmly over the mouth. The posterior oral is larger than the rest, and presses in between them.

As far as is known, in the *Articulata* (*Ichthyocrinoidea*) also, five orals can be distinguished at the centre of the richly but loosely plated tegmen. But, in this case, they are separate, and surround an open mouth. The posterior plate is larger than the rest.

In the *Canaliculata* (with the exception of the above-named genus *Rhizocrinus*) the orals are altogether wanting in the adult.

In the **Blastoidea** the oral region is covered by a roof consisting of numerous small plates usually without definite arrangement, which are continued as covering plates over the ambulacra. In a few forms, however, and especially in *Stephanocrinus*, five orals can be made out. In *Stephanocrinus* these five interradiol orals, resting on the interradiols (*i.e.* the deltoid pieces), form a closed pyramid over the oral region.

In many **Cystidea**, also, the mouth is arched over by an oral pyramid. In *Cyathocystis*, the five oral plates forming this pyramid are more or less equal in size, but in species of the genera *Sphaeronis*, *Glyptosphaera*, and *Pirocystis* the posterior oral is, as in so many *Camerata*, larger than the rest. In the six-rayed Cystid *Caryocrinus* this latter is the case, one of the six orals having shifted from behind forward between the other five, which surround it symmetrically.

In the **Ophiuroidea**, on the oral (lower) side of the disc, there is in each interradius a plate, usually distinguished by greater size. One of these plates, which are called **buccal shields** (Fig. 245, p. 300), is, as madreporite, perforated by the pores of the water-vascular system. In the pentagonal larva of *Amphiura* these buccal shields appear at the edge of the oral side. They have been homologised, probably correctly, with the orals of the *Pelmatozoa*.

In the **Asteroidea**, on the lower surface of the disc at the edge of the mouth, in each interbrachial region, there occurs a skeletal plate of very various shape, which is called the **odontophore** (Fig. 310, p. 352). These plates, which might be described as the **proximal or basal plates of the interbrachial system**, may correspond with the orals of the *Pelmatozoa* and the oral shields of the *Ophiuroidea*, although they may be pushed below the surface by the oral plates (the first pairs of adambulacral plates), and are usually completely covered externally. They arise early in the larva of *Asterias* (after the five terminal plates, the five basals, the apical central plate, the ten oral ambulacral plates, and twenty other ambulacral plates are formed), interbrachially between the oral ambulacra.

Orals have not been discovered in the **Echinoidea**. Whether

certain pieces of the calcareous ring of the *Holothurioidea* correspond with the orals of other *Echinoderms* cannot at present be determined.

C. The Perisomatic Skeleton.¹

All those skeletal pieces which protect the body, between the apical and the oral systems, taken together, form the **perisomatic skeleton** of the Echinodermata. It is obvious that the extent of the perisomatic skeleton must vary inversely with that of the polar (apical and oral) systems. Where the polar systems form only a small part of the body wall the perisomatic skeleton is the more strongly developed, and *vice versâ*. In the *Blastoidea*, for example, nearly the whole of the test is formed by the polar systems (especially the apical), while in most *Echinoidea*, *Asteroidea*, and *Ophiuroidea*, the perisomatic system covers nearly the whole body. Where the equatorial zone of the body is produced into variously shaped branched or unbranched arms, as in most *Pelmatozoa*, *Asteroidea*, and *Ophiuroidea*, the skeleton of these arms is exclusively formed by perisomatic pieces. It is at present impossible to prove any definite homologies between the parts of the perisomatic systems throughout the Echinodermata.

I. *Holothurioidea*.

In the cutis of the *Holothurioidea*, as well in the body wall as in the wall of the tentacles, ambulacra, tube-feet, and ambulacral papillæ, there are found enormous numbers of microscopically minute calcareous bodies of definite shapes (Fig. 300). These give the integument a firm and rough consistency. Their principal significance may well be that of protection. These small calcareous bodies may be called, according to their shapes, "anchors," "wheels," "rods," "anchor plates," "crosses," "lattices," "stools," "buckles," "biscuits," "cups," "rosettes," etc.

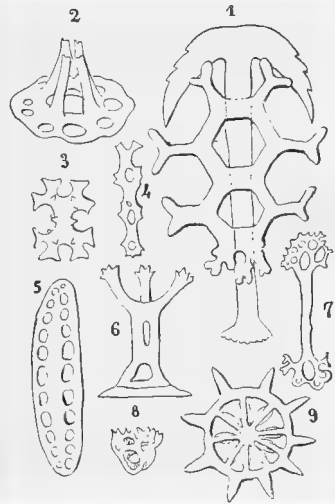

FIG. 300.—Microscopic calcareous bodies of *Holothurioidea*. 1, Anchor and anchor plate of *Synapta inhærens*, O. F. M.; 2, "stool" of *Cucumaria longipeda*, Semp; 3, cruciform body of *Cucumaria crucifera*, Semp; 4, rod from one of the tube-feet of *Sticopus japonicus*; 5, supporting plate from one of the tube-feet of *Styichopus japonicus*; 6, "stool" of *Holothuria Murrayi*; 7, rod from the ventral ambulacral appendages of *Oneirophanta mutabilis*, Théel; 8, latticed hemisphere of *Colochirus cucumis*, Semp; 9, "wheel" of *Acanthotrochus mirabilis*, Dan. and Kor.

¹ On the author's use of the term "perisomatic," see footnote, p. 362.

The shape and method of association of these bodies is of importance for classification, especially for distinguishing one species from another. Nearly all their various forms can be traced back, in a way which cannot here be further described, to a common form, viz. to a very short rod, which tends to branch dichotomously at each end. In some *Dendrochirota* (*Psolus*, *Theelia*, etc.) the calcareous bodies upon the (physiologically) dorsal side of the body attain a specially large size (1 to 5 mm.), so that the back appears to the naked eye to be covered with scales or plates (Fig. 228, p. 287).

In the *Dendrochirota* an anterior part of the body, the proboscis, is invaginable. At the posterior boundary of this proboscis (when evaginated) **five calcareous oral valves** are found in a few genera. When the proboscis is invaginated these come to lie close together in the form of a rosette, which protects the aperture. In *Psolus* these five oral valves are placed interradially, and each is a large triangular calcareous plate (Fig. 228, p. 287); in *Colochirus*, *Actinocucumis*, etc., they are arranged radially and consist of compact masses of calcareous granules and ambulacral papillae. In many *Aspidochirota* and *Dendrochirota* radially or interradially arranged anal valves (anal plates or anal teeth) also occur round the anus.

II. Echinoidea.

The skeleton of the *Echinoidea* forms a plated covering called the test, which encloses the viscera. The greater part of this test is composed of the plates of the perisomatic system, since, as a rule, the plates of the apical system (the central plate, the periproctal plates, the basals and radials) occupy but a small, and even sometimes a minute, area at the apical pole. There are, however, exceptions to this rule, e.g. the Triassic genus *Tiarechinus*, in which a considerable portion of the test is formed by the plates of the apical system (cf. Fig. 231, p. 289).

The form of the shell is thus, as a rule, in the Echinoidea, determined by the perisomatic skeleton. The horizontal outline of the shell, i.e. the outline seen when an Echinoid shell is viewed from the oral or the aboral pole, is called the **ambitus**. This ambitus in *regular Echinoids* is, as a rule, strictly circular, or else pentagonal with rounded corners; less frequently it is oval, in which case the greatest diameter of the ambitus need not coincide with the symmetrical axis. In *irregular Echinoidea* the ambitus is symmetrical, being generally elliptical (lengthened from before backward), or else egg- or heart-shaped.

In all *Echinoidea*, except the *Spatangoida*, the **mouth** lies at the centre of the oral surface of the test; in the *Spatangoida* it has shifted anteriorly on this surface. The mouth, however, always remains the centre round which the plates of the perisomatic skeleton are grouped.

We have already seen that in regular endocyclic forms, the anus lies in the centre of the apical system, but in exocyclic forms it leaves the apical system and enters the posterior interradius, where it may approach the ambitus, or even cross it on to the oral surface, always, however, remaining in the posterior interradius.

The whole perisome, from the mouth to the apical system, falls into two sections: (1) a small portion surrounding the mouth, the **peristome** or oral area; and (2) the larger remaining portion between the peristome and the apical system, the **corona**. In the peristome the skeletal pieces are usually loosely embedded near one another, or imbricate one with the other, remaining movable one against the other. Sometimes the peristome is membranous, without skeletal pieces. In the corona the skeletal pieces are usually firmly connected with one another by means of sutures, like the plates of the apical system, together with which they form a rigid test. In dead *Echinoidea*, and in nearly all fossil forms, this test remains intact, while the skeleton of the peristome falls to pieces, and is therefore rarely preserved.

The perisomatic skeleton in all Echinoidea consists of two systems of plates, which run from the apical system over the ambitus to the mouth as ten meridional zones; five of these zones or systems of plates are placed radially, and these are called the **ambulacra**. These five zones, on which the tube-feet rise, are always in contact with the five radial (ocular) plates of the apical system, so that each ambulacrum touches an ocular plate with its apical end. The ambulacral plates are perforated for the passage of the ambulacral vessels, which serve for swelling the tube-feet. The five other zones or systems of plates are interradially placed, and are called **interambulacra** or interambulacral plate systems. They alternate regularly with the ambulacra.

Considering the perisomatic skeleton of the Echinoidea more closely, the following special points are worth attention.

(a) **The Number of the Vertical or Meridional Rows of Plates in the Ambulacra (radii) and Interambulacra (interradii).**

In all *Euechinoidea* (from Devonian times up to the present), the corona consists of twenty meridional rows of plates, ten of which united in pairs belong to the ambulacral system, and ten also in pairs to the interambulacral system. Five double rows of ambulacral plates thus regularly alternate with five double rows of interambulacral plates.

In the exclusively Palæozoic *Palæechinoidea*, the number of meridional rows of plates in both ambulacra and interambulacra varies. The number of rows in all the five ambulacra and in all the five interambulacra of individuals of one and the same species is, however, always the same.

In the ambulacra, however, the number of rows of plates in the Palæechinoidea is usually two. The *Melonitidae* (Fig. 301) form the only exception, having four to ten rows in each ambulacrum.

In the interradii, on the other hand, the number of rows of plates varies. *Bothriocidaris* has only **one** single row of plates in each interradius. In all other *Palæechinoidea* there are more than two (3-11) rows of plates in each interradius (Fig. 230, p. 289). The interesting genus *Tiarechinus* (Fig. 231, p. 289) is distinguished by the great simplicity of its interradial system of plates; in each interradius there are only four plates, a single one at the edge of the peristome—the large **marginal plate of the peristome**—and three intercalated between this and the

adjoining apical system, these plates being separated by meridional (perpendicular) sutures.

The plates of the *Echinoidea* are most frequently pentagonal. In the two perpendicular rows of an ambulacrum or an interambulacrum the consecutive plates usually alternate in such a way that the suture between the two rows forms a zigzag line. The sutures between the plates, which lie one below the other in a row, usually run horizontally (Fig. 232, p. 291).

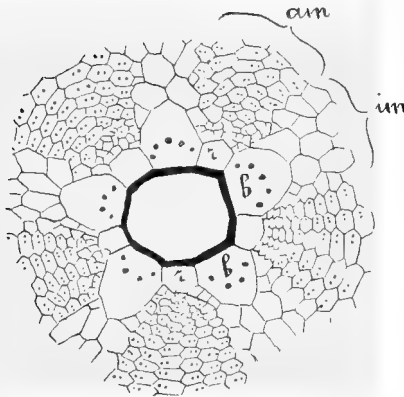

FIG. 301.—Apical system and adjoining peristome of *Melonites multipora*, Norw. (after Meek and Worthen). For lettering see p. 317.

(b) The Pores perforating the Plates of the Ambulacral System.

As a rule, in the Echinoidea, the pores occur in pairs. These double pores occur only on the ambulacral plates. One double pore belongs to each ambulacral foot.¹ From the ampulla, under the test (at its inner side), two canals run out, which, running separately through the plate, unite at the base of the tube-foot to

form a single canal, which runs through the foot and ends blindly at its tip. Originally, there was only one pair of pores on each ambulacral plate. Where two or more pairs occur on one plate, the plate can be proved to be composed of just as many fused plates as there are pairs of pores. **Primary plates** are such as reach from the lateral edge of a two-rowed ambulacrum as far as the median suture between the two rows of ambulacral plates. **Half plates** are such as do not reach the suture, and **included plates** such as do not reach the edge of the ambulacrum. **Isolated plates** reach neither the edge nor the median suture of the ambulacrum.

Besides the double pores there are, in the *Clypeastroidea* and *Spatangoida*, single pores as well, to which small tentacles belong. The arrangement of these pores varies, and they are often not confined to the ambulacra, but are also found on the interradii, especially on the oral surface. Occasionally they are scattered, often in grooves, the so-called ambulacral grooves, which radiate out from the peristome, and may stretch more or less far towards the ambitus or even beyond it, and may be more or less branched.

(c) The Symmetry of the Echinoid Shell.

The test of the **regular Echinoids** (*Cidaroida*, *Diadematoida*, and most *Paleocchinoidea*), viewed superficially, appears to be strictly radiate. The anal area lies at the apical, and the oral area at the diametrically opposite oral pole. All the ambulacra and interambulacra appear similar one to the other, and the ambitus, with few exceptions, is circular or regularly pentagonal with rounded corners. In the *Holectypoida* also the test, as a rule, appears radial, with regard both to the circular (or regularly pentagonal) form of the ambitus and to the similar development of the ambulacra and interambulacra. The peristome occupies its place at the centre of the oral surface. Notwithstanding this, the longitudinal axis and the

¹ For the different forms and arrangements of these feet or tentacles, cf. section on the ambulacral system, p. 416 *et seq.*

plane of symmetry can be recognised in the *Holactyopoida* at the first glance, because the anal area has shifted out of the apical system, and into that interradius which is called the posterior interradius. The same is the case in the *Clypeastroïda*, and, in a still higher degree, in the *Spatangoida*. In the *Clypeastroïda* the peristome with the mouth still remains in the centre of the oral surface, or only very slightly shifts away from this position. But the ambitus is no longer circular or regularly pentagonal; its outline appears symmetrically lengthened or shortened in the direction of the longitudinal axis, in such a way that, even in a superficial view, the plane of symmetry is discoverable. Apart from the fact that the posterior interradius is at once recognisable by the anus lying in it, it is often further distinguished in the *Scutellidae* by a perforation through the test (**lunula**), which never occurs in the other interradia. Further, in the *Scutellidae*, the bilateral symmetry is often distinctly indicated by the number and arrangement of the radial lunulae, or of the marginal incisions (Figs. 233-235, pp. 292, 293).

The bilateral symmetry, which is most pronounced in the *Spatangoida*, culminates in the remarkable family of the *Pourtalesiidae*. The ambitus, which varies greatly in details, is frequently egg-shaped, or heart-shaped, and in *Pourtalesia* flask-shaped. Not only does the anus always lie somewhere in the posterior interradius, but the oral area also shifts from the centre of the oral surface, moving more or less far along this surface anteriorly. In the *Cassidulidae* all the transition stages between a central and a frontal position of the oral area occur. Since the mouth, with the oral area, always forms morphologically the centre of all the systems of radii, in shifting anteriorly it necessarily draws along with it the systems radiating out from it. We shall return later on to the dissimilarity in the ambulacra, and especially to the abnormal development of the anterior ambulacra, and consequent formation of the bivium and trivium, to the special form of the peristome of the *Spatangoida*, etc.

The apical system also does not always remain at the dorsal centre of the test, but shifts more or less far forward (less frequently backward), and the highest point of the test may then come to lie in front of (less frequently behind) its central point (Figs. 236-238, pp. 294, 295).

We have seen that in exocyclic Echinoidea (in which the anal area lies somewhere in the posterior interradius) the longitudinal axis and the plane of symmetry can easily be made out even in a superficial examination, they can also be discovered by careful observation, even in regular endocyclic Echinoidea, which are apparently strictly radiate. When describing the apical system, the constant relation of the outer apertures of the pores of the stone canal to the right anterior basal plate, was pointed out. These relations never quite disappear, and where the apical system is retained, they define with certainty the longitudinal axis and the plane of symmetry.

Further, even where the apical system has not been retained, it is always possible, as has been proved by a very careful investigation of the Echinoid test, to determine the longitudinal axis and the plane of symmetry by the definite and constant arrangement of the plates of the test, both in regular and irregular endocyclic and exocyclic Echinoids. This constant relation of the plates to one another is expressed in **Lovén's law**.

Let the test of any *Spatangoid* be laid with the dorsal (apical) side on a perpendicular surface, in such a way that the mouth is directed upward, and the posterior unpaired interradius (between the bivium) downward. Let the five ambulacra be then marked with the figures I, II, III, IV, V (Fig. 302), starting from the left lower ambulacrum (the right posterior of the animal) and proceeding in the direction in which the hands of a watch travel. Two plates of each ambulacrum, the so-called marginal peristome plates, take part in forming the boundary of the peristome. The first marginal plate which is met with in each ambulacrum, when

moving from left to right may be marked *a*, the second *b*, and these letters may further indicate the rows to which these plates belong. In this way we can name each of the ten ambulacral plates bordering the peristome. Examining these ten plates carefully, we see that those indicated by *Ia*, *IIa*, *IIIb*, *IVa*, *Vb*

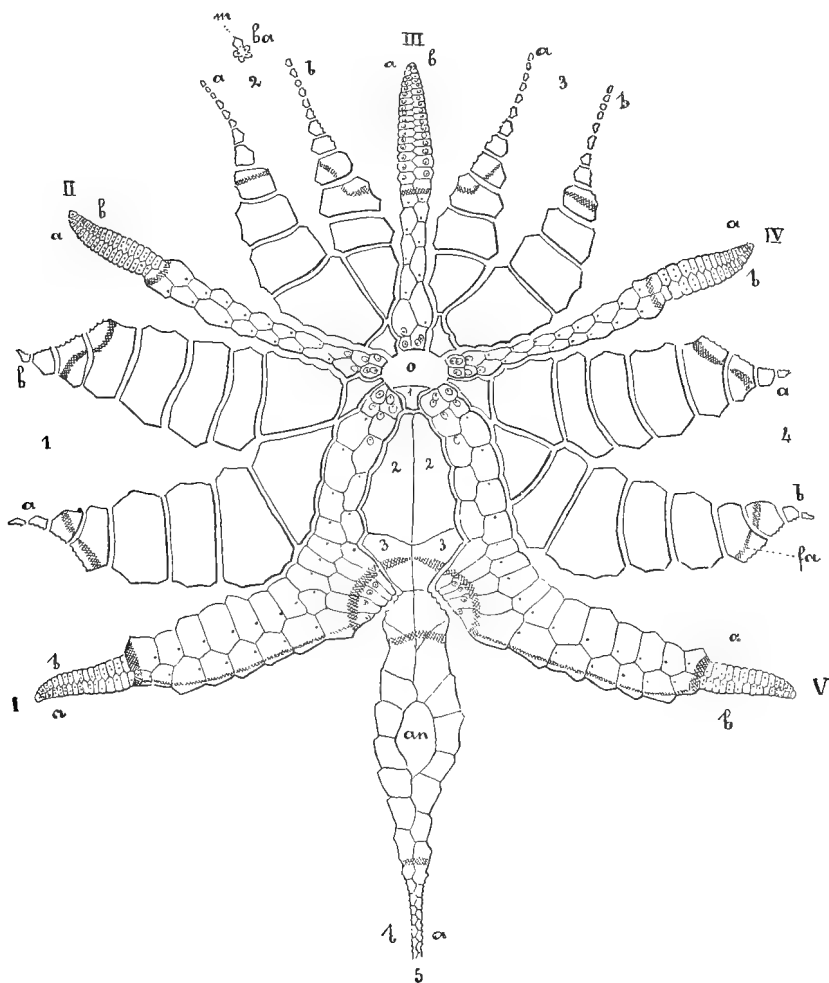

FIG. 302.—*Kleinia luzonica* (Gray). Apical system, spread out (after Lovén). *fa*, Fascioles. Further explanations in the adjoining text.

are larger and possess two pores each, while the smaller plates *Ib*, *IIb*, *IIIa*, *IVb* and *Va* have only one pore each. Only the ambulacra I and V, *i.e.* the two posterior ambulacra, are thus bilaterally symmetrical, while the two (paired) anterior ambulacra II and IV, and the two rows of plates of the anterior unpaired ambulacrum III, are asymmetrical. This law holds for all Echinoidea (not only for adults but for their young stages also); the plates *Ia*, *IIa*, *IIIb*, *IVa*, *Vb* are

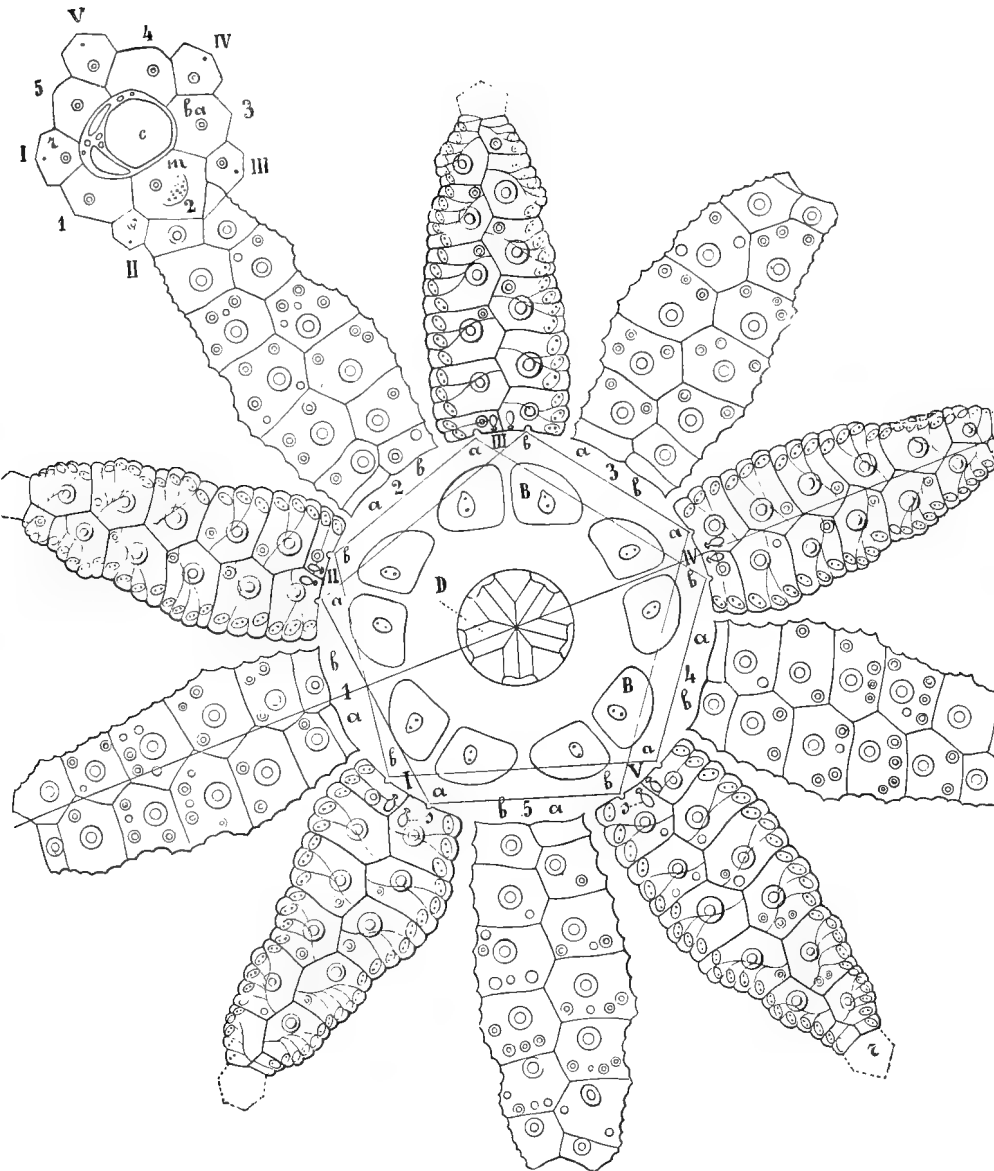

FIG. 303.—*Toxopneustes dræbachiensis* juv., 4 mm. in diam. The whole system of plates spread out in one plane (after Lovén). B, Peristome plates. D, teeth.

marked by common characters, and are distinguished from the plates *Ib*, *IIb*, *IIIa*, *IVb*, *Va*, which also resemble one another. These different characters are, it is true, often not very evident.

As a further example, let us take the test of a young *Toxopneustes dræbachiensis*, 4 mm. in diameter (Fig. 303). If we examine it we shall find that, of the ten ambulacral plates bordering the peristome, five, belonging to different ambulacra, are of greater size (consisting each of three primary plates), and show three double pores, while the five others are smaller (consisting of but two primary plates) and are perforated by only two double pores. We can place the test in only one position, viz. that given in the figure, in which the formula Ia, IIa, IIIb, IVa, Vb, and Ib, IIb, IIIa, IVb, Va holds good. In this we see that a median plane, corresponding with that of the *irregular* Echinoidea, can be established also for the *regular* Echinoidea. The accuracy of this law can be proved by investigating the position of the madreporite. In the above case this actually lies in the right anterior basal plate between the radii II and III.

Lovén's law also applies to other plates besides the ambulacral marginal plates of the peristome.

It may be remarked in passing here that the system of marking above described can be used for naming all the plates of the Echinoid test; in this way we have the ambulacra I-V, the ambulacral rows of plates Ia, Ib, IIa, IIb, IIIa, IIIb, IVa, IVb, Va, and Vb, and in the apical system the radials I-V. If we mark the inter-radii (interambulacra) 1-5, starting from the one lying to the left of ambulacrum I, and proceeding in the direction of the hands of a watch (viewing the test orally), we get the interambulacral rows of plates 1a, 1b, 2a, 2b, 3a, 3b, 4a, 4b, 5a, 5b, and the basals 1-5. The madreporite lies in basal 2. The consecutive plates, counting along each row of ambulacral and interambulacral plates, start from the edge of the oral disc.

The arrangement of plates revealed by Lovén's law, taken together with the special position of the madreporite, and with the excentric position of the anus in the anal area of the regular Echinoids, show us that, strictly speaking, no Echinoid is either radially, or bilaterally, symmetrical.

(d) **The Relation of the Ambulacral and Interambulacral Plates to the Peristome.**

Three cases must be distinguished.

1. The plates, both of the ambulacra and of the interambulacra, are continued in a modified form over the edge of the peristome, and on the peristome itself, towards the mouth (*Cidaroida*, Fig. 304).

2. Only the ambulacral plates are continued on to the oral integument (*Diadematoida*), forming either several concentric rings of plates (*Streptosomata*, *Echinothuridae*), or as five pairs of plates lying isolated in the integument, the so-called **buccal plates** (*Stereosomata*).

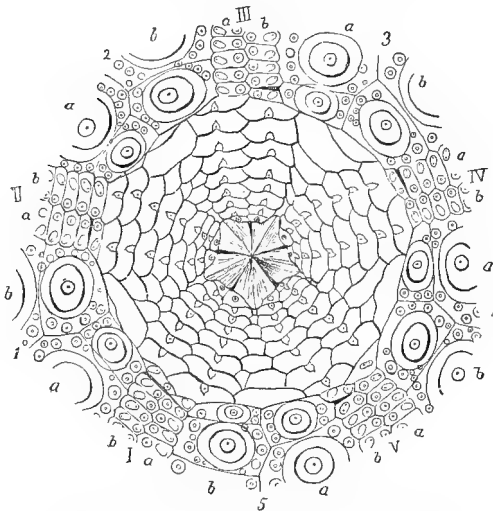

FIG. 304. — Peristome and neighbouring parts of the test of *Cidaris hystrix*, Læmk. (after Lovén).

3. Neither the ambulacral nor the interambulacral plates are continued on to the peristome (*Holactypoida*, *Clypeastroida*, *Spatangoida*).

Among the *Palaechinoidea* also there are forms in which the perisomatic plates reach as far as the mouth; in *Lepidocentrus*, indeed, they do this in such a way as to make it impossible to distinguish the coronal from the peristomal plates.

Apart from the peristome plates just mentioned, the oral area is beset all over with small irregularly arranged calcareous bodies.

With regard to the number of coronal plates which border the peristome (marginal plates of the peristome), it is to be noted that in regular Echinoidea (*Cidaroida*, *Diadematoidea*), and even in most *Holactypoida*, ten pairs occur, five ambulacral and five interambulacral. There are, however, certain *Holactypoida* in which, in one or several interradia, only a single marginal plate occurs. In the *Clypeastroida* (Fig. 306) and *Spatangoida* (Fig. 302) the peristome is, as a rule, bordered by five pairs of ambulacral and five single interambulacral marginal plates. Exceptions to this rule are found in the Spatangoid division, the *Cassiduloidea*, where, for example, among the *Echinoneida*, *Echinoneus* and *Amblypygus* have two marginal plates in their second and fourth interradia and only one in the others.

(e) Manner in which the Skeletal Plates are Connected.

In most *Echinoidea* the plates of the skeleton, at least those of the corona, are firmly and immovably connected together by means of sutures, and thus form a rigid test. This is not the case in very many *Palaechinoidea*, and among the

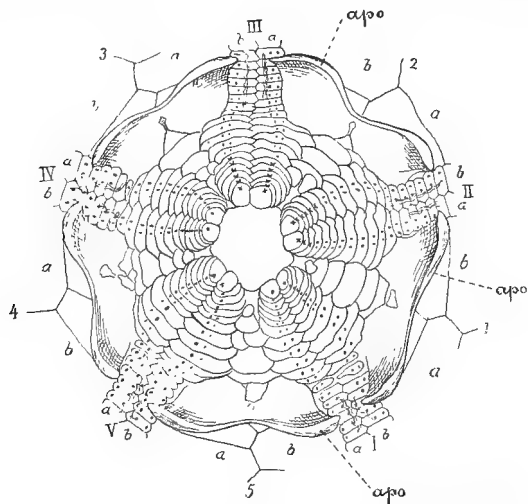

FIG. 305.—Oral area of *Cidaris papillata*, Leske, from within (after Lovén).
apo, Perignathous apophyses.

Echinoidea in the *Diadematoidea Echinothurida*; also, as far as the skeleton of the peristome is concerned, in the *Cidaroida* (Fig. 305). The edges of the plates here overlap, *i.e.* they are imbricated. In the *Echinothurida* the plates are divided from one another by strips of uncalcified connective tissue, which, to some extent, allow the test to change its shape. The imbrication of the ambulacral plates is in a direction opposite to that of the interambulacral. Viewing the test from without,

the imbrication of the ambulacra is adoral, *i.e.* the oral edge of each plate overlaps the apical edge of the next in order below it, whereas, in the interambulacra, the imbrication is apical. Lateral imbrication also occasionally occurs.

Slight imbrication is also found in certain *Spatangoïda*.

(f) **Special Modifications of the Ambulacra.**

In all Echinoidea, in which the mouth remains at the centre of the oral surface, the five ambulacra are alike in length, breadth, and in the arrangement of their

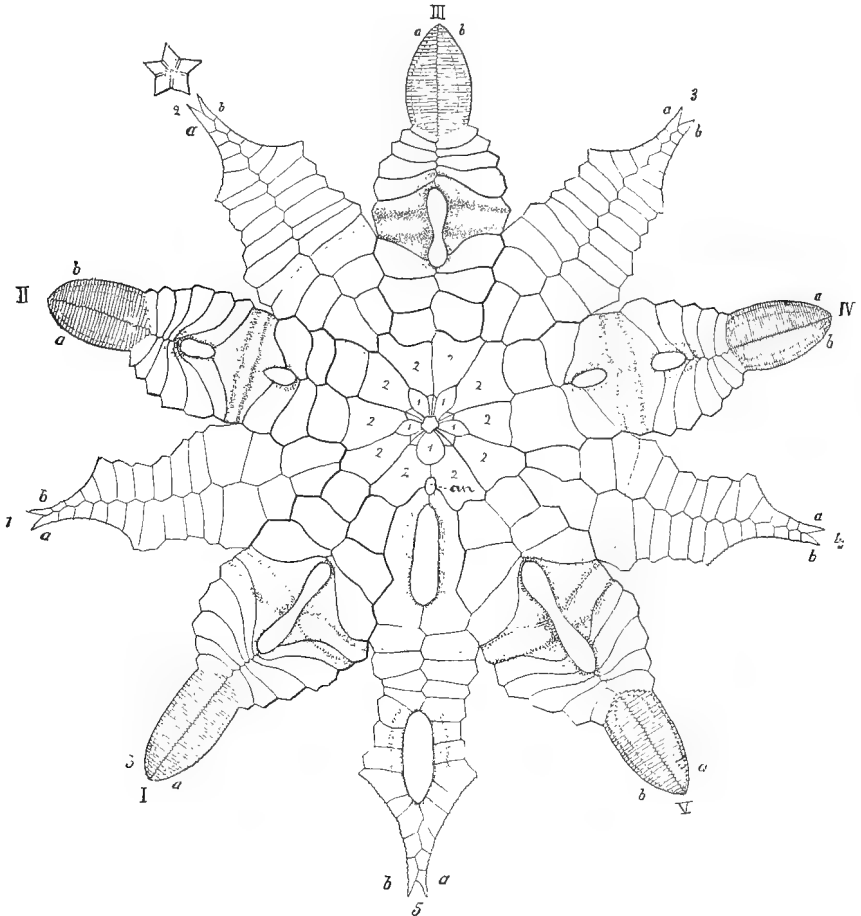

FIG. 300.—System of plates of a Clypeastroid (*Encope Valenciennesi*, Agass.), spread out (after Lovén).

pores, prominences, etc. They only vary in length when the apical system, towards which, radiating from the peristome across the ambitus, they converge, is shifted from the centre of the apical hemisphere to a somewhat anterior (less frequently posterior) position. If the test of such an Echinoid, in which the ambulacra

are of unequal length owing to the shifting of the apical system, be viewed from the oral side, the ambulacra still form a regular, or almost regular, five-rayed star round the central oral aperture or peristome. Where, however, as in the *Spatangoida*, the peristome with the mouth has moved from the centre of the oral surface (on which the Echinoids creep), and is shifted more or less anteriorly, and finally, where in the *Pourtalesia* it comes to lie quite on the anterior ambitus, the parts taken by the five ambulacra in the formation of the oral surface are necessarily very different. The unpaired anterior ambulacrum (III) and the two anterior and lateral ambulacra (II and IV) shorten and form an ever smaller portion of the whole ambulacral area of the oral (ventral) surface, in proportion as the peristome with the mouth shifts forward. They form together the **trivium**. Conversely, the two posterior radii at the same time lengthen and form an increasingly large portion of the ambulacral area of the ventral surface. They form the **bivium**. The length of the ambulacra of the trivium and the bivium in the apical direction is of course determined by the position of the apical system. If this system shifts forward, the trivium is shortened apically; if backward, the ambulacra of the trivium (especially the anterior unpaired ambulacrum) are lengthened, while those of the bivium are shortened. This grouping of the ambulacra into an anterior trivium and a posterior bivium is especially clear on the apical surface of those *Spatangoida* which have a diffused apical system, e.g. the *Collyritidae* and *Pourtalesiidae* (cf. pp. 324, 325). Since the apical ends of the ambulacra are always in contact with the radial plates of the apical system, and since, further, in the diffused apical system the two posterior radials I and V, which are separated from the anterior, are shifted posteriorly, the apical ends of the two posterior ambulacra (the bivium) are also necessarily separated from the three anterior ambulacra (the trivium) by a considerable space (Fig. 284, p. 325).

In the *Palaechinoida*, and among the *Euechinoida* in the *Cidaroida*, the *Diadematoida*, nearly all *Holactypoida*, and many *Spatangoida*, the ambulacra throughout their whole courses have a similar structure, and are similarly provided with pores. In the *Clypeastridae* and many *Spatangoida*, however, the ambulacra are modified on the apical side in a characteristic manner; they are **petaloid**, each ambulacrum forming a **petalodium** (Figs. 233, 234, p. 292; 236, p. 294, and 306). Such a petalodium arises by the divergence of the two rows of large double pores of each ambulacrum from one another immediately on leaving the apex, and their reapproximation and junction before they reach the ambitus. The two rows of pores of each petalodium make a figure like a lancet-shaped leaf, and the five petaloids together form round the apex a graceful rosette of leaves, which recalls the petals of a flower. On the remaining plates of the ambulacra, i.e. those not forming the petalodium, the pores are single and small; they are, further, few in number and scattered. Between the regular ambulacra and those which have apical petaloids there are many transition forms, occurring often within one and the same family. One of these transitions is specially frequent; the two rows of pores of a petalodium do not unite at their oral ends but remain open. The ambulacra are then called **sub-petaloid**. Such petaloids are often very long.

The petaloids often sink in (Fig. 236, p. 294), and then, not infrequently, serve as **brood cavities**, or **marsupia**, for containing the young.

Just as the ambulacra occasionally form petaloid rosettes round the apical system, so, in the family of the *Cassidulidae* (sub-order *Cassiduloida* of the order *Spatangoida*), can they form rosettes of so-called **phyllodes** round the peristome (Fig. 307). The five phyllodes, in which the well-developed double pores lie thickly crowded together, sink in, while the five interradial marginal plates of the peristome between them are contrariwise bulged out. The five interradial cushions form, together with the five radial phyllodes, what is called a **floscelle**.

The **anterior unpaired ambulacrum** in many exocyclic *Echinoidea* differs greatly, both in shape and in the number, arrangement, and form of its pores, from the other

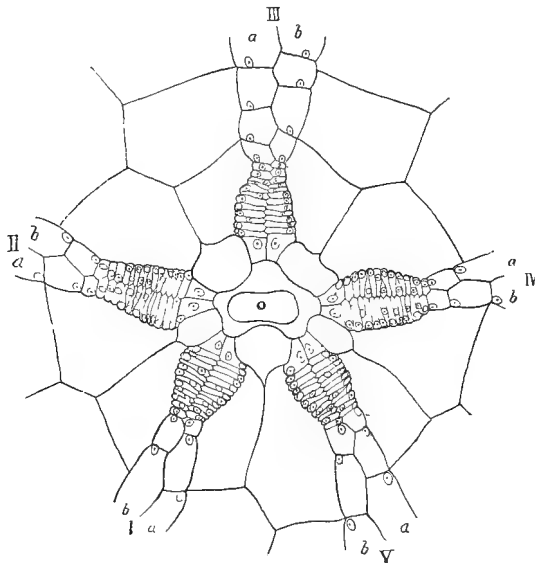

FIG. 307.—Oral perisome of *Cassidulus pacificus*, Ag., with the five phyllodes (after Lovén).

four. This variation in the anterior ambulacrum is found almost exclusively in the order *Spatangoida*, especially in the Cassiduloid family *Plesiospatangidae* and in the sub-order *Spatangoida* (here especially, and, to a very marked degree, in the family of the *Spatangidae*).

(g) Special Modifications of the Interradii.

We can here only point out certain conditions occurring in the order *Spatangoida*.

In the sub-order *Spatangoida* an **extraordinary asymmetry of the two posterior interradii 1 and 4** prevails (cf. Fig. 302, p. 342). The right posterior interradius 1 is always so modified near the peristome that two plates fuse, thus contrasting with the left posterior interradius, which remains only slightly if at all modified. This fusion takes place either between the second and third plates of the row 1*a*, or the two second plates of rows 1*a* and 1*b*, or the second and third plates of row 1*b* and the second plate of row 1*a*. In the last case, the second plates of the two rows of interradius 4 are also fused.

Since, in the *Spatangoida*, the peristome, with the mouth, is shifted forward on the oral surface, the posterior unpaired interradius occupies a considerable portion of the ventral surface (and this is also the case in the *Cassiduloidea* with mouth shifted forward). It is often somewhat bulged out, and the region occupied by it on the oral side is known as the **plastron**. It takes part in the limitation of the peristome by means of a single crescent-shaped plate, which is known as the **labrum** in those forms which have a projecting under-lip to the transverse peristome (cf. Fig. 302, p. 342). In many *Spatangoida* the labrum is followed posteriorly by two large symmetrically arranged plates (**sternum**), which again are followed by two smaller but

still not insignificant plates (**episternum**). The test is then **amphisternal**. In other forms, however, the arrangement of the plates on the plastron (apart from the labrum) approaches the usual arrangement, *i.e.* the plates of the two rows alternate more or less distinctly, so that the median suture which divides them forms a zig-zag line. This arrangement, as compared with that first described, is older and more primitive. The test is then called **meridosternal**.

In most *Clypeastridae* the interambulacra are **interrupted**, *i.e.* they do not run continuously from the apical system to the peristome, but, near the latter, are crowded out by the broad plates of the ambulacra which touch one another interradially, so that the five interradial marginal plates of the peristome are completely isolated from the remaining portions of the interambulacra (Fig. 306). Not infrequently, the paired interambulacra are interrupted and the unpaired posterior interambulacrum is uninterrupted.

(h) Form of the Peristome.

In most Echinoidea, *i.e.* in those in which the peristome retains its central position, its shape is pentagonal, or decagonal, or round, less frequently oval or oblique, or quite irregular, often with branchial incisions. But where the peristome is shifted anteriorly, as in the sub-order *Spatangoidea*, the peristome is transverse and crescent-like, with depressed anterior upper-lip and raised posterior under-lip. The peristome, however, is always central in the embryo, and is originally pentagonal.

(i) Ornamentation.

The outer surface of the plates of the Echinoid test are beset—in many different ways, which are of importance in classification—with numerous larger or smaller prominences, granules, etc., on which spines and pedicellariæ are planted.

In the sub-order *Spatangoidea*, narrow, finely granulated streaks or bands run, in definite arrangement, along the surface of the test, and carry small rudimentary spines or pedicellariæ. These are called **fascioles** or **semites** (Fig. 302, p. 342). The following systematically important forms of fascioles are to be distinguished:—

1. The **peripetaloid fasciole** encircles the apical rosette of petaloids.
2. The **lateral** or **marginal fasciole** runs round the shell near the ambitus.
3. The **lateral subanal fasciole** branches off from the peripetaloid fasciole and runs below the anus.
4. The **subanal fasciole** forms a ring below the anus (between the latter and the peristome). They may give off anal branches which run up on each side of the anus, and occasionally unite above it to form an anal fasciole.
5. The **internal fascioles** run around the apex and the anterior ambulacrum.

The tentacles and plates in those regions which are encircled by the internal and subanal fascioles are modified.

One very varied form of ornamentation of the Echinoid test, which arises early during postlarval development, is due to the deposit of calcareous substance on the plates, and is known as **epistroma**.

(k) Marginal Incisions or Perforations.

These are often to be found in the flat disc-shaped test of the *Scutellidæ*, in some or all of the ambulacra, and not infrequently also in the posterior interambulacrum. The edge of the shell is at first entire, but during growth marginal indentations and incisions make their appearance, and these may close to form perforations (**lunulæ**). (Figs. 234, 235, pp. 292, 293, and 306, p. 346.)

(l) **The Perignathic Apophysial Girdle** (Figs. 308, and 348, p. 402).

In all *Echinoidea* in which the mouth is armed with five teeth, moved by a complicated masticatory apparatus, *i.e.* in all *Echinoidea* except the *Spatangoida* and a few *Holactypoida*, processes, directed apically inwards, are found at the peristomal edge of the test; these serve for the attachment of the muscles and bands of the masticatory apparatus. They either consist solely of the ambulacral or interambulacral marginal plates of the peristome bent round inwards, or else a few of the plates next in order also take part in their formation.

These processes may be divided into those which rise on the ambulacral marginal plates, and those which rise on the interambulacral marginal plates. The former may be called the **ambulacral apophyses**, the latter the **interambulacral apophyses**.

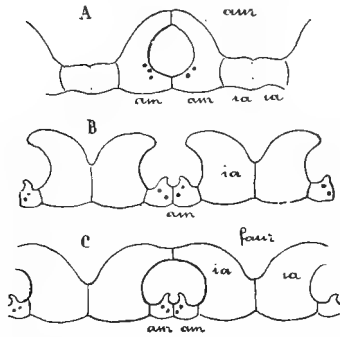

FIG. 308.—The perignathic apophyses of a radius and of the two neighbouring interradial plates of various *Echinoidea*. **A**, *Diadematoïd*. The apophyses of the ambulacral plates (*am*) form true auricles (*aur*). **B**, *Cidaroid*. Apophyses are formed, not by the ambulacral but by the interambulacral plates, forming what are called false auricles. In **C** (also a *Cidaroid*) these interambulacral plates have fused.

The apophysial circle is **closed** or **interrupted**. In the former case, which is best illustrated by the *Diadematoïda* (Fig. 308, A), an apophysis rises on the peristomal margin of each ambulacral area on each side of the ambulacral suture. The two apophyses of one and the same ambulacrum usually unite at their free ends, which project into the body, in such a way as together to form a kind of arch; this is called an **auricle**, and affords passage for some of the important organs (for the trunks of the radial ambulacral vessels, of the nerves, etc.). There are thus, in all, ten ambulacral apophyses, which may unite in pairs to form five auricles. The interambulacral apophyses project less far into the interior of the body. The two apophyses of one and the same interambulacrum together form a ridge which runs along the edge of the peristome, and connects two neighbouring auricles; these ridges are generally fused with one another and with the auricles.

Such a closed apophysial ring, which rises on the edge of the peristome and projects into the body, may be compared to a circular wall with high arched gateways at five radially arranged points. The five arched gateways would represent the auricles, *i.e.* the five pairs of ambulacral apophyses, and the circular wall would be formed of the five pairs of interambulacral apophyses.

In the *Cidaroida* (Fig. 308, B and C) the apophysial ring is **interrupted**. The ambulacral apophyses are wanting, but the interambulacral apophyses are all the more strongly developed, and form ear-shaped processes. The two apophyses of an interambulacrum are connected by a suture at their bases, but diverge at their tips. When the two interambulacral apophyses standing at the sides of an ambulacrum approximate above it (the ambulacrum), but without fusing, a **false auricle** may be formed.

The ambulacral apophyses are also wanting in a few *Holactypoida*; where they are present, they do not unite in pairs to form auricles.

In all *Clypeastroïda*, the apophysial ring is interrupted, and consists either of ambulacral or of interambulacral apophyses.

III. Asteroidea.

Here also the perisomatic portion forms by far the greater part of the whole skeleton. Only in a few forms does the apical system constitute a distinctly appreciable element in the skeleton. Further, the oral system also, even if we include, besides the orals (odontophores, proximal plates of the interbrachial system), the terminals, as radials belonging to the oral system, forms but a very small fraction of the whole skeleton.

The skeleton of the Asteroidea is distinguished from that of most *Echinoidea* by its mobility. It is not a rigid capsule, but its principal plates are articulated one with another, and are movable one upon another by means of muscles. The arms can bend upwards and downwards, and also occasionally, to a certain degree, laterally (in the horizontal plane). The ambulacral furrows may be deep, or shallow. The disc is sometimes shortened in the direction of the principal axis, *i.e.* flattened.

In the perisomatic skeleton of the Asteroidea three principal parts may be distinguished: (1) the ambulacral, (2) the interambulacral, and (3) the accessory.

(a) The Ambulacral Skeleton.

From the free end, or tip, of each arm or ray a large median groove runs on the oral side to the centre of the disc, and here runs into the

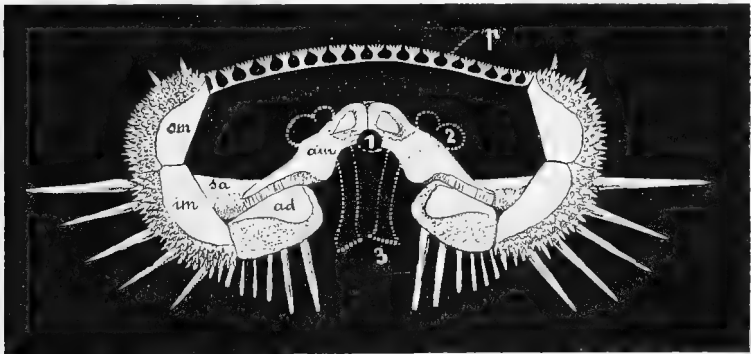

FIG. 309.—Transverse section through the brachial skeleton of *Astropecten aurantiacus* (Gray); original. For lettering see p. 317. *sa*, Supports of the ambulacral plates or supra-ambulacral plates; *ad*, adambulacral plates; *p*, paxillae; 1, position of the radial canal, etc.; 2, ampullae; 3, ambulacral feet.

mouth. In the base of this ambulacral furrow rise the ambulacral, or tube-feet in two or four longitudinal rows (Figs. 239, 243, pp. 296, 298, and 343, p. 396). The plates of the ambulacral skeleton, which

may be compared with vertebræ, and are the principal pieces of the skeleton, form a long roof over the ambulacral furrow, which opens downwards. In a transverse section through the arm of an Asteroïd (Fig. 309) we see that the roof of the furrow invariably consists of four skeletal pieces. Two of these pieces—the **ambulacral ossicles** (*an*)—form the greater part of the roof. They lie symmetrically to the median plane of the arm, and articulate with one another along the ridge of the roof. The two other skeletal pieces—the **adambulacral ossicles** (*ad*)—meet the diverging edges of the ambulacral ossicles, and so lie at the edge of the furrow, or, in other words, at the lower lateral edges of its skeletal roof.

The general form of the ambulacral ossicles is that of transversely elongated clasps. They are arranged in two longitudinal rows in close proximity to one another, and in this way form the roof, which arches over the groove along the whole of its course, from the tip of the arm to the mouth.

In the *Euasteroidea* (to which sub-class all recent forms belong) the ambulacral ossicles of the two rows are arranged in pairs, each ossicle on one side of the roof

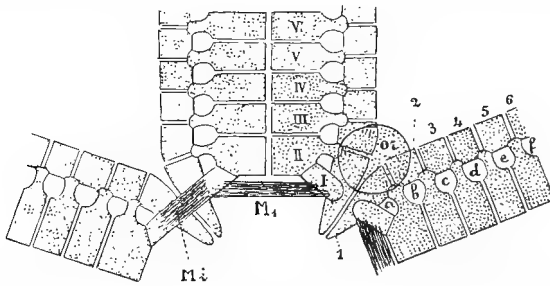

FIG. 310.—Scheme of the oral skeleton of the Asteroidea, from the inner side (after Ludwig). *or*, Oral plate (odontophore); *M*₁, first lower transverse muscle of the ambulacral furrow; *M*₂, the intraradial muscle; I-VI, first to sixth ambulacral ossicles; 1-6, first to sixth adambulacral ossicles; *a, b, c, d, e, f*, apertures for the ampullæ of the tube-feet.

corresponding with one on the other side. In the *Palæasteroidea*, on the contrary, the ossicles **alternate**, at least in the middle part of the arm.

The (smaller) adambulacral plates usually alternate regularly with the ambulacral plates.

We must here emphasise the important fact that the ambulacral ossicles of the Asteroidea lie much deeper than the skeletal pieces of the same name in the *Echinoidea*. In the latter class they are quite superficial, the radial trunks of the water vascular system, as well as the radial nerves and the spaces of the schizocoel, are to be found on their inner side; whereas, in the Asteroidea, these organs lie on the outer side under the ambulacral roof. Of the whole ambulacral vascular system only the ampullæ lie on the inner sides of the ambulacral ossicles, *i.e.* that turned towards the general body cavity.

Between every two consecutive ambulacral ossicles there is one (and never more than one) aperture for the passage of a tube-foot. The number of ambulacral ossicles in a row thus always corresponds quite accurately with the number of the tube-feet on the same side of the ambulacral furrow.

Each aperture for the passage of a tube-foot normally lies in the corner between

two ambulacral ossicles and an adambulacral ossicle (*cf.* Fig. 310). In those Asteroids which have four longitudinal rows of tube-feet, however, these apertures, at some distance from the mouth, alternate regularly in such a way that the laterally placed aperture of one interstitium is followed by a more median aperture in the next interstitium, the next again being lateral, and so on. The connecting line between the apertures of one and the same side of an ambulacrum in this case forms a zigzag, the angle of which is the more pointed the narrower the ambulacral ossicle. The consequence of this is, that the tube-feet which stand in the corners of the zigzag line appear arranged in two rows, that is, in the whole ambulacrum, in **four rows**.

The oral aperture, which always lies in the centre of the ventral surface of the disc, and into which the ambulacral furrows of the arms converge, is surrounded by a circle of firmly connected calcareous pieces, the external edges of which are in immediate contact with the ambulacral and adambulacral ossicles. This circle forms the **oral skeleton** of the Asteroidea. It is extremely probable that its separate pieces (which in the five-rayed forms number thirty, and in forms with a greater number of rays are six times as numerous as the rays) are merely the transformed and more firmly connected proximal ossicles of the ambulacral and adambulacral rows. In this case, in each ray or arm, the first two pairs of ambulacral and the first pair of adambulacral plates of these rows (in *Ctenodiscus*, the first three ambulacral and the first two adambulacral pairs of plates) would take part in the formation of the oral skeleton. The oral skeleton is **ambulacral** (in many *Cryptozonia*) or **adambulacral** (in the *Phanerozonia* and some *Cryptozonia*), according as the ambulacral or the adambulacral portions of the circle project the further into the oral cavity.

(b) The Interambulacral Skeleton.

This comprises the ambitus, *i.e.* the whole surface of the body between the oral (or ventral) and the apical (or dorsal) regions, on both of which, however, interambulacral plates may be found. The interambulacral skeleton thus forms the lateral walls of the arms. The pieces constituting it are called **marginal plates**, and are arranged in each lateral wall in two rows, one above the other. The upper row consists of the **supramarginal** (Fig. 309 *sm*) and the lower of the **inframarginal** (*im*) plates. It only rarely happens (*e.g.* in *Luidia*) that the marginal plates agree in number and length with the ambulacral ossicles. The marginal plates, which in the order *Phanerozonia* are large and well developed, become reduced in that of the *Cryptozonia*, being difficult to distinguish externally. They may be altogether wanting, or else represented merely by microscopically small rudiments. The row of inframarginal plates may be separated from that of the adambulacral ossicles by a row of small intermediate plates. In the same way a row of small intermediate plates may be intercalated between the two rows of marginal plates.

(c) **The Accessory Skeletal System.**

In this system may be included all those plates or ossicles which occur in those parts of the body not covered by the ambulacral and marginal systems. This accessory system is very variously developed, and a comparative study of it cannot here be undertaken. The plates differ greatly in size, form and ornamentation, and arrangement, sometimes being scattered or lying loosely near one another, or else closely approximated, sometimes imbricating or reticulating by means of anastomoses of skeletal pieces.

Not infrequently either the whole, or parts, of the accessory skeleton are reduced. It is often covered by a considerable layer of integument, and is difficult to distinguish externally. Its plates may diminish greatly in size, even becoming microscopically small, but they are rarely altogether wanting.

Three sub-divisions of the accessory skeleton may be distinguished :—

1. **The dorsal, abactinal, or apical accessory system**, when present, consists of skeletal plates developed in the dorsal integument of the disc and in the arms. We have seen above that in the Asteroidea the apical system only rarely takes any recognisable part in the formation of the dorsal skeleton. There are, nevertheless, forms (*e.g. Cucnidaster*) in which the large and distinct plates of the apical system form almost the whole of the dorsal protection of the disc.

2. **The ambital accessory system** consists of the intermarginal plates already mentioned as occasionally being intercalated between the supra- and the infra-marginal rows of plates.

3. **The ventral, actinal, or oral system** in the same way consists of the already mentioned **intermediate plates** which may occur between the **inframarginal** and the **adambulacral** plates. It is most developed in those forms in which the disc increases in size at the expense of the arms, *i.e.* in forms whose outline is more or less pentagonal. The ventral accessory plates then fill up the larger or smaller triangular regions between the ambulacral furrows on the lower side of the disc.

Finally, two other skeletal systems which occasionally occur in the Asteroid body must be mentioned.

In a certain number of Star-fish each ambulacral ossicle is connected by a skeletal plate, or more rarely by a row of two to three firmly united plates, through the body cavity, with a marginal plate of its own side, or else with a laterally placed accessory plate. These simple or compound skeletal pieces, which are limited to the arms, and which here correspond in number with the ambulacral ossicles, are called **supports** to the ambulacral ossicles or **supraambulacral plates** (Fig. 309 *sa*).

The other skeletal system, which occurs especially in Asteroidea with large discs, but is altogether wanting in many forms, is called the **interbrachial system**. It continues the divisions between the arms, either completely or incompletely, into the interior of the disc, and consists either of interbrachial walls, running from the oral to the actinal skeleton, or of interbrachial chains of skeletal plates descending vertically to the oral skeleton. In each interradius a proximal plate of this interbrachial skeleton, however, always enters into closer relations with the oral skeleton. These plates are the **orals**, already mentioned in the section on the **oral system**.

At the free end of each arm in every Asteroid there is to be found a single median skeletal plate, which is sometimes of considerable size and distinctly visible, sometimes small and inconspicuous; it carries on its lower side a visual organ. These plates are called **ocular plates** or **terminals**. According to recent investigations they develop very early (apparently first of all the plates) over the left

cœlomic vesicle. They must thus belong to the oral system, and perhaps, in this system, correspond with the radials in the apical system.

In the development of the Asteroidea the formative centre of each newly appearing plate in a radius of the perisomatic system is always immediately proximal to the ocular plate of the arm. At these points new plates continually appear between those last formed and the ocular plates, which thus always remain at the free tips of the arms.

(*l*) **Comparison of the Perisomatic Skeleton of the Asteroidea with that of the Echinoidea.**

The ocular plates (terminals) of the Asteroidea bear to the newly appearing plates of the perisomatic skeleton relations altogether similar to those which the radials (also "oculars") of the apical system in the Echinoidea bear specially to the ambulacral plates. Since it has not been proved that the radial plates of the Echinoidea arise over the right cœlomic vesicle, it is possible that they, although lying high up at the apex, belong genetically to the oral system, and correspond with the terminals of the Asteroidea. The radials should then not be represented in the apical system of the Echinoidea.

In a comparison of the skeletons of the Echinoidea and the Asteroidea we should then have to suppose that in the former the ambulacra have been lengthened round over the ambitus to the apex; and that, further, the body took on the form of a pentagonal pyramid, by the abbreviation of the arms and the elongation of the principal axis of the body; and that, therefore, the whole region occupied by the accessory skeleton of the Asteroid has disappeared. The marginal plates of the Asteroid would then correspond with the interambulacral plates of the Echinoid, and the adambulacral ossicles of the former with the ambulacral plates of the latter. A comparison of the ambulacral plates of the Echinoid with the plates of the same name in the Asteroid is rendered difficult by the difference of position of the two, the former being superficial, epiambulacral, and epineural, and the latter deeper, subambulacral, and subneural. The ambulacral ossicles of the Asteroid would thus not be represented in the skeleton of the Echinoid.

IV. Ophiuroidea.

(*a*) **Skeleton of the Arms.**

The brachial skeleton of the Ophiuroidea consists typically of six longitudinal rows of plates, a dorsal row (dorsal shields), a ventral row (ventral shields), two lateral rows (lateral shields), and a double row of internal ossicles lying in the axis of the arm. This system is jointed, or segmented, in quite a regular manner—one dorsal, one ventral, one axial piece and two lateral pieces together composing a skeletal segment (Fig. 311).

The external pieces together form, in each arm, a jointed tube, which determines the shape of the arm. Most of the lateral shields carry spines; on each shield there are usually four of these, one above the other, so that each longitudinal row of shields is armed with four longitudinal rows of spines. The tube-feet emerge at

regular segmental intervals through apertures which lie on each side between the ventral shields and the lateral shields belonging to them

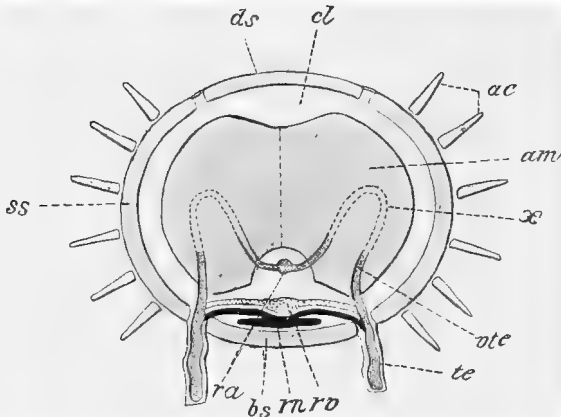

FIG. 311.—Transverse section through the arm of an Ophiurid (after Ludwig). Diagram. *ss*, Lateral shields; *ds*, dorsal shields; *cl*, cavity of the arm (coelom); *ac*, spines; *am*, the ambulacral plates (vertebrae); *x*, loop of tentacle canal in the groove on the distal face of the ossicle (cf. next fig., A 4); *r*, tentacle canal of the radial vessel (*ra*) of the water vascular system; *te*, feeler (tentacle); *rv*, radial pseudohaemal vessel; *rn*, radial nerve strand; *bs*, ventral shield.

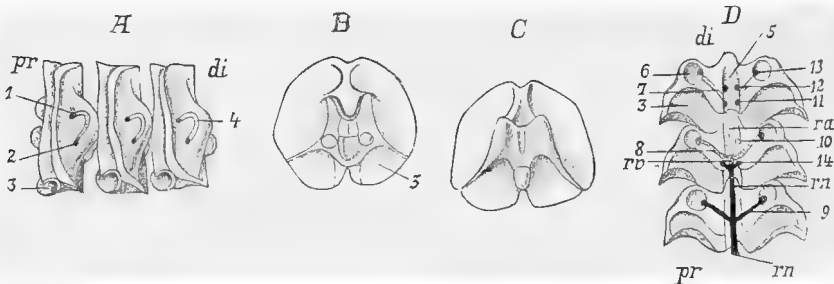

FIG. 312.—Vertebral ossicles (ambulacral plates) of *Ophiarachna incrassata* (after Ludwig), to show the articulating prominences and depressions, etc. **A**, Three vertebral ossicles from the side. **B**, Vertebral ossicles from the proximal (adoral), and **C**, from the distal (aboral) side. **D**, Three vertebral ossicles from the ventral side. *pr*, Proximal; *di*, distal; *ra*, radial trunks of the water vascular system; *rn*, radial nerve trunk; *rv*, radial pseudohaemal canal. 1, Point at which the branch of the radial water vascular trunk running to the tube-foot passes out of the substance of the vertebral ossicle at its distal side; 2, point where this branch re-enters the ossicle; 4, channel between these two points, which receives the loop of the branch belonging to the tube-foot; 3, depression for the lower intervertebral muscle; 5, channel for the radial water vascular trunk; 6, depression for the tube-foot; 7, channel for the branch of the nerve running to the tube-foot; 8, pseudohaemal vessel to the same; 9, nerve branch to the same; 10, branch of the water vascular system to the same, which at 12 passes into the substance of the ossicle, and at 13 out of the latter and into the tube-foot; 11, point at which the nerve branch (14) running to the upper intervertebral muscle, enters the vertebral ossicle.

(cf. Fig. 245, p. 300). At the edge of these apertures there are smaller spines or scales.

The axial double plates are called vertebral ossicles, a very suit-

able name, since they play a part altogether similar to that of the vertebræ of the axial skeleton in Vertebrate animals. In a large majority of cases the two lateral portions of a vertebral ossicle are fused in the median plane in such a way that no sutures are now to be seen. These ossicles, however, arise ontogenetically as two, at first entirely distinct, lateral pieces, which only fuse later. There are, further, certain deep-sea Ophiuroidea (*Ophiohelus*, Fig. 313) in which each vertebral ossicle consists, even in the adult, of two distinct slender pieces, articulated one with the other.

The vertebral ossicles fill up the greater part of the skeletal tube formed by the dorsal, ventral, and lateral shields. Between them and the tube, in dried skeletons, only small spaces are to be found, which dorsally contain continuations of the body cavity of the disc, while ventrally they contain the radial water vascular trunk, the radial nerve cord, the epineural canal, and the pseudohæmal vessel. The lateral branches of the radial vessels of the water vascular system, before entering each tube-foot, pass through, on each side, the substance of the vertebral ossicle of the corresponding segment, nearer the distal than the proximal end of the ossicle. The consecutive vertebral ossicles of the arms articulate one with another, and are connected by means of four **intervertebral muscles**. The contraction of the two upper intervertebral muscles brings about the upward curving, and the contraction of the two lower, the downward curving, of the arms. The horizontal (lateral) movement is brought about by the contraction of the upper and lower muscles of the same side. The vertical movement of the arms is very slight in true Ophiuridæ, whereas in the *Euryalidæ* the arms can be completely rolled up orally (*cf.* Fig. 246, p. 301).

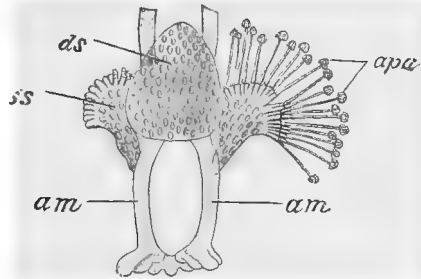

FIG. 313.—*Ophiohelus umbella*, Lym. A macerated joint from near the tip of an arm, from the dorsal side (after Lyman). *ds*, Dorsal; *ss*, lateral shield; *am*, ambulacral ossicles; *apa*, hook spines.

Small accessory plates may occur in addition to the dorsal shields. The superficial brachial skeleton is much reduced in the *Astrophytidæ* (*Euryalidæ*) and the *Ophiomyxidæ*, and the arms are, in these animals, covered by a soft integument, in which only small skeletal pieces occur. In other forms the brachial skeleton is so covered by an integument, often containing small embedded skeletal pieces, that it is either partly or altogether invisible externally.

Small accessory plates may occur in addition to the dorsal shields. The superficial brachial skeleton is much reduced in the *Astrophytidæ* (*Euryalidæ*) and the *Ophiomyxidæ*, and the arms are, in these animals, covered by a soft integument, in which only small skeletal pieces occur. In other forms the brachial skeleton is so covered by an integument, often containing small embedded skeletal pieces, that it is either partly or altogether invisible externally.

At the distal end of each arm in the Ophiuroidea there is, as in the *Asteroidea*, an unpaired **median terminal**, which surrounds the tip of the radial water vascular trunk (the terminal tentacle) in the form of a short skeletal ring. Since, in the *Asteroidea*, the terminal

plate receives the terminal tentacle in a channel on its ventral side, it is important to note that "the terminal plate in the Ophiuroidea also originally forms a channel opening downwards, and only later closes to form a ring."

The relation between the terminals and the developing brachial skeleton is the same in the Ophiuroidea as in the *Asteroidea*. The oldest skeletal segment is the one lying most proximally (orally), and of the following segments the more distal are always the younger. The plates which compose each newly appearing skeletal segment always arise at the end of the arm, on the proximal side of the terminal, which thus remains at the extreme tip of the arm.

When we consider the paired elements of the vertebral ossicles and the relative positions of the skeletal plates and the water vascular system, we are able to establish the following homologies between the components of the brachial skeletons of the Ophiuroidea and *Asteroidea*.

OPHIUROIDEA.	ASTEROIDEA.
The two lateral halves of the vertebral ossicles.	Ambulacral ossicles.
Lateral shields.	Adambulacral ossicles.
Ventral shields.	Not represented.

(b) The Oral Skeleton.

The most important and constant plates of the oral skeleton, in the Ophiuroidea, as in the *Asteroidea*, are the specially modified proximal plates of the brachial skeleton. The most satisfactory view which has been propounded as to the morphological worth of the oral skeleton is that it consists essentially of the ambulacral ossicles (the halves of the vertebral ossicles), adambulacral ossicles (lateral shields), and ventral shields of the first and second proximal skeletal segments of the arms.

If we look at the oral region of any Ophiuroid from without, *i.e.* from the free oral surface of the disc, or from within, *i.e.* after removal of the apical cover of the disc and the viscera, we see the mouth in the centre of the disc as a rosette-like, or star-shaped, aperture. The slits arranged radially round the centre are called the **buccal fissures**. Between them lie the triangular **oral-angles** (Figs. 245, p. 300, and 314). Five pairs of large plates form the frame surrounding the mouth; these are the **oral-angle plates** (Fig. 314). At the interradiial angle of each of these, *i.e.* the angle which projects towards the centre of the oral aperture, two neighbouring angle plates meet. Each angle plate has, on the side facing a buccal fissure of the oral aperture, two depressions for receiving the first tube-feet which have shifted into the oral aperture, and are known as **oral tube-feet**, or oral tentacles. There are often in addition, in the dorsal side (that facing the body cavity) of the circle of oral-angle plates, two circular furrows

or channels, one of which receives the nerve ring and the other the water vascular ring.

In *Astrophyton* part of the water vascular ring is entirely enclosed within the oral-angle plates.

Closer examination reveals the fact that each oral-angle plate consists of two fused plates, a **proximal** and a **distal**. The former,

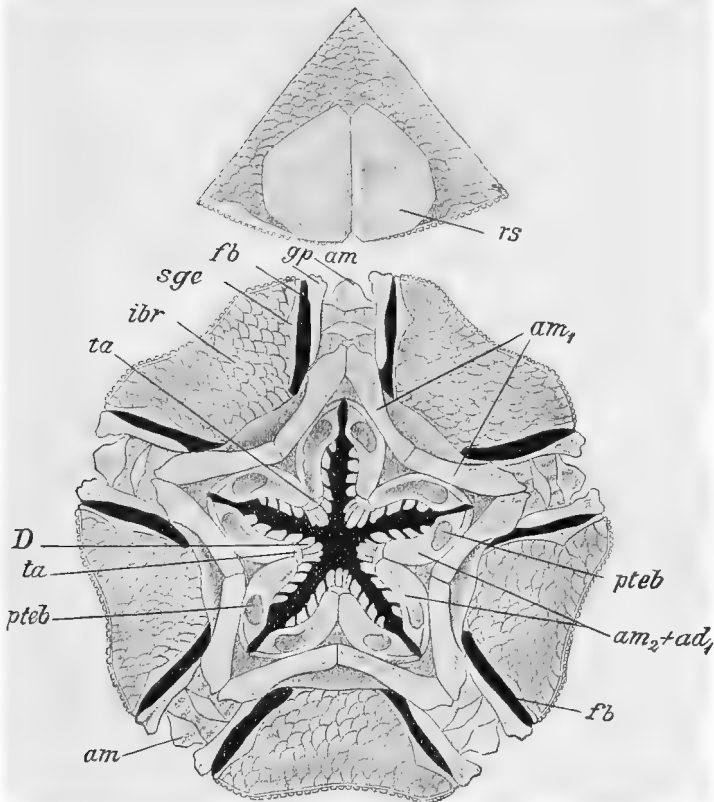

FIG. 314.—Oral skeleton of the *Ophiopora longispinus*, Lym., from within; above, an inter-radial region of the cover of the disc. *rs*, Radial shields; *am*, vertebral ossicle; *am₁*, peristomal plates; *pteb*, depressions for the oral tentacles; *am₂+ad₁*, oral-angle plates; *fb*, bursal apertures; *ta*, torus angularis; *D*, teeth; *ibr*, interbrachial region; *sge*, bursal scale; *gpl*, genital plate (after Lyman).

directed towards the centre of the mouth, fuses with the corresponding piece of its associated oral-angle plate, the two forming the oral angle. The distal plate at its distal end is in contact with a corresponding plate on the opposite side of the buccal fissure. The former of these constituents of each oral-angle plate is regarded as an **adambulacral plate** of the first brachial segment, taking part in the formation of the oral skeleton, while the distal plate is regarded as an

ambulacral ossicle of the **second** skeletal segment. It is the latter which is provided with furrows for the nerve and the water vascular rings, and with depressions for the oral feet (two on each piece). The distal portions of each pair of oral-angle plates, which together border a buccal fissure, would thus correspond with the lateral halves of a brachial vertebral ossicle, not fused together.

In viewing the under (oral) side of the disc of an Ophiuroid (Fig. 245, p. 300) we can easily recognise the interradially placed **buccal shields** (*scuta buccalia*), which are usually large, and have already been mentioned as belonging to the oral system. At the sides of each buccal shield, between it and the neighbouring oral-angle plates, lie two skeletal plates, which are known as **lateral buccal shields** (*scutella adoratia*). That these last-mentioned plates belong to the same row as the adambulacral plates (*lateral shields*) of the arms can generally easily be seen. **They are the adambulacral plates of the second segment** taking part in the formation of the oral skeleton. The third pair of adambulacral plates is thus the first pair of lateral shields in the arm.

Again viewing the oral skeleton from the dorsal or apical side (Fig. 314), we see that above the ten oral-angle plates lie ten other plates, which usually to a greater or lesser extent roof over the water vascular, and the nerve furrows. These, the **peristomal plates**, thus lie upon the inner sides of the oral-angle plates, *i.e.* the sides facing the body cavity. The peristomal plates belonging to two neighbouring radii meet interradially, and may fuse together to form single plates. The two peristomal plates belonging to one and the same radius may, in the same way, touch one another (in which case the ten plates together form a closed circle), or their radial ends may remain more or less apart. Accessory peristomal plates sometimes occur; in other cases these are altogether wanting. **The peristomal plates are considered to represent the ambulacral ossicles (halves of the vertebral ossicles) of the first segment of the oral skeleton**, a view which does not appear to be certainly established, chiefly because they are in no way connected with the tube-feet. The two pairs of tube-feet of each radius of the oral skeleton, as has been pointed out, belong to its two oral-angle plates.

At the distal end of each of the oral slits radially, viewed from without, there is, in many, indeed, in most Ophiuroidea, a plate which also takes part in the limitation of the oral cavity (Fig. 245, p. 300). This plate can at once be recognised as the **most proximal plate in the row of ventral shields**. It is the **ventral shield of the second segment of the oral skeleton**. The lateral shields belonging to them are the **lateral buccal shields**.

In a row with, but dorsally to, this ventral shield, within the buccal fissure, there is a second plate (which, however, may occasionally be wanting); this varies greatly in size and form, and is to be regarded as the **ventral shield of the first segment of the oral skeleton**.

The following table embodies this view of the oral skeleton, viz. that it consists of modified pieces of the first two skeletal segments of the radii (arms).

Skeletal Segment of the arm.	2nd (Distal) Segment of the oral skeleton.	1st (Proximal) Segment of the oral skeleton.
The two halves of the vertebral ossicle (ambulacral plates) (Figs. 311 and 314 <i>am</i>).	The distal portions of the two oral-angle plates belonging to a radius (Fig. 314 <i>am</i> ₂ + <i>ad</i> ₁).	The two peristomal plates of a radius (Fig. 314 <i>am</i> ₁).
The two lateral shields (adambulacral plates) (Figs. 311 <i>ss</i> , and 245, 4, p. 300).	The two lateral buccal shields of a radius (Fig. 245, 5, p. 300).	The proximal portions of the oral-angle plates belonging to a radius (Fig. 314 <i>am</i> ₂ + <i>ad</i> ₁).
The ventral shields (Figs. 245, 1, p. 300, and 311 <i>bs</i>).	Externally visible ventral shield of each radius of the oral skeleton (Fig. 245, 8, p. 300).	Inner ventral shield of the oral skeleton.

Accessory Parts of the Oral Skeleton.

At each oral angle (at the point where two neighbouring oral-angle plates meet interradially), on the side facing the buccal cavity, there lies a vertical row of small skeletal pieces, which may fuse together to form the **torus angularis** (Fig. 386, *ta*, p. 486). This carries the teeth (D) which project into the buccal cavity. The oral-angle plates themselves carry, at the edges which are visible externally, *i.e.* from the ventral side, small spine-like skeletal pieces. Of these those which project into the buccal fissures are called **oral papillæ**; while those which rise at the tips of the oral angles, and are turned to the axis of the buccal cavity, are called **dental papillæ**. Consequently, in each oral angle, the teeth above mentioned lie dorsally to the dental papillæ.

Accessory Skeletal Plates of the Disc.

Lower side.—The pieces already described as appearing at the surface on the lower side of the disc, and which belong to the oral system (oral shields) or to the oral skeleton (oral-angle plates, lateral buccal shields, ventral shields), hardly ever form the whole ventral carapace of the disc. On the contrary, between the roots of the arms (interbrachially or interradially) these plates leave free spaces (Figs. 245, p. 300, and 314 *ibr*); these are often triangular, and are sometimes covered with plates which vary in size and number, and frequently imbricate, or else they consist of soft integument with small skeletal granules scattered through it. These interbrachial regions of the disc may be armed with spines of varying length.

On either side of the root of each arm, on the ventral surface of the disc, there are one or two fissures or slits; if two, one proximal and the other distal. These **bursal apertures** (Figs. 245, 246, pp. 300, 301, and Fig. 314) lead into the bursæ, which will be described later. The adradial edge of each of these slits is usually supported by a single skeletal piece, the **genital plate**, while the interbrachial edge is plated with a row of scales, which is directly continued into the plating of the neighbouring interbrachial region.

Upper (apical) side of the disc.—It follows from what was said above (p. 327)

that the **apical system**, whether complete or incomplete, forms, in many Ophiuroidea, even in adults, the greatest, or at any rate a considerable, part of the dorsal carapace of the disc. Those regions which are not covered by the apical system are plated by the perisomatic skeleton. The plates of this skeleton vary much in size, form, number, and arrangement, and not infrequently, especially in cases where the apical system does not consist of large distinct plates, the dorsal integument of the disc is soft, and only provided with scattered skeletal pieces, which are sometimes microscopically small.

Ten large perisomatic plates appear most constantly (even more constantly than any of the circle of plates of the apical system); one pair of these lies near the base of each arm. These are called the **radial shields** (Figs. 244, p. 299, and 314 *rs*), and are often present even when there are no large plates in the rest of the dorsal carapace of the disc. Sometimes the radial shields, covered with a soft integument, reach from the base of the arm to near the centre of the disc, their presence being then outwardly marked by a graceful rosette formed of five pairs of radial ridges.

V. Crinoidea.

(*Cf.* the apical and oral systems of this class, pp. 328-333).

The perisomatic skeleton of the Crinoidea consists of: (1) The perisomatic skeleton of the calyx; (2) the skeleton of the arms and pinnulae; (3) the skeleton of the stem.

(a) The Perisomatic¹ Skeleton of the Calyx.

In this are included all the skeletal pieces of the calyx, which do not belong either to the apical system (central, infrabasals, basals, and radials) or to the oral system (orals).

In the young stalked larva of *Antedon* the skeleton of the calyx has no perisomatic pieces; it consists exclusively of the typical plates of the oral and apical systems (Fig. 270, p. 318).

The only forms in which this stage persists throughout life are those of the type **Inadunata larviformia**, *e.g.* genus *Haplocrinus* (Fig. 297, p. 334).

In all other living and extinct Crinoidea a perisomatic skeleton is developed, although it varies in extent to an extraordinary degree.

This skeleton may consist of very various systems, and may be developed both in the dorsal cup and the tegmen.

a. One, or several, or even many, pieces may appear only in the posterior or anal interradius, especially in the dorsal cup supporting or bordering the anus. These **anals**, which characterise the posterior interradius, more or less markedly disturb the regularly radial structure of the calyx.

b. In all the five interradii one or many pieces may occur, both

¹ Mr. F. A. Bather (*Natural Science*, vol. vi. pp. 418, 419: 1895), in reviewing the original German edition of this work, adduces strong reasons against the use of the term "perisomatic" as here employed by the author. The term is, nevertheless, retained in this English version because its exclusion seemed to necessitate the entire rearrangement of this Section V.—Tr.

in the dorsal cup and in the tegmen. They are called **interradials**. In the tegmen they develop in the zone between the orals and the edge of the calyx, and belong to the interambulacral system of plates. Usually, only the interradials of the dorsal cup are so called, although they are not infrequently continued, between the bases of the arms, into the interradial system of plates of the tegmen without any sharp boundary.

c. The proximal portions of the arms may, to a greater or lesser extent (to their first, second, etc. divisions), be taken into the calyx, in which case the skeletal segments of the arms (brachials) become perisomatic plates of the dorsal cup, and are known as **fixed brachials** (primary, secondary, etc., formerly called radials of 1st, 2nd, etc. orders). (For the meaning of these names, see below, the section on the brachial skeleton, p. 370.)

d. Just as interradials may appear in the dorsal cup between the five radials and the fixed brachials of the five radii, so the branches of each arm incorporated into the calyx may themselves be connected by **intercalated** plates. Those which lie between brachials of the second order are then called **interdistichals** or **intersecundibrachs**, those between brachials of the third order (after the second forking) **interpalmars** or **intertertibrachs**, etc.

When more than five free arms rise from the edge of the calyx, *i.e.* when some length of the arms and their branches is incorporated into the calyx, the food-grooves running over the tegmen from the mouth to the periphery divide dichotomously in such a way that the number of grooves ultimately corresponds with that of the free arms. The regions between the branches of the five primary radial food-grooves are as a rule also plated with small **interambulacral** pieces.

e. The food-grooves running over the tegmen from the mouth to the bases of the arms very often have a skeleton of their own, which may be continued into the ambulacral furrows of the arms and their branches. This **ambulacral skeleton** may consist of **lateral plates** (which border the furrow laterally) or of **covering plates** (which cover the furrows, changing them into passages or tunnels), or of both these sorts of plates. **Subambulacral plates** may also occur.

Special Remarks on the Perisomatic Skeleton of the Crinoid Calyx.

In the *Inadunata larviformia* (Type: *Haplocrinus*) there is no perisomatic skeleton of the calyx. This latter consists exclusively of the plates of the apical and oral systems (five basals, five radials, three of which are transversely divided, and five orals).

The first perisomatic plate of the calyx occurs in related forms, interradially, in the radial circle, and rests upon the posterior basal; it is the **anal**.

As a type of the *Inadunata fistulata*, we shall first select *Cyathocrinus*. In the dorsal cup only one perisomatic plate appears, which is found resting on the posterior basal, between the two posterior radials (Fig. 289, p. 329). The apical capsule thus altogether resembles that of the *Larviformia*. The tegmen calycis, on the contrary, shows an entirely different condition, which, however, may vary

considerably in the different species, and indeed in different individuals of one and the same species. The orals now no longer occupy the whole of the tegmen, but are supposed by some writers to be represented by certain plates which occur at its centre, and vary in number and regularity, often being replaced by small irregularly arranged perisomatic plates. The mouth is always hidden beneath them. From these supposed orals the five ambulacral furrows run over the tegmen to the bases of the five much branched arms. Each furrow is covered or bordered by two or four rows of alternating **covering plates**. Interradially there are 5 plates (**deltoids**), the edges of which meet beneath the ambulacrals and form the floors of the furrow-. They sometimes appear at the surface for a certain distance between the ambulacrals; in other cases, they are even here covered by more or less numerous interambulacrals.

In some species of *Cyathocrinus*, and in many related *Inadunata* the posterior or anal interradial area bulges out to form a **ventral or anal sac**, which is sometimes cylindrical, sometimes club-shaped or bladder-like (Fig. 315). This anal sac, besides the hind-gut, probably contained a large part of the body cavity. It is covered with numerous plates arranged in vertical rows. The plates of the neighbouring rows alternate in some species. The anus lies sometimes near the tip of the sac, sometimes on its anterior side, and is often encircled by special plates. The anal sac may attain such dimensions that it is as long as, or even longer than the arms. The first tendency to the formation of such an anal sac is met with in *Hyocrinus*, in which the posterior interradial region of the tegmen is somewhat though still only slightly bulged.

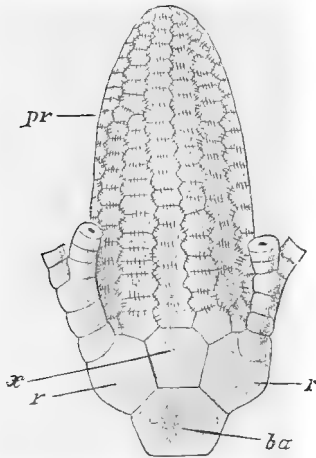

FIG. 315.—*Cyathocrinus longimanus*, after Angelin, from the anal side, after removal of the greater part of the arms. *pr*, Ventral sac; *x*, anal plate; *r*, radials; *ba*, basals.

The *Inadunata* so far mentioned are palæozoic forms. From them certain more recent types may be derived. In *Eucrinus* (Trias) the anal sac has again become a short cone. In forms closely related to this genus, and in *Marsupites* (Chalk), the anal pieces as well have disappeared, so that, while the base is dicyclic, the regularly radial dorsal cup consists only of the plates of the apical system, perisomatic pieces being, in this system, altogether wanting.

The same is the case in the dorsal cup of the family *Holopidae* (Lias to present time), *Hyocrinidae* (Lias to present time), *Bathycrinidae* (present time). In the tegmen calycis of these forms we first notice that the large anal sac of the *Cyathocrinidae* is reduced to a small anal tube. In *Holopus*, between the base of the open oral pyramid and the edge of the calyx, there is only a very narrow zone beset with irregular perisomatic plates. This zone is still wider in *Hyocrinus* (cf. Fig. 298, p. 335), and is thickly covered with numerous small plates. Between the ambulacral furrows lie the interambulacral plates; the furrows, immediately on emerging from between the oral plates, are bordered and covered by lateral and covering plates. In the posterior interambulacral area, near the edge of the tegmen, sometimes excentrically, there rises the short conical plated anal tube, with the anus. In *Bathycrinus*, where the orals are either wanting or reduced, the interradial region is either naked or plated with small pieces. The ambulacral furrows have lateral plates only. The anus lies on a very short papilla-like anal cone.

The *Canaliculata*, like the more recent *Inadunata* (Lias to present time), are distinguished by the regular radial structure of the dorsal cup, in which interradians only exceptionally occur, and special plates in the posterior interradius (anals) never occur. Very often (*Apiocrinus*, *Rhizoerinus*, *Antedonidae*) two or more brachial plates following the radials of the calyx are incorporated as "fixed brachials" into the dorsal cup.

In connection with the tegmen calycis, it must be noted that among the *Canaliculata*, orals appear in the adult only in *Rhizoerinus*. As a rule, the tegmen calycis is plated in the interambulacral regions with numerous loosely connected skeletal pieces, which vary in size according to the species and genus. These small plates are perforated by pores. This skeletal covering is not infrequently continued on to

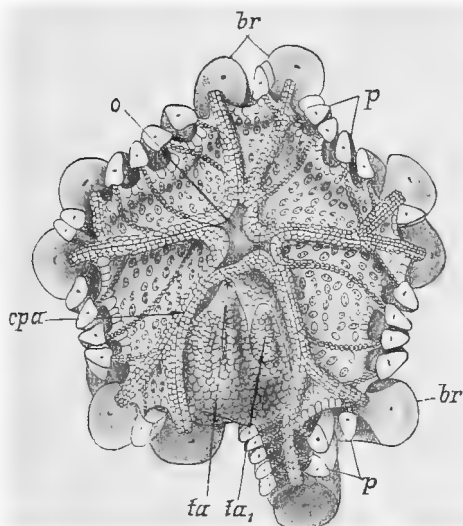

FIG. 316.—Tegmen calycis of *Metacrinus angulatus*, P. H. Carp. (after P. H. Carpenter). *o*, Mouth; *br*, arms; *p*, pinnulae (both broken off); *ta*, anal tube, near which there is a second abnormal tube *ta*₁; *cpa*, covering plates of the ambulacral furrows.

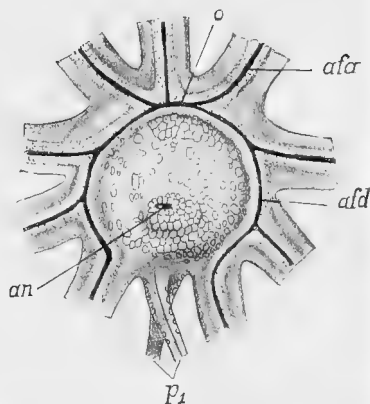

FIG. 317.—*Actinometra strotta*, P. H. Carp. (after P. H. Carpenter). Tegmen calycis. *o*, Mouth; *an*, anus; *afa*, food grooves of the arms; *afd*, the same of the tegmen; *p*₁, two pinnulae, which take the place of one of the two posterior arms.

the bases of the arms, and occasionally runs out between these apically in such a manner as to be visible in the interradians of the dorsal cup.

The ambulacral furrows of the tegmen calycis are rarely open, but usually covered with covering plates and often bordered by lateral plates (Fig. 316). Occasionally the mouth also may be covered with perisomatic plates, but it is usually open.

The anal tube in the posterior interradius varies in size and in its position within this interradian area. Its plating agrees with that of the interambulacral area on which it is found.

The interambulacral areas may also be naked, *i.e.* covered with integument containing only very small calcareous corpuscles.

Actinometra is the only recent Crinoid in which the mouth is found placed quite excentrically (anteriorly) on the tegmen, and the anus, which lies in the enlarged posterior interradian area, comes to lie

almost centrally (Fig. 317). In consequence of this shifting the ambulacra are, of course, very unequal in length.

The (paleozoic) *Camerata* are distinguished by the tendency to strong development of the perisomatic skeleton in the calyx, and by the plates being so firmly interconnected as to form a rigid test. In the formation of the dorsal cup, the bases of the arms are incorporated to a certain extent in such a manner that their lower brachials become fixed plates of the cup. In the five interradii of the dorsal cup, interradials appear, to which, in the posterior interradius, special anal plates are often added. In those cases in which the arms take part in the formation of the capsule beyond their first branchings, interdistichals, etc., may connect the branches firmly together.

The tegmen calycis also consists of plates which are usually very numerous and firmly connected together. Just as the mouth is always covered by characteristically arranged, closely fitting, orals, so also the ambulacral furrows are never open, but are always arched over by large covering plates, some of which may be distinguished by

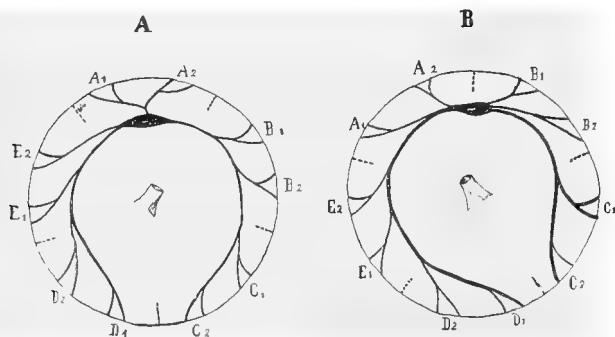

FIG. 318.—*Actinometra* (after P. H. Carpenter). Diagrams to illustrate the courses of the food grooves over the tegmen calycis. A₁-E₂, the directions of the five pairs of arms. In the centre the anal tube.

their greater size. In the older forms, the tegmen is, as a rule, rather flat, and the covering plates of the ambulacral skeleton appear at the surface. In the course of the geological development of the paleozoic epoch, however, the tegmen bulges out more and more, and finally forms a high, firmly plated "vault" or dome (Figs. 253, 254, pp. 307, 308), which, immediately behind its centre, may be prolonged to form a tube, often of greater length than the arms, with the anus at its tip. Where such a highly arched dome is developed, the interambulacral plates, which border the ambulacral furrows, send out processes over the latter. The processes (which are closely joined to one another) from one side of the ambulacra meet and become firmly connected with those from the other, so that the ambulacral furrows with their skeletons are completely arched over, and are not externally visible.

(This condition was until quite recently wrongly explained as follows. The *Camerata* possessed an inner, naked, or merely loosely plated tegmen, in which the ambulacra ran from the mouth in the centre to the periphery, and this tegmen was arched over by a firmly plated vault in such a way, that between the tegmen and the vault there was a free space.)

The interradial plates of the tegmen are often continued directly, *i.e.* without a boundary line, into the interradial plates of the dorsal cup.

The anus, surrounded by special plates, lies in the posterior interradius.

α. **The apical capsule or dorsal cup.**—In *Platycrinus*, the dorsal cup (*cf.* Fig. 254, p. 308) still consists exclusively of the plates of the apical system (three basals and five large radials). The arms are free from their bases. A plate which is found in each interradius, between the bases of the free arms and between the radials, may be considered to belong almost as much to the tegmen as to the dorsal cup. In *Hevacrinus* the radial structure of the apical capsule is essentially disturbed by the appearance of an anal plate, which presses in between the two posterior interradials in the posterior interradius, and to which, in the direction of the tegmen, two or three other anals may be added. Further, in each radius, the one small primary brachial plate present has become a fixed plate of the apical system. As a further

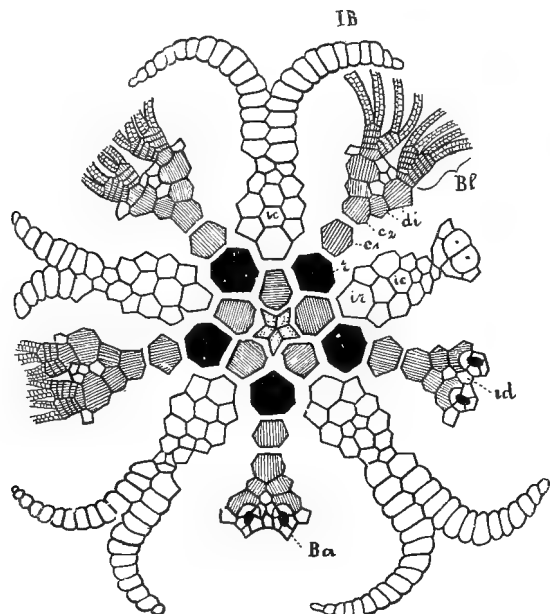

FIG. 319.—*Gilbertsocrinus tuberculatus*, Hall (after Wachsmuth and Springer). The system of plates of the dorsal cup and of the interradial appendages IB. Ba, point of attachment of the arms; Bf, commencement of the free portions of the arms. For other lettering see p. 317.

example we may take *Dimerocrinus* (*Glyptasteridae*), in which the dorsal cup is still more complicated. In each radius the radial is followed by two primary brachials, which are incorporated into the dorsal cup. In each case the second of these brachials is followed by two or three secondary brachials, which are also fixed in the dorsal cup, the last of them carrying a free arm. In each interradius there are several interradials; first a large plate which lies between the primary brachials, and then two more lying at the level of the secondary brachials. The posterior interradius is broader than the others. The first plate here lies between the radials, and agrees with them in size, then follows a second row of three plates, and, orally from these, various small plates which lead over on to the tegmen calycis. Interdistichals may also occur. *Melocrinus* (Fig. 252, p. 307) and *Dorycrinus*, etc. agree with *Dimerocrinus* in these points.

In *Gilbertsocrinus* (*Rhodocrinidae*) also, the two primary brachials and the two or three secondary brachials are incorporated into the dorsal cup (Fig. 319). In each of

the five interradial there are several (twelve) interradials, the arrangement of which is shown in the figure. The anal interradius is hardly distinguishable from the other interradial. The distichals or secondary brachials are connected by smaller interdistichals.

The perisomatic skeleton of the dorsal cup of *Actinoecrinus* (Fig. 291, p. 329) is very like that of *Gilbertsoecrinus*; but the anal interradius is much larger than the others, and its plates are divided into two lateral groups by the intercalation of a vertical row of anal plates. This is also the case in *Batocrinus* (*Actinoecrinidae*). Here, however, not only the 5×2 primary brachials and the 10×2 secondary brachials, but also the 20×2 tertiary brachials are incorporated into the dorsal cup. In *Strotocrinus* (*regalis*) an extreme form is found (Fig. 320). The calyx

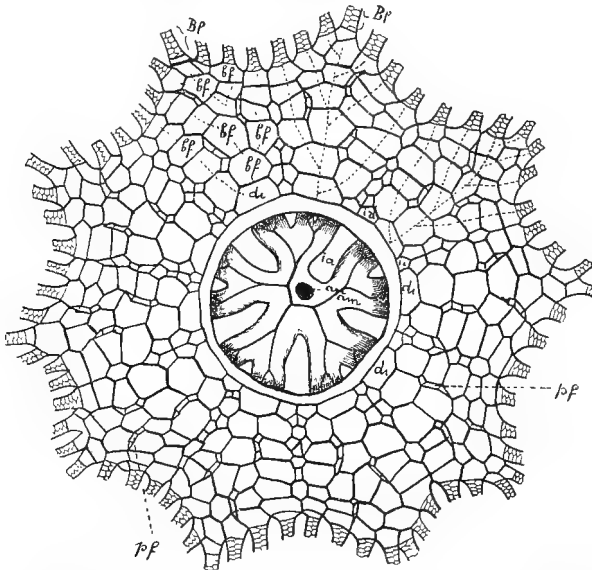

FIG. 320.—*Strotocrinus regalis* (after Wachsmuth and Springer). The apical border. The conical portion of the dorsal cup is broken away (as far as the distichals *di*) and shows the tegmen with the anus, the mouth and the food grooves. The dotted lines denote the manner of branching of the fixed arms. *an*, anus; *bf*, fixed joints of the arms, which form the border; *Bf*, the free arms which run out from the edge of the border; *ia*, interambulacral region of the tegmen calycis; *am*, ambulacra; *pf*, fixed pinnulae.

is very large. The dorsal cup consists of a small conical portion above the stalk, followed by a border spread out horizontally. In each radius each radial is followed by two primary brachials. The second costal is in each case followed by the two secondary brachials (making ten in all). Up to this point the above mentioned plates, together with the apical system, form the conical part of the dorsal cup. The plates which follow form the horizontally expanded border. Each distichal is followed by a principal row of (six) plates, which runs radially to the edge of the border, where the last plate carries a free arm. Accessory rows branch alternately from these principal rows, three on each side. These also run to the edge of the border, and the last plate of each row carries an arm-branch. Seventy free arm-branches in all thus rise from the edge of the border. In the interradial, in the interdistichal regions, and between all the further branches of the fixed arms, inter-

radials, interdistichals, etc. are found binding the brachials into the rigid horizontal border. Their number and arrangement are best elucidated by the figure. The anal interradius is not distinguished from the others in any marked manner.

b. **The Tegmen calycis.**—The tegmen of *Marsupiocrinus cœlatus* is only slightly vaulted. It is plated with numerous small, firmly connected pieces (Fig. 321). Among these, we can easily distinguish the covering plates of the ambulacra, which thus here come to the surface, and can easily be distinguished from the somewhat larger interradial and interambulacral plates. In the centre of the tegmen lie the five orals, arranged in the manner which is characteristic of the *Camerata*, and behind these, subcentrally, the anal aperture, surrounded by special plates.

If the ambulacral covering plates are larger and more massive, as in many species of the genus *Platyocrinus*, it is then more difficult to distinguish the interradial plates of the tegmen from them.

The genus *Agaricocrinus* affords examples of the specially strong development of single covering plates of the ambulacral skeleton, which are called radial dome plates. The tegmen is highly vaulted.

An extraordinarily highly vaulted tegmen is found in the *Actinocrinidæ* (*Actinocrinus*, *Batocrinus*, Figs. 253, 254, pp. 307, 308). It is regularly and firmly

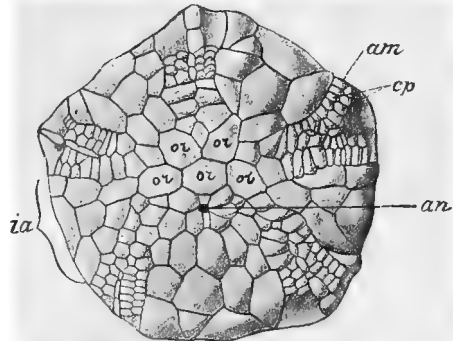

FIG. 321.—Tegmen calycis of *Marsupiocrinus cœlatus* (after Wachsmuth and Springer). *or*, Orals; *am*, ambulacra; *cp*, covering plates of the ambulacral furrows; *ia*, interambulacral region.

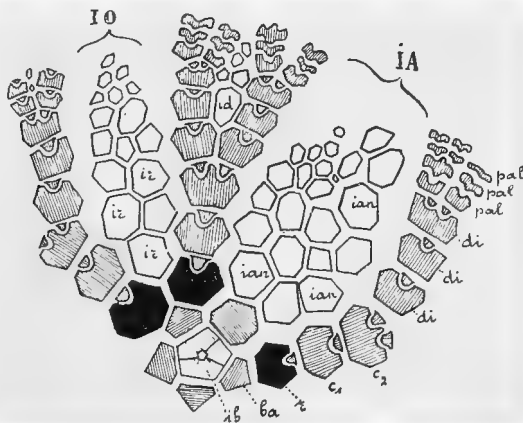

FIG. 322.—Part of the dorsal cup of *Forbesiocrinus*, spread out. For lettering see p. 317. In addition, IO, one of the four similar interradial regions; IA, the deviating anal interradial region; *pal*, palmars.

plated with large strong plates more or less equal in size. Nothing can be seen of the ambulacral skeleton externally, it having been pressed down, or rather, overgrown, as already described, by the interambulacral plates. In the posterior inter-

radius, immediately behind the centre of the tegmen, this dome is produced still further into a long tube similarly plated; this is the anal tube, on the tip of which lies the anus.

The *Articulata*, so far as the perisomatic plates of the calyx are concerned, agree with the *Camerata* in that the ossicles of the arms are sometimes incorporated into the dorsal cup as far as to their second or third divisions (Fig. 322), the primary, secondary, and often also the tertiary brachials becoming fixed plates of the dorsal cup. The number of the brachials in each arm and its branchings varies. Three primary brachials are often found in each radius. But these fixed brachials are not, as in the *Camerata*, rigidly connected *inter se* and with the radials, but are articulated. The spaces on the dorsal cup between the radii and between their branchings are filled either with quite small, loose, and irregular calcareous corpuscles or scales, or with small, definitely arranged plates (interradials, interdistichals, etc.). In the posterior interradius there are often, in addition, special anal plates frequently asymmetrically arranged.

The tegmen calycis of one species of the genus *Taxocrinus* is well known. The radii and their branchings are bulged out while the interradii are depressed. From the central mouth, which is open and surrounded by five orals, the five ambulacral furrows run out, dividing dichotomously in correspondence with the branching of the arms. Each ambulacral furrow has a floor of two longitudinal rows of subambulacral plates, is bordered by lateral plates, and closed in by two longitudinal rows of covering plates. The covering plates in the two rows are alternately arranged, their interlocking forming a zigzag line, and it is very probable that they were movable, *i.e.* that they could be raised and depressed. The interambulacral regions contain a large number of small, loose, irregular plates. In the posterior interradius, at the edge of the tegmen, there is a plated process (anal tube?).

For *Thaumatoocrinus*, see "The Systematic Review" (p. 309).

(b) The Brachial Skeleton.

The calyx of the Crinoidea carries at its edge (on the boundary between the tegmen calycis and the dorsal cup) five arms, which are rarely simple, but usually branched, and in the living animal are beautifully extended. The arms can be made by stimulation to fold together over the tegmen. They are found in this position also in dead animals, and therefore almost always in fossilised individuals.

The arms, which contain important inner organs, are supported by a special brachial skeleton. This consists of consecutive calcareous pieces, the **brachials**, which are either firmly connected or articulated with one another. The brachials are deepened on their oral side, that which is directed upwards when the arms are spread out, to form a more or less deep longitudinal groove along the arms and all their branches; this is the **ambulacral groove**. In the base of this groove lie the most important inner organs of the arms (radial canals, water vessels, outgrowths of the body cavity, etc.). The soft integument which covers these organs, and stretches over the ambulacral grooves of the brachial skeleton is in its turn depressed to form a channel. These integumental channels, which accurately correspond with the ambulacral grooves of the skeleton, are called **food grooves**. At the

bases of the free arms they pass into the ambulacral grooves or food grooves of the tegmen calycis, which run to the mouth.

The arms, when divided, as they normally are, usually branch dichotomously; occasionally, however, they give off alternating branches, which may again branch alternately. In most Crinoids the arms and their branches carry, at the sides of the ambulacral grooves, closely crowded and alternating processes; these are rod-shaped, and end in a point, and are known as **pinnules**. The skeleton of these pinnules resembles that of the arm, and, like the latter, is jointed. The pinnules may best be regarded as the ultimate branchings of the arms, and it is very probable that in the numerous palæozoic *Inadunata* that have no pinnules the last branches of the arms fulfilled their functions.

The brachial skeletons in the Crinoidea are always direct continuations of the radials of the apical capsule. The first plate which follows the apical radial radially must be considered, morphologically, as a brachial or ossicle of the arm, although it is only rarely (*e.g.* in the *Inadunata*) a free ossicle. The terms introduced to denote the various orders of brachials are almost as numerous as the writers themselves. It is the clearest plan to speak of them as brachials of the first, second, third, etc. orders, or as primary, secondary, tertiary, etc. brachials. Such a plan was, however, soon found too cumbersome for practical purposes, and was supplanted by the terms **costals**, **distichals**, **palmars**, and **postpalmars**. To these terms, however, considerable exception may be taken, and it seems simplest to adopt the intelligible and congruent terms **primibrachs**, **secundibrachs**, **tertibrachs**, etc., which are capable of indefinite extension, and are readily symbolised as IBr, IIBr, etc.

It has already been pointed out, in the section which treated of the perisomatic plates of the calyx, that brachials are incorporated into the dorsal cup in many, indeed, in the great majority of Crinoids. We can accordingly distinguish **free brachials** from **fixed brachials**, the latter being those which have become perisomatic plates of the dorsal cup. The first brachials to be so incorporated are naturally the primibrachs, the next the secundibrachs, the tertibrachs may also then become fixed. In describing the skeleton in detail, therefore, the terms fixed primibrachs, fixed secundibrachs, etc. are used, and the number of these plates in each arm is given. The arrangements found in the various divisions of the Crinoidea in this respect have been already briefly described in the preceding section. That of the *Inadunata* is the simplest, since in them the arms are free from their very bases (hence the name), the first primibrach being a free ossicle of the arm; the most complicated condition is that of certain *Camerata* (*Actinoecrinoides*, etc.), in which the brachials of several orders are incorporated into the calyx, and being connected by intraradials, interdistichals, etc. lend to the dorsal cup its rich plating.

In branched arms those joints above which the divisions or branchings take place are called **axillary**, *e.g.* we have an **axillary costal**, **axillary distichal**, or, as they may more simply be called, **primaxil**, **secundaxil**, etc. (Iax, IIax, etc.).

With regard to the distribution of the pinnule, it is the rule, at least in modern Crinoids, that the **axillary joints** never carry pinnule, and that where two joints are connected by syzygial sutures or by ligaments, pinnule are also wanting on the lower or proximal joint.

There are three different ways in which the free brachials may be arranged. The arms may consist of a **single row** of joints, the brachials being superimposed in a single series with parallel surfaces of contact (**uniserial**). Again, the joints may "**alternate**," if they are wedge-shaped, and if, in the row, the thick and the thin sides

of the wedges regularly alternate. Or again, the joints may be arranged in **two series** or rows, the contact-surfaces of the one row alternating with those of the other, and the two rows themselves interlocking along a zigzag line (**biserial**).

The *Articulata*, many *Canaliculata*, and the recent *Inadunata* have the joints of their arms arranged in single rows. This condition has been proved to be ontogenetically and phylogenetically primitive, *i.e.* for the palæozoic *Inadunata* and the *Camerata*. The majority of palæozoic *Inadunata* have uniserial arms, but towards the end of the palæozoic period forms appeared with alternating rows (*e.g.* *Poteriocrinus*), and finally some genera in which the brachials may be biserial at the tips of the arms (*Eupachycrinus*, *Erisocrinus*, *Hydreionocrinus*).

Most of the *Camerata* (an order limited to the palæozoic age) have biserial arms. But by far the greater number of the Lower Silurian species have uniserial



FIG. 323.—Part of the arm of a Crinoid. Diagram showing the transition from the uniserial, through the alternating, to the biserial arrangement of the brachials.

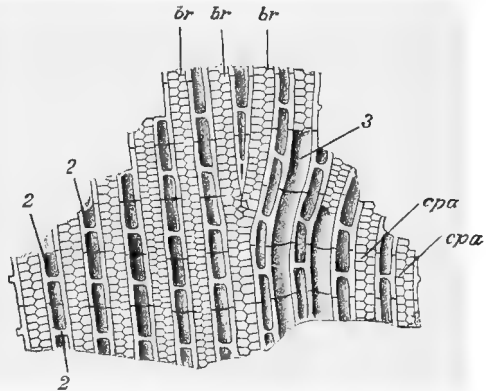

FIG. 324.—Part of the disc formed by the arms of *Crotalocrinus rugosus* (after Wachsmuth and Springer). 2, The trabecule connecting the arms; *br*, the arms with the covering plates (*cpa*) over their food grooves; in 3 these covering plates are removed.

arms. In the Upper Silurian, however, but few forms persisted with such arms, and they are found side by side with species and genera with alternating, or with two rows of, brachials.

In Crinoids whose arms have two rows of joints, the uniserial and the alternate stages are passed through ontogenetically. It must, further, be specially emphasised that not a single case is known of arms being formed of two rows of brachials throughout their whole length, *i.e.* from the radials of the calyx to their tips. At their bases the arms always, for a certain distance, have a single series of brachials, then they have alternating brachials, and finally two rows. The transformation of the uniserial arm into an alternate, and finally into a biserial one commences, ontogenetically and phylogenetically, at the tip of the arm, and proceeds from that point towards the base.

The **food grooves** of the arms resemble those of the calyx. They are sometimes naked and open, and at others provided with a variously developed ambulacral skeleton, consisting either only of lateral plates, or of lateral and covering plates. Subambulacral plates may also occur in the floor of the food grooves, dividing them from the subjacent organs of the ambulacral furrows of the skeleton (body cavity of the arms, genital strands, pseudohæmal canals, etc.). Where covering plates are present there are two rows which alternate and interlock in such a way as to form a

median zigzag line. These plates can be raised and depressed in the living animal; when they are raised the food groove is open, when depressed, it is shut.

An altogether peculiar arrangement is found in the arms of the genus *Crotalocrinus* (Upper Silurian, England. Sweden), which is thought by some to belong to the *Camerata*. The free arms branch extraordinarily frequently, the separate branches being closely crowded together, and forming together a wide expanded coherent disc round the calyx, resembling the fully open corolla of a flower. As many as 500 to 600 branches may in some forms reach the edge of this disc (*C. rugosus*, Fig. 324). Each ossicle of the arms has two lateral processes, which become connected with similar processes of the corresponding ossicles of the neighbouring arms or branches, so that the disc formed in this way by the skeleton of all the free arms is lattice-like. At definite distances from the calyx the brachials are of equal length, so that they, as well as the sutures which lie between the consecutive brachials, seem to be arranged in regular concentric rings round the calyx. The whole brachial disc was very flexible, and could be rolled up over the calyx from its periphery. In *C. pulcher*, the brachial disc falls into five broad radial lobes, which, when the disc closes over the calyx, overlap like the petals of a bud. The food grooves are covered by double longitudinal rows of alternating covering plates.

(c) The Stem (Columna).

The great majority of Crinoids are attached to the bottom of the sea by means of a jointed stem. Among recent Crinoids only the *Antedonidae* and *Thaumatoocrinus* are, in the adult condition, non-pedunculate and unattached. The stalked condition is undoubtedly the more primitive, for (1) the Crinoids show very markedly the habitus characteristic of many attached animals, and (2) all free and unstalked *Antedonidae* pass through an early stalked and attached stage. The stem, which varies greatly in length and thickness, consists of a series of calcareous ossicles one above the other, the uppermost of which is connected with the centre of the apical system, and carries the calyx with its arms.

The ossicles of the stem (**columnals**) vary greatly in shape. They may be flat and disc-like, or long and cylindrical; sometimes they are gradually thickened towards each end in such a way as to resemble dice-boxes. Further, the columnals in different parts of one and the same stem may be very different. The external outline of the ossicles in transverse section is sometimes pentagonal, sometimes round, rarely elliptical. They are connected with one another more or less firmly by sutures, or else are movably articulated. The stem throughout its whole length is penetrated by a central canal (**axial canal**), which thus runs through all the consecutive columnals. Within this canal run the eelomic canals (continuations of the chambered organ) and nerves. The size of the canal in transverse section differs as much as its shape. The outline of its section seems most frequently to be pentagonal or quinquelobate, but it is not infrequently round. Occasionally also the central canal is surrounded by five narrower peripheral canals.

New ossicles are added, as the animal grows, at the upper end; at first they are small and flat, and often concealed within the stem. The most constant place of their appearance is between the uppermost columnal and the base of the calyx. New ossicles may, however, also be intercalated between two already formed ossicles, but this almost always takes place at the upper end of the stem. In a growing stem the ossicles in the upper part vary greatly in length, the shortest being the youngest.

At definite intervals the stem may carry whorls of so-called **cirri**. These are jointed processes of the stem, pointed at their tips, and perforated by a longitudinal canal which communicates with the central canal of the stem (Figs. 257, 258, pp. 311, 312).

The cirri are, as observations on living animals have shown, very mobile. Five cirri, as a rule, belong to one whorl, being inserted on the five sides of the **nodal ossicle**. Between two consecutive nodes there are a varying number of columnals which do not carry cirri. These together form an **internode**. Whereas in the *Inadunata*, *Articulata*, and *Camerata* cirri are, as a rule, wanting, or only present at the lower part of the stem, in the *Canaliculata* (*Pentacrinidae*) nodes are found along the whole length of the stem between the consecutive internodes. In the

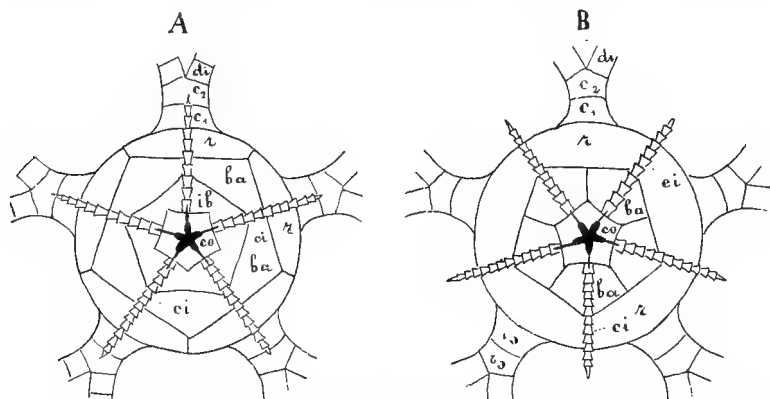

FIG. 325.—Diagram to elucidate Wachsmuth and Springer's rule. A, Crinoid with dicyclic base. B, Crinoid with monocyclic base. For lettering see p. 317.

recent species of *Pentacrinus* and *Motacrinus*, each nodal ossicle is connected with the next ossicle of the internode below it by a syzygial suture.

Peculiar relations exist between the stem and the base of the apical capsule, according to the "rule of Wachsmuth and Springer," given in the diagram Fig. 325. In Crinoids with dicyclic base (*i.e.* where the base consists of basals and infrabasals, with pentagonal stem and five-rayed central canal, the five edges or angles are interradially arranged, while the five rays of the central canal and the five cirri of each whorl are radially arranged. In Crinoids with monocyclic base (*i.e.* where the base consists exclusively of the basals, Fig. 325 B) the reverse is the case. In those Crinoids which possess cirri, and in which the stem and central canal are not round, the character (monocyclic or dicyclic) of the base of the calyx can be determined—apparently with great certainty—from an examination of the stem. This is of importance in forms in which the infrabasals are very small, or, being covered by the uppermost joint of the stem, are hidden, or when they occur only in a young stage. Such forms are said to be constructed on a dicyclic plan, and have been called "pseudo-monocyclic." It is possible that certain genera in which Wachsmuth and Springer's rule appears to be violated may eventually be proved pseudo-monocyclic. Meanwhile, however, the rule is not absolutely universal.

The lower part of the Crinoid stem is called the **root**. It serves, in various ways, to attach the body to the sea floor. If the latter

be muddy or sandy, the base of the stem puts out lateral branches, the so-called **root-cirri**, the numerous ramifications of which penetrate the sea floor in all directions. The end of the stem itself may at the same time branch like the root-cirri. When the sea floor is rocky, the root-cirri spread out more horizontally, accommodating themselves to the surface to which they are attached, and becoming cemented to it at their ends by means of a calcareous secretion.

Further, it is almost certain that individuals of some species, e.g. *Pentacrinida* and some Palæozoic crinoids, are capable of free locomotion when the stem is either voluntarily or accidentally broken. Such locomotion is no doubt chiefly promoted by the movements of the arms, the cirri serving rather for attachment.

In *Holopus* (Fig. 250, p. 305) the stem is wanting. The calyx, which resembles a reversed cone in shape, is cemented to the substratum by means of an irregularly expanded calcareous mass.

The *Antedonida* are stalked and attached only in the young stage. The larval stem resembles that of the Bourgueticrinidæ (Fig. 326); the cirri are developed only on its uppermost ossicle, on which five radially arranged cirri first appear, then five interradially arranged. At a certain stage, differing in the different species, the calyx together with the uppermost columnal (i.e. the one carrying cirri), which is fused with the infrabasals to form the **centrodorsal**, separates from the stem, the latter remaining attached to the place where it was fixed. Above the cirri already formed, i.e. between them and the base of the calyx, new whorls of cirri continuously appear on the centrodorsal, which constantly increases in size, so that we are tempted to consider this piece as part of the stem, consisting entirely of nodal ossicles fused together without intervening internodes.

The *Comatulidæ* can both swim by the rowing movements of their arms, and creep by means of the cirri and of the arms. They can, further, anchor themselves by their cirri, the arms being then directed upwards.

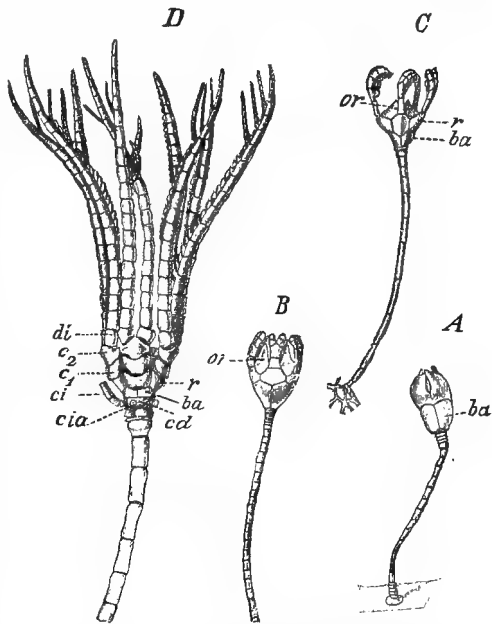

FIG. 326.—Several stalked young stages of *Antedon phalangium* (A); *Antedon spec.* (B); *Antedon tuberosa* (C); and *Antedon multispina* (D), after P. H. Carpenter. For lettering see p. 317. *cia*, Points of attachment of the cirri.

*(d) The Manner of Connection between the Skeletal Pieces.*¹

Under this head we have to consider the method of connection between the ossicles of the arms and of the pinnule, between the plates of the apical capsule, and between the columnals.

Perhaps the clearest view of the great diversity which prevails in this matter is obtained by assuming that the plates composing an echinoderm skeleton develop in a stroma of connective tissue fibrils; all the plates might thus be supposed to have been originally but loosely united by such fibrils.

This condition persists in what is known as the loose suture. The ossicles of the pinnules in many living Crinoids are united in this way.

From this loose suture we can obtain all the many variations which are found either in the direction of greater rigidity or of greater flexibility.

In the former case we have:—

1. The close suture, also known as synostosis, in which the connecting fibres are short, and “the joints closely and immovably fitted together, though they can be separated by the action of alkalis,” *e.g.* the radials of *Antedon*.

2. The syzygy, which is a special case of close suture, viz. that in which, if pinnules or cirri are carried by the ossicles, the lower one loses its pinnule or cirrus.

The two components of a syzygy are termed epizygal and hypozygal.

3. Anchylosis, in which the two plates or ossicles are immovably cemented together by an unbroken deposit of calcareous substance, which, however, is less solid than that of the plates themselves (*e.g.* the basals of *Bathycrinus* and the radials of *Rhizocrinus*).

On the other hand we have the modifications in the direction of greater flexibility which lead up gradually to the development of true muscles, the original undifferentiated fibrils becoming muscularly contractile. Such muscular articulations may indeed be very highly specialised, with interlocking ridges and teeth on the opposed facets of the ossicles.

As all these different modifications pass into one another by imperceptible stages, it is not always easy to say whether in any special case we have to do with muscular articulation or with a less specialised form of connection. It now seems probable that many of the fibrous connections which were at one time thought to be only elastic fibres are really muscles.

For instance in the arms of living Crinoids, a pair of muscles on the oral side are counteracted by a pair of bundles of “elastic” fibres on the dorsal side. The action of the muscles in contracting rolls the arms up orally, and on the muscles relaxing, the “elastic” fibres expand the arms again. Now it is clear that if these fibres were thus simply elastic, Crinoids would die with their crown of tentacles expanded, whereas the reverse is the case.

Again, the cirri are actively movable, often (*e.g.* in *Pentacrinus*) more so than the arms, although no muscular articulations occur in them.

From these facts it is rightly argued that the fibrils in these cases, though differing histologically from the true muscles, are yet to some extent muscular.

That all these various connections are in reality derivations from some common primitive form of connection, we gather from the fact that in the stems of Crinoids we may have anchylosis, close suture, syzygy, loose suture, and true muscular articulation.

¹ This passage was rewritten in accordance with the tenour of Mr. Bather's criticism in *Natural Science*, vol. vi. pp. 420, 421.—TR.

(e) The Nerve Canals of the Arms and of the Apical Capsule.

(Figs. 327-330).

The skeletal joints of each arm (the brachials) are perforated by an axial canal, which is continued to the tip of the arm, and into the pinnulæ. Where the arms fork or branch in various ways, the axial canal does the same. It contains nerve strands, and may thus be suitably considered as a nerve canal. This canal is continued right into the base of the dorsal cup, perforating the radials, basals, and also the infrabasals, when present. All the nerve canals, and the nerves within them, converge towards the apex of the calyx, where, either in the base of the dorsal cup itself (surrounded by the basals in stalked Crinoids), or partly enclosed within the centrodorsal (*Antedonida*), lies the central organ of this nervous system, which surrounds the so-called five-chambered sinus in the shape of a cup or capsule. From this point the already mentioned central, or axial, canal runs through all the ossicles of the stem, giving off lateral branches to the cirri.

The nerve strands arise from this apical central nervous system at five interradial points. The five interradial strands fork either in the basals or in the radials. Within the radials each branch of a strand becomes connected with a branch of the neighbouring strand, and from these radially arranged points of junction the radial nerve strands originate which pass from the radials into the costals, and are continued into the ossicles of the arms and of their branchings. Within the circle of radials there is, besides, a circular commissure between the radiating nerve strands; the following diagrams illustrate the courses taken by these.

In the *Pentacrinidae*, *Encrinidae*, and *Antedonidae*, where the nerve strands divide in the first axillaries, there is a peculiar **chiasma nervorum brachialium**, which is shown in the diagrams.

In *Encrinus*, and it is said also in *Pentacrinus*, the nerve strands which run through the ossicles of the arms are double. But whereas, in *Encrinus*, they run separately, and are enclosed in separate canals, in *Pentacrinus* they lie in a common canal.

Many paleozoic Crinoids, and above all the *Camerata* (with the exception of the *Crotalocrinoids*), appear to have no differentiated nerve canals in the arms.

(f) The Water Pores.

In the *Canaliculata* (e.g. *Pentacrinus*, *Antedon*, *Actinometra*) the tegmen calycis, whether naked or plated, is perforated by so-called water pores, whose significance will be discussed more in detail later on.

If the tegmen is plated, many or all of the plates of the interambulacral areas are perforated by one or more such pores. In *Pentacrinus decorus*, as many as twenty pores are found on one plate. The total number of pores varies greatly in different genera and species. In *Antedon rosacea* it has been estimated at 1500, and in other forms may be even greater. The pores are usually limited to the tegmen, and are least plentiful in the posterior interradius. They may, however, also occur on the

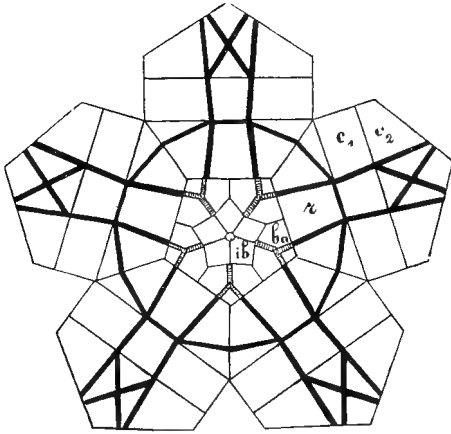

FIG. 327.

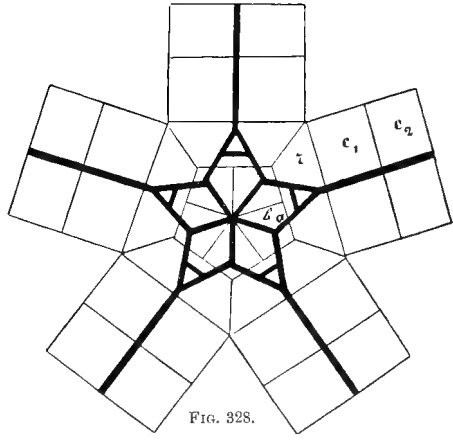

FIG. 328.

FIGS. 327-330.—Diagrams to illustrate the course of the axial canals and the nerve strands within them in the dorsal cup and the first brachial joints of *Enocrinus* (Fig. 327, after Beyrich), *Rhizocrinus lofotensis* (Fig. 328, after P. H. Carpenter), *Antedon rosaceus* (Fig. 329) and *Bathyrinus aldrichianus* (Fig. 330, after P. H. Carpenter). In Fig. 327 only the distal ends of the interradial canals are represented. The parts which are transversely streaked run superficially on the inner side of the basal plates.

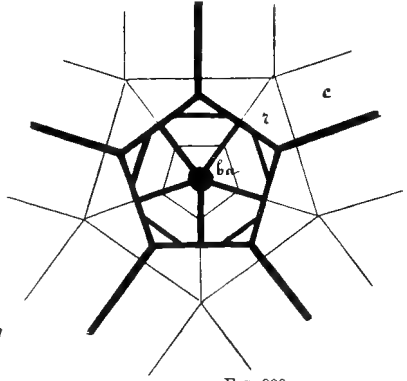

FIG. 330.

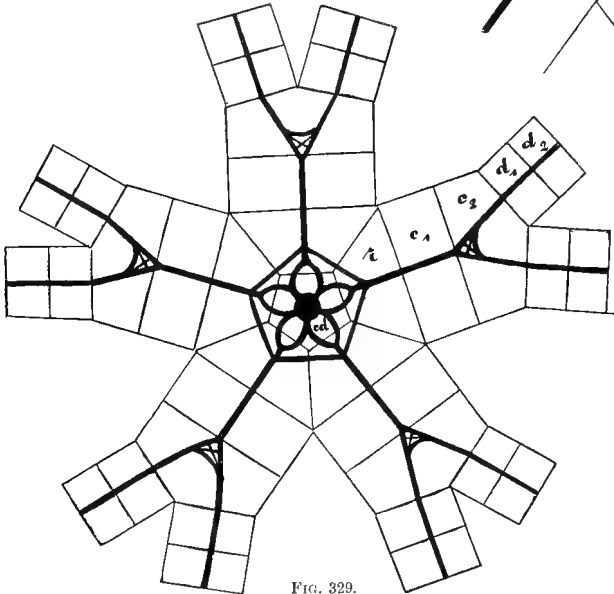

FIG. 329.

edge of the calyx between the bases of the arms, and in the genus *Actinometra*, where they are chiefly developed near the ambulacral furrows, they have occasionally been observed on the lowest pinnulæ as well, and even on pinnulæ in the middle or towards the ends, of the arms.

In *Rhizocrinus*, in each interradius of the tegmen calycis there is only one water pore perforating the oral plate. In *Hyocrinus* the anal oral plate is perforated by two pores; the other oral plates either have one pore each or else none at all. Further, in this genus, 2 to 7 pores occur in the plates of the interambulacral areas lying between the oral pyramid and the edge of the calyx, except in the posterior interambulacral area, where they are wanting.

It is impossible to decide with certainty whether the pores which, in certain *Camerata* (*Actinocrinida*, *Melocrinida*, *Rhodocrinida*), occur at the edge of the calyx at the bases of the arms (and correspond with the arms in number) are the homologues of these water pores. The same applies to the slit-like pores which are supposed by some writers to perforate the edges of the plates of the ventral sac in the *Inadunata fistulata* (along the sutures), and to the pores which are found along the brachial furrows in the *Inadunata larviformia*. These pores may, in some cases, have been connected with hydrospires (see the next two sections). In many *Inadunata* there is what appears to be a true madreporic plate in the posterior interradius of the tegmen.

VI. Blastoidea.

One part of the perisomatic skeleton of the Blastoidea has already been described in connection with their apical system. There are **five interradial or deltoid plates**, which surround the oral region (peristome), and radiate out from it (Fig. 331). These deltoid plates do not form a closed circle, *i.e.* do not touch one another laterally, but are separated from one another by the proximal portions of the five ambulacra.

In describing the rest of the perisomatic skeleton, which, apart from the stem, consists exclusively of the skeleton of the ambulacra, it is useful to select a few typical forms.

(a) The Ambulacral Skeleton.

1. **Pentremites.**—Fig. 263, p. 314, shows a representative of this genus in profile, Fig. 331 from the oral side. The five ambulacral regions, or ambulacra, together form a five-leaved rosette round the peristome (Fig. 331, *A, B, C, D, E*). They are separated from one another by the five (interradial) deltoid plates (3). The larger, distal part of each ambulacrum fits in between the two limbs ($10, 10^b$) of the forked radials.

On the egg- or pear-shaped body the ambulacra stretch as far as to the equator, or even further, towards the apical pole.

The skeleton of each ambulacrum, when most complete, consists of the following parts:—

- (a) One lancet plate (6).
- (b) One lower lancet plate (12).

- (c) Two rows of side plates (5).
- (d) Two rows of accessory side plates (8).
- (e) Two rows of pinnulæ (2).
- (f) Two groups of folds of hydrospire pouches (13).
- (g) A double row of covering plates (1).

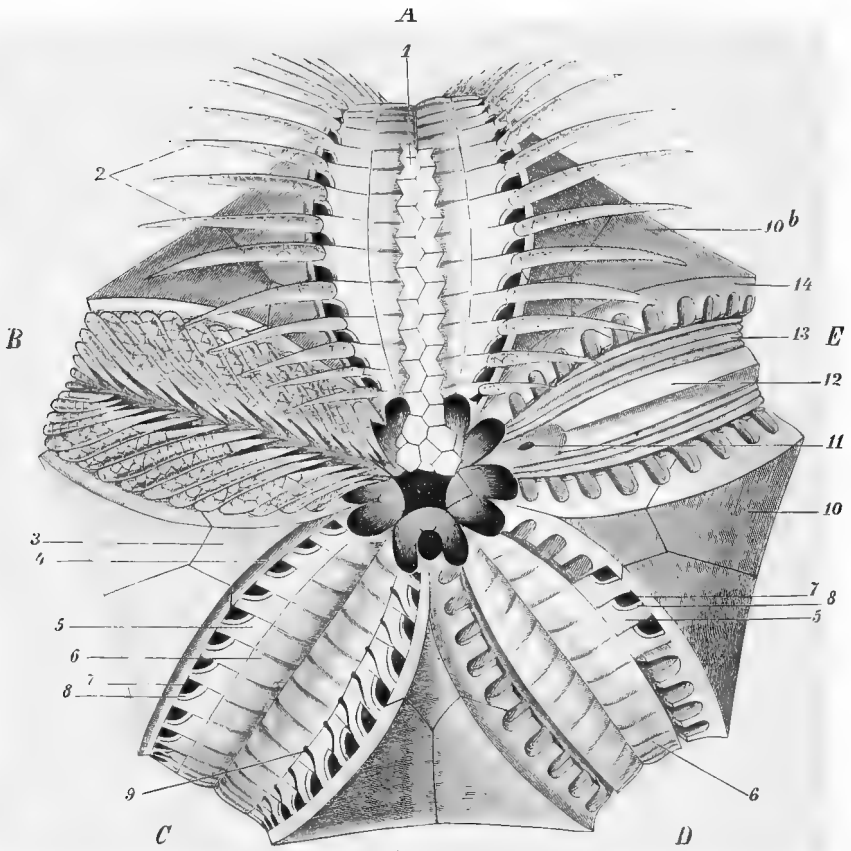

FIG. 331. Diagram of the organisation of a *Pentremites* (original). A, B, C, D, E, the five ambulacra. A, Ambulacrum with covering plates (1) and extended pinnulæ (2). B, Ambulacrum with depressed pinnulæ. C, Ambulacrum after removal of the pinnulæ and covering plates. D, After the further removal of the side plates and accessory side plates (except 3). E, After removal of the lancet plate as well. In the centre is seen the mouth with the spiracles surrounding it, in the posterior interradius the anus. 1, Covering plates; 2, pinnulæ; 3, deltoid plates; 4, their sloping ambulacral edges; 5, side plates; 6, lancet plate; 7, pores; 8, outer or accessory side plates; 9, furrow of unknown significance on each side plate; 10, radials = fork plates; 11, aperture of the ambulacral canal; 12, lower lancet plate; 13, hydrospire folds.

Passing over the covering plates, which are very rarely retained, we have, at the centre of each ambulacrum, a skeletal plate about half as wide as the ambulacrum itself, and more or less similar in shape. This is the so-called **lancet plate** (Fig.

331, 6). On its outer, *i.e.* oral surface, this plate shows a more or less deep longitudinal furrow, which gives off alternating lateral furrows to right and left. This longitudinal furrow of the lancet plates is universally considered to have the same significance as the food grooves on the tegmen calycis, and on the arms, of Crinoids. Each lancet plate is longitudinally pierced by a canal, the so-called ambulacral canal.

The space on each side between the lancet plate in the middle, and the lateral margin of the ambulacrum (which latter is formed by the sloping edges of a deltoid plate and of one limb of a fork plate (radial)), is occupied (*a*) by a longitudinal row of large **side plates** (5), and (*b*) by a longitudinal row of smaller **accessory side plates** (8). The number of side plates and accessory side plates corresponds with that of the lateral branches of the median ambulacral furrow on the lancet plate. Each side plate consists of a narrow portion which is directed towards the edge of the ambulacrum, and of a broad portion which is in contact with the lancet plate. The broad parts of the consecutive side plates in a row are in contact with one another, but between the narrow parts of these same plates are spaces, in each of which lie an accessory side plate, and a **hydrospire pore** (7). This latter leads below the surface to the **hydrospire pouches** under the ambulacrum. The hydrospire pores, the accessory side plates, and the narrow ends of the side plates follow one another regularly in this order.

The margins of the ambulacra carry thin long jointed appendages, the **pinnules** (2), which may be compared with the structures of the same name in the Crinoids.

The pinnules are retained only in rare cases, and are then depressed from the two sides orally over the ambulacral area (ambulacrum **B**, Fig. 331). There can, however, be no doubt that they could be raised and opened out (ambulacrum **A**). The number of the pinnules corresponds with that of the side plates in a longitudinal row, as also with that of the accessory side plates and of the hydrospire pores. The points of attachment of the pinnulae lie **between** the consecutive pores. Each pinnule consists of a large number of skeletal pieces, which, near the base, alternate in two rows, but above this are arranged in one row.

If the lancet plate of an ambulacrum is removed (**E**, Fig. 331), the (smaller and thinner) lower lancet plate (12), which lies close below it, appears at the surface.

This plate resembles the lancet plate in shape. If the pinnulae, the side plates, and the accessory side plates be removed, the edges of the plates which border the ambulacrum (deltoid plates, limbs of the fork pieces) are seen sloping towards the floor of the ambulacrum. These sloping edges carry a longitudinal row of transverse ridges, alternating with depressions, into which latter the narrower (outer) portions of the side plates fit. On each side, between the lower lancet plate and the sloping lateral walls of the ambulacrum, some of the parallel clefts and folds of the hydrospire pouches (13) are seen lying parallel to the longitudinal axis of the ambulacrum. At the central or proximal end of the ambulacrum (*i.e.* near the peristome), the interradial deltoid plates meet, and are joined by a radial suture. An aperture in this suture, the **ambulacral aperture** (11), leads to the interior of the calyx. Through this ambulacral aperture, the ambulacral canal, which traverses the lancet plate longitudinally, is connected with a circular canal which surrounds the oesophagus.

In closest proximity to the peristome there are five large inter-

radial apertures, the so-called **spiracles**. Each of these apertures leads into the hydrospire pouches in such a way that the halves of two adjoining ambulacral areas have one common spiracle for their hydrospire pouches.

Each spiracle forms a depression in the central part of the corresponding deltoid plate, and is further bordered by the proximal side plates, and by the proximal ends of the lancet plates. Occasionally, each spiracle is more or less distinctly **divided into two** by a vertical median ridge (septum) projecting into it from the deltoid plate. In the posterior interradius, the spiracle is confluent with the anus.

The **hydrospires** (Fig. 332) are calcareous pouches or tubes united in groups.

A group of such calcareous pouches is arranged symmetrically on each side of the middle line of, and in close connection with, each ambulacrum. The pouches,

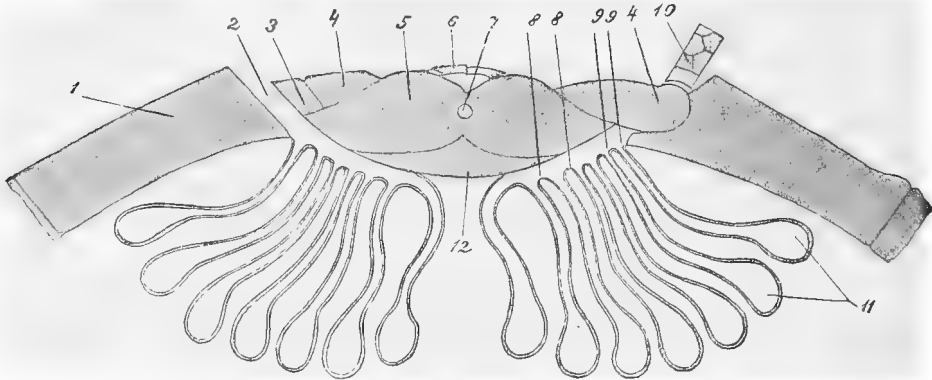

FIG. 332.—Section through an ambulacrum of *Pentremites*, diagrammatic. 1, Deltoid, while lower down is the radial; 2, hydrospire pore; 3, accessory side plate; 4, side plate; 5, lancet plate, with its ambulacral canal; 6, covering plates; 7, central opening; 8, common channel, into which the hydrospire pouches (11) enter at 9; 10, base of a pinnula; 11, hydrospire pouches; 12, lower lancet plate.

which hang down into the cavity of the calyx, are parallel to one another, and stretch from the distal end of the ambulacrum to its proximal end, as far as to the spiracle, through which they open externally. In addition to this opening, each hydrospire pouch possesses a slit-like aperture extending along its whole length, in the ambulacral area. These hydrospire folds are hidden, lying partly under the side plates and partly under the lancet plate. After the removal of these latter pieces, as we have seen, they appear at the surface. They vary in number from three to nine. The concealed hydrospire canal (8), into which, on each side, the hydrospire pouches open through their clefts, communicates with the exterior by means of the hydrospire pores already mentioned.

The hydrospire pouches or tubes have thus a double manner of communication with the exterior, viz. through the five or ten spiracles round the mouth, and through the numerous hydrospire pores at the lateral edges of the ambulacra.

In certain species, the peristome was overarched by a roof of **covering plates**, for the most part irregularly arranged (Fig. 331, 1); at their centre, five oral plates

can sometimes be distinguished. The covering plates, which are rarely retained complete, are occasionally continued on to the food grooves of the ambulacra, where they are arranged in two longitudinal rows. Perhaps they could be raised and depressed; if not, it is difficult to see how the food grooves with their lateral furrows could function: the lateral furrows would then have to pass under the covering plates so as to be in communication with the principal groove. In rare cases the covering plates even spread sideways over the spiracles.

2. **Codaster** (Fig. 265, p. 314).—The arrangements here differ considerably from those of *Pentremites*, just described. The food grooves are deeply sunk into the lancet plates, which are hollowed out on each side for the reception of the side plates. Spiracles are wanting. A certain number of the hydrosphere clefts which run parallel to the ambulacrum always appear at the surface of the calyx, laterally to the ambulacrum (Fig. 333). These clefts run at right angles across the suture between

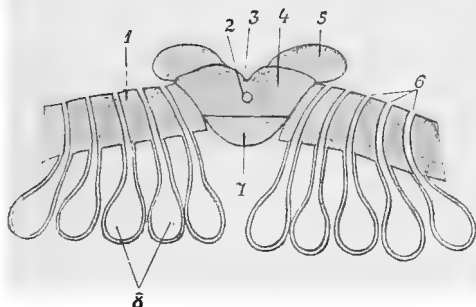

FIG. 333.—Transverse section through an ambulacrum of *Codaster* (after Etheridge and Carpenter), diagram. 1, Deltoid plate or possibly a radial; 2, ambulacral canal; 3, food groove; 4, lancet plate; 5, side plate; 6, apertures of the hydrosphere pouches; 7, lower lancet plate; 8, hydrosphere pouches.

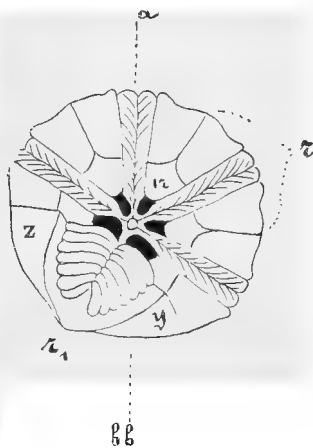

FIG. 334.—*Eleutheroerinus Casedayi*, from the oral side (after Etheridge and Carpenter). *aa-bb*, Axis, passing through the mouth and anus; *r*, radials; *ir*, interradials; *r*₁, the radial of the differently shaped ambulacrum; *z*, *y*, the two larger basals.

the radial and the deltoid plates. One or more hydrosphere clefts may be covered by the side plates of the ambulacra. At those sides of the two posterior ambulacra which are turned towards the anus, the clefts are altogether wanting.

3. In **Orophocrinus** (type *O. stelliformis*, Fig. 266, p. 314) there are no hydrosphere pores on the ambulacra, but depressions occur between the consecutive side plates for the reception of the bases of the pinnales. The hydrosphere clefts lie quite hidden below the surface within the ambulacral sinus, covered by the lower lancet plate. The spiracles, on the contrary, which are ten in number, appear at the sides of the ambulacra as long wavy slits. The two spiracles of the posterior interradius are distinct from the anus. The ambulacra, round the mouth at least, are covered by covering plates.

4. The **Irregulares** (*Astrocrinus* and *Eleutheroerinus*) are chiefly distinguished by the fact that one of the four ambulacra is developed quite differently from the others (Figs. 334, and 267, p. 315).

The bundles of hydrospire tubes or pouches of the Blastoidea have been compared with the "bursae" of the *Ophiuroidea*. They are said to have served, like these latter, for respiration and for the ejection of the genital products. The similarity of these apertures is specially marked if we compare *Orophocrinus* with an Ophiurid.

(b) The Stem.

With the exception of the genera *Pentephyllum*, *Eleutherocrinus*, and *Astrocrinus*, which, at least in the case of all known adults, were non-pedunculate, the Blastoidea were attached to the substratum by a jointed stem without cirri (Fig. 264, p. 314).

VII. Cystidea.

The study of the skeleton of this ancient class, which is limited to the palæozoic age, has no very great comparative interest. The organisation of the very heterogeneous groups which are classed together under this heading can only to a small extent be understood from their skeletal remains. According to the structure of the skeleton, we can perhaps distinguish two principal groups: the *Cystocrinoidea*, whose skeleton consists of comparatively few definitely arranged plates, and which in some forms approximate the *Crinoidea*, and the *Eucystidea*, whose skeleton consists of a very large number of plates, showing no definite recognisable order.

It is characteristic of most Cystidea, that all or some of the plates of the skeleton are perforated in various ways by pores, which, however, never seem to establish communication between the interior of the calyx and the exterior. It is difficult to ascertain the significance of these pores. They could not serve for the passage of the ambulacral feet, since the pore canal, as already said, does not stand in direct communication with the interior of the calyx. It is now pretty generally accepted that, as the water passed through them, they served for respiration. The following principal forms of pores can be distinguished:—

1. Scattered single pores.
2. Scattered double pores (the pores being united in pairs) (Fig. 260, p. 312).
3. Double pores arranged in rhombs. In this case, the two pores of a double pore are found on two neighbouring plates, and are connected by a furrow or a canal, which sometimes runs at the outer and sometimes at the inner side of the plate. This canal or furrow lies at right angles to the suture between the two plates, and the suture itself lies diagonally to the rhomb formed by the pores. Such pore-rhombs may occur on all the plates of the Cystid test, or again may occur singly. In the latter case, the two halves

of a rhomb are not infrequently divided by a smooth intermediate region.

Since it is difficult or even impossible to give any comprehensive description of the perisomatic skeleton of the Cystidea, it is advisable to treat a few of the best known forms separately.

Cystocrinoidea.

Porocrinus is a form which only differs essentially from a simple Crinoid of the order *Inadunata* in the presence of the pectinated rhombs.

Caryocrinus.—The calyx is almost pear-shaped, and is carried by a long stalk perforated by a wide axial canal. At the edge of the calyx there are 6 to 13 thin, jointed, biserial arms, each provided with a furrow on the oral side. The hexagonal dorsal cup, apart from two plates lying interradially in the circle of the radials, consists exclusively of the already described plates of the apical system (four infrabasals, six basals, six radials). The tegmen calycis is formed of a great number of plates, and at their centre six orals, which show the characteristic arrangement before described (Fig. 294, p. 332), completely cover the mouth. The ambulacral furrows are not externally visible. An excentrically placed aperture, roofed over by a pyramid formed of six triangular plates, is regarded as the anus. The pectinated rhombs are found on all the plates of the dorsal cup, and on them alone. The two pores of a double pore are connected by a canal on the inner side of the plate.

Echinoencrinus.—The almost egg-shaped calyx consists of the already described plates of the apical system (four infrabasals, five basals, five radials) arranged in five rays, and five other perisomatic plates in contact with the circle of the radials, and partly pressing in between them. At the oral pole there is a depression, round which short uniserial tentacles rise, and in the centre of which the star-shaped oral aperture lies. The anal aperture has shifted across the equator of the calyx apically, and lies to the right posteriorly above the basals. Three pectinated rhombs are developed, whose position is shown in Fig. 296, p. 333. The calyx is carried by a short thick stem, the ossicles of which are perforated by a wide canal.

Cystoblastus (Figs. 259, p. 312, and 295, p. 332) shows some resemblance to the *Blastoidea*. The egg-shaped or spherical calyx consists of sixteen plates and the ambulacra. Of these sixteen plates, which are arranged in four circles, fourteen belong to the apical system (four infrabasals, five basals, and five radials). The radials exactly resemble the radials (fork plates) of the *Blastoidea*. Each radial clasps an ambulacrum between its two limbs. Between two neighbouring radials, in four of the interradii, a lancet-shaped plate, which is keeled in the middle, presses in, recalling the deltoid plates of the *Blastoidea*. In one interradius this plate is wanting, so that here the neighbouring radials touch one another. At the centre of the rosette formed by the five ambulacra lies the mouth, and from it a furrow runs to each ambulacrum, passing down its whole length and dividing it into two lateral halves. The principal groove of each ambulacrum gives off alternating lateral furrows, which end in distinct pits (pores? depressions for the reception of pinnulæ?). At the base of the calyx there are two pectinated rhombs (*cf.* Fig. 295, p. 332). Further, the forks of the radials appear transversely striated by numerous parallel pore clefts, and a similar striation also occurs on each side of the rib or keel on the four deltoid plates. Perhaps every two neighbouring rows of pore clefts, belonging, however, to different but adjoining plates, together formed a kind of pectinated rhomb. A large aperture half way up the calyx is regarded as the anal aperture, and a smaller, in an angle between two ambulacra, as the aperture of the water vascular system. This is, however, uncertain. The arms are unknown,

and so is the stem, though the latter was present, since it is easy to distinguish a depression at the apex marking its point of attachment.

Eucystidea.

Protocrinus (Fig. 260, p. 312).—The calyx is non-pedunculate, with somewhat flattened apical side; otherwise it is almost spherical. It consists of numerous pentagonal or hexagonal bulging plates, each of which is provided with several double pores. At the oral pole lies the oral aperture, from which five long ambulacral furrows radiate, giving off, here and there, lateral furrows. At the end of each lateral furrow there is a depression on a prominence. At these points, small arms or pinnule were perhaps once articulated. The ambulacral furrow and the mouth are roofed over with covering plates. The anus lies excentrically in an interradius, roofed over by a pyramid of valves. Between anus and mouth there is a small third aperture. The stalked genus *Glyptosphaerites* is related to *Protocrinus*.

Orocystis (Fig. 261, p. 313).—The almost egg-shaped body is tessellated with a considerable number of plates which are usually hexagonal, and are all provided with pectinated rhombs. The pores are on prominences, arranged as in the figure. A stem was present, but has never been met with attached to the body. On the oral side of the body there are two principal apertures, the mouth and anus, lying on chimney-like prominences, and there is also an additional third aperture. The area around the mouth is never preserved intact; probably the mouth was surrounded by a few tentacles. In the genus *Echinosphæra*, very common in the Lower Silurian, the spherical test is formed by a large number of pentagonal or hexagonal plates, all of which have pectinated rhombs. In each rhomb the pores lying on the opposite sides of the suture, between the two plates, are connected in pairs by canals. The oral aperture lies on a chimney-like or conical prominence, surrounded by two to four long or short arms. At some distance from the buccal cone lies the anus, covered by a pyramid of valves. Between the mouth and the anus, but a little to one side, is a third smaller aperture. In *Aristocystis* there are two smaller apertures between the mouth and the anus, one of which, near the anus, perhaps represents the genital aperture which, in other Cystids, is possibly confluent with the anus. In *Ascocystis*, the body, which was evidently richly plated, is prolonged like a tube; at the pointed apical pole it was attached by means of a stem; at the oral side it is truncated, the oral disc being surrounded by as many as twenty-five biserial, unbranched arms. The structure of the disc surrounded by these arms has not yet been made out with certainty.

Mesites.—The body is spherical, and was probably stalked. The test consists of numerous plates provided with double pores, and showing no definite arrangement. Five furrows run from the oral pole in meridians towards the apical pole. Each furrow is covered by a double row of contiguous, so-called ambulacral plates, and is thus converted into a closed canal. Between the consecutive (ambulacral) plates, pores lead into this canal, while on the plates themselves circular areas can occasionally be made out, which have been regarded as points of attachment of pinnulæ. A groove runs along the middle line of each double row of plates; this is open along most of its length, but, at the oral pole, small plates form a slanting roof over it.



FIG. 335. — Transverse section through an ambulacrum of *Mesites*.

We thus distinguish, in each radius, an external groove which runs upon the ambulacral plates, and an internal canal, which runs below these plates and above the perforated plates of the test (Fig. 335).

In an interradius on the oral side of the body, nearer one of the ambulacra than the other, lies the anus, which can be closed by valves.

Mesites shows a certain similarity with the Palæechinoidea. By arbitrarily assuming that an ambulacral vessel ran in the canal below the ambulacral plates, and that ambulacral feet passed out through the pores between these plates, stress was laid upon the agreement thereby established between the Echinoids and *Mesites* in the position of the radial water vascular trunk on the inner side of the ambulacral plates. But (1) it is quite uncertain that the ambulacral vessel really lay in this canal and not in the outer channel, (2) the ambulacral feet, in Echinoids, pass *through* the ambulacral plates and not *between* them as in *Mesites*, and (3) it is not at all certain that the pores of *Mesites* really served for the passage of ambulacral feet.

Agelacrinus (Fig. 262, p. 313).—The body resembles a more or less flat, round disc, attached to a firm object (*e.g.* the shell of a Brachiopod). The test is formed of numerous, irregularly arranged scale-like plates, which more or less imbricate with one another. In the middle of the free (oral) side of the disc lies the mouth, covered with plates, from which five curved ambulacral furrows radiate, covered with double rows of alternating plates. The plates of each double row form a tunnel, raised above the level of the disc, and, between the plates, apertures may occasionally be observed which are supposed to have served for the passage of ambulacral feet. In one of the interradii, between two ambulacra which converge so as to form a ring, lies the anus, arched over by a pyramid of valves.

Just as *Mesites* has been regarded as nearly related to the racial form of the *Echinoidea*, so *Agelacrinus* (with the related genus *Edrioaster*) was said to be nearly connected with that of the *Asteroidea*. But it appears hardly conceivable that the almost rigid skeleton of the attached, sessile *Agelacrinus* could give rise to the richly jointed and movable skeleton of the *Asteroid*. In the *Asteroids*, it is not the ambulacral feet but the canals connecting them with the ampullæ which pass out between the ambulacral plates, and the radial water vascular trunks lie outside of the latter. The double rows of covering plates in *Agelacrinus* cannot thus be compared with the double rows of ambulacral plates in the *Asteroid*.

In conclusion, it may here be remarked that structures resembling the pectinated rhombs of the Cystidea occur in many fossil *Crinoids* and *Echinoids*. These are parallel striæ on the skeletal plates, which run transversely over the suture dividing two neighbouring plates, and together form a rhomb-like figure. In young and fossil *Echinoids*; it is principally the plates of the apical system which are ornamented with such striated rhombs.

D. The Spines and their Derivatives—The Sphæridia and the Pedicellariæ.

1. The Spines.

The test of the *Echinoidea*, and the plated test of the *Asteroidea* and *Ophiuroidea* carry large or small, variously shaped spines or processes, which also vary in number and arrangement. The knowledge of the structure, shape, size, and arrangement of these rigid processes of the body (**acanthology**) is of importance for classification. We must here confine ourselves to the most important points, referring the reader for further particulars to systematic works.

a. **The Spines of the Echinoidea**, which we shall first consider

merely as parts of the skeleton, occur in all forms. They are found in definite arrangement over the whole test, on both the ambulacral and the interambulacral plates, but usually in greater numbers on the latter than on the former.

The spines are usually slender and pointed, but may also (*e.g.* the principal spines of certain *Cidaridae*) be club-, egg-, plate-, or oar-shaped, etc.; or again in other cases they may look like fine setæ. The skeleton of the spine shows the same microscopic lattice-like structure which characterises all parts of the Echinoderm skeleton. Transverse and longitudinal sections of the spines reveal specific developments of this structure, the lattice-work being closer in some cases and opener in others, so that a careful examination of the structure of an isolated spine, taking into account certain possibilities of error, may suffice to determine the species of a specimen. The spines are mostly solid, less frequently hollow (*e.g.* in the *Scutellidae*).

The spines are movably articulated with the test. Each spine rises from a wart-like prominence of a test plate, which is called a **tubercle**.

Large, strong spines rise from large tubercles, and small spines from small tubercles, so that an examination of the tubercles on the test of an Echinoid which has lost its spines leads to some conclusions as to the nature of its former spinous covering. The tests of the *Clypeastroidea* and *Spatangoidea*, for instance, have very small tubercles, with which the small, inconspicuous, seta-like spines of these orders correspond. The regular Echinoidea have powerful spines and large tubercles. In the *Cidaroida*, especially, by the side of numerous small tubercles carrying small spines, there occur, in the interradii, a smaller number of remarkably large tubercles, which carry either very long and strong or else shorter but very massive spines, (Fig. 336).

Most spines are in some way ornamented, by ribs, thorns, etc.

In describing the various parts which can be made out in a spine, and in that portion of the test plate which surrounds its base, we shall select a **principal spine** of *Dorocidaris papillata* (Fig. 337). The spine consists of a **shaft** and a **socket**, the latter articulating with the tubercle of the test plate. The shaft thins away near the socket to form a **neck** which, again, is separated from the socket by a projecting **circular ridge** or **cushion**.

Each tubercle rises from a mound formed by the bulging of a round, smooth area, the edge of which is surrounded by a circle of smaller tubercles, which carry smaller spines and pedicellariæ (Fig. 336).

The socket, where it is in contact with the tubercle, has a pit, and a similar pit is found at the centre of the tubercle itself. Within these two corresponding pits runs an axial band consisting of elastic fibres, which fastens the spine to the tubercle, and passes at its two ends into the organic substance of the spine and tubercle.

The base of the spine is surrounded by a **double fibrous envelope**. The inner envelope consists of **elastic fibres**, the outer of **muscle**

fibres, which latter bring about the movements of the spine on the tubercle. Both the muscular, and the elastic, fibres are attached on the one hand to the socket (below the circular ridge or cushion), and on the other to the area surrounding the tubercle. They pass into the organic substance of the skeleton.

The spine is covered from tip to base (*i.e.* to the neck) by a very hard and thick calcareous layer, the **cortical layer**, which, in the

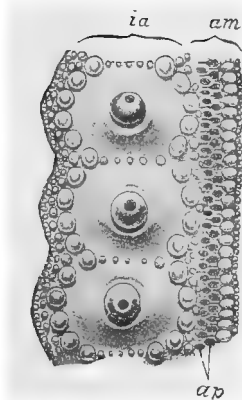

FIG. 336.—Part of the surface of the test of *Cidaris tribuloides*, Ag., near the ambitus, to show the tubercles and ambulacral pores *ap*. *ia*, Interambulacral row of plates; *am*, ambulacral row of plates.

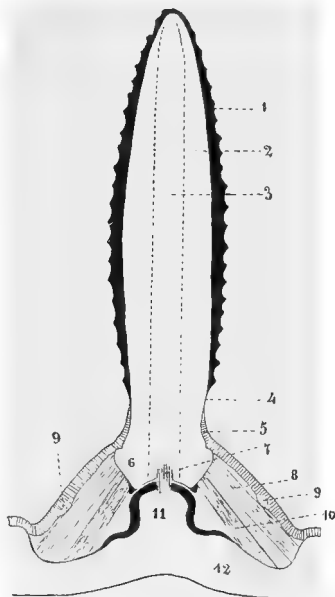

FIG. 337.—Large spine of a *Cidaris*, diagrammatic (essentially after Prouho). 1, Cortical layer; 2, middle layer; 3, medulla; 4, neck; 5, integument; 6, pedicle; 7, axial band; 8, muscle ring; 9, circular ganglion; 10, ligamentous envelope; 11, tubercle on the test; 12, test.

development of the test, is the last part deposited, and determines the ornamentation of the spine.

At first the body integument covers the whole spine, its epithelium being provided with cilia. But when the spine has attained its definitive size, and the cortical layer has been formed, the integument dies away on those parts which are covered by that layer, and is only retained round the base of the spine.

At this base, about half way up the muscular envelope, under the surface of the epithelium, lies a **nerve ring** with scattered ganglion cells; this runs right round the base of the spine, and innervates its muscles.

The structure of all Echinoid spines resembles that just described, except that the pits in the socket (or acetabulum) and on the tubercle are usually wanting, and with them also the axial ligament.

The **small spines** of the *Cidaroida* are protective. They surround the anal aperture, the genital apertures, and the pores of the radials (or ocular plates); on the interambulacra, they surround the bases of the principal spines like a circular palisade, and on the ambulacra they are arranged in two longitudinal rows. They can be raised, and inclined towards one another over the part to be protected. The smaller spines have no cortical layer and no nerve ring at their bases. They are always covered by the ciliated integument, which at the tip of the spine carries sensory (tactile) hairs. Each small spine carries at its base, on the side turned away from the part to be protected, a whitish, transparent, ampulla-shaped swelling, which seems to be caused by the presence of glandular cells in the epithelium. The secretion of this glandular cushion may perhaps be poisonous.

In *Centrostephanus longispinus*, round the anus, certain short spines of a lilac colour occur; in the living animal, these constantly rotate, the tips of the spines describing a circle. In the epithelium of these spines there are sensory prominences, and at their bases the characteristic circular ganglion. The fibres of the muscular envelope are transversely striated.

In *Podocidaris*, immovable spines without any articulation are found, principally on the apical side of the shell.

The poisonous spines of *Asthenosoma urens* (*Echinothurid*). This *Echinoid* is much feared by fishermen and divers, on account of the acute pain produced by contact with its body. Spines, whose ends are swollen into shiny blue heads (Fig. 338), seem to form the principal part of its poison apparatus. These **poison spines** are arranged in regular bands on the interambulacra, but in the larva are found scattered over other parts as well. The axis of the spine is occupied by a hollow calcareous rod with an extremely fine point; this rod, throughout the greater part of its length, is perforated by pores arranged in longitudinal rows; at its fine tip, however, there are only a few small pores or eyes. The swollen head which surrounds the tip of the spine contains a somewhat large **poison sac**, with an aperture at its tip, through

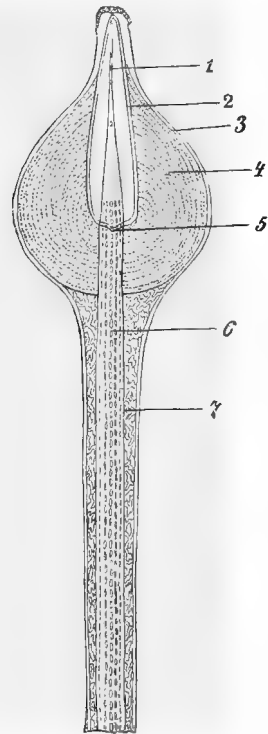

FIG. 338.—Spine with poison head of *Asthenosoma urens* (after P. and F. Sarasin), diagrammatic. 1, The tip of the spine; 2, poison sac; 3, epithelium of the poison head; 4, muscles of the same; 5, lower terminal fascia of the poison head, penetrating the spine; 6, longitudinal rows of pores in the shaft (7) of the spine.

which the spine may protrude. The epithelium lining the sac passes, at the aperture, into the outer epithelium of the head. The poison sac and the part of the spine which runs through it are filled with a clear fluid with floating vesicles (cells and remains of cells), yielded by the epithelium of the sac. The sac and its envelope of connective tissue are surrounded by a powerful muscular capsule, most of whose fibres are attached on the one hand to the sac, and on the other to the part of the spine lying below it. The contraction of these muscles causes the sharp tip of the spine to protrude through the aperture of the sac. Perhaps, at the same

time, the poison is squeezed into the spine through the lower pores in that part of it which lies within the sac, and is squirted out through the few pores or eyes at its tip.

On the *fascioles* of the *Spatangoida*, whose course has already been described (p. 349), there are exceedingly numerous very small, granular tubercles carrying small seta-like spines, thickened at the tip; these are sometimes articulated, sometimes immovable. Such *clavulæ* are covered by a ciliated integument, which very probably contains sensory cells.

b. The Spines of the Asteroidea.—The Asteroid body is also usually covered with spines and papillæ. The form and arrangement of these vary so greatly that they cannot here be more fully described. We must refer the reader to the principal systematic works for details. Their finer structure is almost entirely unknown, and we have hardly any knowledge of the positions of the sensory organs and glands which almost certainly occur.

The spines are often firmly connected with the skeletal plates of the body wall, from which they rise. Spines occur most constantly at the edges of the ambulacral furrows, bordering them like a palisade. They are not infrequently movable; they can be erected, and inclined over the furrow for its protection (Fig. 243, p. 298).

Many *Phanerozonia*, and especially the *Astropectinida*, are characterised by short calcareous pillars rising from the integument, which, on their terminal flat surfaces, carry a usually circular group of small, thickly crowded spines, prominences, or papillæ. These structures are called *paxillæ* (Fig. 309, p. 351).

c. Spines of the Ophiuridæ.—In the *Ophiuridæ*, it is principally or exclusively the lateral shields which carry spines, in a manner already described (p. 355).

These spines are mostly large, slender, and pointed, and are occasionally provided with thorns. In the genera *Ophiomastix*, *Astrochema*, and *Ophiocreas* club-shaped spines occur, together with the ordinary kinds. Over the ends of these spines the epithelium is thickened, and contains glandular and sensory cells. In *Ophiopteron elegans*, numerous small spines of peculiar structure are found on the dorsal side of the disc. A short stem divides into six long pointed branches, which are connected by a thin, soft membrane in such a manner as to form a kind of funnel. The whole structure somewhat recalls an umbrella turned inside out. In the same species, each lateral shield carries, besides a hook and a thorny spine, ten long, slender

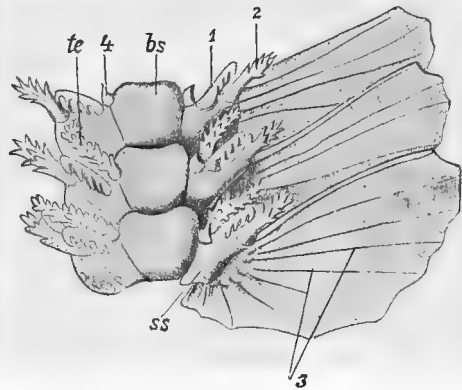

FIG. 339.—Three brachial joints of *Ophiopteron elegans*, from the middle part of the arm, lower side (after Ludwig). *bs*, Ventral shields; *te*, tentacle; *ss*, lateral shields; 1, hook; 2, thorny spine; 3, supporting rods of the fins.

spines arranged in a row, which runs up from the ventral to the dorsal side of the arm; these spines are connected by a thin, transparent membrane in such a way as to form a sort of **fin** (Fig. 339). On the first three free joints of the arm, the fin of one side of the arm passes into that of the other side dorsally. We are justified in assuming that the animal is able to swim by means of these large fins on the arms.

The genera *Ophiotholia* and *Ophiohelus* are distinguished by peculiar **umbrella-shaped spines**. A stem with a swollen, button-like base, articulating with a tubercle, carries at its tip a circle of recurved spines, which, during life, are covered by a common integument. These are found either in groups near the base of the ordinary brachial spines, as in *Ophiotholia*, where they first appear at some distance from the disc, or else replacing the ordinary spines near the end of the arm, as in *Ophiohelus*.

Function of the spines.—The fact that the spines serve principally for the protection of the body is at once evident, especially when they are provided with poison glands.

In response to stimuli, the spines become erect. In *Diadema setosum*, which is very sensitive to light, the long spines turn threateningly towards a hand which approaches them from any side. The spines of most *Echinoids* further serve for **locomotion**, moving in a co-ordinated manner. This has been directly proved in the *Cidaridae*, *Arbacia*, *Echinus*, and *Spatangus*, etc. In the first of these forms, the long (principal) spines are indeed the chief, or the only, locomotory organs, and are used as stilts. Many *Echinoids*, e.g. *Dorocidaris*, *Arbacia*, *Spatangus*, if laid on their backs, can turn themselves over again by the help of their spines.

It has also been proved that the spines may serve for seizing prey and for forwarding it to the mouth. Several spines incline towards the prey, seize it with their tips, and pass it on to the next group in the oral direction, and so on towards the mouth. Compare with this the rise of pedicellariæ in Asteroids, p. 394.

2. Modified Spines.

a. **The Sphæridia of the Echinoidea.**—These are small spherical or ellipsoidal bodies, which, by means of a short stalk, articulate with a prominence of the test, and are inclined sometimes in one direction, sometimes in another. They either project freely, or else rise from the base of a pit-like depression of the test (Fig. 340). This depression may more or less completely close over the sphæridium. We are here reminded of the various forms of acoustic tentacles in the Medusæ, which sometimes rise freely from the body, sometimes from the base of a pit, sometimes on the walls of closed vesicles, which latter come into existence through the concrescence of the edge of the pit above the tentacle. Here, however, we have to do not with tentacles, but evidently with modified spines.

Sphæridia occur in all *Echinoidea* except the *Cidaroida*. They are found only on the ambulacra, and always on the peristomal plates, although in many forms they are not limited to these, the area in which they occur stretching out in the direction of the ambitus, or even beyond it. The number and arrangement of the sphæridia vary greatly in different groups.

Structure of the Sphæridia (Fig. 341).—The sphæridia consist (1) of a very firm and hard transparent calcareous sphere, which is concentrically laminated, and does not show the lattice-like perforated structure of the rest of the skeleton, and (2) of the calcareous stem, which is perforated like a sponge, and is generally continued into the interior of the sphere. The calcareous sphere perhaps answers to the cortical layer of a large spine of a *Cidaroid* (cf. Fig. 337). Not infrequently the head is traversed by a canal which opens at its free end.

The sphæridium is covered by a ciliated epithelium which is often pigmented; the waving cilia are very long at the base of the stem, but gradually diminish in length towards the head. The sphæridia, like the spines, are surrounded at the base where they articulate with the tubercle, by a muscular envelope and by a circular ganglion, the

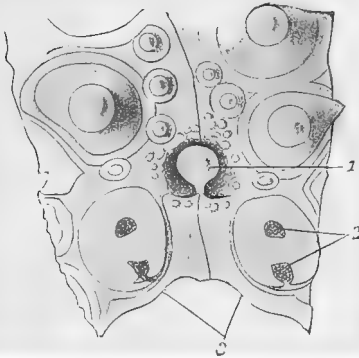

FIG. 340.—Portion of an ambulacrum bordering the peristome in *Echinocidaris nigra*, Mol. (after Lovén), magnified. 1, Sphæridium in its niche; 2, ambulacral double pore; 3, edge of the peristome.

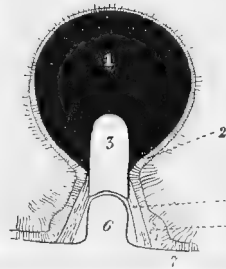

FIG. 341.—Longitudinal section through a sphæridium, diagrammatic. 1, Calcareous mass of the sphæridium; 2, epithelium; 3, calcareous stem of lattice-like structure; 4, muscle envelope; 5, circular ganglion; 6, tubercle; 7, test.

latter lying within the epithelium, which is here specially thickened. The hair-like cells of this circular thickening of the epithelium are probably for the greater part sensory.

The sphæridia have always been claimed as sensory organs, and, on account of their usual position near the mouth, as gustatory or olfactory organs. They have also been thought to be auditory, or organs for the appreciation of the movements of the water. They also remind us of organs adapted for appreciating the position of the body in the water.

b. The Pedicellariæ.—These are small seizing organs which rise from the integument. They occur in all *Echinoidea*, most *Asteroidea*, and a few *Ophiuroidea* in very varying number and arrangement, and in many different forms, between which, again, there are transition forms. They must be considered as modified spines, or groups of spines. In one and the same species various forms of pedicellariæ,

definitely arranged, may occur. It is very probable that many of the different forms of pedicellariæ, within certain divisions, have developed independently out of spines.

1. **The pedicellariæ in the Ophiuroidea.**—In *Trichaster elegans*, from about the thirty-sixth tentacle pore of an arm onwards, the two tentacle papillæ are replaced on the adoral side of each pore by two hooks movably articulated on a stem. This stem also is articulated with a ventral lateral process of the corresponding brachial vertebral ossicle. The skeleton of this apparatus consists of three pieces, belonging to the stem and to the two diverging hooks. The hooks do not move against one another, the planes of their movement being nearly parallel. On one side a flexor, and on the other an extensor muscle connects each hook with the stem. In *Astrophyton* also, similar pedicellariæ are found, and in *Ophiothrix fragilis* the end of the arm is beset with movable hooks provided with flexor and extensor muscles. Similar hooks occur, further, on the lateral shields of the arms in certain species of *Gorgonocephalus*.

2. **The pedicellariæ of the Asteroidea** (Fig. 342).—In some groups, e.g. the *Asterinidæ*, *Solasteridæ*, and *Pterasteridæ*, the pedicellariæ are altogether wanting: in the *Astropectinidæ* they are only very rarely found.

In the simplest cases, groups of small spines may function as pedicellariæ. The spines of such a group are movably connected with the body, and may be arranged either in two opposite rows of four to five spines each, these rows approximating or diverging; or else at definite points of the body three or four spines stand close together, forming, when they incline towards one another, a three- or four-sided pyramid. Two spines even may form a group. For instance, on the dorsal surface of *Asterina gibbosa*, spines are found sometimes isolated, sometimes united in larger or smaller groups. Among these groups there are couples connected at the base by a transverse muscle, and such spines can move towards one another more energetically than those of the other groups (Fig. 342, A to F).

In the above cases, we have to a great extent to do with commencing or rudimentary pedicellariæ, and we recognise, in the larger and smaller groups of spines, the material out of which pedicellariæ with two, three, or four forceps may be developed. (Cf. also what has been remarked on p. 392 on the spines of the *Echinoidea* as organs for the seizing and conveying of prey to the mouth, and p. 390 on the smaller spines of the *Cidaroida*.)

The **true pedicellariæ** of the *Asteroidea* usually have two blades or valves, less frequently three. **Stalked** and **sessile pedicellariæ** may be distinguished.

a. **Sessile pedicellariæ** (Fig. 342, G).—The two blades rise directly from the integument. Each consists of a calcareous piece determining its shape, which may be long or short, broad or narrow, pointed or blunt, flat or spoon-like. The two skeletal pieces are directly articulated with a skeletal plate of the integument. In *Gymnasteria carinifera*, for example, numerous double-bladed pedicellariæ rise at the edge of the ambulacral furrow. The two blades are connected at their bases in a manner illustrated in the figure, by a transverse muscle, the **adductor muscle**. Further, each blade at its outer side (*i.e.* at the side turned away from the axis of the pedicellaria) is also connected with the subjacent calcareous plate of the integument by an **opening muscle** (abductor). The bases of the

pedicellariæ are further attached by a strong elastic fibrous band to this same plate.

b. **Stalked pedicellariæ** (Fig. 342, H, K).—Each pedicellaria rises from a short, soft stalk; the blades, of which there may be two

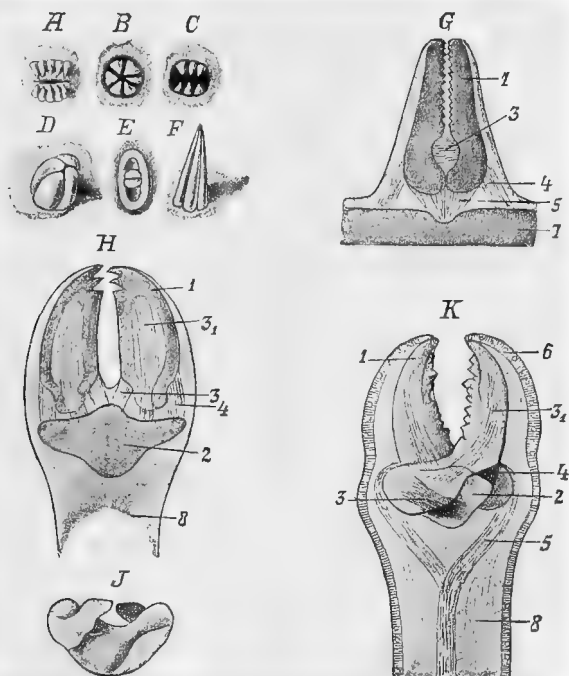

FIG. 342.—Pedicellariæ of Asteroids. A, B, C, D, E, F, Pseudo- or commencing pedicellariæ of various species. G, Sessile pedicellaria from the edge of the ambulacral furrow of *Gymnasteria carinifera* (after Cuénot). H, Stalked straight pedicellaria diagrammatised (after Cuénot). J, Basal portion of a stalked crossed pedicellaria of *Asteracanthion rubens* (after Perrier). K, A similar pedicellaria of *Asteracanthion glacialis* (after Cuénot). 1, Calcareous blade of the forceps; 2, basal piece; 3, occlusor muscle; 3₁, axial muscles of the blades; 4, opening muscle; 5, axial band; 6, epithelium; 7, body wall; 8, stem.

or three, articulate with a basal skeletal piece. The double-bladed (**didactyle**) pedicellariæ are either straight (**forcifiform**) or crossed (**forecipiform**). Both kinds may be found in one and the same animal.

We select for description *Asterias (glacialis)*, one of the *Asteroids* most richly provided with pedicellariæ, whose arrangement is specially interesting.

A. glacialis has three kinds of pedicellariæ, straight, crossed, and three-bladed.

The crossed pedicellariæ are found in very great numbers, thickly crowded together on a soft cushion, which surrounds the base of the spines, and into which the latter can be withdrawn (Fig. 344).

The straight pedicellariæ are far less numerous, and are found scattered over the integument either singly or in groups.

The three-bladed pedicellariæ are always found entirely isolated, and may be altogether wanting in some individuals.

Structure of the straight pedicellariæ (Fig. 342, H).—Each of the two blades consists of a hollow toothed skeletal piece, which articulates with a common basal

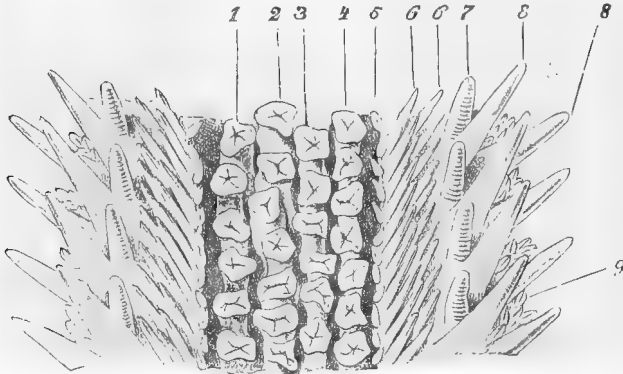

FIG. 343.—A portion of an arm of *Asterias stichantha*, Sladen, from the lower side (after Sladen). 1, 2, 3, 4, The four longitudinal rows of ambulacral feet; 5, forficiform pedicellariæ; 6, adambulacral spines; 7, papulæ; 8, inframarginal spines; 9, forcipiform pedicellariæ at the outer bases of these latter.

piece. Two muscles serve for opening the pedicellaria, the outer side of each blade being attached by a muscle to the basal piece. The blades are closed by means of two muscles which run from the inner sides of their bases to the basal piece,

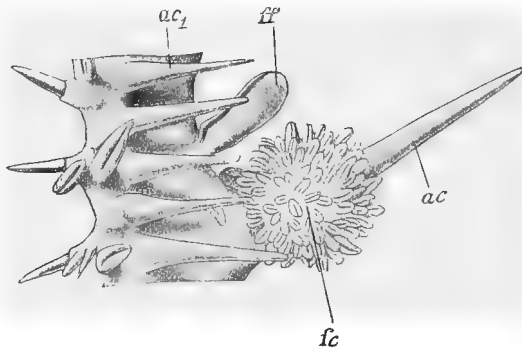

FIG. 344.—*Asterias (Stolasterias) volsellata*.—Adambulacral plates and neighbouring portion of the oral integument of an arm. *ff*, Straight; *fc*, crossed pedicellariæ on a cushion at the base of a large spine (*ac*); *ac1*, smaller spine (after Sladen).

and also perhaps by means of two muscles which, lying for the greater part within the calcareous blades, run from their tips to the basal piece. Each pedicellaria is surrounded by a layer of connective tissue, and covered by body epithelium, in which glandular cells are scattered.

Structure of the crossed pedicellariæ (Fig. 342, K).—A crossed pedicellaria is not unlike a forceps with short handles. It also consists of three pieces, the

two limbs of the forceps, and an intermediate or basal piece, upon which the blades move. Each limb of the forceps consists of the blade and the stalk or handle. The two limbs cross at the two sides of the intermediate piece like the two parts of a pair of pincers or scissors. When the two handles are approximated, the pincers close, when they are drawn apart, they open. The opening and closing of the pedicellariæ is effected by means of six muscles. Two small muscles, running from the outer side of the bases of the blades to the basal piece, by their contraction, open the forceps; while two pairs of muscles close it. One of these pairs runs within the blades to the basal piece, and the two muscles of the other pair run transversely from the handles of the two limbs to the basal or intermediate piece.

An axial strand of elastic fibres run from the stalk of the pedicellaria to the base

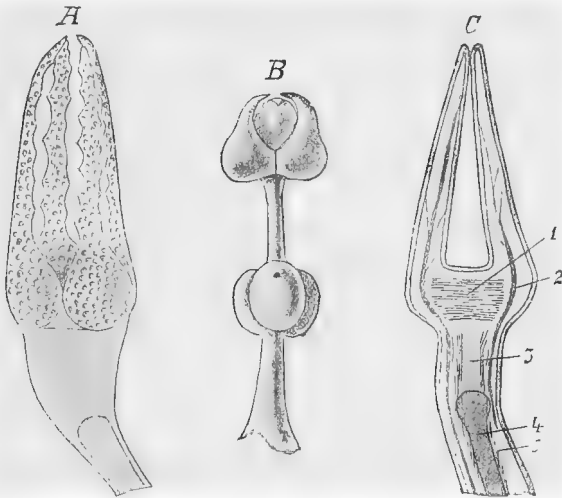

FIG. 345.—Pedicellariæ of Echinoids. A, Four-bladed pedicellaria of *Schizaster canaliciferus* (after Köhler). B, Glandular pedicellaria with glandular sacs on the stalk, *Sphærechinus granularis*. C, Longitudinal section through a decalcified tridactyle pedicellaria of *Centrostephanus longispinus* (after Hamann). 1, Adductor muscle; 2, nerve; 3, elastic column; 4, calcareous rod; 5, longitudinal muscle fibres.

of the forceps. This strand divides into two branches, which embrace its handles. The fibrous strands of the individual pedicellariæ penetrate the cushion, which surrounds the base of the spine (Fig. 344), and finally break up into fibres which become closely matted together. The whole cushion consists of thickly interwoven fibres of connective tissue and muscle. Muscle fibres run down from the calcareous piece of the spine into the cushion, in which they are lost. By means of these muscles, the cushion can be drawn up the spine, like a sort of sheath. The pedicellariæ, like the cushion from which they rise, are covered by a markedly glandular epithelium.

The three-bladed pedicellariæ, apart from the number of their blades, agree in structure with the straight two-bladed pedicellariæ.

3. **The pedicellariæ of the Echinoidea** (Figs. 345 and 346).—Pedicellariæ occur in all Echinoids on the integument, between the spines, and in one and the same species two or more forms of them may be found. The special arrangement of the various forms of pedicellariæ on the body (whether occurring on the ambulacral or on the interambulacral areas, and whether orally or apically), their distribution, number, and very varied form cannot here be described in detail, but must be sought for in systematic works.

The pedicellariæ of the Echinoidea are always stalked, and three-, less frequently two-, or four-, bladed. Two principal forms may be distinguished: **seizing pedicellariæ** (Fig. 345 A and C) and **glandular pedicellariæ** (Fig. 345 B and Fig. 346).

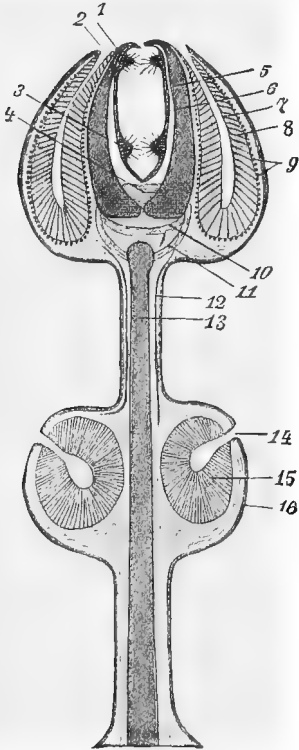

FIG. 346.—Organisation of a glandular pedicellaria of *Sphærechinus granularis*, section. 1, distal tactile prominence; 2, aperture of the gland of the forceps; 3, proximal tactile prominence; 4, adductor muscle; 5, skeletal piece of the forceps; 6, epithelium of the forceps; 7, cavity of the gland of the forceps; 8, epithelium of the same; 9, muscle layer of the forceps gland; 10 and 11, opening muscles; 12, nerve; 13, calcareous rod in the stalk; 14, aperture of the stalk gland (16); 15, epithelium of the gland. (The distal tactile prominence here represented is wanting in this species.)

a. The seizing pedicellariæ.—The form of the blades varies greatly in details. They are sometimes long and slender (p. tridactylæ, tetradactylæ), sometimes spoon-shaped and toothed (p. ophiocéphalæ, seu buccalæ, seu triphyllæ), or in other cases broadened out like leaves (p. trifoliatæ). Each blade is always supported by a skeletal piece, which determines its general shape and the special form of its teeth, hooks, etc. The stalk also is always supported by an axial calcareous rod, which sometimes penetrates the whole of its basal half (p. tridactylæ), sometimes only reaches a short way into the base of the stalk.

The tridactyle pedicellariæ of *Centrostephanus longispinus* (Fig. 345 C) will serve to illustrate the structure of the seizing pedicellariæ.

The three slender blades are connected at their bases, and on the sides turned to the axis of the whole forceps, by three transverse adductor muscles, each of which is attached on the inner (axial) sides of two neighbouring blades. The three muscles together form a triangle. These adductor muscles are counteracted by opening muscles, which run down on the outer sides of the bases of the blades longitudinally. A nerve enters each blade, running towards its tip, and innervating the musculature and epithelial sensory cells. The inner surface of each blade is ciliated. Within the stalk, the supporting calcareous rod reaches only half way up, ending in a knob. The continuation of the calcareous rod is formed by an elastic pillar, which consists of modified connective tissue, and is enveloped in a sheath of longitudinal muscle fibres. This arrangement makes it possible for the distal portion of the stalk with the head to bend in various directions, and even to bend right back upon the basal portion. When the muscles which bring about such movement are relaxed, the distal part resumes the upright position by means of the elastic pillar it contains.

The adductor muscles of these pedicellariæ consist of transversely striated muscle fibres;

consequently these tridactyle pedicellariæ are very active seizing organs.

b. The glandular pedicellariæ have been carefully investigated, up to the present time, only in a small number of Echinoids (*Sphærechinus granularis*, *Echinus acutus*, *E. melo*, *Dorocidaris papillata*, *Strongylocentrotus lividus*, *Echinocardium flavescens*), but it is probable that in time they will be found more widely distributed. In general structure they resemble the ordinary seizing pedicellariæ possessing three

seizing blades, which are opened and closed by special muscles, but the fibres of the adductor muscles are not transversely striated. In the stalk, the axial calcareous rod is continued as far as the three-bladed head, an arrangement which greatly decreases the mobility of this kind of pedicellaria.

The most distinctive characteristic of these pedicellariæ, however, is the presence of a large glandular sac in each blade. This glandular sac, which, as is shown by recent discoveries, consists of two fused sacs, causes each blade to be pear-shaped. It is covered by a thick glandular epithelium, and has a muscular wall of its own, in which the (smooth) fibres run in circular layers. This muscular wall, no doubt, serves for pressing out the slimy, and probably poisonous, secretion, through the aperture which lies near the tip of the blade. This aperture appears in most cases to lie on the outer side of the blade.

At the base of each blade, on its inner side, the epithelium is thickened to form a **tactile prominence or cushion**, which (besides cilia) carries immovable sensory hairs. In *Echinus acutus*, besides the basal, or lower, tactile prominence, there is, on each blade, a distal or upper prominence, which also lies on the inner side of the blade (Fig. 346).

Numerous nerves pass from the stalk of the pedicellaria into its head and its blades, so as to innervate the muscular and the sensory cells.

In a few Echinoids, glands also occur on the stalk of the pedicellaria; such glands are specially strongly developed in *Sphærechinus granularis*. These glands, three in number, encircle the stalk of the glandular pedicellariæ (p. gemmiformes), about half way up. Each gland is a large vesicle with an aperture, through which, on stimulation, a slimy secretion is discharged. The wall of the vesicle consists of glandular epithelium within a muscular layer. The three glands cause large vesicular swellings on the stalk of the pedicellariæ on which they occur; they are covered by undifferentiated outer body epithelium.

If we imagine that, in such pedicellariæ provided with stalk glands, the distal portion of the stalk above these glands degenerated, or was no more developed, we should have the form of pedicellaria which is called **p. globifer**. Such **globifers**, occasionally still provided with rudimentary seizing forceps, have been discovered in *Centrostephanus longispinus* and *Sphærechinus granularis*, side by side with ordinary pedicellariæ. They are capable of pendulous movements.

The **function of the pedicellariæ** has not yet been satisfactorily decided. The view that, in Echinoids, they play some part in locomotion, has recently been decidedly opposed, and it has been maintained that Echinoids move exclusively by means of their ambulacral feet and spines. It has further been asserted that the pedicellariæ lay hold of foreign objects, algæ, etc., and hold them fast on the upper side of the body in order to hide it, but this view also has been opposed, the function therein ascribed to pedicellariæ being claimed for the tube-feet. Such a function could, in any case, only be accessory. Another view is that the pedicellariæ serve for the holding of prey, and for carrying it to the mouth. In the *Asteroidea*, however, which take the food in large pieces (Fish, Crabs, Mussels, Snails, Echinoids, etc.), they could not well play this part.

The most probable view is that the pedicellariæ are protective organs, and fulfil the function of cleaning the spine-covered body. They clear away foreign bodies. Small animals which come into contact with the body are seized, and enveloped in the slimy secretion of the epithelium, or in the possibly poisonous secretion of the specialised glands of the pedicellariæ, and held until they are dead, and then "thrown overboard." In this way Echinoids and Asterooids may protect themselves from animal and vegetable growths, parasitic or otherwise. This would explain the astonishing cleanness of most members of this group in spite of their spinous covering.

E. The Masticatory Apparatus of the Echinoidea.

(Aristotle's Lantern.)

In all Echinoidea, with the exception of the *Spatangoida*, and perhaps of a few *Holactypoida*, the mouth, which lies at the centre of the peristomal area, is armed with five hard and pointed, interradially arranged teeth. These teeth are approximated or moved apart by means of a complicated **masticatory or jaw apparatus** lying within the test, and resting on the peristome. This apparatus is known as the **lantern of Aristotle**, and is of considerable size; it is covered on all sides by a closely applied integument, the **lantern membrane**, a continuation of the peritoneum. The spaces within the masticatory apparatus are completely separated by this membrane from the spacious body cavity within the test.

The masticatory apparatus resembles a pentagonal pyramid, the base of which is directed upwards, *i.e.* projects into the cavity of the test, while the tip, formed by the five teeth, lies in the mouth. Its axis is traversed by the œsophagus. It consists essentially of skeletal pieces, muscles, and ligaments.

a. **The skeleton of the masticatory apparatus** (Fig. 347) is composed of twenty-five pieces (including the teeth), radially grouped around the œsophagus; some of these pieces have received very unsuitable names. There are **five teeth**, **five pairs of jaws (alveoli)**, **five "sickles" (falces)**, and **five radii or rotulæ**. The "sickles" may be named intermediate plates, and each pair of jaws forms a "pyramid."

The principal part of the framework of the masticatory apparatus is formed by the five interradially placed pairs of jaws. These determine the conical or pyramidal form of the whole framework. The two pieces of each pair are firmly connected with one another on the outer side of the framework by a vertical interradial suture, and together form a hollow triangular pyramid, the fifth part of the whole pyramidal framework. Each single pyramid thus has one outer and two lateral surfaces. The five single pyramids are in contact with one another along these lateral surfaces, which lie radially to the axis of the whole framework. The edges along which the lateral surfaces come in contact are the axial edges, *i.e.* those turned towards the œsophagus. The suture, which divides each single pyramid into two halves or jaws, runs down the outer surface, exactly halving it. The walls of each single hollow pyramid are, however, not complete: (1) the two lateral surfaces do not quite meet along their inner edges, but there is a slit left between them (Fig. 347, **E**); (2) the basal wall (that turned upward) is wanting; when the soft parts are removed an aperture is found here, the **foramen basale**, which leads down into the cavity of the pyramid; (3) a large incision (**foramen externum**) is found at the base of the outer wall, and is either confluent with the foramen basale or is separated from the latter by an arch, the **arcus**.

The single pyramids (or pairs of jaws) are the supports and carriers of the **teeth**. Each tooth is a long, slender, and hard skeletal piece, curved, so that its convex side faces outwards; it traverses the cavity of the pyramid, and projects beyond it at both

ends. The lower end, which projects beyond the tip of the pyramid, is short and pointed, and forms the externally visible part of the tooth lying in the mouth. The upper end, which is directed aborally, is called the root of the tooth, and projects considerably beyond the foramen basale, it is usually coiled inwards (towards the axis of the masticatory framework). The growth of the tooth no doubt takes place principally at this root end. On its inner side, the tooth usually has a longitudinal ridge, the *carina*, and on its outer side is firmly attached to the outer wall of the

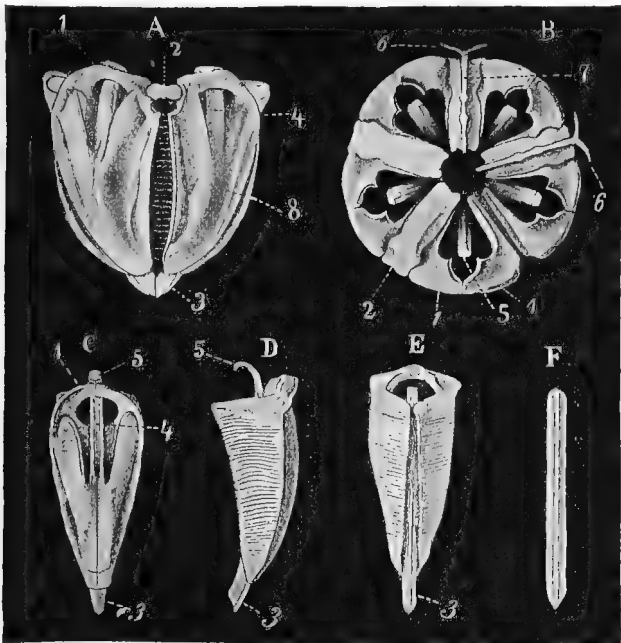

FIG. 347.—Masticatory apparatus of an Echinus, original. A, In profile. B, From the apically directed basal side. C, External view of a single pyramid. D, Side view of the same. E, Internal view of the same. F, Tooth. 1, Arcus; 2, intermediate plate; 3, freely projecting portion of the teeth; 4, median portion of a tooth; 5, upper portion of the same; 6, the limbs of a forked radius (7); 8, single pyramid in situ.

pyramid which it traverses, in such a way that it cannot move by itself, but only with its pyramid.

The fine structure of the teeth differs essentially from that of the other skeletal pieces of the body (*cf.* on this subject the special treatises mentioned in the Bibliography).

The **intermediate plates** are five more or less flat, oblong, skeletal masses lying on the base of the masticatory apparatus, like the spokes of a wheel round its central axis. Each of these intermediate plates rests on the bases of the two contiguous lateral walls of two pyramids [or pairs of jaws], and therefore between two foramina basalia.

Finally, lying apically upon these falces, are the five **forked radii**, which are also arranged like the spokes of a wheel. Each radius consists of a slender central stalk, and of two peripheral diverging prongs, and each is bent downwards in such a

way that its prongs point down towards the peristome over the edge of the base of the pyramid (Fig. 348, 5).

b. Muscles and ligaments of the masticatory apparatus (Fig. 348).—We must here refer back to what has been said of the perignathous apophysial ring, for the masticatory apparatus and the apophysial ring are, physiologically, closely connected. The most important muscles and bands of the masticatory apparatus connect its component pieces with the apophysial ring, and the latter must be regarded merely as a folding inwards of the edge of the peristome, which has come into existence

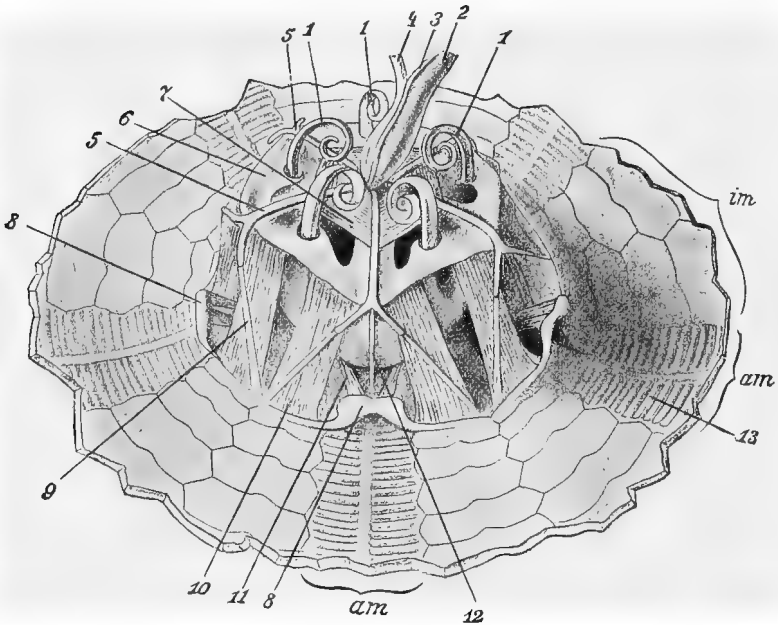

FIG. 348.—Masticatory apparatus of an Echinoid (*Toxopneustes*) in its natural position at the centre of the oral side of the shell, which has been broken off, original. 1, Root of the tooth; 2, intestine; 3, accessory intestine (?); 4, axial sinus with stone canal; 5, forked radii; 6, arcus of a single pyramid; 7, muscles of the forked radii; 8, perignathous apophysis (auricula); 9, ligaments of the forked radii; 10, adductor muscles of the teeth; 11, opening muscles of the teeth; 12, radial canal of the water vascular system; 13, anpullæ; *im*, interambulacrum; *am*, ambulacrum. The delicate transparent lantern membrane which covers the whole of the masticatory apparatus is not represented.

for the insertion of the masticatory muscles. The two apparatus are either absent or present simultaneously.

Round the masticatory apparatus, **ten thin ligaments** (9) connect the **forked radii** with the **interradial apophyses** of the perignathous girdle. The two bands which belong to each fork are attached to the prongs, and continue their lines downwards to the apophysial girdle; they are inserted into the two neighbouring interradial apophyses near the interradial sutures.

The two bands proceeding from each radial fork thus diverge downwards, and the two proceeding from each interradial apophysis of the perignathous ring diverge upwards.

These bands appear merely to serve for the attachment of the masticatory appa-

ratus, and for its maintenance in the upright position over the oral area. Further investigations, however, must decide whether the bands consist only of elastic fibres, or whether muscle fibres also occur in them.

The **adductor muscles of the teeth** (*musculi adductores dentium*, 10).—These are present in five interradial pairs; they are strongly developed as broad bands. The two muscles of a pair are attached, above, along the outer edge of the arcus of the pair of jaws (pyramid) to which they belong; and below, along nearly the whole length of the corresponding interambulacral apophysis of the perignathous ring. If these muscles contract, the upper ends of the pair of jaws (or pyramids) are drawn outwards and downwards, forcing the lower ends, with the teeth, inwards, *i.e.* towards the centre of the mouth. In other words, the externally visible pointed lower ends of the teeth are pressed together.

The **opening muscles of the teeth** (*musculi abductores dentium sive dilatatores oris*, 11).—These are five radially arranged pairs of muscles, which run horizontally. The two muscles of each pair are attached on the one side to the inner surface of the ambulacral apophyses (auriculæ), and, on the other, to the halves of the jaws nearest them, close to the ends which point downwards. These muscles counteract the adductor muscles; when they contract, the lower ends of the five pairs of jaws, and with them the tips of the teeth, are moved, centrifugally, towards the auriculæ. The teeth move apart, and the mouth opens.

The **intermediate jaw muscles** (*musculi intermaxillares*) connect the apposed lateral surfaces of the five pyramids with one another. The five pyramids close firmly together, when these muscles, which together act like a kind of sphincter, contract.

The **muscles of the forked radii** (7) lie on the upturned base of the masticatory apparatus, forming together a pentagonal ring by connecting the five handles of the forks for about half their length. As to the function of these muscles, we can only imagine that they depress the whole masticatory apparatus by their contraction, and thus cause the oral integument to project conically, especially if the adductor muscles of the teeth contract at the same time. It is well known that Echinoids are assisted in locomotion by the bulging forward of the tooth-carrying portion of the oral area, which is supported by the masticatory apparatus.

In the *Clypeastroida*, the frequently asymmetrical masticatory apparatus is more or less flattened, usually indeed quite flat. The teeth are not vertical, but slope towards one another quite obliquely, or are even arranged horizontally. The radii are wanting, and the intermediate plates are rudimentary.

F. The Calcareous Ring of the Holothurioidea.

In the Holothurioidea, the œsophagus is surrounded by a circle of ten calcareous skeletal pieces (Fig. 349, 3 and 13), five of which are radial and the other five interradial. This calcareous ring protects the nerve ring at its inner side. For a certain distance it supports the radial water vascular trunks and the tentacular vessels, and may indeed be regarded as the inner skeleton of the oral region of the body. The five longitudinal muscles or pairs of muscles of the body, and, where such are present, the five retractor muscles of the oral region, are attached to this ring, *i.e.* to its radial portions. The calcareous ring is altogether wanting in the remarkable free-swimming form *Pelagothuria* (Fig. 224, p. 286).

The form and size of the calcareous ring and its separate parts vary greatly. The radials are often lengthened backwards (apically) into two prongs of varying length, between which the radial water vascular trunks run.

It not infrequently happens that the separate parts become partially or altogether broken up into single pieces, which are connected together like a mosaic.

The number of pieces in the ring may increase or decrease. Where there are more or fewer than ten pieces, it is always the interradials which either increase or diminish in number. This is comprehensible when we remember that the longitudinal muscles of the body are attached to the radials.

The interradial portions are wanting in species of the genera *Phylloporus*, *Cucumaria*, and *Trochostoma*, and in many *Elasipoda*, especially in the whole family of the *Elpidiidae*.

More than ten pieces are found in many *Synaptidae*, viz. in nearly all those forms which possess more than ten tentacles. The number of extra interradials then usually corresponds with that of the supernumerary tentacles.

Six-rayed specimens of *Cucumaria Planci* have been described, whose calcareous ring consists of six radials and six interradials.

The ring which is originally radiate may become **bilaterally symmetrical**. Its plane of symmetry then agrees with the general plane of symmetry of the body, and passes through the fifth interradius (the so-called dorsal interradius in which the genital aperture lies) and the central (first) radius of the ventral side. The symmetry is determined either by the fact that the portions of the ring on the ventral side differ in form, size, and manner of connection from those on the dorsal side, or else by the presence of a larger number of such portions, in consequence of an increased number of interradials in definite sym-

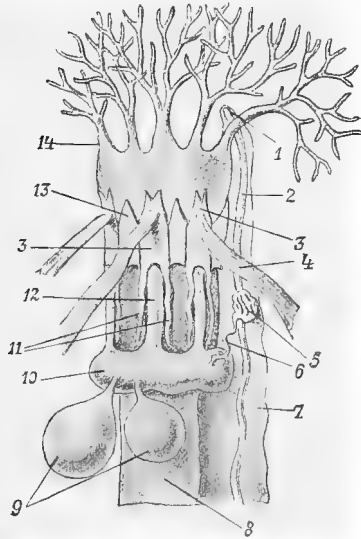

FIG. 349.—The œsophagus and half the oral tentacles of a dendrochirote Holothurian (after Ludwig). 1, Genital aperture; 2, genital duct; 3, radial pieces of the calcareous ring; 4, retractor muscles; 5, madreporite; 6, stone canal; 7, dorsal mesentery; 8, intestine; 9, Polian vesicles; 10, circular canal; 11, continuation of the radial calcareous pieces; 12, proximal portions of the radial canals of the water vascular system; 13, interradial pieces of the calcareous ring; 14, one of the two small ventral tentacles.

metrical interradial. For instance, *Synapta digitata* has seven interradials, one each in the mediodorsal and in the two ventral interradial, and two each in the dorso-lateral interradial.

The portions of the calcareous ring are more or less closely united together by means of connective tissue (never by means of muscles); in some cases they are firmly fused together.

Structures corresponding to the calcareous ring of the Holothurioidea have long been sought for in the other classes of the Echinodermata. It was thought that in the Echinoidea it might perhaps be represented either by the teeth or by the perignathous apophysial ring, or in certain parts of the masticatory apparatus.

The homology of the teeth of the Echinoidea with the calcareous ring of the

Holothurioidea is no longer maintained. The two structures are altogether differently related to the nervous and water vascular systems.

The homology of the calcareous ring with the perignathous apophysial ring of the Echinoidea is equally doubtful. The radials of the calcareous ring were in this case compared with the auriculæ (ambulacral apophyses). But each auricule is paired and consists of two processes, or folds, of the edge of the peristome, which may or may not be connected together by an arch; the radials, however, are from the first unpaired. Only the arches of the auriculæ could be compared with the radials; the arch, however, is not a single plate, but is formed by apposition of the two neighbouring ambulacral apophyses of one and the same ambulacrum.

The comparison of the calcareous ring with the masticatory apparatus or Aristotle's lantern of the Echinoidea still remains. The five radials have been compared with the five fork pieces, and the five interradials with the five arches of the pairs of jaws (pyramids) of the lantern. This comparison is in many ways plausible, but here, as before, many difficulties appear when the subject is carefully investigated. The arches of the jaws are paired structures, and cannot therefore be compared with the interradials, which are from the first unpaired. Moreover, it is very doubtful whether they represent independent skeletal pieces; they appear rather to be merely muscular processes of the halves of the jaws. Further, the sinews which proceed from the forks of the radial fork pieces are attached to the perignathous apophysial ring *interradially* (*i. e.* to the interambulacral apophyses), while the muscles which are attached to the radials of the calcareous ring of the Holothurioidea run strictly radially.

G. Further Deposits of Calcareous Matter.

Deposits of calcareous corpuscles and masses may occur in the connective tissue of the walls of various internal and external organs, especially in the ambulacral and alimentary systems. These will be considered in connection with the systems to which they belong.

We shall here only mention certain calcareous deposits in the *Clypeastroidea*. An *endoskeleton* is here formed. On the oral, as well as on the apical, inner surface of the test, needles, pillars, lamellæ, etc. rise, sometimes only at the edge, sometimes over large areas. These may traverse the whole depth of the test, connecting its opposite walls. They more or less completely separate the ambulacral structures from the other internal organs, such as the intestine, the genital organs, etc., and may in some cases attain such great development that, as in *Encope*, they form a sponge-like or cellular calcareous framework throughout the whole interior of the test, in which larger spaces are left for the masticatory apparatus, the intestine, the ambulacra, etc. Not infrequently, the ambulacral vessels are completely vaulted over by deposits of calcareous matter.

H. Concluding Remarks on the Section on the Skeletal System.

In the above section, I have adopted the views of those investigators whose wide and for the most part difficult researches have convinced them that at least the plates of the apical and oral systems (the central, infrabasals, basals, radials, and orals) are homologous throughout the whole group of the Echinodermata. These plates therefore must be ascribed to the common racial form. But these plates are

in reality only characterised according to their position in the adult animal, whether radial or interradial, apical or oral, and according to the place of their first appearance (above one or the other coelomic vesicle). They have **no other** distinctive characteristic by which, for example, a radial could be recognised throughout the class of the Echinodermata. It is therefore still possible that such correspondence may be merely superficial, merely the expression of the radiate structure so common among Echinoderms. There is nothing astonishing in the fact that the skeleton of a radiate animal commences at the poles either with radially or with interradially arranged plates. Such correspondence, then, as far as it goes, is described as homology. But nothing is really gained by insisting that such and such Ophiurids "possess infrabasals," because the system of plates commences at the apex with five radial plates, which are followed by another outer row of radial plates. Is it, after all, certain that the infrabasals are wanting when the skeletal system at the apex begins with interradial plates (which are on that account called basals) ?

III. The Outer Morphology of the Holothurioidea.

The Holothurioidea form an exception to the rule which applies to all other Echinoderms that the outer form of the body is accurately reproduced in the test of skeletal plates. This test gives us, as a rule, exact information as to the position of the outer apertures of the internal organs, and as to the relation of the radii or ambulacra, to the interradial or interambulacra. But in the Holothurioidea, in whose integument only microscopically small and isolated calcareous bodies occur, this is not the case. Having treated of the external morphology of the *Echinoidea*, the *Asteroidea*, the *Ophiuroidea*, and the *Pelmatozoa* in the section on the skeletal system, we must now give some account of the outer morphology of the Holothurioidea.

We shall begin with those forms in which the body, elongated in the direction of the principal axis, is, in section, circular or pentagonal with rounded edges (*cf.* for example, *Cucumaria Planci*, Fig. 226, p. 287). At the oral pole of the principal axis (*i.e.* in the Holothurioidea, **anteriorly**) lies the **mouth**, surrounded by feelers ; at the opposite, apical (**posterior**) pole, the **anus**. Along the body, from before backward, run five ridges, corresponding with the radii, and causing the pentagonal form of the transverse section. On each edge there are two longitudinal rows of tube-feet.

Careful examination shows that the radiate structure of *Cucumaria* is even externally disturbed by certain characters which make it bilaterally symmetrical. There is only **one** genital aperture, at the oral margin of an interradius, which we will arbitrarily call the **dorsal interradius**. Further, of the ten oral feelers, **two adjacent feelers** are much smaller than the rest. They lie exactly opposite the genital aperture, and distinguish the **middle ventral radius**. The plane which passes through the dorsal interradius and the middle ventral radius, in the direction of the principal axis (*i.e.* longitudinally through the body) is the **plane of symmetry**.

If the animal is opened, it is seen that this external symmetry corresponds with an internal symmetry ; the anterior limb of the intestine is attached by a mesentery to the body wall in the dorsal interradius. The stone canal and the genital glands lie in the dorsal interradius, and the Polian vesicle in the middle ventral radius.

The application of the terms “ventral” and “dorsal,” in very many Holothurioidea, is fully justifiable, since there arises, parallel to the principal (longitudinal) axis, a flattened **creeping sole**, along the middle of which the above-named **ventral radius** runs, while the middle of the vaulted **dorsal surface** opposed to this creeping sole is occupied by the **middle dorsal interradius**.

The radii and interradii now become arranged in such a way that three radii (one middle and two lateral) belong with their ambulacral

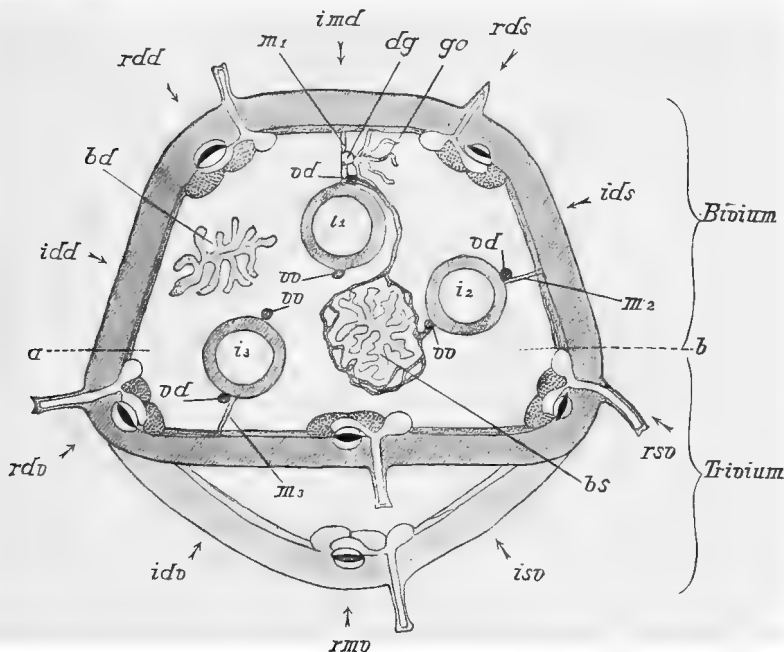

FIG. 350.—Diagrammatic section illustrating the symmetry of the Holothurioidea. Development of the bivium and the trivium (mainly after Ludwig). *imd*, Medio-dorsal interradius; *ids*, left dorsal ditto; *isv*, left ventral; *idv*, right ventral; *idd*, right dorsal interradius; *rds*, left dorsal radius; *rsv*, left ventral ditto; *rmv*, medio-ventral; *rdv*, right ventral; *rdd*, right dorsal radius; *m₁*, anterior or dorsal mesentery; *m₂*, middle or left; *m₃*, posterior or right mesentery; *i₁*, *i₂*, *i₃*, first, second, and third, or anterior, middle, and posterior limbs of the intestine; *vd* and *vv*, dorsal and ventral intestinal vessels; *bd* and *bs*, right and left branchial tree (aquatic lung); *go*, gonad; *dg*, genital duct; *a*, body cavity.

feet to the creeping sole, and form the **trivium**; while on the dorsal surface two radii (one right and the other left) form the **bivium**. Two interradii, on the other hand, belong to the creeping sole, and three to the dorsal surface (cf. the diagram, Fig. 350).

The creeping sole usually runs along over the whole length of the body, less frequently (*Psolus*, *Psolidium*) it is limited to a circumscribed region between the anterior and posterior ends.

The difference between the ventral and the dorsal side (the trivium and the

bivium) becomes still more accentuated by the different development of the ambulacral feet in the two regions. On the ventral side, these feet are altogether or principally locomotory tube-feet (ending in suckers), on the dorsal side (the bivium) they are exclusively or chiefly non-locomotory papillæ (with more or less pointed ends). This difference between the dorsal and ventral tube-feet is found both in those forms in which the ambulacral feet, limited to the radii, are arranged in one or more longitudinal rows, and in those in which they are also found in the interradii and arranged irregularly.

In the genus *Psolus*, the distinction between dorsal and ventral, and consequently the bilateral symmetry of the body, becomes still more marked by the entire absence

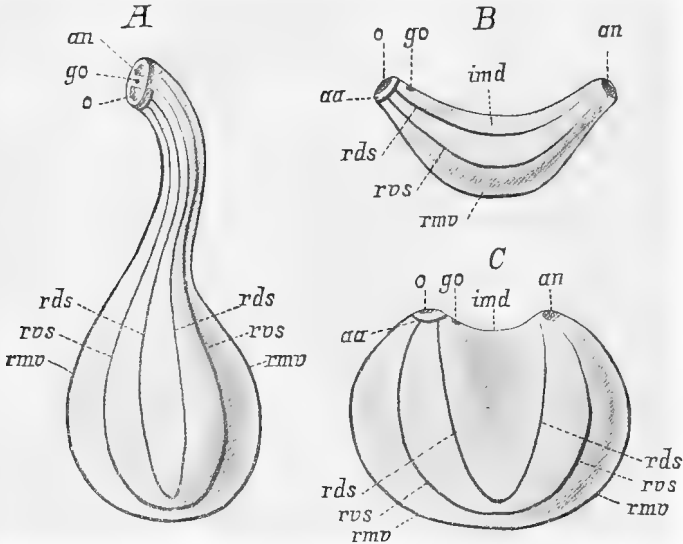

FIG. 351.—Derivation of *Rhopalodina* (A) from an ordinary *Holothurian* (B) (after Ludwig). C, Ideal intermediate form. *rds*, *rvs*, *rmv*, left dorsal, left ventral, medioventral radius; *imd*, mediiodorsal interradius; *o*, mouth; *an*, anus; *go*, genital aperture; *aa*, water vascular ring.

of ambulacral appendages on the bivium. The tube-feet of the middle ventral radius may also be wanting in some species of this genus.

Where ventral and dorsal are sharply distinguished, the mouth and the anus tend to shift on to the ventral side.

The condition of the genus *Rhopalodina* (Fig. 351) is quite peculiar. The body is pear-shaped, and produced into a long stalk. At the end of this stalk, close to one another, lie the mouth and the anus, and between them the genital aperture. On the swollen portion of the body there are ten double longitudinal rows of ambulacral feet, so that it appears as if *Rhopalodina* possesses ten radii, whereas it in reality possesses only five. To obtain this condition we have to imagine (1) the body of an ordinary dendrochirote *Holothurian* bent upward anteriorly and posteriorly, and (2) the approximation of the anus and mouth by the great shortening of the dorsal interradius. The accom-

panying diagram will help to make this clear. The genus *Ypsilothuria* seems to have become fixed while in the act of being similarly modified.

In the genus *Psychropotes* (Fig. 223, p. 285) the dorsal surface is prolonged beyond the anus into a long caudal appendage directed posteriorly. *Peniagone* is distinguished by an anteriorly inclined comb, rising transversely from the neck. On the swimming disc of *Pelagothuria*, cf. Figs. 224 and 225, p. 286.

IV. Position and Arrangement of the Most Important Organs in the Radii.

The position and arrangement of the organs in the radii can best be explained by describing cross-sections. In the *Asteroidea*, the

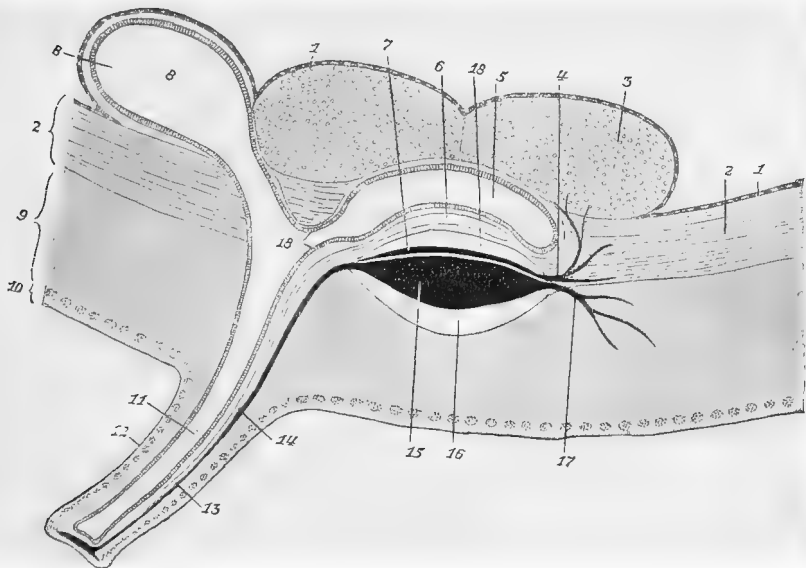

FIG. 352.—Transverse Section of a radial region of the body wall of a Holothurian, partly diagrammatic. 1, Endothelium of the body cavity; 2, circular musculature; 3, longitudinal musculature; 4, motor nerve; 5, radial water vascular canal; 6, radial blood lacuna; 7, radial ridge of the deeper oral nervous system; 8, ampulla; 9, cutis; 10, epidermis; 11, tube-foot canal of the vascular system; 12, tube-foot; 13, nerve of the same; 14, vessel of the same; 15, radial nerve strand of the superficial oral nervous system; 16, epineural canal; 17, peripheral nerve; 18, pseudohæmal canal.

Ophiuroidea, and the *Crinoidea*, in which the body is produced radially into arms, the sections to be described will be those of the arms; in the *Holothurioidea* and *Echinoidea* the sections are of a radial region of the body wall.

Holothurioidea (Fig. 352).—In a transverse section through a

radial region of the body wall of an *actinopodan Holothurian* we find, proceeding from without inwards:—

- (a) The outer body epithelium (10).
- (b) The cutis, or the connective tissue layer of the body wall, with the calcareous corpuscles (9).
- (c) The epineural canal (16).
- (d) The radial nerve trunk of the superficial oral system (15).
- (e) The radial nerve trunk of the deeper oral system (7).
- (f) The subneural pseudohæmal canal (18).
- (g) The radial blood lacuna (radial blood vessel) (6).

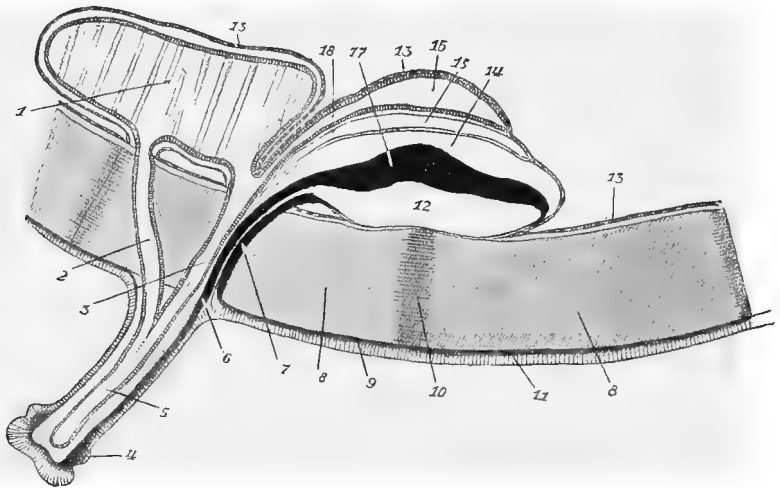

FIG. 353.—Transverse Section through a radial region of the body wall of an Echinoid, partly diagrammatic. 1, Ampulla, traversed by muscle filaments; 2 and 3, the two canals traversing the test and connecting the ampulla and the tube-foot canal (5); 4, circular nerve in the terminal disc of the tube-foot; 5, tube-foot canal; 6, nerve of the tube-foot; 7, integumental nerve; 8, calcareous substance of the ambulacral plate; 9, nerve plexus in the depths of the body epithelium; 10, suture between two plates of the two contiguous rows of ambulacral plates; 11, body epithelium; 12, epineural canal; 13, endothelium of the body cavity; 14, pseudohæmal canal; 15, radial blood vessel; 16, radial canal of the water vascular system; 17, radial nerve strand; 18, lateral canal of the radial canal of the water vascular system to the ampulla.

- (h) The radial canal of the water vascular system (5), and the tube-foot canal branching from it transversely (11), and finally also the ampulla of the tube-foot (8).
- (i) The circular musculature of the body (2).
- (k) The longitudinal musculature of the body (3).
- (l) The endothelium of the body cavity (1).

The figure also illustrates the relation of a tube-foot to its canal and ampulla.

This description does not apply to the *Paractinopoda* (*Synaptidæ*) in so far as, in these latter, the radial canals of the water vascular system are altogether wanting.

Echinoidea (Fig. 353).—In a transverse section of an ambulacral area we find :—

- (a) The outer body epithelium (11).
- (b) The cutis, almost entirely calcified, as ambulacral plates (8).
- (c) The epineural sinus (12).
- (d) The radial nerve trunk (17).
- (e) The subneural sinus—pseudohæmal canal (14).

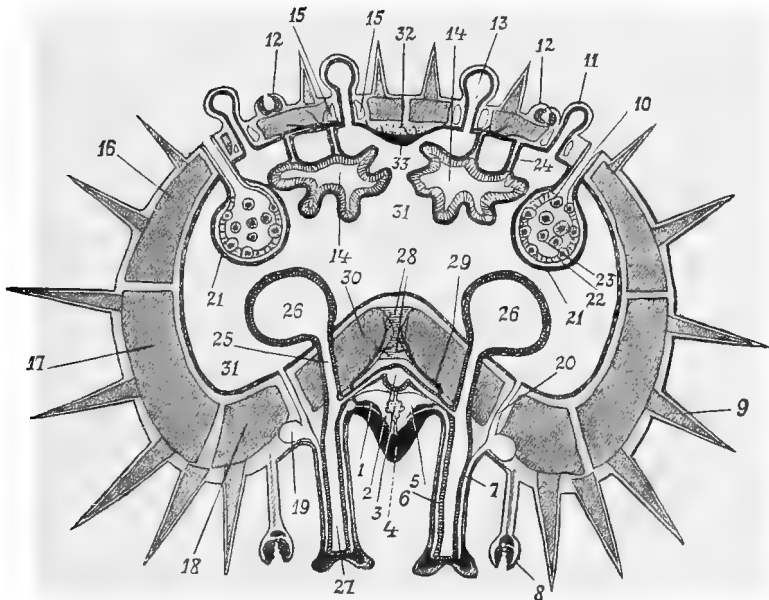

FIG. 354.—Transverse Section through the arm of an Asteroid, diagrammatic. 1, Ridges of the deeper oral nervous system; 2, radial canal of the water vascular system; 3, continuation of the axial organ in the arm; 4, radial nerve ridge of the superficial oral system; 5, pseudohæmal canal; 6 and 7, branches of the pseudohæmal system running to the tube-feet; 8, pedicellaria; 9, spine; 10, genital aperture; 11, branchial vesicle (papulla); 12, sessile pedicellaria; 13, continuation of the body cavity into the branchial vesicle; 14, brachial diverticulum of the stomach; 15, circular sinus of the schizocoel round the branchial vesicle; 16, supramarginal plate; 17, inframarginal plate; 18, adambulacral plate; 19, marginal canal of the pseudohæmal system; 20, canal connecting it with the body cavity; 21, endothelium of the body cavity; 22, genital sinus of the coelom; 23, gonad (ovarium); 24, mesenteries of the diverticula of the stomach; 25, ampullæ canal of the water vascular system; 26, ampullæ; 27, tube-feet canal; 28, upper and lower transverse muscles of the ambulacral skeleton; 29, motor branches of the deeper oral nervous system; 30, ambulacral plates; 31, brachial cavity (coelom); 32, apical longitudinal muscle of the arm; 33, nerve ridge of the apical nervous system.

- (f) The radial blood vessel (15).
- (g) The radial canal of the water vascular system (16).
- (h) The endothelium of the body cavity (13).

The figure at the same time illustrates the relation of the tube-feet to their ampullæ, the double pores, etc.

Asterioidea (Fig. 354).—In a transverse section through the lower (oral) wall of an Asteroid arm we find, from without inwards :—

- (a) That the body epithelium stretching across the ambulacral furrow is thickened into the longitudinal ridge which stands up in the base of the furrow, and here contains :
- (b) The radial nerve strand (lying in the epithelium itself) (4).
- We find further : (c) below the latter, to the right and left, the trunks of the deeper oral nervous system (1).
- (d) The radial pseudohæmal canal (5), which is divided into two lateral portions by a vertical septum.

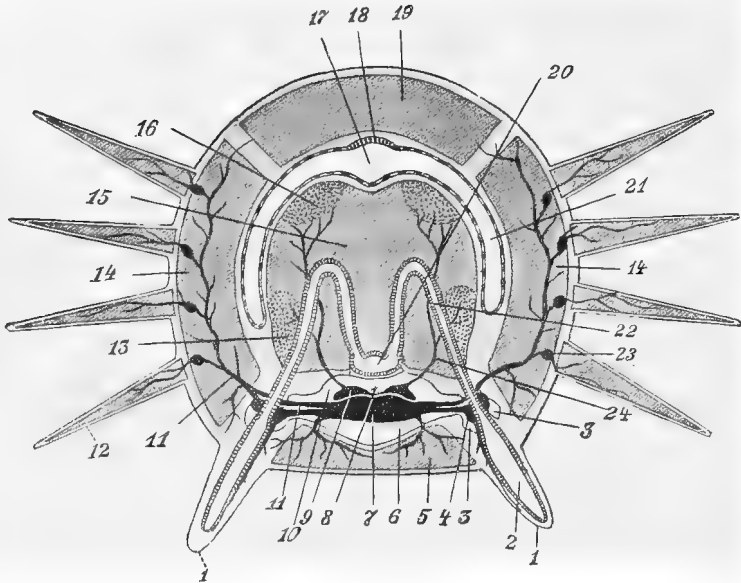

FIG. 355.—Transverse Section through the arm of an Ophiuroid, diagrammatic. 1, Ambulacral tentacle; 2, its water vascular canal; 3, epineural circular canal at the base of the tentacle; 4, circular ganglion at the base of the tentacle; 5, ventral shield; 6, radial epineural canal; 7, radial nerve trunk of the superficial oral nervous system; 8, continuation of the axial organ in the arm (?); 9, radial trunk of the deeper oral nervous system; 10, radial pseudohæmal canal; 11, peripheral branch of the radial nerve trunk; 12, spine; 13, lower (oral) intervertebral muscle cut across; 14, lateral shield; 15, vertebral ossicle; 16, upper (apical) intervertebral muscle; 17, dorsal canal of the brachial cavity (coelom); 18, ciliated strip of endothelium; 19, dorsal shield; 20, radial canal of the water vascular system; 21, lateral portions of the brachial cavity, which are segmentally repeated; 22, branch of the water vascular system running to the tentacle; 23, ganglion at the base of the spine; 24, motor branch of the nerve (of the deeper oral system).

- (e) The radial canal of the water vascular system (2), with the canals of the tube-feet branching from it. (All these are separated from one another by thin layers of connective tissue.)
- (f) The ambulacral plates (30), with the transverse muscles which connect them (28).
- (g) Still further in, and projecting into the body cavity, are the ampullæ (26) of the tube-feet.

(h) The endothelium of the body cavity (21).

The figure also shows the relations of the ampullæ to the tube-feet and their canals, and the organs of the apical side of the arm of an Asteriod.

Ophiuroidea (Fig. 355).—In a section through an arm, proceeding from the lower (oral) to the upper (apical) side, we find:—

- (a) The body epithelium.
- (b) The ventral shield (5).

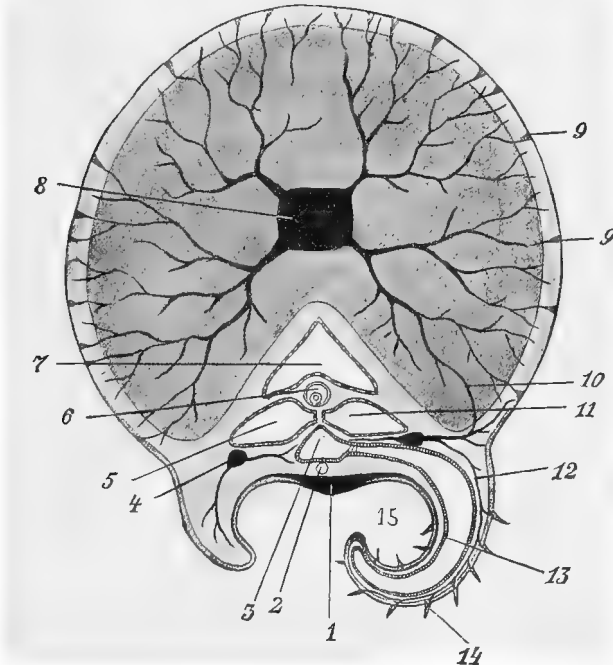

FIG. 356.—Transverse Section through the arm of a Crinoid, diagrammatic. 1, Radial nerve trunk of the superficial oral nervous system; 2, radial pseudohæmal canal; 3, radial canal of the water vascular system; 4, the paired deeper longitudinal nerves of the arms; 5, 7, and 11, the three radial sinuses of the brachial coelom; 6, genital sinus with genital rachis; 7 (see 5); 8, nerve trunk of the apical nervous system; 9, end of the nerves at the surface; 10, branch connecting 4 and 8; 11 (see 5); 12, tentacle nerve; 13, tentacle canal of the water vascular system; 14, sensory cone on the tentacle; 15, food groove of the arm.

- (c) The radial epineural canal (6).
- (d) The radial nerve trunk of the superficial oral nervous system (7).
- (e) The radial nerve trunk of the deeper oral system (9).
- (f) The (subneural) radial pseudohæmal canal (10).
- (g) The radial canal of the water vascular system (20).
- (h) The calcareous mass of the vertebral ossicle (15), which is traversed by the tentacle canals (22), and the intervertebral musculature (16 and 13).

- (i) The endothelium of the body cavity.
- (k) The much diminished body cavity itself (enterocœl, 17 and 21).
- (l) The dorsal (apical) body wall, which in this connection is of no further interest.

Crinoidea (Fig. 356).—On the section of the arm of a Crinoid, proceeding from the oral to the apical side, we find :—

- (a) The body epithelium covering the food groove.
- (b) Deep in this epithelium, the radial nerve trunk of the superficial oral system (1).
- (c) Below the epithelium (not invariably present) a small schizocœl canal (pseudohæmal canal (2).
- (d) The radial canal of the water vascular system (3).
- (e) At its two sides, the paired subepithelial longitudinal nerves of the arms (4).
- (f) The three radial sinuses; viz. two paired sinuses (5 and 11), separated by a vertical septum (the so-called ventral or subtentacular canals), and a third unpaired sinus (7), the dorsal canal, separated from the first two by a horizontal (transverse) septum.

All these parts lie embedded in somewhat sparse connective tissue. In the middle between them run :—

- (g) The narrow genital sinus (6), with the genital tube (rachis) within it.
- (h) The skeletal ossicle of the arm, or (according to the plane of the section) the apical and oral muscles and bands, uniting the ossicles.
- (i) In the centre of the joint we find the section of the nerve canal (axial canal) with the radial trunk of the apical nervous system (8) which it encloses.

The figure also shows the tentacles, and the nerves which connect the paired radial nerves of the oral with the radial trunk of the apical nervous systems.

V. The Integument.

The integument of the Echinodermata consists of (1) the unilaminar **body epithelium** which covers the whole body with its processes and appendages, and (2) a strong subjacent **connective tissue layer** (the **cutis** or **corium**) of mesenchymatous origin, in which the various skeletal structures develop. The cutis forms by far the largest part of the body wall. Internally, it is either directly lined by the endothelium of the body cavity or else is separated from the endothelium by musculature (*Holothuria*, *Asteroidea*).

(1) **The body epithelium.**—(a) This is **distinct** from the subjacent cutis in the *Echinoidea*, *Asteroidea*, many *Holothurioidea*, and on the oral surface of the disc and arms of the *Crinoidea*; also in the *Euryalæ*.

In the *Ophiuroidea* (excluding *Euryalæ*), and on the apical side of the disc and

arms of the *Crinoidea*, there is **no sharp line of distinction** between the body epithelium and the cutis. Such a distinction is, however, demonstrable in very young stages. In later stages of development the elements of the two forms of tissue seem to mingle, and skeletal substance forms right up to the surface of the integument.

In many *Holothurioidea* also, the body epithelium, as such, is very indistinct. In *Cucumaria*, for example, the cutis appears at the surface of the integument, and the body epithelium is found in the form of nests of cells scattered within the peripheral layer of the cutis. Each cell sends a thin process to the surface of the integument.

(b) The body epithelium is usually covered by a **cuticle** of varying thickness.

(c) The body epithelium is ciliated over the whole surface of the body in the *Astroidea* and *Echinoidea*, but in the *Crinoidea* only in the food grooves.

The integument of the *Ophiuroidea*, *Crinoidea* (with the exception of the food grooves), and *Holothurioidea*, is **non-ciliated**.

(d) The body epithelium of the *Astroidea* is rich in glands. The glands are usually unicellular (goblet glands, granular glands, etc.), and remain on the level of the epithelium. In *Echinaster sepositus*, large multicellular glands are also found, whose pear-shaped or spherical bodies dip down into the cutis. In the integument of the *Holothurioidea* also glands have been described, and it will probably be discovered that certain epithelial cells of the *Echinoidea* are of a glandular character.

(e) The integumental pigment may belong to the epithelium as well as to the cutis; it not infrequently occurs in both layers.

(f) Epithelial sensory cells, ganglion cells, and nerve fibres will be described in another place.

(2) The **cutis** of the Echinodermata is always very thick, although it shows extraordinary variations in this respect according to the genus and species. It everywhere consists (a) of a **ground- or intercellular substance** of gelatinous or cartilaginous consistency, and (b) of the nucleated connective tissue cells which secrete this ground-substance and are embedded in it; these cells are spindle-shaped, star-shaped, etc. There are, further, (c) in all Echinodermata, **granulated plasm cells or wandering cells (amœbocytes)** similar to those which are to be found in different body fluids. These can move, like amœbæ, in and through the different tissues.

In *Holothurioidea*, these wandering cells may collect in such quantities in the deep looser layer of the cutis, as to form a distinct layer (Wanderzellenschicht).

The **calcareous skeleton** of the body wall of the Echinodermata always lies in the cutis, whether it consists, as in the *Holothurioidea*, of isolated calcareous corpuceles, or, as in other Echinoderms, of larger plates of lattice-like or spongy structure. In sections through the decalcified body wall, the spaces in which the skeleton lay are visible. In other words, the connective-tissue fills up all the spaces in the spongy calcareous skeleton. Since the wandering cells can travel to the surface through these spaces, they may play an important part in the nutrition of the soft parts which lie at the surface of the skeleton, especially in *Asteroids* and *Echinoids*.

It appears that even the intercellular substance may occasionally become differentiated into fibres, which, however, are difficult to distinguish from the fibrous processes of the connective-tissue cells.

Where two skeletal plates are united by a suture, this suture is formed of thickly crowded parallel fibres, which connect the ground-substance of one plate with that of the other.

VI. The Water Vascular System.

(System of the Ambulacral Vessels: Hydrocœl.)

This is a system of canals filled with fluid, the arrangements of which may be generally described as follows.

An outer aperture, the **madreporite**, leads first into a vesicular section of the cœlom, the **madreporitic ampulla**. This again is connected by means of a **stone canal** (so called because that portion of its wall which consists of connective tissue is often calcified) with a **ring canal** which surrounds the œsophagus. Into the madreporitic ampulla there opens, further, the **axial sinus** of the body cavity, which follows the stone canal in its course, and surrounds a lymphatic gland, the **axial organ**.

The **water vascular ring** may carry various accessory structures, whose principal function seems to be that of lymphatic glands, and which are known as **Polian vesicles**, **Tiedemann's bodies**, etc.

From the ring canal there run out into the radii of the body, either in the body wall or in close contact with it, as many **radial canals** as there are radii (usually therefore five). The radial canals send off, on each side, **tube-foot canals**, which run into outer appendages of the body wall, ending blindly at their tips. These extensible appendages are usually present in great numbers, and serve either as **tube-feet for locomotion** (*Holothurioidea*, some *Echinoidea*, *Asteroidea*), and are then provided with a terminal sucker, or as **tentacles**, **tentacular gills**, etc., for tactile purposes, for respiration, and for conducting food (some *Echinoidea*, *Ophiuroidea*, *Crinoidea*). In connection with the tube-feet canals, **tube-foot ampullæ** are very often found (*Holothurioidea*, *Echinoidea*, *Asteroidea*); these are accessory contractile vesicles, which serve for the swelling of the tube-feet. Special valves are so arranged as to prevent the flowing back of the water vascular fluid into the radial canals (Fig. 352, p. 409).

The chief departures from this general description met with in the five classes of Echinoderms, affect the madreporite, the madreporitic ampulla, and the stone canal. These will be described in detail later on.

Structure of the wall of the water vessels.—Lining the lumen of the vessels, there is generally found, first of all, a **ciliated epithelium**. This is followed, in most parts (always in the ambulacral appendages), by a **longitudinal muscle layer**. Outside this latter lies a **layer of connective tissue**, and, outermost of all, there is almost always an **external ciliated epithelium**. On the ambulacral appendages (the tube-feet and tentacles) this last is nothing more than the **external body epithelium**. But in those parts of the water vascular system which **project into or lie in the body cavity**, it is the **endothelium of the cœlom**. This outer epithelium of the water vascular system is rarely altogether wanting; it is, however, absent in such parts of the system as run embedded in the body wall. A circular musculature is seldom found; it only occurs locally.

Calcareous corpuscles may be formed in the connective tissue layer of the wall in other parts of the water vascular system besides the stone canal. Such calcification always takes place in locomotory tube-feet.

The fluid contained in the water vascular system is sea-water with traces of albumen (in a 0·5 – 2 per cent solution). Floating in this fluid are found amoeboid cells (lymph bodies) and coloured corpuscles often united into small lumps. The fluid occasionally appears of a pale yellow, or reddish, colour.

The origin of this fluid is a question of frequent recurrence. The view which still appears best supported is that sea-water flows in through the madreporite and the stone canal, but an exactly opposite view has also been maintained. The observations made on this subject appear to contradict one another, it being very difficult to carry on investigations in a decisive and satisfactory manner.

A. Madreporite and Stone Canal.

1. **Holothurioidea** (Fig. 357).—The condition which must be considered as the original is that in which only one stone canal occurs; this is attached to the dorsal mesentery (*cf.* p. 406), and its madreporite lies mediodorsally in the integument, and its pore canal or canals open outward direct.

Such a condition is found in the adult only in certain *Elasipoda* and in *Pelagothuria*.

In the large majority of Holothurioidea, the stone canal loses all direct communication with the exterior, while at its distal end, which now lies in the body cavity, a new inner madreporite forms, through whose canals communication is established between the stone canals and the body cavity.

In a comparatively small number of Holothurioidea (never in *Molpadidae* and *Elasipoda*) the number of stone canals increases (the single canals usually shortening at the same time), and may finally become very great (over 160).

The inner madreporite is found in the form of a variously shaped swelling on the stone canal, which is often S-shaped or spirally coiled. Only the primary stone canal is connected with the dorsal mesentery; this is never the case with accessory canals. These latter float freely in the body cavity, and this is also the condition of the primary stone canal of the *Aspidochirotae*, which has lost its connection with both the body wall and the mesentery.

More than one canal is found in only a very small number of forms even among the *Synaptidae*, the *Dendrochirotae*, and *Aspidochirotae*. The number of accessory canals varies greatly in different forms; it does not seem to be of systematic importance, since it varies in individuals of one and the same species. It is probable that the accessory canals, ontogenetically, bud off secondarily from the water vascular system, whereas the dorsomedian stone canal arises primarily from the canal which, in the larva, connects the hydrocoel with the exterior.

Branched stone canals, with a madreporite at the distal end of each branch, occur in *Synapta Beselii*, Jäg; and *Thyone chilensis*, Semp.

The madreporite of the primary (mediodorsal) stone canal. The simplest, and no doubt also the most primitive condition is found in *Pelagothuria* and in certain *Elasipoda*, e.g. species of the genera *Scotoplancs*, *Kolga*, *Parelpidia*, *Elpidia*, *Peniagone*, and *Benthodytes*. In these the stone canal opens simply through a single mediodorsal pore, which lies in front of the genital aperture (Fig. 357 A). In other species of these genera and in species of *Psychropotes*, *Latmogone*, *Ilyodæmon*, more than one madreporite pore is found, their number varying, according to the species, from two or three to fifty or more (Fig. 357, B). In other cases (species of the *Elasipoda* genera *Irua*, *Elpidia*, *Oncirophanta*, *Orphnurgus*, *Benthodytes*, and the *Molpadiidae* genera *Trochostoma* and *Ankyroderma*) the distal end of the stone canal still remains

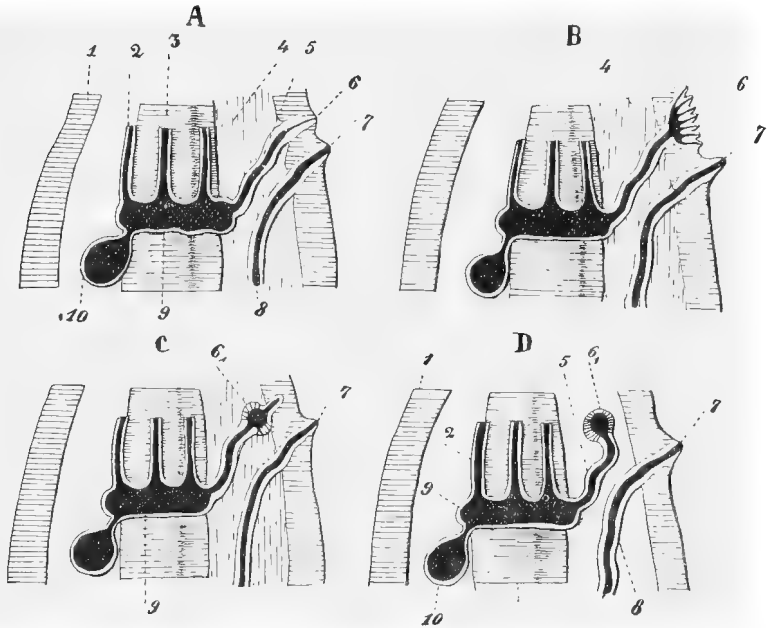

FIG. 357.—Diagrams illustrating the various relations existing between the stone canal and the madreporites in the Holothuriidea. 1, Body wall; 2, commencement of the radial canal; 3, oesophagus; 4, dorsal mesentery; 5, stone canal; 6, outer madreporite; 6i, inner madreporite; 7, genital aperture; 8, genital duct; 9, water vascular ring; 10, Pollian vesicle.

embedded in the body wall, but it has lost the pore or pores which formed the communication between it and the exterior. New pores therefore arise laterally at the distal portion, which still lies in the body wall, and these now open communication between the lumen of the stone canal and the body cavity, and make this widened part of the stone canal into an **inner madreporite** (Fig. 357, C). Other *Molpadiidae* and the *Synaptidae* and *Dendrochirota* differ from these last only in the fact that in them the stone canal has become entirely detached from the body wall (Fig. 357, D). In the *Aspidochirota*, which also possess an inner madreporite, the latter appears complicated, in that its pore canals do not open direct into the lumen of the stone canal, but first into a collecting cavity, which in its turn communicates by means of an aperture (occasionally through several) with the lumen of the stone canal.

2. **Echinoidea** (Fig. 358, 33).—In the Echinoidea, so far as is

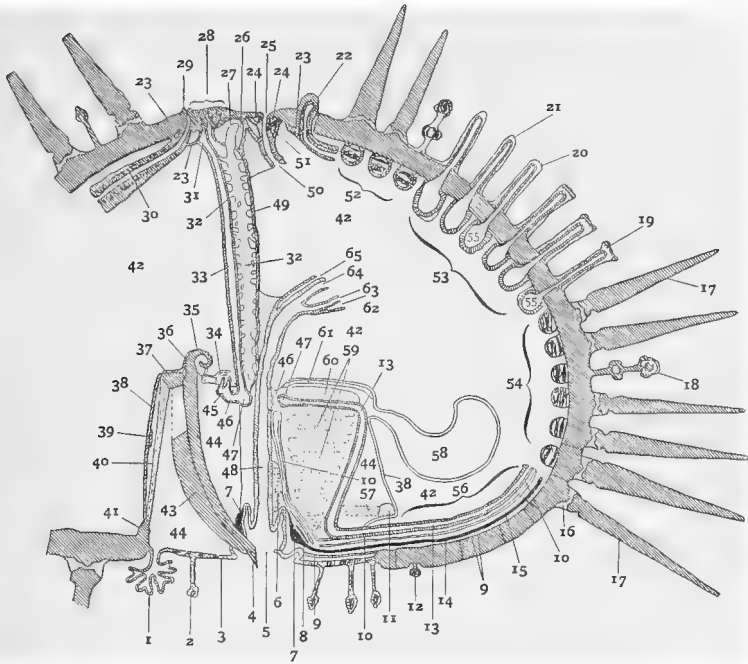

FIG. 358.—Diagram of the organisation of a regular Echinoid. Section in the direction of the principal axis. The surface of the section lies interradially on the left and radially on the right. The left half is incomplete. 1, External gill (this would not exactly come into this section, since there are five pairs of interradially placed gills); 2, seizing pedicellaria; 3, oral integument; 4, tooth; 5, mouth; 6, cushion of connective tissue; 7, nerve ring of the superficial system; 8, deeper oral nervous system; 9, radial epineural canal; 10, radial blood vessel; 11, arch of the ambulacral apophysis (auricula); 12, spheridium in its niche; 13, radial canal of the water vascular system; 14, radial nerve trunk (of the superficial oral system); 15, radial pseudohæmal canal; 16, circular ganglion at the base of the spine; 17, spine; 18, glandular pedicellaria; 19, ambulacral tube-feet with terminal disc; 20, 21, ambulacral tentacles (without terminal disc); 22, terminal feeler or tentacle emerging through the pore in the radial (ocular) plate; 23, apical (genital) ring sinus; 24, perianal sinus of the coelom; 25, anus; 26, sinus, into which a process (27) of the axial organ projects; 27, aboral process of the axial organ; 28, madreporite; 29, genital aperture on the genital papilla; 30, genital duct; 31, madreporitic ampulla, into which the stone canal and axial sinus enter from below; 32, axial organ; 33, stone canal; 34, part taken by the blood lacuna in the formation of the Polian vesicle; 35, root of the tooth; 36, muscle of the forked radii (Fig. 348, 7) cut through; 37, arch (arcus) of a jaw pyramid of the masticatory apparatus; 38, lantern membrane; 39, ligament of a forked radius; 40, adductor muscle of the teeth; 41, interambulacral apophysis; 42, general body cavity (coelom); 43, pyramid; 44, peripharyngeal sinus, lantern sinus of the coelom; 45, part taken by the water vascular system in the formation of the Polian vesicle; 46, circular vessel of the blood lacunar system; 47, water vascular ring; 48, oesophagus; 49, axial sinus of the coelom; 50, hind-gut; 51, perirectal sinus of the coelom; at 52 and 54 the section is not quite radial, so that it does not, as at 22 and 56, take in the radial canal of the water vascular system, but passes transversely through its lateral canals which lead to the ampullæ; in 53 the plane of the section lies still more to the side, so that the ampulla is taken in (cf. Fig. 353); 57, adductor muscle of the teeth; 58, Stewart's organ; 59, muscles between the pyramids; 60, intermediate plate; 61, forked radius; 62 and 65, intestinal vessels; 63, accessory intestine; 64, principal intestine. The accessory intestine in reality runs on the axial side of the principal intestine.

yet known, there is always only one stone canal, and it always communicates with the exterior by means of the pores of the madreporite. This communication is, however, by no means direct. The pores of the madreporite first lead into a small cavity lying below it, the **madreporic ampulla**, into which opens, on the one hand, the ascending stone canal, and, on the other hand, the axial sinus of the enterocoel, to be described later. The stone canal, on leaving the ampulla, traverses the body cavity, following the axial sinus with its lymph gland, and runs down to the water vascular ring, which in the *Cidaroida* and *Clypeastroida* encircles the œsophagus immediately above the masticatory framework (Fig. 358), but, in the *Spatangoida*, immediately above the mouth. In both the former groups the stone canal is short and more or less straight, but in the *Spatangoida* it is very long and runs in coils.

On the possibly great morphological importance of the ampullæ, cf. the section on Ontogeny.

Echinocyamus pusillus, a *Clypeastrid*, shows an embryonic condition in the adult in that the madreporite has only one pore. All other Echinoids, examined with reference to this point, possess as adults several or numerous pores. The number of pores increases with age and growth.

The pore canals which traverse the madreporites may anastomose with one another. They may enter the ampulla through several inner pores or else through one common inner aperture. In the *Spatangida*, they traverse the substance of a large skeletal process (apophysis) of the madreporite, which projects into the cavity of the test.

The condition of the stone canal in the *Spatangoida* deserves further investigation, since the observations hitherto recorded contradict one another. According to one account, the stone canal (in *Echinocardium*) breaks up into branches on its way to the water vascular ring, these branches communicating with the axial blood lacunar system. According to another, it ends blindly (in *Spatangus purpurcus*), and the water vascular ring is said in no way to communicate openly with the apical stone canal. A canal, however, runs from the water vascular ring towards the stone canal, without reaching it. The existence of any kind of communication with the lacunar system is emphatically denied by those who hold this latter view.

3. **Asteroidea.** — In all Asteroids the madreporite is external, and takes the form of a skeletal plate, which is perforated by many pores, and always lies on the apical side of the disc interradially. The stone canal, within the axial sinus and attached by a band to its wall, descends direct to the water vascular ring which surrounds the œsophagus, and enters this ring interradially. The wall of the stone canal is generally highly calcified, and its lumen is divided in a more or less complicated manner into shelves, niches, etc., by projecting folds which frequently branch. It not infrequently happens in Asteroids that there is more than one stone canal and madreporic plate. For example, all Asteroids which reproduce asexually (*i.e.* by division) possess more than one canal.

The relations of the madreporite to the axial sinus are interesting. Not all the pores of the madreporic plate open into the stone canal;

some of them open direct into the axial sinus. No direct communication between the stone canal and the axial sinus is found in adult animals.

The madreporite appears externally marked by furrows radiating from the centre to the periphery (Fig. 359). In the bases of these furrows lie the apertures of the pores. The pore canals, which run through the substance of the madreporite to the stone canal, anastomose in definite ways, which cannot here be described.

The increase of surface of the inner wall of the stone canal (Fig. 360) is of some interest. As the middle layer of connective tissue takes part in the formation of the folds projecting into the lumen, these folds may calcify. The simplest condition is found in the *Echinasteridae* and *Asterias tenuispina*, where a projecting longitudinal ridge is formed on the inner wall of the stone canal (Fig. 360, A). In *Asterina* the free edge of this fold splits up into two diverging lamellæ, in such a way that the transverse section is Y- or anchor-shaped (B). The lamellæ may become coiled (species of *Asterias*, *Pentaceros*, *Hymnasteria*, C). Occasionally the ridge traverses the whole lumen of the canal as a septum (D), and then carries on each surface a coiled lamella (species of *Astropecten*). The whole lumen, further, may be traversed by septa which, in transverse section, form a network (*Luidia*, *Culcita*, species of *Astropecten* and *Ophidiaster*, F).



FIG. 359.—A quarter of the madreporic plate of *Asteracanthion rubens* (after Ludwig).

Number of the stone canals and madreporitic plates.—Several madreporites and stone canals (two to five and more) are not infrequently found in individuals

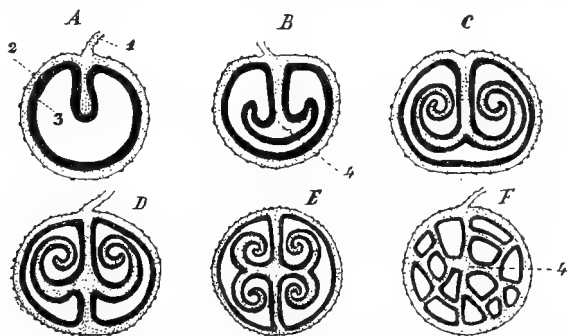

FIG. 360.—A-F, Transverse sections through the stone canal of various Asteroids. 1, Suspensor of the stone canal to the wall of the axial sinus; 2, endothelium of the axial sinus; 3, inner epithelium of the stone canal; 4, connective tissue portion of the wall.

with six, seven, or more arms, belonging to species which normally have five arms. There are, however, some species (having normally five or more arms) which habitually possess more than one madreporite (*Asterias capensis*, *A. polyplax*, *Ophidiaster Germani*, *Acanthaster echinites* and *A. Ellisii*). On the other hand, the species of the genera *Solaster*, *Heliaster*, and *Luidia*, which normally have numerous arms, possess only one madreporite. When more than one madreporite is present they lie, as a rule, in different interradii. Cases have, however, been observed in which two stone canals occurred in one and the same interradius, and even in one and the same axial sinus.

4. **Ophiuroidea.**—In this class, as a rule, one single madreporite with one pore aperture and a single stone canal are present. The pore aperture is not found, as in *Asteroids* and *Echinoids*, on the apical side of the body, but, in adult Ophiuroidea, on the oral side of the disc, asymmetrically in an interbranchial area, and on that edge of the oral shield which is turned to the bursal aperture. This oral shield thus becomes the madreporic plate. The pore aperture leads first into an ampulla (Fig. 361, 3), which probably corresponds with the axial sinus of the *Asteroides* and *Echinoides*. Into this ampulla the stone canal which descends from the water vascular ring opens.

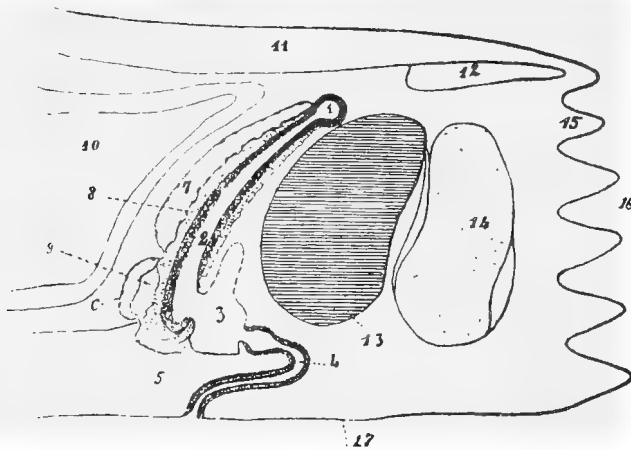

FIG. 361. — Stone canal and neighbouring parts of *Amphiura squamata*, diagrammatic vertical section through the madreporic interradius of the disc. 1, Water vascular ring; 2, stone canal; 3, ampulla; 4, madreporic canal; 5 and 7, axial sinus (?); 6, circular genital sinus; 8, axial organ; 9, genital rhachis; 10, bursal pouch; 11, oral wall of the intestine; 12, peristomal sinus; 13, interradian muscle; 14, circular nerve; 15, teeth; 16, mouth; 17, oral surface of the disc.

A large part of the ampulla lies on that side of the stone canal which is turned towards the mouth. In consequence of the position of the pore aperture, the stone canal, which rises out of the water vascular ring interradianly, runs in a downward (oral) direction.

The diagram (Fig. 361) illustrates in detail (1) the relation of the stone canal to the axial sinus; (2) the manner in which the former enters the madreporic ampulla, the cylindrical epithelium of the former being directly continued into the tessellated epithelium of the latter; (3) the opening outward of the ampulla through a madreporic canal.

It appears that in many species of the genera *Amphiura*, *Ophiolepis*, *Ophioplocus*, *Ophionereis*, and *Ophiocnida*, several or many pore apertures occur at the edge of the oral shield. This is certainly the case in many *Astrophytidae*. In *Trichaster*, however, only one pore aperture is present; but this and the stone canal belonging to it are repeated in each interradius.

In *Ophiactis virens* also, which reproduces itself asexually by division, several (as many as five) stone canals occur in the adult in different interradial areas. In young individuals only one is found.

5. **Crinoidea.**—Adult Crinoids have at least five, and usually many more or even very numerous stone canals, all of which open into the body cavity. Communication between the exterior and the body cavity is brought about by at least five ciliated pores (Kelch-poren) in the tegmen calycis; their number is generally far greater, and may mount up to a thousand. Each single pore corresponds with a madreporite with one pore canal. We must not therefore compare the calyx pores of a Crinoid collectively with the numerous pores of a madreporic plate. Originally, the number of pores on the calyx no doubt agreed with the number of stone canals. In cases in which both structures are very numerous, however, no such relation can be established.

In many inadunate Crinoids (*cf.* p. 303) a madreporite occurs in the posterior interradius of the tegmen.

Rhizocrinus lofotensis and *Actinocrinus verneuilianus* have only five interradiial stone canals and five interradiial pores in the calyx. The openings of the stone canals into the body cavity lie directly below the pores belonging to them.

For the number and arrangement of the calyx pores, *cf.* the section on the Tegmen Calycis of the Crinoids, p. 377.

B. The Water Vascular Ring and its Appendages.

1. **Holothurioidea.**—The water vascular ring always encircles the cesophagus behind (*i.e.* apically to) the calcareous ring. In all Holothurioidea without exception it carries **Polian vesicles**. As a rule, **only one** Polian vesicle is present.

These pear-shaped or tubular cæca of the water vascular ring, which project freely backward into the body cavity, vary greatly in size. In extreme cases they may be half as long as the body.

In the *Molpadiidæ*, and among the *Elasipoda* in the *Psychropotidæ* and *Deimatidæ*, more than one vesicle has never yet been observed, and, in the *Elpadiidæ*, there is, normally, only one. In other divisions, a varying number of species, greatest in the *Synaptidæ*, have more than one Polian vesicle. In all such species, however, there was *originally* only one vesicle. Where accessory vesicles occur they vary greatly in number, and appear to have very slight, if any, systematic significance.

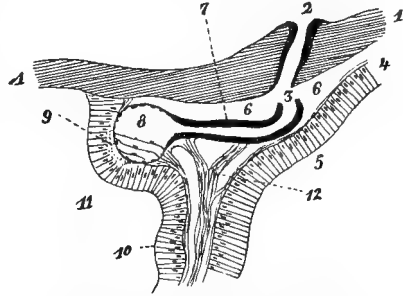

FIG. 302.—A stone canal and pore of the calyx of *Rhizocrinus lofotensis*, diagrammatic (after Ludwig). Interradiial section in the neighbourhood of the mouth. 1, Tegmen calycis; 2, calyx pore; 3, aperture of the stone canal into the body cavity; 4, intestinal epithelium; 5, intestinal cavity; 6, cœlum; 7, stone canal; 8, ring canal; 9, circular nerve; 10, cesophageal epithelium; 11, cesophagus; 12, connective tissue.

Where only one Polian vesicle occurs, it lies in the left ventral interradius, very seldom in the left dorsal interradius.

Where two or more vesicles occur, they are also mostly found in the ventral region of the circular canal.

The walls of the Polian vesicles correspond in structure, essentially, with those of the ring canal. Cells belonging to the inner epithelium become amœboid and break away from the wall. These are said to become the lymph cells of the water vascular system.

2. **Echinoidea.**—In the *Spatangoida* (which have no masticatory apparatus) the ring canal encircles the œsophagus immediately above the mouth. In other Echinoidea, however, it is pushed up by the masticatory apparatus which intervenes between it and the mouth. The canal therefore surrounds the œsophagus at the point where this latter emerges from the lantern. The ring canal, as well as its accessory structures, nevertheless, lie within the lantern membrane, which envelops the whole masticatory apparatus. The circular vessel (the lacunar ring) is in close contact with the canal (Fig. 358).

In the *Spatangoida* and some *Clypeastridae* (*Echinoecyamus pusillus*), the ring canal has no accessory structures. In the *Stereosomata*, on the contrary, it has, in each interradius, a small outgrowth, which ramifies and intertwines with similar ramifications of the circular blood vessel to form together a spongy body, which is known as the Polian vesicle, and is regarded as a lymph gland. This, which, in the *Stereosomata*, is confined to certain localised interradiial points, occurs in the *Cidaroida*, certain *Clypeastroidea* (e.g. *Peronella orbicularis*), and the *Streptosomata*, along the whole course of the canal, so that the intertwining of the appendages of the ring canal and of the circular blood vessel gives rise to a spongy ring.

An intermediate stage is found in *Echinodiscus biforis* (*Clypeastroidea*), in which the interradiial spongy bodies of the circular canal are longer than in the *Stereosomata*, but long radially arranged tracts are still left free, the canal at these parts retaining its simple lumen.

3. **Asteroidea.**—The circular canal which surrounds the mouth, following the inner outline of the oral skeleton, here has two kinds of appendages: **Tiedemann's bodies** and the **Polian vesicles**, both of which lie interradially. Tiedemann's bodies appear to occur in all Asteroids, whereas the Polian vesicles are wanting in some families, e.g. the *Asteriidae*, *Echinasteridae*, and *Linckiaidae*.

Tiedemann's bodies (Fig. 363, 7) are small tufts of tubules, closely crowded together, their walls of connective tissue being fused with one another. These tubules, which open into the circular canal, are lined internally with a cubical epithelium, and contain within their lumen bundles of cells which have broken away from the wall. These cells, the protoplasm of which contains pigmented concretions, become the amœboid lymph cells which float in the fluid of the water vascular system. They give the Tiedemann's bodies their more or less distinct coloration.

Two Tiedemann's bodies usually occur in each interradius; the interradius containing the stone canal not infrequently, however, forms an exception to this rule, only one such vesicle being present in it (*Asteriidae*, *Echinasteridae*, *Linckiiidae*, *Asterinidae*, *Culcitidae*). If the circular canal is viewed internally in the position shown in Fig. 363, this body lies to the right of the stone canal.

The **Polian vesicles** (Fig. 363, 6) are large structures with long stalks, and to them, as to Tiedemann's bodies, the function of lymph glands has been attributed. In the *Asterinidae*, *Culcitidae*, *Luidia*, and several species of *Astropecten*, one

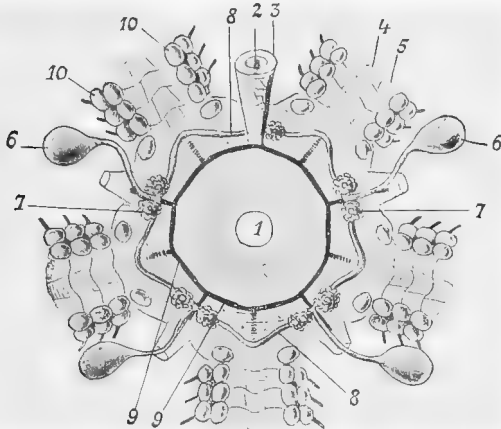

FIG. 363.—Circular canal, Polian vesicles, Tiedemann's bodies, and ampullæ of the water vascular system of *Asterina gibbosa* (after Cuénot). Seen from within, i.e. from the body cavity. 1, Mouth at the centre of the oral membrane; 2, stone canal; 3, axial sinus; 4, transverse muscles of the ambulacral plates; 5, ambulacral plates; 6, Polian vesicles; 7, Tiedemann's bodies; 8, circular canal; 9, blood vascular ring (?); 10, ampullæ.

vesicle is found in each interradius. Only in the interradius containing the stone canal is it wanting, or else (in species of *Astropecten*) two are here found instead of one. *Astropecten aurantiacus* has two to four (usually three) Polian vesicles in each interradius (even in the stone canal interradius). The wall of this vesicle, proceeding from without inwards, consists of: (1) the ciliated endothelial covering; (2) a layer of connective tissue in which run the longitudinal muscle fibres; (3) a circular muscle layer, and (4) the inner epithelium, whose cells lie in the interstices of a network of connective tissue.

4. **Ophiuroidea.**—The water vascular ring here possesses one Polian vesicle, which functions as lymph gland in each interradius except that of the stone canal. The structure of the wall of this vesicle resembles that in the *Asteroidea*, the longitudinal musculature, however, seems always, and the circular musculature frequently, to be wanting. The canals to the first two tube-feet arise directly from the circular canal, commencing usually as a common canal which forks later, but occasionally the canals are distinct from the first.

Ophiactis virens (Fig. 364) occupies an exceptional position among the Ophiuroidea, being capable of asexual reproduction by means of fission. This form not only has, as already mentioned, several stone canals, but in each interradius two to three

Polian vesicles and, besides (an altogether unique condition), six to fifteen long thin accessory vessels in each interradius, which are hollow and end blindly; these encircle the intestine and in sexually mature animals penetrate between the genital organs. The walls of these vessels, which are filled with blood and lymph corpuscles, and communicate with the circular canal, consist, from without inwards of: (1) the

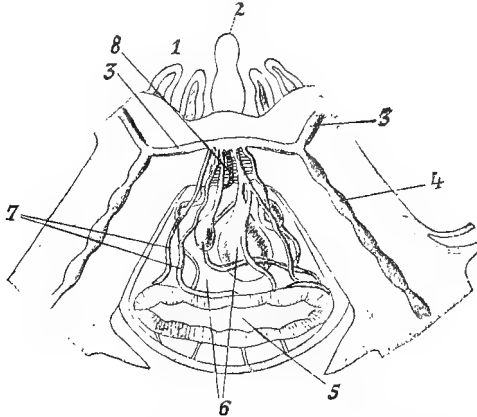

FIG. 364.—A portion of the disc of *Ophiactis virens* in horizontal section, somewhat diagrammatic (after Cuénot). 1, Oral tentacles; 2, tooth; 3, circular canal; 5, section of the stomachal sac; 6, Polian vesicles; 7, accessory vessels of the circular canal; 8, stone canal.

endothelium of the body cavity; (2) a thin layer of connective tissue; (3) the inner epithelium. This altogether peculiar development of the water vascular system in *Ophiactis virens* is considered to be connected with the absence of bursæ which serve for respiration, *Ophiactis* standing alone among the Ophiuroidea in having no such structures. This peculiar development of the water vascular system is said to be a supplementary means of respiration.

5. **Crinoidea.**—The circular canal which surrounds the mouth has here no accessory structures except the stone canals. It is provided with longitudinal muscle fibres, which are connected with the epithelial cells (epithelial muscle cells). As in the radial canals, muscle cells also occur transversely traversing the lumen of the canal. The circular canal gives off canals direct to the five groups of tentacles which surround the mouth.

C. The Radial Canals, the Canals of the Tentacles and Tube-feet; the Tentacle and Tube-feet Ampullæ.

1. **Holothurioidea.**—The Holothurioidea fall into two very distinct groups, the *Synaptidæ* being distinguished from all other members of the class by the fact that, in adults, neither tube-feet, tube-feet canals, ampullæ, nor any traces of radial vessels are found. The *Synaptidæ* (*Paraactinopoda*) have only oral

tentacles and tentacle canals, the latter springing directly out of the circular canal.

The arrangement in all other Holothurioidea (*Actinopoda*) may be described as follows. There are five radial canals, and never more. The tentacle canals never spring directly from the circular canal, but arise out of the radial canals. The tentacles are to be regarded as the first (modified) tube-feet, and the tentacle canals as the first tube-feet canals.

The canals of the tube-feet and tentacles are usually connected with ampullæ.

Actinopoda (Fig. 365).—From the circular canal the radial canals run forward (anteriorly) along the œsophagus towards the mouth, passing the axial surface of the calcareous ring (*i.e.* between it and the œsophagus). They then pass, together with the radial nerves on whose inner side they lie, through the incisions or apertures belonging to them in the ring, and run backwards (aborally) in the body wall, outside the circular musculature, and end blindly near the anus.

In some rare cases, where the ventral surface is sharply distinguished from the dorsal, and the dorsal ambulacral appendages, *i.e.* those of the bivium, have entirely disappeared, the corresponding dorsal radial canals are said also to be wanting. In a few isolated forms the central radial canal of the ventral side (*i.e.* of the trivium) is also said to be wanting.

The **tentacle canals** branch off from their radial canals just above the calcareous ring. Their number corresponds with that of the tentacles to which they run. These canals are often connected, at the anterior edge of the ring, with **tentacle ampullæ** (Fig. 365, 18). These latter are tubular outgrowths, which vary greatly in size, stretching back over the outer surface of the calcareous ring, and for the most part projecting freely into the body cavity. Where such ampullæ occur, all the canals without exception are provided with them. They are entirely wanting in the families of the *Elasipoda* and *Dendrochirota*, but occur normally in the *Synaptidae*, *Molpadiidæ*, and *Aspidochirota*. In *Pelagothuria*, branches run through the peculiar swimming disc (*cf.* p. 286), radially, and reach even to the tips of its processes. They are evidently to be regarded as modified tentacle ampullæ.

The **canals of the tube-feet** branch off alternately from the radial canals. As a rule, a separate canal runs from the radial canal to each foot; but in some cases (*Holothuria tubulosa*) one canal, by branching, runs to several (4-6) tube-feet. In the *Molpadiidæ*, and the above-named Holothurian, it is said that there are tube-feet canals which end blindly, and thus have no tube-feet answering to them. Except in the footless *Molpadiidæ* and the *Psychropotidæ*, the tube-feet canals are connected with egg-shaped, often somewhat long and occasionally branched ampullæ. These either lie as **covered ampullæ** outside of the circular musculature of the body wall or, as **free ampullæ**, press in between the transverse musculature into the body cavity.

At the point where the ampulla opens into the tube-foot canal, but in that part of the latter which comes from the radial canal, there is a **valve**, similar to that found in *Asteroids*, which will be described later. This valve is arranged in such a way as to prevent the return of the fluid into the radial vessel, either from the foot or from the ampullæ. Valves are also found in the tentacle canals.

The walls of the ampullæ resemble those of the Polian vesicles in structure. The radial canals and their branches are chiefly distinguished by the fact that the longitudinal musculature is only developed in the outer part of the walls.

Paractinopoda.—The tentacle canals here spring directly out of the circular canal, and nearly always agree in number with the tentacles. At the level of the

calcareous ring, in each tentacle canal a muscular membrane forms a semilunar valve which projects from the wall with its concave side directed forwards (orally).

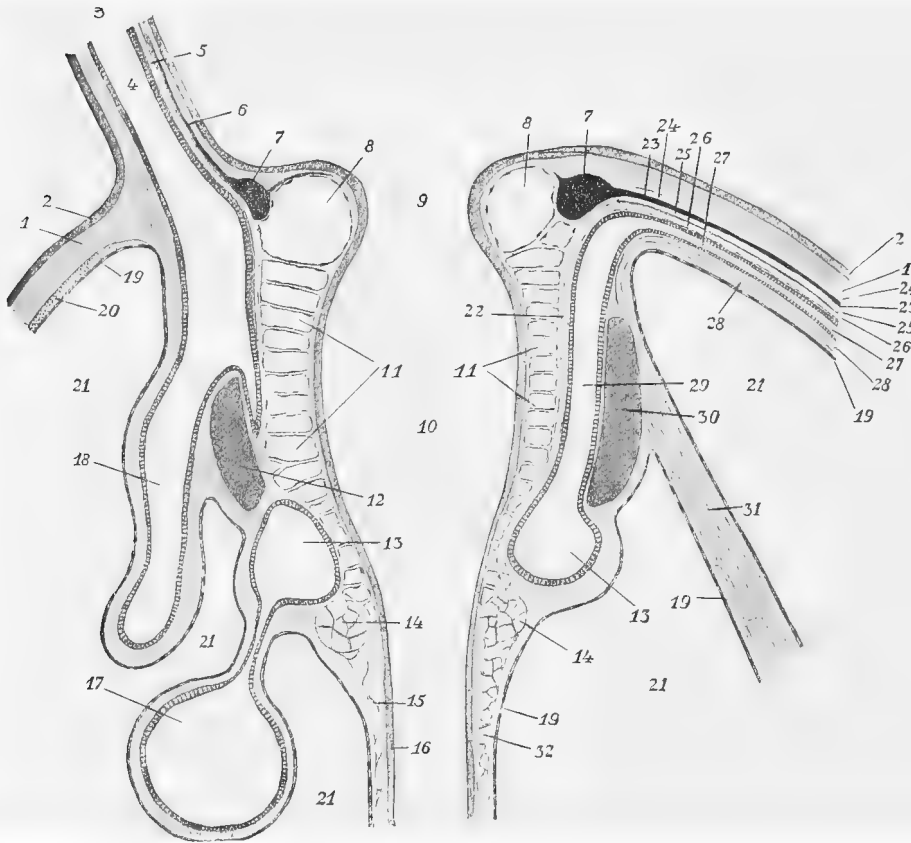

FIG. 365.—Section through the oral region of an Actinopod, in the direction of the principal (longitudinal) axis. On the right, the plane of the section is radial; on the left, almost interradial. 1, Cutis; 2, body epithelium; 3, oral tentacle, cut off; 4, water canal of the oral tentacle; 5, blood vessel of the oral tentacle; 6, tentacle nerve; 7, circular nerve; 8, oral portion of the coelomatic periesophageal sinus; 9, mouth; 10, oesophagus; 11, periesophageal sinus; 12, interradial portion of the calcareous ring; 13, water vascular ring; 14, blood vascular ring; 15, ventral intestinal vessel; 16, intestinal epithelium; 17, Polian vesicle; 18, ampulla of the oral tentacle; 19, endothelium of the body cavity; 20, circular musculature of the body wall; 21, body cavity; 22 and 26, radial blood vessels; 23, radial nerve trunk of the superficial system; 24, radial epineural canal; 25, radial perihæmal canal; 27, radial canal of the water vascular system; 28, longitudinal muscles; 29, commencement of the radial canal of the water vascular system; 30, radial portion of the calcareous ring; 31, retractor muscle; 32, dorsal intestinal vessel.

This valve prevents the water vascular fluid flowing back out of the tentacles into the circular canal.

The wall of the tentacle canals consists, from without inwards, of: (1) the endothelium of the body cavity; (2) a longitudinal muscle layer; (3) a layer of connective tissue; (4) a circular muscle layer; (5) an inner epithelium.

2. **Echinoidea** (Fig. 358, p. 419).—In the Spatangoida, where a masticatory apparatus is wanting, the radial canals, on leaving the circular canal which surrounds the mouth, are already in their respective radii, and commence at once to send out branches right and left to the tube-feet. In other Echinoidea, however, the radial canals have to descend from the circular canal which encircles the œsophagus above the lantern to the peristome, and thus, after rising out of the circular canal, have first to run **under the intermediate plates** and over the intermaxillary musculature. They emerge at the periphery of the lantern and then descend on its **outer side, i.e. outside the intermaxillary musculature** to the peristome. Having reached this latter, they first give off a branch which runs in the oral region towards the mouth. They then **pass through the auriculæ**, in order to run up radially towards the apex, on the inner side of the test, and in the middle lines of the ambulacra. They end blindly in the pores of the radial plates of the apical system.

While running up on the inner side of the test, the radial canals give off alternating lateral branches, each of which enters an ampulla (*cf.* Fig. 353, p. 410). The ampulla, which projects into the body cavity, is itself connected, by means of one or two canals, with the cavity of a tube-foot or tentacle, which latter projects freely on the outer side of the test. The ambulacral plate at such a point is perforated by either a single or a double pore, according as the canal to the tube-foot is single or double (*cf.* the section on the Skeletal System).

In all Echinoidea, the tube-feet in young animals are all alike, and each is connected with its ampulla by a single pore through the test. This may be considered to be the primitive arrangement. Tube-feet with single pores are found in adults in a few *Spatangoida*: in the *Pourtalesiidæ*, in the Ananchytidan genera *Urechinus*, *Cystechinus*, *Calymne*, in the Spatangoid genus *Palæotropus* and the Cassidulid genus *Neolampas*.

In all other Echinoids, the tube-feet or tentacles have double pores. In the regular Echinoids (*Cidaroida*, *Diadematoïda*), only double pores are found: but in the *Clypeastroïda* and the *Spatangoida*, only the pores of the petaloids are double: those on the remaining ambulacral regions being single.

The ampullæ are delicate structures which vary in shape. In cases in which they, like the tentacles to which they belong, stand at some distance from one another, they are pear-shaped or spherical; but where they, like the tube-feet, stand in compact rows in the ambulacral meridians, as in the regular Echinoids and in the petaloids of the irregular forms, they are lengthened out horizontally and flattened vertically (dorso-ventrally). The walls of the ampullæ, from without inwards, consist of: (1) a ciliated endothelium; (2) a layer of connective tissue, containing occasional embedded calcareous corpuscles; (3) a circular muscle layer; (4) an inner ciliated epithelium. The lumen is traversed from wall to wall by fibres, which are probably muscular. In several Echinoids, at the points where the lateral canals of the radial canals open into the ampullæ, valves have been observed.

The branches of the radial canal which run in the oral integument supply the tube-feet or tentacles occurring in this region.

3. **Asteroïdea**.—The radial canals, in this class, run along the

bases of the ambulacral furrows of the arms, outside the ambulacral plates. At the tips of the arms they end blindly in the terminal ocular tentacles. In their courses, consecutive widenings and narrowings are not infrequently found, these correspond with the segmentation of the arm, but are never very marked. Each radial canal gives off—at regular intervals, which correspond with the skeletal segments, and at opposite points to right and left—**canals to the tube-feet**. At the point where such a canal opens into the tube-foot, a second canal, the **ampulla canal**, branches off from it. This canal rises up between two consecutive ambulacral plates to widen out above these latter into an **ampulla** which projects freely into the body cavity (Fig. 354, p. 411).

This ampulla is single in all young Asteroids and many adults (*Linckiidæ*, *Echinasteridæ*, *Asteriidæ*, *Luidiæ*). In other Asteroids (*Astropectinidæ* excluding *Luidia*, *Asterinidæ*, *Pentacerotidæ*, e.g. *Culeita*) two separate ampullæ occur to each tube-foot in the adult.

Valves are found at the points where the canals of the tube-feet open into the radial canal. A muscular membrane, resembling a truncated cone with the base attached horizontally round the wall of the canal, projects into the lumen directed towards the foot. This valve prevents the fluid pressed out of the ampulla from returning into the radial canal, either because the membrane is able by muscular action to close the aperture, or because the pocket surrounding this projecting membrane is swelled up by pressure of water from the foot or ampulla, and so closes the valve.

4. **Ophiuroidea**.—The first point to be noted with regard to the Ophiuroidea is that they have no tube-feet ampullæ.

The radial trunks of the water vascular system run in the arms between the ventral shields and the vertebral ossicles. At the tip of the arm each trunk ends in a small terminal tentacle. Regularly consecutive and distinct widenings are found in their courses corresponding with the regular segmentation of the arms. Between every two of these consecutive widenings, the radial canal is provided with a single layer of band-like circular muscle fibres. A narrow tube-foot canal runs off to right and left from each widening, running either straight into its tentacle or first forming a V-shaped loop, which ascends apically into the calcareous mass of the vertebral ossicle. At the point where the tentacle canal enters the tentacle, the lumen of the former becomes much widened, and a valve occurs (similar to that described in the *Asteroids*), which prevents a flowing back of the water vascular fluid out of the tube-foot into the radial canal.

The first two pairs of canals to the tube-feet or tentacles (the so-called oral tentacles) come direct from the circular canal.

5. **Crinoidea**.—**Tentacle ampullæ are wanting**. The radial canals lie close under the food grooves of the disc, of the arms, and of the pinnulæ, whose courses they exactly follow, so that they branch just

as often as do the arms and their food grooves. Their course is more or less markedly zigzag, and they give off at the angles thus formed (*i.e.* alternately) lateral **tentacle canals**. Each of these latter runs to a group of three small tentacles at the edge of the food groove, and here divides into three canals, which enter the three tentacles and form their cavities.

Tentacle canals are wanting in all cases where food grooves are wanting, which is the case in *Actinometra* over a great part of the arms, and in some species of *Antedon* in certain proximal pinnulæ of the arms.

All authors agree in maintaining that the inner epithelium of the water vascular system in the Crinoids differs from that in all other Echinoderms in not being ciliated. A band of longitudinal muscle fibres runs in the wall of the canals along the side turned to the food groove. The lumen of the canals is at certain points (*i.e.* where the tentacle canals branch, or at the commencement of these canals) traversed by muscular fibres. This arrangement perhaps fulfils the function of the valves found in other Echinoderms.

D. The Ambulacral Appendages.

(Tube-feet, Tentacles, Feelers, Ambulacral Papillæ, etc.)

1. **Holothurioidea**.—The following facts require first of all to be emphasised.

a. In all Holothurioidea, a smaller or greater number of ambulacral appendages (10-30) are developed as **tentacles** near the mouth.

b. The *Synaptidæ* and *Molpadidæ* have no ambulacral appendages except these tentacles.

c. In all other Holothurioidea besides the tentacles there are **tube-feet** (and **papillæ**) varying greatly in number (often very numerous), in structure, and in arrangement.

d. These tube-feet (and papillæ) are found either only on the radii, one or two or more longitudinal rows being arranged in each radius, or else they are distributed, usually in an irregular manner, over some or all of the interradii. The arrangement of the tube-feet is not of great systematic importance, since even within one and the same genus (*e.g.* *Cucumaria*), all the intermediate stages between a strictly radial and an altogether scattered arrangement can be observed.

e. Where the ventral and the dorsal surfaces are distinctly differentiated, the ambulacral appendages are developed on the ventral side (in the trivium), normally as **locomotory tube-feet** with sucking discs supported by **perforated plates**: on the dorsal side, on the other hand, they take the form of conical non-locomotory **papillæ**, which have either a rudimentary perforated plate at the narrow tips or none at all.

No very sharp distinction between tube-feet and papillæ is, however, possible, either with regard to their distribution, their form, or their structure.

With regard to the number of the tentacles, the following numbers seem to prevail in the different families: 20 in the *Aspidochirota*, 20 in the sub-family *Decimatidæ* of the *Elasipoda*, 15 in the *Molpadiidæ*, 13-16 in the *Pelagothuridæ*, 12 in the *Synaptidæ*, and 10 in the *Dendrochirota* and in the sub-family *Elpidiidæ* of the *Elasipoda*.

With regard to form: the tentacles are **feathered** (*Molpadiidæ Synaptidæ*, Fig. 229, p. 288), **dendriiform** (*Dendrochirota*, Fig. 226, p. 287), and **shield-shaped** (*Aspidochirota*, *Elasipoda*). In the latter, the disc or shield, the edge of which may be more or less deeply indented, is carried by a stalk.

The size of the tentacles has already been sufficiently indicated in the systematic review.

The relation between the arrangement and size of the tentacles on the one hand and the symmetry of the rest of the body on the other is interesting. In the *Dendrochirota* (cf. Fig. 226, p. 287), of the ten tentacles, the **two ventral** are almost always distinguished by being much smaller than the rest.

In many species of *Myriotrochus*, *Synapta*, and *Chirodota* with twelve tentacles, these are distributed symmetrically as follows: three occur in each of the two dorsal interradii, and two in each of the three ventral interradii.

The tentacles may be swelled and extended; and on the other hand they can be withdrawn into the body cavity together with the surrounding anterior part of the body, although not invaginated like the tentacles of a Gastropod.

2. **Echinoidea**.—Ambulacral feet are developed in all Echinoids without exception. In early youth, they are always found to resemble one another, and in both the *Echinidæ* and the *Pourtalesiidæ* this is still the case in adults, the former having tube-feet with terminal sucking discs and the latter tube-feet with rounded ends. In most Echinoidea, on the contrary, more or less marked **polymorphism** occurs, division of labour taking place between the ambulacral appendages of one and the same individual.

This polymorphism is not very striking in the regular Echinoidea, e.g. the *Cidaroida*, *Echinothuridæ*, *Diadematiidæ*, *Arbaciidæ*, *Echinometridæ*, etc. In these, the ambulacral appendages appear, as a rule, in three different forms: (1) as **locomotory tube-feet** with terminal or sucking discs; (2) as **tactile** or **branchial tentacles** without terminal sucker; and (3) as **oral** or **sensory feet** with bi-lobate terminal disc.

All these tube-feet are connected by means of double pores with their ampullæ, which lie within the test. Without detriment to their principal function, they may all act as respiratory organs, since the presence of the double pore allows of a circulation of the ambulacral fluid between the inner ampulla and the outer ambulacral foot; the fluid in the foot takes in oxygen, carries it back into the ampulla, and gives it off through the wall of the ampulla to the fluid in the body cavity.

The **locomotory tube-feet** are found on the oral hemisphere of the body, but may also occasionally occur on the apical hemisphere as well.

The **tactile** or **branchial tentacles** are limited to the apical hemisphere. They are specially suited for respiratory purposes when the ampullæ are large, and have thin and delicate walls containing no calcareous corpuscles.

The **oral tube-feet** (always ten in number?) surround the mouth, and especially when food is being taken in, are subject to active swinging or pulsating movements, without, however, touching the food. They have been regarded as olfactory or gustatory organs. They seem to be wanting in the *Cidaroida* and the *Echinothuridae*; on the other hand they occur in those *Echinidae* which otherwise possess only one sort of tube-feet, viz. those with sucking discs.

The polymorphism of the ambulacral appendages is much more marked in the *Clypeastroidea* and the *Spatangoida*. It must first be noted that the ambulacral appendages, in those apical regions of the ambulacra which are known as petaloids (*cf.* p. 347), serve for respiration (**ambulacral gills**). They seem to be peculiarly fitted for this activity by the delicacy of their walls, the want of calcareous corpuscles, the increase of surface obtained by **branching**, the possession of double pores (whereas the ambulacral appendages in other parts of the body have single pores) and by the size of their ampullæ.

In the *Clypeastroidea*, besides the ambulacral gills of the petaloids, three kinds of appendages have been observed: (1) the ordinary slender tube-feet, with rounded terminal knobs, scattered on the test; (2) sessile knobs, with deep sensory

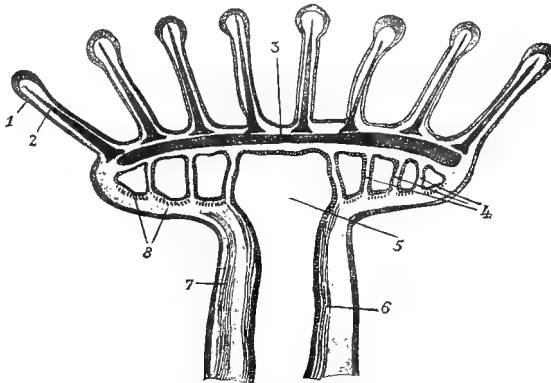

FIG. 366.—Longitudinal section through an ambulacral brush of a Spatangoid (after Lovén and Hamann). 1, Body epithelium; 2, supporting rod; 3, supporting plate of the terminal disc; 4, septa; 5, canal of the water vascular system; 6, longitudinal muscles; 7, nerve; 8, circular muscle fibres.

epithelium (sensory tentacles); (3) short, thick tube-feet with truncated ends: these occur between the ordinary feet on the oral side, and are perhaps locomotory.

Among the *Spatangoida*, the polymorphism of the ambulacral appendages is very marked in all the divisions except in the *Echinoneidae*; it reaches its highest point in the families of the *Spatangidae* and *Apetala*.

The **ambulacral gills** of the four paired petaloids have been described above. We note first the characteristic **ambulacral brushes** which occur in the *Spatangoida* more or less near the mouth and the anus, and in the *Cassiduloida* on the **phylloides** (*cf.* p. 347). The terminal plate or disc of an ordinary tube-foot (Fig. 366) is here extraordinarily widened, and carries a number (usually large) of club-shaped or conical, solid appendages, each of which is supported by a calcareous rod. These ambulacral brushes are said to play an important part in the taking in of food by

stirring up the sand. On other parts of the ambulacra, slender tentacles without prehensile discs occur, to which a tactile function has been ascribed. Still more interesting are the **ambulacral appendages of the anterior unpaired ambulacrum**, which are certainly to a still higher degree tactile organs. These vary in shape; in all young *Spatangoida* and many adults they are distinguished by their remarkable size, and help to emphasise the bilateral symmetry of the whole body. In *Spatangus* and other genera they end in a flat disc, the edge of which is drawn out into short, solid, knobbed processes, which are supported by calcareous rods. The whole terminal disc thus looks like a beautiful rosette.

As compared with the ordinary tube-feet, truly gigantic proportions are attained in the genera *Acoste* and *Erope* by the ambulacral appendages, which lie in the depressed anterior ambulacrum within the peripetaloid fasciole. They are found only in small numbers, yet in their contracted condition they almost completely fill the depression from whose base they rise. Their ends are provided with large discs.

Turning to the **finer structure** of the ambulacral appendages of the Echinoidea, their wall is found to consist of the typical layers. In the locomotory tube-feet of the regular Echinoids, the inner layer of the connective tissue is specially modified as an elastic membrane, with circular fibres. Calcareous corpuscles are wanting only in the respiratory tentacles of the apical surface of the body. In all other parts of the body they are found in great numbers in the stalk, while in the terminal discs of the tube-feet they take the form of delicate, circular, terminal plates usually composed of several pieces. The whole surface of the tentacles, except that of the terminal discs, is ciliated. A nerve enters each tube-foot, running in the epithelium until near the tip, where it forms a lateral ganglion, which can be externally recognised as a swelling. From this ganglion, the terminal apparatus of the tube-foot is innervated. In tube-feet with terminal discs, the epithelium at the edge of the disc is differentiated as a deep **sensory epithelium**, and within it runs a basal nerve ring, connected with the lateral ganglion by two nerves. Where the tentacles end in knobs (tactile tentacles and sessile knobs of the *Clypeastroidea*) or carry knobbed processes on their terminal discs (ambulacral brushes, rosette-like tube-feet of the anterior unpaired ambulacrum of the *Spatangoida*), these knobs are caused by the great thickening of the sensory epithelium. In the ambulacral gills of the *Clypeastroidea* (*Echinocyamus*, *Echinodiscus*) the epithelium occasionally thickens to form **sensory papillæ**. The sensory epithelia appear everywhere to carry stiff sensory setæ or hairs.

The lumen of the tube-feet at its central and basal parts is not infrequently traversed by transverse muscle fibres; occasionally it appears to be double—a septum consisting of transverse bands continues for some distance into the tube-foot, the partition in the test between the two apertures of the double pore. The cavity of the large terminal discs of the paint-brush tentacles in the *Spatangoida* is traversed by concentric, much-perforated septa (Fig. 366). The ambulacral gills and their ampullæ are traversed by bands arranged radially around an axis, in such a way that the fluid contained is forced to circulate at the periphery.

3. **Asteroidea.**—The ambulacral appendages always take the form of tube-feet, and stand in two or four longitudinal rows in the ambulacral furrows which run from the mouth to the tips of the arms. It has already been pointed out (p. 353) that the tube-feet, even when apparently present in four rows, in reality belong only to two. That there are only two rows is very clear in young animals. In young Asteroids all the tube-feet are alike; all have conical ends, with rounded tips. This is still the case in many adult Asteroids (*Astro-*

pecten, *Luidia*, etc.), while in very many other genera (e.g. *Asterius*, *Solaster*) a slight difference in shape occurs. Only the tube-feet near the ends of the arms retain the primitive shape, while a well-developed disc is found on all the rest. The former then function chiefly as tactile tentacles.

The wall of the tentacles shows the typical layers. In the tactile tube-feet, the epithelium at the conical end is much thickened, and contains very numerous sensory cells. Within the epithelium, a layer of nerve fibres is developed; these run from the base to the tip of the foot. The layer is specially strongly developed

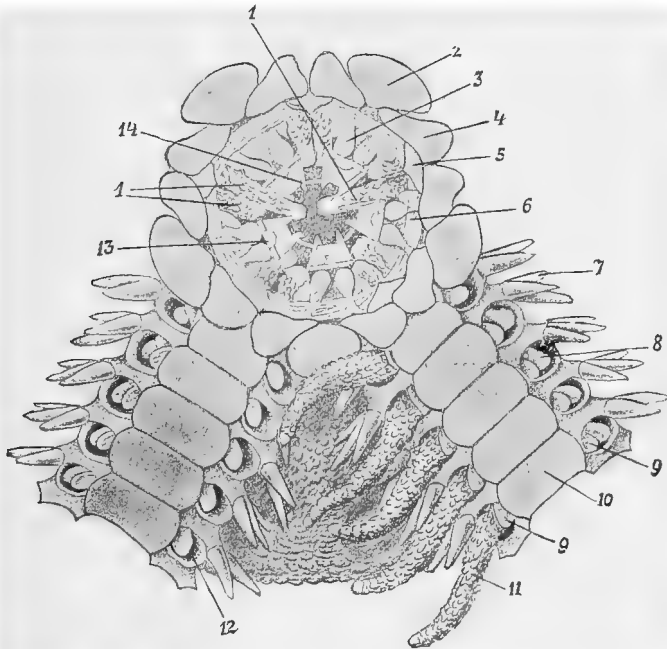

FIG. 367.—Portion of the disc of *Hemiphysalis cordifera*, from the oral side (after Lyman). 1, oral tube-feet; 2, buccal shields; 3, jaw=oral-angle plates; 4, lateral buccal shields; 5, first ventral shield; 6, oral integument, lip; 7, spines on the marginal plates; 8, retracted tentacle; 9, tentacle scale; 10, ventral shields; 11, extended tentacle; 12, tentacle pore; 13, torus angularis; 14, teeth.

within the terminal sensory epithelium. A similar deep sensory epithelium, consisting of sensory, supporting, and glandular cells, also covers the sucking discs of the other tube-foot; these discs have a depression at their centres, while, round their edges the nerve tissue lying within the epithelium becomes thickened into a nerve ring.

From the centre of each sucker, radial muscle fibres run out towards the periphery and are attached round the ambulacral canal which ends below the sucker. These muscles, by their contraction, cause the sucker to adhere. They are entirely distinct from the longitudinal muscles of the appendage, which explains the fact that a tube-foot sticking to an object may be cut off without becoming detached.

This applies almost equally well to the sucking discs of the tube-feet of the *Echinoids*.

4. **Ophiuroidea** (Fig. 367).—In the Ophiuroidea, the ambulacral appendages have no locomotory significance; they resemble tentacles, and never have suckers. Locomotion is caused by the jointed arms themselves. The tentacles are always strictly segmentally arranged, *i.e.* one pair of tentacles occurs on each brachial segment. Each of these emerges through an aperture between the ventral shield and the lateral shield of a segment. The tentacles are not infrequently covered with a large number of sensory papillæ. A nerve, coming from the basal circular ganglion and running in the deeper portion of the layer of connective tissue, traverses the tentacle from base to tip.

It has already been mentioned above that the first ten pairs of tentacles (*i.e.* the first two pairs of each arm) have shifted, as oral tentacles, to a position round the mouth, and receive their canals direct from the circular canal.

5. **Crinoidea**.—The small tentacles which form the ambulacral appendages of this class have already been sufficiently noticed (p. 414). They never possess suckers, and have no locomotory function, but simply serve for respiration, and for conducting food to the mouth.

VII. The Cœlom.

(The Enterocœl, the true or secondary Body Cavity.)

All those cavities of the body which are derived from the **enterocœlomic vesicles** of the larva are considered to belong to the cœlom, which is lined throughout with **endothelium**, usually developed as **ciliated epithelium**. The **cœlomic fluid** exactly resembles in constitution the water vascular fluid already described. The cœlom is, however, except at one single point to be mentioned later, altogether separate from the ambulacral vascular system.

The cœlom is never found as a single cavity, but is always divided into several cavities, which may be entirely distinct one from the other. The largest of these cavities is that which contains the viscera, and which may be termed simply the **body cavity**.

The body cavity is most spacious in the *Echinoidea* and the *Holothurinoidea*; in these forms it occupies almost the whole cavity of the test, or the sac- or tube-shaped body. In the disc of the *Asteroidea* it is somewhat less spacious, and is very limited in that of the *Ophiuroidea*. In the *Crinoidea*, it is traversed by a more or less strongly calcified network of connective tissue.

Where the body is drawn out into arms in the radii, the body cavity runs into these, and forms the **brachial cavities**. The brachial cavities in the *Asteroidea* are very spacious, but are much narrowed in the *Ophiuroidea* and the *Crinoidea*, owing to the great development of skeletal plates (vertebral ossicles, joints) in the arms.

A special section of the cœlom, the **pericœsophageal sinus** (peripharyngeal sinus) encircles the œsophagus or pharynx. In the *Echi-*

noidea, this is quite cut off from the body cavity. The membrane which separates the body cavity from the pericæsoophageal sinus is called, in those *Echinoïds* which are provided with a masticatory framework (*Cidaroida*, *Diadematoïda*, and *Clypeastroïda*), the **lantern membrane**. This membrane entirely covers the lantern on the side turned to the body cavity.

In many *Echinoïds*, this part of the coelom protrudes externally at the edge of the peristome, forming the **outer gills**: in others, the lantern membrane bulges out **into the body cavity**, and forms **Stewart's organs**.

In the *Holothurioidea* and *Echinoidea*, the hind-gut is surrounded by a small coelomic sinus, the **perianal sinus**.

In the *Echinoidea*, *Asteroidea*, and *Ophiuroidea*, a part of the coelom, cut off from the rest, runs from the region of the madreporite interradially to the circular canal of the water vascular system. This is the **axial sinus** in which the stone canal runs. It contains also a **lymph gland**, the so-called **ovoid gland** or **axial organ**.

The axial sinus, in the *Echinoïds*, is in open communication with the **ampulla** which lies beneath the madreporite. Recent ontogenetic researches have shown that this ampulla also is of enterocoelomic origin, and is thus a section of the coelom. Since the stone canal opens into the ampulla, an open communication exists at this point, and at this alone, between a closed division of the coelom (the axial sinus) and a section of the water vascular system (the stone canal).

A. The Body Cavity.

1. **Holothurioidea**.—The spacious body cavity of the Holothurioidea is divided up by the mesentery which attaches the intestine to the body wall. This mesentery may be described as having three parts corresponding with the three sections of the intestine, viz. the **dorsal mesentery**, belonging to the first section of the intestine which runs backward; the **left dorsal mesentery**, belonging to the second section, which bends forward; and the **right ventral mesentery**, belonging to the third section, which runs backward to the cloaca. All three parts of the mesentery lie interradially.

The so-called **ciliated urns** or **funnels** (Fig. 368) are found only in the *Symaptidae*. These are funnel-, cup-, or slipper-shaped organs, each of which is attached to the body wall or the mesentery by a stalk, and hangs down freely into the body cavity. They are specially numerous to the right and left of the dorsal mesentery. In *Chirodota*, many funnels have one common stalk, and so form **trees of ciliated funnels**.

The funnel consists of three layers, an outer endothelial tessellated epithelium, a middle and extremely thin layer of connective tissue, and an inner layer of columnar epithelium, which lines the lumen and carries long cilia. Towards the stalk the lumen is closed, but it is open towards the body cavity.

The vigorous movements of the ciliated urns no doubt serve to promote the streaming and circulation of the fluid in the body cavity.

2. **Echinoidea.**—In the Echinoids, the body cavity is partitioned in a manner similar to that described for the *Holothurioidea*, by mesenteries which follow the intestine in its windings (see p. 480), and attach it to the inner surface of the test. The genital organs are also attached to the test by mesenteries. In regular Echinoids, the mesenteries are much perforated, but are only slightly, if at all, broken through in the *Spatangoidea*.

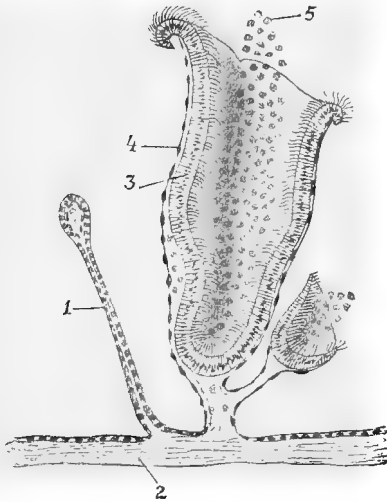

FIG. 368.—Ciliated urns of a *Synaptid* (after Cuénot). 1, mesentery; 2, circular muscle layer of the body wall; 3, ciliated inner epithelium of the urn; 4, endothelium of the body cavity; 5, lymph cells. Near the principal urn, there is a young accessory urn.

In this latter order, where the mesenteries have to carry the heavy intestine, filled with sand, they are specially strong and tough. The coils of the intestine are here also united *inter se* by mesenteries. Special bands attach the intestine to the apical and oral poles of the test, internal processes or apophyses being sometimes developed for the attachment of the bands.

Two such apophyses are found at the apical pole, at the end of the stone canal, and a third not infrequently occurs at the peristome, in an interradius.

The axial sinus, with the axial organ and the stone canal, is attached by bands on the one hand to the apical pole, and on the other to the oesophagus.

For a description of the calcareous pillars, septa, etc., which, in the *Clypeastridae*, traverse the cavity of the test, see p. 405.

In the fluid of the body cavity in Echinoids there are found, besides blood corpuscles, great numbers of spermatozoa-like cells, with long flagella in vigorous movement. These may set up currents in the fluid of the body cavity.

3. **Asteroidea.**—The body cavity of the disc is not spacious, the greater part of it being filled by the large digestive sac. Mesenteries are wanting in the greater part of the intestine, or are only developed as isolated filaments or strands of connective tissue. In the peripheral portion of the disc, radially placed bands or septa traverse the body cavity vertically in the interradii, connecting the dorsal (apical) body wall with the ventral (oral) wall.

The lymph gills, branchial vesicles or papulæ, which are only found in the Asteroids, deserve attention. These are small vesicular bulgings of the body wall, which occur in great numbers between the skeletal plates. On these bulgings, the body wall is very thin, and, in order to facilitate osmosis, devoid of calcareous deposits. It consists of layers similar to those found in other parts of the body: an outer, strongly ciliated and glandular epithelium; a middle layer of connective tissue, containing longitudinal and circular muscle fibres; and an inner ciliated epithelium, which is nothing else than the endothelium of the body cavity. The cavities of the papulæ are merely diverticula of the body cavity which bulge out the much-thinned body wall.

The papulæ are sensitive, and contract at the slightest touch.

In Asteroids with very thick body wall, diverticula of the body cavity force their way into it, branching on their way to the surface. On reaching this latter, each branch enters a branchial vesicle.

In certain forms, a single diverticulum traversing the body wall supplies a whole group of branchial vesicles.

A constant streaming to and fro of the body fluid can easily be observed in the branchial vesicles.

Each branchial diverticulum of the body cavity is surrounded, in the connective tissue layer of the body wall, by a circular lacuna.

The branchial vesicles occur both on the arms and on the disc. In the *Phanerozonia* they are found only on the upper side of the body; in the *Cryptozonia*, on the contrary, they occur on the sides of the arms as well, and on the lower (oral) side of the body.

4. **Ophiuroidea.**—The body cavity of the disc is much limited by the digestive sac and the bursæ. Filaments and bands of connective tissue, covered with endothelium, traverse it at irregular intervals, and connect the viscera with the body wall.

5. **Crinoidea.**—The body cavity of the calyx is almost completely filled with bands, trabeculæ, filaments, etc., of connective tissue covered with endothelium, which together form a spongy network, and often become calcified. In this network a sac-like membrane becomes differentiated, which divides the body cavity into a central and a peripheral space. The central space, which contains the intestine, is known as the peri-intestinal cavity; the peripheral, as the subtegumentary cavity. The peri-intestinal cavity, again, contains another separate portion of the coelom, the axial body cavity, round which the intestine coils itself. This latter cavity encloses the genital stolon and communicates, on the one hand, with the five chambers of the chambered organ which lies in the apex of the calyx, and through it with the coelomic canals of the stalk and the cirri; and on the other, with the oral or subtentacular canals of the arms. The peri-intestinal cavity, on the contrary, is continued into the dorsal or apical brachial canals.

B. The Brachial Cavities.

1. **Asteroidea**.—The body cavity of the disc is produced in the form of large cavities which run along the arms to their tips. The body cavity is thus found throughout the whole of that part of the arms which is enclosed by the skeletal plates, and contains (1) the ampullæ of the water vascular system, (2) the two radial cæca of the stomach, and finally (3) a part of the genital glands as well. The radial cæca of the stomach (two of which occur in each arm) are each attached to the dorsal wall of the arm by two suspensors, which run in the longitudinal direction, so that, above each cæcum there lies a cœlomic canal whose walls are formed (1) dorsally by the brachial wall, (2) ventrally by the wall of the cæcum, and (3) laterally by the two suspensors (*cf.* Fig. 354, p. 411).

2. **Ophiuroidea** (Fig. 355, p. 412).—The vertebral ossicles occupy so large a part of the transverse section of the arm, that only a very small space is left for the brachial cœlom. This latter is found as a flat cavity below the dorsal wall of the arm. It is divided into consecutive chambers, which agree in number with the segments of the arm; these chambers are incompletely separated from one another by transverse, vertical, calcareous septa, which connect the vertebral ossicles with the outer skeletal plates of the arm. These septa leave a mediodorsal space free, through which all the chambers are in open communication with one another. This is the "dorsal canal" of authors.

The endothelium of the brachial cavity is thickened in the dorsal middle line, and carries specially strong cilia. There is thus in each arm a longitudinal **ciliated band** or **streak**, which, when it reaches the disc, passes into the ordinary endothelium. The activity of these strong cilia originates and maintains the circulation of the body fluid in the brachial cavity. Occasionally the ciliated streak is deepened into a groove.

3. **Crinoidea** (Fig. 356, p. 413).—In this class also the brachial cavity is much reduced by the strong development of the skeletal joints of the arms; unlike that of the Ophiuroidea, however, it is found on the ventral side of the arm. The cavity is divided by a horizontal longitudinal septum into two canals, one lying above the other; both of these run through the arm and its branches as far as to the tips of the pinnulæ. The dorsal (apical) cœlomic canal is known as the **dorsal**, and the ventral (oral) canal as the **ventral** or **subtentacular canal**. The latter, on reaching the disc, enters the axial cœlom, the former enters the peri-intestinal cavity. The ventral canal itself, again, is divided by a vertical longitudinal septum into two lateral canals.

The endothelium of the dorsal canal occasionally (especially in the pinnulæ) shows small sac-like bulgings, which are known as **ciliated baskets** or **sacs**. The

floors of these sacs consist of flat cells, but the epithelium round their openings into the dorsal canal is much thickened, and provided with large cilia. These ciliated sacs undoubtedly serve the same purpose as the ciliated bands in the brachial cavities of the *Ophiuroidea* and the urns of the *Synaptida*.

C. The Periesophageal Sinus.

1. **Holothurioida** (Fig. 365, p. 428).—Between the mouth and the water vascular ring the œsophagus is surrounded by a membrane-like sheath, in such a way that between it and this membrane a narrow cavity is left; this is the **periesophageal sinus**, which is a section of the cœlom. The radial canals of the water vascular system run along its outer side, and in the radial direction it is traversed by numerous bands and filaments which are attached on the one hand to the œsophageal wall, and on the other to the outer membrane of the

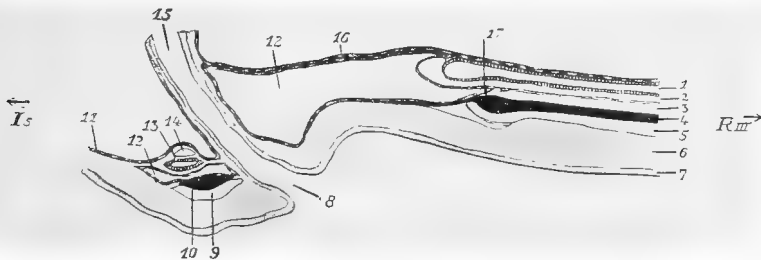

FIG. 369.—Median section through the oral region of *Spatangus purpureus* (after Cuénot). I₅, Posterior unpaired interradius; R_{III}, anterior unpaired radius. 1, Radial canal of the water vascular system; 2, radial blood vessel; 3, radial pseudohæmal canal; 4, radial nerve trunk; 5, radial epineural canal; 6, test; 7, body epithelium; 8, mouth; 9, epineural circular canal; 10, circular nerve; 11, endothelium of the body cavity; 12, periesophageal sinus; 13, water vascular ring; 14, blood vascular ring; 15, œsophagus; 16, membrane which separates the periesophageal sinus from the body cavity; 17, septum, which separates the pseudohæmal canal from the periesophageal sinus.

sinus. These are only wanting in the part near the mouth, which is thus distinct, and is known as the **peribuccal sinus**. The periesophageal sinus is usually in open communication with the common body cavity by means of a varying number of apertures in its outer membrane. In *Cucumaria* there are five such apertures, which are large and interradiar in position. In the *Elasipoda* alone is the periesophageal sinus completely separated from the general body cavity by an uninterrupted outer membrane, which runs from the water vascular ring direct to the body wall.

2. **Echinoidea**.—In the *Spatangoida* (Fig. 369) a membrane, which runs out horizontally from the commencement of the intestine to surround the circular canal of the water vascular system, completely separates a very small periesophageal sinus of the cœlom from the spacious body cavity. In those Echinoids which are provided with a masticatory framework, this latter develops within this sinus, which

thus attains a large size. The membrane which completely separates the periesophageal sinus from the general body cavity then becomes the lantern membrane, surrounding the masticatory apparatus on all sides, from the point where the intestine leaves the lantern down to the perignathous apophysial ring. The greater part of the periesophageal sinus (Fig. 358, 44, p. 419) is filled by the masticatory framework, the remaining space being traversed by trabeculæ, bands, etc. All the radial organs arise from within the periesophageal sinus, running in it as far as to the auricule.

The **outer gills** and **Stewart's organs** of the Echinoids are developments from the periesophageal sinus.

The **outer gills** (Fig. 358, 1) consist of five pairs of branched appendages, which rise at the periphery of the oral region, at the inner edge of the oral integument, and project freely outward. One pair of such gills occurs on each interradius. The peristomal edge of the disc is indented at certain points for the reception of the gills, so that their presence or absence may be determined by the presence or absence of these incisions on the test of either extant or fossil Echinoids. The gills are hollow outgrowths of the oral integument, their cavities being direct prolongations of the periesophageal sinus, and thus in open communication with this latter; the body fluid of the sinus can thus enter the gills and flow back into the sinus again. The wall of such a gill consists of a deep outer epithelium provided with long cilia, a central layer of connective tissue with calcareous corpuscles and lacunæ, and an inner ciliated covering of endothelium.

External gills occur in most endocyclic (regular) Echinoids. They seem to be wanting only in the *Cidaroida*.

Stewart's organs.—Just as external bulgings of the oral integument lead to the formation of external gills, internal bulgings of the lantern membrane into the body cavity give rise to **Stewart's organs**. These are delicate-skinned vesicles or tubes, which vary greatly in size. Five are usually present, projecting into the body cavity from the edge of the (apically directed) base of the masticatory framework, immediately below the fork plates or radii between these and the falces or intermediate plates (*cf.* p. 400). The cavity of the vesicle is a diverticulum of the periesophageal sinus.

The **Stewart's organs** of the *Cidaroida* are large, and are usually beset with secondary outgrowths. Since the *Cidaroida* possess no gills, it has been conjectured that Stewart's organs fulfil the functions of the absent external gills, and they have therefore been called **internal gills**. It is, however, very difficult to demonstrate with any certainty the respiratory significance of these organs.

In the *Echinothurida*, although external gills are present, **Stewart's organs** may attain a gigantic size (*Asthenosoma urcens*, Fig. 370). They here fill the greater part of the body cavity, and, it has been conjectured, serve in this case to prevent the collapse of the flexible test at the time when the genital products are ejected. On the other hand they may be quite vestigial, or even altogether absent (*Phormosoma*).¹

¹ *Cf.* Bell, *Ann. Mag. N. H.* vol. iv. 1889, p. 437.

In certain *Clypeustroidea* (*Echinodiscus biforis*, *Peronella orbicularis*) small inter-radial, thin-walled, vesicular outgrowths of the lantern membrane, on the base of the lantern itself, have been called Stewart's organs. Two of these occur in each

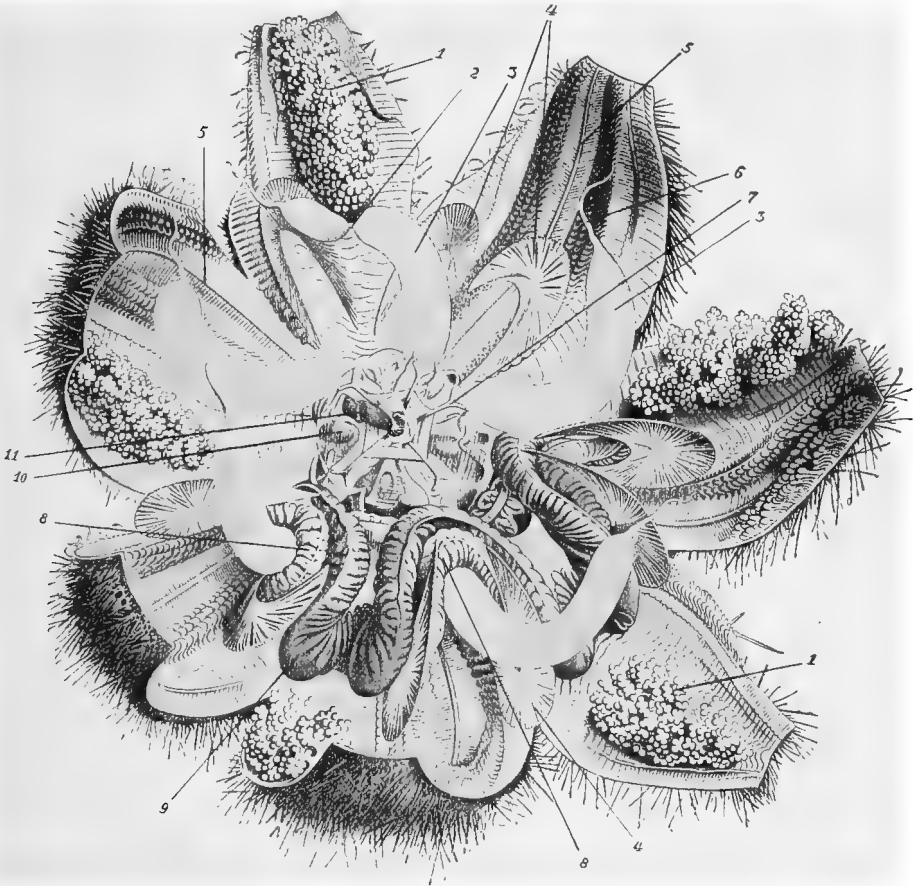

FIG. 370.—Viscera of *Asthenosoma* (after F. and P. Sarasin). 1, Gonads; 2, constriction in a Stewart's organ; 3, Stewart's organ; 4, muscle lamellae; 5, radial canal of the water vascular system; 6, tip of a Stewart's organ; 7, forked radius of the masticatory framework; 8 and 9, upper and lower coils of the intestine; 10, Polian vesicle; 11, intestine.

interradius, but are generally wanting in that interradius in which the intestine in ascending lies upon the lantern.

3. **Ophiuroidea.**—Two circular membranes, one above the other, connect round the œsophagus, and traversing the body cavity, connect the œsophagus with the oral skeleton. They thus cut off two very small periesophageal sinuses from the general body cavity.

D. The Perianal Sinus.

In the *Holothurioidea* (with the exception of the *Synaptidae*) and in the *Echinoidea* the end of the hind-gut is connected with the neighbouring body wall by means of a circular membrane, which cuts off a small **perianal sinus** from the general body cavity. If the circular muscle fibres, with which the walls of this sinus are abundantly supplied, contract, they act as sphincters, and close the anus. In the regular *Echinoids*, below the perianal sinus, there is a second closed sinus surrounding the hind-gut; this is the **periproctal sinus**.

E. The Axial Sinus.

1. **Asteroidea**.—In the madreporitic interradius the general body cavity is traversed by a large, vertical, flattened tube, with tough, flat, radially arranged lateral walls. This tube connects the region of the madreporite with the ventral body wall. The cavity of the tube is an enclosed portion of the true body cavity, and in a young stage is in open communication with the enterocoel; it is known as the **axial sinus** (sac- or tube-like canal, sac hydrophorique). It surrounds and contains (1) the stone canal, which runs down from the madreporitic plate to the circular canal; and (2) the axial organ (dorsal organ, heart, pseudo-heart), which is attached to its wall by means of a mesentery. The tough wall of the axial sinus consists of the following layers: (1) the ciliated endothelium of the body cavity (on the side facing that cavity); (2) longitudinal muscle fibres; (3) connective tissue; (4) the inner ciliated epithelium lining the axial sinus. The axial sinus opens dorsally into the **aboral circular canal (circular sinus) of the genital system**.

2. **Ophiuroidea** (Fig. 361, p. 422).—In consequence of the shifting of the madreporite on to the oral side, the stone canal which springs out of the circular canal bends outward and downward. At its distal end it is connected with a small coelomic sinus, usually called an ampulla, which lies on the side turned to the centre of the disc, and itself opens outward through the water vascular pore. This sinus no doubt corresponds with the axial sinus of Asteroids. Another sinus accompanies the stone canal on the side turned to the periphery of the disc, and opens into the circular canal of the genital system. That portion of the wall of this second canal which is in contact with the stone canal is developed as the **ovoid gland**.

3. **Echinoidea** (Fig. 358, p. 419).—The axial sinus, which runs up from the circular canal to the apex and is accompanied by the stone canal, is here almost completely filled by the large axial organ. It is completely cut off by a septum from a spacious sinus which lies near the ampulla, and into which a process of the axial organ projects. The two communicate only in an early stage of

development. Further, the communication which always primitively exists between the axial sinus and the aboral circular sinus of the genital system is interrupted in adult Echinoids, the only known exception to this rule being *Echinocyamus pusillus*.

4. **Crinoidea.**—In the *Comatulidae*, an axial section of the body cavity round which the intestine becomes coiled is said to exist. In other Crinoids, such an axial sinus seems to be wanting, or else is filled with connective tissue. There is, in adults, no connection between this sinus and the stone canals. In the direction of the principal axis, however, the axial sinus is traversed by a dorsal (glandular) organ, which, although of somewhat different structure, no doubt corresponds with the axial organ of other Echinoderms. This homology seems to be established by the fact that the dorsal organ of the Crinoids shows relations to the genital system similar to those of the axial organs in the Echinoidea, the Asteroidea, and the Ophiuroidea to the same system.

5. **Holothurioidea.**—In this class there is no axial sinus cut off from the general body cavity.

F. The Axial Organ.

(Dorsal Organ, Heart, Pseudo-heart, Kidney, Plastidogenic Organ, Ovoid Gland, Lymph Gland.)

No other organ of the Echinoderm has given rise to so many contradictory statements as the axial organ. The names given in the above heading, which have been gathered from various authors, show what different functions have been ascribed to it.

According to the most recent anatomical and ontogenetic researches, the following points may be stated with some degree of certainty.

(a) The axial organ lies on or in the axial sinus.

(b) It is developed from the endothelium of the body cavity, and, during early ontogenetic stages, it grows out in the shape of processes, strands, or tubes, which, at certain definite points of the body, become the gonads (ovaries and testes).

(c) Further, in the adult animal, the axial organ is in most cases still connected with the genital system, functioning, however (at least in the *Asteroidea*, *Ophiuroidea*, and *Echinoidea*), in all probability, as a lymph gland.

The *Holothurioidea* appear to possess no axial organ.

In the *Astroidea*, *Ophiuroidea*, and *Echinoidea*, the axial organ consists of a network of connective tissue, in whose meshes (embedded in blood plasma) round cells lie, which, by continual division, yield lymph corpuscles.

1. **Asteroidea.**—The axial organ lies in the axial sinus, to the wall of which it is attached by a mesentery. Below the madreporite it sends off a process into a small cavity, which is completely cut off from the axial sinus. Further, it pro-

trudes at certain points through the wall of the axial sinus into the general body cavity.

2. **Ophiuroidea**.—The axial organ is developed out of the wall of the sinus which accompanies the stone canal on the side which is turned towards the periphery of the disc; and, further, out of that portion of the wall which is in contact with the stone canal. It projects as a somewhat massive body into the sinus, occupying almost its entire lumen (*cf.* Fig. 361, 8, p. 422).

3. **Echinoidea** (Fig. 358, 32, p. 419).—The axial organ lies in the axial sinus, which it almost completely fills, and to the wall of which it is attached by means of numerous strands. It sends off a process into the sinus which lies below the madreporite near the ampulla, this process perforating the wall which divides this sinus from the axial sinus.

4. **Crinoidea** (Fig. 384 *op.*, p. 482).—The axial organ, which is in this class known as the **genital stolon** (or the **glandular organ** or the **dorsal organ**), is here differently constructed. It originates as a thin strand in the axis of the chambered organ, then ascends direct through the axial section of the body cavity of the calyx towards the mouth, widening in the first part of its course, and then again narrowing. It consists of a complex of much-twisted canals with narrow lumina, which are enclosed in a stroma of connective tissue; the lumina of these canals may disappear, and they may become strands. They are lined with cylindrical epithelium. In the axis of the chambered organ, the axial organ consists merely of a few very thin strands or canals, but when it leaves the chambered organ and ascends into the body cavity, the canals swell and branch, so that their number increases till the middle of the body cavity is reached. Then their number again decreases, one canal after the other ending blindly. Finally, in the oral region, the axial organ consists of only a few strands, which **most probably are continued into the genital tubes or strands of the arms**. Such a connection has at least been demonstrated in the young *Antedon*, and it has been further found that, ontogenetically, the genital tubes bud out of the axial organ.

G. The Chambered Sinus of the Crinoidea and its continuation in the Stalk and in the Cirri.

Quite in the apex of the calyx, and in *Antedon* enclosed in the centrodorsal, there is a cavity containing the apical parts of the axial organ. This cavity is of enterocœlomic origin. It is divided, by means of five radially arranged partitions of connective tissue, into five chambers, which are covered on all sides by epithelium. This is the "chambered organ" (Fig. 384 *ch.*, p. 482).

In stalked Crinoids the chambered sinus is continued into the stalk, forming in it a canal. This is also divided, by five radially arranged partitions, into five sub-canals (the continuations of the five chambers of the sinus) arranged round a common axis. This common axis is probably formed by a continuation of the axial organ.

In each of the whorl joints of the stalk in those Crinoids which have cirri, the five-fold canal widens to form a kind of repetition of the chambered sinus, giving off into each of the cirri a lateral canal, which runs through its whole length, and is divided into an upper and a lower canal by a horizontal partition reaching inwards as far as to the common axis of the stalk canals.

In the *Comatulidæ*, in consequence of the absence of a stalk, the arrangement is somewhat modified. We must imagine, however, that only the internodes of the stalk are wanting, just as many whorl joints being fused with one another and with the centrodorsal as there are whorls of cirri. In this way the chambered sinus is enlarged by the addition of the widened portions of the canal which were originally present in the whorl joints. The cirrus canals now rise direct from the chambered sinus.

As in the cirri of the stalked Crinoids, so also in those of the *Comatulidæ*, the canal is divided by a horizontal partition, and in these latter animals also the partition of each cirrus canal is continued as far as to the axis of the chambered sinus formed by the axial organ. The chambered sinus of the *Comatulidæ*, in sections taken in the direction of the principal axis, appears therefore to be divided by these partitions into as many spaces, consecutively superimposed, as there are consecutive whorls of cirri.

The five chambers of the chambered sinus, in close contact with the axial organ, are produced orally for a short distance as ever-narrowing canals accompanying the axial organ, and then end blindly.

The system of the chambered sinus is, therefore, in adult Crinoids, completely cut off from the rest of the cœlom.

For the relations of this sinus to the apical nervous system, see the section dealing with this latter, p. 460.

VIII. The Pseudohæmal System.

(Radial Sinuses and Circular Sinus of the Schizocœl, Subneural Canals.)

The pseudohæmal system consists of canals which are closely connected in the same manner in all Echinoderms with the oral nervous system. As **radial pseudohæmal canals**, they accompany the radial nerve trunks as far as to the ends of the radii; and as a **pseudohæmal ring** they accompany the nerve ring in its course round the œsophagus. They always lie on the inner side of the nerve trunks (that turned to the body cavity), between these trunks and the water vascular trunks. The radial pseudohæmal canals give off side branches which accompany the nerves of the tube-feet to their bases.

The pseudohæmal canals are filled with a fluid which resembles the cœlomic fluid. The intimate relation subsisting between these canals and the oral nerve ring and the radial nerve trunks makes it probable that they are specialised for the nourishment of these nerves. It has also been conjectured that they, together with the epineural canals, which we shall describe later, are of essential service in protecting the nerve trunks from being pressed or torn.

In the *Holothurioidea* and *Echinoidea* the pseudohæmal system is closed on all sides; in the *Asteroidea* and *Ophiuroidea*, on the contrary,

it communicates, by means of numerous apertures, with the general body cavity, and at one point of the pseudohæmal ring, in the madreporitic interradius with the axial sinus.

The pseudohæmal system, in the *Ophiuroidea* and *Asteroidea*, is said to arise, ontogenetically, as a cleft in the connective tissue (mesenchyme), and thus to be a **schizocœlomic** structure. It is, however (as has been proved in the *Holothurioidæ*), lined with endothelium. Such a lining, in the case of a schizocœlomic cavity is, however, so incongruous, that we are justified in desiring further evidence. (For the position of these canals, see Figs. 352-356, pp. 409-413.)

Special.—In the *Holothurioidæ* the oral pseudohæmal ring is, in the *Paractinopoda* (*Synaptidæ*), separated from each of the radial pseudohæmal canals by a septum. The pseudohæmal canals stretch only a short way backwards. In the *Actinopoda*, they run the whole length of the body, but are said also to end blindly at both ends, and the pseudohæmal ring is said to be wanting. The same is the case with the well-developed radial pseudohæmal canals of the *Echinoidea*. In the *Crinoidea* the canals are certainly very much reduced, their existence is altogether denied by some authors. The pseudohæmal canals of the *Ophiuroidea* give off lateral branches at regular segmental intervals; these branches ascend to the brachial cavity (dorsal canal), and open into it. In the *Asteroidea*, both the circular and the radial vessels are divided into two by a longitudinal septum. In the radial canals the septum is vertical, in the pseudohæmal ring it runs slantingly, dividing it into an outer and lower and an inner and upper canal. The latter, the inner and upper canal, in the madreporitic interradius, communicates with the axial sinus; the former, the outer and lower canal, is in open communication with the body cavity of the disc by means of five ascending, interradiar, lateral canals. At regular intervals, between every two consecutive tube-feet, each radial pseudohæmal canal is connected with two marginal canals which run longitudinally at the edges of the ambulacral furrow. Each tube-foot receives two canals from the pseudohæmal system, which run to its tip; one of these comes from the radial canal, and the other from the lateral canal. The lateral canal, further, sends off at each corner between two consecutive ambulacral plates and the contiguous adambulacral plate, a lateral branch, which runs up between these plates. This lateral branch opens into the brachial cavity.

Two specially interesting facts deserve notice: (1) the mesentery by means of which the axial organ is attached to the wall of the axial sinus is continued into the septum of the pseudohæmal ring, and through this into the septum of the radial pseudohæmal canals; and (2) the axial organ, although in a reduced condition, may even be produced along a greater or smaller portion of these septa. These facts throw further doubt upon the schizocœlomic nature of the pseudohæmal canals.

IX. The Epineural System.

In the *Holothurioidæ*, the *Echinoidea*, and the *Ophiuroidea* the oral nervous system is accompanied by canals known as the **epineural canals**, which run between it and the adjacent body epithelium. This epineural system thus repeats **on the outer side** of the oral nervous system the pseudohæmal system which accompanies the nerves on their inner side, and, like the latter system, it consists of an oral circular canal, and radial canals. In the *Asteroidea* and

Crinoidea, where the oral nervous system still lies in the epithelium, the **epineural canals are wanting**. This fact is in harmony with what we know of the formation of the epineural canals, which, as has been proved in the *Ophiuroidea*, arise through the sinking of the nerve trunks below the surface—the nerve trunks rising ontogenetically in the epithelium. These originally epithelial trunks become covered by two lateral integumental folds, which finally grow together over them in such a way that between them and the integument, which now forms a continuous cover over them, a cavity, the epineural canal, remains. The *Synaptidae* also have no epineural canals. This is probably connected with the special way in which their (subepithelial) nerve trunks develop ontogenetically.

An epineural circular canal is wanting in the *Holothurioidea*, and, in the *Echinoidea*, the circular canal is not in communication with the radial epineural canals. A small epineural (periambulacral) space occurs in connection with the development of a circular ganglion at the base of each tentacle in the *Ophiuroidea*.

X. The Blood Vascular or Lacunar System.

Within the connective tissue of various parts of the body in most classes of the Echinodermata there occurs a strongly developed **system of very small spaces or lacunæ**, which open into one another, and sometimes form at the surface of different organs a fine, close, membrane-like network of lacunæ. In other cases, they coalesce to form bundles of canals, running in definite directions, and anastomosing with one another. This lacunar system was formerly universally called a **blood vascular system**, and may still be allowed to retain this name, although a **regular circulation in definite directions of the fluid it contains has in no single case been demonstrated**.

The intercommunicating **lacunæ**, of which the blood vascular system consists, **have no walls of their own**, and no endothelial lining, and their arrangement in networks or plexuses, which are sometimes spread out flatly, and at others thickened into "**vascular trunks**," is entirely confined to the Echinodermata.

A **localised propelling apparatus is wanting**. What was formerly called the heart has nothing to do with the blood vascular system, but is the axial organ.

The **fluid (blood)** contained in the blood vascular system resembles that in the body cavity and in the water vascular system, but **contains much more albumen in solution**. In sections of fixed and stained animals, a vessel can easily be distinguished from the other almost empty cavities of the body by the considerable quantity of coloured coagulum contained in its spaces. The solid constituents floating in the blood are the same as in the body cavity and in the ambulacral vascular system.

Leaving altogether on one side the *Ophiuroidea* and the *Asteroidea*, in which the existence of a blood vascular system is still doubtful,

the following may be considered as the chief constituents of the blood vascular system in the Echinodermata: (1) a **blood vascular network in the intestinal wall**, whose evident function is to absorb the digested and dissolved nourishment as albuminoid out of the intestinal wall; (2) two large **vascular trunks**, which, arranged on opposite sides of it, accompany the intestine in its course; these conduct the blood, which has become enriched with albuminoid in the vascular network of the intestine, to other parts of the vascular system; (3) a **blood vascular ring**, which surrounds the mouth or œsophagus, and into which the two intestinal vascular trunks open; (4) **five radial blood vessels**, which run, like the water vascular and the nerve trunks, in the radii; (5) a **vascular network** on the surface of the **gonads** (genital glands); (6) a **vascular network** on the surface of the **axial organ**.

The connective tissue surrounding the vessels may, at various points of the vascular system, become modified for yielding corpuscles to the blood (**lymph glands**).

Contractions, very irregular and indistinct, have been observed only in the **vascular trunks of the intestine of the Holothurioidea**.

1. **Holothurioidea** (Fig. 371).—The simplest arrangement of the blood vascular system in this class is found in the *Paractinopoda* (*Synaptidae*). The intestinal lacunæ pour their contents first into two longitudinal trunks, one of which runs along the dorsal, and the other along the ventral side of the intestine. The ventral trunk opens anteriorly into the dorsal, which then runs along within the dorsal mesentery direct to the genital gland. It is here continued into a spacious lacunar system, which develops in the wall of the gland in such a way as to split into two diverging lamellæ, an outer and an inner, the latter carrying the germinal epithelium. The dorsal vessel further gives off a small lateral branch near the point at which the stone canal enters the circular canal. According to recent researches, neither a circular canal of the blood vascular system, nor radial vessels, nor tentacle vessels are to be found. In the *Actinopoda* (Fig. 371) the blood vascular system is more completely developed. Here, again, the blood from the lacunar network of the intestinal wall (which lies on the inner side of the muscle layer) is collected by two vascular trunks which accompany the intestine along its whole length, *i.e.* to the hind-gut; one of these trunks is the dorsal or mesenterial, and the other the ventral or anti-mesenterial. They both open anteriorly, immediately behind the circular canal of the water vascular system, into a circular vessel which surrounds the œsophagus, from which five radial vessels run in the radii. Each radial blood vessel lies between the radial nerve trunk on the outer and the radial water vessel on the inner side (Fig. 352, p. 409). It gives off lateral branches to the oral tentacles, the ambulacral feet, and the papillæ. The wall of the genital glands is everywhere richly "vascularised," either by a lacunar network or by a more simple splitting of its wall of connective

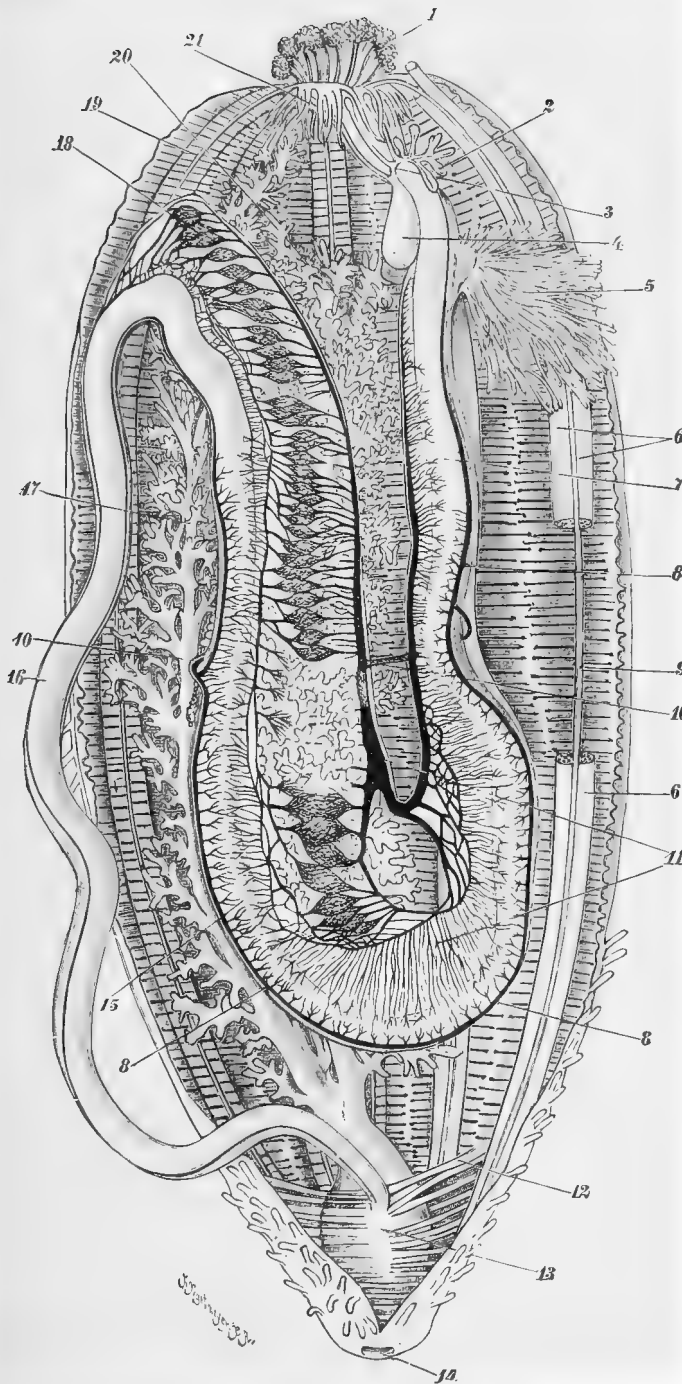

FIG. 371.—Organisation of *Holothuria tubulosa*. The blood vascular system is marked black. 1, Oral tentacles; 2, stone canals; 3, water vascular ring; 4, Polian vesicle; 5, gonads; 6, longitudinal muscles; 7, anterior section of intestine; 8, ventral intestinal vessel; 9, radial water vessel; 10, vascular anastomoses; 11, dorsal intestinal vessel; 12, filaments and strands (of the nature of both muscle and connective tissue) which attach the cloaca to the body wall; 13, cloaca; 14, cloacal aperture (anus); 15, middle section of the intestine; 16, posterior section of the same; 17, right branchial tree; 18, rete mirabile; 19, radial canal of the water vascular system; 20, left branchial tree; 21, tentacle ampulla (after Milne Edwards and Carus).

مكتبة جامعة القاهرة

tissue. The blood vascular system of the genital gland may derive its blood in three mutually exclusive ways: (1) by means of a special genital vessel from the blood vascular ring, (2) by means of a special genital vessel from the dorsal intestinal vessel, (3) direct from the latter, with which the genital gland is in contact.

The ventral vessel of the anterior section of the intestine is almost always connected with that of the middle section by means of a usually simple, but sometimes complicated anastomosis (Figs. 371, 10, 383, 27, p. 477).

In the *Aspidochirota* principally, but also in many *Dendrochirota* and *Molpudiida*, the dorsal vessel becomes detached from the intestine for a considerable distance; in *Holothuria tubulosa* (Fig. 371) this occurs along part of the anterior, the whole middle, and part of the posterior section, and it has a free course as the **marginal vessel of the rete mirabile** through the body cavity. It, however, remains in connection with the lacunar network which is developed in the wall of the intestine by means of a rich plexus of blood lacunæ, known as the **rete mirabile**. This network forms a much perforated membrane, one edge of which is attached to the intestine, while the marginal vessel runs along the other. The blood of the intestinal lacunar system, again, may collect in a special longitudinal vessel (**collateral vessel**, pulmonary vein) before passing over into the rete mirabile (Fig. 371).

The rete mirabile is often particularly richly developed in the loop formed by the anterior and middle intestinal sections. In the rest of the small intestine, the vessels which enter the plexus from the marginal vessel first break up into a bundle of very fine lacunæ (capillaries); these finest lacunæ then collect to form vessels which enter the collateral vessel. It may be said that here, between the collateral and the marginal vessels, numerous small retia mirabilia (Fig. 371, 18) of the second order are developed, and that they form webs round the **terminal ramifications of the left water lung**. It is doubtful whether they serve for respiration, since they are not developed in the wall of the water lung itself, but merely loosely invest the latter.

The dorsal vessel (so called because it lies on the anterior intestinal section close to the dorsal mesentery) does not run in this mesentery, but somewhat to the left of it. In the middle section of the intestine it comes to lie on the right, and in the posterior section again on the left side of the mesentery.

At certain points in the course of the vessel, blood glands may be developed. The spongy, alveolar structure of the vessel then becomes more marked, and many cells are found embedded in the strands, filaments, membranes, etc., of connective tissue which traverse the vessel; these are the formative cells of the blood corpuscles. At such points the lumina of the vessels (*i.e.* of the separate lacunæ, which together form the vessel) are much reduced.

2. **Echinoidea**.—The arrangement of the blood vascular system here agrees to a great extent with that in the *Holothurioidea*. A rich plexus of vacuoles is developed in the connective tissue layer of the

intestinal wall (with the exception of a larger or smaller portion of the hind-gut); from this plexus the blood collects into two longitudinal vessels, one outer and dorsal and the other inner and ventral. These longitudinal vessels do not lie in but on the wall of the intestine, in its mesenteries. The ventral or inner vessel, along the part where the accessory intestine is developed, passes on to this latter. Both vessels open into a blood vascular ring which encircles the œsophagus, in close contact with the water vascular ring. The position of these two rings and their relation to one another has already been sufficiently described (p. 424). From the blood vascular ring five radial vessels run to the radii, within the bands of connective tissue which separate the pseudohæmal canals from the radial trunks of the water vascular system (Fig. 353, p. 410). In Echinoids provided with a masticatory framework, the proximal portions of these radial blood vessels descend in the axis of the lantern along the edges of the five single pyramids forming the lantern, which are turned towards the œsophagus and to the nerve ring (Fig. 358, p. 419), before passing through the auricles to be produced as mentioned into the radii. They are said not to be in open communication with the circular vessel, but to be divided from it by a septum. The radial blood vessels during their course give off lateral branches which run to the bases of the tube-feet.

A lacunar plexus is also developed in the axial organ, immediately below the surface; this is either in direct communication with the blood vascular ring which encircles the œsophagus, or else draws its blood from the dorsal intestinal vessel. The vacuolar plexus of the axial sinus is further continued into the wall of the apical circular sinus of the body cavity, and thence on to the wall of the genital glands.

3 and 4. **Asteroidea and Ophiuroidea.**—It is doubtful whether a blood vascular system occurs in these two classes. This system is certainly wanting in the intestinal wall. The vessels which have hitherto been regarded as blood vascular, ring, and radial blood vessels (running between the nerve trunks and the pseudohæmal vessels) agree in structure with the axial organ, and are said to be direct continuations of this organ. As such they fall under another heading.

5. **Crinoidea.**—The blood vascular system is here well developed, and in all its parts shows in a very marked manner the spongy structure characteristic of Echinoderms (*i.e.* it consists of lacunar networks or plexuses). One lacunar network covers the axial organ, and another spreads out over the intestinal wall. Both are in open communication with a lacunar plexus which surrounds the œsophagus, and which may, at one point, become differentiated into a blood gland (spongy organ) by the deposition of numerous blood formative cells in its meshes.

XI. The Nervous System.

This system in the Echinodermata is developed in a quite peculiar manner, unknown in other animals. It is composed of three alto-

gether independent systems: (1) the superficial oral, (2) the deeper oral, and (3) the apical system.

(a) The **superficial oral nervous system** is developed on the oral side of the body, and is always more or less superficial. Its most important and constant constituents are: (1) a **nerve ring** encircling the œsophagus, and (2) **radial nerves** radiating from this ring, and corresponding in number with the radii. This system innervates the integument, the ambulacral appendages, and the intestinal canal. It occurs in all Echinodermata without exception.

(b) The **deeper oral nervous system** accompanies the superficial system on its inner side (*i.e.* on the side turned towards the body cavity). In the *Ophiuroidea* and *Asteroidea* it is paired in each radius, *i.e.* its trunks or ganglia lie on the two sides of the radial nerves of the superficial system. In the *Echinoidea* and *Holothurioidea*, on the contrary, it is unpaired in each radius, and consists of a trunk or ridge in close contact with the radial nerve of the superficial system on its inner side. In the *Ophiuroidea* and *Asteroidea* a more or less complete ring surrounding the œsophagus seems to be developed in this system, but this is wanting in the *Echinoidea* and *Holothurioidea*. The *Crinoids* and those *Echinooids* which have no masticatory apparatus have no deeper oral nervous system.

This system innervates the muscles which run in the oral side of the body wall; in the *Holothurioidea* it perhaps innervates the whole dermo-muscular tube, but in the *Echinoidea* probably only the muscles of the masticatory apparatus.

(c) The **apical nervous system** is specially strongly developed in the *Crinoidea*. It consists of a nerve envelope, surrounding the chambered organ, and forming a centre from which five nerves run out along the axial canals of the brachial skeleton, penetrating as far as to the distal joints of the pinnulæ (*cf.* Fig. 356, 8, p. 413).

The apical nervous system is also continued into the stalk and the cirri. It innervates the whole of the musculature which moves the arms and the cirri.

In the *Asteroidea* the apical nervous system consists of radially arranged nerve trunks which meet at the centre of the disc; there is one trunk for each arm. These trunks run along the middle line of the arms, immediately above the body cavity, and innervate the dorsal muscles of the arms.

In the *Ophiuroidea* and *Echinoidea* a delicate nerve trunk runs within the wall of the aboral circular sinus throughout the whole course of the latter; this is the **genital nerve ring**.

The *Holothurioidea* have no aboral system.

A. The Superficial Oral Nervous System.

Until comparatively recently this system was the only nervous system known in Echinodermata.

In the *Asteroidea* and *Crinoidea* it occupies throughout life an **epithelial position**, but in all other Echinoderms it sinks and becomes subepithelial, except at the ends of the radii (in the terminal tentacles), and in the intestine. Here, throughout life, it is epithelial.

The shifting of the superficial nervous system to a position below the body epithelium, in Echinoderms, goes hand in hand with the formation of the epineural canals, as already explained (p. 449).

1. *Asteroidea* (Fig. 354, p. 411).

The radial nerves here form a thickened longitudinal ridge of the epithelium along the base of each ambulacral furrow, and the circular nerve a thickened ridge round the mouth. In these nerve ridges the (ciliated) epithelial cells represent the nerve cells. At their bases they are continued into nerve fibres, which run in the longitudinal direction of the nerve ridges (*i.e.* of the radial nerves), and together form the deeper layer of the ridge. From the radial nerves a close plexus of nerve fibres spreads out below the surface of the outer epithelium over the whole body; this is especially close in the ambulacral feet. In the same way a layer of nerve fibres is found over the whole intestinal epithelium; this layer increases in thickness orally until it enters the circular nerve.

2. *Crinoidea* (Fig. 356, p. 413).

The above account of the nervous system of the *Asteroidea* is also applicable to that of the *Crinoidea*, if it be remembered that the food grooves of the arms and of the tegmen calycis of the Crinoids correspond with the ambulacral furrows of the *Asteroidea*. The food grooves branch with the arms, and so do the radial nerve ridges of the superficial oral system. The Crinoids, however, differ from the *Asteroids* in that the epithelial nerve plexus is limited to the oral side of the calyx and of the arms, since no epithelium can be made out on the apical side of the calyx, on the sides and backs of the arms, and on the stalk and the cirri of adults.

3. *Ophiuroidea* (Fig. 372).

The superficial oral nervous system, having here taken up a subepithelial position, appears in the form of distinct nerve trunks and of nerves radiating from these. The central portion consists of the nerve trunks of the disc and of the five radial trunks of the arms. These latter run on the inner side of the row of ventral shields, between these and the vertebral ossicles. The circular nerve throughout its whole course is beset with nerve cells on the side turned towards the oesophagus, and the same is the case with the radial nerves on the side turned towards the ventral shields. The segmentation of the arms appears in a marked manner in the radial nerve trunks which

run through it. At regular segmental intervals, about on a level with the consecutive pairs of tentacles, these trunks show distinct swellings, from which most of the nerves originate. In this way the radial nerves superficially resemble the ventral ganglionic chain of many *Annulata* and *Arthropoda*.

The central portion of the deeper oral nervous system is so closely applied to the corresponding portion of the superficial nervous system that the two can only be distinguished from one another by means

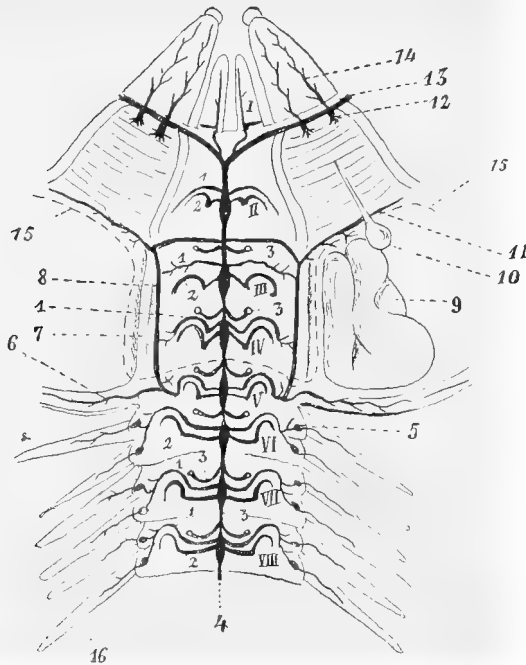

FIG. 372.—Nervous system of an Ophiurid (*Ophiothrix fragilis*) (after Cuénot). Part of the disc and the base of an arm. 1, Peripheral brachial nerve; 2, tentacle nerve; 3, nerve to the muscles between the vertebral ossicles; 4, radial nerve trunk; 5, ganglion at the base of a spine; 6, marginal nerve of the disc; 7, bursal aperture; 8, nervus lateralis; 9, gonad projecting into the bursa; 10, Polian vesicle; 11, interradial nerve; 12, nerve of the musculus interradialis aboralis (Simroth); 13, nerve ring; 14, dental nerve; 15, enterocolic nerve ring; 16, spine; I, first oral tentacle; II, second oral tentacle; III-VIII, tentacles of arms.

of careful microscopic examination, *e.g.* of transverse sections. In the following description, however, we shall keep the two systems entirely distinct from one another.

Nerves of the œsophageal ring.—A large number of nerves arise from the œsophageal ring, and ramify in the connective tissue layer of the intestinal wall. Further, at each of the points where a radial nerve trunk joins the œsophageal ring, the latter gives off two nerves, which run to the bases of the first pair of oral tube-feet. Each of them there forms a circular ganglion, almost completely surrounding

the base of the root, and then sends off a branch which runs to the tip of the tube-foot (Fig. 372. 1).

Nerves of the radial trunks.—Two pairs of nerves arise at regular intervals from the radial nerve trunks, as well in the free portion of the arm as in that included in the disc. These are the **tentacle nerves** and the **peripheral nerves**.

The **tentacle nerve** has a short course to the base of its tentacle, and there forms a ganglion—the tentacle ganglion—which embraces the base of the tentacle. The nerve contains along its course nerve cells, which are still more plentiful in the tentacle ganglion. The tentacle nerve and the ganglion are, like the radial nerve trunk, accompanied by an epineural canal. From this basal tentacle ganglion, the tentacle nerve, which remains in the subepithelial layer, ascends to the tip of the tentacle.

The **peripheral nerve** at first runs in close contact with the tentacle nerve of the same side as far as to the base of the tentacle; it then runs further laterally, penetrates into the lateral wall of the arm, running through the skeletal mass of the latter, and breaks up into branches which innervate the ventral, lateral, and dorsal integument of its own side of the arm.

In those Ophiurids, the sides of whose arms are provided with spines (*i.e.* in the majority of cases), **peripheral ganglia** are formed at the bases of these spines.

The nervous system becomes somewhat more complicated in the portion of the arm which is included in the disc. Branches of the peripheral nerve ascend apically at the side of the bursa which is turned to the arm, *i.e.* on the radial side of the genital plate described on p. 361, when it meets a **lateral nerve** (8) running along this plate. **Distally** this lateral nerve is continued into an **aboral marginal nerve** (6), the branches of which innervate the periphery of the disc. **Proximally**, the lateral nerve passes over into an **interradial nerve** (11), which runs along the outer side of the interradial muscle.

In some cases (*Ophiothrix*, *Ophiocoma*, *Ophioglypha*), the first pair of tentacle nerves and their accompanying peripheral nerves are followed by a pair of nerves which run towards the bursal aperture, subsequently uniting with the lateral nerves.

In *Ophioglypha*, a delicate pair of nerves which innervate the integument of the ventral (oral) side of the arm runs out between each of the regularly recurring pairs of tentacle and peripheral nerves.

4. Echinoidea (Figs. 353 and 358, pp. 410 and 419).

In all Echinoids, even in those which are provided with a masticatory apparatus, the œsophageal ring remains in close proximity to the mouth, on the inner side of Aristotle's lantern, and at a considerable distance from the water vascular and blood vascular rings, which appear to be in a manner lifted up by the lantern. From the œsophageal ring, especially, in the radii, nerves run to the œsophagus, gradually breaking up into a plexus, which is still traceable even in the wall of the first coil of the intestine. From the radial nerve trunks, as in the *Ophiuroidea*, at intervals which correspond with the ambulacral feet, **nerves for these feet** and **peripheral nerves** are given off. In the regular *Echinoidea* and the *Clypeastroidea*, the tube-foot nerves and peripheral nerves arise together, but in *Spatangoida* they arise separately. The points of origin of these two sets of nerves from the radial nerve trunk are arranged alternately, in accordance with the alternate arrangement of the two rows of

ambulacral plates of an ambulacrum, and with the alternate arrangement of the ambulacral feet at the two sides of the water vascular trunk.

Each tube-foot nerve, with its peripheral nerve, passes out together with the tube-foot canal of the water vascular system, through the ambulacral pore, on to the surface of the test. The nerve of the tube-foot is then continued in the epithelial layer to the tip of the foot, without forming a ganglion. The peripheral nerve, however, enters an integumental nerve layer which covers the whole body and its appendages.

The network of nerves or layer of nerve fibres, both in the intestine and in the external integument, lies, in regular Echinoids (*Cidaroida*, *Diadematoidea*) and in the *Clypeastroidea*, deep in the epithelium, but is subepithelial in the *Sputunyoidea*.

5. Holothurioidea.

The superficial oral nervous system is here subepithelial and agrees in all respects with that of the *Erchinoidea*. The nerve ring which surrounds the mouth gives off the nerves to the oral tentacles and the intestinal canal. The latter innervate also the skin round the mouth, and ramify richly in the connective tissue layer of the intestine, especially in its anterior portion. The radial nerve trunks give off lateral branches to the tube-feet or ambulacral papillæ, and "peripheral nerves" to the integument. The latter break up into a subepithelial network of fibres.

In the *Synaptidae*, each radial nerve trunk, soon after it rises from the œsophageal ring, gives off a pair of nerves to the auditory vesicles.

B. The Deeper Oral Nervous System.

1. Asteroidea (Fig. 354, p. 411).

In close contact with the inner side of each radial nerve ridge (which is here epithelial) a subepithelial longitudinal band of nerve cells and nerve fibres run along each side. A similar band accompanies the œsophageal ring, at least in its interradian regions. From the radial bands of the deeper nervous system, lateral nerve bands arise at regular intervals which correspond with the ambulacral feet. These lateral bands ascend on the outer side of the radial pseudo-hæmal canals, and soon break up into fibres, which probably innervate the muscles of the ambulacral skeleton. Nerves which emerge interradially from the deeper nerve ring seem to innervate the interradian muscles of the oral skeleton.

2. Ophiuroidea (Fig. 355, p. 412).

Here also, two lateral bands, consisting of nerve cells and longitudinal fibres, lie in close contact with the inner side of each

radial nerve trunk. The radial nerve trunk of the superficial system and the paired nerve bands of the deeper nervous system are separated merely by a thin structureless membrane. The superficial circular nerve is similarly accompanied by a band of the deeper nervous system.

The paired bands become thickened at regular intervals, simultaneously with the radial nerve trunks of the superficial system. Between the consecutive swellings of this latter, however, they are extremely thin. The deeper nerve ring is much thicker in its inter-radial than in its radial portions.

In each interradius two nerves are given off by the deeper nerve ring; these break up into several branches and innervate the inter-radial muscles of the oral skeleton.

The paired radial bands of the deeper system give rise, at points which regularly alternate with the tentacle and peripheral nerves, to nerves which, first penetrating the cavity of the pseudohæmal canal, ascend apically, enter the vertebral ossicles, ramify in them, and innervate the intervertebral muscles. The vertebral nerve of one side always innervates the dorsal and ventral intervertebral muscles of the same side of the arm, which counteract the homologous muscles of the opposite side.

3. Echinoidea.

Only those Echinoids which are provided with a masticatory apparatus have a deeper nervous system; this bears out the very probable assumption that this system innervates the masticatory muscles. It consists of five lamellæ consisting of nerve cells and fibres, which are in close contact with the radial portions of the superficial œsophageal ring and the points of departure of the radial nerves. Each lamella gives off a pair of large nerves. These ascend along the edges of the five jaws, then ramify, and most probably, as already stated, innervate the jaw muscles.

4. Holothurioidea (Fig. 352, p. 409).

The deeper nervous system is only developed on the radial nerve trunks, which it covers on their inner sides in the form, in each case, of a single thin band, consisting of nerve cells and longitudinal fibres. The nerves which proceed from these radial bands seem to serve principally for the innervation of the dermo-muscular tube.

C. The Apical or Aboral Nervous System.

The apical nervous system of the *Asteroidea*, *Echinoidea*, and *Ophiuroidea* has already been sufficiently described at the beginning of this section, p. 454. That of the *Crinoidea*, however, requires some further elucidation.

The chambered sinus which lies in the centrodorsal is surrounded by a cup-shaped envelope, which consists of ganglion cells and nerve fibres. The latter are arranged more or less concentrically around the sinus. The nerve envelope of the chambered sinus is continued along its prolongation, the stalk canal, and along the canals of the cirri. All these canals are in fact surrounded by a nerve sheath whose fibres run longitudinally. The large apical nerve trunks, which run from the nerve envelope of the chambered sinus into the radii (enclosed in the nerve canals), consist of nerve fibres and ganglion cells. A kind of metamerism is apparent in them, since they become somewhat thickened in the consecutive ossicles of the arm, and give off nerves at regular intervals corresponding with these ossicles. The apical nerve trunks divide with the arms, in whose nerve canals they are enclosed, and run to the tips of the pinnulæ.

Round the chambered sinus, commissures are formed between the nerve trunks arising from the nerve-envelope of the sinus. The courses of these commissures are explained by the diagrams of the nerve canals in which they are enclosed (Figs. 327-330, p. 378).

In *Antedon* and other forms, in the second costal, where the five primary nerve trunks fork to make the ten brachial nerves, a peculiar **chiasma nervorum brachialium** is formed (*cf.* Figs. 327 and 329, p. 378). The two ramifications of the nerve, which by their crossing form the chiasma, run one above the other without any mingling of their fibres. Further, the two brachial nerves forming one pair are connected immediately beyond the chiasma by means of a transverse commissure.

In each ossicle of the arm, the apical brachial nerve gives off an upper (oral) and a lower (apical) pair of nerves. These nerves seem to be principally sensory. They ramify richly in the calcareous substance of the joints. The increasingly fine ramifications, which radiate to the surface of the arm (Fig. 356, p. 413), finally reach special groups of epithelial cells, which must no doubt be considered as sensory cells. One principal branch of the oral (upper) pair, however, is said to run to the musculature, uniting the joints of the arm.

Besides these two pairs of nerves proceeding from the apical nerve trunks, nerves are said to run out at the level of the joint, from between the consecutive brachial joints, these having for their special function the innervation of the brachial musculature.

The apical **pinnula nerves**, which are given off in alternating order by the brachial trunks to the pinnulæ, arise from double roots.

According to the present state of our knowledge on the subject, the apical nervous system of the Crinoids is formed by the cœlomic endothelium. Even in adult animals, those portions of this system which envelop the chambered sinus, the stalk canal, and the cirrus canals show a close connection with their places of formation. The apical nervous system of the *Asteroids* retains its endothelial position throughout life.

D. The third Nervous System of the Crinoidea.

Besides the superficial oral and the apical systems, the Crinoids have another nervous system. This is developed on the oral side of the disc and of the arms, and is **subepithelial in position**. It consists of the following principal parts: (1) a **nerve ring encircling the œsophagus close to the mouth**; and (2) **five pairs of brachial nerves**. The two nerves of each brachial pair run down the arm longitudinally at the sides of the radial water vascular canal (Fig. 356, 4, p. 413). They are found on the branches of the first, second, and other orders. Their condition at the points where the arms divide is not yet known.

In addition to the five pairs of brachial nerves, the œsophageal ring gives rise, in each interradius, to two nerves which branch freely and run to the bands and mesenteries which traverse the body cavity, giving off branches also to the tegmen calycis.

Lateral branches of the paired brachial nerves innervate the musculature of the water vascular and tentacle canals which run in the arm; they also ascend in the tentacles to innervate their sensory papillæ.

This third nervous system of the Crinoids is connected with the apical system by means of branches in the following manner:—

1. The two brachial nerves of each arm send off branches alternately (first from the right nerve, then from the left) towards the apical side of the arm. Each of these unites with one of the pair of nerves which descend orally from the apical nerve trunk within the interior of the brachial joint (Fig. 356, 10, p. 413).

2. Certain lateral branches of the pair of nerves which run out from the œsophageal ring in each interradius seem to run along the body wall apically, and to unite with lateral branches of the apical nerve trunks which come from the nerve envelope of the chambered sinus.

Although recent investigators incline to the opinion that this third nervous system in the Crinoids has no representative in the other Echinoderms, the question may here be raised whether it does not correspond with a deeper oral nervous system. If we imagine the deeper oral nervous system of an *Ophiurid* or an *Asteroid* to have become severed from the superficial system and to have shifted further below the surface, we have a system showing considerable resemblance to the third system of the Crinoids. Because no connection between the deeper oral system and the apical system has yet been demonstrated in other Echinoderms, we have no right, considering the difficulty of investigation on this point, to conclude that no such connection exists. It is difficult to believe that there are three *completely* independent nervous systems in the Echinoderm body.

XII. The Sensory Organs.

The sensory organs of the Echinodermata show, as compared with the great complexity of the rest of their organisation, a very low degree of differentiation. They are for the most part undifferentiated **integumental (tactile) sensory organs**. Specific sensory organs are only rarely developed; the **oral feelers** are considered to be **olfactory and gustatory** organs; the **red spots at the tips of the arms** of Echinoids (on the terminal tentacles), and also the **shining spots on the integument** of the *Dialematidae* and related forms, are thought to be eyes; the **sphæridia of the Echinoidea**, and **Baur's vesicles (otolith vesicles)** in the *Synaptidae* and *Elasipoda* are considered to be organs of **hearing** or of **orientation**.

A. The Ambulacral Appendages as Sensory Organs.

1. The Terminal Tentacles.

We are undoubtedly justified in assuming that originally the radial canals of the water vascular system in all Echinoderms ended distally in a freely projecting tentacle or feeler, which, covered with a highly developed sensory epithelium, functioned as a sensory organ.

Such terminal tentacles are well developed in all *Asteroids* and *Ophiuroids*, and are found in them at the tips of the arms, where, as we have seen, the radial water vascular trunks end. They are supported by the terminal plates of the skeleton, and are surrounded by small spines which, when the slightest stimulus is applied to the terminal tentacle, bend towards one another protectively over it.

It has long been known that the terminal tentacle of the *Asteroids* carries a pigment spot, which has been regarded as an eye.

In the *Echinoidea*, the terminal tentacle is already somewhat reduced. The five tentacles are found on the five ocular plates of the apical system, and the pore which perforates each ocular plate is the aperture of the distal end of the water vascular trunk, which runs into the tentacle.

The five terminal tentacles are still further reduced in the *Holothurioidea*, where they lie round the anus.

Adult *Crinoids* have no terminal tentacles. The radial canals end blindly before reaching the ends of the arms and pinnules.

The terminal tentacles, in contradistinction to all other ambulacral appendages (ambulacral feet, ambulacral tentacles, papillæ), may be regarded as **primary appendages**. In the youngest stages of the animal, when the radial water vascular trunks have only just arisen as outgrowths of the hydrocœlomic vesicle, they lie close to the mouth. They attain the position they occupy in the adult animal by the

growth and prolongation of the radial canals, during which process bulgings arise alternately to right, and left, which, pushing the integument before them, form the ambulacral feet or tentacles. Those tube-feet are therefore most recent in origin which are nearest to the terminal tentacles and furthest from the ring canal.

The terminal tentacle is the **oldest ambulacral appendage**; it receives the distal end of the radial canal, and is the **only unpaired ambulacral appendage** of the radius.

Special—1. Asteroidea.—The tentacle which rests on the terminal plate is covered by a very deep sensory epithelium, which consists of long, thin, sensory

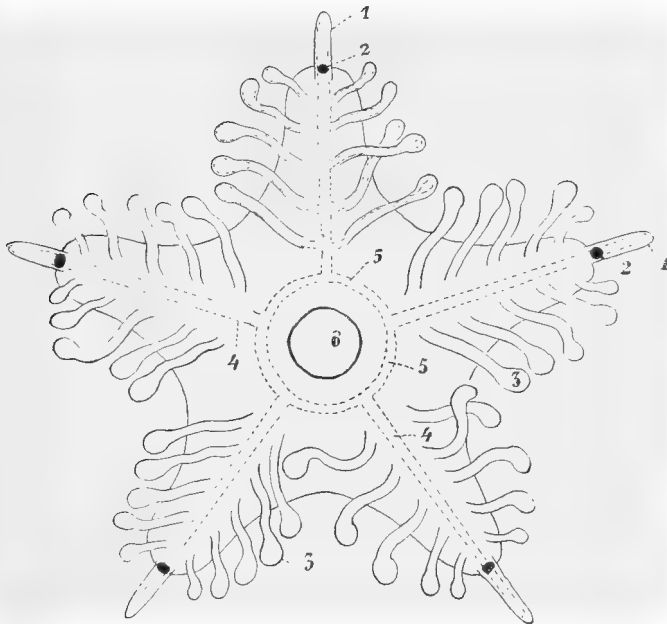

FIG. 373.—Water vascular system of a very young Asteroid. 1, Terminal tentacle; 2, eye spot at its base; 3, ambulacral feet; 4, radial canal of the water vascular system; 5, circular canal; 6, mouth.

cells. It carries long cilia, and contains beneath the surface a thick layer of nerve fibres, which represent the distal end of the radial nerve tract of the arm. At its base, on the side turned to the mouth, it carries a vivid orange-red pigment spot.

2. **Ophiuroidea.**—The tentacle is surrounded by the terminal plate as by a ring. There is no eye. The subepithelial radial nerve enters the terminal tentacle and ends in its epithelium. (These facts recall an analogous arrangement in the Annelida, where the ventral cord still remains epithelial in the growing caudal end after it has become subepithelial in other regions of the body). In the *Euryalæ*, which have much-branched arms, no terminal tentacles have been found.

3. **Echinoidea.**—The terminal tentacle in the adult is usually reduced to a low papilla which rises above the pore in the radial plate. In *Echinocyamus pusillus*

alone (Fig. 374) does this papilla project somewhat further. The radial canal traverses the pore and ends blindly under the epithelium of the papilla. The radial nerve trunks also, and with them the epineural canal, pass through the pore. After reaching

the papilla, the fibres, which had hitherto been subepithelial, enter the epithelium of the papilla and the epineural sinus ends. The pseudohæmal sinus, on the contrary, accompanies the radial canal and the radial nerve trunk only to the point where these latter enter the pore.

In a few rare cases the radials are perforated by two pores for the passage of two terminal tentacles (*Arbaciidae* and certain *Palæchinoidea*: *Melonites multipora*, *Palæchinus elegans*).

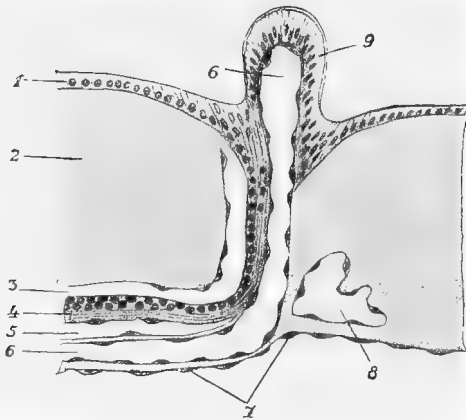

FIG. 374.—Section through the terminal tentacle of *Echinocyamus pusillus* (after Cuénot). 1, Body epithelium; 2, test; 3, epineural canal; 4, radial nerve trunk; 5, pseudo-hæmal canal; 6, radial canal of the water vascular system; 7, endothelium of the body cavity; 8, genital circular sinus; 9, terminal tentacle.

appeared. The radial canal perforates the body wall, accompanied by the radial nerve trunk and the epineural canal, and ends blindly close below the surface. The radial nerve unites with those "nests" of cells which represent the integumentary epithelium and which were described above, p. 415. The pseudohæmal canal ends at the point where the radial canal enters the body wall.

In other *Holothurioida* (e.g. *Holothuria impatiens*) even the last (intrategumentary) trace of the terminal tentacle is wanting. The *Synaptidae* have no terminal tentacle, since the radial canals are altogether wanting in them. The distal ends of the radial nerve trunks, however, perforate the integument, and in this we may perhaps see a last trace of the terminal tentacle.

2. The Ambulacral Feet and Ambulacral Tentacles.

Experiments on the living animal show that all the ambulacral appendages are very sensitive to external stimuli, especially mechanical and tactile. If the extended ambulacral foot of an *Echinoid* be irritated, it contracts, and the neighbouring spines bend over it protectively. The same is the case with all the ambulacral appendages of all Echinoderms. This is what we should expect from the rich innervation of these appendages, which, in addition to their other functions, must be regarded as organs of touch. Tactile functions could indeed be safely attributed to them by merely observing how the long, thin, suckerless feet at the end of the Asteroid arm, or the feet on the anterior side of the Spatangoid body, stretch out tentatively in various directions like the "horns" of a snail.

It cannot yet be demonstrated that all or any of the ambulacral appendages of the Echinodermata have any other special sensory functions. It has been conjectured that the oral tentacles are gustatory, but in the *Synaptidae* alone have

4. Holothurioida.—In

Cucumaria cucumis and *C. Lacazei*, the radial canals end round the anus, just as in the *Echinoida*, but the last externally visible trace of the terminal tentacle has dis-

specific sensory organs (the so-called **sensory buds**) been found on the inner side of the oral feelers (*i. e.* on the side turned to the mouth).

It has further been conjectured that the highly developed sense of smell of many Echinoderms is located in ambulacral appendages, and in the Asteroids it has been localised especially in the terminal tentacles of the arms, above described. Decisive experiments, however, have still to be made on this point.

The innervation of the ambulacral appendages is as follows: The tube-feet or tentacle nerves are always lateral branches of the radial nerve trunks of the superficial system, these lateral branches being accompanied by ganglion cells. When the base of the tube-foot or tentacle is reached the nerves have, in the *Echinoidea*, an epithelial course; but in the *Ophiuroidea* and *Holothurioidea*, they are subepithelial even within the foot or tentacle. In the *Crinoidea* and *Asteroidea*, these nerves, like the superficial nervous system, are, as we should expect, epithelial.

The condition of the nerves within the appendages varies.

In the *Asteroidea* and *Crinoidea*, no localised distinct tentacle or tube-foot nerve can be distinguished, a layer of nerve fibres being developed within the epithelium of the entire foot. In the *Ophiuroidea*, *Holothurioidea*, and *Echinoidea*, on the contrary, these nerves are distinct even in the feet (in the first two groups they are subepithelial, and in the last epithelial), and their ramifications can be clearly followed.

When the nerve reaches the base of a tentacle in the *Ophiuroidea*, it forms a large semilunar or semicircular ganglion encircling the base, before it ascends into the tentacle (Fig. 372, p. 456).

Round the terminal disc, in the tube-feet of the *Echinoidea* and *Asteroidea*, the (epithelial) nerve tissue becomes thickened to form a nerve ring, from which the nerve fibres (arranged as a whole radially) run inwards close to the epithelium of the terminal disc.

The way in which the nerve fibres end in the epithelium of the ambulacral appendages is still a disputed question. According to one view, the nerve fibres are connected with filiform sensory cells, which have been brought to light by means of maceration. According to another view, no such cells are present, the nerve fibres and epithelial cells being merely in contact.

Special.—Any special terminal apparatus of the sensory nervous system has rarely been observed in the ambulacral appendages. We have, however:—

(a) The sensory buds on the oral tentacles of the *Synaptidae*, already mentioned above. These are arranged in two longitudinal rows along the inner side of each tentacle. They are conical or papilla-like projections of the tentacle wall, with a pit-like invagination at the tip. A nerve from below the surface of the cutis enters the base of the pit, which consists of strongly ciliated sensory cells. It has already been pointed out that olfactory or gustatory functions have been attributed to these sensory buds.

(b) The tentacles of the *Crinoidea* carry scattered sensory papillæ in the form of distinct slender projections. Each papilla is composed of the fine processes of the circle of sensory cells, which form its base. It is traversed by a shiny axial (muscle) fibre, and carries at its freely projecting end three delicate, thin, immobile sensory hairs (Fig. 356, 14, p. 413).

(c) Similar sensory papillæ are found on the tentacles of the Ophiuroid form *Ophiactis virens*.

(d) In certain species of the Ophiuroid genus *Ophiothrix*, the tentacles are covered with circular rows of conical sensory papillæ. Each papilla seems to consist of a bundle of long sensory cells, and carries freely projecting sensory hairs (Fig. 375).

(e) Sensory papillæ, sensory hairs, etc., have also been observed on the various sensory feet of the *Echinoidea*.

[On the polymorphism of the ambulacral appendages, see the section on the Water Vascular System, D, p. 431.

B. Nerve Endings in the Integument.

A close plexus of nerve fibres is developed within the body epithelium of the *Echinoidea* and *Asteroidea*. This plexus is more strongly developed, *i.e.* closer and thicker at points which are specially sensitive to external stimuli, such as the fascioles of the *Echinoidea*, round the bases of the pedicellariæ, and on the gills (the so-called papulæ) of the *Asteroidea*, and at the bases of the spines of the *Echinoidea*.

[For the sensory prominences on the pedicellariæ, see p. 399.]

In the *Crinoidea* and *Ophiuroidea*, sensory nerves continually ramifying more and more finely, run through the (calcified) cutis to the surface of the body. The manner in which these nerve fibres terminate is unknown. Investigation on this point is the more difficult as the epithelium appears to be hardly distinguishable from the cutis.

At the edges of the food grooves (on the arms and the oral disc) of the *Crinoidea*, alternating with the trilobed tentacles, groups consisting of five to six sensory cells with delicate immobile hairs, occur.

Among the *Holothurioidea*, a system of nerve fibres ramifying in the cutis has been described in *Cucumaria*. From these branches run to the nests of epithelial cells sunk below the surface, which were mentioned in connection with the integument, p. 415. A similar arrangement has been found in other *Actinopoda*.

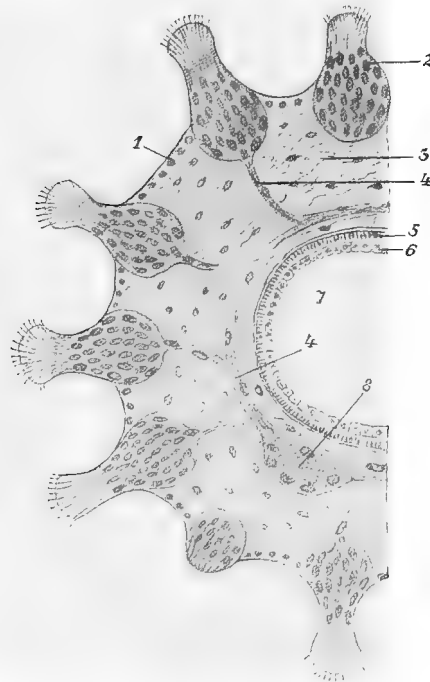

FIG. 375.—Half of a transverse section through an ambulacral tentacle of *Ophiothrix fragilis* (combined from figures by Hamann). 1, Body epithelium; 2, sensory papillæ; 3, cuticular connective tissue; 4, nerves to the sensory papillæ; 5, longitudinal musculature; 6, epithelium of the tentacle canal (7); 8, tentacle nerve.

In the *Paractinopoda* (*Synapta*, *Anapta*) numerous scattered sensory or tactile papillæ are found on the integument, which, at such points, bulges out to form prominences. At the centre of such a prominence a group of sensory cells forms the tactile papilla. A distinct nerve runs from each papilla to a large tactile ganglion lying in the cutis beneath it. The epithelial cells surrounding the papilla are differentiated into glandular cells (*Synapta inhaerens*).

C. Auditory Organs, Organs for Orientation.

Two types of organs for hearing or for orientation have been observed in Echinoderms: (1) the **auditory vesicles (Baur's vesicles, otocysts)** of certain *Holothurioidea*; and (2) the **sphæridia** of the *Echinoidea*, which have already been described.

1. **Auditory vesicles** are found only in the Holothurioidea, and among these in the *Paractinopoda* (*Synaptidae*), and among the *Actinopoda* in the *Elasipoda*.

They have been best observed in the *Synaptidae* (Fig. 376). In this family, five pairs of these vesicles occur in the cutis of the body wall, near the tentacles, at the points where the five radial nerve trunks emerge from the calcareous ring. On the outer side of each

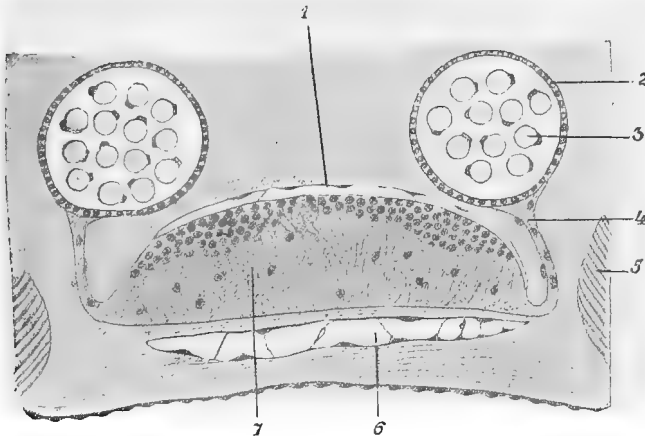

FIG. 376.—Section through the two auditory vesicles of a radius of *Synapta* (after Cuénot). 1, Epineural sinus; 2, epithelial wall of the auditory vesicle; 3, otoliths; 4, nervus acusticus; 5, longitudinal muscles; 6, pseudohæmal canal; 7, radial nerve trunk.

nerve trunk lies a pair of otocysts. Each otocyst consists of a vesicle filled with fluid, with a wall of (ciliated) plate epithelium. Numerous otoliths are found vibrating in the fluid. These otoliths are vesicular cells, the cavity of each being filled by a hard mass (phosphate of lime). The nerves to the otocysts (*nervi acustici*) come from the radial nerve trunk.

The auditory vesicles of the *Elasipoda* occur in great numbers; there may be fourteen to one hundred or even more. Not infrequently their manner of distribution is bilaterally symmetrical. For instance, in *Elpidia glacialis*, six of the fourteen auditory vesicles occur on the two lateral radii of the trivium, and one on each of the two radii of the bivium. In this case no vesicles occur in the ventral median radius.

2. The **sphæridia** of the *Echinoidea*, which are regarded as

transformed spines, have already been described in the section on the skeletal system (pp. 392-3). According to recent researches, there is only a loose connection between the sphaeridium and the shell tubercle, fibres of connective tissue, and not muscle fibres, uniting them. When an *Echinoid* is in the natural position, the sphaeridia, which are developed only on the oral side, hang down perpendicularly in their niches or chambers, owing to the weight of the dense calcareous mass which forms their rounded ends. They are thus able, by pressing on the nerve cushion at their base, to orientate an animal as to its position in space. *Echinoids* which are laid on the back, quickly turn themselves over again.

D. Eyes.

1. The **eye-spots of Asteroids** have already been mentioned (p. 463) in connection with the terminal tentacles. A vivid red eye-

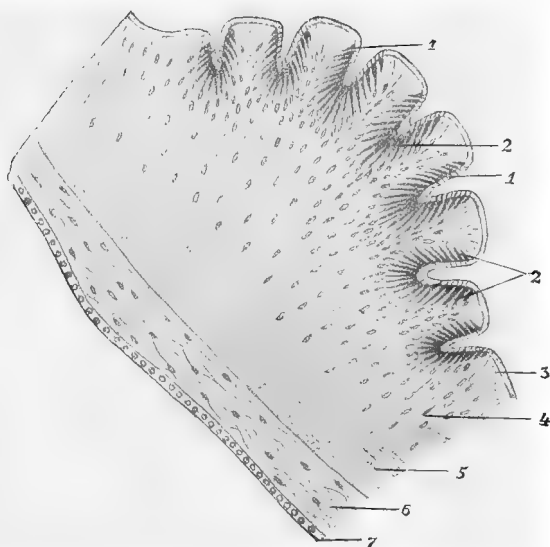

FIG. 377.—Section through the optic cushion at the base of the terminal tentacle of an *Asteroid*. 1, Cuticle of the optic cup; 2, pigment cells; 3, cuticle of the tentacle epithelium (4); 5, nerve layer below the surface of the same; 6, cutis of connective tissue; 7, epithelium of the tentacle canal.

spot is found at the base of each of these tentacles, on the side turned to the mouth. On closer examination each eye-spot is found to break up into a large number of single eyes, shaped like cups or hollow cones. The tips of these conical cups are directed inward towards the highly developed layer of nerve fibres below the surface of the tentacle epithelium, while their cavities open outward (Fig. 377). The wall of each optic cup is formed of pigment cells (with interspersed unpigmented retinal cells). The cuticle of the tentacle epithelium

also is continued into each cup. The portions of the cuticle which belong to the different cells forming the wall of the cup are distinct from one another, and have been described as rods.

Living Asteroids carry the arm with its tip directed upwards, so as to enable the eye-spot to function.

2. In *Diadema setosum* (*Euechinoidea diadematoidea*), an animal highly sensitive to light, the skin, which is as black as velvet, is

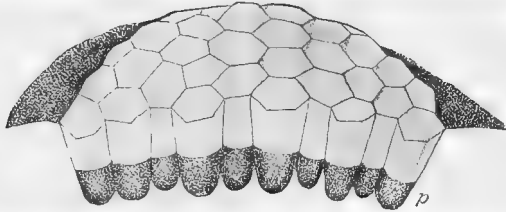

FIG. 378.—Part of a compound eye of *Diadema setosum* (after P. and F. Sarasin).
p, Pigment cups.

ornamented with numberless shiny blue spots; these are gradually lost on the oral side.

Each of these blue spots, when its surface is examined with the microscope, breaks up into a number of pentagonal or hexagonal portions. The number of these varies, according to the size of the spot, sometimes being many hundreds. Each is a refractive body, which stands in a cup of black pigment (Fig. 378). The blue colour

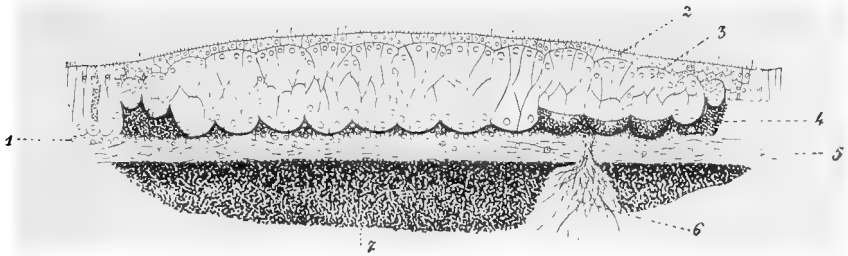

FIG. 379.—Section through the eye of *Diadema setosum*, diagrammatic (after P. and F. Sarasin). 1, Layer of ganglion cells; 2, "cornea"; 3, refractive body; 4, pigment cups; 5, nerve layer, or plexus; 6, fibres of connective tissue; 7, collection of pigment below the nerve layer.

of the spots, which are regarded as compound eyes, is due to interference.

A section made through such an eye (Fig. 379) reveals: (1) that the body epithelium, which is covered by a ciliated cuticle, spreads, much thinned, over the whole eye (cornea); (2) that each "refractive body" consists of a number of vesicular cells (modified epithelial cells); (3) that a pigment cup (consisting of cells which are often branched and star-like) surrounds the basal portion of each refractive body; (4) that the whole eye, with its numerous pigment cups, rests

directly upon a **nerve layer** provided with ganglion cells, which, at the edge of the eye, passes into the usual layer of nerve fibres, found in all *Echinoids* below the surface of the body epithelium.

Similar spots are found in other *Diadematidæ*, and species of the related genus *Astropyga*.

In the *Synaptidæ* (*S. vittata*), at the base of each tentacle, two pigment spots occur. It has now been proved that these "eyes" are sensory organs, but a detailed account of them has not yet been given.

XIII. The Body Musculature.

The special development of the body musculature of the Echinoderms is directly connected with the peculiar development of the skeleton.

Regarding the musculature and the skeleton alone, the Echinoderms may be divided into three groups.

Holothurioidea.—The skeleton here consists merely of isolated, and usually microscopically small, calcareous bodies. The presence of these in the leathery integument does not prevent changes of form in the tubular body. The body musculature is developed as a dermo-muscular tube. By means of co-ordinated contractions of the circular and longitudinal musculature of which this tube is composed, the animal is able to make slow, worm-like movements.

Asteroidea, Ophiuroidea, and Crinoidea.—The body in these classes is drawn out in the direction of the radii in the form of arms, which are supported by a jointed skeleton. The dermo-muscular tube breaks up into separate muscles, which connect the joints of the skeleton together. In the Asteroidea alone, a dermo-muscular tube persists side by side with these isolated muscles.

Echinoidea.—The skeleton of the Echinoidea (with but few exceptions) is a rigid test or capsule. A body musculature would here be useless, and is therefore wanting.

An exception to this rule is found among the *Euechinoidea* in the *Streptosomata*, in which the plates of the more or less flexible test imbricate. It has now been proved that in the *Echinothuridæ*, five pairs of muscle lamellæ run in meridians from the oral to the apical side on the inner surface of the test. The contraction of these muscle lamellæ causes a depression of the test.

The musculature of the Echinodermata consists, as a rule, of smooth muscle fibres. A longitudinally striated fibril of contractile substance lies on one side of the undifferentiated protoplasm of the formative cell which contains the nucleus. **Transversely striated muscle fibres** are of less frequent occurrence, but are found in the adductor muscles of the seizing pedicellariæ in the Echinoidea (p. 398), and in the muscles of the rotating anal spines of *Centrostephanus longispinus*.

The musculature of the various organs or systems of organs will be described in the sections dealing with those organs.

A. Holothurioidea.

The dermomuscular tube consists everywhere of an **outer circular muscle layer**, and of five radial **longitudinal muscles** (Figs. 371 and 383, pp. 451 and 477).

The circular musculature lies immediately within the cuticle. It is usually interrupted in the five radii, and thus consists of five longitudinal interradial strips or bands of muscle, the fibres of which run transversely. In the *Paractinopoda* (*Synaptidae*) alone, where there are no radial canals of the water vascular system, the fibres run uninterruptedly round the body.

The longitudinal musculature consists of five strong muscles or pairs of muscles traversing the body longitudinally along the radii. These muscles thus cover, on the side of the body cavity, the radial organs enumerated on p. 409. Anteriorly (at the oral pole) they are inserted into the radial pieces of the calcareous ring, posteriorly (at the apical pole) they end near the anus.

In the *Dendrochirotae*, the longitudinal musculature is differentiated in a peculiar manner. At the middle of the body, or somewhat in front of it, the fibres of each of the five longitudinal muscles divide into two bundles. One of these bundles is continued simply as a longitudinal muscle along the body wall, while the other freely traverses the body cavity, and is attached anteriorly to a radial piece of the calcareous ring (Fig. 349, p. 404). The **retractor muscles of the oral region** have in this way been derived by the splitting up of the originally simple longitudinal muscles, and this specialisation became more marked as the oral tentacles of the *Dendrochirotae* became more and more highly developed, and required increasing protection. Species are to be found in which the separation and branching off of retractors from the longitudinal muscles has not yet been perfected.

Apart from the *Dendrochirotae*, retractors occur only in the genus *Molpadia*, and in species of the genera *Chirodota* and *Synapta*.

B. Echinoidea.

The longitudinal muscles of the *Echinothuriidae* (*Asthenosoma*) have the shape of semilunar leaves, the convex sides of which are directed outwards, and are attached to the inner surface of the test; the concave edges, on the other hand, face the axis of the test (Fig. 380). They are inserted into the test at the boundaries between the ambulacra and the interambulacra, at the lateral edges of the ambulacral plates.

In each muscle lamella, the fibrous bands radiate fan-like (Fig. 380) from a "centrum tendineum" on the inner edge of the lamella. The uppermost fibres are attached to the radials, the lowermost to the outer side of the auriculæ. Anastomoses between the fibres are not infrequent.

The five pairs of longitudinal muscles or pairs of muscle lamellæ in the *Echinothuridae* invite comparison with the five longitudinal muscles or pairs of muscles in the *Holothurioidea*. No true homology can, however, be proved with certainty,

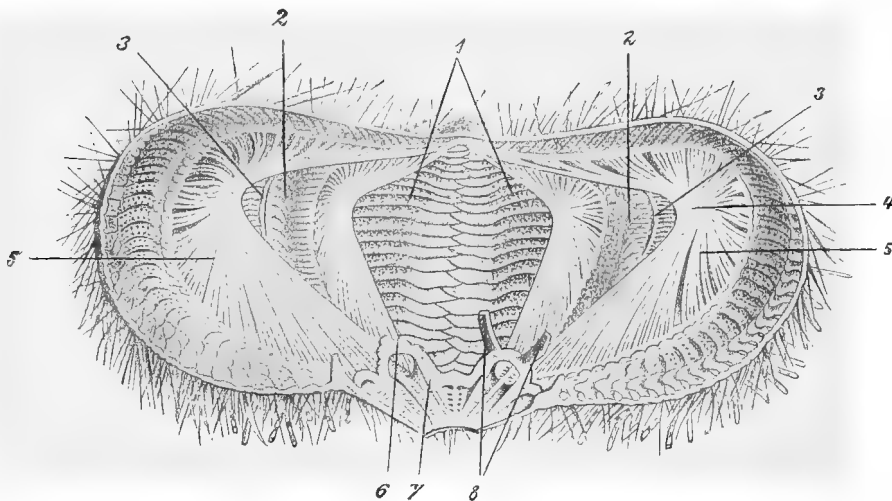

Fig. 380.—Test of *Asthenosoma*, broken open so as to show the longitudinal muscles. 1, Interambulacral plates; 2, ambulacral plates; 3, radial canals; 4, centrum tendineum; 5, muscle bands; 6, ambulacral apophysis (auricula); 7, opening muscle of the teeth; 8, retractors of the masticatory apparatus.

since no direct relation between the calcareous ring of the *Holothurian*, and any definite portions of the *Echinoid* skeleton (such as the auricules, or the pieces of the masticatory apparatus) can be established.

C. Asteroidea.

On the apical side of the arms and of the disc, a dermomuscular layer has been observed, which consists of external transverse, and internal radial fibres, and runs lengthwise in the arm. This does not appear to spread (as a muscle layer) to the oral side of the body, where the ambulacral skeleton is developed. It may perhaps, however, have become differentiated here into the special musculature of the ambulacral skeleton.

This latter is developed as follows:—

Ten muscles occur in each skeletal segment.

1. On each side two **vertical muscles** (or bands), one distal and the other proximal, connect the adambulacral with the ambulacral plate (*cf.* Fig. 309, p. 351).

2. On each side an **upper longitudinal muscle** connects every two consecutive ambulacral plates on their apical side (that turned to the body cavity). The function of these muscles is to bend the arm upward (Fig. 381, 2 and 7).

3. On each side a **lower longitudinal muscle** connects every two consecutive adambulacral pieces; this muscle counteracts the upper longitudinal muscle.

4. An **upper transverse muscle** connects the two opposite ambulacral plates of one and the same skeletal segment, on their apical side (that turned to the body cavity). These muscles, by their contraction, widen the ambulacral furrow (Fig. 382, 3 and 6).

5. A **lower transverse muscle** connects the two ambulacral plates of a segment on the lower side, which is turned to the furrow. These muscles, by their contraction, narrow the furrow.

The **musculature of the oral skeleton** (Fig. 381) is arranged as follows :—

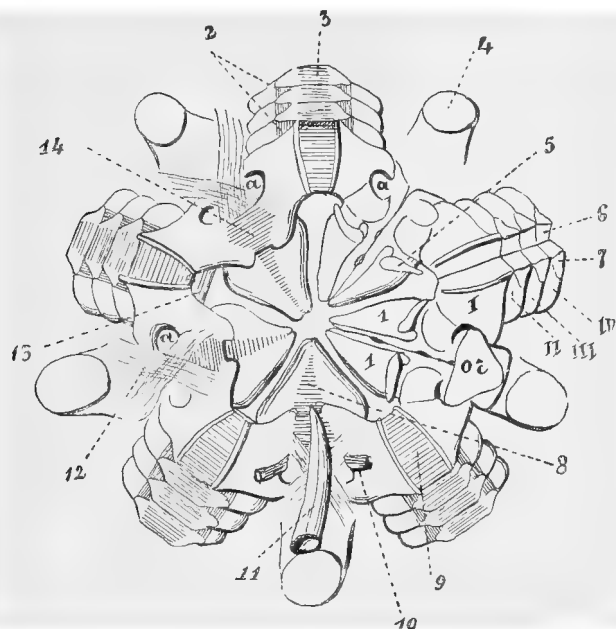

FIG. 381.—Oral skeleton and basal part of the brachial skeleton of *Pentaceros turritus*, with the musculature of these parts (after *Viguiér*). From within. 1, First adambulacral plates; I-IV, first to fourth ambulacral plates; or, orals; 2, dorsal longitudinal muscles; 3, dorsal transverse muscles (for opening the ambulacral furrow); 4, interbrachial pillars; 5, muscle apophyses of the first adambulacral plates; 6, facets of the ambulacral plates for the attachment of the dorsal transverse muscles; 7, ditto for the attachment of the dorsal longitudinal muscles; 8, transverse muscles between the first adambulacral plates (teeth); 9, dorsal transverse muscles between the first pair of ambulacral plates; 10, dorsoventral muscle; 11, stone canal; 12, crossed ligament; 13, abductor dentium; 14, adductor dentium; "a", aperturé for the first ambulacral feet.

1. A single or double radial muscle connects the distal ends of the first adambulacral plates (teeth, 1 in Fig. 310, p. 352) of one and the same radius (Fig. 381, 13), and opens these plates.

2. A muscle, which connects the distal ends of the first two adambulacral plates of two neighbouring radii, and is therefore interradiial. These interradiial muscles, by contracting, close the pairs of teeth (Fig. 381, 14). This closing action is assisted by a transverse muscle, which joins the opposing edges of each pair of teeth (8).

3. The first pair of ambulacral plates of a radius, like all succeeding pairs, are connected together by means of a dorsal transverse muscle (Fig. 381, 9).

4. Five pairs of dorsoventral muscles connect the first five pairs of ambulacral plates with the dorsal wall of the disc. By the contraction of these, the apical wall of the disc is approximated to its oral wall (Fig. 381, 10).

D. Ophiuroidea.

A dermomuscular tube is altogether wanting. The muscles which move the brachial skeleton (the intervertebral muscles) have already been described, p. 357.

The **musculature of the oral skeleton** (*cf.* Figs. 314 and 386, pp. 359 and 486).

1. A **musculus interradialis externus** connects transversely the opposite distal surfaces of the oral-angle plates of neighbouring arms. This is the most powerful of the muscles.

2 and 3. The two oral-angle plates of one and the same arm are connected by an upper and a lower transverse muscle (**musculus radialis superior et inferior**), and approximated by means of their contraction.

The three muscles just described form an outer circle, which is followed, orally, by a second inner circle, consisting of the following muscles:—

4. A **musculus interradialis internus inferior** connects transversely the oral ends of the oral-angle plates of the different arms.

5. The innermost muscles of the oral skeleton consist of fibres which radiate outwards. They run as five interradially placed pairs of muscles, from the oral-angle plates to the teeth (in *Ophiactis* only to the upper teeth), for whose movement they serve. These are the **musculi interradiales interni superiores**.

E. Crinoidea.

A dermomuscular tube is wanting. The musculature which moves the jointed skeleton has already been described, p. 376.

XIV. The Alimentary Canal.

A. General Review.

The alimentary canal, which runs through the body cavity, being attached or suspended to the body wall in various ways by means of mesenteries or mesenterial filaments, commences with the **mouth** and ends with the **anus**.

The absence of the anus in the *Ophiuroidea* and in the Asteroid family *Astropectinidae* cannot be regarded as an original condition.

In **no case** does the alimentary canal run as a **straight tube** from mouth to anus, although, in many *Synaptidae*, its condition is almost as simple. As a rule, the secreting and resorbing surface of the canal is increased in one of two ways:—

1. The alimentary canal, between the mouth and anus, becomes increasingly **lengthened**, and thus necessarily forms **loops**, and has a **winding** course (*Holothurioides*, *Echinoidea*, *Crinoidea*).

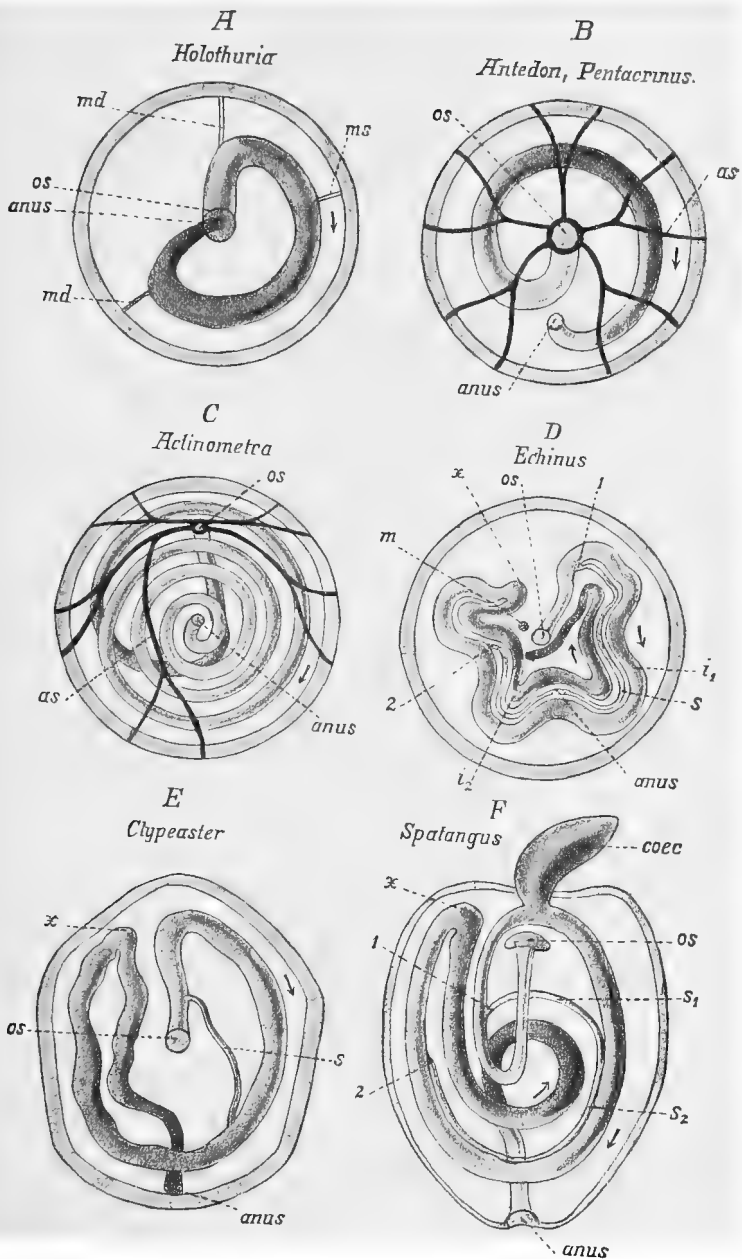

FIG. 382.—Diagram of the course of the alimentary canal in various Echinoderms. The body is viewed from the oral side. *md*, *ms*, Mesenteries; *as*, food-grooves or ambulacral furrows of the tegmen calycis; *m*, madreporite; *x*, commencement of the backward coil of the intestine; *i₁* first, *i₂* second (backward) coil of the intestine; *s*, siphon, accessory intestine; 1 and 2 (in F) the two points at which the accessory intestine enters the principal intestine; *s₁*, free portion of the accessory intestine; *s₂*, portion of the same in contact with the principal intestine; *coec*, intestinal cœcum. [Combined from several sources.]

2. The alimentary canal runs direct, without coiling, from mouth to anus, but has **sac-like widenings** (*Ophiuroidea*), and further, in the Asteroids, sends off branched outgrowths into the arms.

The wall of the intestine, as a rule, in the Echinoderm, consists of the following layers: (1) a **deep inner epithelium**, with numerous glandular cells; (2) a layer of **connective tissue**; (3) a muscle layer; (4) an outer epithelium, the **endothelium of the body cavity**. A system of **blood lacunæ** (absorbing canals) is developed in the layer of connective tissue in the *Holothurioidea*, *Echinoidea*, and *Crinoidea*.

B. Holothurioidea (Figs. 371, p. 451, and 383).

Course of the alimentary canal.—The mouth lies at the oral pole (*i.e.* at the anterior end of the body), the anus at the apical pole. For the exceptions to this rule, especially *Rhopalodina*, in which the mouth lies close to the anus, *cf.* section III, p. 408.

The alimentary canal is, as a rule, considerably longer than the body (on an average three times as long), and therefore has a looped or winding course. From the mouth, it first runs backward towards the anus (**first or anterior section**), it then bends for the first time, and runs forward again (**second or middle section**); lastly, it bends again near the anterior end of the body, and runs backward once more, this time to the anus (**third or posterior section**).

In making these bends, the alimentary canal forms a spiral round the principal (longitudinal) axis of the body; this is very clearly seen by following the line of attachment of its mesenteries to the body wall.

The anterior section is attached to the median dorsal line interradially. From this, at the first bend, the mesentery passes across the left dorsal radius into the left dorsal interradius. The whole of the central section is attached in this interradius. At the second bend, the mesentery passes over the left ventral radius and interradius, and over the middle ventral radius, into the right ventral interradius. The third or posterior section is attached in this latter interradius (Figs. 350, p. 407, and 383).

If a Holothurian is placed upright, with the oral pole upward and the apical downward, and if we project the loops of the alimentary canal on to a horizontal plane, or, if we simply view the **intestinal loops** of a Holothurian from the oral pole, we see that the digestive tract runs **from left to right, i.e. in the direction of the hands of a clock**. In other Echinoderms with coiled intestine, the coils also run in this direction.

It was mentioned above that the alimentary canal of many *Paractinopoda* (*Synaptilæ*) is almost straight. This is, however, not an original condition, as is seen from the following facts: (1) the older larva and the quite young *Synapta* have a bent alimentary canal; (2) the intestinal mesentery is inserted in the body wall exactly in the

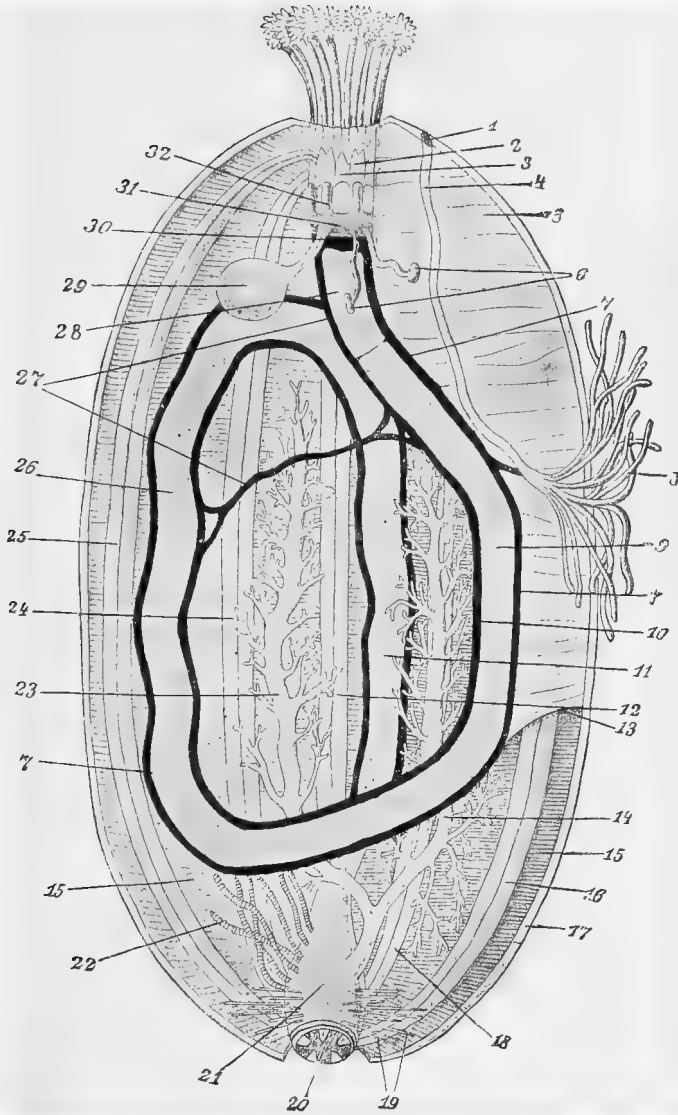

Fig. 383.—Organisation of an Aspidochirotan Holothurian. In the dorsal interradius, the body wall is cut through on the left, near the dorsal mesentery, and is spread out (after Ludwig, in Leuckart's *Tafelwerk*). 1, Genital aperture; 2, radial plates; 3, interradial plates of the calcareous ring; 4, genital duct; 5, dorsal or anterior mesentery of the intestine; 6, stone canals with their inner madreporites; 7, dorsal intestinal vessel; 8, gonads; 9, anterior section of the alimentary canal; 10, ventral intestinal vessel; 11, posterior section of intestine; 12, longitudinal muscles; 13, posterior edge of the dorsal mesentery; 14, right branchial tree (water lung); 15, circular musculature of the body wall; 16, longitudinal muscles; 17, cut edge of the body wall; 18, longitudinal muscles; 19, partly muscular filaments running from the wall of the cloaca to the body wall; 20, cloaca; 21, cloaca; 22, Cuvierian organs; 23, left branchial tree; 24 and 25, longitudinal muscles; 26, middle section of the alimentary canal; 27, vascular anastomosis; 28, fore-gut; 29, Polian vesicle; 30, blood vascular ring; 31, water vascular ring; 32, commencement of the radial vessel.

manner above described, and thus runs in a spiral; (3) in most cases, close examination reveals that even in the adult the canal is coiled in a spiral, although drawn out to a great length, and that the first and second bendings can still be distinguished as slight curves.

If the typical alimentary canal of an *Actinopod* were to be shortened until it was of almost the same length as the body, the condition found in the *Synaptidae* would arise.

The divisions or sections of the alimentary canal.—In the intestine of the Holothurioidea, consecutive sections have been distinguished, but these are never very marked microscopically. Throughout its whole course, the canal retains its tubular shape. The different sections are distinguished by their sizes and by the thickness of their walls, by their colour, their vascularisation, and especially by their histological structure. The boundaries of the consecutive sections are usually externally indicated by circular constrictions of varying distinctness; these constrictions not infrequently correspond with circular folds projecting into the canal.

The mouth.—Around the mouth, the circular musculature becomes thickened into a small **sphincter muscle**.

The more strongly the oral tentacles are developed, the more marked is the capacity for invaginating the mouth with its tentacles, and with a larger or smaller portion of the anterior end of the body, into the body cavity. In the *Dendrochirote*, in which the tentacles are strongly developed, the invaginable portion of the anterior end of the body is called the proboscis. It is not infrequently distinguished by the different colouring and constitution of its integument. In all cases, in invagination, the chief part is played by the retractor muscles (*cf.* p. 471). At the posterior boundary of the proboscis region five (interradial or radial) **calcareous valves** are occasionally developed; these, when the proboscis is invaginated, close the aperture (*c.g.* *Psolus*, Figs. 227 and 228, p. 287).

The œsophagus reaches from the mouth to the circular canal of the water vascular system, or even further. It is attached to the water vascular ring, the calcareous ring, the radial canals of the water vascular system, etc., by means of bands which run out radially, traversing the pericesophageal sinus (see Fig. 365, p. 428). These bands are chiefly of the nature of connective tissue, but also contain muscle fibres. The œsophagus, with the complex of surrounding organs, is sometimes called the **pharyngeal bulb**.

The œsophagus is followed by a shorter portion known as the **stomach intestine**, and this again by the longest part of the digestive tract, the small intestine. This last forms the larger posterior portion of the first section of the intestine, the whole of the second section, and by far the greater portion of the third and last section.

The last part of the alimentary canal, the **cloaca** or **rectum**, is distinguished by special thickness, and is attached by radially arranged strands and filaments to the neighbouring body wall. These strands consist of connective tissue and muscle fibres.

Into the cloaca or rectum open the **water lungs** and the **Cuvierian organs**, where these are present. These will be described, pp. 487, 488. In some *Elpidiidae*, the anterior part of the cloaca bulges out to form a large cœcum, which projects more or less far into the body cavity, sometimes reaching almost to the middle of the body. Since the *Elpidiidae* possesses no water lungs, there is some justification for the

suggestion recently made that their cloacal cæcum may function as a rudimentary organ of this kind.

The inner surface of the alimentary canal often shows a **longitudinal fold**. **Transverse intestinal folds**, arranged in longitudinal rows, have been observed in the small intestine of the *Aspidochirota*.

Finer structure of the alimentary canal.—The wall of the digestive tract consists of the following layers, which may vary greatly in thickness and special structure in the different sections: (1) An inner intestinal epithelium; (2) an inner layer of connective tissue with the blood lacunæ; (3) a muscle layer (generally consisting of an inner layer of longitudinal and an outer layer of circular fibres, but in some *Synaptidæ* and *Aspidochirota* this order is reversed); (4) an outer layer of connective tissue (often very thin); (5) the ciliated endothelium of the body cavity.

The inner intestinal epithelium is ciliated, especially in the small intestine. Over most of the digestive tract it is found as a very deep epithelium covered by a fine cuticle, its cells being palisade or thread cells. Glandular cells of various sorts are specially numerous in the epithelium of the stomach. The epithelium of the cloaca resembles the outer body epithelium. Into it open the processes of long subepithelial glands, which are unicellular and tubular.

The **anus** can be closed by means of a sphincter muscle. Calcareous plates, papillæ, etc., may occur round it.

C. Echinoidea.

For the **position of the mouth and the anus**, cf. p. 338.

In all adult Echinoidea, the length of the tubular intestine is greater than that of a straight line from the mouth to the anus, so that the course of the alimentary canal is necessarily coiled.

The simplest arrangement is found in the *Clypeastroidea* (Fig. 382, E, p. 475). The direction of the intestinal coils will here be described in the same way as in the Holothurioidea, the viscera being viewed from the oral side. After traversing the masticatory apparatus, the alimentary canal turns to the right (following the direction of the hands of a clock), and makes rather more than a complete coil round the principal axis of the body. So far, the course exactly resembles that of the intestine in the Holothurioidea. In the *Clypeastroidea*, however, the canal now bends back upon itself, and runs direct back to the anus, which in this division of the Echinoidea lies orally in the posterior unpaired interradius.

In the **endocyclic or regular Echinoidea**, the arrangement is not simpler, but still more complicated. After leaving the masticatory apparatus, the alimentary canal ascends towards the apical system, then bends round and follows the direction of the hands of a clock (attached to the inner surface of the test by the mesentery) till it has run about once round the principal axis. It then bends back upon itself, coiling in the reverse direction backwards to the apical anus (Fig. 382, D, p. 475).

The intestine of the exocyclic *Spatangoideu* resembles in its course that of the endocyclic Echinoidea with one difference, caused by the facts that the mouth has shifted anteriorly along the oral surface, and

the anus, out of the apical system into the posterior interradius. The mouth therefore draws the commencement of the first intestinal coil (which runs in the direction of the hands of a clock) forward, while the anus draws back (*i.e.* posteriorly) the end of the spiral which runs, as above described, backwards (Fig. 382, F, p. 475).

It is worthy of note that, in quite young *Spatangoidea* (*Hemiaster cavernosus*, 2 mm. long), the intestine, which appears to end blindly, ascends direct from the oral to the apical pole. At a rather later stage the mouth is still central, while the apical end of the alimentary canal has already somewhat shifted, and opens through the anus outside of the apical system. At this stage (when the length of the animal is from two to three mm.) the intestine runs up from mouth to anus in one single coil, as a spiral in the direction of the hands of a clock. The complicated arrangement in the adult is thus secondary, and is no doubt due to the fact that the canal increases in length more than does the interval between mouth and anus.

Finer structure of the intestinal wall.—This agrees essentially with the structure described in connection with the Holothurioida. No distinct sections can be made out in the alimentary canal. That part of it which runs through the masticatory apparatus is often called the **pharynx**. Its lumen in section is five-rayed, the layer of connective tissue forming five longitudinal ridges which bulge in the epithelium. It is connected, in a manner which cannot here be further described, by means of five pairs of longitudinal bands of connective tissue, with the surrounding masticatory apparatus.

The name œsophagus is generally given to the portion of the digestive tract which follows the pharynx (and, in the *Spatangoidea*, to the whole of the first portion of the intestine) as far as the point where, in regular Echinoids, there is a sac-like widening, and in the *Spatangoidea* a large cæcum. In regular Echinoidea, it includes that part of the intestine which ascends from the lantern towards the apical system, together with the first portion of the first spiral. In the *Spatangoidea* it runs back from the mouth and then bends forward, forming the commencement of the first intestinal spiral.

The œsophagus is followed by the **first intestinal spiral**, which runs in the direction of the hands of a clock. It commences with a slight sac-like swelling (regular Echinoids) or a large cæcum (*Spatangoidea*). In this part of the alimentary canal a rich system of blood lacunæ is developed in the connective tissue layer on the inner side of the otherwise weak musculature.

In the **second or reverse spiral** this lacunar network is wanting. This spiral is distinguished, more especially in the regular Echinoidea, by its peculiar colouring, being yellow, whereas the first spiral appears brown.

In regular Echinoidea, the two intestinal spirals have an elegantly undulating course, regularly ascending and descending.

The second spiral passes without any sharp boundary into the **rectum**, which, in the *Spatangoidea*, runs back from the middle of the body. At its commencement, in *Echinocardium (flavesens)* and *Schizaster*, it has a small diverticulum.

The alimentary canal of the *Spatangoidea*, which is distended with sand and mud, is thicker and its walls are firmer than in the regular Echinoidea, whose intestine usually contains, besides mud, a large number of unicellular algæ. There is a corresponding difference in the mesenteries. In the regular Echinoidea the intestine is attached by means of mesenteries practically only to the test, and these

mesenteries are broken through in such a manner as to form elegant arcades. In the *Spatangoidea*, however, the different coils of the canal are further connected together *inter se* by mesenteries which are not perforated.

Unicellular glands of various kinds are found, chiefly in the epithelium of the first section of the intestine. In the *Spatangoidea*, in the commencement of the first spiral, there are multicellular flask-shaped glands; these lie in the connective tissue layer, the neck-like duct alone opening into the lumen of the alimentary canal.

The **accessory intestine (siphon)**, which occurs in nearly all Echinoidea, deserves special attention. Near the commencement of the first spiral, the siphon branches off from the main intestine as a narrow tube, which again enters the intestine at the end of that spiral, to which it thus belongs. The siphon always runs along the inner side of the main intestine (that turned to the principal axis of the body). In regular Echinoids, it follows the main intestine in its course; in the *Clypeastroidea*, on the contrary, its course is somewhat shortened. In the *Spatangoidea*, the first part of its course is shorter than that of the main intestine, while the rest follows the coils of the latter.

The *Cidaroida* (*Dorocidaris papillata*) have no distinct siphon, but it is very probable that this organ is here represented by a longitudinal furrow bordered by two folds, which furrow is either not yet, or no longer, shut off from the lumen of the intestine. This furrow occurs in the same region of the intestine as the siphon, and also on the axial side of the canal.

In the Spatangoid genera *Brissus*, *Brissopsis*, and *Schizaster* a second siphon has been discovered, running parallel to the intestine.

The structure of the siphon resembles, in essential points, that of the main intestine. It has been conjectured that it, like the accessory intestine of certain worms, subserves intestinal respiration.

D. Crinoidea.

In this class the alimentary canal is tubular. It descends from the mouth into the calyx, coiling in the direction of the hands of a clock (when the body is viewed from the oral side). From the base of the calyx it again ascends, continuing the same curve, towards the tegmen calycis, and here enters the anal cone in the anal interradius; it then runs through the anal cone, opening outward at its tip through the anus.

During its course through the calyx, the intestine makes **one complete coil** round the principal axis (Fig. 382, B, p. 475). The alimentary canal of *Actinometra* affords a striking exception to this rule, forming, in the same direction as in other Crinoids, as many as **four coils** (Fig. 382, C). It may be remembered that *Actinometra* is also distinguished from all other Crinoids by the eccentric position of the mouth in the tegmen calycis.

The section of the intestine which lies at the bottom of the calyx

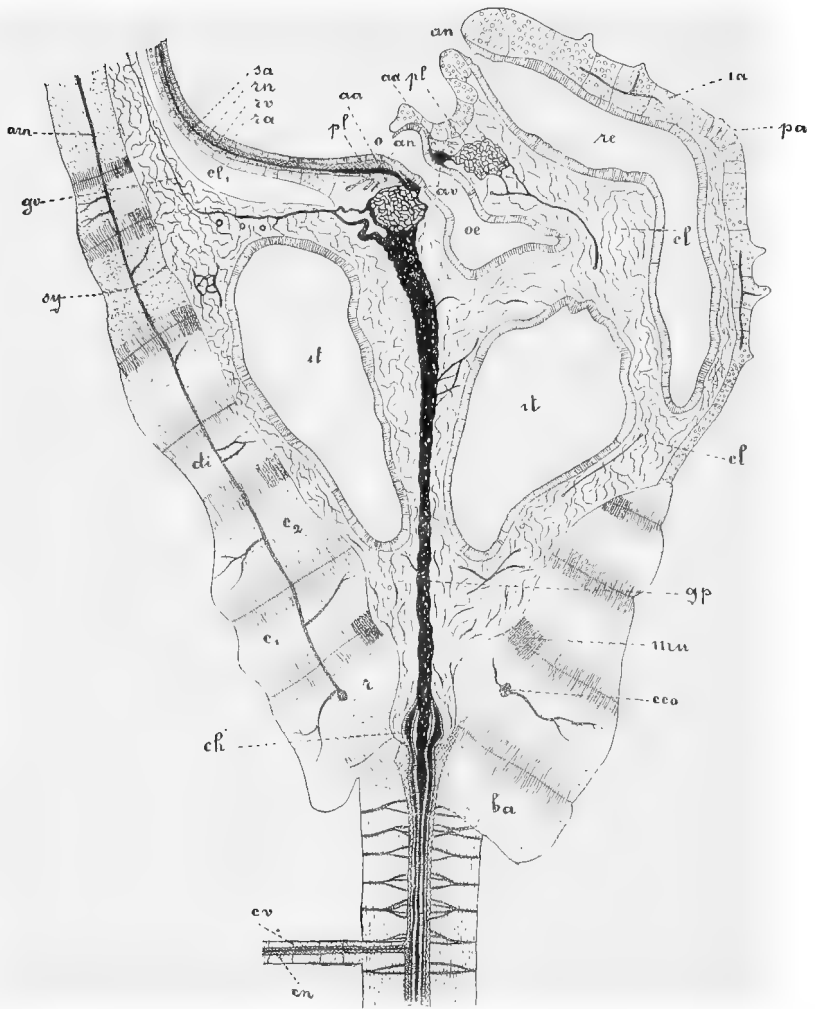

FIG. 354.—Radial-interradial section in the direction of the principal axis through the calyx of *Pentacrinus decorus* (after P. H. Carpenter), left half radial, right interradial, diagrammatic. In many respects the figure is obsolete and incorrect. The most noteworthy points are emphasised by special type in the following lettering. *sa*, Subambulacral plates; *rn*, radial nerve trunk (hatched); *re*, radial pseudohaemal canal (black); *ra*, radial canal of the water vascular system (dotted); *cl*₁, brachial coelom; *pl*, spongy organ of the blood vascular system; *av*, circular canal of the water vascular system; *o*, mouth; *an* (to the right), anus; *ar*, blood vascular ring? pseudohaemal ring?; *an* (to the left), anus; *re*, rectum; *ia*, plates of the interambulacral areas; *pa*, calyx pores; *cl*, the coelom, traversed by a spongy network; *it*, intestinal coils (cut through); *gp*, axial organ; *mu*, muscles; *eeo*, nerve commissure between the axial trunks; *ba*, basal; *cv*, cirrus canal; *cn*, cirrus nerve; *ch*, chambered sinus, with the centre of the apical nervous system; *r*, radial plate; *e*₁, *e*₂, first and second costal; *di*, distichal; *sy*, syzygial suture; *gv*, genital canal; *arn*, apical nerve trunk of the arm.

is occasionally somewhat widened, and is then called the **stomach**. In *Rhizocrinus* and *Bathycrinus* there are, on the external side of the digestive tract, interradially placed outgrowths. Similar outgrowths occur in great numbers on the inner side of the tract in *Antedon* (the side facing the axis of the calyx). Such a diverticulum, when especially large and branched, has been called a hepatic cæcum, but this name must not be accepted in any strict sense.

The finer structure of the intestine agrees in essentials with that in other Echinoderms. The intestinal epithelium is everywhere ciliated except in part of the rectum. The musculature is weakly developed or altogether wanting, except near the mouth and in the rectum, where sphincters are formed. The anal tube or cone consists of the body wall externally and of the wall of the rectum internally. Between these two the reduced body cavity is traversed by radially placed strands of connective tissue.

E. Asteroidea (Fig. 385).

That part of the oral area which is left free by the skeleton is covered by a soft **oral integument**, in the middle of which lies the **mouth**. This organ can be opened by muscles which run out from it radially in the oral integument; it can be closed by circular muscle fibres, which run round it in the oral integument and in the œsophagus.

The mouth leads into an **œsophagus**, which ascends perpendicularly, widens rapidly, and passes over without any sharp boundary into the stomachal sac.

In *Echinaster sepositus*, the œsophagus has around it ten outgrowths, whose walls are very much folded, and whose (inner) epithelium is richly supplied with glands.

The membranous **stomachal sac** of the Asteroids is very spacious, filling the whole disc. Its wall is irregularly folded, and provided with outgrowths; it is connected with the wall of the disc by means of mesenteric strands, partly of connective tissue, partly of muscle.

In the upper (apical) portion of the stomachal sac, five pairs of **brachial diverticula** open; these are the radial cæca, or hepatic appendages, which stretch more or less far into the arms, according to family, genus, or species. There is one pair in each arm. These diverticula of the stomachal sac (which, ontogenetically, develop comparatively late) have the following general structure. Each diverticulum consists of a median common tube, which runs in the longitudinal direction of the arm, giving off lateral tubes alternately to right and left. Each lateral tube receives from each side the openings of closely crowded glandular lobes, so that the secreting surface is very large.

In the *Echinasteridae* and *Asterinidae*, the common tube swells into a large sac.

At the point where the stomachal sac narrows to form the short

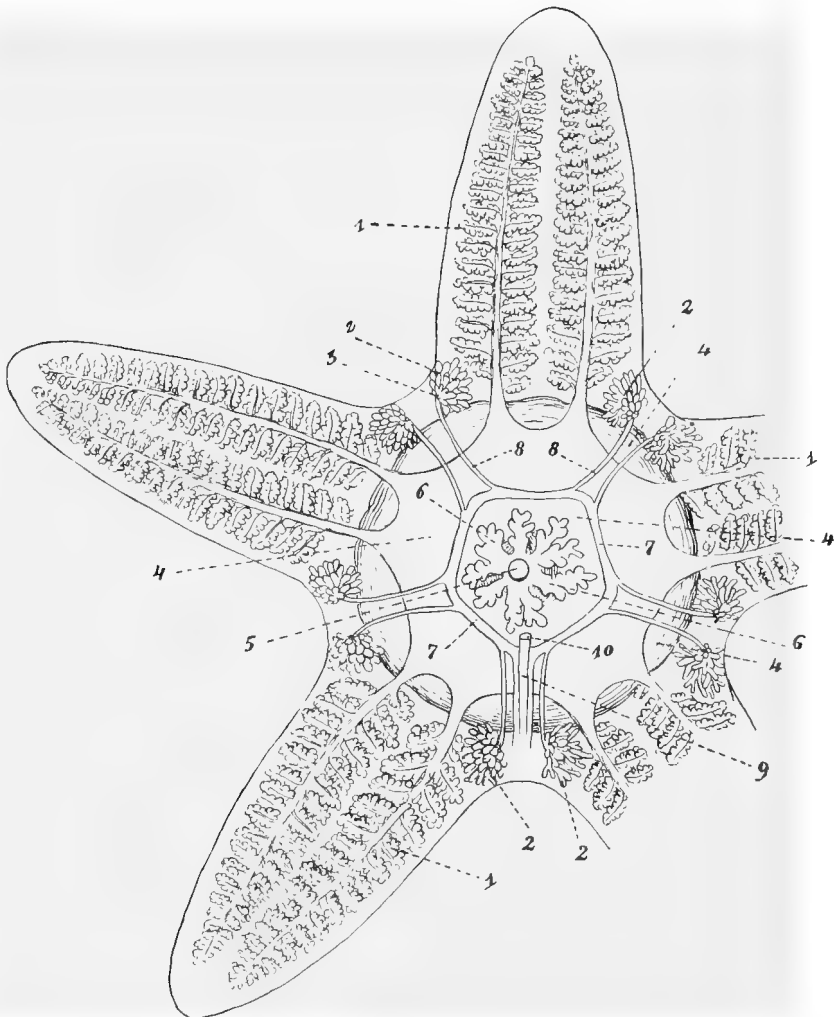

FIG. 385.—Alimentary canal and genital organs of an Asteroid, diagrammatic. 1, Brachial diverticula of the stomach; 2, gonads; 3, base of the gonad, which corresponds with its aperture; 4, stomachal sac; 5, anus; 6, rectal diverticula; 7, apical circular sinus and trunk; 8, one of the ten radial sinuses and trunks running from this latter to the gonads; 9, stone canal in the axial sinus; 10, madreporite.

rectum, *i.e.* high up in the apex of the disc, it is once more provided with diverticula. These rectal diverticula, whose number, arrange-

ment, and size are subject not only to specific and generic, but often also to individual variations, are, as a rule, much smaller than the brachial diverticula of the stomach, with which they otherwise agree in structure.

The anus is wanting only in the *Astropectinidae*. Elsewhere it lies somewhat eccentrically (never exactly at the apical pole) in the interradius which follows the madreporitic interradius (in the direction of the hands of the clock), when the disc is seen from the apical side.

Finer structure of the intestine.—The intestinal epithelium is ciliated. Glandular cells, as goblet cells, mucus cells, and granular cells, are everywhere found together with epithelial cells. The last named appear to secrete especially the digestive ferment; they preponderate at the commencement and terminal part of the canal, and are particularly numerous in the brachial and rectal diverticula. The muscle layer is well developed in the œsophagus, the rectum and the rectal diverticula, less strong in the stomach, and wanting in the brachial diverticula.

The manner in which the brachial diverticula are suspended to the apical brachial wall has already been described (p. 440).

The Asteroidea are carnivorous, feeding on other marine animals, especially Bivalves and Gastropods. When feeding, they evaginate the greater part of the stomach out of the oral aperture, enveloping their prey with it. The secretion of the mucus cells yielded during the process appears to be poisonous and to have a decomposing action. The animals attacked quickly die, and are passed on to the part of the stomach still remaining within the disc, where they undergo the digesting action of the secretion yielded by the granular glands (Körnerdrüsen).

The evagination of the stomach is brought about by the musculature of the disc, and its withdrawal by the (partially) muscular mesenterial bands which attach it to the body wall.

The anal aperture certainly does not serve for the ejection of all the faecal masses. It is impossible that large masses, such as the shells of Bivalves and Gastropods, which are found in the stomachs of Asteroids, can be ejected through such a narrow aperture; they are no doubt passed out again through the mouth.

F. Ophiuroidea (Figs. 386 and 388, p. 494).

The condition of the alimentary canal in this class is simpler than in any of the others. The somewhat spacious buccal cavity which is surrounded by the oral skeleton leads into the digestive sac which fills the body cavity of the disc, in so far as it is not occupied by the bursæ. An anus is wanting. Special intestinal appendages in any way corresponding with the brachial or rectal diverticula of the *Asteroids* are wanting.

XV. Respiratory Organs.

There are no respiratory organs which are homologous throughout the whole phylum of the Echinodermata. Portions of the body belonging to very different organs and systems of organs are function-

ally modified for the purpose of respiration. All these respiratory organs (except the respiratory trees of the Holothurioidea) are described

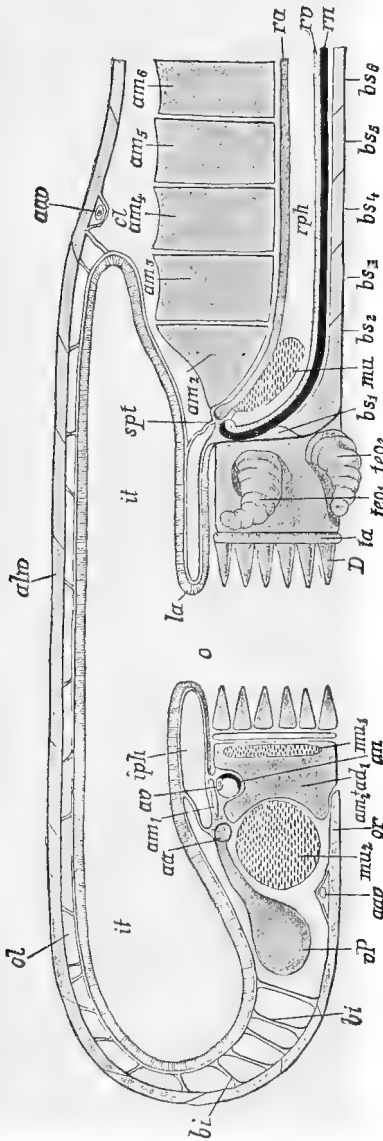

FIG. 380.—Radial-interradial section through the disc and the base of the arm of an Ophiurid, in the direction of the principal axis. Left half interradial, right half radial (after Ludwig). *mu, mu₁, mu₂*, Muscles of the oral skeleton; *an* (black), nerve ring; *am₂ + ad₁*, oral-angle plates; *or*, oral=ventral wall of the disc; *av*, apical circular sinus with ring-like strand (cf. Fig. 390). *vP*, Polian vesicle; *bi*, mesenterial filaments between the stomachal sac and the wall of the disc; *cl*, cœlum; *aw*, apical wall of the disc; *ra*, radial canal of the water vascular system; *rph*, radial pseudohæmal canal; *rv*, continuation of the axial organ in the arm (?), radial blood vessel (?); *rn*, radial nerve trunk of the oral system; *bs₁ - bs₆*, first to sixth ventral shield; *teo₁* and *teo₂*, first and second oral tentacles; *ta*, torus angularis; *D*, teeth; *o*, buccal cavity; *la*, entrance to the stomachal sac; *iph*, peripharyngeal sinus; *am₁*, peristomal plates; *am*, water vascular ring; *st*, stomachal sac; *am₂ - am₆*, second to sixth brachial vertebral ossicles; *spt*, septum between the body cavity and the peripharyngeal sinus.

in connection with the systems of organs to which they belong. A review of these organs will be found below.

A. The (inner) Respiratory Trees of the Holothurioidea (Figs. 371 and 383, pp. 451 and 477).

These organs, which are known as **water lungs** or **respiratory trees**, occur as two tree-like delicate-walled branched canals or tubes, which lie to the right and left in the body cavity, their principal trunks opening posteriorly into the anterior part of the cloaca. They open either separately or through a common terminal portion. The last branches of the respiratory trees end in vesicular widenings, similar "ampullæ" being found also along the branches themselves. When well developed, the respiratory trees reach far forward into the body cavity, being attached at various points by muscle fibres or filaments of connective tissue to adjacent organs, *i.e.* to the body wall, the alimentary canal, the pharynx, and the mesenteries. In many *Aspidochirote* the left respiratory tree is associated with the rete mirabile of the blood vascular system in the way described on p. 452. The delicate wall of the organ consists of an inner ciliated epithelium, a thin layer of connective tissue, a muscle layer (in which an inner layer of longitudinal fibres and an outer layer of circular fibres can be more or less distinctly made out), and, finally, of the ciliated endothelium of the body cavity.

There can be no doubt that the respiratory trees actually function as respiratory organs. At regular intervals water flows into them from the cloaca, and is from time to time expelled through the anus, discoloured by the admixture of fæcal masses.

Respiratory trees are wanting in all *Paractinopoda* (*Synaptidæ*), the *Pelagothuriidæ*, and the *Elasipoda*, unless, in the last-named family, the diverticulum of the rectum described in the section on the alimentary canal, p. 478, represents a rudimentary lung.

B. Review of the Respiratory Organs of the Echinodermata.

(a) **Holothurioidea Actinopoda** (excluding *Elasipoda* and *Pelagothuriidæ*).

1. The **respiratory trees**, which open into the cloaca.
2. The **oral tentacles**, and to some extent the delicate-walled ambulacral tentacles as well.

(b) **Holothurioidea, Paractinopoda and Pelagothuriidæ.**

The whole of the **body wall** and the **oral tentacles**. Respiration is promoted by the circulation of the body fluid, kept up by means of the ciliated urns.

(c) **Echinoidea.**

1. The **external gills**, as outgrowths of the peripharyngeal sinus, p. 442.
2. The **ambulacral feet**, especially those on the apical surface of

the body, and more particularly the branchial tentacles on the petaloids, *cf.* p. 433.

3. The **accessory intestine**, in which, at least in regular Echinoids, a streaming of water takes place which does not interfere with the digestive processes going on in the principal intestine, *cf.* p. 481.

(*d*) **Asteroidea.**

1. The **papulæ**, *cf.* p. 439.
2. The **ambulacral feet**.

(*e*) **Ophiuroidea.**

1. The **bursæ** (respiratory and genital chambers).
2. The **ambulacral tentacles**.

(*f*) **Crinoidea.**

1. The **ambulacral tentacles**.
2. The **anal tube** (anal cone), which alternately takes in and gives out water.

XVI. The Cuvierian Organs of the Holothurioidea (Fig. 383, 22, p. 477).

In certain Holothurioidea, peculiar accessory structures are found connected with the terminal portion of the respiratory trees; these are known as the **Cuvierian organs**. They occur chiefly in the *Aspidochirote* (especially in the genera *Holothuria* and *Mulleria*); in other Holothurioidea they only occur in isolated cases (*Molpadia chilensis*, *Cucunaria frondosa*). The Cuvierian organs are usually very numerous, even as many as a hundred occurring in some of the species provided with them. Although, as already mentioned, they are usually found in the terminal portion of the respiratory trees, they may shift higher up the principal trunk, and may even pass over on to the branches.

It is not improbable that they represent morphologically transformed branches of these trees, the structure of their walls agreeing in general plan with that of these latter.

Two kinds of Cuvierian organs are distinguished—(1) glandular, and (2) non-glandular.

The Cuvierian organs of the **glandular** kind are long tubes, the very narrow axial canals of which open into the terminal section of the respiratory tree. Each of these axial canals has a spiral course, and is lined by a unilaminar epithelium. This epithelium is followed externally by a very thick layer of connective tissue, which projects into the axial canal in the form of a spiral fold. The next layer consists (1) of isolated circular muscle fibres, and (2) of external longitudinal muscle fibres gathered into small bundles. Outside of the muscle layer there is another layer of connective tissue, which, on the side of the body cavity, is covered by a peculiarly developed glandular layer; this no doubt represents the modified endothelium of the body cavity.

In this glandular layer the cells can no longer be recognised except by their nuclei, no boundaries being distinguishable. The layer is closely packed with secreted granules. Wandering cells and calcareous corpuscles are found in the connective tissue wall.

The animal, when irritated, vehemently ejects its Cuvierian organs through the cloaca. (The susceptibility to irritation which leads to such ejection varies greatly in different forms.) In this process the tubes are not turned inside out, but are thrown out complete, just as they are in the body cavity, probably through a rent in the cloacal wall. When these tubes are thus thrown out, water is almost certainly pressed out of the respiratory trees into their axial canals. The discharged Cuvierian organs are remarkable (1) for their **extreme viscosity**; (2) for their **extraordinary extensibility**. They can be drawn out to more than thirty times their ordinary length. Their viscosity is no doubt produced by the secreted granules of the glandular layer. In consequence of these peculiarities, the discharged Cuvierian organs are weapons of defence; they remain attached to the body of an enemy, and impede its movements. They may also be weapons of attack, the prey being caught and held fast till it dies, when its decomposing remains serve for food.

The **non-glandular** Cuvierian organs are either tubular, like the glandular, or branched. They are mostly beset with stalked vesicles. The smooth endothelium of the body cavity which covers them shows no glandular development of any sort. The part played by these non-glandular and consequently non-viscid organs is entirely problematical.

XVII. Excretion.

Special excretory organs are altogether wanting throughout the Echinodermata. It is probable that fluid excrement is osmotically given off, together with the carbonic acid, at the respiratory surfaces of the body. Further, coloured and occasionally crystalline corpuscles, which are met with in very different parts of the body, chiefly in the connective tissue layers in most Echinoderms, have been regarded as products of excretion. They appear to remain in the places of their formation, this conclusion being arrived at from the fact that they are present in far greater quantities in old than in young animals. They are also found within the wandering cells, and it might be worth investigation whether these wandering cells, which force their way into the body- and the intestinal-epithelium, do not play some part in excretion.

XVIII. The Sacculi of the Crinoidea.

These are peculiar organs which, in certain Crinoids, occur in great numbers below the integument, principally at the edge of the food grooves of the pinnulæ, the arms, and the disc, less frequently elsewhere (intestinal wall, mesenteries). They are globular sacs lying close below the surface, but having no outer aperture, and are closely packed with strongly refractive spherules, which, during life, are colourless, but turn red after death. Close examination shows that

these spherules are enclosed, at least at first, in cells, each of which has a nucleus lying in the base, which is turned away from the surface. These are regarded as connective tissue cells.

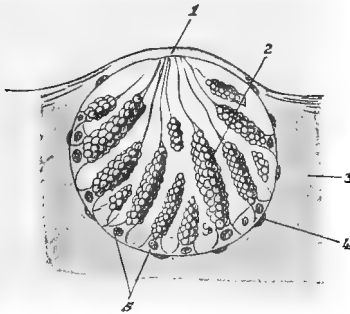

FIG. 387.—Diagram of a sacculus. 1, Superficial layer of integument passing over the sacculus; 2, granular masses within special cells; 5, the nuclei of these cells; 4, nuclei of the surrounding cutis (3).

According to recent ontogenetic research, each individual spherule is the metamorphosed product of a mesenchyme cell, and the sacculi on their first appearance are said to be nests of such cells.

Sacculi are specially numerous in all species of *Antedon*, but are also found in *Eudicrinus*, *Promachocrinus*, *Pentacrinus*, *Rhizocrinus*, *Bathocrinus*. They are wanting in *Actinometra*, *Thaumatocrinus*, and *Holopus*. Their significance has not been discovered. They have been regarded by various authors as calcareous glands, excretory organs, groups of unicellular algæ, and slime glands, but, according to the most recent opinion, they are proteid corpuscles, deposited in the connective tissue cells as reserve stuff, to be used as occasion requires, for the regeneration of broken-off arms or of the viscera.

In other Echinoderms the contents of wandering cells (especially of those cells which are massed together below the surface of the Holothurian integument) have also been claimed as reserves of nutrition.

XIX. Genital Organs.

A. General Morphology.

With rare exceptions, which will be dealt with separately, the sexes are separate in Echinoderms.

The genital organs are throughout distinguished by great simplicity, as evidenced by:—

1. The entire absence of every kind of copulatory organ. The sexual products are ejected from the body, and fertilisation takes place in the water (except in cases of care of the brood to be mentioned later).

2. The entire absence of accessory glands, of widenings or outgrowths of the ducts, and of complicated adaptations for the nourishment of the ripening sexual products.

The genital organs consist of variously shaped tubes, within which the spermatozoa or eggs ripen, and from which they are discharged through simple efferent ducts.

These gonadial tubes lie in any part of the body cavity; in the most complicated cases their wall consists, from without inward, of (1) the endothelium of the body cavity; (2) a thin muscle layer;

(3) a layer of connective tissue; and (4) the inner germinal epithelium. The muscle layer is often wanting.

According to the morphology of the genital organs the Echinoderms fall into two groups.

In the **larger principal group**, containing the *Echinoidea*, *Asteroidea*, *Ophiuroidea*, and *Crinoidea*, there are several gonads, each with a duct and an aperture; they follow, in their arrangement, the radial structure of the body, showing at the same time close relations to the axial organ (or to the wall of the axial sinus). The axial organ has been compared to a trunk, of which the gonads, as direct prolongations, are the fruitful branches, on which the sexual products ripen, as fruit.

The direct organic connection between the axial organ and the gonads persists throughout life in the *Asteroidea*, *Ophiuroidea*, and perhaps also in the *Crinoidea*; in the *Echinoidea* it is only ontogenetic, and ceases in the adult.

The **second group** is formed by the *Holothurioidea*, in which there is neither axial organ nor axial sinus. The genital organs consist of a single tuft of gonadial tubes. This tuft lies in the body cavity in the median (dorsal) interradius, and sends off a duct which runs forward in the dorsal mesentery, and opens outward in the anterior region of the body, often very near the mouth.

There is, as a rule, no difference in the microscopic structure and external appearance of the male and female genital organs in Echinoderms. In some cases, however, at the time of maturity, they may be distinguished by their different colouring.

Secondary sexual characters have been noticed only in very rare cases.

B. *Holothurioidea* (Figs. 371 and 383, pp. 451 and 477).

In all *Holothurioidea*, the gonads are developed as a single tuft of genital tubes, lying in the dorsal interradius. All the tubes of the tuft converge towards one point, and open into the base of the gonad, which lies in the dorsal mesentery, and is often somewhat widened for the reception of the sexual products.

The gonadial tubes are either simple or branched; in number and size they vary within pretty wide limits according to the species and the stage of maturity attained. They may exceed the body in length. They usually hang from the base of the gonad, on the two sides of the mesentery, into the body cavity, but there are cases in which they are developed only on one side—the left—of the mesentery (in *Holothuria*, *Mülleria*, *Labiodemas* among the *Aspidochirotae*, and in many *Elpidiidae*). The base of the gonad lies in the anterior half of the body, often very near its anterior end (especially in *Synaptidae* and *Molpadidae*, but also in many *Aspidochirotae* and *Dendrochirotae*).

From the base of the gonad the **genital duct** runs more or less

far forward in the dorsal mesentery, to pass through the body wall at some point of the anterior half of the body in the dorsal median line, and to open outward through the usually single genital aperture.

The distance of this aperture from the extreme anterior end of the body, however, varies very greatly. It is greatest in the *Elasipoda*, and becomes smaller in the *Aspidochirota*. In the *Molpadiida* and *Synaptida* the genital aperture lies immediately behind the circle of tentacles, and in the *Dendrochirota* it shifts into that circle, even reaching its inner side. It is found behind the middle of the body only in *Psychropotes longicauda*.

The genital aperture is usually inconspicuous. Occasionally it is found on the tip of a genital papilla; in species of the genera *Thyone* and *Cucumaria*, this is the case only in males, a slight sexual dimorphism thus arising.

The occurrence of several genital apertures (2, 4, 8, 16 in certain *Elasipoda*) is quite exceptional. They always belong to one and the same gonad, and to one genital duct. This latter in such cases, before emerging, divides dichotomously into as many branches as there are apertures.

C. Asteroidea (Fig. 385, p. 484).

The genital organs are here developed as five pairs of bundles of gonadial tubes, or as five pairs of rows of such bundles. These project freely into the body cavity; their bases are attached to the apical (dorsal) body wall, generally at the apical edge of the supramarginal plates, or on a level with this edge. Exactly over the point of attachment, *i.e.* over the base of each gonadial tuft, the efferent duct traverses the body wall (between two neighbouring skeletal plates) to open outward at the surface through one, less frequently through several, genital apertures. These apertures are quite small, and are often only clearly visible at the season of sexual maturity, when the genital products are ejected.

The bases of all the gonadial bundles are still connected with the axial organ even in the adult (*cf.* p. 445 on the axial organ and the axial sinus). The axial organ is continued along the inner apical (dorsal) body wall (that turned to the cœlom) as a **pentagonal strand running round the apical pole and the anus**, which agrees in structure with the organ itself. At each of the five interradially placed corners of the ring it sends off a pair of strands which run peripherally. **There are thus in all five pairs of strands radiating from the ring; these run to the bases of the five pairs of gonadial tufts**, and where these are in rows, from tuft to tuft of each row, connecting their bases.

Just as the axial organ is surrounded by the axial sinus, so are all its derivatives surrounded by a cœlomic sinus, a direct prolongation of the former.

The aboral ring-like strand lies in a **ring-sinus**, attached to its wall by a suspensory band. This sinus is also continued along the five pairs of strands which radiate from the ring-like strand; when it

reaches the bases of the gonads it is further continued along all the individual tubes to their tips. The gonadial tubes thus have a double wall—first, their own wall, which is a continuation of that of the outgrowths from the axial organ; and secondly, an outer wall, which is a continuation of the wall of the axial sinus. Between these two walls lies the narrow cœlomic sinus, which is in open communication by means of the sinuses of the genital strands, with the ring sinus, and through this latter with the axial sinus.

The relations existing between the gonads, the axial organ, and the system of sinuses, is clearly elucidated by the ontogeny of the Asteroidea, which shows that in quite young animals the axial organ grows out apically, and first forms the ring strand. Out of this the genital strands bud, and from these latter again the bundles of gonadial tubes arise, which are at first solid outgrowths, and only become hollow secondarily. During this whole process the growing axial strand, which finally produces the rudiments of the gonads, continually carries the axial sinus along with it, so that the ring-like strand, the genital strand, and the genital tubes are entirely surrounded by a sinus, which constantly remains in open communication with the axial sinus.

At those points of the genital strands from which the gonadial bundles bud, *i.e.* at the future bases of the gonads, the duct which perforates the body wall is formed from within at a later stage.

The form of the individual gonadial bundles requires little notice. The genital tubes of which each bundle is composed are usually not long, sometimes they resemble short sacs and are vesicular, they are rarely branched.

Of much greater interest are the number and arrangement of these bundles.

In the simplest cases, five pairs of gonadial bundles are present; this is the case, as far as examination of the various species on this point has taken place, in the following families: the *Asterinidae*, *Solasteridae*, *Echinasteridae*, *Linckiidae*, *Asteriidae*. In these, the five pairs either lie in the disc, one bundle at each side of each interradius, or have shifted into the bases of the arms (*Echinasteridae*, *Linckiidae*). More than five pairs of gonads are found in the families of the *Astropectinidae*, *Pentacerotidae*, and *Gymnasteriidae*. They either lie in the disc in rows at the sides of the interradii, or the five pairs of rows stretch into the arms. This last arrangement is found in the most extreme form in *Luidia*, where, on each side of each arm, a row of nine runs to near its tip, one or two pairs occurring on each skeletal segment.

In all cases, each bundle has its separate genital aperture.

As a rule, each bundle has only one aperture, but it sometimes happens (*Asterias*, *Solaster*) that the duct which traverses the apical body wall branches, and opens through several genital pores lying near one another.

Asterina gibbosa is an exception to the rule that the genital apertures lie on the apical side of the disc or arms. The apertures here lie on the oral side, a peculiarity connected with the fact that these Asteroids do not simply eject their eggs into the water, but attach them in combs or plates to stones, etc.

It must, finally, be noted that the aboral ring sinus is not always simple, but may break up into a circular network of sinuses (*e.g.* *Echinaster sepositus*).

D. Ophiuroidea.

In structure and development the genital organs in this class strongly resemble those of the *Asteroidea*. The gonad is connected with the axial organ by means of an aboral ring-like strand, and both the gonads and this strand are surrounded by cœlomic sinuses, which communicate with the axial sinus.

The only important difference in the genital organs of the two classes is caused by the fact that, in the Ophiuroidea, the gonads do not open outward directly, but by means of five pairs of large sac-like

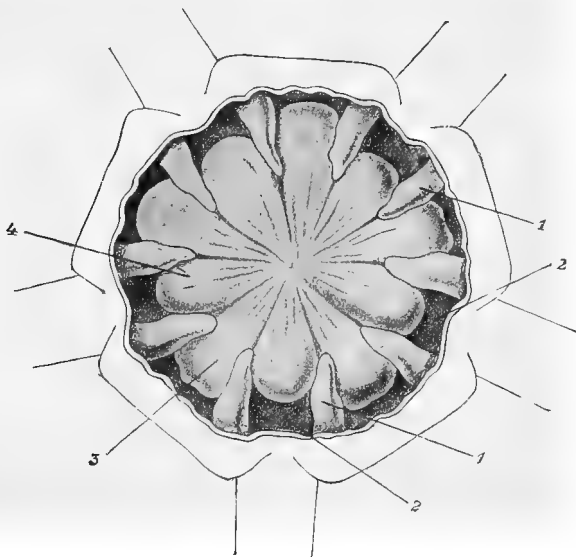

FIG. 388.—Stomach and bursæ of a young *Ophioglypha albida*, in its natural position in the disc, the dorsal wall of which is removed. 1, Bursæ; 2, cavity of the disc; 3, interradial; 4, radial bulgings of the digestive sac (after Ludwig).

invaginations of the body wall into the cœlom of the disc, these sacs themselves communicating with the exterior through five pairs of slit-like apertures lying at the sides of the bases of the arms on the lower (oral) side of the disc. These sac-like invaginations of the body wall are the **bursæ** or **bursal pockets**, their outer slit-like apertures being known as the bursal (genital) apertures, which have already been mentioned (Figs. 245, 246, and 314, pp. 300, 301, and 359).

1. The Bursæ (Figs. 388 and 389).

These are large sacs within walls, which fill up the body cavity of the disc round the digestive sac. Their walls are attached to that of

the digestive sac and the apical body wall by means of strands of connective tissue, and consist of the same layers as the body wall, though in the bursæ these layers are much thinner. Calcareous corpuscles may be either present or wanting in the connective tissue. The inner epithelium of the bursæ is in some parts strongly ciliated.

The outer apertures of the bursæ lie at the sides of the proximal portions of the arms, which are included in the disc. Each bursa has, as a rule, one aperture, but in the genus *Ophiura* (formerly *Ophioderma*) there are two apertures on each side of the base of an arm, one distal and the other proximal. Both these apertures, however, lead into one and the same bursa, and the double aperture (in *Ophiura*) can be deduced from the ordinary single aperture by assuming that the margins of the latter fuse at about the middle of their length.

The gonads are attached to the wall of the bursa, on the side turned to the body cavity (Figs. 391 and 392). The sexual products pass into the bursa, and are ejected thence through the aperture. This is, however, only one of the functions of the bursa, and, in most Ophiuroidea, as it appears, not the principal function.

The bursæ have a more important function as respiratory organs. Sea-water can enter them, and through their thin walls exchange of gases can take place between it and the body fluid. It would be interesting if it could be proved that, as in the mouth and œsophagus of the Corals, the sea-water enters through one (more or less proximal) part of the bursal aperture, and flows out again through another (more distal) part. The proximal aperture of each bursa in *Ophiura* is perhaps an inhalent, and the distal an exhalent aperture.

In certain Ophiuroidea (e.g. *Amphiura squamata*, *magellanica*, *Ophiacantha vivipara*, *marsupialis*, *Ophioglypha hexactis*, *Ophiomyxa vivipara*, etc.), the bursæ serve as brood chambers. The eggs pass through their whole development in them, until all the organs of the young Ophiurid are formed.

2. The Genital Apparatus (Figs. 390-393).

The most interesting point in connection with the genital apparatus is the peculiar course of the apical ring sinus with the ring-like strand

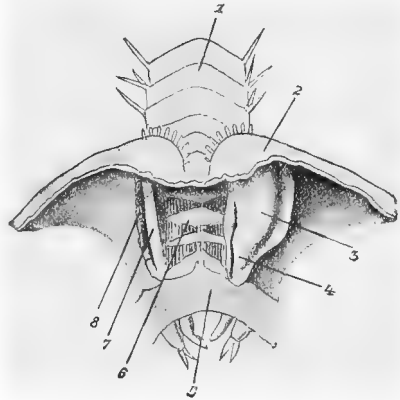

FIG. 389.—Part of a preparation of *Ophioglypha* similar to that in Fig. 388, after removal of the stomach and the gonads (after Ludwig). Of the two bursæ, that on the left has been removed. 1, Dorsal shields of the arm; 2, dorsal wall of the disc; 3, bursa with its tip (4); 5, peristome; 6, vertebral ossicle in the base of the arm; 7, genital plate; 8, row of bursal plates or scales.

it contains. Fig. 390, which represents the ring sinus in horizontal projection, illustrates its course in five outwardly directed radial and five

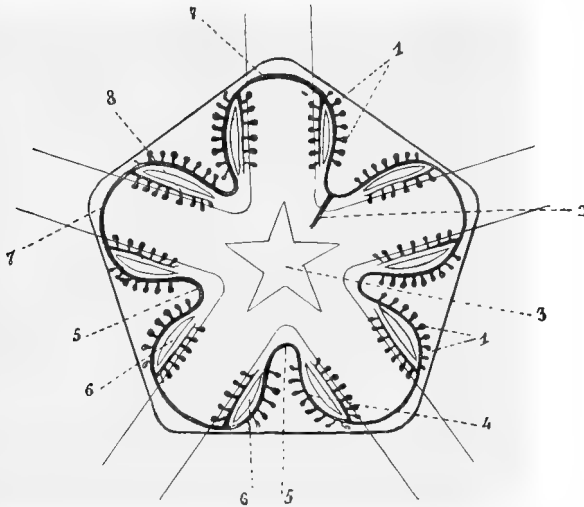

FIG. 390.—Course of the aboral circular sinus, with the ring-like strand contained in it in the Ophiuroidea (diagram after Ludwig). 1, Gonads; 2, axial sinus with axial organ; 3, mouth; 4, circular sinus with ring-like strand, on the side of the bursal wall turned to the interradius; 5, interradial portion of the ring sinus and strand, bent downwards orally (Fig. 386, left *aav*); 6, bursal aperture; 7, radial (apical) region of the ring sinus (Fig. 386, right *aav*); 8, lateral branches of the same on the bursal wall turned to the radius.

inwardly, *i.e.* orally directed interradial curves. In this undulating course the ring sinus descends on the inner wall of the disc alternately from the apical to the oral side, and then again ascends to the apical side, the radial curves lying apically and the interradial (those near the bursæ) orally.

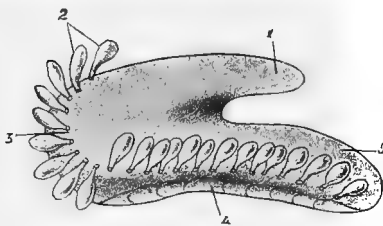

FIG. 391.—Bursa of Ophioglypha, seen from the side turned towards the interradius (diagram after Ludwig). 1, The tip of the bursa, lying on the dorsal side of the digestive sac; 2, the gonads sessile on the bursal wall; 3, distal portion of a bursa (that turned to the periphery of the disc); 5, proximal portion of the same (that turned to the centre of the disc); 4, the rows of bursal scales along the aperture.

in the oral direction (in the first place this could of course only apply to the madreporitic interradius), or whether, on the contrary, the ring sinus, shifting orally, drew

This peculiar course is no doubt connected (1) with the orally directed course of the axial sinus, the axial organ, and the stone canal which opens outward orally through its madreporite (Fig. 361, 6, p. 422). For the ring sinus is the continuation of the axial sinus, and the ring-like strand is the continuation of the axial strand. It is now impossible to determine whether the axial sinus and the axial organ, in bending orally, drew the ring sinus interradially

the axial sinus, etc. with it downwards; *i.e.*, it is impossible to decide which organ took the lead in shifting. (2) As the gonads which bud from the ring-like strand open into the bursæ, which latter, however, open outward orally, it is to some extent explicable why the ring-like strand descends interradially to the bursæ.

The whole problem is still further complicated by the questions: (1) What was the original function of the bursæ? (2) Is the ventral position of the bursæ the primitive position? (3) Is the opening of the gonads into the bursæ a recent specialisation in the Ophiuroidea?

The curved-in portion of the ring-like strand (with the sinus enclosing it) runs along that side of each bursa which is turned to the interradius. It, however, gives off a branch to the wall which is turned towards the radius (of the arm), this branch running along this wall from its periphery to its proximal part. Both walls of the bursa, therefore,

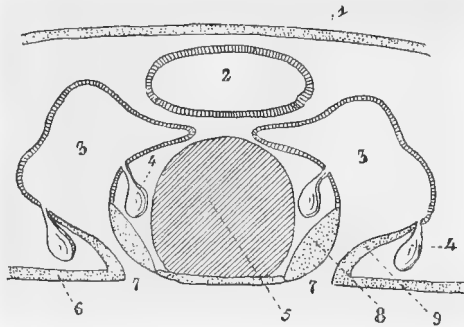

FIG. 392.—Transverse section through the disc of an Ophiurid (*Ophioglypha*) at the base of an arm (after Ludwig). 1, Dorsal wall of the disc; 2, bulging of the digestive sac; 3, bursa; 4, gonad on the bursal wall; 5, base of the arm; 6, ventral wall of the disc; 7, bursal aperture; 8, genital plate; 9, bursal scale.

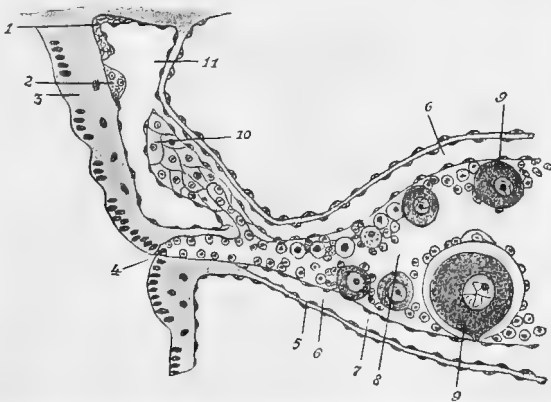

FIG. 393.—Section through an ovary of an Ophiurid (*Ophioglypha lacertosa*) (after Cuénot). 1, Muscle trunk, cut through transversely; 2, nerve ring; 3, bursal wall; 4, aperture of the ovary into the bursa; 5, wall of the genital sinus; 6, genital sinus; 7, the endothelium of the genital sinus, which covers the gonadial wall; 8, cavity of the gonad; 9, eggs in a more mature condition than the rest; 10, ring-like strand in the aboral ring sinus (11).

the abradial wall, *i.e.* that turned to the interradius, and the adradial wall, *i.e.* that turned to the arm, have a genital strand. The abradial genital strand of each bursa is merely a part of the apical ring strand, while the adradial is a lateral branch of that strand. These

five pairs of adradial genital strands recall the five pairs of genital strands of the *Asteroidea*.

The gonadial tubes are sessile upon the genital strands of the bursæ, and project freely into the body cavity of the disc. These gonadial tubes are either single pear-shaped tubes, great numbers of which are arranged in rows along the genital strands, or they are collected into tufts, and then there is one tuft on the adradial and one on the abradial wall of the bursa.

In the former case (*e.g.* *Ophioglypha*, *Ophiomyxa*, *Ophiocoma*) the two rows of genital tubes (the adradial and the abradial) stand rather low down on the wall of the bursa, near its aperture, almost parallel with the edges of the latter. Each genital tube has its special aperture into the bursa.

In the second case, the points of insertion of the two tufts of gonads within the ventral region of the bursal wall, *i.e.* the position of the bases of the gonads, seems to vary greatly, and each tuft appears to have only one aperture into the bursa (*Ophiopholis*, *Ophiotrix*).

It is still an open question whether the genital apertures are constant in adult Ophiurids, or whether they only break through into the bursal cavity at the time of maturity.

The gonadial tufts arise as originally solid buds from the genital strands, and, while forming, bulge out the wall of the sinus which contains the strand; the tubes are thus here also surrounded by a genital sinus, which communicates with the ring sinus, and through it with the axial sinus (Fig. 393).

The ring-like strand is attached by a thick band to the wall of the ring sinus. It is solid, and consists of two kinds of cells: (1) cells which entirely resemble those of the axial organ, of which the ring-like strand is a prolongation; (2) enclosed in these cells, there is a strand of cells proved to be genital germ cells (*rachis genitalis*). The cells of the former kind progressively decrease in number, and those of the second kind increase in number the nearer the ring-like strand approaches the gonads. The former are not even continued into the gonadial tubes, while the latter kind yield the germinal cell material of the gonads. It is very probable that, after the sexual products have been ejected, a new formation of germinal cell material takes place, by some kind of forward movement, from the *rachis genitalis*.

The development of the genital system from the axial organ and the axial sinus proceeds in the same manner as in the *Asteroidea*.

Ophiactis virens, a form distinguished by reproduction by means of fission, and by the peculiar arrangement of the appendages of the water vascular system, is the only Ophiurid in which the bursæ are altogether wanting. The gonads open direct outward on the oral side.

E. Echinoidea (Figs. 358 and 370, pp. 419 and 443).

Although the genital system of the Echinoidea appears to resemble in its development that of the *Asteroidea* and the *Ophiuroidea* (a point on which, however, further research is desirable), marked deviation takes place in the adults.

The gonads, at least in regular Echinoids, are five in number, and

lie in the apical region of the body cavity, in the interambulacra. The five genital ducts ascend towards the apex, there perforate a cœlomic circular sinus which surrounds the rectum, pass through the genital pores of the basals, and then open outward, sometimes at the tips of projecting papillæ.

The gonads.—These, in a mature condition, are large acinose organs, which are suspended to the inner wall of the test by an exactly interradiar principal suspensor, and by various other bands of connective tissue. **They are not surrounded by a genital sinus.**

The number of gonads was originally five. Five are found in all the regular Echinoids (*Cidaroida* and *Diadematoïda*), and also in many *Clypeastroïda*.

In the *Spatangoida*, the *Holactypoida*, and many *Clypeastroïda*, the number is reduced, the posterior unpaired gonad with the genital pore belonging to it being the first to disappear. In the *Spatangoida*, the reduction may go still further, the right anterior, and in a few cases the left anterior as well, disappearing (Fig. 394).

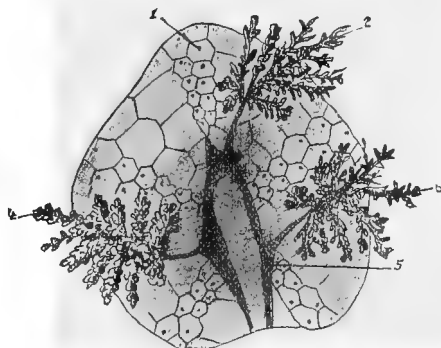

FIG. 394.—*Cystechinus vesica* A. Ag. Apical portion of the test from within, with the three gonads. 1, Anterior ambulacrum; 2, left anterior; 3, left posterior; 4, right posterior gonad; 5, circular sinus (after A. Agassiz).

Further details on this point are to be found in the section on the skeletal system (*cf.* pp. 321-324 on the genital pores). It is there shown that these pores are by no means necessarily limited to the basals.

The genital apertures.—The genital papillæ, on the tips of which the genital apertures lie, are specially well developed in the *Spatangoida*.

The **ring sinus** encircles the anus with the periproctal sinuses, the stone canal, and the axial sinus. Its wall is formed on the one side by the test, and on the other by a circular lamella of connective tissue which is covered on both surfaces by endothelium, on the apical surface by that of the ring sinus, and on the oral by that of the general body cavity.

The lower wall of the apical ring sinus is broken through in *Dorocidaris*, so that the circular sinus is here in open communication with the general body cavity.

In all other cases, the ring sinus is entirely closed on all sides in adult Echinoids.

In adults, there is no trace of a ring-like strand enclosed in the ring sinus. The connection between the axial organ and the gonads is thus lost.

F. Crinoidea (Fig. 395).

In the Crinoids, a genital strand runs through the arms, branching with them, and entering into their last ramifications—the pinnulæ. While this genital strand, which is to be found even below the food grooves of the tegmen calycis, remains as a rule infertile in the calyx

and in the arms, in the pinnulæ the germinal cells which it contains give rise to the genital cells. The genital strand in the pinnulæ becomes a gonadial tube.

On the position of the genital strand *cf.* p. 414 and Fig. 356. It runs between the three brachial sinuses of the body cavity (between the dorsal canal and the two ventral canals), below the food grooves of the arms.

It is contained in a special cœlomic sinus (like the ring-like strand and the genital strands of the *Asteroidea* and the *Ophiuroidea*), to the wall of which it is attached by filaments of connective tissue.

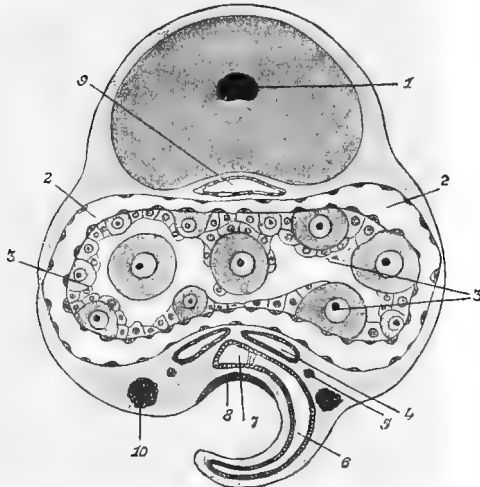

FIG. 395.—Transverse section through an ovarian pinnule of a Crinoid, diagrammatic. 1, nerve trunk of the apical nervous system in the joint of the pinnula; 2, genital sinus; 3, germinal epithelium of the gonadial rachis (genital strand or tube); 4 and 9, sinuses of the brachial cœlum; 5, deeper longitudinal nerves of the pinnula; 6, tentacle canal; 7, radial canal of the water vascular system; 8, nerve ridge of the superficial oral system; 10, sacculus, see p. 490.

The cœlomic sinus is continued on to the gonadial tubes of the pinnulæ and there becomes the genital sinus.

The genital strand is at first solid, but at a later stage becomes a hollow genital tube. This genital tube widens in the pinnulæ into the gonadial tube, which, in mature pinnulæ, is filled either with eggs or spermatozoa, these having their origin in the cells of the wall of the gonadial tubes (the germinal epithelium).

In a transverse section of the genital tubes of the arms, the wall appears thickened at one part. This thickening is the section of a ridge whose cells seem to correspond with those of the germinal epithelium of the gonadial tubes.

It is very probable also, that after the ejection of the sexual products from the pinnulæ in Crinoids, the new formations of these products proceed from the germinal cells, which are pushed forward out of the ridge of the genital tube into the pinnulæ.

That the cells of the genital ridge (and, indeed, originally all the cells of the genital strand) are germinal cells is further proved by the fact that, in exceptional cases, gonads may develop in the arms also, and even under the ambulacral furrows of the calyx (*e.g.* in individuals of the species *Antedon* and *Actinometra*, and in one species not specified).

The gonadial tubes are sometimes long, sometimes egg-shaped. They run through a larger or smaller number of joints of the pinnule. At the time of maturity they swell and often bulge out the wall of the pinnule in such a way as to show at a glance which pinnules contain ripe sexual products.

The manner in which the ripe products are ejected from the pinnules is not yet satisfactorily explained. There seem to be no constant genital apertures in the adult. It appears that the ejection takes place through two merely temporary apertures (one on each lateral wall of the pinnule).

Round the mouth, finally, there are five genital strands with the sinuses in which they lie, running from the periphery, *i.e.* from the bases of the arms below the food grooves of the tegmen calycis. It is not certainly known what becomes of these genital strands; according to some accounts, they are continued round the mouth into the strands of the axial organ. They are said also to develop ontogenetically as outgrowths of that organ (*cf.* p. 446).

If the axial organ of the Crinoids is homologous with that of the *Ophiuroids*, *Asteroids*, and *Echinoids* (which homology cannot be considered as certainly established), then we should have the same relations subsisting between the axial organ and the genital organ in the Crinoids as in the other groups above mentioned. But in the Crinoids the genital strands, which only become fruitful as gonadial tubes in the pinnulæ, are oral outgrowths of the axial organ, whereas in other Echinoderms (apart from the *Holothurioidea*, which are quite isolated) they are apical outgrowths.

G. Origin of the Sexual Products.

The first origin of the sexual products has been accurately described for the Ophiurid *Amphiura squamata*. They, and the cells of the axial organ, arise out of one and the same rudiment, which consists of the endothelial cells of the cœlom. The Echinoderms would thus, as far as the origin of the sexual products is concerned, agree with the Annulata, the Mollusca, and the Vertebrata.

The specific cells of the axial organ seem incapable of becoming germinal cells.

H. Hermaphroditism in Echinoderms.

Hermaphroditism is an altogether exceptional phenomenon in Echinoderms, and is only of frequent occurrence in one order of the Holothurians, the *Paractinopoda* (*Synaptidæ*). Apart from this order, it is only certainly established in one *Asteroid* (*Asterina gibbosa*) and one *Ophiurid* (*Amphiura squamata*).

(a) **Paractinopoda.**—All species of the genera *Synapta* and *Anapta*, examined with regard to this point, and a few species of the genus *Chirodota*, are hermaphrodite.

Eggs as well as spermatozoa are produced in the gonadal tubes, but the two products do not ripen simultaneously (*Synapta inharens*). The spermatozoa only ripen after the ejection of the eggs.

(b) *Asterina gibbosa*.—Here also the eggs and the spermatozoa are formed in the same genital organs, again not being simultaneously produced. The young animals are males, the adults females.

(c) *Amphiura squamata*.—The simple pear-shaped gonads are very few in number. On the average, the adradial and the abradial walls of a bursa have only one gonad each sessile on it. The adradial gonads are testes, the abradial ovaries. Only a few eggs in the ovary and a small number of spermatozoa in the testes ripen at one time. These two kinds of sexual products here also, as it appears, do not ripen simultaneously in one and the same animal. The eggs are developed in the bursæ.

I. Care of the Brood and Sexual Dimorphism.

Little by little, somewhat numerous cases of care of the brood have become known among the *Holothurioidea*, *Echinoidea*, *Asteroidea*, and *Ophiuroidea*. These are not infrequently connected with a more or less pronounced sexual dimorphism, the adaptations for care of the brood being found only in the female.

The eggs of an Echinoderm in which the brood is cared for are, as far as investigation on this subject has gone, distinguished by remarkable size, and by a rich provision of nutritive yolk, from those which are ejected into the water, and are destined to develop into free-swimming larvæ.

The following review makes no claim to be exhaustive.

(a) *Holothurioidea*.—In *Psolus ephippifer* (cf. Fig. 228, p. 287) large plates are found on the back of the female, raised from the dorsal integument by means of stalks. Between the stalks a brood chamber, roofed over by the contiguous plates, arises; in this the fertilised eggs which emerge through the dorsal genital aperture pass through their development.

In *Cucumaria crocea*, the developing eggs are retained in a dorsal trough, which arises by the swelling up and bulging outward of the body wall in the two dorsal radii.

Another kind of care of the brood is found in *Cucumaria levigata* and *C. minuta*. Two sacs here project from the body wall into the body cavity; these are brood pouches, which shelter the developing brood. The sacs are probably mere invaginations of the body wall; their outer apertures, however, have been discovered only in *C. minuta*. The two sacs belong to the two ventral interradial areas; in *C. levigata* they lie near the middle of the body, in *C. minuta* anteriorly.

In *Phyllophorus urna* and *Chirodota rotifera*, the body cavity serves as a brood chamber. It is, however, unknown how the fertilised eggs pass in and the young *Holothurioidea* out of it.

In other Echinoderms, as might be anticipated, we find the spines occasionally acting as protections for the brood.

(b) *Echinoidea*.—In a few *Cidaroida* (e.g. *C. canaliculata*, *C. nutrix*, *C. membranipora*) the eggs are retained on the apical area of the test, and here develop, protected by the spines, which bend together over them. The same is the case in many *Spatangoida*, but the members of this order have become still more specialised for this function. In certain forms either some or all of the petaloids (cf. p. 347) sink in deeply, and thus give rise to brood chambers (**marsupia**) into which the eggs pass from the genital aperture. The brood developing in such a marsupium is protected by the bending together of the larger spines which border it. In the *Schizaster* figured on p. 294, the anterior unpaired petaloid; in *Hemister cavernosus*, in which this arrangement is best known, the paired petaloids are the most deeply sunk. As

this is only the case in the female, we here have a striking sexual dimorphism. Similar adaptations for the care of the brood seem to occur in *Moiria*, *Anochanus*, etc.

(c) **Asteroidea.**—Among the Asteroidea, the *Pterasterinae* (*Pteraster*, *Hymenaster*) are very remarkable for the care of the brood. The whole of the apical body wall carries large peculiarly shaped **paxillæ** or calcareous pillars, from the free ends of which radiate, like the spokes of a wheel, a varying number of calcareous rods (cf. p. 391). All these calcareous stars of the paxillæ are connected by an integument in such a way that, between this integument (supradorsal membrane) and the dorsal wall of the body beneath it, a large brood chamber is formed. This chamber communicates with the exterior at many points: (1) through a large aperture at the apical pole (**osculum**) usually surrounded by five valves of considerable size (Fig. 396); (2) through numerous contractile pores or spiracles in the membrane which covers the brood cavity; (3) through regular segmentally recurring apertures at the sides of the arms. These apertures can be closed by means of small spines or scales. These "segmental" apertures are regarded by the present writer as ventilating apertures, as they appear to serve the purpose of keeping up an active circulation of water in the brood cavity.

The sexual arrangements in the *Pterasterinae* are unfortunately still unknown. All specimens as yet described show the brood membrane. Possibly they are all females, and the males are still unknown, or the *Pterasterinae* may be hermaphrodite. Or, again, there may be a far-reaching dimorphism, which has led to the males being described as a separate species.

Leptoptychaster kerguelenensis, an *Astropectinid*, shows us the care of the brood, seen in the *Pterasterinae*, to a certain extent in statu nascendi. The eggs which emerge from the genital aperture pass into the interstices between the stalks of the still separate paxillæ, and there pass through the first stages of their development. At a later stage, also, as young Asteroids, they remain for some time on the body of the mother.

In *Asterias spirabilis*, similar arrangements are found, but the embryo is connected by means of a stalk to the body wall of the mother.

Other Asteroids (e.g. species of *Echinaster* and *Asterias*) protect the brood which collects on the oral side; it develops under the shelter of the arms, which simply bend round over it, so forming a temporary brood chamber.

Ophiuroidea.—In the description of the bursæ, p. 495, it was mentioned that, in many Ophiurids, these function as brood chambers, and the best-known cases were given.

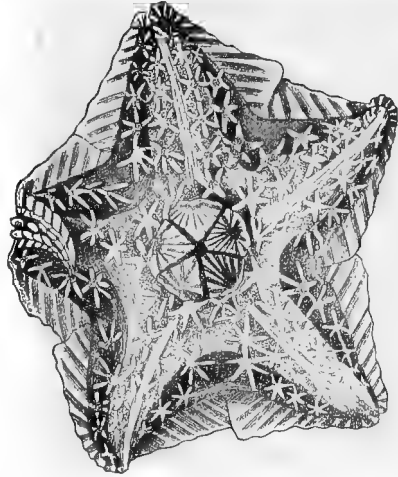

FIG. 396.—*Hymenaster pellucidus*, Wyv. Thomson, from the apical side. The osculum is seen, surrounded by five valves (after Sladen).

XX. Capacity for Regeneration and Asexual Reproduction by means of Fission and Gemmation.

The capacity for regeneration is, as a rule, highly developed in Echinoderms. Defects in the body wall are in this way easily and quickly repaired in all Echinoderms. The *Echinoidea*, even, in which this capacity is in other ways slightly developed, easily repair smaller or greater defects in the body epithelium which covers the test. For example, in *Dorocidaris papillata*, portions of the test over which the epithelium has been damaged or destroyed are cast off, and as soon as a fresh integument has formed a new test can undoubtedly be produced below it.

The capacity for regeneration may increase to an extraordinary degree within the different divisions, and the sensitiveness to external stimulus increases in proportion, till a stage is reached when voluntary amputation by means of muscular contraction takes place in response to external stimuli.

The *Crinoids* completely regenerate lost viscera, and it even appears as if such loss is not altogether involuntary, in certain species and under certain conditions voluntary amputation taking place. This, however, is not certain.

Crinoids easily regenerate broken-off portions of arms or whole arms; several or indeed all the arms may, under favourable circumstances, be regenerated. The arms break off easily at their bases; it even appears as if *Antedon*, in response to injurious stimuli, voluntarily throws off its arms.

The regeneration of the portions of arms (bitten off, possibly by enemies) or of whole arms takes place very easily in many *Asteroidea* and *Ophiuroidea*. The frequency with which *Asteroids* and *Ophiurids* with regenerated arms or arm tips are met with demonstrates both the frequency of mutilation and the great utility of regeneration.

Species of *Asteroids* in which the disc with the other arms are regenerated at the base of broken-off arms are less common. Such regenerations give rise to the well-known "comet" form of *Asteroids* (Fig. 397, B). Regeneration of the whole body from one arm never occurs in *Ophiurids*. It has been suggested that the difference between *Asteroids* and *Ophiurids* in this respect is connected with the fact that, in *Asteroids*, intestinal diverticula project into the arms, and that the genital products are often developed in them, which is never the case in *Ophiurids*.

Animals in which half the disc is retained can regenerate the rest of the body both among the *Ophiuroidea* and the *Asteroidea*.

Defects both great and small in the disc are repaired.

In *Linckia multifora*, an *Asteroid* distinguished by an extraordinary capacity for regeneration, cases have been known in which, after the animal has lost the greater part of an arm, two new tips have been formed by the wounded surface, and in one case regeneration led to the formation of a complete new *Asteroid* at such a point. This latter case is illustrated in outline in Fig. 397 C. The new animal consists of two discs with their arms, connected by the regenerating stump of the arm.

Holothurioidea.—Here also the capacity for generation seems to be very great. Not only are tentacles and integumental defects repaired, but the ejected viscera (intestine, respiratory trees, and even the calcareous ring, the water vascular ring, and the gonads) can be regenerated. In *Synapta*, after the body has been completely cut to pieces, its anterior portion can regenerate the whole. In a *Cucumaria*, the two separate halves can grow into complete animals.

Increase in the capacity for regeneration is accompanied by increased irritability. Many *Holothurioidea*, especially *Aspidochirota*, when strongly stimulated, contract

so violently that the intestine is torn out (usually behind the calcareous ring), and together with the right respiratory tree is ejected through a rent in the cloacal wall.

In certain *Holothurioidea*, the integument, when strongly irritated, easily dissolves into slime. A *Stichopus* was observed to come entirely out of its skin, *i.e.* the whole integument dissolved into slime, so that only the dermomuscular tube

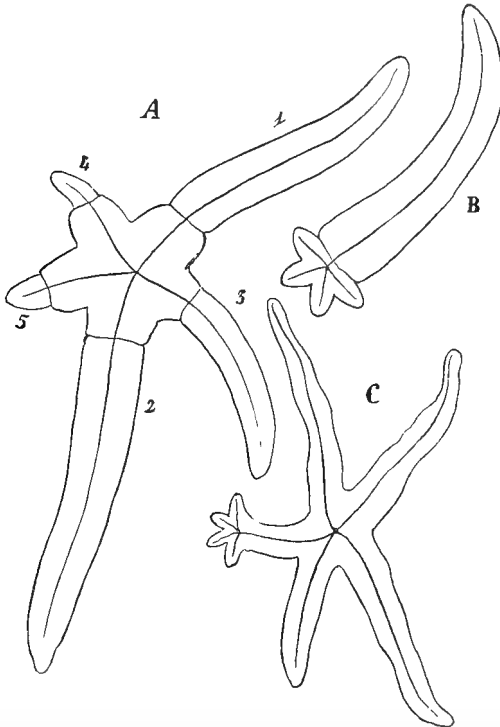

FIG. 397.—A, *Ophiaster diplox*. A specimen with the arms (3, 4, 5) in the act of being regenerated; and two (1 and 2) being constricted off (after **Haeckel**). B, *Linckia (Ophiaster) multifora*, a "comet" form. One arm is in the act of regenerating the disc and the other four arms (after **Haeckel**). C, The case given in the text of a specimen of *Linckia multifora* (after **P. and F. Sarasin**).

enclosing the viscera remained. That regeneration follows such a phenomenon has not yet been established by observation.

The *Synaptidae* react on stimuli (often quite slight) by falling to pieces, the circular musculature being at certain points so strongly contracted that the parts thus constricted break off.

It will no doubt be proved in time that all these manifestations of increased irritability which coincide with increased capacity for regeneration are of use to the animal.

Asexual reproduction (schizogony). In certain Echinoderms, the strongly developed capacity for regeneration has had as a consequence asexual reproduction.

parts is purely voluntary (*i.e.* results from causes entirely within the animal itself) and not to some extent due to external stimuli, however slight. In any case, the final result of the regeneration which follows is the same—the multiplication of individuals.

Fission of the body into two halves of approximately equal size with subsequent regeneration has been observed in *Ophiuroidea*, *Asteroidea*, and *Holothurioidea*. In the two former classes the plane of fission passes through the middle of the disc (through the mouth and digestive sac), in the *Holothurioidea* (*Cucumaria*) it passes transversely through the tubular body, dividing it into an anterior (oral) and a posterior (apical) half.

In the *Ophiuroidea*, reproduction by means of fission has been observed in the following genera: *Ophiactis* (*Mülleri*, *Savigny*, *virens*), *Ophiocnida* (*sexradia*), *Ophiocoma* (*pumila*, *Valenciæ*), *Ophiothela* (*isidicola*, *dividua*).

Among the *Asteroidea*, schizogony is specially characteristic of many species of the genus *Asterias* (*acutispina*, *atlantica*, *calamaria*, *microdiscus*, *tenuispina*), and is also found in *Asterina* *Wega*, *Cribrella sexradiata*, *Stichaster albulus*.

Another kind of asexual reproduction seems to be very common in the family of the *Linckiiide*. In these Asteroids, the arms become constricted off at their bases, after which not only does the disc regenerate the arms which have been cast off, but each individual arm regenerates the disc and the other arms (“comet” forms of Asteroids, Fig. 397 A, B).

Asexual reproduction does not, as a rule, appear to take place simultaneously with sexual reproduction, but there are exceptions to this rule.

XXI. Ontogeny.

In all Echinoderms, except those few forms in which care of the brood occurs, the fertilised eggs develop into **free-swimming, bilaterally symmetrical larvæ**, which are transformed into the **radially built Echinoderm** after passing through an often **very complicated metamorphosis**.

The larvæ of the different classes of Echinoderms will first be compared exclusively according to their external characteristics.

A. The various Larval Forms of the Echinodermata.

We shall first construct a hypothetical larval form, and then deduce the various larval forms from it (Fig. 398, A).

The body of the larva is **egg-shaped**, and concave on the ventral side. In the base of the concavity lies the larval mouth. Near one of the poles (*i.e.* near the **posterior end**), but still on the ventral side, there is a second aperture (proceeding from the blastopore of the gastrula larva); this is the **larval anus**. A **ciliated band** which runs back upon itself surrounds the mouth along the edge of the ventral concavity; posteriorly it runs over the **ventral side in front of the anus**, and is the **circumoral ciliated ring**. The aperture of the mouth and its immediate surrounding are also ciliated (**adoral ciliated band**).

1. **Holothurioidea**.—The Holothurid larva known as **Auricularia** (Fig. 398, A) differs but little from the hypothetical form. The ventral concavity becomes more complicated, lengthening on each side posteriorly and anteriorly, while a posterior median portion with the anus forms a ventral prominence, the **anal area**, and a median portion in front of the mouth forms another prominence, the **preoral area**. The ciliated band which runs longitudinally along the ventral depression assumes

in consequence a more complicated form, and takes a winding course. This description will be elucidated by the figures.

Here, as in all other Echinoderms, the ciliated rings are mere remains of the cilia which covered the whole body in an earlier stage, *i.e.* in the gastrula.

2. *Asteroidea* (Fig. 398, B).—The Asteroid larvæ are known as *Bipinnariæ* and *Brachiolaria*. The chief distinction between them and the *Auricularia* is the preoral ciliated ring. This is a circle on the preoral area, and *within* the circumoral ciliated ring, from which it is altogether distinct.

The comparison of a *Bipinnaria* with an *Auricularia* led to the conjecture that the preoral ciliated ring of the former corresponds with a preoral portion of the common circumoral ciliated ring of the latter, which has become distinct and has closed to form a ring. Direct observation of the ontogenetic development of the ciliated ring of the Asteroid larva has entirely confirmed this conjecture.

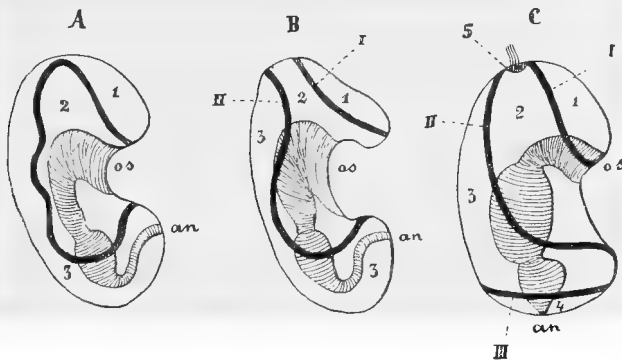

FIG. 398.—A, B, C, *Auricularia*, *Bipinnaria*, and *Tornaria* (*Enteropneustan* larva), from the right side, diagrammatic. 1, Pretrochal area; 2, oral area; 3, postoral area; 4, anal area; I, preoral; II, circumoral; III, anal or principal ciliated ring; 5, neural plate; *os*, mouth, *an*, anus.

The *Bipinnaria* passes through an *Auricularia* stage. The general ciliation of the body, belonging to an early stage, disappears first from the ventral side, which becomes depressed, then from the dorsal side, in such a way as to leave a band running back on itself at the edge of the ventral depression; this corresponds entirely with the course of the circumoral ciliated band in the *Auricularia*. In the frontal region, however, where the two lateral strips of the circumoral band approach each other in the median line, a ciliated island is for a time retained connecting them (*Asterias rubens*). The covering of cilia thus forms an X-like cross on the frontal region. By the disappearance of the ciliation from the centre of the X, the preoral section of the ciliated ring is separated from the rest, and forms the distinct **preoral ring** enclosed within the circumoral ring.

The process in *Asterias vulgaris* seems to take a somewhat different course, but has the same final result. On the frontal region, where, in *A. rubens*, an **isolated ciliated area** remained to form a connection between two portions of the circumoral ciliated band, this connection arises only **secondarily** by the approximation of the two portions in the middle line. The further process of separation of the preoral ring from the rest, which latter then represents the **secondary circumoral ciliated ring**, agrees with that in *A. rubens*.

The ventral depression (in which the mouth lies) which, in the *Auricularia*, runs forward to the right and left of the preoral portion of the circumoral ciliated ring,

that portion; it forms a moat round the preoral area, which becomes raised up like a shield.

An **adoral ciliated ring**, closely encircling the mouth and extending some way into the buccal cavity, is also present.

The body is produced into longer or shorter processes or arms, in the regions of the preoral and circumoral ciliated rings. An anterior unpaired frontal process, belonging to the ciliated ring, is distinguished by its constant occurrence and its greater length.

In some species, the ciliated band disappears on this frontal process, which, on

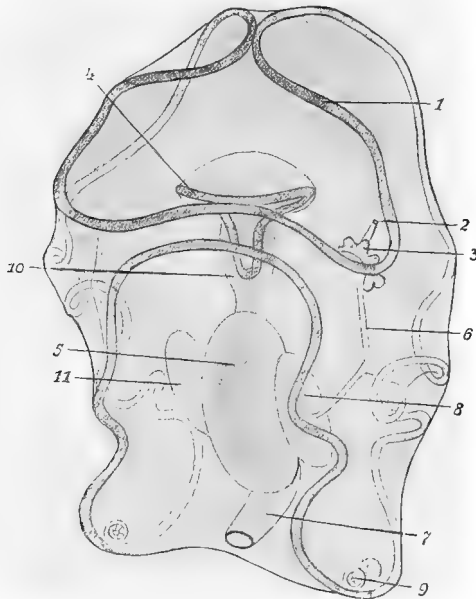

FIG. 399.—Older *Auricularia*, seen diagonally from the lower and left side (after Semon). 1, Circumoral ciliated ring; 2, hydropore; 3, hydrocoel; 4, adoral ciliated ring; 5, median or stomach intestine; 6, nerve band; 7, hind-gut; 8, left enterocoel; 9, calcareous wheel; 10, fore-gut, oesophagus; 11, right enterocoel.

the other hand, divides into three branches, apparently covered with protuberances at their tips. Such larvæ are known as **Brachiolaria**.

There are, further, **Asteroids** whose larvæ do not at all resemble the *Bipinnarian* and *Brachiolarian* larvæ, or else show only a superficial resemblance to them; cf. below the account of the larva of *Asterina gibbosa* (p. 525).

3. **Ophiuroidea**.—The Ophiurid larva is known as the **Pluteus**, and can be just as easily deduced from the hypothetical larval form of the Echinoderms, sketched above, as the *Auricularia* and the *Bipinnaria*. The gastrula stage is followed by the bilateral stage with depressed ventral surface, in the centre of which lies the larval mouth. A circumoral ciliated band is retained, running along the edge of this ventral depression. This band always remains single. While the preoral area (the larva being viewed from the ventral side) remains very small or is even indistinguishable, the anal area appears very large. The body is produced into processes or arms, which may become very long, and are supported by calcareous rods. These pro-

cesses are of two kinds. One kind, which belong to the region of the circumoral ciliated ring, are paired, and diverge in a forward direction. Two arms are distinguished by their constant occurrence and special length; these belong to the posterior and lateral region of the circumoral ciliated band. Opposed to these paired processes of the circumoral ciliated band pointing anteriorly is an unpaired, posterior, postanal process projecting backwards from the posterior end of the anal area; its tip may carry a cap of cilia.

In Ophiuroidea in which care of the brood occurs, the typical larval forms are not developed.

4. **Echinoidea** (Figs. 400 and 401).—The larva of Echinoidea agrees to a great extent with that of the *Ophiuroidea*, and is, like it, known as the **Pluteus**. The only

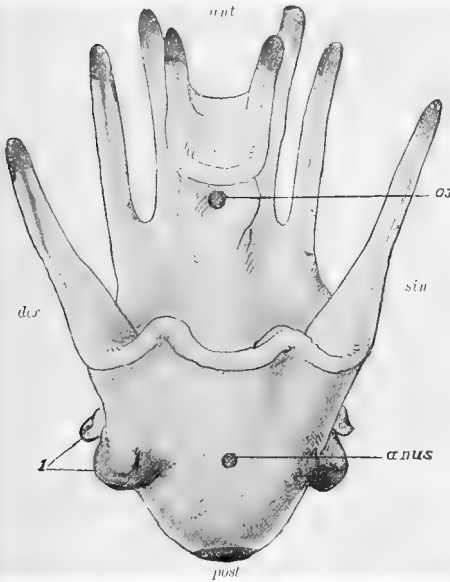

FIG. 400.—Larva of an Echinid (*Pluteus*) from the ventral side. 1, Ciliated "epaulettes"; *ant*, anterior; *post*, posterior; *der*, right; *sin*, left.

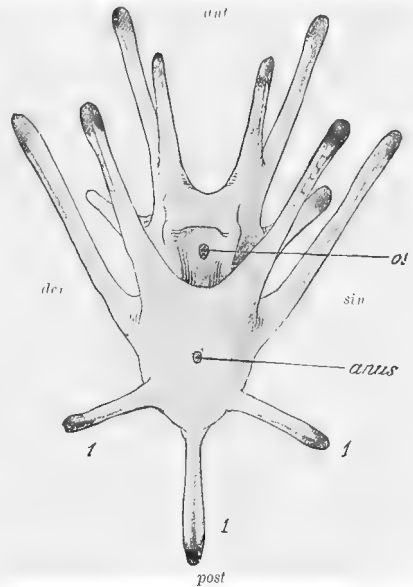

FIG. 401.—Spatangid larva (*Pluteus*) from the ventral side. 1, The three processes of the anal area.

important difference is that the two lateral arms which, in the Ophiurids, are the most constant and the longest, seem to be altogether wanting in the Echinoidea.

The *Pluteus* of *Echinus* has eight arms or processes, and at the bases of each of the four posterior arms a ciliated "epaulette" (Fig. 400).

The larvae of *Arbacia* and *Spatangus* (Fig. 401) have no ciliated "epaulettes," but *Arbacia* has two and *Spatangus* three long posterior processes of the anal area, which, like all the other processes, are supported by calcareous rods.

Echinoids in which care of the brood occurs develop direct without metamorphosis.

5. **Crinoidea** (Fig. 402).—The free-swimming larva of *Antedon* is long and egg-shaped. At the frontal pole, the thickened but somewhat depressed ectoderm (the neural pit or plate) carries a tuft of long flagella. The larva, in swimming, has the frontal pole, which corresponds with the anterior end of other Echinoderms, directed forwards.

The body is surrounded by five ciliated rings, distinct from one another; these cannot be ontogenetically derived from one continuous ciliated ring.

The most anterior ring is interrupted on the ventral side.

The second ring runs somewhat diagonally from above downwards and forwards, the third is directed downwards and backwards, so that there is a large interval between the second and third rings ventrally.

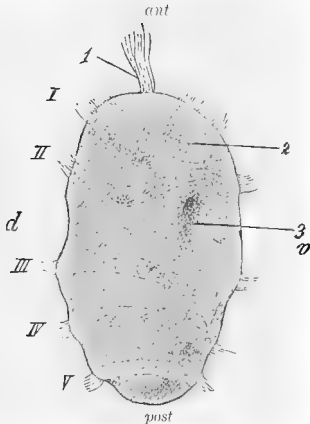

FIG. 402.—Free-swimming larva of *Antedon*, from the right lower side (after Bury). I-V, The five ciliated rings; 1, the neural tuft; 2, the adhesive pit; 3, the vestibular depression; d, dorsal; v, ventral.

consists in the varying number and arrangement of the ciliated rings, which most recall the condition in the Holothurid larva (pupa), to be described later. The vestibular depression of the *Antedon* larva may, however, be compared without forcing to the ventral depression of the other Echinoderm larvæ. A thickening of the ectoderm, comparable with the neural plate of the *Antedon* larva, also occurs, as we shall see in other Echinoderm larvæ.

B. Ontogeny of the Holothurioidea.

The segmentation of the ovum is total and equal, and leads to the formation of a cœloblastula, whose unilaminar cell wall usually consists on one side of somewhat larger cells. By invagination of this part of the blastula wall, a cœlogastrula is formed. The invaginated part, *i.e.* the archenteron, is a blindly ending tube, with narrow lumen (archenteric cavity), which is far from filling the segmentation cavity. This latter is filled with an albuminous, fluid or semifluid, mass, the gelatinous nucleus.

The ectoderm and the endoderm are ciliated.

During the process of invagination (occasionally even during the blastula stage) cells arise by division from the ectoderm, but more especially from the endoderm, which, as mesenchyme cells, wander into the enclosed jelly-like substance, multiply by division and, in ever-increasing numbers, occupy the blastocœl. From them is produced all the connective tissue of the Holothurian body. The calcareous corpuscles arise exclusively in the mesenchyme.

In this region, the ventral side sinks in to form a large ciliated **vestibular depression**.

A smaller depression on the ventral side between the first and second ciliated ring is known as the **adhesive pit**. The larva attaches itself at this point, by means of a special secretion yielded by the glandular cells of the depression.

To the left, between the third and fourth rings, there is a small aperture, the primary madreporite (water pore).

The intestine lies as an entirely closed sac in the posterior part of the larva. The free-swimming larva has neither larval mouth nor larval anus. The definitive mouth breaks through the floor of the vestibular depression later.

The whole anterior part of the larva, as far as the third ciliated ring, becomes the stalk, and the posterior part the calyx of the attached larva.

The free-swimming Crinoid larva cannot with certainty be derived from the same hypothetical form as other Echinoderm larvæ. The difficulty

The blind end of the lengthening archenteron bends to that side, which becomes the dorsal side of the larva as it rapidly grows bilaterally symmetrical (Fig. 403, A), and at the same time it moves somewhat to the left side. As the **hydro-enterocœl vesicle**, it soon becomes entirely constricted off from the rest of the archenteron, which opens outward through the blastopore (Fig. 403, B, C, D, 4, 5).

This constriction from the archenteron, the **hydro-enterocœlomic vesicle**, is of the greatest importance, because out of its wall arises the **whole musculature of the body and all the internal epithelia, i.e. the cœlomic and water vascular epithelia.**

The hydro-enterocœlomic vesicle increases in length, alongside of the intestine, in the direction of the blastopore, and again divides into two vesicles by means of a

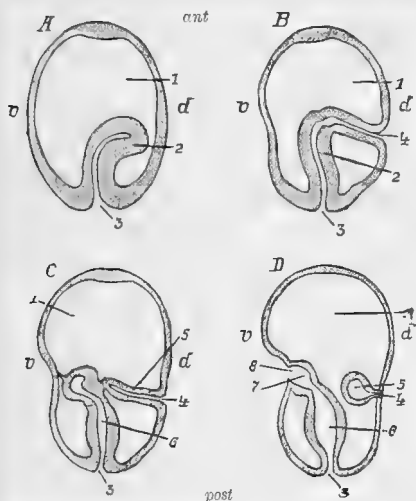

FIG. 403.—Formation of the larval mouth and the hydro-enterocœlomic vesicle in the gastrula larva of *Synapta digitata*, diagrammatic (after Selenka). A, Gastrula, the archenteron bent towards the dorsal side; B, archenteron, opening outward through the blastopore; C, hydro-enterocœl, constricted from the intestine; D, intestine, opening outward through the larval mouth ventrally. 1, Segmentation cavity, blastocœl; 2, archenteron; 3, blastopore; 4, hydro-pore; 5, hydro-enterocœl; 6, intestine; 7, œsophagus; 8, mouth; *ant*, anterior; *post*, posterior; *v*, ventral; *d*, dorsal.

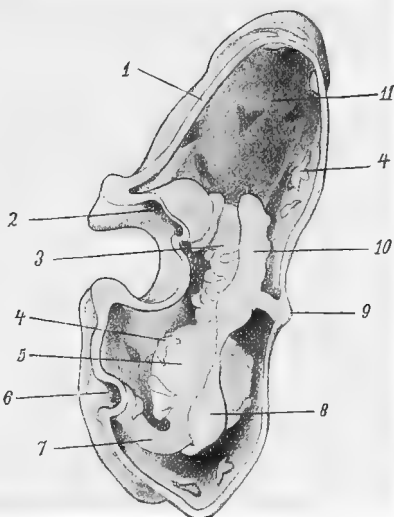

FIG. 404.—Auricularia with the left half of the ectoderm removed, from the left (after Ziegler's model). The organs lying in the segmentation cavity (11) are seen. 1, Cut edge of the ectoderm; 2, mouth; 3, œsophagus; 4, mesenchyme cells; 5, mid-gut or stomach intestine; 6, anus; 7, hind-gut; 8, left enterocœl, still connected with the hydrocœl 10, the latter showing slight indications of the first radial outgrowths; 9, dorsal pore or hydro-pore; 11, blastocœl, segmentation cavity.

transverse constriction. The other vesicle (that further from the blastopore) is the **hydrocœlomic vesicle**, which at once sends off a canal to the dorsal side, which opens outward through a pore on the left of the middle line. The canal is the **primary stone canal**, and the pore the **primary madreporite**. The hydrocœlomic vesicle is the rudiment of all the rest of the water vascular system, and in the first place, of course, of the circular canal (Fig. 404).

The first appearance of the various structures just described does not occur in the same order in all species of Holothurioida examined on this point. The hydro-enterocœlomic vesicle may become connected with the exterior through a stone canal before it has divided, or even (a unique condition found in *Synapta digitata*) before

it has itself separated from the archenteron (Fig. 403). In the last case, it can be established that the archenteron which begins with the blastopore opens outward for a time through a second aperture, the primary madreporite.

After the hydro-enterocœlomic vesicle has become constricted from the archenteron, the intestine grows further, its blind end bending to the ventral side (that lying opposite to the water pore), which commences to become depressed and to sink in.

The blind end of the intestine soon becomes applied to the ectoderm of the depressed ventral side of the larva, about half way down the body, or a little in

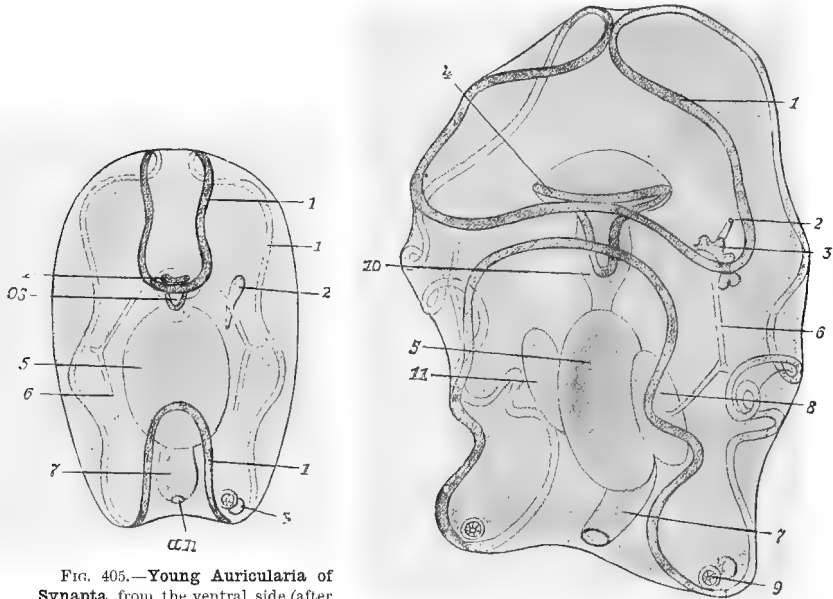

FIG. 405.—Young *Auricularia* of *Synapta*, from the ventral side (after Semon). 1, Circumoral ciliated band; 2, entero-hydrocœl; 3, calcareous wheel; 4, adoral ciliated ring; os, mouth; an, anus; 5, mid-gut or stomach intestine; 6, larval nerve band.

FIG. 406.—Older *Auricularia*, seen diagonally from the left lower side (after Semon). 1, Circumoral ciliated band; 2, hydropore; 3, hydrocœl; 4, adoral ciliated band; 5, mid-gut or stomach-intestine; 6, nerve band; 7, hind-gut; 8, left enterocœl; 9, calcareous wheel; 10, fore-gut, œsophagus; 11, right enterocœl.

front of the middle point. Where the two touch one another, an aperture, the mouth, breaks through.

The median portion of the intestine (the mid-gut) swells up and becomes distinct both from the fore-gut and from the hind-gut.

In the meantime, the larva has undergone a change of shape through which it reaches the *Auricularia* stage, the depression of the ventral side being the most important part of this change. The general ciliation has disappeared; of the complete covering of cilia, only the circumoral ring and the adoral band are retained, and the region immediately around the mouth has become depressed to form the oral vestibule (Figs. 404-407).

The transformation of the *Auricularia* into the barrel-shaped larva (Figs. 408-413).—The *Auricularia* does not change direct into a young *Holothurid*, but passes through an intermediate stage, which was formerly known as the **pupal stage**, because during it no nourishment is taken.

FIG. 407.—Older *Auricularia* (after Semon). *an*, Anus; *os*, mouth; 1, outgrowths (primary and secondary) of the primitive horse-shoe-shaped hydrocoel; 2, stone canal; 3, left, 4, right enterocelomic sac, which have become closely applied to the mid-gut.

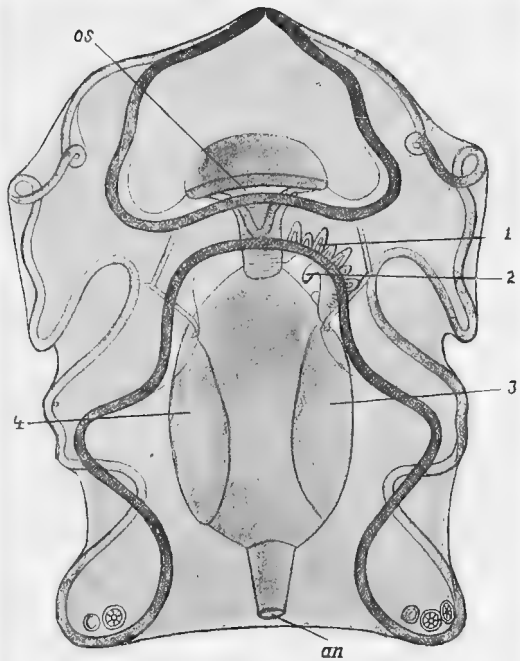
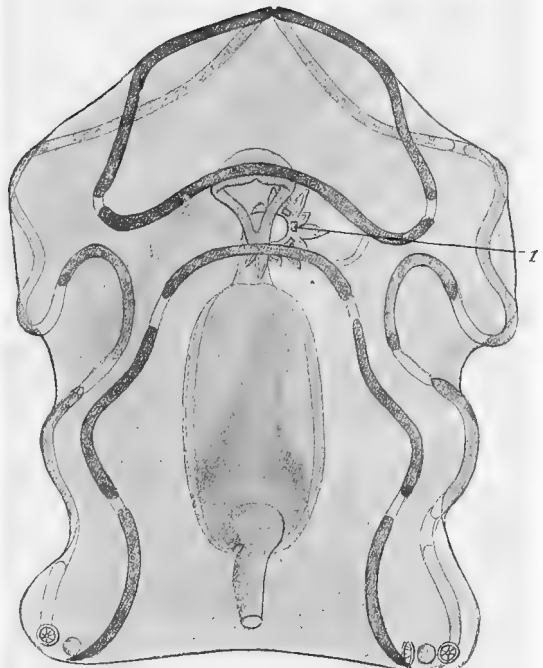

FIG. 408.—*Auricularia*, in which the circumoral ciliated ring is beginning to break up into lengths (after Semon). The horse-shoe-shaped hydrocoel is growing round the intestine. The first pieces of the calcareous ring (1) have appeared.



The *Auricularia* assumes the shape of a barrel. The circummoral ciliated ring atrophies in sixteen places, which are indicated in the diagram (Fig. 413). The sixteen lengths of the ring which remain continue to grow and join, as indicated

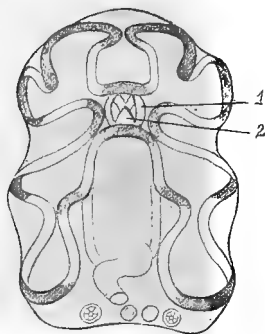

FIG. 409.—Old *Auricularia*. Transition to the barrel-shaped pupa, the whole body decreasing considerably in size. 1, The nerve bands, in the act of forming the nerve ring; 2, primary tentacle.

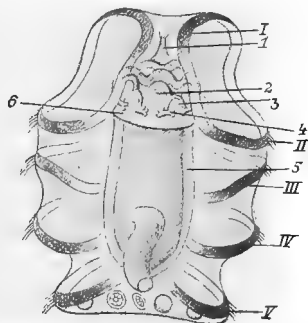

FIG. 410.—Intermediate stage between *Auricularia* and the barrel-shaped pupa of *Synapta* (after Semon). I-V, the rudiments of the five ciliated rings. 1, The oral funnel; 2, the primary; 3, the secondary outgrowths of the water vascular ring; 4, pieces of the calcareous ring; 5, colonic vesicle; 6, water vascular ring.

by dotted lines (Fig. 413), to form five ciliated rings entirely encircling the barrel-shaped body. The centre of the former oral area becomes surrounded by four lengths of the ciliated band which join together to make a square. The part of the oral

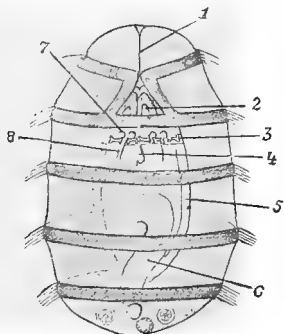

FIG. 411.—Young barrel-shaped larva (pupa) (after Semon). 1, Oral funnel; 2, tentacles; 3, pieces of the calcareous ring; 4, Polian vesicle; 5, left coelom; 6, hind-gut; 7, auditory vesicles; 8, secondary outgrowths of the hydrocoel ring.

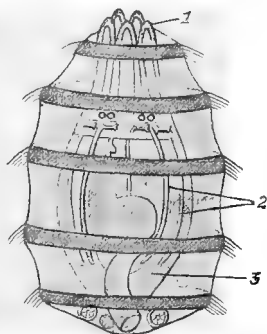

FIG. 412.—Barrel-shaped larva, with the tentacles (1) beginning to project from the opening oral funnel (after Semon). 2, Water vessels of the body—secondary outgrowths of the circular canal; 3, the rapidly swelling enterocoel.

area enclosed by this ring sinks below the surface, and thus increases the size of the oral vestibule. The ciliated square itself becomes depressed and forms the oral shield. The spacious oral vestibule becomes cut off from the exterior, with the exception of a very narrow aperture, and shifts quite to the front, so that now the

three apertures, that of the oral vestibule, the mouth itself lying in its floor, and the anus, lie almost in the axis of the barrel-shaped body.

In the older *Auricularia* stages and during the transformation into the barrel-shaped larva important internal processes take place.

Calcareous corpuscles appear early (even in the younger *Auricularia*) in the mesenchyme. In the best known *Auricularia*, that of *Synapta digitata*, these bodies appear in the form of wheels in the two posterior tips of the larva (cf. Fig. 404, p. 511, and following).

The **hydrocœlomic vesicle** assumes the form of a horse-shoe with the curve towards the dorsal side. On the convex side of this **horse-shoe-shaped vesicle** five outgrowths appear. The two arms of the horse-shoe then close round the fore-gut, growing towards each other round it until, finally, they meet and fuse (probably in the right half of the body). The horse-shoe-shaped hydrocœl is now the closed **water vascular ring** surrounding the fore-gut. It continues, as before, to communicate with the exterior through the primary stone canal and the dorsal water pore.

The five outgrowths of this hydrocœl ring now become more distinct. They are originally directed forwards, but very soon, with further growth, bend backward, and, as the **rudiments of the radial canals** of the water vascular system, grow further back under the body wall, in the five radii. The **rudiments of the tentacle canals** appear **very early** on the rudiments of the radial canals as orally directed lateral outgrowths.

The above account of the first processes of differentiation in the hydrocœl vesicle are those found in *Cucumaria Planci*, the ontogeny of which has recently been carefully investigated. In other Holothurioidea, at least in *Synapta digitata*, according to former authors, the ontogenetic processes differed essentially from these. The first five outgrowths of the hydrocœl in *Synapta* develop exclusively into the tentacle canals, and only after the appearance of these and alternately with them, five other outgrowths form the rudiments of the radial canals.

This and certain other discoveries led to the conclusion that the radial canals in the Holothurians arise **interradially** and only shift into the radii secondarily, hence it was inferred that the tentacle canals of the Holothurioidea were homologous with the radial canals of other Echinoderms, and that the radial canals of the Holothurioidea are not represented in other classes. The above discoveries in the larva of *Cucumaria Planci* dispose of this suggestion, which must always have appeared improbable to comparative anatomists.

It is a very noteworthy fact that, in *Synapta*, the radial canals appear ontogenetically, whereas they are wanting in the adult.

The **Polian vesicle** also arises as an outgrowth of the circular canal; in *Cucumaria Planci*, it forms at the point where it lies in the adult, *i. e.* in the left dorsal interradius.

The tube-feet arise as outgrowths of the radial canals, which push the ectoderm

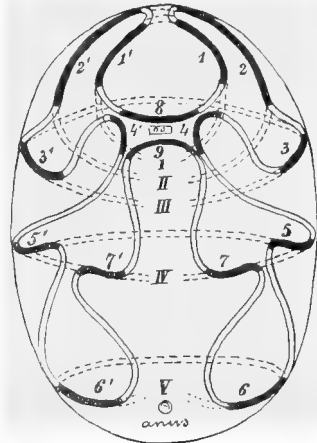

FIG. 413.—Diagram illustrating the rise of the five ciliated rings of the Holothurian pupa from the pieces of the ciliated bands 1-7 and 1'-7' of the *Auricularia* (after Ludwig). The pieces of the ciliated band are marked by broad black lines, the interruptions being left clear. 8, The preoral; 9, the postoral intermediate piece of the ciliated ring; *os*, mouth. The dotted lines give the direction in which the pieces of the ring of the *Auricularia* unite to form the five complete rings (I-V).

out in front of them (Fig. 415). The first two tube-feet in *Cucumaria Planci* arise simultaneously at the posterior end of the body. Both these feet belong to the medioventral radial canal.

The differentiation of the enterocoel vesicle.—After the hydro-enterocoel vesicle has divided into the hydrocoel and the enterocoel vesicles, the latter grows backwards longitudinally, the growing posterior end pushing its way gradually over the intestine, on to its right side (*i.e.* into the right-hand portion of the segmentation cavity). The anterior part of the enterocoel vesicle now lies to the left, the posterior to the right, near the intestine (Fig. 404). These parts become completely separated by a constriction which stretches transversely over the intestine, into a left and a right enterocoel vesicle.

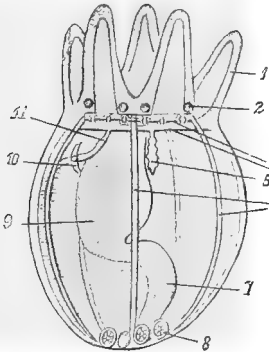

FIG. 414.—Young *Synapta* (*Pentactula*) (after Semon). 1, Oral tentacles; 2, auditory vesicles; 3, pieces of the calcareous ring; 4, water vascular ring; 5, Polian vesicle; 6, radial vessels of the water vascular system; 7, hind-gut; 8, calcareous wheels; 9, mid-gut; 10, madreporite; 11, stone canal.

Each of these vesicles becomes applied to the intestine, and, increasing in size, takes the shape of a hollow disc resembling a watch glass.

The nervous system of the larva.—On each side of the *Auricularia* larva, on the ventral side, in the oral area, there is a ciliated ectodermal ridge, beneath the surface of which ganglion cells lie and longitudinal nerve fibres run. The ridge consists of two limbs, meeting in an obtuse angle which is open towards the mouth. From the ends and angles of these ridges nerve fibres go off to the circumoral ciliated band.

Formation of the tentacles.—The tentacle canals, whether as lateral outgrowths of the radial canals or direct outgrowths of the water vascular system, grow towards the oral vestibule, and press out the ectodermal wall of the latter before them.

The ectodermal covering thus afforded them is derived from the oral shield, *i.e.* indirectly from parts of the original circumoral ciliated ring of the *Auricularia* larva. The tentacles (five of which form first) remain hidden in the oral vestibule during the pupal stage.

Transformation of the barrel-shaped larva into the young Holothurian (Figs. 414 and 415).—The external changes are as follows. The ciliated rings atrophy. The tentacles project freely from the expanding and widely opening vestibule, and increase in number. In the *Actinopoda* tube-feet are formed in all the five radii.

It is an important fact that, in the comparatively simple transformations of the Holothurian, not only does the whole of the larval epithelium pass into the body epithelium of the adult, but none of the larval organs are eliminated.

The following description applies to *Cucumaria Planci*.

The tentacles.—It is somewhat remarkable that the five tentacles first formed do not each arise from a single radial canal. Two of the five tentacles, on the contrary, receive their canals from the medioventral, and two others from the left dorsal radial canal. The fifth tentacle belongs to the right dorsal radial canal. Other tentacles appear only at a very late stage, two more being added first, a sixth and a seventh. These belong to the two lateral ventral radii, which up to this time have been without tentacles.

The stone canal.—An anterior outgrowth forms on the primary stone canal; the epithelium of this outgrowth flattens, giving rise to the **madreporitic vesicle**. On the wall of this vesicle the mesenchyme forms an incomplete shell, perforated like a lattice.

The water pore lying on the right side of the mesentery (now formed) disappears

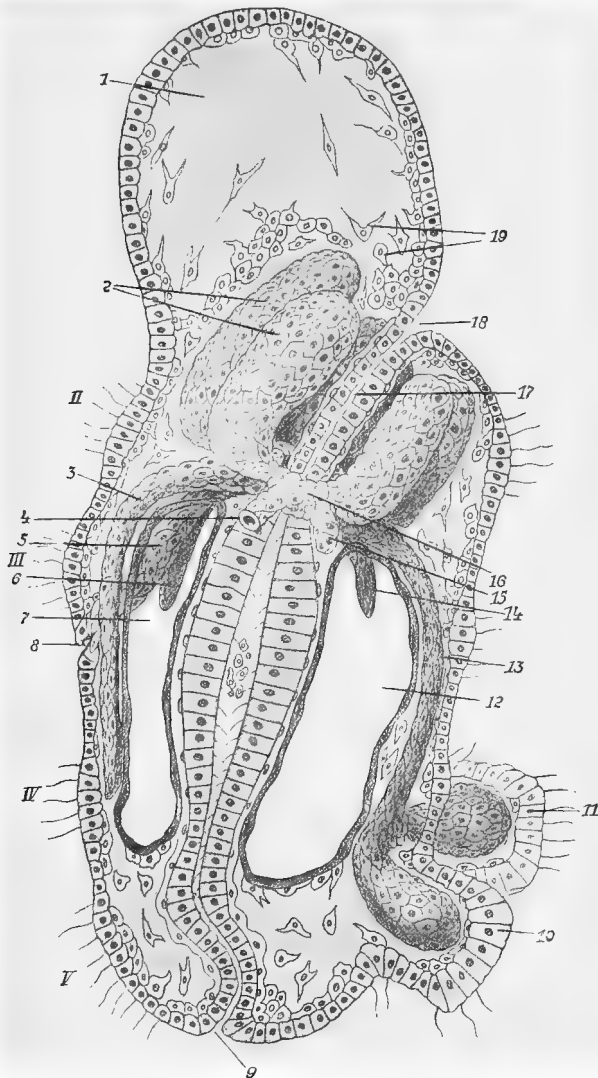

FIG. 415.—Longitudinal section of a larva of *Cucumaria dolium* (after Selenka). 1, Frontal prominence with enclosed jelly-like substance; 2, tentacle vessels; 3, 6, 15, 14, 13, radial vessels; 5, stone canal; 8, madreporite; 4, Polian vesicle cut off; 7 and 12, coelom, enterocoel vesicle; 9, anus; 10 and 11, the first two tube-feet; 16, circular canal of the water vascular system; 17, oesophagus; 18, mouth; 19, mesenchyme cells; II, III, IV, V, ciliated rings.

later, and still later the madreporitic vesicle opens into the body cavity, and thus becomes the **secondary inner madreporite**.

The radial canals.—The five radial canals do not develop with equal rapidity, nor indeed do the radial nerves and the radial longitudinal muscles. The medio-ventral organs (radial canal, radial nerve, longitudinal muscle) in all cases arise first, then follow the organs of the two dorsal radii, and only at a later stage, those of the two lateral ventral radii.

The tube-feet.—In agreement with the order of appearance just described, the two first tube-feet, already mentioned above, belong to the ventral radius (Fig. 415). The two next in order also belong to the medioventral radial canal, and, according to the rule which applies to all the newly developing tube-feet, arise in front of those already present. The fifth tube-foot belongs to the left dorsal radial canal. (The correspondence of this order with that of the rudiments of the tentacles should be noted.)

According to observations which have been made, it appears that when, in a *Holothurian*, the tube-feet are scattered, this arrangement is, ontogenetically, secondary. In the same way animals which have several rows of tube-feet in each radius have only two rows in a young stage, or a zigzag row of alternating feet.

The nervous system.—The first part of the nervous system to appear is the **oral circular nerve**, and this arises as an **ectodermal circular ridge** on the floor of the oral vestibule in the larva. It sends out five band-like processes in the direction of the rudiments of the radial canals; these are the rudiments of the **radial nerves**.

In that the rudiments of the circular nerve and the radial nerves become **subepithelial**, there arises between them and the body epithelium which closes over them a narrow space; this is the **epineural canal**.

The rudiments of the five radial nerves grow backwards together with those of the radial canals.

In *Cucumaria Planci* there seems to be no larval nervous system. In *Synapta*, on the contrary, the larval nervous system yields the rudiments of the definitive system. The two lateral nerve ridges of the *Auricularia* larva, when the oral vestibule of the barrel-shaped larva is formed, shift into it. Their free ends then become connected from the two sides to form a ring encircling the mouth, which is the rudiment of the nerve ring.

The **intestine** shows, at an early stage, the coils characteristic of the adult.

The first portions of the **calcareous ring** to appear are the five radial pieces: these arise on the radial canal and, like all the calcareous structures, are produced by the mesenchyme. The medioventral calcareous piece is from the first the largest.

The enterocœl.—The right and the left enterocœl vesicles grow round the intestine. At the point where they meet ventrally they open into one another. Dorsally they press the mesenchyme cells together in a vertical lamina. In this way the dorsal (anterior) mesentery arises. The middle and the posterior mesenteries probably arise in consequence of the two enterocœl vesicles twisting round the intestine posteriorly.

The **visceral wall** of the enterocœl, which becomes applied to the intestine, presses the **mesenchyme cells**, which have greatly increased in number, against the endodermal intestinal wall, till they form a layer, which becomes the **connective**

tissue layer of the intestine. In a similar way, the **parietal** wall of the enterocoel presses the peripheral mesenchyme cells to form a layer below the ectodermal body epithelium; this layer forms the **cutis of the body wall.**

Whilst these processes have been going on (*i.e.* while the enterocoel vesicles are increasing in size till they surround the intestine, the parietal wall becoming applied to the body wall, and the visceral wall to the intestinal wall of the young animal, and the two vesicles opening into one another ventrally), the narrow slit-like cavities of the watch-glass-shaped enterocoel vesicles in the larva have become the **large spacious body cavity.**

The visceral wall of the enterocoel yields the intestinal musculature and the **endothelial covering** of the intestine; the parietal wall of the enterocoel gives rise to the **longitudinal and circular musculature** of the body wall and its **endothelial covering.** Since the **musculature** of all parts of the **water vascular system** is formed from the epithelial wall of that system, it follows that the whole of the **musculature of the Holothurian body is of epithelial origin.**

The **blood lacunar system** arises in the form of cavities in the connective tissue (mesenchymatous) layer of the different organs (integument, intestine).

The rudiments of the genital organs, of the respiratory trees, and of the Cuvierian organs are unknown.

Not all the Holothurids pass through a distinctly marked Auricularia stage. The gastrula larva of *Cucumaria Planci*, for example, passes direct into the stage of the barrel-shaped larva. Nevertheless, "when the oral depression of the *Cucumaria* begins to form, it is beset along its edge with wreath-like ectodermal protuberances (ciliated protuberances) which, taken together, may be compared with the ciliated ring of the *Auricularia* larva." One trace of the *Auricularia* stage seems thus to be retained.

The preoral region in the *Cucumaria* larva rises up sharply as the **frontal prominence**, and in its gelatinous nucleus an excessive growth and multiplication of the mesenchyme cells early takes place. This is resorbed at a later stage as nourishment for the formation or further development of the different organs.

The **plane of symmetry** of the young Holothurid does not coincide with that of the larva, but deviates from the latter, anteriorly to the left, and posteriorly to the right. The longitudinal axis of the young Holothurian deviates anteriorly ventrally, and posteriorly dorsally, from that of the larva.

C. Ontogeny of the Echinoidea.

The following description is an epitome of the results gained by various investigators in the examination of different Echinoids.

Segmentation is total, and, in a peculiar manner, unequal. The inequality between the blastomeres, however, soon almost entirely disappears. A spherical, egg-shaped, or (*Echinocyamus pusillus*) long elliptical **cœloblastula** arises, with a unilaminar wall, which becomes covered with long flagellate hairs (one on each cell).

The wall of the blastula becomes thickened at the vegetative pole. At this thickened part, the blastoderm cells divide actively, so that the wall becomes bi- or trilaminar. The deeper cells pass in succession into the segmentation cavity, become amoeboid, and are the first **mesenchyme cells.** At this same point the blastula wall sinks in to form the archenteron. The blastula becomes a **gastrula.** During this process of invagination, the wandering of mesenchyme cells out of the wall of the archenteron into the blastocoel continues.

In *Echinocyamus* (and other Echinoids?) the cells of the blastula wall at the animal pole (the point opposite the later blastopore) are longer than the rest even at

the blastula stage, and their flagella are less movable. This differentiated part (larval sensory organ? neural plate?) can also be recognised in the subsequent stage.

First Pluteus stage.—The gastrula becomes concave on the ventral side; on the opposite (dorsal) side it becomes convex. The larva is now bilaterally symmetrical. The blastopore at first indicates the posterior end; then it shifts somewhat on to the ventral side on to a mound-like bulging of the body (**the anal area**), which lies posteriorly to the ventral depression. The anterior edge of this anal area becomes drawn out into two anteriorly diverging processes, the two posterior ventral arms

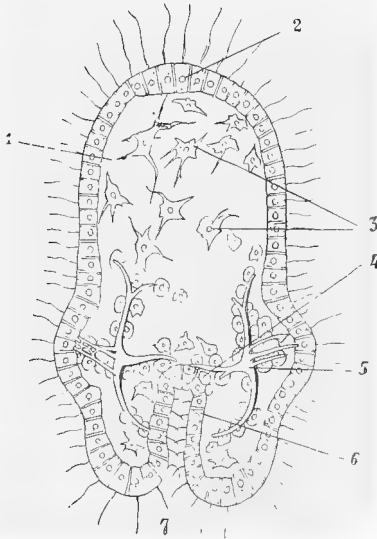

FIG. 416.—*Echinocyamus pusillus*, gastrula, forty hours after fertilisation (after Thélal). 1, Blastocoel; 2, frontal thickening of the ectoderm; 3, mesenchyme cells; 4, formation of these wandering cells at the base of the archenteron; 5, the first two calcareous spicules; 6, archenteron; 7, primitive mouth, blastopore.

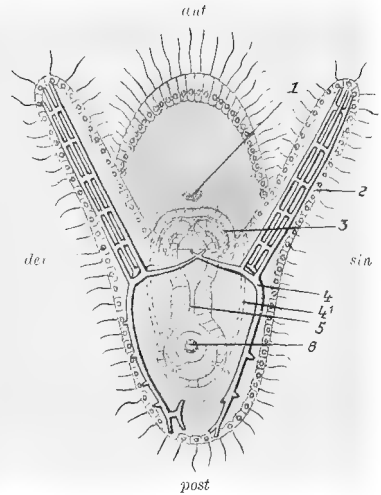

FIG. 417.—*Echinocyamus pusillus*, young Pluteus, about forty-eight hours after fertilisation (after Thélal), from the ventral side. 1, Rudiment of the larval mouth; 2, the first arms; 3, rudiment of the hydro-enterocoel at the base of the archenteron; 4, larval skeleton; 4', dorsal branches of the same; 5, archenteron; 6, primitive mouth, blastopore.

(Fig. 417). The circumoral ciliated ring, which is continued on to the arms, becomes raised above the general ciliated covering of the body.

During the first larval stage the following important internal changes take place. The two first lateral **calcareous spicules** develop in the mesenchyme and send supporting rods into the only two arms present at this stage, the posterior ventral arms. (The first rudiments of these two spicules can be made out even in the gastrula larva, Fig. 416.)

Formation of the hydro-enterocoel.—The anterior blind end of the archenteron has, on each side, a small outgrowth, which lengthens posteriorly. The archenteron becomes constricted immediately behind these outgrowths, which finally become separated from it in the form of a horse-shoe-shaped vesicle, with two limbs directed posteriorly and applied to the archenteron. This **hydro-enterocoel vesicle** at once divides into its two lateral limbs, forming two lateral hydro-enterocoel vesicles. In

certain species this division seems to take place as early as the constriction of the hydro-enterocœl from the archenteron.

From the very commencement of the formation of the hydro-enterocœl, the three sections of the intestinal canal, the **hind-gut**, the **mid-gut**, and the **œsophagus**, begin to be marked off by constrictions, which become more distinct. All three, especially the middle section (the stomach intestine), begin to widen out like vesicles. The blastopore having shifted, as larval anus, far from the vegetative pole ventrally to the centre of the anal area, the hind-gut is drawn up and forms an angle with the mid-gut (Fig. 418). After the hydro-enterocœl has been constricted off, the new blind end of the intestine bends ventrally and soon meets a small invagination of the ectoderm of the depressed ventral surface. These break through into one another, and the **larval mouth** thus enters into open communication with the lumen of the fore-gut.

During the latter part of the first larval stage, **contractile fibres** appear in the wall of the œsophagus, and enable this section of the intestine to contract strongly.

Of the two hydrocœl vesicles lying at the sides of the posterior portion of the fore-gut, that on the **left** opens outward by a **water pore** at the centre of the dorsal surface.

Second larval stage.—The two posterior dorsal arms grow out. They are supported by the rod-like processes of two new calcareous bodies, which have appeared in the mesenchyme. On the **left side**, in the angle between the posterior dorsal and the posterior ventral arms, an **ectodermal invagination** appears (Fig. 419, 3); this sinks into the blastocœl in the shape of a flask. This invagination plays an important part in the transformation of the larva into the young Echinoderm.

Third stage (fully-grown Pluteus larva).—The two anterior dorsal and the two anterior ventral arms continue to grow (cf. Figs. 400 and 401, p. 509). On the dorsal side, a fifth unpaired calcareous spicule arises, and, in the immediate neighbourhood of the water pore, sends off processes, two of which enter the anterior dorsal arms and support them. The body has shortened, and its posterior region has become rounded off.

Further differentiation of the hydro-enterocœl.—We resume the description of this organ from the stage in which it consisted of two lateral vesicles applied to the intestine. **Each vesicle now becomes divided by a constriction into an anterior and a posterior vesicle.** The two anterior vesicles lie at the sides of the posterior portion of the œsophagus, the two posterior at the sides of the stomach intestine. The left anterior vesicle opens outward through a water pore; the other three are in no way connected with the future water vascular system; they are distinguished as the right anterior, right posterior, and left posterior **enterocœl vesicles**. Somewhat later, **three vesicles are seen on the left side** (Fig. 419, 2, 4, 5). The anterior and middle vesicles are in communication, whereas the posterior is distinct, and becomes applied to the middle vesicle, assuming a crescent shape. The left

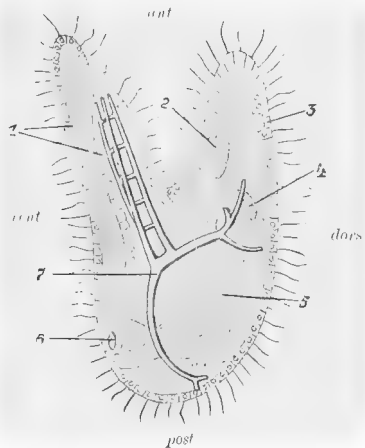

FIG. 418. — *Echinocyamus pusillus*, the same larva from the left side (after Théel). 1, The first larval arm; 2, rudiment of the larval mouth; 3, ectoderm; 4, hydro-enterocœl rudiment; 5, archenteron; 6, blastopore; 7, larval skeleton.

anterior (enterocoel) vesicle is the one which opens outward through the water pore; it, however, does not become the hydrocoel, but the middle vesicle (which is in communication with it) now represents the rudiment of the hydrocoel. It is probable that this is produced by constriction from the left anterior hydro-enterocoel vesicle.

On the left side, the development of the hydro-enterocoel is now as follows. The water pore leads into the posterior end of a left anterior enterocoel vesicle, which, again, communicates, by means of a constricted portion, with the hydrocoel

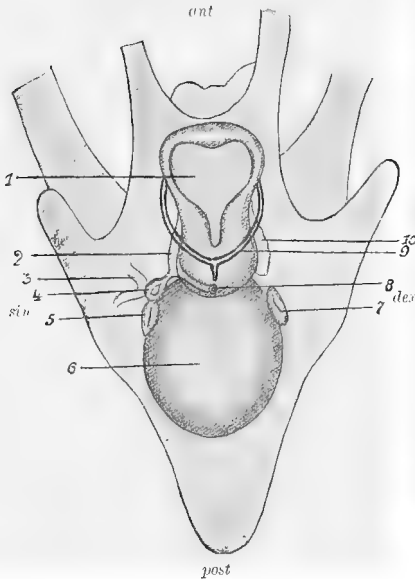

FIG. 419.—Dorsal aspect of an Echinoid Pluteus, to illustrate the relations of the hydro-enterocoel (after Bury). *ant*, Anterior; *post*, posterior; *sin*, left; *dex*, right; 1, larval oesophagus; 2, left anterior enterocoel; 3, ectodermal invagination; 4, rudiment of the hydrocoel; 5, left posterior enterocoel vesicle; 6, stomach-intestine; 7, right posterior enterocoel; 8, hydro-pore; 9, unpaired dorsal skeletal piece; 10, right anterior enterocoel. The arms are not fully represented.

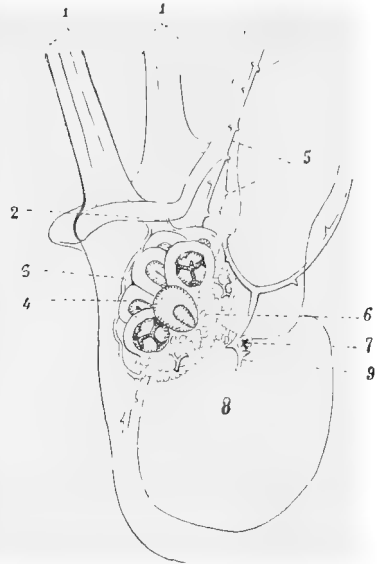

FIG. 420.—Rudiment of the Echinoid in the Pluteus larva of *Echinocyamus pusillus* (after Théel). The Pluteus is seen from the dorsal side, and only the left side is completely drawn. 1, Arms of the Pluteus; 2, aperture of invagination of the sac (3), whose floor will form the oral body wall of the Echinoid; 4, outgrowths of the hydrocoel, which push this wall before them and form the first ambulacral tentacles; 5, skeletal rods of the Pluteus; 6, hydrocoel; 7, hydro-pore; 9, portion of a skeletal piece lying in the neighbourhood of the hydro-pore, which will probably become the madreporite; 8, stomach-intestine.

vesicle. This latter is embraced posteriorly by the horse-shoe-shaped left posterior enterocoel. The stone canal does not arise out of the water pore, but out of the connecting piece between the left anterior enterocoel vesicle and the hydrocoel vesicle, which becomes drawn out into a canal. The left anterior enterocoel seems to become the madreporitic ampulla.

(The above description of the differentiation of the hydro-enterocoel must not be considered as fully established. The observations are not quite continuous, and do not all agree.)

Transformation of the Pluteus larva into the young Echinoid.—This metamorphosis is far from having been satisfactorily described, its investigation being exceedingly difficult.

An important part in the shaping of the Echinoid body is played by the above-mentioned **flask-like invagination of the ectoderm** on the left side. The thickening floor of this invagination grows towards the hydrocoel, and becomes externally applied to this latter as the "**Echinoid disc**". (Fig. 420). The thin lateral walls of the capacious flask, which is still connected by its neck with the larval ectoderm, are known as the **amnion**.

The **hydrocoel** vesicle assumes the **horse-shoe-shape**, and at the same time puts forth **five outgrowths** which push before them the Echinoid disc, *i.e.* the floor of

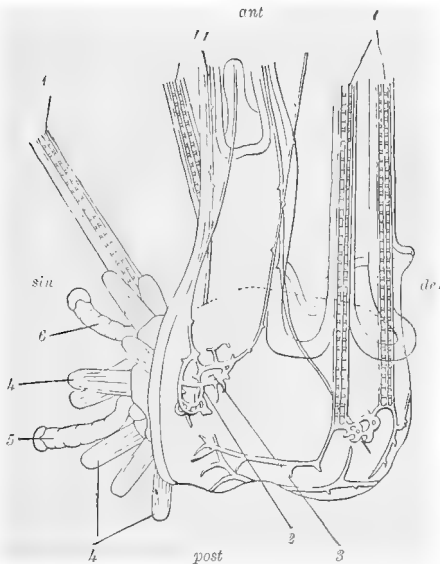

FIG. 421.—Dorsal aspect of a larva of *Echinocyamus pusillus*, about forty-five days old (after Théel). 1, The larval arms, with their calcareous rods; 2, unpaired calcareous rod, taking part in surrounding the dorsal pore (3); 4, spines; 5 and 6, primary tentacles of the young Echinoid; *ant*, anterior; *post*, posterior; *sin*, left; *dex*, right.



FIG. 422.—Lateral view of a very young Echinoid (*Echinocyamus pusillus*), forty-five days old (after Théel). The first tube-feet and spines of the Echinoid are seen, and, attached to its back, the remains of the calcareous rod of a larval arm.

the flask-like invagination. Five hollow tubes thus now project into the cavity of the flask, which continually becomes more and more spacious; these are the **five primary tentacles**, which receive their covering from the spreading Echinoid disc. This Echinoid disc forms the oral wall (that is, no doubt, only the epithelium and the nerves?) of the young Echinoid, while the apical wall is formed direct from the larval dorsal ectoderm of the *Pluteus*.

The fate of the amnion is differently described for different forms. Sometimes it is said to pass over into the young Echinoid, the amnion sac opening and spreading out, and yielding the circular integumental region between the apical and oral surfaces of the body. At other times, again, the amnion sac is said to remain closed

and the amnion, together with part of the larval integument, are lost when the larva changes into the young Echinoid.

The larval arms disappear, and their spicules are for the most part absorbed. As a rule, one or other of the arms of the *Pluteus* still adheres to the quite young Echinoid (Fig. 422).

The **intestine**, at least the **whole stomach**, the spreading enterocœl, and the growing hydrocœl are taken over into the young Echinoid; the latter, however, has, at first, neither mouth nor anus. In Echinoids, therefore, the larval mouth and anus do not pass direct into the corresponding organs of the adult.

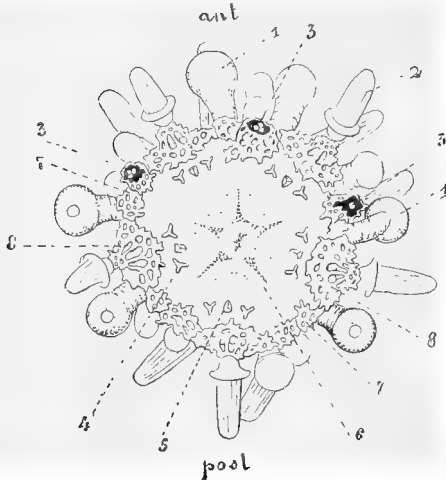

FIG. 423.—*Echinocyamus pusillus*, young Echinoid, about forty-five days old, from the oral side (after Théel). *ant*, Anterior unpaired ambulacrum; *post*, posterior unpaired interambulacrum; 1, tentacle; 2, spines; 3, spheridia in their niches; 4, pieces of the masticatory apparatus; 5, teeth; 6, oral integument, the mouth is not yet formed; 7, radial skeletal plates; 8, interradial skeletal plates.

of the larva, become the other **basals**. In their centre the **dorso-central** is soon distinguishable. On the oral side, in the peripheral part of the original Echinoid disc, where the primary tube-feet developed, the first **ambulacral** and **interambulacral plates** appear, with the rudiments of the **spines** and the **sphæridia**, both of which form independently over the plates (Fig. 423). In the future oral area, which is surrounded by a circle of ambulacral and interambulacral plates, thirty small calcareous centres form, three in each radius and three in each interradius; these are the **rudiments of the plates of the masticatory apparatus**. The **middle calcareous plates of the interradial** become the **teeth**.

Little or nothing is known of the ultimate fates of the other twenty-five pieces, or of the enterocœl, of the hydrocœl (*e.g.* the order of appearance of the tube-feet), or as to the appearance of the nervous system, the origin of the radial plates, etc.

D. Ontogeny of the Asteroidea.

Segmentation is total, and leads to the formation of a **cœloblastula**, through the invagination of which a **cœlogastrula** arises. The **formation of the mesenchyme** takes place in the manner already described for the *Holothurionidea* and the *Echin-*

Formation of the mouth and the definitive œsophagus.—According to one account, the œsophagus only grows out from the intestine after the horse-shoe-shaped hydrocœl has closed; it then passes through the water vascular ring and opens outward at the centre of the Echinoid disc through the definitive mouth.

The **pedicellariæ** arise very early. They are even occasionally seen on the dorsal side of an older *Pluteus* larva.

The **water pore** becomes the madreporite, and the unpaired spicule which, in the older *Pluteus*, arose in its immediate neighbourhood, changing into a lattice-like plate, becomes the **madreporitic basal**. Four other plates, which arise **over the right enterocœl**

oides, and commences either in the blastula stage or not until the gastrula stage. In the former case, that part of the blastoderm which becomes invaginated to produce the archenteron yields the mesenchyme, and, after invagination has taken place, continues to produce it. In the second case, also, the endoderm is the place of formation of the mesenchyme cells, which wander into the blastocoel. Such observations, however, seem to point to the fact that, although most mesenchyme cells arise from the endoderm, the ectoderm also takes part in their formation.

In the older gastrula stage of *Asterias vulgaris*, the ectoderm seems to be thickened at the (aboral) pole opposite to the blastopore. This may be the rudiment of the neural plate.

As a further illustration of the development of the Asteroidea, we shall utilise the observations made on *Asterina gibbosa*, in which form, however, a typical

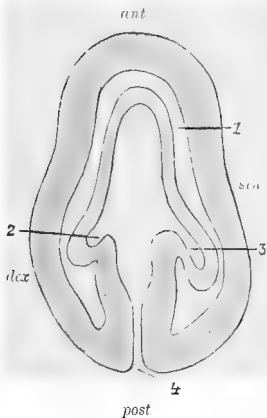

FIG. 424.—*Asterina gibbosa*, gastrula four days old; approximately horizontal longitudinal section, from the ventral side (after Ludwig). *ant*, Anterior; *post*, posterior; *dex*, right; *sin*, left; 1, segmentation cavity; 2 and 3, right and left coelomic outgrowths of the archenteron; 4, blastopore.

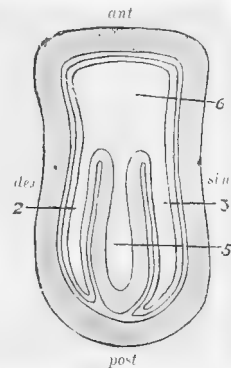

FIG. 425.—*Asterina gibbosa*, larva at the end of the fourth day, horizontal longitudinal section seen from the ventral side (after Ludwig). The enterocoel outgrowths have grown in length. 2, right enterocoel outgrowth; 3, left or hydro-enterocoel outgrowth; 5, intestine; 6, anterior unpaired coelom. The coelom is still in open communication with the intestine.

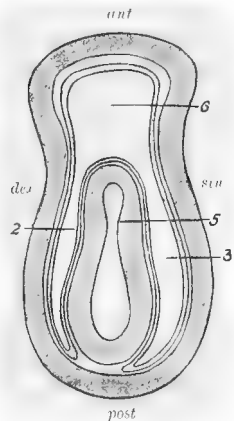

FIG. 426.—*Asterina gibbosa*, larva at the commencement of the fifth day, horizontal longitudinal section (after Ludwig). The enterocoel has become constricted off from the intestine. Lettering as before.

Bipinnaria larva does not attain development. In the course of the description observations made on other Asterooids will be referred to.

In the ovoid gastrula of *Asterina*, the blastopore does not lie altogether at the posterior pole, but is shifted somewhat on one side, which in the further development of the animal becomes distinguishable as the ventral side. Two sections can be made out in the archenteron, a short cylindrical commencement (posterior section), and a vesicular blind terminal part (anterior section). This description applies to the gastrula on the second day.

Third day.—The rudiment of the hydro-enterocoel vesicle.—The anterior vesicular section of the archenteron, which represents the rudiment of the hydro-enterocoel vesicle, bulges out posteriorly on each side, while its wall becomes thinner (Fig. 424). The two bulgings grow out longitudinally backwards, at the sides of the posterior part of the archenteron, and become the two hydro-enterocoel

vesicles, which continue to grow backward in proportion as the posterior part of the archenteron, the **larval intestine**, grows anteriorly (Fig. 425).

Fourth day.—The whole hydro-enterocœl becomes constricted off from the larval intestine, and is now found as a large vesicle occupying the anterior part of the larval body, and continued posteriorly in the two long hydro-enterocœl vesicles, the one on the left being longer than the one on the right (Fig. 426).

An invagination of the ectoderm, somewhat anteriorly to the middle of the ventral side, represents the rudiment of the **larval mouth and œsophagus**, and, towards the end of the fourth day, breaks through into the larval intestine.

Anteriorly a **cushion-like thickening** of the body appears encircling a depression.

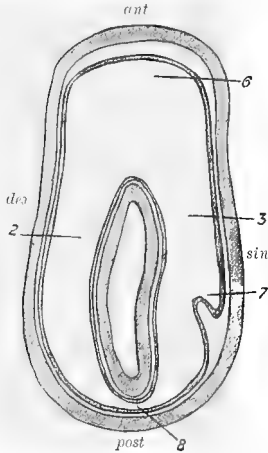

FIG. 427. — *Asterina gibbosa*, larva five days old, horizontal longitudinal section seen from the ventral side. First rudiment of the hydroœl outgrowth (7) on the left of the hydro-enterocœl vesicle (3). The two enterocœl vesicles have opened into one another posteriorly at 8.

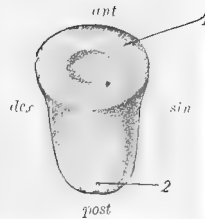

FIG. 428. — Larva of *Asterina gibbosa* four days old, just hatched, from the ventral side (after Ludwig). 1, Larval organ; 2, blastopore. Here, and in the following figures, *ant* = anterior; *post* = posterior. ;



FIG. 429. — *Asterina gibbosa*, larva six days old, from the left side (after Ludwig). *v*, Ventral side; *d*, dorsal side; 1, larval organ.

This circular cushion, the rudiment of the **larval organ**, slants from above anteriorly to below posteriorly (Figs. 428-430).

At the end of the fourth day the embryo leaves the egg-envelope, and swims about freely by means of the cilia covering its entire surface.

Fifth day.—The two hydro-enterocœl vesicles grow round the larval intestine above and below.—Where they meet below, somewhat to the left of the median line, they form a **ventral mesentery**, which, however, rapidly disappears, the two vesicles opening into one another at this point. Above the intestine a dorsal mesentery, lying to the **right of the median line**, arises in a similar manner, and persists.

The left hydro-enterocœl vesicle bulges out laterally somewhat behind its middle point. This bulging is the **rudiment of the hydroœl** (Fig. 427).

At this stage, therefore, the hydro-enterocœl consists of the following sections in widely open communication with one another.

1. **Anterior unpaired enterocœl** (6 in Figs. 426, 427), lying in the larval organ.
2. **Right enterocœl vesicle** (2 in the figs.), anteriorly in wide open communication with No. 1, and ventrally in open communication with—

3. **The left enterocœl vesicle** (3 in the figs.). This vesicle, again, has an outgrowth (7) on the left, which is—

4. **The hydrocœl vesicle.**

Simultaneously with the formation of the hydrocœl rudiment, that of the **water pore** appears dorsally, somewhat to the left of the median line, as an **invagination of the ectoderm**, which grows towards the left enterocœl, and breaks through into it.

Sixth and seventh day.—The **outer form** of the larva has been considerably modified on the fifth day. The larval organ has increased in size, and its sloping circular ridge projects considerably beyond the surface of the larval body.

The **rudiment of the hydrocœl** has grown out further backward, but is still anteriorly in open communication with the left enterocœl. Five outgrowths (Nos. I-V in Fig. 435) now appear at its posterior edge; these are the rudiments of the five radial vessels. The water pore (dorsal pore, madreporite) still leads into the



FIG. 430.—The same specimen of *Asterina gibbosa* viewed from the left and from the ventral side. 1, Larval organ with its dorsal and ventral lobes; 2, larval mouth.



FIG. 431.—*Asterina gibbosa*, larva at the beginning of the eighth day, from the left side; the larval organ is very largely developed (after Ludwig).

left enterocœl. “A channel develops on that wall of the hydrocœl which faces the interior of the body, which soon closes to form a canal.” This canal runs towards the point where the dorsal pore opens into the left enterocœl. One end of this canal remains in open communication with the hydrocœl, while the other enters the enterocœl quite near the aperture of the dorsal pore. This canal is the **stone canal** of the future Asteroid. The dorsal pore of the larva does not thus lead direct into the stone canal, but enters it **through the left enterocœl** (Fig. 436). Only at a later stage does the dorsal pore come into direct connection with the stone canal.

Formation of the hydro-enterocœl in other Asteroids.—In the larva of *Asterias vulgaris* also, the entero-hydrocœl arises in the form of two lateral diverticula of the blind and somewhat swollen archenteron, whose wall has become thinner. The two diverticula soon become constricted from the archenteron, and become distinct vesicles. Each sends off an **outgrowth** towards the dorsal surface, a **growth of the ectoderm** running in towards it. The two meet and fuse, become hollow, and form the **stone canal** with the water pore. Thus in the young *Bipinnaria* larva of *Asterias vulgaris*, the **bilateral symmetry** is so marked that a right as well as a left stone canal attains development (Fig. 432). The right pore, however, soon disappears, and the right canal somewhat later.

The two lateral mesoderm vesicles lengthen and fuse in front of and above the mouth, and, further, surround the intestine. On the left vesicle (hydro-enterocœl vesicle) a transverse constriction appears, which finally divides it into two vesicles, an **anterior**, which at its posterior end opens outward through the stone canal and water pore, and a posterior (Fig. 433).

Further development of the hydrocœl in *Asterina gibbosa*.—After the seventh day the five outgrowths of the hydrocœl (Figs. 437-440) become **trilobate**, and later have **five lobes**. The unpaired terminal lobe of each outgrowth is the rudiment of the **terminal tentacle**, the paired lobes are the rudiments of the **first two pairs**

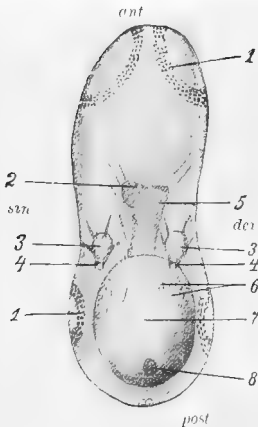

FIG. 432.—Larva of *Asterias vulgaris*, about four days old, from the dorsal side (after Field). 1, Circumoral ciliated band; 2, mouth; 3, right and left hydro-enterocœl vesicles, with their hydro-pores (4); 5, oesophagus; 6, mesenchymatous muscle fibres; 7, stomach intestine; 8, anus. The mouth and the anus lie on the side turned away from the reader.

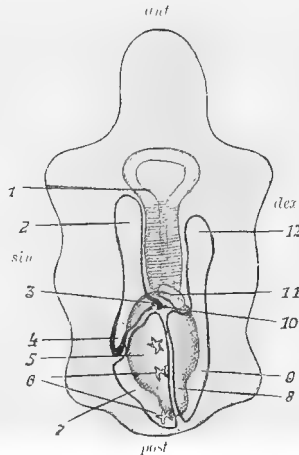

FIG. 433.—Dorsal aspect of a *Bipinnaria* larva to illustrate the development of the hydro-enterocœl (after Bury). 1, Larval oesophagus; 2, left anterior enterocœl; 3, hydro-pore; 4, rudiment of the hydrocœl; 5, stomach intestine; 6, terminals; 7, left posterior enterocœl vesicle; 8, dorsal mesentery; 9, right posterior enterocœl vesicle; 10, madreporite; 11, blood vesicle, pulsating vesicle; 12, right anterior enterocœl.

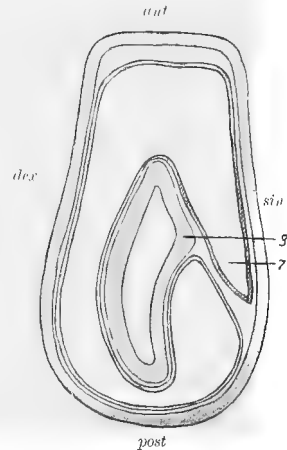

FIG. 434.—*Asterina gibbosa*, larva six days old, horizontal longitudinal section from the ventral side (after Ludwig). The hydrocœl (7) has become constricted posteriorly from the left enterocœl. An outgrowth of the intestine (8) is the first indication of the future oesophagus of the Asteroid.

of tube-feet. Each new pair of feet arises between the terminal tentacle and the foot last formed.

The five outgrowths of the hydrocœl become **outwardly** visible, bulging out the body. On the left side of the seven-days-old larva there are thus visible five flat protuberances arranged in a convex arch directed upward and backward; these protuberances become more marked on the eighth day, and are then divided either into three or five lobes each (Figs. 438-440). These are the first indications of the young Asteroid, the rudiments of its ambulacral arms.

The rudiment of the definitive oesophagus appears in the form of a bulging of the left side of the archenteron, that facing the hydrocœl. This arises in the region which corresponds with the anterior part of the gastrula intestine (Fig. 434, 8), and **has nothing to do with the larval oesophagus**. This latter degenerates on the eighth or ninth day, and the **larval anus** also disappears.

The **larval organ** attains its greatest development on the eighth or ninth day, it diminishes in size later, and finally is altogether resorbed, without giving origin to any organ of the young Asteroid. Its wall consists of three layers: (1) an outer ciliated larval epithelium, (2) the inner epithelium of the unpaired section of the enterocœl which fills up the whole cavity of the larval organ, and (3) between these two layers, one of mesenchyme cells differentiated into muscle fibres. The larva uses the organ for locomotion and for temporary attachment.

Soon after the ambulacral (oral) rudiments of the arms have appeared on the left side in the form of the five protuberances (1-5, Fig. 437) mentioned above, **five mesenchyme thickenings form, which also bulge out the ectoderm**, and represent the **antiambulacral (apical, dorsal) arm rudiments (I-V)**. Three of these are

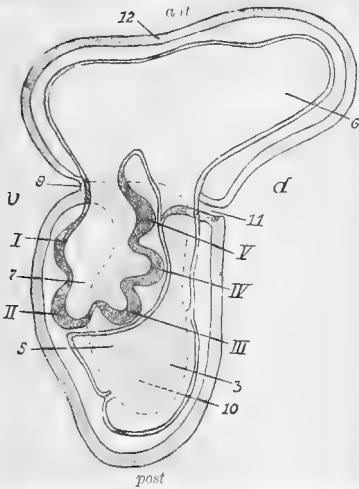

FIG. 435.—*Asterina gibbosa*, larva six days old, seen from the left (after Ludwig). I-V, The five primary bulgings of the hydrocœl (7); 3, the left enterocœl, opening outward through the hydropore or dorsal pore (11) on the dorsal side; 5, intestine; 6, anterior enterocœl, enterocœl of the larval organ; 9, larval mouth; 10, mesentery; 11, dorsal pore; 12, ectoderm of the larval organ.

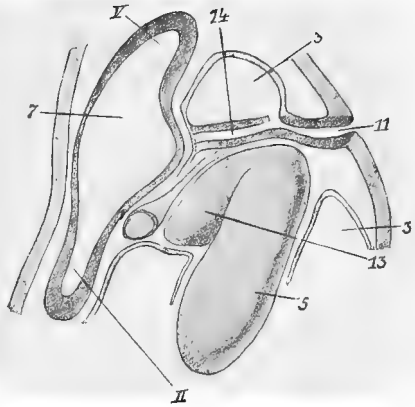

FIG. 436.—*Asterina gibbosa*, larva eight days old, seen from the dorsal and somewhat from the left side, optical longitudinal section (after Ludwig). II, V, second and fifth primary bulgings of the hydrocœl; 3, left enterocœl; 5, intestine; 7, hydrocœl; 11, dorsal pore; 13, œsophagus of the Asteroid; 14, rudiment of the stone canal.

found on the left ventral side, and two somewhat to the left of the median line, on the dorsal side of the larva. The five stand in a curved row, the curve opening anteriorly, the plane in which they lie making an angle with that of the ambulacral arm rudiments.

These two sets of arm rudiments then shift towards one another, until their planes are nearly parallel.

Appearance of the skeletal plates.—As early as the time when the hydrocœl bulgings begin to become trilobate, a small calcareous body appears in the mesenchyme on each side of each primary bulging, on the proximal side of the lateral secondary bulgings (*i.e.* of the rudiments of the first tube-feet). These are the rudiments of the first five pairs of ambulacral plates. When a second pair of lateral lobes appear distally to the first pair on each hydrocœl bulging, a second pair of

calcareous bodies form between this and the first pair; these are the rudiments of a second pair of ambulacral plates, and so on.

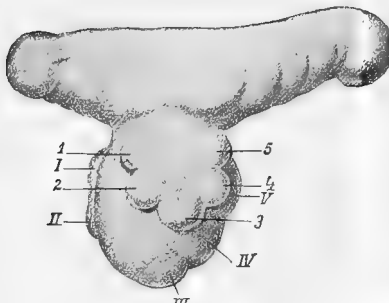

FIG. 437.—*Asterina gibbosa*, larva at the end of the eighth day, from the left side (after Ludwig). 1-5, The ambulacral rudiments of the arms over the primary hydrocoel bulgings; I-V, the antiambulacral rudiments of the arms.

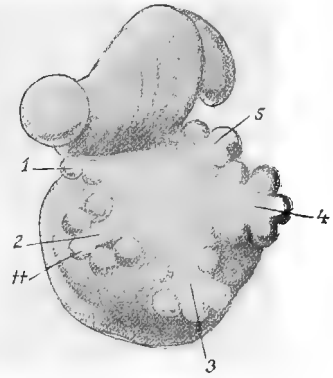

FIG. 438.—*Asterina gibbosa*, larva ten days old, seen from the left and somewhat from the ventral side (after Ludwig). The ambulacral arm rudiments (1-5) now have five lobes. tt, Terminal lobe, terminal tentacle.

As early as the seventh day, the rudiments of the apical skeletal plates, eleven in number, appear. These eleven rudiments lie superficially below the ectoderm of

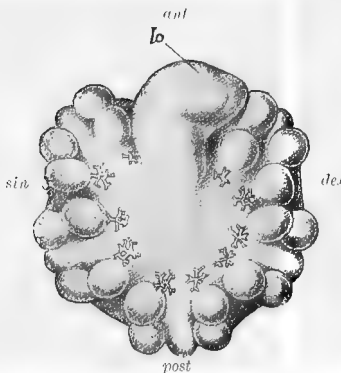

FIG. 439.—*Asterina gibbosa*, young Asteroid, with much reduced lateral organ (*lo*) at the end of the tenth day, from the left side (after Ludwig). The first rudiments of the ambulacral skeleton have appeared (five pairs of ambulacral plates). The mouth of the Asteroid has not yet formed.

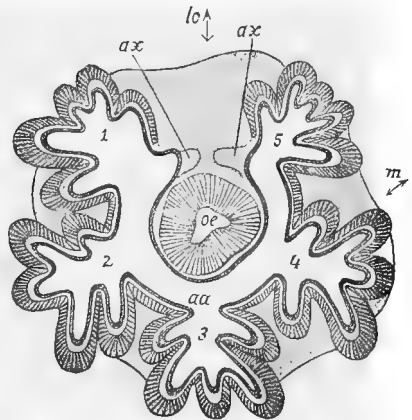

FIG. 440.—*Asterina gibbosa*, young Asteroid eleven days old, horizontal section immediately below the oral surface (after Ludwig). 1-5, The five five-lobed outgrowths of the hydrocoel ring (*aa*) which has not yet closed; *ax*, the two outgrowths at the two ends of the horse-shoe-shaped hydrocoel, which by growing out towards one another and opening into one another close the hydrocoel; *lo*, interradius of the larval organ; *m*, interradius of the madreporite.

the apical region. Five of them appear in the mesenchyme of the five apical brachial rudiments, and become the terminals of the Asteroid arms, always remaining at the

tips of the growing arms (Fig. 441, t_1-t_5). Five others appear within the anteriorly open curve made by the five terminals, and alternate with these latter; these are the **primary interradials** (basals) of the dorsal surface of the Asteroid disc (ba_1-ba_5). One of these (ba_3) always lies on the right near the dorsal pore, and, growing round this pore later, becomes the **madreporitic plate**. The eleventh plate lies in the centre of the two curves just mentioned, and is the rudiment of the central plate (ce).

The basals and the central appear on the right side of the larva over the **right enterocoel**. The relation of the terminals to the enterocoel has not yet been certainly ascertained. It has been proved that in the *Bipinnaria* they appear even before the rudiment of the five hydrocoel outgrowths, above the **left enterocoel**.

Metamorphosis of the larva into the young Asteroid.

This is throughout a continuous process. Only two parts of the larva are **not taken over** by the young Asteroid, viz. the **larval organ** and the **larval oesophagus**, which are gradually resorbed. The anus of the Asteroid does not indeed develop out of that of the larva, but at the same point.

The last remains of the larval organ are found on the ventral side of the young Asteroid lying excentrically in that interradius in which the hydrocoel closes to form the water vascular ring; viewing the body apically this interradius follows the madreporitic interradius on the right (*cf.* Figs. 440, 441; the arrows indicate these interradii).

The **mouth** and **oesophagus** of the young Asteroid arise by the outgrowth from the left side of the archenteron, mentioned above, reaching the body wall and finally breaking outward through it (thirteenth or fourteenth day). The oesophagus is then grown round by the hydrocoel, which closes to form the **water vascular ring**. Only shortly before this takes place does the hydrocoel become entirely constricted off from the enterocoel, and the dorsal pore comes into direct connection with the **stone canal**.

The intestine widens into a sac, five radially placed outgrowths appearing in it, directed towards the rudiments of the arms. At the point where the larval anus formerly lay, in the interradius between the first and second apical brachial rudiments, the **definitive anus** breaks through.

The two curves formed by the **five apical** (antiambulacral) and the **five oral** (ambulacral) **arm rudiments** approach one another more and more, the zone of the body wall which separates them (and which is, with regard to the animal, equatorial) becoming continually narrower. Finally, the edges of the apical and those of the oral rudiments touch to form the **young Asteroid**. During this process the arm rudiments unite in the following peculiar manner: Number 1 unites with II, 2 with III, 3 with IV, 4 with V, and 5 with I.

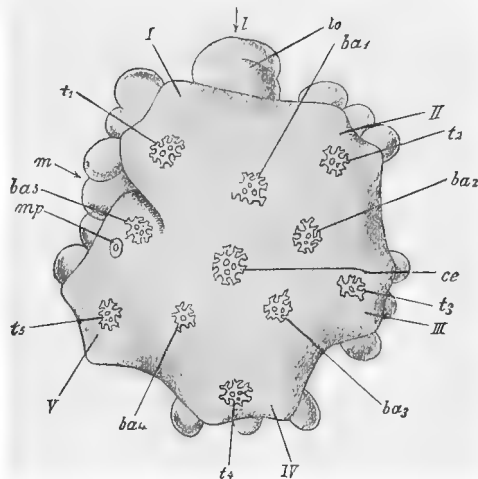

FIG. 441.—*Asterina gibbosa*, young Asteroid ten days old, dorsal view (after Ludwig). I-V, The antiambulacral arm rudiments; *l*, interradius of the larval organ (*lo*); *m*, interradius of the madreporite (*mp*); ba_1-ba_5 , the five basals; t_1-t_5 , the five terminals; *ce*, central.

In the meantime new pairs of outwardly projecting lateral lobes (rudiments of tube-feet) have appeared on the hydrocœl bulgings, which have developed into the radial water vascular trunks; these new growths always appear distally to those already formed and proximally to the median terminal lobe (terminal tentacle).

The **nervous system** develops as an epithelial circular cushion in the oral area, even before the mouth has broken through its centre.

The **skeleton** receives the addition of fifteen new plates on the apical side outside of the basals, five being radial and five pairs interradial.

In each interradius orally (on the thirteenth day) a plate forms between the separate proximal pairs of ambulacral plates. These five plates are the rudiments of the **orals (odontophores)**.

At the sides of the ambulacral plates the **adambulacral plates** appear. The remaining pairs of ambulacral and adambulacral plates arise in the same order as the pairs of tube-feet, always proximally to the terminals of the arms, and distally to those already formed.

The five first and the five second pairs of ambulacral plates unite with the five first pairs of adambulacral plates to form the **oral skeleton**.

The five radial outgrowths of the intestine quickly grow into the arms, forking, and thus producing the ten brachial diverticula of the digestive sac. Five pairs of small interradial outgrowths on the water vascular ring represent the rudiments of **Tiedemann's bodies**. None of the tube-feet at first have suckers. The formation of the nerve ring is followed by that of the radial nerve ridges, which, like the former, are epithelial in position, persisting as such even in the adult Asteroid. The **continuous ciliated covering** of the larva is at no time interrupted, but passes direct into the ciliated covering of the Asteroid.

We shall not enter upon the accounts given of the rise and development of the **blood vascular system**, since there is nothing more problematical in the anatomy of the adult Asteroids than this system.

Where, among Asteroids, a typical *Bipinnaria* larva is developed, the metamorphosis which produces the young Asteroid seems to resemble in essentials that of *Asterina*. The rudiment of the young Asteroid is found in the posterior part of the larva which contains the swollen mid-gut. At first, as in *Asterina*, this rudiment is double, *i.e.* it consists of an oral rudiment, arising close to the hydrocœl, and an apical rudiment, the two uniting round the intestine. The larger anterior portion of the larval body, together with the ciliated rings of the *Bipinnaria*, are, like the larval organ of *Asterina*, gradually resorbed.

E. Ontogeny of the Ophiuroidea.

According to the present state of our knowledge the development of the Ophiuroidea does not appear to differ so greatly from that of the *Asteroides*, in spite of the difference in shape of the larvæ, as to need detailed description. We shall therefore limit ourselves to a few points.

Development of the hydro-enterocœl.—The first rudiment of the **hydro-enterocœl** has not been observed with as much certainty as could be desired. In the quite young *Pluteus* larva an enterocœl vesicle lies at each side of the œsophagus. Somewhat later the larva possesses, besides this pair of vesicles, another pair of enterocœl vesicles at the sides of the stomach-intestine, these latter having, as it appears, been constricted off from the former. The left anterior vesicle at this stage enters into communication with the exterior through the dorsal pore (water pore). On the left side there now arises, between the anterior and the posterior enterocœl vesicles, apparently by constriction from the latter, a third new vesicle,

the **hydrocœl vesicle** (Fig. 442). This at once becomes entirely distinct, and lengthens out anteriorly below the left anterior enterocœl vesicle. At its outer left edge it then produces **five outgrowths, the rudiments of the radial portions of the water vascular system**. Between the fourth and fifth outgrowths (reckoning from before backward) a dorsally directed diverticulum further grows out from the hydrocœl vesicle, which, after a very short course, comes in contact with the left anterior enterocœl vesicle, and opens into it immediately below the aperture of the water pore. This diverticulum is the rudiment of the **stone canal**. Its connection with the dorsal pore (madreporite) is thus secondary, and is brought about by means of the left anterior enterocœl, which no doubt becomes the ampulla.

The long hydrocœl vesicle, with its five outgrowths, then clasps the larval œsophagus like a halter, and grows round it; this **larval œsophagus** apparently becomes the **definitive œsophagus**, while no definitive **anus** replaces that of the larva.

First appearance of the plates of the skeleton.—Soon after the formation of the stone canal, ten skeletal plates appear on the *Pluteus* larva, five on the left and five on the right side, *i.e.* above the left and right posterior cœlomic vesicles. The five on the right side are the **radials** of the apical system; the five on the left are the **terminals**. In the middle of the right side the rudiment of the central plate then appears, and on the left side, immediately in front of the water pore, another plate appears, which is the **fifth oral**, the one which becomes the madreporitic plate. The madreporite thus belongs ontogenetically to the oral system of plates. The other parts of the skeleton form only after the metamorphosis.

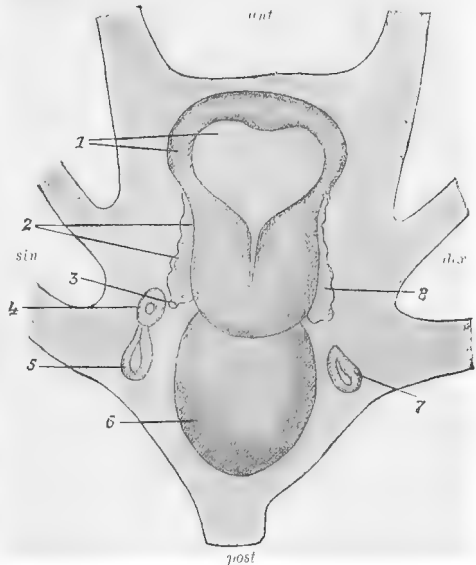

FIG. 442.—Dorsal aspect of a young Ophiuroid *Pluteus*, to illustrate the hydro-enteroœl (after Bury). 1, Larval œsophagus; 2, left anterior enterocœl; 3, hydropore; 4, hydrocœl; 5, left posterior enterocœl vesicle; 6, stomach-intestine; 7, right posterior enterocœl vesicle; 8, right anterior enterocœl vesicle.

F. Ontogeny of the Crinoidea.

The **Ontogeny of *Antedon*** alone has been investigated.

1. Embryonic Development.

Here also a **cœlogastrula** is formed by the **invagination of a cœloblastula**. The transverse slit-like blastopore indicates the **posterior end** of the larva, which at a later stage becomes bilaterally symmetrical. The **segmentation cavity** is filled by an albuminiferous gelatinous mass (**gelatinous nucleus**).

After the process of invagination has begun, the **formation of mesenchyme** also commences, proceeding from the blind end of the archenteron, which here is bilaminar. The cells of the layer which is turned to the segmentation cavity wander into that cavity, *i.e.* into the gelatinous nucleus which fills it, and become mesenchyme cells (Fig. 443). The formation of mesenchyme proceeds actively during the whole process of invagination along the whole archenteron, but chiefly at its base. Here, indeed, the formation of mesenchyme is observed long after important processes of separation and differentiation have been accomplished in other parts of the archenteron.

The formation of mesenchyme takes place here more actively than in any other Echinoderm in which it has been observed, so that the large segmentation cavity soon appears to be crowded with mesenchyme cells.

The **ectoderm** becomes covered with **cilia**.

The **blastopore** closes **completely** in the course of the second stage of develop-

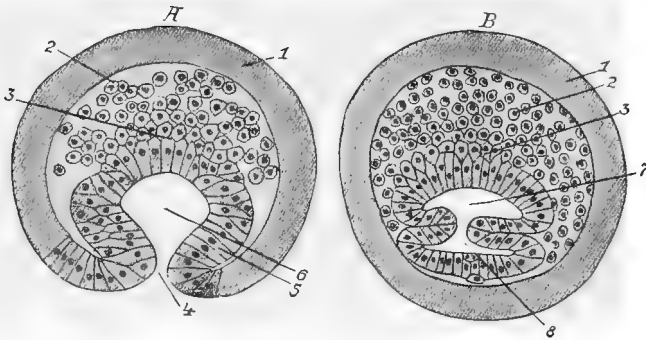

FIG. 443.—A, Horizontal longitudinal section through an embryo (gastrula) of *Antedon* twenty-six hours old; B, the same of one forty-eight hours old, in which the archenteron, which has become constricted off, is divided into two sections (after Seeliger). 1, Ectoderm; 2, mesenchyme cells; 3, place of formation of the mesenchyme cells at the base of the archenteron; 4, blastopore; 5, endoderm; 6, archenteric cavity; 7, mesentero-hydrocoel vesicle; 8, enterocoel vesicle.

ment. The **archenteron** then lies as a **closed vesicle** in the posterior region of the segmentation cavity.

An important process soon takes place. The archenteric vesicle or **archenteron** becomes constricted by a circular furrow (Fig. 443 B). This constriction leads to a complete division of the archenteron into an **anterior and a posterior vesicle**. The anterior is somewhat larger than the posterior; the formation of the mesenchyme continues actively on its wall (Fig. 444).

From the anterior vesicle are derived the **intestine** and the **hydrocoel**; from the posterior the **cœlom** with the **chambered sinus**, etc. We here have a remarkable difference between *Antedon* and other Echinoderms, in which latter, as above described, the anterior blind end of the archenteron always yields the cœlom.

The anterior vesicle is in close proximity to the ectoderm, on the **ventral side**.

The posterior vesicle becomes a transversely placed tube, whereas the anterior is produced into a horn, both dorsally and ventrally. These **two horns** clasp the posterior vesicle from its anterior side. The larva is now distinctly **bilaterally symmetrical** (Fig. 444).

The next changes to occur are the following:—

The two horns of the anterior vesicle grow out towards one another round the posterior vesicle until they touch, and so form a **hollow ring** surrounding the posterior vesicle, but not closed posteriorly.

The posterior vesicle (enterocoel vesicle) assumes the shape of a dumb-bell, its two lateral parts swelling up, while the transverse connecting piece becomes narrower. It is this connecting piece which becomes encircled by the anterior vesicle (Fig. 444).

The ectoderm thickens on the ventral side.

The germ, which till now is approximately spherical, begins to **lengthen** from before backward (in the direction of the principal axis).

The anterior vesicle forms a large ventrally directed outgrowth, the **first rudiment of the hydrocoel** (Fig. 445, 3). A small outgrowth of its anterior wall is the rudiment of a sinus, which has been called by some the **parietal cavity**, and by others the **anterior enterocoel** (2). The circular anterior vesicle itself becomes the intestine (5, 7).

In the posterior (enterocoel) vesicle the two lateral swellings increase in size, while the connecting piece becomes thinner and thinner, and finally, at a later stage, entirely disappears. **The enterocoel vesicle is thus divided into a right and a left enterocoel sac.**

During the next period, which more or less corresponds with the fourth day of development, the embryo increases somewhat more in length. Anteriorly, in the frontal region, *i.e.* at the end of the embryo diametrically opposite to the point where the now vanished blastopore lay, a **ciliated tuft** forms. Ciliated rings appear in the arrangement characteristic of the free-swimming larva (*cf.* Fig. 402, p. 510).

The ectoderm which carries the neural tuft thickens (**neural plate**), becomes multilaminar, and at the same time appears to be slightly depressed (Figs. 446 and 447). The deep cells become **ganglion cells**, and **nerve fibrillæ** also appear below the surface, closely applied to the neural plate and formed by the ectoderm; these are the **rudiments of the larval nervous system**.

Ventrally from the neural plate, close behind it in the median line, a pit-like depression forms; this is the **adhesive pit**, so called because, at a later stage, the free-swimming larva attaches itself by means of it.

Another depression, which rapidly deepens and increases in circumference, lies in the thickened ventral ectoderm, and is the rudiment of the vestibule, whose significance will be explained later.

The two **cœlom sacs** have become completely detached, the connecting piece having disappeared. That on the **right** spreads chiefly dorsally forward into the segmentation cavity and then over the intestine, even crossing the median line on to the left side. The **left** cœlom sac, however, spreads chiefly backward and grows round the intestine posteriorly like a cap, until it touches the posterior wall of the right sac. Dorsally it touches the latter somewhat to the left of the median line, and a **mesentery** is thus formed which runs dorsally somewhat to the left of the

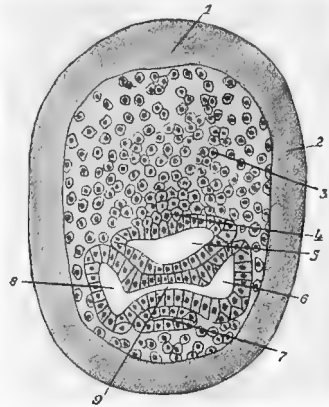

FIG. 444.—Horizontal longitudinal section through an embryo of *Antedon*, fifty-seven hours old (after Seeliger). 1, Point at which the neural plate becomes differentiated; 2, ectoderm; 3, mesenchyme; 4, place of formation of the mesenchyme; 5, rudiment of the intestine; 6, rudiment of the left cœlom; 7, ventral outgrowth of the mesentero-hydrocoel vesicle; 8, rudiment of the right cœlom; 9, transverse duct, connecting the two rudiments of the cœlom.

median line, but on the posterior side shifts the more to the right the nearer it approaches the ventral side. This is the **principal mesentery**. Ventrally the two cœlom sacs still remain far apart.

In the anterior vesicle, the **hydrocœl rudiment**, together with the rudiment of the **parietal sinus**, becomes separated from the rudiment of the intestine. After this separation has taken place, the hydrocœl vesicle still remains for a short time in open communication with the parietal sinus.

The **hydrocœl vesicle** lies close below the thickened ventral ectoderm, shifted somewhat far to the left.

The rudiment of the **parietal sinus** becomes a transverse tube.

The **rudiment of the intestine** changes shape. It is no longer, as before, an incomplete hollow ring, placed vertically, through which the connecting piece of the two cœlom vesicles passed (Fig. 445). The connecting piece having degenerated, the lumen of the tubular ring has room to expand from before backward, until the hollow ring becomes a vesicle.

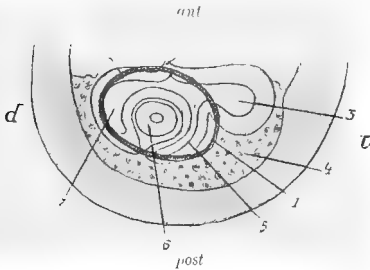

FIG. 445.—Posterior end of an embryo of *Antedon* sixty hours old, seen from the right side (after Seeliger). 1, The outline of the right cœlom sac; 2, rudiment of the parietal sinus; 3, rudiment of the hydrocœl; 4, mesenchyme; 5, ventral, and 7, dorsal process of the mesentero-hydrocœl vesicle; 6, connecting duct between the right and the left cœlom sacs.

As a rule (with the exception of the first oral, which indicates the end of the left side of the arch) the five orals lie round the left cœlom sac.

The **five basals** have exactly the same arrangement as the five orals, merely lying somewhat further forward than the latter. All of them, except the first basal, lie above the right cœlomic vesicle.

The 3-5 **infrabasals** again, which are still extremely small, lie in front of the basals, but further below the surface of the embryo.

In the anterior half of the embryo the infrabasals are followed by the **row of stalk plates**. This row forms an arch which is concave towards the ventral surface, so that the most anterior, the pedal, plate, lies near the floor of the vestibular invagination.

The newly-arising **skeletal plates** of the stalk appear at the posterior end of the row, generally (but not exclusively) immediately in front of the future centrodorsal, between it and the last formed most posterior stalk plate.

Up to this time the embryo has lain enclosed in the egg-membrane, on the pinule of the mother, but it is now ready to be hatched. Even at this stage its organisation leads to the conjecture that the calyx will be produced from the larger posterior half, which alone contains the internal rudiments, while the stalk of the future attached larva will be produced from the anterior half.

2. The Free-swimming Larva (Figs. 402 (p. 510), 446, 447, 448).

The external form of the free-swimming larva has already been described on p. 510.

The **duration of this manner of life** differs greatly in individuals of the same brood, varying from a few hours to several days.

Ectoderm.—For the ciliated bands, see above, p. 510.

In the intermediate zones, which are free from cilia, a fine cuticle becomes differentiated from the ectodermal epithelium, the cells of which later begin to secrete a homogeneous substance which separates cell from cell, so that the epithelium comes to resemble a connective tissue.

The **neural plate**, the **neural tuft**, and with them the **larval nervous system** attain their highest development at this stage, but undergo complete degeneration in the next. The ganglion cells below the neural plate increase in number, and the layer of nerve fibres spreads out over the whole anterior end of the larva. Fine nerve trunks run to the ciliated rings, and two specially strong ventral nerve trunks run back at the sides of the vestibular invagination, their anterior parts being beset with isolated ganglion cells.

The **adhesive pit** becomes larger and deeper, and towards the end of this period loses its ciliation and assumes a **glandular** character.

The **vestibular invagination** spreads over the greater part of the ventral side. It closes and becomes a tube, the lateral edges of the invagination growing towards one another and fusing in the median line. This process takes place from behind forwards, and is not fully completed during this period, a small aperture being retained anteriorly. The ciliation of the vestibule disappears.

The **intestine** alters its shape. It spreads out somewhat, assuming first the form of a hollow plate, with the concavity directed ventrally and the convexity dorsally. In the ventral concavity lies the hydrocoel vesicle. At a later stage the intestine again becomes rounded and vesicular.

The two **enterocoel sacs** continue to change their positions and to spread out. The right vesicle produces anteriorly five tubular outgrowths, which become grouped round the principal axis. These five tubes arise, widened like funnels, from the right cœlom, then narrow anteriorly, and, losing their lumina, run out as strands. They are the **rudiments of the chambered sinus**.

The **skeletal pieces of the stalk** are at this time horse-shoe-shaped, and tend to enclose the five tubes of the chambered sinus. When they become complete rings the chambered sinus passes through them.

The **hydrocoel vesicle** becomes completely constricted from the **parietal sinus**, flattens in the dorsoventral direction, and at once assumes the horse-shoe shape. The gape of the horse-shoe points at first backwards and to the left, and finally to the left and forwards. Five ventrally directed outgrowths appear on it, out of each of which, at a later stage, three tentacle vessels arise.

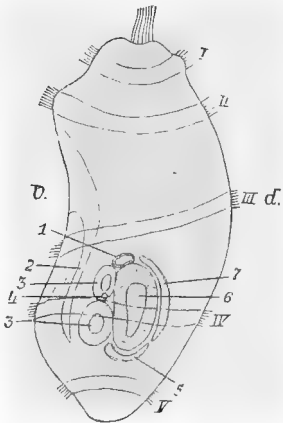

FIG. 446.—Free-swimming larva of *Antedon*, fifty-two hours old, from the left side (after Seeliger). I-V, The five ciliated rings; 1, the parietal sinus; 2, the vestibule, already closed posteriorly; 3, the hydrocoel; 4, the hydropore; 5, left enterocoel vesicle; 6, intestine; 7, right enterocoel.

The rudiment of the **primary stone canal** appears at the blind end of the left limb of the hydrocoel, as a dorsal process, running to the left.

The tubular **parietal sinus**, which is now completely isolated from the hydrocoel,

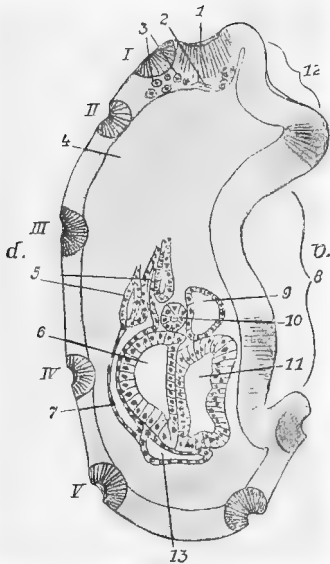

FIG. 447.—Median longitudinal section through a free-swimming larva of *Antedon*, twenty-eight hours old, in the act of becoming attached (after Seeliger). I-V, The ciliated rings; 1, neural plate with nerve fibres (2), and ganglion cells (3); 4, gelatinous nucleus, the mesenchyme cells which crowd it are not represented; 5, the tubes of the chambered organ; 6, intestine; 7, right coelom; 8, vestibule; 9, parietal sinus; 10, right enterocoel; 11, hydrocoel; 12, adhesive pit; 13, left enterocoel.

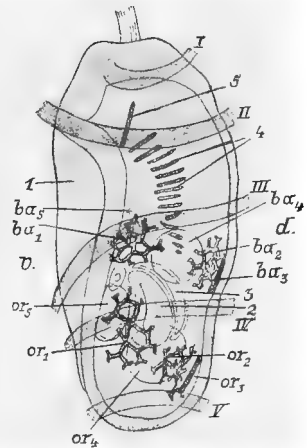

FIG. 448.—Free-swimming larva of *Antedon*, forty-eight hours after being hatched, from the left side, specially to illustrate the rise of the skeletal plates. I-V, The ciliated rings; $b\alpha_1$ - $b\alpha_5$, the five basals; or_1 - or_5 , the five orals, those lying on the right side represented as discs; 1, vestibule; 2, intestinal vesicle; 3, right enterocoel; 4, calcareous joints of the stalk; 5, pedal plate.

has shifted to a position in front of and above the latter. Its posterior end grows out till it touches the ectoderm immediately in front of the fourth ciliated ring ventrally and to the left, and finally breaks out through the **hydropore** at this point.

3. Attachment of the Larva and its Transformation into the Stalked Form (Figs. 449-453).

Attachment takes place by means of the adhesive pit, which yields a sticky secretion; and since this pit lies **ventrally** at the anterior part of the body, the attached larva has at first a position parallel to the surface to which it is fastened, and the vestibule lies immediately above that surface. The body, however, soon **becomes erect**, and the adhesive pit takes up a terminal position.

Very soon after attachment the **ciliated rings disappear**, and so does the

neural tuft; the neural plate flattens out, and the larval nervous system completely degenerates.

The ectoderm cells continue to yield an intermediate substance. Many of them sink below the surface, the consequence being that the distinction between the body epithelium and the mesenchymatous cutis is entirely obliterated.

The vestibule becomes completely constricted off, the last remains of the aperture of invagination closing. At the same time it shifts entirely to the posterior end of the larva, the end which now freely projects, twisting through an angle of 90° , so that its thickened epithelial floor, which before lay parallel to the principal axis, now

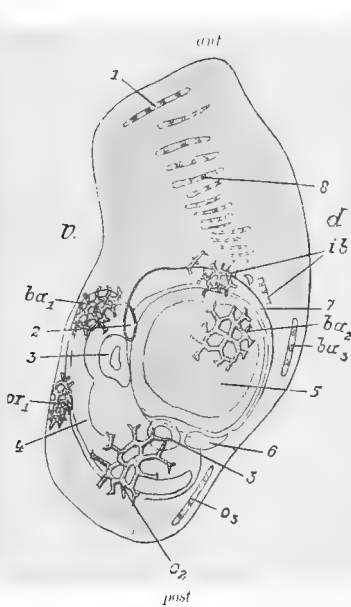

FIG. 449.—Young attached larva of *Antedon*, forty-eight hours old, from the left side (after Seeliger). The vestibule has become entirely constricted off, but the distinction between the calyx and the stalk is not yet pronounced. ba_1 - ba_3 , Basals; or_1 - or_3 , orals; ib , infrabasals; 1, pedal plate; 2, parietal canal; 3, hydrocoel outgrowths; 4, vestibule; 5, intestinal vesicle; 6, left coelom sac; 7, right coelom sac; 8, calcareous joints of the stalk.

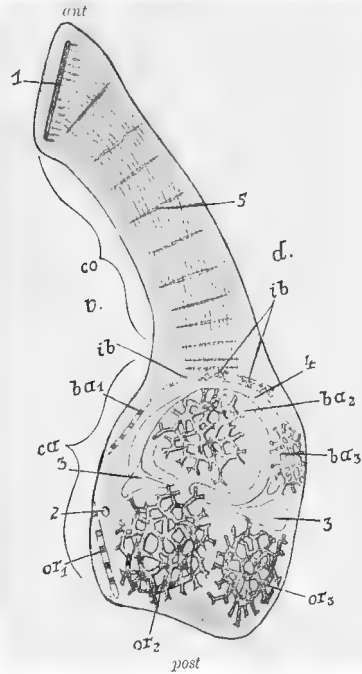

FIG. 450.—Young attached larva of *Antedon*, forty-eight hours after being hatched, from the left side (after Seeliger). co , Stalk; ca , calyx; ba_1 - ba_3 , basals; or_1 - or_3 , orals; ib , infrabasals of the left side; 1, pedal plate; 2, hydropore; 3, left coelom; 4, right coelom; 5, joints of the stalk.

lies at right angles to it. The larval body becomes club-shaped, the anterior body forming the handle of the club. The vestibule, which continues to increase in size, comprises the entire posterior part of the club (the calyx); it becomes pentagonal, and imprints the same shape upon the whole posterior part of the body, and thus first determines the radiate structure (Figs. 450, 451, and 452).

The anterior end of the larva becomes the apical end of the stalk, the posterior end becoming the oral side of the calyx of the attached *Pentacrinus*-like larva.

The hydrocoel undergoes the same twisting and shifting as the vestibule, beneath

whose floor it lies after as before the process. It has passed from the horse-shoe shape to the circular, but the hydrocoel ring still remains unclosed for a long time at the point where the gape of the horse-shoe formerly was. Its five outgrowths

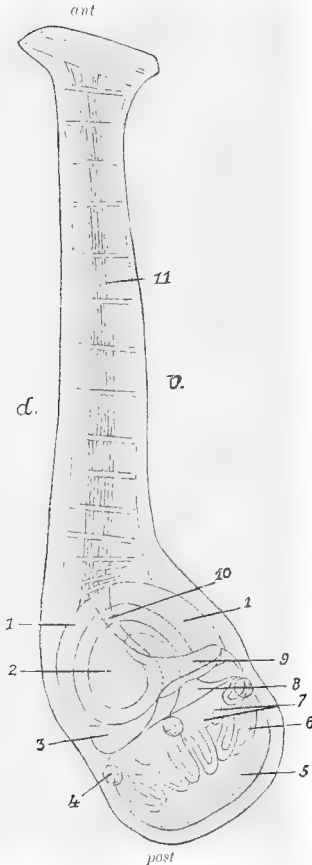

FIG. 451. Stalked larva of *Antedon*, eighty-four hours old, with twenty-five tentacles, from the right side (after Seeliger). Calcareous plates not represented. 1, Right coelom sac; 2, stomach intestine; 3, left coelom sac; 4, sacculi; 5, vestibule, still closed; 6, the fifteen primary tentacles; 7, the five pairs of secondary interradial tentacles; 8, oesophagus; 9, hind-gut; 10, axial organ; 11, fibrous strands in the stalk, continuations of the axial sinus.

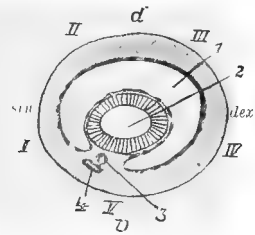

FIG. 452.—Transverse section through the region of the left or oral coelom of an attached larva of *Antedon*, 108 hours old (after Seeliger). I-V, The five radii; 1, left oral coelom; 2, oesophagus; 3, stone canal; 4, parietal canal.

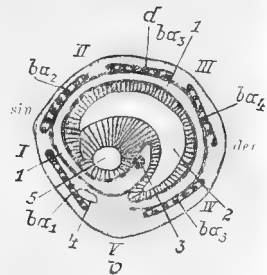

FIG. 453. - Diagrammatic transverse section through the region of the aboral coelom in an *Antedon* larva, 108 hours old (after Seeliger). I-V, The five radii; ba_1 - ba_5 , the five basals; 1, right or aboral coelom; 2, hind-gut; 3, axial organ; 4, parietal sinus; 5, oesophagus.

push up the ectoderm of the floor of the vestibule into the vestibular cavity; they soon appear to be trilobate, so that in all 5×3 tentacles are present, ten more being added to them, which arise in pairs at the bases of the primary outgrowths.

The stone canal breaks through into the parietal sinus.—The point at which this occurs does not, however, correspond with the point at which the hydrocœl and the parietal sinus originally were in open communication.

The **parietal sinus** also takes part in the shifting just mentioned. In the free-swimming larva it lay in front of the hydrocœl. This position it retains, while shifting backward (towards the oral end) together with the hydrocœl. It thus approaches its external pore. Compared with the other growing organs, it remains small and stationary.

The hydrocœl is thus connected by the stone canal with the parietal sinus, and this latter is in open communication with the exterior through the hydropore.

The intestine.—An extraordinary process goes on in the intestinal vesicle. Numerous cells become detached from its wall, and wander into its cavity, which they finally completely fill. They fuse for the most part into a large yolk-like mass, which is entirely resorbed at a later stage as nutritive material.

The floor of the vestibule deepens at the centre, and is produced anteriorly like a funnel towards the intestinal vesicle. This funnel, which passes through the hydrocœl ring, becomes the **œsophagus**, and joins a posterior process of the intestinal vesicle which grows out to meet it.

The intestinal vesicle divides into a **stomachal section** to the left of the larva and a narrower portion running dorsoventrally on the right side. This latter part, the **hind-gut**, rises with a broad base out of the former and ends blindly. The blind end of the hind-gut then grows over to the left ventrally.

The cœlom.—The two cœlom sacs shift and spread out in a peculiar manner. The left sac shifts quite posteriorly, and becomes the oral cœlom, which grows round the œsophagus on all sides from above downward, thus assuming the shape of a hollow horse-shoe which clasps the œsophagus, the stone canal, and the parietal canal (counting these in order from within outward). The gape of this horse-shoe is directed ventrally to the left, and since the tips of its two arms grow towards one another, a short **longitudinal accessory mesentery** arises. The **right cœlom vesicle** passes through changes of form, expansion, and shifting which are difficult to describe briefly, and becomes the **aboral or apical cœlom**. In consequence of the shiftings of these vesicles the **longitudinal principal mesentery** which separated the originally right from the originally left cœlom vesicle becomes a **transverse mesentery**, separating the oral from the apical cœlom, and surrounding the œsophagus like a diaphragm. Near the right (now aboral) cœlom also, a **longitudinal**, somewhat diagonal **accessory mesentery** develops, which runs somewhat to the right of the ventral median line. The walls of the apical (originally right) cœlom are continued anteriorly into the walls of the five tubes which form the **chambered sinus**, but at the point where they pass into one another they are so pressed together that no open communication exists between the two sinuses.

The **axial organ (genital stolon)** of the calyx arises as a thickening in the left epithelial wall of the longitudinal accessory mesentery of the aboral cœlom, at its most anterior (apical) end, where the chambered organ commences. As the genital strands of the arms and pinnulæ most probably arise as outgrowths of the axial organ, it might thus be proved that in the Crinoids also the genital cells are derived in the last instance from the endothelium of the body cavity. The cushion-like thickening increases in length, becoming partly constricted from the mesentery; posteriorly, it reaches to the oral cœlom; anteriorly, the axial organ passes into the stalk up the centre, between the five tubes of the chambered sinus.

The **formation of trabeculæ** begins in the aboral cœlom. Single endothelial cells lengthen and project like pillars into the cœlomic cavity. A similar process takes place in the hydrocœl.

The **skeleton.**—When the vestibule shifts to the posterior end of the larva the

skeletal plates are also shifted. The horse-shoes formed by the five orals and the five basals close, and form two flat rings or circles. The **circle of the orals** shifts backward and on to the roof of the vestibule in such a way that the five plates together form a pyramid, the truncated tip of which forms the centre of the vestibular roof, at the extreme posterior end of the larva. The orals have thus shifted away from the region of the left (oral) coelom.

The **circle of basals** which lies in front of (apically to) that of the orals forms a pyramid in the body wall of the calyx, around the aboral coelom, the truncated end of this pyramid lying at the commencement of the stalk, or at the anterior (apical) end of the calyx. The orals and the basals together form a pentagonal double pyramid, truncated at both ends. At the truncated end of the basal pyramid, round the uppermost (most posterior) joints of the stalk, lie the four or five small **infra-basals**. The number of joints in the stalk increases, and the anterior body of the larva becomes, as the stalk, more and more distinctly demarcated from the posterior body or **calyx**, which has now become five-rayed.

The orals and basals alternate with the primary outgrowths of the hydrocoel, *i.e.* they are interradially placed. If we indicate that primary outgrowth of the hydrocoel which, when the larva is viewed from the oral side, comes next in the direction followed by the hands of the clock, to the hydropore (which lies ventrally to the right) as No. I, and those which follow in this direction as II, III, IV, and V, and if, again, we indicate that oral or basal which lies in the interradius between radii I and V as the first, and those which follow in this direction as orals (or basals) 2 to 5, it can be proved that the hydropore, in the older stages of the attached larva, is enclosed by the basal part of the **first oral plate**. In these stages it is also seen that the infrabasals fuse to form a single plate, the **centrodorsal**, at the centre of which there is an aperture for the passage of the chambered organ.

During the first developmental periods which follow the attachment of the larva, the **sacculi** appear. Five of these first arise exactly radially at the bases of the middle tentacle of each group of tentacles, on the outer side of the circular canal. These sacculi can be ontogenetically derived from groups of mesenchyme cells.

4. The Stalked Larva after the Vestibule has been Perforated.

(From five days to the sixth week after hatching, Fig. 454.)

The calyx becomes more and more distinct from the stalk.

The roof of the **vestibule** becomes ever thinner at its centre, an aperture finally forming. Radial incisions run from this central aperture towards the peripheral base of the roof, so that this latter becomes divided into five interradial lobes or valves, each of which contains an oral plate. This pyramid of valves can open and shut. The vestibule has opened outward.

The five tentacles meanwhile lengthen and receive their papillæ. They usually project outwards from between the five oral valves.

The definitive nervous system (which is oral and superficial) rises quite independently of the larval nervous system, which entirely disappears. The first appearance of the nerve ring was observed very late, long after the perforation of the vestibule. The ectoderm of the oral disc, *i.e.* the peripheral portion of the original vestibular floor (the central part having sunk in to form the oesophagus), becomes thickened in a ring which is bordered by tentacles, and here becomes multilaminar. The cells of the deeper layer yield the nerve tissue.

Neither the rudiments of the deeper oral nervous system nor those of the apical system have as yet been certainly observed.

Alimentary canal.—The **mouth** from the very first does not lie exactly at the centre of the oral disc, but somewhat eccentrically in the interradial area bordered by the first and fifth radii.

The stomach becomes a capacious sac, and the yolk-like mass contained in it is gradually absorbed. The hind-gut arises out of it (in interradius III-V), being broad at the base, and then thinning into a tube which has the following course. Viewing the larva from the oral pole, the hind-gut runs (in the direction of the hands of the clock) in the horizontal mesentery, near the body wall, through the interradial space IV-V, then runs across radius V, and immediately after opens outwards in the interradial space V-I, through the **anus** which has in the meantime broken through the calyx laterally. This is the same interradius in which the hydropore lies, on the original ventral side of the bilaterally symmetrical larva. The ectoderm takes no part in the formation of the anus.

In the **cœlom sacs** profound changes are going on, which may be briefly summarised as follows.

(a) The **chambered sinus** gives up all connection with the original right, now the aboral cœlom sac.

(b) The **mesenteries** (both the principal and the longitudinal accessory mesentery) are **completely resorbed**, and as a consequence the right and left cœloms unite to form one large body cavity.

(c) The **trabeculæ** (of endothelial origin) become very strongly developed, and traverse the body cavity in all directions as a network.

(d) The **axial organ** becomes differentiated as an independent solid cell strand, lengthens till it reaches the tegmen calycis (oral disc), and at a later stage becomes hollow.

(e) In the parietal sinus, which comes to lie quite in the body cavity, two sections become more and more distinct; the one vesicular, and the other a narrow canal-like section opening outwards through the hydropore. The former, into which the primary stone canal enters, loses its independent endothelium, and the thin wall which separates it from the cœlom also probably disappears, so that it ceases to exist as a separate cavity. The stone canal now opens into the general body cavity, which is thus in communication with the exterior through the narrower section of the original parietal sinus, and through the hydropore in the anal interradius.

In the **hydrocœl**, the water vascular ring completely closes. The whole of the musculature of the hydrocœl is formed by the hydrocœlomic epithelium itself. The

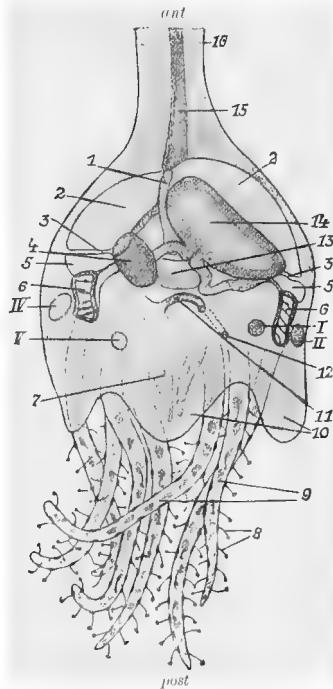

FIG. 454.—Calyx of a decalcified larva of *Antedon*, five weeks old, with extended tentacles, from the left and lower side (after Seeliger). I-V, The five radially placed primary sacculi; 1, axial organ; 2, right (aboral) cœlom; 3, principal mesentery, between the right (aboral) and the left (oral) cœlom; 4, hind-gut which follows the stomach; 5, oral cœlom; 6, hydrocœl ring; 7, two of the ten secondary tentacles; 8, tentacle papillae; 9, primary tentacles (only seven of the total number, fifteen, are represented); 10, oral lobes; 11, stone canal; 12, hydropore; 13, oesophagus; 14, stomach; 15, continuation of the chambered organ in the stalk (16).

trabeculae within the system of canals increase in number. In the **tentacles**, the following changes have taken place. Formerly the twenty-five tentacles were arranged in five radial groups of five each. The five tentacle canals of a group were connected by a common tentacle canal rising with the circular canal. Now all the five tentacle canals of a group rise separately from the water vascular ring.

Further, during the period of the attachment of the stalked larva, four new **stone canals** appear, and four new **calyx pores** form in the other interradial. These and all that arise later cannot, of course, form in the same way as the **primary calyx pore**.

The stage, the development of which has just been described, has been called the **Cystid stage**, owing to the absence of arms, to there being no clear division of the calyx into dorsal cup and tegmen calycis, and to the occurrence of the rudiment of the genital organs as an axial organ, whereas later the genital glands lie in the arms and especially in the pinnules.

In opposition to the above view it may be remarked :

1. That neither the want of arms nor the absence of division of the calyx into a dorsal cup and an ambulacral disc is characteristic of the *Cystidea*.

2. That the skeletal system of the attached larva of *Comatula* is altogether radiate, consisting of the three circles, the radials, the basals, and the infrabasals. On the other hand, the irregular arrangement of the skeletal plates is, as a rule, characteristic of the *Cystidea*. Those *Cystids* which most resemble the larva of *Comatula* in the number and radial arrangement of the skeletal plates are also those which are, of all *Cystids*, the most nearly related to the Crinoidea.

3. The hydrocœl of the stalked *Comatula* larva consists simply of the water vascular ring and a circle of tentacles, which receive their canal direct from the water vascular ring. In the *Cystidea*, radial canals must have run out from the water vascular ring, below the food grooves of the ambulacra, giving off tentacle canals to right and left, and also probably penetrating into the arms.

4. The appearance of the first rudiments of the genital glands **in the body** merely proves that the definitive position **in the arms** is secondary, and this applies to all Echinoderms.

The position of the anus, indeed, agrees in both.

5. Last Stage of the Attached Stalked Larva—Pentacrinus Stage.

(Cf. Fig. 326, p. 375.)

This stage is distinguished by the rise of the arms, which begin to grow out in the radii between the circle of the orals and that of the basals. Each rudiment of an arm is, from the very first, supported on its apical side by a newly arising skeletal plate. These plates are the **five radials** of the dorsal cup. Distally from each radial on the growing arm, two new skeletal plates follow one another, the first and second costals. The growing rudiment of the arm then forks, the distichals form, and so on.

During the formation of the arms the five middle and strictly radially arranged tentacle canals of the five tentacle groups become the radial vessels, which fork with the arms. Fresh investigation of this point is, however, much needed.

The interval between the oral pyramid and the bases of the arms increases, and the tegmen calycis thus comes into existence. The pyramid of five oral valves in the middle of the latter does not grow further, and the valves with their skeletal plates finally disappear. Round the anus, which comes to lie in the tegmen calycis, an anal plate develops temporarily.

At this stage the resemblance of the attached and stalked larva of Antedon

to the Inadunata, especially to the so-called Larviformia (*cf.* pp. 303, 328, etc.), is so striking as to be at once recognisable.

The calyx, with the arms, sooner or later breaks away from the stalk, and can either move by using the arms as paddles or catch on to objects by means of its cirri. When it breaks loose from the stalk, some of the uppermost whorl joints on which cirri have formed remain connected with it; these fuse with one another, and with the centrodorsal. The basals, again, fuse to form a rosette, which is soon overgrown on all sides by the large apical centrodorsal plate.

XXII. Phylogeny.

No other phylum of the animal kingdom is so sharply marked off from all others as the Echinoderms. Their organisation is in all points strange; even the radiate structure is strange, in so far as it is, unlike that of many *Cœlenterata*, only a mask which hides a complicated and hitherto inexplicable asymmetry. We are not in a position to compare an adult Echinoderm with the adult representative of any other phylum from a phylogenetic standpoint.

The difficulties which meet us in attempting to reconstruct the phylogenesis of the Echinodermata are still further increased by the fact that the typical characteristic Echinoderm larva cannot at any stage of its development be compared with the adult or larval form of any other animal. An exception to this statement may, however, perhaps, be made in favour of the *Enteropneusta*, which will be described in the next chapter.

If, taking the gastræa theory as a foundation, we assume for the Metazoa a common bilaminar racial form, it seems, in view of the above-mentioned difficulties, that the racial form of the Echinodermata must have branched off extraordinarily early, perhaps at a stage corresponding phylogenetically with the gastrula. By such an assumption, the Echinoderms and their larvæ would be removed from the sphere of comparative anatomy and comparative embryology, except in so far as such comparative enquiry were limited to the Echinoderm phylum itself.

It appears to us, however, that attempts to approximate the Echinodermata to Metazoa standing higher than the *Cœlenterata* should not be abandoned. Recent anatomical and ontogenetic researches have brought to light facts which open up new prospects. We may mention the demonstration of a neural plate and of a larval nervous system, the attempts to demonstrate that there are two pairs of enterocoel vesicles, the proof that the first rudiments of the gonads proceed from the endothelium of the coelom, the suggestion that the stone canal or the hydropore should be regarded as a nephridial canal, etc.

All this, of course, does not justify us in closely comparing the Echinoderm larva with other definite forms, adult or larval, belonging to Metazoan classes higher than the *Cœlenterata*, except perhaps the *Enteropneusta*. But these discoveries and new views tend to make the Echinoderm body appear somewhat less strange, since we find in its organisation important points in which it is fundamentally in agreement with the so-called Triploblastica.

It cannot be doubted, and has never been doubted, that the Echinodermata form a distinct, naturally marked out phylum of the animal kingdom, or, in the language of Phylogeny, that all Echinoderms have had a common racial form.

Within the phylum of the Echinodermata, further, the classes are again quite distinct and naturally marked off from one another. Among known Echinoderms, there are no intermediate forms between the *Pelmatozoa*, the *Holothurioidea*, the *Echinoidea*, the *Asteroides*, and the *Ophiuroidea*. Every known Echinoderm can at once be recognised as either an *Echinoid*, an *Asteroid*, a *Holothurid*, etc. The *Cystidea*

alone, perhaps, form an exception to this rule, showing decided resemblance to the *Crinoids* on the one hand, with an occasional possible approach to the opposite extreme, i.e. the *Holothurioidea*, on the other. It is, however, very difficult to judge of the *Cystidea*, since conclusions as to the inner organisation drawn exclusively from the structure of the skeleton cannot be regarded as altogether trustworthy.

It appears to us that there is not the least justification for deducing the different Echinoderm classes in any definite way from one another, nor can we at all accept the recently urged view that the *Holothurioidea* stand nearest to the racial form. On the contrary, the morphology of the genital organs leads us to believe that the *Holothurioidea* are distinct from all other Echinoderms, with the possible exception of the *Cystidea*.

If we review the whole morphology of the Echinodermata, our phylogenetic speculations are, first of all, influenced by the fundamental fact that the radiate, but at the same time asymmetrical Echinoderm proceeds ontogenetically from a bilaterally symmetrical larva, the so-called Dipleurula.

The Dipleurula Larva.

This larva is regarded from two opposite points of view. (1) The bilateral structure is thought to have been secondarily acquired, within the different groups of the Echinoderms, in adaptation to the free-swimming manner of life. (2) The bilateral structure of the larva has been inherited from the common racial form of the Echinodermata, or from the larva of such a form. The first view is now generally abandoned. The manner of life might indeed have called forth external bilateral symmetry of form, but certainly not the marked bilateral symmetry of structure of the internal organs.

If we now try to sketch a hypothetical phylogenetic stage based upon a comparison of the various Dipleurula larvæ of the Echinodermata, the following is the result: The body was freely movable, ovoid, and bilaterally symmetrical; the mouth lay anteriorly on the ventral side, the anus at the posterior end, or posteriorly on the ventral side. In the frontal region there was a nerve centre below the surface of the ectodermal epithelium which was differentiated into a sensory organ (neural plate). Running back from the nerve centre along the ventral side, below the surface of the body epithelium, were two nerve trunks beset with ganglion cells. The intestine was divided into the ectodermal(?) œsophagus, the wider endodermal mid-gut, and the hind-gut, which was also endodermal. At the sides of the intestine were two pairs of œelomic vesicles, the anterior pairs at the sides of the œsophagus, the posterior at the sides of the mid- and hind-guts. The two anterior œelomic vesicles (or their posterior portions) were connected with the exterior by a canal laterally or dorsally (cf. the interesting temporary occurrence of a hydropore on the right side in *Asteroids*, especially in *Asterias vulgaris*, p. 527). The genital products developed out of the endothelium of the œelom.

Such an organisation has nothing strange about it. It has almost as much claim to be classed with the *Vermes* as *Sagitta* has, for which latter classification, however, not much can be said. It is further possible that the racial form possessed special organs for locomotion, respiration, etc., about which nothing can now be positively affirmed, since they have in all cases disappeared from the ontogeny of the Echinoderms. It is not at all likely that the ciliated rings have any phylogenetic significance.

Metamorphosis of the Dipleurula Larva.

The larva develops, through metamorphosis, into the young Echinoderm, which, under its radiate mask, is asymmetrical. The radiate structure is **amalgamated** with an asymmetrical structure.

Here again, we are not altogether without light as to the phylogenetic significance of this process. We agree with the majority of modern authors in believing that a **radiate structure of body arises as a consequence of an attached manner of life**. We are, therefore, justified in assuming that the radiate Echinoderm arose from a free-moving racial form, in adaptation to a newly-acquired, attached manner of life.

All Echinoderms must, therefore, once have been attached animals.

If now, we wish to ascertain in what special manner **attachment took place**, we **unavoidably** turn for an answer to this special question to the *Crinoids*. These are the only Echinoderms which, in all probability, never again gave up the attached manner of life. That the only *Crinoid* about whose ontogeny we know anything, *Antedon*, is a form which has actually once more become free, *i.e.* has, as a secondary specialisation, given up the attached manner of life, detracts in no way from the arguments based upon its ontogeny.

All other Echinoderms whose ontogeny we can investigate have long since given up the attached manner of life, and, with the exception of certain (analogous) cases among the *Asteroids* (*e.g.* *Asterina*), do not any longer pass through an attached larval stage. Hence the methods of development of other Echinoderms, even when simpler than that of the *Crinoids*, must in comparison with the latter be regarded, phylogenetically, with some suspicion.

From the developmental history of *Antedon* then, we learn that the attachment of the Dipleurula larva of this animal took place by means of the **ventral side of the anterior end of the body**. In a similar way the Dipleurula larva of *Asterina* attaches itself by means of the **larval organ** which develops **anteriorly**.

Authors who have recently attacked this problem assume that **attachment took place on the right side**; making this assumption in order to explain the asymmetry which follows. To us also this assumption appears necessary, but it should be specially stated that the attachment took place on the right anteriorly.

When this assumption is made we must further ask: What were the changes which the attached manner of life induced?

It is difficult, with the embryological material we have at present, to obtain an adequate idea of the resulting processes, and only a very tentative explanation can be given.

Judging by analogy from the modifications which, in other parts of the animal kingdom, result from an attached manner of life, it may be assumed that the arrangements for conducting food were the first to become adapted to the new condition of existence. The mouth left its unfavourable position and wandered along the ventral side, first to the left, *i.e.* to the side which was now uppermost (being opposite to the point of attachment). In this shifting the œsophagus pushed the median and

ventral wall of the left anterior cœlom in front of it, embedded itself to a certain extent from without in the cœlomic vesicle, so that this vesicle surrounded it in the shape of a horse-shoe. Round the mouth, the body wall (and with it the left anterior, cœlomic vesicle which lay here) grew out into five tentacles which, as in so many attached animals, served for bringing in food, for the sense of touch, and for respiration. (Compare the tentacles and the horse-shoe-shaped tentacle-carrier of the *Bryozoa Cephalodiscus*, etc.) Thus, the left anterior cœlom, which from the very first was, like the right, connected with the exterior by means of a canal, produced the primary horse-shoe-shaped hydrocœl with the primary tentacles and the hydro-pore (stone canal). In this way the first impulse towards the development of the radiate structure was given. The horse-shoe finally closed to form the circular canal.

The right anterior side of the body, which was used for attachment, could be produced into a stalk, as is the case in most *Pelmatozoa*. (The larval organ of *Asterina* may be a modified reminiscence of such a stalk.) The right anterior cœlomic vesicle, which lay in this region, now serving for attachment, lost its efferent aperture, atrophied, or became a cavity of the stalk (chambered sinus and its continuation in the *Crinoids*(?), cœlom of the larval organ in *Asterina* (?).

The body now developed principally in the oral and tentacular region (on the left anterior side). The posterior portion of the body with the anus near its end was originally like a lateral outgrowth or shield on the body, which gradually subsided and disturbed less and less the radiate appearance.

According to this view, the greater development of the anal interradius which is found in many *Crinoids*, especially in palæozoic forms, may possibly be an original condition, in connection with which we have the occurrence of special anal plates in the anal interradius. The anus also may originally have lain outside of the circle of tentacles, a supposition which harmonises with its position in the *Cystids* and in the ontogeny of *Antedon*.

Concurrently with these changes, the left posterior cœlom, which lay nearer than the right to the mouth, which had shifted to the left, now upper, side, grew round the œsophagus, and forming a vertical mesentery, became the oral cœlom. The right cœlomic vesicle, however, spread out chiefly in the lower (originally the right) region of the body, and became (also forming a vertical mesentery) the apical cœlom. The mesentery dividing the two (oral and apical) sections of the cœlom would naturally be horizontal (transverse).

In the vertical mesentery, the rudiments of the gonad (the axial organ) arose as a ridge-like thickening and growth of the endothelium on one side; in mature animals, this opened outward through a genital duct and aperture in the region between the mouth and the anus.

This phyletic stage, deduced as a result of the attached manner of life, may be called the **Pentactæa**.

For the protection of the body, calcareous plates developed in the mesenchyme below the integument, at first, perhaps quite irregularly.

From the Hypothetical (unknown) Pentactæa Stage to the known Echinoderm.

Most Echinoderms gave up the attached manner of life at a later stage. The known case of *Antedon*, in which an animal in the highest degree adapted for the attached life resumed the free life, is specially welcome and useful in this connection.

The ancestors of the *Holothurioidæ* were probably the first to renounce the attached manner of life, although not as early as the Pentactæa stage.

The organisation of the Pentactæa would only become completely adapted to the attached manner of life, when the number of tentacles and the surface for taking in nourishment increased. Such increase might take place in various ways; we have many examples among attached animals belonging to other divisions of the animal kingdom.

The Pentactæa may have become perfected in one direction as follows:—

The interval between the bases of the primary tentacles and the mouth increased, while the (apical) interval between the primary tentacles and the attached pole remained the same or decreased. By the shifting of the circle of tentacles away from the mouth, the basal piece of each tentacle canal would be drawn out radially below the oral body wall, and would become a **radial canal**, from which new lateral tentacle canals would bud out alternately to right and left, always proximally to the shifting primary (now terminal) tentacle, the body wall projecting in the form of **tentacles**. There thus arose in each radius a double row of tentacles, which, to speak exactly, stood in the corners of a zigzag line. Nutritive particles, descending, would be sent on to the mouth between these rows of tentacles. This adaptation became perfected when the floors between these rows of tentacles sank in the form of furrows—the **food grooves or ambulacral furrows**; these furrows then became provided with means of transport, in this case with cilia. The epithelial cells lining the furrows gradually became **sensory cells**, and **epithelial nerve ridges**,—the **radial nerves**,—would arise, which would meet round the mouth as the **nerve ring**.

This rise of the radial nervous system of the Echinodermata as a natural development of the ambulacral furrows, and of the palisades of sensory tentacles bordering these furrows on each side, may be without difficulty followed out in detail, although there is no space for such an attempt in this volume.

At this stage are found the armless Cystids with their carapace of plates. The genital organ is enclosed in the body, and opens outward through a single aperture (the “third” aperture of the *Cystidea*).

It was, perhaps, at a similar phyletic stage that the ancestors of the *Holothurioidæ* gave up the attached manner of life. For locomotion, they used the tentacles, arranged in five meridional double rows, the body elongated, and the anus shifted to the apical end, which became free. Food was taken in directly at the mouth; to assist in alimentation, the œsophagus became modified into a pharynx, and the tentacles lying close to the mouth became specialised. The food grooves lost their function, leaving, however, behind them the epithelial nerve ridges, which continued to innervate the tube-feet. The food grooves could now close over to form a tube for the protection of the nerve ridges; these latter became the subepithelial radial nerves, and the lumina of the closed tubes the **epineural canals**. According to this view, therefore (and this applies also to the *Ophiuroidea* and *Echinoidea*), **the subepithelial radial nerves, with their epineural canals, are the original food grooves** closed over to form tubes. They gave up their original function as “food grooves” in proportion as, with the adoption of a free manner of life, food was taken in direct at the mouth.

It is a question of subsidiary importance, in the derivation of the Holothurid body, which still possesses the single genital organ and the single aperture, whether the condition of its skeleton is to be regarded as original, or whether it has not rather been derived from the carapace of plates of a Cystid-like animal by means of the multiplication of the skeletal pieces, their loose arrangement, and their decrease in size.

The longitudinal and circular musculature may be new, but may just as well have been inherited from an attached ancestral stage, in which they could be functional, just as are the longitudinal and circular muscles of *Actinia*.

After the foregoing description it is obvious that the *Paractinopoda* (*Synaptidæ*)

cannot be regarded as primitive forms of *Holothurioidea*. They are, on the contrary, highly specialised forms, which, in adaptation to the limicolous life, have lost the tube-feet and the radial canals, which, however, still occur ontogenetically.

We have thus seen how the Pentactæa might become modified in the direction of certain *Cystids* and of the *Holothurioidea*.

By remaining attached, the Pentactæa might develop in another direction.

The body carried by the stalk might remain small, but become drawn out into processes or arms in the directions in which the primary tentacles travel from the mouth, the ends of these arms being always marked by the possession of the primary tentacles. Secondary tentacles then rose out of the radial vessels which ran along the arms (the tentacle canals of the primary tentacles) in the way above described; the food grooves and their nerve ridges also formed in the same way. A still more complete adaptation to the attached manner of life was attained by the branching of the arms and the formation of pinnulæ. In this way the surface for capturing food was continually increased.

The direction of adaptation here indicated might be called the **Crinoid direction**, the *Crinoids* having, in fact, gone furthest in this direction.

The development of the crown of arms on a body which remained small had necessary consequences. The body (calyx, disc) and the stalk (should this latter develop) would have to gain the necessary stability for carrying the growing arms. This was provided for by the formation of the more or less firm carapace of plates. The stalk attained firmness by the development of joints; the calyx, by that of the dorsal cup, and here all the facts seem to indicate that in the racial form of the *Crinoids*, the dorsal cup had a definite composition, viz. five infrabasals, five basals, five radials arranged in the typical manner, and the anals. For the protection of the mouth, five orals were added, forming together a pyramid which could be opened and closed. For the support of the arms, and in connection with the developing capacity for unfolding and closing the crown of arms, the jointed brachial skeleton formed.

As the arms grew out from the small body, the cœlom was produced into them, and processes of the single rudiment of the gonad (the axial organ) spread in one way or another into them. They became fertile more or less far from the calyx (or disc) and yielded the gonadial bundles, each of which opened outwards through one or more special apertures.

In this point also, the *Crinoids* are the most extreme forms.

The *Echinoidea*, *Ophiuroidea*, and *Asteroidea* appear also to belong as lateral branches to this Crinoid development.

First, and probably very early, the **Echinoids** seem to have branched off. They became free, used their tentacles for locomotion, and took in food direct through the mouth, the food grooves, with the nerve ridges, becoming the subepithelial radial nerves. The arms were again incorporated into the enlarging calyx, or test; in that the apical skeleton of the arms degenerated, and thus brought the (ambulacral) ends of the arms close up to the continually decreasing apical capsule. As this latter was free, the anus could shift into its centre.

We have come to hold this view of the derivation of the Echinoidea from attached ancestral forms with arms, a view which, as far as we know, has never before been published, chiefly for the following reasons:—

The *Echinoidea* possess five pairs of gonads, which are at first connected with the axial organ by means of an aboral circular strand.

This important distinction from the *Holothurioidea*, with which the *Echinoidea* are usually compared in other points, can only be explained by the assumption that the *Echinoidea* originally possessed arms which contained the fertile outgrowths of the central genital rudiment. That the gonads now lie interradially, presents no

difficulty. They could easily have been in the short thick arms, while the terminal portions of their efferent ducts opened outward interradially.

The **Ophiuroidea** branched off from the series leading to the *Crinoids* by the readoption of the free manner of life later than the *Echinoids*. They used the free arms for locomotion, and took food direct into the mouth. The tentacles never became ambulatory tube-feet, but only retained their respiratory functions. The food grooves closed to form tubes, becoming subepithelial radial nerves with their epineural canals. For further protection, the radial longitudinal rows of ventral shields became arranged over the closing food grooves. The use of the arms almost exclusively as locomotory organs determined their slender form, which makes them appear as mere appendages of the body, and it further led to the return of the gonads into the disc.

The **Asteroidea** were the last to branch off from the series of attached Echinoderms with arms, by the adoption of a free manner of life. They used their tube-feet first for locomotion, and secondly for seizing and holding fast prey, which was enveloped *en masse* direct by the evaginated oral portion of the intestine and drawn through the mouth into the stomach. The food grooves now no longer serve as such, but are retained as deepened ambulacral furrows, from the bases of which the closely crowded tube-feet rise, and into which they can withdraw. Over the tentacles, withdrawn within the furrow, the spines which border the furrow can bend protectively together. Deep in the base of the furrow, the radial nerve ridge is found still in its epithelial position.

From the standpoint of the foregoing it is to be expected that the ontogeny of the *Holothurioidea*, which earliest gave up the attached life, should show the least trace of the phyletic stage of the attached animal, and that by the avoidance of those complicated rearrangements which attachment caused, their development should be much simplified. The facts agree with this expectation, and also with the expectation that an attached stage is most likely to be ontogenetically repeated in the *Asteroids* (cf. the ontogeny of *Asterina*, with its temporary fixation by means of the anterior part of the body, the larval organ).

In the foregoing attempt to trace the phylogeny of the Echinoderms, we have avoided going into details, and we have also avoided all reference to many important points, such as the hydropore and the stone canal, the hydrocoel and the left anterior enterocœl, etc. etc. These can only be elucidated by renewed research, which must be both extensive and thorough. In applying our views to explain special points in Echinoderm morphology, it must be acknowledged that in the majority of cases it does not suffice for a full explanation, and that it cannot indeed at present be reconciled with many ontogenetical and anatomical facts. The recent researches in Echinoderm morphology and the attempts at phylogenetic explanations, which are continually suggesting new points of view, justify us, however, in hoping that, little by little, many of these interesting and important problems will receive a satisfactory solution.

Review of the most important Literature.

Comprehensive Works. Text Books. Treatises of Wider Scope. Researches extending over some or all of the Classes.

- A. Agassiz.** *Palæontological and embryological development. Address before the American Association for the Advancement of Science. Boston Meeting. Cambridge, 1880. Also Ann. and Mag. Nat. Hist.* (5). Vol. VI. 1880.

- E. Baudelot.** *Contributions à l'histoire du système nerveux des Echinodermes.* Arch. de Zool. Exp. (1). Vol. I. 1872.
- P. H. Carpenter.** *Several important treatises especially on the Skeletal System, from 1870-1890, in various Journals, principally in Quart. Journ. Microsc. Science, and in the Ann. and Mag. Nat. Hist.*
- L. Cuénot.** *Études sur le sang, son rôle et sa formation dans la série animale.* Part II. *Invertébrés.* Archives Zoologie expérimentale (2). Tome IX. 1891.
- *Études morphologiques sur les Echinodermes.* Arch. Biologie (van Beneden). Tome XI. 1891.
- Herb. E. Durham.** *On waveling cells in Echinoderms, etc., more especially with regard to excretory functions.* Quart. Journ. Mic. Sci. Vol. XXXIII. 1892.
- Johs. Frenzel.** *Beiträge zur vergleichenden Physiologie und Histologie der Verdauung.* I. Mith. Der Darmkanal der Echinodermen. Arch. f. Anat. u. Physiol. Physiol. Abth. 1892.
- Greeff.** *Ueber den Bau der Echinodermen.* Sitzungsber. d. Gesellsch. f. Naturwiss. zu Marburg. 5 Parts. 1871, 1872, 1876, 1879.
- O. Hamann.** *Die wandernden Urkeimzellen und ihre Reifungsstätten bei den Echinodermen.* Zeitschr. f. wiss. Zool. 46 Bd. 1887.
- M. M. Hartog.** *The true nature of the madreporic system of Echinodermata, with remarks on Nephridia.* Ann. and Mag. Nat. Hist. (5). Vol. XX. 1887.
- Herapath.** *On the pedicellariæ of the Echinodermata.* Quart. Journ. Microsc. Science. Vol. V. 1865.
- Carl Jickeli.** *Ueber den Bau der Echinodermen.* Zool. Anz. 7 Jahrg. 1884.
- A. Kowalevsky.** *Zur Kenntniss der Excretionsorgane.* Biol. Centralblatt. 9 Bd. 1889.
- H. Ludwig.** *Morphologische Studien an Echinodermen.* Leipzig, 1877-1882.
- *Reprints from the Zeitschr. f. wiss. Zool.*
- *Bronn's Klassen und Ordnungen des Thierreichs.* 2 Bd., 3 Abth. Echinodermen. Holothurioida. Asteroidea in progress.
- Joh. Müller.** *Ueber den Bau der Echinodermen.* Berlin, 1854. *Abhandl. Akad. Wissensch.* Berlin, 1853.
- M. Neumayr.** *Morphologische Studien über fossile Echinodermen.* Sitzungsber. Akad. Wissensch. Wien. mathem.-naturw. Cl. 84 Bd. 1 Abth. 1881.
- *Die Stämme des Thierreichs, etc.* 1888.
- E. Perrier.** *Recherches sur les pédicellaires et les ambulacres des Astéries et des Oursins.* Annales des Sciences natur. (5). Tomes XII. and XIII. 1869-1870.
- *Echinodermes.* Part I. *Stellerides.* Exped. du Travailleur et du Tulasman. Paris. 1895.
- G. J. Romanes and J. E. Ewart.** *Observations on the locomotor system of Echinodermata.* Proceed. Roy. Soc. London. Vol. XXXII. 1881. *Philos. Transactions* London. 1881. Part III.
- C. F. and P. B. Sarasin.** *Ueber die Anatomie der Echinothuriden und die Phylogenie der Echinodermen.* Ergebnisse nat. Forschungen Ceylon. 1 Bd. 1888.
- R. Semon.** *Die Homologien innerhalb des Echinodermenstammes.* Morph. Jahrbuch. 15 Bd. 1889.
- *Die Entwicklung der Synapta digitata und die Stammesgeschichte der Echinodermen.* Jenaische Zeitschr. f. Naturwiss. 22 Bd. 1888.
- W. P. Sladen.** *On the homologies of the primary larval plates in the test of Brachiata Echinoderms.* Quart. Journ. Microsc. Science (2). Vol. XXIV. 1884.
- Friedr. Tiedemann.** *Anatomie der Röhrenholothurie, des pomeranzenfarbigen See sterns und des Stein-Seeigels.* Landshut, 1816.
- K. A. Zittel.** *Handbuch der Paläontologie.* 1 Bd. München and Leipzig, 1876-1880.

**Principal Systematic Works and Treatises specially dealing with the
Morphology of the Skeletal System. Pedicellariæ.**

- A. Agassiz.** *Revision of the Echini (Illustrated Catalogue of the Museum of Comparative Zoology at Harvard College. No. VII.).* Cambridge, Mass., 1872-1874.
— *North American Starfishes (Mem. of the Museum of Comp. Zool. Vol. V. No. 1).* Cambridge, Mass., 1877.
— *Report on the Echinoidea. Report on the scient. results of the voyage of H.M.S. "Challenger," Zool. Vol. III. Part IX. 1881.*
— *Report on the Echini (Results of dredging by the "Blake," XXIV. Part I.). Memoirs of the Museum of Comparative Zoology at Harvard College. Vol. X. No. I. Cambridge, Mass., 1883.*
- F. A. Bather.** *British fossil Crinoids. A series in progress in Ann. and Mag. Nat. Hist. beginning (6). Vol. V. 1890.*
— *The Crinoidea of Gotland. Part I. The Crinoidea inadunata. Kongl. Svenska Vetenskaps-Akademiens Handlingar. Bandet 25. Stockholm, 1893.*
- J. F. Brandt.** *Prodromus descriptionis animalium ab H. Mertensio in orbis terrarum circumnavigatione observatorum. Fasc. 1. Petropoli, 1835.*
- Leopold von Buch.** *Ueber Cystideen. Abhandl. Berl. Akad. 1844.*
- P. H. Carpenter.** *Report on the Crinoidea. I. The Stalked Crinoids. Voyage of the "Challenger." Vol. XI. Part XXXII. London, 1884. II. The Comatulæ. Ibid. Vol. XXVI. Part LX. 1888.*
— *A Series of important works, chiefly on the Morphology of the Skeletal System, appearing from 1870-1890 in English journals, especially Quart. Journ. of Microsc. Science, and Annals and Magazine of Natural History.*
- G. Cotteau.** *Échinides. Paléontologie française. Vols. VII., IX., X. Paris, 1862-1879.*
- D. C. Danielssen and Joh. Koren.** *Holothurioidæ. The Norwegian North Atlantic Expedition. 1876-1878. VI. Christiania, 1882.*
- E. Desor.** *Synopsis des Echinides fossiles. Paris and Wiesbaden, 1858.*
- F. Dujardin.** *Recherches sur la Comatule de la Méditerranée. L'Institut. Tome III. 1835.*
- P. M. Duncan.** *A revision of the genera and great groups of the Echinoidea. Journ. Linn. Soc. London. Vol. XXIII. 1889.*
- P. M. Duncan and W. Percy Sladen.** *A memoir on the Echinodermata of the arctic sea to the west of Greenland. London, 1881.*
- R. Etheridge jun. and P. H. Carpenter.** *Catalogue of the Blastoidea in the Geological Department of the British Museum (Natural History), with an account of the morphology and systematic position of the group and a revision of the genera and species. London, 1886.*
- J. W. Fewkes.** *On the serial relationship of the ambulacral and adambulacral Calcareous Plates of the Starfishes. Proceed. Boston Soc. N. H. Vol. XXIV. 1890. Primary spines of Echinoderms. Ibid.*
— *On the development of the Calcareous Plates of Asterias. Bull. Mus. Harvard Coll. Vol. XVII. 1888.*
— *On the development of the Calcareous Plates of Amphipura. Bull. Mus. Comp. Zool. Vol. XIII. No. IV. 1887.*
- Alex. Foettinger.** *Sur la structure des pédicellaires gemmiformes d'Échinides. Arch. de Biol. Vol. II. 1881.*
- E. Forbes.** *A history of British Starfishes and other animals of the class Echinodermata. London, 1841.*
- E. Fraas.** *Die Asterien des weissen Jura von Schwaben und Franken, mit Unter-*

- suchungen über die Structur der Echinodermen und das Kalkgerüst der Asterien. Palaeontogr.* 32 Bd. 1886.
- Wilhelm Giesbrecht.** *Der feinere Bau der Seeigelzähne. Morph. Jahrbuch.* 6 Bd. 1880.
- J. E. Gray.** *Synopsis of the species of Starfishes in the British Museum.* London, 1866.
- G. Hambach.** *Contributions to the anatomy of the genus Pentremites, with description of new species. Trans. of the Acad. of Science of St. Louis.* Vol. IV. No. I. 1880.
- Clem. Hartlaub.** *Beitrag zur Kenntniss der Comatulidenfauna des Indischen Archipels. Nova Acta Acad. Cæs. Leop.-Carol. Germ. Nat. Cur.* 58 Bd. No. 1. 1891.
- C. Heller.** *Die Zoophyten und Echinodermen des Adriatischen Meeres.* Wien, 1868.
- O. Jaekel.** *Beiträge zur Kenntniss der Palaeozoischen Crinoiden Deutschlands. Pal. Abh. New Series.* III. 1895.
- K. Lampert.** *Die Seewalzen. Reisen im Archipel der Philippinen von Dr. C. Semper. 2 Th. Wiss. Resultate.* 4 Bd. 3 Abth. Wiesbaden, 1885.
- A. Ljungman.** *Ophiuridea viventia huc usque cognita.* Stockholm, 1867.
- P. de Loriol.** *Échinologie helvétique.* I., II., III. Geneva, 1868-1875.
- *Monographie des Crinoïdes fossiles de la Suisse.* Geneva, 1877-1879.
- *Paléontologie française. Terrain jurassique.* Tome XI. *Crinoïdes.* Part I. 1882-1884. Part II. 1884-1889.
- S. Lovén.** *Études sur les Échinodées. K. Svensk. Vet.-Akad. Handl.* 11 Bd. (1873-75). Stockholm, 1874.
- *On Pourtalesia, a genus of Echinoidea. K. Svensk. Vet.-Akad. Handl.* 19 Bd. 1884.
- *Echinologica. Bihang till K. Svensk. Vet.-Akad. Handl.* XVIII. Afd. 4. 1892.
- Chr. Fr. Lütken.** *Additamenta ad historiam Ophiuridarum.* Copenhagen, 1858-1869.
- Hubert Ludwig.** *Trichaster elegans. Zeitschr. f. wissenschaft. Zool.* 31 Bd. 1878.
- *Zur Kenntniss der Gattung Brisinga. Ibid.*
- *Das Mundskelet der Asterien und Ophiuren. Ibid.* 32 Bd. 1879.
- *Ueber den primären Steinkanal der Crinoideen nebst vergleichend-anatomischen Bemerkungen. Ibid.* 34 Bd. 1880.
- *Zur Entwicklungsgeschichte des Ophiuren skeletes. Ibid.* 36 Bd. 1882.
- *Ophiopteron elegans, eine neue, wahrscheinlich schwimmende Ophiuridenform. Ibid.* 47 Bd. 1888.
- *Ankyroderma musculus (Riss.), eine Molpadiide des Mittelmeeres, nebst Bemerkungen zur Phylogenie und Systematik der Holothurien. Ibid.* 51 Bd. 1891.
- *Holothuroidea of the "Albatross" Expedition. Mem. Mus. Harvard.* XVII. 3. 1894.
- Th. Lyman.** *Ophiuridae and Astrophytidae. Illustr. Catalogue of the Museum of Comp. Zool. Harvard College.* I. Cambridge, Mass., 1865.
- *Report on the Ophiuridea. Report on the scientific results of the voyage of H.M.S. "Challenger."* Vol. V. Part XIV. London, 1882.
- Meyer.** *Ueber die Laterne des Aristoteles. Arch. f. Anat. u. Physiol.* 1849.
- J. S. Miller.** *A natural history of the Crinoidea or lily-shaped animals.* Bristol, 1821.
- Joh. Müller.** *Ueber den Bau des Pentacrinus caput Medusae. Abhandl. d. Akad. d. Wissensch.* Berlin, 1841.
- *Ueber die Gattung Comatula Lam. und ihre Arten. Abhandl. d. Akad. d. Wissensch.* Berlin, 1847.

- Joh. Müller** and **Fr. H. Troschel**. *System der Asteriden*. Braunschweig, 1842.
- Edm. Perrier**. *Observations sur les relations qui existent entre les dispositions des pores ambulacraires à l'extérieur et à l'intérieur du test des Echinides réguliers*. *Nouv. Arch. Muséum*. Tome V. 1869.
- Edm. Perrier**. *Recherches sur les pédicellaires et les ambulacres des Astéries et des Ourisins*. *Annales des Sciences natur.* (5). Vols. XII. and XIII. 1869-1870.
- *Révision de la collection de Stellérides du Muséum d'histoire naturelle de Paris*. Paris, 1875-1876.
- *Mémoire sur les étoiles de mer, recueillies dans la mer des Antilles et le golfe du Mexique*. Paris, 1884.
- H. Prouho**. *Recherches sur le Dorocidaris papillata et quelques autres Échinides de la méditerranée*. *Arch. de Zool. expér.* (2). Tome V. 1887-1888.
- F. A. Quenstedt**. *Petrefactenkunde Deutschlands*. 3 Bd. *Echiniden*. Leipzig, 1872-1875.
- Ferd. Römer**. *Monographie der fossilen Crinoidenfamilie der Blastoideen*. *Arch. f. Naturgeschichte*. 1851.
- G. O. Sars**. *Mémoire pour servir à la connaissance des Crinoides vivants*. Christiania, 1868.
- *Researches on the structure, etc., of the genus Brisinga*. Christiania, 1875.
- M. Sars**. *Bidrag til Kundskaben om Middelhavets Littoral-Fauna*. Christiania, 1857.
- *Oversigt of Norges Echinodermmer*. Christiania, 1861.
- E. Selenka**. *Beiträge zur Anatomie und Systematik der Holothurien*. *Zeitschr. f. wissenschaft. Zool.* 17 and 18 Bd. 1867, 1868.
- C. Semper**. *Reisen im Archipel der Philippinen*. 1 Bd. *Holothurien*. Leipzig, 1868.
- W. Percy Sladen**. *On a remarkable form of Pedicellaria, and the functions performed thereby, etc.* *Annals and Mag. of Nat. History* (5). Vol. VI. 1880.
- *On the homologies of the primary larval plates in the test of Brachiata Echinoderms*. *Quart. Journ. Microsc. Science* (2). Vol. XXIV. 1884.
- *Report upon the Asteroidea collected by H.M.S. "Challenger."* Vol. XXX. 1889.
- Hj. Théel**. *Report on the Holothurioidea collected during the voyage of the "Challenger."* Part I. Vol. IV. 1882. Part II. Vol. XIV. 1886.
- *On the formation and resorption of the skeleton in the Echinoderms*. *Ofv. Ak. Forh.* 1894.
- Volborth**. *Ueber Achradocystites und Cystoblastus, zwei neue Crinoiden-Gattungen*. *Mém. Acad. Imp. Sc. St. Pétersbourg*. 1870. Tome XVI. No. II.
- C. Viguier**. *Anatomie comparée du squelette des Stellérides*. *Arch. Zool. expérim.* Tome VII. 1879.
- C. Wachsmuth** and **F. Springer**. *Revision of the Palæocrinoidea*. *Proceed. Acad. Nat. Sc. of Philadelphia*. 1879, 1881, 1885.
- (1) *Discovery of the ventral structure of Taxocrinus and Haplocrinus, and consequent modifications in the classification of the Crinoidea*. *Proceed. Acad. Nat. Science Philadelphia*. 1889.
- (2) *Crotalocrinus: its structure and zoological position*. *Ibid.*
- *The perisomic plates of the Crinoids*. *Pro. Acad. Nat. Sc. Philadelphia*. 1890.
- T. Wright**. *Monograph of the British fossil Echinodermata of the bolithic formation*. London, 1857-1880.
- *Monograph of the British fossil Echinodermata of the cretaceous formation*. London, 1864-1882.
- K. A. Zittel**. *Handbuch der Paläontologie*. 1 Bd. 1876-1880.

Anatomical Monographs.

- A. Agassiz.** *Revision of the Echini.* *Mus. Compar. Anatomy Harvard Coll.* Vol. VII. 1872.
- *North American Starfishes (Mem. of the Mus. of Comp. Zool. Vol. V. No. I.)*. Cambridge, Mass., 1877.
- *Report on the Echinoidea collected by H.M.S. "Challenger."* Vol. III. London, 1881. (Also contains anatomical details.)
- Nic. Christo Apostolides.** *Anatomie et développement des Ophiures.* *Arch. Zool. expér. génér.* Vol. X. 1882.
- Alb. Baur.** *Beiträge zur Naturgeschichte der Synapta digitata.* *Acta. Acad. Cæs. Leop.-Carol. Nat. Curios.* 1864.
- P. H. Carpenter.** *Report upon the Crinoidea collected during the voyage of H.M.S. "Challenger" during the years 1873-1876.* Part 1. *General Morphology, with descriptions of the stalked Crinoids.* Vol. XI. 1884. Part 2. *The Comatulæ.* *Ibid.* Vol. XXVI. 1888. (The second part is almost exclusively systematic and descriptive.)
- William B. Carpenter.** *Researches on the structure, physiology, and development of Antedon rosaceus.* *Philos. Transactions.* Vol. CLVI. 1866. Addendum. *Pro. R. Soc.* Vol. XXIV. 1876.
- L. Cuénot.** *Contribution à l'étude anatomique des Astérides.* *Arch. Zool. expér.* (2). Tome V. Supplementary (1887-1890).
- *Études anatomiques et morphologiques sur les Ophiures.* *Arch. Zool. expér.* (2). Tome VI. 1888.
- D. C. Danielssen and J. Koren.** *Holothurioiden. The Norwegian North Atlantic Expedition.* 1876-1878. Christiania, 1882.
- Frédéricq.** *Contributions à l'étude des Échinides.* *Arch. de Zool. expér.* Tome V. 1876.
- O. Hamann.** *Beiträge zur Histologie der Echinodermen.* 1. Heft. *Die Holothurien.* Jena, 1884. 2. Heft. *Die Asteriden.* Jena, 1885. 3. Heft. *Anatomie und Histologie der Echiniden und Spatangiden.* Jena, 1887. 4. Heft. *Anatomie und Histologie der Ophiuren und Crinoiden.* Jena, 1889. (Reprints from the *Jenaischen Zeitschr. f. Naturwiss.*)
- *Beiträge zur Histologie der Echinodermen.* 1. *Die Holothurien (Pedata) und das Nervensystem der Asteriden.* *Zeitschr. f. wiss. Zool.* 39 Bd. 1883.
- É. Hérouard.** *Recherches sur les Holothuries des côtes de France.* *Arch. Zool. expér.* (2). Tome VII. 1889.
- C. F. Heusinger.** *Anatomische Untersuchung der Comatula mediterranea.* *Zeitschr. f. organische Physik.* Tome III. 1828.
- C. K. Hoffmann.** *Zur Anatomie der Echinien und Spatangien.* *Niederl. Arch. Zool.* 1 Bd. 1871.
- *Zur Anatomie der Asteriden.* *Niederl. Arch. f. Zool.* 2 Bd. 1874.
- G. F. Jaeger.** *De Holothuriis.* *Diss. inaug.* Zurich, 1833.
- Et. Jourdan.** *Recherches sur l'histologie des Holothuries.* *Ann. Mus. H. N. Marseilles.* Tome I. 1883.
- R. Köhler.** *Recherches sur les Échinides des côtes de Provence.* *Ann. Mus. H. N. Marseilles.* Tome I. 1883.
- W. Lange.** *Beitrag zur Anatomie und Histologie der Asterien und Ophiuren.* *Morph. Jahrbuch.* 2 Bd. 1876.
- Leydig.** *Anatomische Notizen über Synapta digitata.* *Müller's Arch.* 1852.
- Lovén.** *Études sur les Échinoides.* *Svensk. Vetensk.-Akad.* 11 Bd. 1874.
- H. Ludwig.** *Beitrag zur Kenntniss der Holothurien.* *Arbeit. Zool. Inst. Würzburg.* 2 Bd. 1874.

- H. Ludwig.** *Beiträge zur Anatomie der Crinoideen.* Leipzig, 1877. *Zeitschr. f. wiss. Zool.* 26 Bd. 1877. 28 Bd. 1877.
- *Zur Anatomie des Rhizocrinus tofotensis.* *Ibid.* 29 Bd. 1877.
- *Ueber Rhopalodina lageniformis.* *Ibid.* 1877.
- *Beiträge zur Anatomie der Asteriden.* *Ibid.* 30 Bd. 1878.
- *Ueber Asthenosoma varium Grube und über ein neues Organ bei den Cidariden.* *Ibid.* 34 Bd. 1880. *Berichtigung im Zool. Anz.* 3 Jahrg.
- *Ueber den primären Steinkanal der Crinoiden nebst vergl.-anatomischen Bemerkungen über die Echinodermen überhaupt.* *Ibid.* 34 Bd. 1880.
- *Neue Beiträge zur Anatomie der Ophiuren.* *Ibid.* 34 Bd. 1880.
- *Nochmals die Rhopalodina lageniformis.* *Ibid.* 48 Bd. 1889.
- *Die Seevallen. Bronn's Klassen und Ordnungen des Thier-Reichs.* 2 Bd. 3 Abth. *Echinodermata.* Leipzig, 1889-1892.
- Hub. Ludwig and Ph. Barthels.** *Beiträge zur Anatomie der Holothurien.* *Zeitschr. f. wiss. Zool.* 54 Bd. 1892.
- T. Lyman.** *Report on the Ophiuridea. Voyage of H.M.S. "Challenger," Zool.* Vol. XV. Part 14. London, 1882.
- J. Müller.** *Ueber den Bau von Pentacrinus caput Medusae.* *Abhandl. d. Akad. d. Wissensch.* Berlin, 1841.
- *Ueber Synapta digitata und über die Erzeugung von Schnecken in Holothurien.* Berlin, 1852.
- E. Perrier.** *Mémoire sur l'organisation et le développement de la Comatule de la Méditerranée (Antedon rosacea Linck).* *Nouv. Archives Mus.* Paris, 1886-1892.
- *Recherches sur l'anatomie et la régénération des bras de la Comatula rosacea.* *Arch. Zool. expér.* Tome II. 1872.
- H. Frouho.** *Recherches sur le Dorocidaris papillata et quelques autres Échinides de la Méditerranée.* *Arch. de Zool. expér.* (2). Tome V. 1887.
- A. de Quatrefages.** *Mémoire sur le Synapte de Duvernoy.* *Ann. Sc. natur.* (2). Tome XIV. 1842.
- C. Semper.** *Kurze anatomische Bemerkungen über Comatula.* *Arbeit. Zool. Inst. Würzburg.* 1 Bd. 1874.
- C. F. and P. B. Sarasin.** *Ueber die Anatomie der Echinothuriden und die Phylogenie der Echinodermen.* *Ergebnisse Nat. Forschungen Ceylon.* 1 Bd. 1888.
- G. O. Sars.** *Researches on the structure etc. of the genus Brisinga.* Christiania, 1875.
- *Mémoire pour servir à la connaissance des Crinoides vivants.* Christiania, 1868.
- Selenka.** *Beiträge zur Anatomie und Systematik der Holothurien.* *Zeitschr. f. wiss. Zool.* Two papers in Vols. 17 and 18. 1867-1868.
- R. Semon.** *Beiträge zur Naturgeschichte der Synaptiden des Mittelmeers.* *Mith. Zool. Stat. in Neapel.* 7 Bd. 1887.
- Von Siebold.** *Zur Anatomie der Seeesterne.* *Müller's Archiv.* 1866.
- H. Simroth.** *Anatomie und Schizogonie der Ophiactis cirens.* *Zeitschr. f. wiss. Zool.* Two papers in Vols. 27 and 28. 1877.
- Reinhold Teuscher.** *Beiträge zur Anatomie der Echinodermen. I. Comatula mediterranea.* *Jenaische Zeitschr.* 10 Bd. 1876.
- Friedr. Tiedemann.** *Anatomie der Röhrenholothurie, des pomeranzenfarbigen Seeesters und des Stein-Seeigels.* Landshut, 1816.
- Hj. Théel.** *Report on the Holothurioida. Voyage of H.M.S. "Challenger." Zoology.* Part I. Vol. VI. Part XIII. 1882. Part II. Vol. XIV. Part XXXIX. 1885.
- J. V. Thompson.** *Sur le Pentacrinus europaeus, l'état de jeunesse du genre Comatula.* *L'Institut.* 1835.

- G. Valentin.** *Anatomic du genre Échinus. Monographies d'Échinodermes, par L. Agassiz.* Neuchâtel, 1841.
- Alex. Weinberg.** *Die Morphologie der lebenden Crinoiden mit Beziehung auf die form Antedon rosacea Linné. Naturhistoriker.* 5 Jahrg. 1883.

Works dealing with Single Organs or Systems of Organs.

- H. Ayers.** *On the structure and function of the Sphaeridia of the Echinoidea. Quart. Journ. Microsc. Science* (2). Vol. XXVI. 1886.
- E. W. M'Bride.** *The development of the genital organs, ovoid gland, axial and aboral sinuses in Amphiuira squamata, together with some remarks on Ludwig's Hæmal System in this Ophiurid. Quart. Journ. Microsc. Science.* Vol. XXXIV. 1893.
- *The development of the dorsal organs, genital rachis and genital organs in Asterina gibbosa. Zool. Anz.* 16 Jahrg. 1893.
- E. Baudelot.** *Contributions à l'histoire du système nerveux des Échinodermes. Arch. de Zool. expér.* 1872.
- W. B. Carpenter.** *On the nervous system of Crinoida. Proceed. Roy. Soc. London.* Vol. XXXVII. 1884.
- L. Cuénot.** *Études sur le sang, son rôle et sa formation dans la série animale. Part II. Invertébrés. Arch. Zool. expér.* (2). Tome IX. 1891.
- E. Haeckel.** *Ueber die Augen und Nerven der Seesterne. Zeitschr. f. wiss. Zool.* 10 Bd. 1860.
- Otto Hamann.** *Beiträge zur Histologie der Echinodermen. 1. Die Holothurien (Pedata) und das Nervensystem der Asteriden. Zeitschr. f. wiss. Zool.* 39 Bd. 1883. 2. Mitth. 1. Nervensystem der pedaten Holothurien. 2. Cuvier'sche Organe. 3. Nervensystem und Sinnesorgane der Apoden. *Ibid.*
- R. Köhler.** *Recherches sur l'appareil circulatoire des Ophiures. Ann. Sc. nat.* (7). Tome II. 1887.
- F. Leiboldt.** *Das angebliche Excretionsorgan der Seeigel, untersucht an Sphaerechinus granularis und Dorocidaris papillata. Zeitschr. f. wiss. Zool.* 55 Bd. 1893.
- Theodore Lyman.** *The stomach and genital organs of Astrophytidae. Bull. Mus. Comp. Zool. Harvard College.* Vol. VIII. No. 6. Cambridge, Mass., 1891.
- A. M. Marshall.** *On the nervous system of Antedon rosaceus. Quart. Journ. Microsc. Science.* Vol. XXIV. 1884.
- C. Mettenheimer.** *Ueber die Gesichtsorgane des violetten Seesterns. Müller's Arch.,* 1872.
- E. A. Minchin.** *Notes on the Cuvierian organs of Holothuria nigra. Ann. and Mag. Nat. History* (6). Vol. X. 1892.
- J. Niemiec.** *Recherches sur les ventouses dans le règne animal. Recueil Zool. Suisse.* Tome II. *Encore un mot, etc. Ibid.* 1885.
- Owsjanikoff.** *Ueber das Nervensystem der Seesterne. Bull. Acad. St. Pétersbourg.* 1870. Tome XV.
- Ed. Perrier.** *Recherches sur les pédicellaires et les ambulacres des Astéries et des Oursins. Ann. des Sciences natur.* (5). 12 and 13 Bd. 1869-1870.
- *Recherches sur l'appareil circulatoire des Oursins. Arch. de Zool. expér.* Tome IV. 1875.
- G. J. Romanes and J. C. Ewart.** *Observations on the locomotor system of Echinodermata. Philos. Transact. London.* Part III. 1881.
- A. Russo.** *Ricerche citologiche sugli elementi seminali delle Ophiureæ (spermatogenesi-oogenesi) Morfologia dell'apparecchio riproduttore. Internat. Monatschr. f. Anat. und. Phys.* 8 Bd. 8 Heft.
- C. F. and P. B. Sarasin.** *Die Augen und das Integument der Diadematiden.*

Ergebnisse naturwiss. Forschungen auf Ceylon in d. Jahren 1884-1886. 1 Bd. 1887.

- Rich. Semon.** *Das Nervensystem der Holothurien.* *Jenaische Zeitschr. f. Naturwiss.* 16 Bd. 1883.
- H. S. Wilson.** *The nervous system of the Asteridae.* *Transact. Linnean Society.* Vol. XXIII. 1860.

Ontogeny.

- A. Agassiz.** *North American Starfishes, 1864.* *Mem. of the Museum of Comp. Zool. Harvard College.* Vol. V. 1877.
- *Revision of the Echini. Illustr. Catalogue of the Museum of Comp. Zool. Harvard College.* 1872-1874.
- Nic. Christo Apostolides.** *Anatomie et développement des Ophiures.* *Arch. Zool. expér.* Tome X. 1882.
- J. Barrois.** *Recherches sur le développement de la Comatule (C. mediterranea).* *Recueil Zool. Suisse.* Tome IV. 1888.
- E. W. M'Bride.** *The development of the genital organs, ovoid gland, axial and aboral sinuses in Amphiuira squamata, together with some remarks on Ludwig's Hemal System in this Ophiurid.* *Quart. Journ. Microsc. Science.* Vol. XXXIV. Part II. 1893.
- *The development of the dorsal organ, genital rachis and genital organs in Asterina gibbosa.* *Zool. Anz.* 16 Jahrg. 1893.
- H. Bury.** *The early stages in the development of Antedon rosacca.* *Philos. Transactions.* Vol. CLXXIX. 1888.
- *Studies in the embryology of the Echinoderms.* *Quart. Journ. Microsc. Sc.* Vol. XXIX. 1889.
- *The Metamorphosis of Echinoderms.* *Ibid.* Vol. XXXVIII. 1895.
- P. H. Carpenter.** *On some points in the anatomy of larval Comatula.* *Quart. Journ. Microsc. Sc.* (2). Vol. XXIV. 1884.
- *Notes on Echinoderm morphology.* No. 11. *On the development of the apical plates in Amphiuira squamata.* *Quart. Journ. Microsc. Sc.* Vol. XXVIII. 1888.
- William B. Carpenter.** *Researches on the structure, physiology, and development of Antedon rosaceus.* *Philos. Transact.* Vol. CLVI. 1866. *Addendum. Pro. Roy. Soc.* Vol. XXIV. 1876.
- J. W. Fewkes.** *On the development of calcareous plates of Amphiuira.* *Bull. of the Museum of Comp. Zool. of Harvard College.* Vol. XIII. 1887.
- A. Fleischmann.** *Die Entwicklung des Eies von Echinocardium cordatum.* *Zeitschr. f. wiss. Zool.* 46 Bd. 1888.
- Geo. W. Field.** *The larva of Asterias vulgaris.* *Quart. Journ. of Microsc. Sc.* Vol. XXXIV. Part 2. 1892.
- Alexander Goette.** *Vergleichende Entwicklungsgeschichte der Comatula mediterranea.* *Arch. f. mikr. Anatomie.* Tome XII. 1876.
- E. Korshelt.** *Zur Bildung des mittleren Keimblatts bei den Echinodermen.* *Zool. Jahrb. Abth. Morph.* 3 Bd. 1889.
- Kowalevsky.** *Beiträge zur Entwicklungsgeschichte der Holothurien.* *Mém. de l'Acad. Impér. de St. Pétersbourg.* (7.) Tome XI. 1867.
- H. Ludwig.** *Zur Entwicklungsgeschichte des Ophiurenenskeletes.* *Zeitschr. f. wiss. Zool.* 36 Bd. 1881.
- *Entwicklungsgeschichte der Asterina gibbosa Forbes.* *Zeitschr. f. wiss. Zool.* 37 Bd. *Also in Morph. Studien an Echinodermen.* 2 Bd. 1882.
- *Zur Entwicklungsgeschichte der Holothurien.* *Sitzber. K. Preuss. Acad. d. Wiss.* 1891. X. XXXII.

- E. W. M'Bride.** *The organogeny of Asterina gibbosa.* *Pro. R. Soc.* LIV. 1894.
- E. Metschnikoff.** *Studien über die Entwicklung der Echinodermen und Nemertinen.* *Mém. Acad. St. Pétersbourg.* Tome XIV. (No. 8). 1869.
- *Entwicklung von Comatula.* *Bull. Acad. St. Pétersbourg.* XV. (Col. 508.) 1871.
- *Vergleichend-embryologische Studien.* 5. *Ueber die Bildung der Wandzellen bei Asterien und Echiniden.* *Zeitschr. f. wiss. Zool.* 42 Bd. 1885.
- Joh. Müller.** *Classical Treatises on the larval forms of Echinoderms, and their metamorphoses.* *Abhandlungen d. Königl. Akad. d. Wissensch. zu Berlin.* 1848, 1849, 1850, 1852, 1853, 1855.
- Edm. Perrier.** *Mémoire sur l'organisation et la développement de la Comatule de la Méditerranée.* *Nouv. Arch. du Mus. Hist. nat. Paris.* 1886-1892.
- A. Russo.** *Several treatises in Neapolitan journals.* 1891-1892.
- Oswald Seeliger.** *Studien zur Entwicklungsgeschichte der Crinoiden (Antedon rosacea).* *Zool. Jahrb. v. Spengel. Abth. f. Anat. u. Ont.* 6 Bd. Jena, 1892.
- Emil Selenka.** *Die Keimblätter der Echinodermen.* *Studien üb. d. Entwicklungsgesch. d. Thiere.* 2 Heft. 1883.
- *Zur Entwicklung der Holothurien.* *Ein Beitrag zur Keimblättertheorie.* *Zeitschr. f. wiss. Zool.* 27 Bd. 1876.
- R. Semon.** *Die Entwicklung der Synapta digitata und die Stammesgeschichte der Echinodermen.* *Jenaische Zeitschr. f. Naturwiss.* 22 Bd. 1888.
- *Zur Morphologie der bilateralen Wimperschnüre der Echinodermenlarven.* *Jena. Zeitschr. f. Naturwiss.* 25 Bd. 1891.
- C. Wyville Thomson.** *On the embryology of the Echinodermata.* *Nat. History Review.* 1863-1864.
- *On the embryogeny of Antedon rosaceus.* *Philosoph. Transact. of the Roy. Soc. London.* Vol. CLIII. 1865.
- Hjalmar Théel.** *On the development of Echinocyamus pusillus (O. F. Müller).* *Nova Acta Rg. Soc. Sci. Ser. 3.* Vol. XV. (No. 6). Upsala, 1892.

Phylogeny.

Besides the above-named treatises and works of **Al. Agassiz**, **P. H. Carpenter**, **Cuénot**, **Haeckel**, **Ludwig**, **Neumayr**, **Perrier**, **Sarasin**, **Seeliger**, **Semon**, compare especially **O. Bütschli**, *Versuch der Ableitung des Echinoderms aus einer bilateralen Urform.* *Zeitschr. f. wiss. Zool.* 53 Bd. Suppl. 1892.

CHAPTER IX

ENTEROPNEUSTA¹

BILATERALLY symmetrical, long, vermiform animals with soft skin. The body is divided into (1) a preoral proboscis, (2) a short "collar," (3) a long trunk. The wide mouth lies at the boundary between the proboscis and the collar. The anus is terminal. The long intestine may be divided into four sections. The mouth leads direct into (1) the buccal cavity, which runs through the collar, and sends off a diverticulum anteriorly into the proboscis. The buccal cavity leads into (2) a branchial intestine, which is in open communication with the exterior through numerous pairs of consecutive gill-pouches. The branchial intestine passes, through an intermediate portion, into (3) the hepatic intestine, which is often provided with two longitudinal rows of cæca. Lastly, the hepatic intestine runs into (4) an efferent intestine, which opens outwards through the anus.

There is an unpaired proboscidal cœlom, which opens outward at the base of the proboscis either by a single pore on the left side, or by two symmetrical pores. The cœlom of the collar is paired, and there are two pores at its posterior end. The cœlom of the trunk is also paired. The integumental and intestinal musculature are derived from the cœlomic walls. The nervous system consists of a layer of nerve fibres in the integument, this layer being thickened to form a mediodorsal nerve cord provided with ganglion cells, and a similar medioventral cord, both extending the whole length of the trunk. The dorsal cord sinks, in the collar, below the integument, forming the collar cord. A capillary network is found within all the limiting or basal membranes of the body. A large contractile vessel lies in the dorsal middle line of the collar and trunk, and a similar vessel in the ventral middle line of the trunk. In the former, the blood flows

¹ In this chapter the author, relying largely upon Spengel's monograph on *Balanoglossus*, rejects the proposed affinity between the Enteropneusta and the ancestors of the Vertebrata. As this affinity has been very widely accepted in England and America, the student should consult M'Bride's "Review of Spengel's Monograph" (*Quart. Journ. Micro. Sci.*, vol. xxxvi., 1894), which is written from this latter point of view.—TR.

from behind forward, in the latter, from before backward. A pulsating heart vesicle, which serves to propel the blood, though not belonging to the vascular system, is found in the proboscis, above the intestinal cæcum.

The sexes are separate in the Entero-pneusta. The gonads are tubes or sacs which lie in longitudinal rows in the anterior region of the trunk (in and behind the posterior branchial region) and open through dorsal genital apertures. There are no copulatory organs. Reproduction is sexual. Development is with metamorphosis (in which case the larva is known as the Tornaria) or with abbreviated metamorphosis.

Marine, inhabiting sand or mud. Four genera **Ptychodera**, **Glandiceps**, **Schizocardium**, **Balanoglossus**.

I. Outer Organisation (Fig. 455, A, B).

In the long worm-like body, **three principal regions** can be distinguished, corresponding with three consecutive sections of the cœlom: these are the **proboscidal region**, the **collar region**, and the **trunk region**. Compared

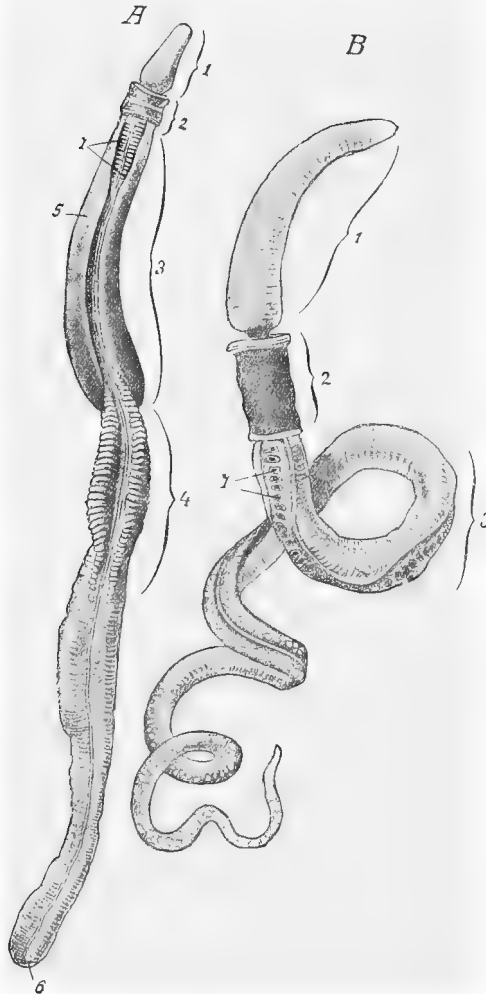

FIG. 455.—A, *Ptychodera minuta*, from the dorsal side; B, *Balanoglossus Kowalevskii*. After drawings by Peters and Minot, in Spengel's monograph. 1, Proboscis; 2, collar; 3, branchiogenital region; 4, hepatic region; 5, genital folds; 6, anus; 7, branchial pores.

with the long trunk, the first two regions are short.

A. The **proboscis** is in the shape of an acorn (hence its German name "Eichel"). It can be distended and contracted, and, in the limicolous manner of life, is the chief organ for burrowing.

B. The proboscis is joined to the second division—the **collar**, by a short stalk or neck.

This region forms a somewhat projecting ridge anteriorly round the neck of the proboscis, its anterior wall surrounding the neck like a stand-up collar. The neck is only joined to the collar dorsally, for between the neck of the proboscis and the ventral wall of the collar, gapes the wide unarmed mouth. This leads into the buccal cavity, which runs through the collar. The proboscis is thus a **preoral division of the body**. The collar is marked off from the trunk by a circular furrow of varying depth, over which it sometimes bulges out posteriorly. Further, immediately in front of its posterior boundary, there is a circular furrow round the collar itself.

C. In the long **trunk**, in the genera *Ptychodera* and *Schizocardium*, three regions can be distinguished: the **branchio-genital**, the **hepatic**, and the **abdominal regions**.

1. The anterior part of the **branchio-genital region**, which follows the collar, is distinguished by the branchial pores, and the posterior part by the gonadal apertures. The gonads, however, may stretch for some distance anteriorly into the branchial, and posteriorly into the hepatic regions. The branchial pores are found on the dorsal side, arranged in two longitudinal rows, or, when they are small and circular, in two more or less deep longitudinal furrows converging posteriorly. The pores may take the form of transverse slits.

The genus *Ptychodera* is distinguished by a longitudinal fold or ridge on each side for the reception of the gonads. These two **genital folds** (Fig. 455, A) can, when well developed, bend towards one another over the back, and so form, on the dorsal side of the branchial region, a branchial vestibule.

2. The **hepatic region** is distinct only in *Ptychodera* (Fig. 455, A) and *Schizocardium*. In these genera it is distinguished by two longitudinal rows of projecting brown or green **liver-cæca**. Even in cases in which these cæca do not appear to be arranged in two longitudinal rows, it can be shown that their insertions on the body form two such rows, but, there not being sufficient room for their swollen ends one behind the other, many of them are pushed out irregularly to the right or left. A mediadorsal strip of the hepatic region always remains uncovered.

3. The cylindrical, delicate walled **abdominal region** tapers off posteriorly, as a rule gradually, to the **terminal anus**.

II. The Body Epithelium.

The body is everywhere covered by a thick ciliated epithelium, in which, apart from the nerve-elements, undifferentiated epithelial cells and gland cells can be distinguished. The latter are always

epithelial in position. The finer structure of the epithelium cannot be dealt with here.

III. The Nervous System (Figs. 456 and 457).

The facts of fundamental importance will be treated of first.

The whole nervous system, with the single exception of a part situated in the collar, lies in the body epithelium.

Below the surface of the whole of the body epithelium, there is an uninterrupted layer of nerve fibres, a close continuous nerve plexus.

The principal or main portions of the nervous system are merely local thickenings of this network; and are the two longitudinal nerve cords, one mediodorsal and the other medioventral, which run throughout the whole length of the trunk.

At the boundary between the collar and the trunk, the network of nerve fibres thickens into a nerve ring, which forms a more specialised connection between the dorsal and ventral nerve cords.

The dorsal cord is produced anteriorly as far as to the base of the proboscis, where it divides into two diverging branches, which encircle that base. This circular thickening of the epithelial nerve plexus, however, is not sharply circumscribed.

The collar portion of the dorsal cord leaves its epithelial position, and runs longitudinally through the cœlom of the collar above the buccal cavity.

Special.—Besides smaller ganglion cells, others of remarkable size, so-called **giant ganglion cells**, sometimes occur in the thickenings of the nerve plexus, especially in the collar region. Near the nerve cords and fibres the body epithelium has few or no glands, and above the cords it is thickened. Further, all along these cords, *i.e.* in the dorsal and ventral middle lines, and especially in the latter, the body wall appears to have sunk in.

The **cord in the collar**, which may best be regarded as the central portion of the nervous system, forms the so-called **dorsal nerve cord of the collar**. This lies in the median line in the cœlom of the collar above the pharynx, and consists of several parts. There are two **perihæmal tubes**, which clasp between them the collar portion of the dorsal **blood vessel**; the nerve substance itself lies upon these, or in a channel formed by them. The nerve cord of the collar is a thick, almost cylindrical band, the dorsal part of which consists of cells, which, however, are not nerve cells but may be glandular; the ventral part, that turned to the intestine, consists of nerve tissue, and is a direct prolongation of the dorsal nerve cord of the trunk. Anteriorly, *i.e.* at the anterior end of the collar, this band divides, one portion running into the nerve tissue of the base of the proboscis, and the other into the epithelial nerve tissue of the circular collar ridge which surrounds this base.

In the genus *Ptychodera*, the nerve cord of the collar is connected with the epithelium of the dorsal body wall in the median plane by means of a varying number of epithelial tubes, the so-called **roots of the nerve cord**. Of these, only

one or more of the most anterior are really hollow, containing an **axial canal**. The posterior roots are solid strands of epithelium. No outer aperture of the axial canal has been observed, although the root tissue passes directly into the body epithelium, and the limiting membrane, elsewhere found below the epithelium, is interrupted at the point where they join. On the peripheral, outer side of the roots, the plexus of nerve fibres of the integument is continued into the nerve tissue of the collar cord. The roots themselves are connected only with the dorsal layer of cells of that cord.

The collar cord contains cavities: these are either numerous small **medullary cavities**, arranged more or less exactly in two longitudinal rows, or they form one continuous central cavity, an **axial canal** (*Ptychodera*) which either (in one species) opens outward at the anterior and posterior boundaries of the collar region, or (in all other species in which this point has been investigated) ends blindly at these points.

The axial canals of the roots of the collar cord (which run in the dorsal mesentery) are in communication either with the axial canal of that cord or with its medullary cavities.

IV. Sensory Organs.

Even the most recent careful investigations have not been able to demonstrate with certainty the existence of specific sensory organs. Undifferentiated sensory cells may be scattered over the whole of the integument. At the posterior, and especially at the postero-ventral part of the proboscis, and, further, at the anterior edge of the collar, the constitution of the body epithelium is such as to make it highly probable that it is a **sensory epithelium**. In one species alone, *Balanoglossus canadensis*, in the postero-ventral wall of the proboscis, there is a deep epidermal pit, which is the only structure that can, with any probability, be claimed as a localised sensory organ.

On the sensory organs of the free-swimming larva, cf. the section on Ontogeny, p. 586.

V. The Alimentary Canal.

The alimentary canal runs as a large and usually straight epithelial tube through the body, from the wide oral aperture, at the anterior and ventral end of the collar, to the terminal anus. It is, as a rule, attached to the body wall by both a dorsal and a ventral mesentery traversing the body cavity. It is developed in ways peculiar to the different regions of the body. Especially noteworthy is the fact that, in the branchial region, it forms a branchial intestine, communicating by means of two longitudinal rows of branchial canals (gill-slits) with the exterior.

A. The mouth is followed by the spacious **buccal cavity**, which traverses the collar region, and is provided with a thick epithelial wall.

B. The roof of the buccal cavity grows out to form a diverticulum directed anteriorly; this runs through the neck of the proboscis,

reaching as far as the base of that organ. This is the **proboscidal diverticulum** of the buccal cavity (Fig. 456), and is **preoral**. Its epithelial wall is a continuation of the epithelial wall of that cavity.

Special.—In the proboscidal diverticulum, a narrower posterior neck and an anterior head or body can usually be distinguished. In section, the neck appears

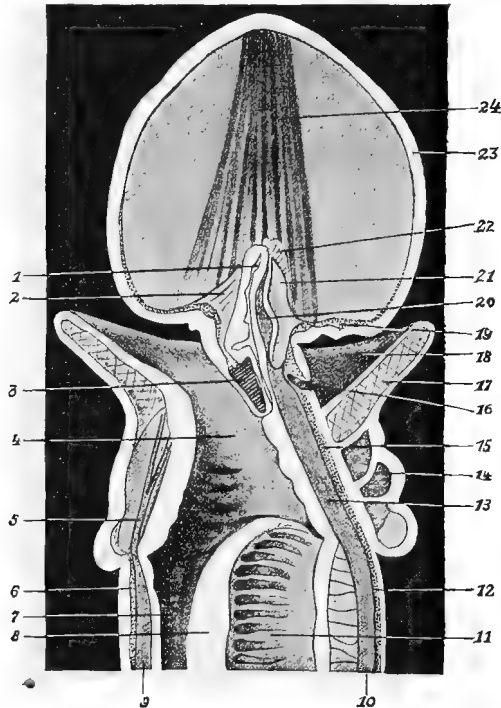

FIG. 456.—*Ptychodera minuta*. The proboscidal, collar, and anterior branchial regions, cut through the middle line, and seen from the cut surface, diagrammatic (after Spengel). 1, Proboscidal diverticulum of the buccal cavity; 2, ventral septum of the proboscis; 3, skeleton of the proboscis; 4, buccal cavity; 5, ventral vessel of the collar; 6, ventral nerve cord of the trunk; 7, oesophagus; 8, ridge forming the boundary between the oesophagus and the branchial intestine; 9, ventral blood vessel of the trunk; 10, dorsal blood vessel of the trunk; 11, branchial intestine, with the gill-slits; 12, dorsal nerve cord of the trunk; 13, dorsal blood vessel of the collar; 14, roots of the collar cord; 15, collar cord; 16, proboscis pore; 17, coelom of the collar traversed by muscle fibres; 18, anterior wall of the collar; 19, nerve layer at the base of the proboscis; 20, central blood vascular cavity of the proboscis; 21, heart vesicle; 22, proboscidal glomerulus; 23, proboscidal epithelium; 24, a part of the longitudinal musculature traversing the proboscidal cavity.

semilunar, with the concavity directed downwards. In *Schizocardium* and *Glandiceps*, the head is continued anteriorly into a narrow blind canal, the **vermiform process**, which runs through the proboscidal cavity almost axially.

In *Balanoglossus canadensis*, the neck is wanting, the head of the diverticulum consequently forming a constricted vesicle. In other species, the continuity of the lumen may be interrupted here and there.

In certain sections, the tissue of the proboscidal diverticulum, especially that of its head, has a **vesicular appearance** which recalls that of the **noto-chord of Vertebrates**. The proboscidal diverticulum of the Enteropneusta has even been called the chorda, and has been directly homologised with this structure in Vertebrates. More recent researches have, however, shown that the tissue of the diverticulum is an epithelium in direct continuation with the intestinal epithelium of the buccal cavity. This epithelium seems to consist of thread-like cells, which at one point swell up to form vesicles or vacuoles containing a fluid clear as water. The vacuoles of adjacent cells have not room enough to lie in the same level of the epithelium. They have to make room for one another, and thus come to lie in very different levels of the thickened epithelium. This makes the proboscidal diverticulum appear to have a vesicular structure, especially in tangential sections.

C. The branchial intestine.—At the posterior end of the collar, the buccal cavity passes on into the branchial intestine, which lies in the anterior portion of the branchio-genital region of the body.

Here, as already mentioned, the intestine is in communication with the exterior through two rows of pouch-like canals, which will be described more in detail later.

The numerous pouches of each longitudinal row follow one another closely, and mutually flatten one another, so that their lumina become slit-like, and lie transversely in the body at right angles to its longitudinal axis (*cf.* Figs. 457, 458, 459).

From each of these flat, vertical, and transverse **gill-pouches**, an inner aperture, the **gill-slit**, leads into the alimentary canal, and an outer aperture, the **branchial pore**, leads to the exterior.

The inner aperture, the gill-slit, is as long as the gill-pouch itself, and would have the shape of a very long O were it not complicated by the formation of the **tongue**. The intestinal wall projects from the upper end of the gill-slit in the form of a hollow process down into the slit, changing the O into a very long vertical U. (Fig. 457, 12). This hollow process is the **tongue**. Its cavity is in open communication with the coelom of the trunk. It either hangs freely down into the gill-slit (*Balanoglossus*, *Glandiceps*), or is attached to the wall of the gill-pouch by means of rods or buds, the so-called **synapticulæ** which run across the limbs of the U-shaped gill-slit transversely, making the latter fenestrated.

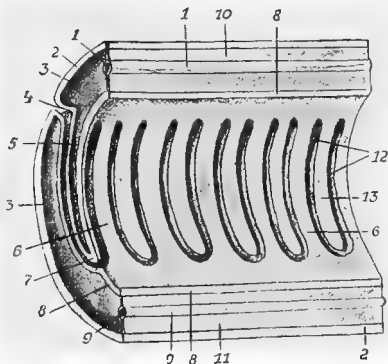

FIG. 457.—Portion of the branchial region of an Enteropneustan, cut down through the middle line, and seen from the cut surface, diagrammatic. 1, Dorsal vessel; 2, body wall; 3, cavity of the trunk; 4, branchial pore; 5, continuation of the trunk coelom in the tongue-shaped process; 6, branchial septum; 7, lowest tip of the branchial tongue; 8, wall of the alimentary canal; 9, ventral vessel; 10, dorsal mesentery; 11, ventral mesentery; 12, gill-slits; 13, branchial tongue in the gill-slit.

The partitions between the consecutive gill-pouches are called **septa**, and the edges of these which are turned to the intestine are the **septal edges**. If a lateral wall of the branchial intestine be viewed from the intestinal cavity, the septal edges and branchial

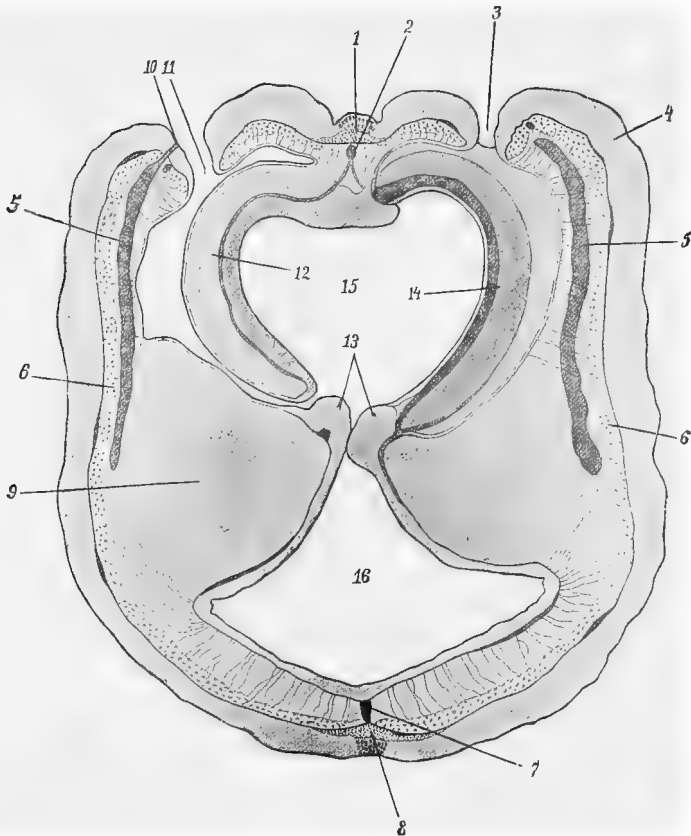

FIG. 458.—*Ptychodera minuta*, transverse section through the branchial region, somewhat diagrammatic (after Spengel). 1, Dorsal nerve cord; 2, dorsal blood vessel; 3, branchial furrow; 4, body epithelium; 5, gonad; 6, longitudinal muscle layer of the integument; 7, ventral blood vessel; 8, ventral nerve cord; 9, coelom of the trunk; 10, genital pore; 11, branchial pore; 12, branchial tongue; 13, dividing ridges; 14, branchial septum; 15, cavity of the branchial intestine; 16, oesophagus.

tongues are seen regularly alternating. The septa, like the tongues, are hollow, their cavities communicating with the coelom of the trunk. But whereas the septal edges are continued both dorsally and ventrally into the wall of the intestine, the edges of the tongues turned towards the intestine, the so-called **backs of the tongues**, are, of course, only in connection with the intestinal wall dorsally.

The epithelial walls of the gill-pouches and of the tongues are ciliated.

The depth (measured dorsoventrally) of the area occupied by the gill-slits on the lateral wall of the branchial intestine varies greatly.

In all cases the gill-slits leave only a narrow strip of the intestinal wall in the dorsal median line; this strip is the **epibranchial streak**. Ventrally they never extend so far towards the median line. They either leave a narrow strip of the intestinal wall, the **hypo-branchial streak**, which is at any rate wider than the epibranchial streak (*Schizocardium*), or they only extend a very short way on to the ventral wall (*Glandiceps*), or again they only reach about half way down the lateral wall (*Balanoglossus*). In the last case the hypobranchial streak

FIG. 459.—Vertical longitudinal section through the anterior part of a row of gills, and through a collar pore of *Schizocardium brasiliense* (after Spengel). *cp*₁, Anterior aperture of the collar canal (into the coelom of the collar); *cp*₂, posterior aperture (collar-pore) of the same (into the first gill-pouch); *bp*₁-*bp*₆, first to sixth branchial pores (outer apertures of the gills); *bs*₁-*bs*₅, first to fifth gill-pouches; *b*₄, *b*₅, fourth and fifth gill-slits (apertures of the gill-pouches into the branchial intestine); *dvm*, dorsoventral musculature; *cc*, coelom of the collar; *cr*, coelom of the trunk; *v*, blood vessels; *lc*, continuation of the coelom of the trunk into the branchial tongues; *l*, branchial tongues; *s*, branchial septa; *sz*₁, first anterior septal bar or prong; *lz*, tongue bars or prongs; *crs*, septum dividing the trunk from the collar.

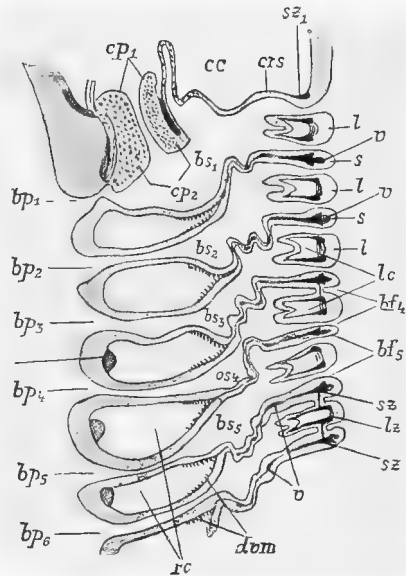

occupies the ventral or nutritive half of the branchial intestine, which is thus more or less distinct from the dorsal or respiratory half, into which the gill-slits open. The distinction between these two halves is still more marked in *Ptychodera* (Fig. 458, 15, 16), inasmuch as they are here separated by longitudinal ridge-like projections of the intestinal wall, which run on each side along the boundary between the two (13). The two ridges growing towards one another may even touch, in which case open communication between the branchial intestine above and the oesophagus below ceases.

The form of the outer apertures of the gill-pouches, the **branchial pores**, has been described above. The furrows in which they lie correspond, in *Balanoglossus*, *Glandiceps* and *Schizocardium*, with the submedian line, which is indicated by the

interruption of the longitudinal musculature. In *Ptychodera*, the branchial pores lie mediad of this line.

The gills are, as a rule, paired, but in species of *Ptychodera*, those belonging to one side may be shifted in front of those of the other side by as much as half the breadth of a gill.

At the posterior end of the branchial region, even in adult animals, new gills are continually being formed.

In *Ptychodera clavigeru*, each gill-pouch has a long ventrally directed diverticulum.

The cavity of the branchial tongue is lined with endothelium, and traversed in various directions by fibres, some of which, no doubt, are muscular.

The efferent section of the gill-pouches is provided with a musculature, which cannot here be described. The pores also may be provided with an encircling sphincter musculature of their own.

In *Balanoglossus Kowalevskii*, the posterior edge of the collar is continued backward as two outgrowths, which cover the most anterior branchial pores. These outgrowths have been called the **opercula**, and the small space they enclose, the **atrium**.

For the **blood vessels** and the **skeleton** of the branchial intestine, see below, pp. 584 and 580.

D. The **afferent intestine**, which follows the branchial intestine, runs through the posterior gill-less part of the branchio-genital region, and at its posterior end passes over into the hepatic or stomach intestine. In some forms the afferent intestine is distinguished by the fact that it sends off dorsally to right and left short canals, which open outward on the dorsal surface. These efferent canals are known as the unpaired intestinal pores, because they are for the most part unpaired.

Special.—These unpaired intestinal pores are found in *Schizocardium brasiliense*, *Glandiceps Hacksii*, and *Gl. talaboti*. In *Schi. brasiliense* the openings are irregular, either paired or unpaired. Twenty-nine in all have been observed, thirteen on the left and sixteen on the right side, and among them seven pairs. The afferent section of the alimentary canal is, in this species, distinguished by a strong circular musculature. In *Gl. Hacksii*, nine unpaired pores were observed in the young animals examined, the most anterior being on the right, and the rest on the left. In *Gl. talaboti*, all the pores in this region are unpaired; in the animals examined they are arranged in nine groups at irregular distances from one another. The efferent canals of each group probably open into a common ampulla, which, on its part, opens outward through a single aperture.

E. The **hepatic or stomachal region of the intestine** is, in all Enteropneusta, distinguished by the fact that its epithelium is ciliated and contains numerous globules of a secretion, usually green in colour. This section of the intestine seems to have a musculature of its own only in *Schizocardium brasiliense*, in which it is developed as a fine layer of longitudinal fibres. The hepatic intestine is no doubt the part of the alimentary canal of the greatest importance for **digestion**; the network of vascular capillaries, which will be described later, is specially strongly developed in its walls.

The hepatic intestine appears as a specialised section of the

digestive tract only in those species of *Ptychodera* and *Schizocardium* in which it gives off on each side dorsally a row of finger- or wedge-shaped outgrowths, which push out the body wall in such a way as to form the above-mentioned **liver-cæca**. The aperture of each cæcum into the alimentary canal is a narrow transverse slit. Food never passes into the liver-cæca. The capillary network is exceedingly close in their walls, and the intestinal epithelium of the cæca is, as a rule, much folded.

In *Glandiceps Hacksii*, an **accessory intestine** occurs in the hepatic region: this is a straight canal, ca. 6 mm. long, which branches off from the median dorsal surface of the intestine proper about the middle of the region, and again enters it at the posterior end of the same region.

In *Schizocardium brasiliense*, *Glandiceps Hacksii*, *Balanoglossus Kowalevskii*, and *B. Merschkovskii* (but not in *Ptychodera* and not in *B. Kupfferi*, and *B. canadensis*) **paired intestinal pores**, leading outward dorsally, are found in the most anterior hepatic region, or in the region immediately in front of it, intercalated between it and the afferent intestine. *Schi. brasiliense* has one pair, *Gl. Hacksii* three pairs, and *Balanoglossus Kowalevskii* four to six pairs of such pores. They emerge mediad of the submedian line, and may be provided with cilia and with sphincter muscles.

F. The hepatic intestine is followed by the **efferent section**, which gradually passes into the narrower **rectum**, this in its turn opening outward through the **anus**. Where, in this section, a proper musculature is found, it is very weakly developed.

VI. The Cœlomic Sacs and the Body Musculature.

We here use the expression **cœlomic sacs** rather than **cœlomic cavities**, the former implying that they have walls of their own.

Five cœlomic sacs occur in the body of an Enteropneustan, these being divided among the principal regions of the body as follows:—

The **proboscis** contains one **unpaired cœlomic sac**.

The **collar** contains **two paired cœlomic sacs**.

The **trunk** contains **two paired cœlomic sacs**.

The cœlomic sacs fill up almost the whole of the space between the **intestinal epithelium** and the **body epithelium**, *i.e.* the **segmentation cavity** or **blastocœl** of the larva, with the exception of a system of spaces, serving as the blood vascular system, which will be described later.

In each cœlomic sac there can be distinguished, at the least, a **visceral wall** in contact externally with the intestinal epithelium, and a **parietal wall**, in contact internally with the body epithelium.

Where the cœlomic sacs are paired, *i.e.* in the collar and the

trunk, the two lateral sacs come in contact with one another above the intestine to form a **bilaminar dorsal mesentery**, and below the intestine to form a **bilaminar ventral mesentery**.

In the adult animal these mesenteries are nowhere retained in their full extent.

Each cœlomic sac has an anterior and a posterior wall. The posterior wall of the collar sac becomes applied to the anterior wall of the trunk sac and thus forms a **bilaminar transverse and vertical septum**, separating the cœlom of the collar from that of the trunk.

The walls of the cœlomic sacs, in the larva, are epithelial. Throughout the greater part of these sacs, however, the epithelial cells become transformed into muscle fibres to form the musculature of the **body and of the intestine**. And this takes place to such an extent that over large areas no endothelial lining to the body cavity is any longer demonstrable.

Connective tissue is also produced by the walls of the cœlomic sacs.

The musculature of the Enteropneusta consists exclusively of **smooth fibres**.

Lymph cells (probably amœboid) float in the fluid of the body cavities: these are presumably produced by the peritoneal endothelium.

A. The Cœlom of the Proboscis.

The **proboscis cœlom** is, as above mentioned, unpaired. The parietal wall lies under the proboscidal epithelium, the visceral wall envelops not only the proboscidal diverticulum of the buccal cavity, but a complex of other organs as well, which lie posteriorly in the base of the proboscis; these **basal organs**, to a certain extent, bulge out the cœlomic wall, like the finger of a glove, from behind forward, into the proboscis cavity.

This cavity has three outgrowths directed backward towards the neck, one ventral and two, a right and a left, dorsal. The left outgrowth is produced backward into a canal lined with ciliated epithelium, which opens outwards through the **proboscis pore**. This pore lies dorsally to, and on the left side of, the neck, at a greater or less distance from the median line.

In a few forms (constantly in *Balanoglossus Kupfferi* and *B. canadensis*, and occasionally in *Ptychodera minuta* and *B. Kowalevskii*) a second proboscis pore occurs, through which the right dorsal outgrowth of the proboscis cœlom opens outward. This **secondary proboscis pore** rises much later ontogenetically than the primary.

It has been conjectured that water is taken in through these pores for the purpose of swelling the proboscis. There is no justification for ascribing to them any excretory function.

The visceral wall of the proboscidal cœlomic sac and, in general,

the walls of the posterior outgrowths, retain an epithelial character, while the parietal wall develops muscle and connective tissue. This parietal wall consists of the following parts :—

1. Close under the basal or limiting membrane of the body epithelium, there is an outermost layer of **circular muscle fibres**.

2. This latter is followed by a massive layer of **longitudinal muscles**, filling up the greater part of the proboscis. The very complicated course of the longitudinal muscle fibres cannot here be described in detail. They are stretched like the strings of an instrument between two points of the proboscidal wall, one behind the other, so that they cross one another in every direction.

3. **Dorsoventral muscle fibres** form a **dorsoventral muscle septum** exactly in the median plane of the proboscis. This is, however, not developed through the whole length of the cavity, but reaches only as far forward as the proboscidal diverticulum of the intestine or its vermiform process. This muscle septum thus has a free anterior edge. The fibres of the septum, which descend from the median line, when they reach the basal organs, diverge to right and left, clasping these organs between them, then again uniting beneath them, form the ventral portion of the septum. This ventral portion is distinctly a double muscle lamella. The two constituent lamellæ are separated by a structureless limiting lamella, which is a continuation of the limiting membrane of the ventral proboscidal epithelium. The circular muscle layer of the proboscis **passes through** the limiting membrane of the ventral septum in bundles.

The ventral septum is interrupted at its most posterior part, so that it has a free posterior edge as well as a free anterior edge.

That portion of the proboscidal cavity which is free from muscle fibres, is to a great extent filled with connective tissue, in which irregular spaces are found as remains of the cavity. A space free from connective tissue and varying in size is retained round the basal organs.

B. The Cœlomic Sacs and the Musculature of the Collar.

The collar region of the body contains not only its own two cœlomic sacs, but outgrowths or processes of the trunk cœlom as well; these latter have been called peripharyngeal or perihæmal cavities, and will be described with the trunk cœlom. The two lateral cœlomic sacs of the collar are, in adults, nowhere completely separated from one another by mesenteries. The median ventral mesentery is retained for a short distance in the posterior region of the collar. The dorsal mesentery extends further forward, but never as far as to the anterior end of the collar. In *Balanoglossus Kupfferi*, both the mesenteries are altogether wanting.

The divisions of the collar cœlom are complicated by the appearance of folds in the inner or visceral wall. The two lamellæ of

these folds lie close to one another, being only separated by a limiting membrane containing vessels. According to the courses of these **vascular folds** which project into the collar cœlom, the Enteropneusta can be divided into two groups.

Group 1—**Balanoglossus, Glandiceps, Schizocardium**.—A fold commences at the posterior end of the cœlom on each side, near the ventral median line, and ascends diagonally in a curve anteriorly to the neck of the proboscis.

Group 2—**Ptychodera**.—A medio-ventral vascular fold runs anteriorly from the posterior end of the collar region, dividing at a short distance from the anterior end of that region into two folds, which ascend perpendicularly and encircle the buccal cavity.

The walls of the collar cœlom are for the most part developed as muscles.

1. The **parietal wall** consists first of an outer layer of **longitudinal muscle fibres**. These commence, it is true, posteriorly in the visceral wall, then run slantingly forwards and outwards towards the integument, traversing the cœlom. Only in the anterior collar region do they run close under the integument to the anterior end of the collar. Only in this anterior region of the collar also is a **circular muscle layer** developed on the inner side of the longitudinal musculature.

2. The **visceral wall** contains first an **inner longitudinal musculature**, according to the arrangement of which the Enteropneusta may be divided into two groups.

Group 1—**Schizocardium, Glandiceps, Balanoglossus**.—A bundle of longitudinal fibres rises on each side anteriorly, from the probosciscal skeleton, which will be described later. These muscles spread out fan-like towards the septum between the collar and the trunk. The fibres composing this fan slope more and more the nearer the ventral middle line they become attached to that septum. Anteriorly, the two bundles of fibres surround the efferent vessel of the collar.

Group 2—**Ptychodera**.—The numerous bundles of longitudinal fibres run parallel to one another. Only a few of them, viz. those lying nearest the median line, run as far as the neck, enclosing the efferent collar vessel and becoming attached to the skeleton of the proboscis. None of the rest reach the anterior end of the collar region, but become attached to the posterior wall of the vascular fold mentioned above as encircling the buccal cavity.

The visceral wall of the collar cœlom further consists of a **transverse musculature**. This also is differently arranged in the groups mentioned above, its distribution being determined by the courses of the vascular folds.

In group 1 (*Schizocardium*, *Glandiceps*, and *Balanoglossus*) the transverse fibres run out laterally from the dorsal point of attachment of the ventral mesentery on each side and then upwards, to become attached to the vascular fold above described which runs from behind and below, anteriorly and upward.

Where the ventral mesentery is wanting, the transverse fibres run without interruption from the right to the left vascular fold, surrounding the buccal cavity ventrally. The transverse fibres are quite short posteriorly and limited to the ventral side, for here the vascular folds are but commencing to diverge. Anteriorly, as the folds gradually meet over the buccal cavity, the fibres become longer and longer; they finally form, near the insertion of the neck, circular loops almost completely surrounding the buccal cavity, these loops being interrupted for only a short distance dorsally.

In group 2 (*Ptychodera*) this transverse musculature is altogether wanting

throughout the larger part of the collar, viz. in all that part which lies behind the circular vascular fold. In front of this fold, however, it is as highly developed as in the same area in group 1. The muscles arise dorsally at each side of the proboscidal skeleton, and form loops encircling the buccal cavity.

3. **The anterior wall of the collar cœlom.**—A strong bundle of muscle fibres arises to right and left of the neck of the proboscis; these radiate from the anterior wall of the collar cœlom to the edge of the collar. Both ventrally and dorsally the marginal fibres of these two radiating bundles usually pass beyond the median line, cross one another, and intermingle at these points.

Besides the musculature hitherto described of the parietal visceral and anterior walls of the collar cœlom, there are further isolated **radial muscle fibres**, which connect the outer with the inner wall, and also with the anterior wall. These fibres together form a system of crossing fibres, some running slantingly from the outer wall inward and **forward**, and others inward and **backward**.

The cavity of the collar is filled with connective tissue, which penetrates everywhere between the muscles, leaving only certain spaces free. Such a free space is as a rule found to the right and left in the posterior part of the collar. The collar cœlom here is continued on **each side** into a **canal** lined with a ciliated cylindrical epithelium; each canal opens through a pore (**collar-pore**), not on the external surface of the body, but on the **anterior wall of the first gill-pouch**, near the branchial pore. The canal projects from this pore freely forward into the collar cœlom, and, on its outer surface, that turned to this cœlom, is covered with plate epithelium.

As to the function of these two collar pores, we can say no more than what was said above about that of the proboscis pore.

In *Balanoglossus Kuppferi* a cushion-like thickening of the epithelium is found on each side of the body on the septum dividing the collar from the trunk. This thickening occurs both on the anterior surface, that turned to the collar cœlom, and on the posterior surface, that turned to the trunk cœlom. These thickenings probably function as **lymph glands**.

C. The Cœlomic Sacs and the Musculature of the Trunk.

The Perihæmal and Peripharyngeal Cavities of the Collar Region.

The trunk cœlom is uninterrupted throughout its whole length. Its composition out of two lateral cœlomic sacs can still be recognised in the adult animal, the ventral mesentery being entirely, the dorsal partially, retained.

The cœlomic sacs of the trunk send outgrowths anteriorly into the cavity of the collar, which push before them the wall of that cavity; these are the **perihæmal** and **peripharyngeal cavities** (Fig. 460).

The **perihæmal cavities** are two dorsal prolongations of the trunk cœlom, which traverse the collar region and the neck of the proboscis as far as the proboscidal skeleton. They run below the collar cord and above the buccal cavity. In the median line the two cavities are separated by a structureless partition, a limiting membrane, in which the **dorsal vessel** runs. The perihæmal spaces are almost entirely filled by longitudinal muscle fibres formed by their

dorsal walls. These are the immediate anterior continuations of the dorsal longitudinal musculature of the trunk. In *Ptychodera*, a single weak layer of longitudinal muscle also develops on the ventral walls of the perihæmal cavities. In *Schizocardium* and *Glandiceps*, on the contrary, a transverse musculature is here developed. In the genus *Balanoglossus*, both longitudinal and transverse muscles are wanting in the ventral wall.

Besides the muscles which have been mentioned, there are fibres which traverse the perihæmal cavity transversely, chiefly in a dorso-ventral direction.

The **peripharyngeal cavities** are also anterior continuations of the

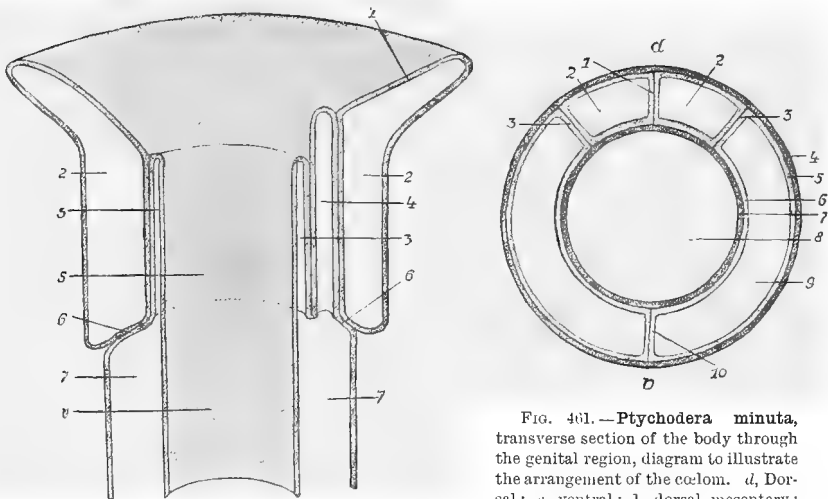

FIG. 400.—*Ptychodera minuta*, diagram of the collar coelom and of the anterior region of the trunk, in an almost median longitudinal section (after Spengel), somewhat modified. 1, Anterior wall of the collar; 2, collar coelom; 3, peripharyngeal cavity; 4, perihæmal canal; 5, buccal cavity; 6, septum dividing the collar from the trunk; 7, trunk coelom; 8, œsophagus.

FIG. 401.—*Ptychodera minuta*, transverse section of the body through the genital region, diagram to illustrate the arrangement of the coelom. *d*, Dorsal; *v*, ventral; 1, dorsal mesentery; 2, dorsal accessory chambers of the trunk coelom; 3, lateral mesenteries; 4, body epithelium; 5, parietal wall; 6, visceral wall of the trunk coelom; 7, intestinal epithelium; 8, intestinal cavity; 9, principal chamber of the trunk coelom; 10, ventral mesentery.

the trunk coelom, which push in between the buccal cavity (pharynx) on the one side and the collar coelom on the other, and, in *Ptychodera*, surround the buccal cavity. Anteriorly, they end dorsally at the point where the proboscidal diverticulum of the intestine arises, and laterally, at the points of attachment of the vascular folds. The inner wall of the peripharyngeal cavities consists of a layer of **circular muscle fibres** which surrounds the buccal cavity, closely applied to its epithelium, and only separated from it by a limiting membrane.

In *Schizocardium*, the two peripharyngeal cavities are less extensive, they lie at the sides of the buccal cavity, without surrounding it either ventrally or dorsally. Each peripharyngeal cavity forms a

triangle, whose sides are constituted as follows. The first (posterior) side corresponds with its origin out of the trunk cœlom; the second (dorsal) with the lateral edge of the perihæmal cavity; the third (anterior and lower) with the line of insertion of the vascular fold. There is a corresponding limitation and circumscription of the transverse muscle fibres on the lateral walls of the buccal cavity. Nevertheless a closed muscular envelope is formed: (1) dorsally, by means of the transverse musculature on the lower walls of the perihæmal cavities; (2) ventrally, by the transverse musculature of the collar cœlom.

Peripharyngeal cavities are found, not only in *Ptychodera* and *Schizocardium*, but in *Balanoglossus Kowalevskii*, in the same form as in *Schizocardium*, but provided with **longitudinal** instead of transverse muscles, not belonging, however, to the inner or visceral wall, but to the outer parietal wall which is in contact with the collar cœlom.

In *Ptychodera*, a further complication occurs in the divisions of the trunk cœlom. In the anterior hepatic and the branchiogenital regions, an **accessory or lateral mesentery** (Fig. 461) occurs on each side dorsally in the submedian line, in addition to the two principal (median) mesenteries. This accessory mesentery runs from the intestine to the integument, dividing the cœlom at this point into four chambers, two large, ventral, principal chambers, and two small dorsal **accessory chambers**. The accessory chambers open posteriorly into the principal chambers, the accessory mesentery disappearing; anteriorly, they narrow and end in the branchial region. They are here no longer in contact with the intestine, but only with the integument, the accessory mesenteries here shifting their visceral edges of attachment on to the integument, in a manner which cannot here be described more in detail.

By far the greater part of the walls of the trunk cœlom are taken up in the formation of musculature. The parietal wall most especially becomes differentiated into a powerful **dermo-muscular tube** which gradually diminishes in strength posteriorly.

The most important and constant part of this dermo-muscular tube is the **longitudinal musculature**.

The longitudinal musculature, which is specially strongly developed on the ventral side of the body, in the genital folds (where these are developed), and on the dorsal side in the branchial region, is **interrupted** in the dorsal and ventral median lines by the median mesenteries. A similar interruption takes place in the branchiogenital region in the submedian lines, in which the gonads, and, in the genera *Balanoglossus*, *Glandiceps*, and *Schizocardium* the gills also, open.

By these **four lines of interruption**, the longitudinal musculature is divided into two dorsal and two ventrolateral areas. (*B. canadensis* has two streaks on each side free from muscle, and gonads open in both.)

Each longitudinal fibre runs in a curve between two points, one behind the other, on the limiting membrane of the body epithelium. Each fibre thus crosses numberless others.

In *Ptychodera*, in addition to these, an **outer circular muscle layer** is also differentiated from the parietal wall of the trunk cœlom; the fibres of this layer pass through the mesenteries.

A true circular muscle layer is nowhere else developed. Such a layer is, however, functionally replaced by **pseudo-circular muscle fibres** which run on the inner side of the longitudinal musculature, but which in **reality** do not form a closed ring.

In *Schizocardium*, the bundles of these pseudo-circular muscle fibres run on each side from the dorsal edge of the mediadorsal mesentery to the dorsal edge of the ventral mesentery. Similar bundles arise near the ventral edge of the ventral mesentery, and break up into fibres on the lateral walls of the body, ascending along the inner side of the longitudinal musculature, traversing it, and becoming attached to the limiting membrane of the body. In *Glandiceps*, this latter system is repeated (but of course reversed) on the dorsal side.

Balanoglossus has neither the outer true, nor the inner pseudo-, circular musculature.

Radial muscle fibres connect the limiting or basal membrane of the body epithelium with the limiting membrane of the intestine throughout the whole cœlom. In the genital folds, these fibres are stretched between opposite points of the integument. In the region of the lateral mesenteries, similar fibres stretch between these and the integument.

VII. The "Heart Vesicle" (Figs. 456, 21, p. 566; 464, 11, p. 583).

This is one of the names¹ suggested for a **small closed sac which lies upon the proboscidal diverticulum of the intestine in the basal part of the proboscis**. Its ventral wall bends down somewhat over the diverticulum to right and left, and it is separated from the latter by a small blood sinus. Posteriorly, towards the neck of the proboscis, the "heart vesicle" is drawn out to a small tip, which is traversed by fibres, most probably muscular, chiefly in a transverse direction, while the rest of the vesicle contains a fluid as clear as water. The median part of the posterior and dorsal wall is in contact with the body epithelium of the neck of the proboscis.

The ventral wall is formed of a single layer of transverse muscle fibres and pear-shaped cells, while the rest of the wall is represented by a plate epithelium. The existence of a closed circular musculature has not yet been demonstrated.

The "heart vesicle" in *Schizocardium* (and to a lesser degree in *Glandiceps* also) is produced anteriorly into two large symmetrically arranged tips, the auricles. From the posterior tip of the "heart vesicle" two bundles of muscle fibres arise which pass anteriorly into these auricles, each one giving off fibres, one after the other, to the wall of the auricle it enters.

It must be emphasised that the "**heart vesicle**" **does not belong to the blood vascular system**, and does not communicate with it, but is merely **in contact** with part of that system. If, therefore, the vesicle propels the blood, this can only

¹ Morgan suggests "Proboscis vesicle."—Tr.

occur in a way similar to that seen in the lower Crustacea, where the contractions of the intestines are able to set the body fluid in motion.

The "heart vesicle" appears, according to recent researches, to be of ectodermal origin, and thus cannot be considered as a cœlomic vesicle.

VIII. The Limiting Membranes, the Proboscidal Skeleton, and the Branchial Skeleton.

Throughout the whole body of the Enteropneusta, the walls of organs which are in contact are separated from one another by **structureless limiting membranes**, which are to be regarded as secretions of these walls. These limiting membranes must be thought of as composed for the most part of two adhering laminae. **The blood vessels lie within the limiting membranes**; they represent a system of spaces between the two laminae.

In secreting the limiting membranes, the histological character of the secreting walls is of no consequence. A muscle wall can secrete a limiting membrane just as well as an epithelial wall.

After the foregoing description the reader will be able to understand without further assistance the occurrence and arrangement of limiting membranes in the body. He will, for example, know that a limiting membrane exists everywhere below the body epithelium, secreted by that epithelium on the one hand, and by the parietal wall of the cœlom on the other.

A similar limiting membrane must also occur between the visceral wall of the cœlomic sacs and the intestinal epithelium, as also between the anterior and posterior walls composing the septa, which separate collar from trunk, peripharyngeal cavities from collar cœlom, etc. etc.

At certain points, especially in the proboscis and on the branchial intestine, the limiting membrane becomes thickened, and forms the **proboscidal and branchial skeletons**.

A. The **proboscidal skeleton** consists of a median **body** and two **limbs** diverging backward. The body of the proboscidal skeleton lies in the neck of the proboscis, between the neck of the proboscidal diverticulum of the buccal cavity above, and the ventral body epithelium of the neck of the proboscis below. The limbs diverge to right and left into the collar region, clasping from above the entrance to the buccal cavity, and in close contact with its epithelium.

The proboscidal skeleton is further strengthened laterally by the **chondroid tissue** which becomes attached to it. The ground substance of this tissue is identical with the substance of the proboscidal skeleton, and of the limiting membranes generally. It is secreted by the anterior wall of the collar cœlom, and by the posterior wall of the proboscidal cœlom, or by the latter alone; but cell processes of these walls remain in the secreted ground substance, and these processes may break up into cell groups or nests, which give sections of the

chondroid tissue a certain similarity to cartilage. This chondroid tissue is most developed, forming a mass thicker than the pro-

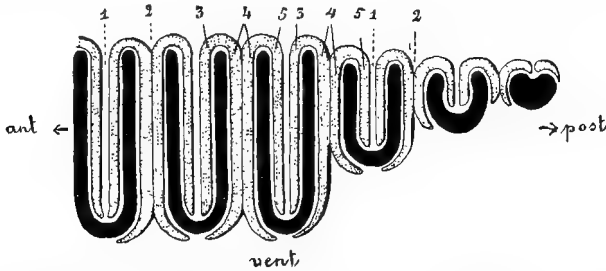

FIG. 462.—Gill slits and branchial skeleton of an Enteropneustan. The six hindmost gills seen from the intestine, the three posterior in the act of forming, diagrammatic. The black parts represent the U-shaped gill slits; the dotted parts, the skeletal forks. 1, Branchial tongue; 2, branchial septum; 3, anterior prong; 4, median or septal prong; 5, posterior lingual prong of a three-pronged skeletal fork.

boscidal skeleton, which always remains at its centre, in the genera *Schizocardium* and *Glandiceps*.

B. The Branchial skeleton (Figs. 462 and 463). (Cf. here pp. 567 and 568 on the gill slits, the branchial septa, and the branchial tongues.)

The branchial skeleton here, again, consists of local thickenings of the limiting membrane, which separates the epithelium of the branchial intestine from the visceral wall of the trunk cœlum of the branchio-genital region. These thickenings are in the form of upright three-pronged skeletal forks, which are arranged on each side, in a single longitudinal row, throughout the whole length of the branchial region. The number of forks corresponds with that of the gills. The free ends of the prong are turned downwards, and the connecting piece upwards. The three prongs of a fork are arranged as follows. The middle prong lies in a branchial septum, under the surface of the septal edge, which is turned towards the cavity of the branchial intestine. This septal prong forks at its free lower end, giving off a short anterior and a posterior branch.

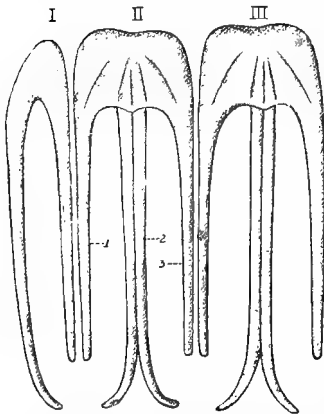

FIG. 463.—The three anterior forks of the branchial skeleton in *Balanoglossus Kowalevskii* (after Spengel). The most anterior (I) has only two prongs. 1, A posterior lingual prong; 2, a septal prong (in its origin double); 3, an anterior lingual prong.

The anterior prong of a fork lies on the posterior wall of the branchial tongue, immediately in front of the septum; the posterior prong in the anterior wall of the branchial

tongue, immediately behind the septum. Each fork thus has a median septal prong, and an anterior and a posterior lingual prong. Each tongue has two prongs, one anterior and the other posterior, but these belong to two different forks. Each septum has only one prong. A very minute examination shows, however, that each septal prong consists of two fused prongs. Two-pronged forks must, therefore, be the ultimate elements of the branchial skeleton. Each fork would lie with one prong in a tongue and the other in a septum. The two septal prongs belonging to two consecutive two-pronged forks, are, however, in every case fused together.

The most anterior skeletal fork, and it alone, has two prongs.

In the formation of the lingual prongs, the branchial epithelium (belonging to the intestine) and the mesodermal, inner wall of the lingual cavity (belonging to the visceral wall of the trunk coelom) take part, but the septal prongs are secreted exclusively by the branchial epithelium of the septal edge.

IX. The Blood Vascular System.

The blood vascular system consists of **spaces in the limiting membranes of the body**. The two lamellæ of the limiting membranes simply remain apart at certain points, thus forming the walls of the vessels. An endothelium-like covering of the inner side of the separating lamellæ has only been found in *Ptychodera*, and in isolated parts in *Schizocardium* and *Glandiceps*. Nothing of the sort has been observed in *Balanoglossus*. In *Ptychodera*, isolated blood cells float in the colourless blood fluid.

The lacunar blood vessels of the Enteropneusta do not arise by the separation of the formerly contiguous lamellæ of a limiting membrane. They are, rather, **persistent portions of the larval segmentation cavity or blastocœl**. The organs of the larva lie in a spacious blastocœl, which narrows and disappears in proportion as the organs (especially the coelomic sacs) increase in size, these swelling up in such a way that their walls come in contact with one another and with the body and intestinal epithelium. Certain cavities, however, persist, which afterwards form the blood vascular system. The blood cells and endothelial cells of the vascular system are, in all cases, of mesenchymatous origin.

The arrangement of the vascular system may be roughly described as follows.

There is a capillary network in all the limiting membranes of the body, especially in that of the integument and of the intestine. This network is in connection with larger vessels, *i.e.* (1) with a **dorsal vessel** which, in the dorsal mesentery, runs through the trunk and collar and communicates with the blood vessels of the proboscis, and (2) with a **ventral vessel** which, running in the ventral mesentery of

the trunk, receives blood from the proboscis through two lateral vessels or vascular plexuses within the two vascular folds of the collar, these vessels or plexuses usually uniting in the ventral median line at the posterior end of the collar region. **The dorsal and the ventral vessels** of the trunk have **muscular walls**, which, however, do not properly belong to them, but are borrowed from the apposed walls of the mesenterial portions of the cœlomic sacs. In the proboscis, the blood vascular system, by increase of its surface towards the proboscidal cœlom, to right and left of the basal complex of organs, gives rise to the so-called **proboscidal gill** or **glomerulus**.

Special.—The finer details cannot be entered upon.

1. **Vessels of the trunk**.—While the dorsal mesentery is retained in the abdominal part of the body (as already noted, the ventral mesentery persists throughout the whole trunk) it may disappear in the anterior trunk region with the exception of the part which contains the dorsal longitudinal vessel. The **muscles of the vascular trunks** are transverse or circular muscles, and, in part at least, continuations on to the mesenteries of the circular musculature of the body. The ventral vascular trunk of *B. Kowalevskii* is provided, not with a transverse, but with a longitudinal musculature. The musculature (which is yielded by the mesenterial endothelium) always lies on the side of the limiting membrane away from the lumen of the vessel, and facing the body cavity.

2. **The dorsal vessel of the collar** is the direct continuation of the dorsal vessel of the trunk. It runs between the two perihæmal cavities, from whose walls it borrows its musculature. Passing out again from between these cavities, it loses its musculature and opens, in the proboscis, into a blood sinus, the **basal sinus** of the proboscis. This is a space left between various heterogeneous organs,—the proboscis pore, the diverticulum of the intestine, the posterior tip of the “heart vesicle,” the epithelium of the neck of the proboscis.

This basal sinus communicates, on the one side, with the capillary network in the wall of the proboscis, and on the other, through a narrow slit, with the central blood sinus of the proboscis which lies in front of it.

3. The **central blood sinus of the proboscis** (Fig. 464, 9) is a space in that limiting membrane which separates the “heart vesicle” (dorsally) from the proboscidal diverticulum of the buccal cavity (ventrally). It has no musculature of its own. This, however, is supplied by the ventral transverse musculature of the “heart vesicle” which lies above it. In *Schizocardium*, the central blood sinus is continued in a peculiar manner, which cannot here be further described, on to the two “auricles” of the “heart vesicle.”

4. The **proboscidal glomerulus** (Fig. 464, 10) consists of two lateral principal portions and a dorsal connecting piece. Each of the principal portions has the form of a unilaminar honeycomb, with deep cells. The base of the comb is formed by the right or left lateral walls of the basal complex of proboscidal organs, *i.e.* of the “heart vesicle” and the proboscidal diverticulum of the intestine. The apertures of the single “cells,” however, are turned towards the proboscidal cœlom. The walls of the cells are formed by folds of the visceral endothelium of the proboscidal cœlom. They are hollow, and the cavities are blood sinuses, which open into a common cleft-like sinus in the base of the comb. This latter, again, communicates, by means of a slit-like transverse aperture, between the “heart vesicle” and the proboscidal diverticulum, with the central sinus of the proboscis (Fig. 464, 9). Posteriorly, each lateral principal part of the glomerulus becomes simpler and

simpler, and its sinus, which anteriorly is so complicated, becomes on each side a simple vessel in the limiting membrane between the proboscidal intestine and the visceral cœlomic endothelium.

These two vessels are the efferent proboscidal vessels.

Blood reaches the central sinus of the proboscis in the following ways: (1) from the dorsal vessel of the trunk and collar through the basal blood sinus, (2) out of the integumental vascular network of the proboscis through vessels or a vascular plexus, which ascends in the limiting membrane of the ventral septum, and lastly (3) out of this vascular network through a vessel, which descends along the free edge of the "heart vesicle."

The "heart vesicle" propels the blood by means of its ventral wall, which lies upon the central sinus. Its function is considered to be that of driving the blood

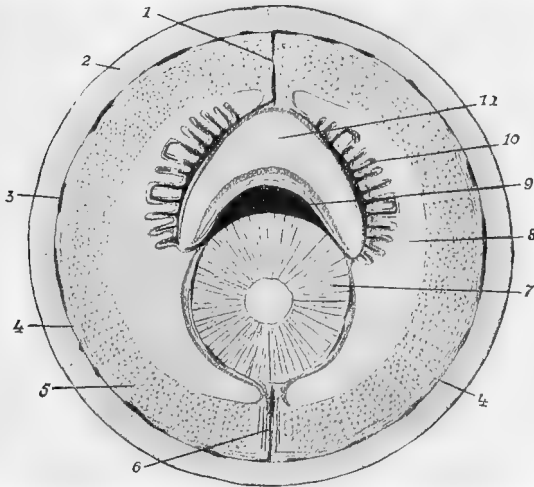

FIG. 464.—Diagrammatic transverse section through the proboscis of an Enteropneustan. 1, Dorsal proboscidal septum; 2, proboscidal epithelium; 3, blood lacunæ of the integument; 4, circular musculature; 5, longitudinal musculature; 6, ventral proboscidal septum; 7, proboscidal diverticulum of the buccal cavity; 8, proboscidal cœlum; 9, central blood sinus of the proboscis; 10, proboscidal glomerulus; 11, "heart vesicle."

through the narrow passages of the glomerulus, and through the efferent proboscidal vessels finally into the ventral vessel of the trunk.

If the proboscis pore takes in water for swelling the proboscis, it appears pretty certain that the glomerulus (formerly called the proboscidal gill) must, irrespective of other unknown functions, also serve for respiration.

5. **The efferent proboscidal, and collar, vessels.**—From their origin out of the two posterior tips of the lateral portions of the glomerulus, these vessels turn ventrally, and, running very close to one another, traverse the chondroid tissue of the neck. In the anterior and upper area of the collar region, they enter the two vascular folds, in whose limiting membranes they run, breaking up into more or less rich plexuses. Their courses then, naturally, correspond with those of the vascular folds, which take their name from the vessels within them. In *Schizocardium*, *Balanoglossus*, and *Glandiceps*, where the two vascular folds descend slantingly to the ventral median line of the posterior end of the collar, they neces-

sarily also have slanting systems of blood vessels, which open into the anterior end of the ventral vessel of the trunk.

In *Ptychodera*, on the contrary, where the vascular folds descend perpendicularly in the anterior part of the collar region, and form a ring around the buccal cavity, which is then continued as a medioventral fold to the posterior end of the collar, the vessels which run in these folds naturally also form a similar ring, which passes into a medioventral collar vessel continuous with the ventral vessel of the trunk.

The vessels of the collar are distinguished from the principal vessels of the trunk by the fact that they possess no musculature.

A circular space, running in the limiting membrane of the septum separating the collar from the trunk, is in open communication with the ventral vascular trunk.

6. **The vascular capillary networks of the integument and of the intestine** are everywhere in communication with the two principal vessels. In the collar, a connection is formed between the integumental and the intestinal plexuses by plexuses running in the mesenteries. Where peripharyngeal cavities are found (*Ptychodera*, *Schizocardium*) the integumental plexus lies in the peripheral walls of the cavities, viz. those turned to the œlom of the collar. Of all the sections of the intestine, the hepatic is most distinguished by the closeness of its capillary plexus and its rich supply of blood.

In some species of *Ptychodera*, dendriform, blindly-ending, vascular cœca project from the dorsal side of the collar cord and sometimes also from the dorsal septum.

7. **Lateral vessels—Ptychodera.**—Two lateral vessels, provided with muscular walls, run through the branchiogenital and hepatic regions. They originate anteriorly out of the vascular network of the integument, run backward in the submedian line, and enter the lateral mesenteries, in whose limiting membranes they run. At the posterior ends of these mesenteries, at the boundary between the branchiogenital and the hepatic regions, they pass over on to the intestine, being continued in two vessels running along close below the liver-cœca of the intestine, and finally open into the intestinal capillary network. The anterior portions of the lateral vessels, which might be called the genital vessels, are connected with the capillary network of the gonadial walls. Similar lateral vessels also occur in *Schizocardium*.

In *Balanoglossus* and *Glandiceps* there are, usually in the hepatic region, two lateral vascular trunks of the intestine, which open anteriorly and posteriorly into its capillary network. Their musculature consists, in *Glandiceps*, of circular fibres; in *Balanoglossus*, of longitudinal fibres. These perhaps correspond with the posterior or intestinal portion of the lateral vessels of *Ptychodera*.

8. **The branchial vessels.**—These vessels have been best investigated in *Ptychodera*. A branchial capillary network is found in the limiting membranes both in the branchial tongues and the branchial septa, *i.e.* in the limiting membrane which separates the epithelium of the branchial intestine from the visceral layer of the mesoderm which lies outside it. Into this plexus, vessels having a definite constant course and of large size enter: (1) a vessel along the back of each tongue, (2) a vessel along the inner side of each lingual prong, *i.e.* on the side turned to the lingual cavity, (3) a vessel along that edge of each septal prong which is turned to the body wall. These last-named vessels run ventrally into the capillary network of the lower, nutritive part of the branchial intestine (*i.e.* of the œsophagus), and must be considered as efferent vessels of the branchial septa.

The branchial capillary network receives its blood from **afferent branchial vessels**, which originate out of the dorsal vessel and (in *Ptychodera clavijera*) have the following arrangement: Each afferent branchial vessel, soon after its origin

out of the dorsal vessel, divides into two, one running into a tongue and the other into the branchial septum next in front. The lingual vessel divides again into two branches, which are continued into the two above-mentioned vessels of the lingual prongs ("tongue-bars").

It is not known in what way the blood is again carried out of the branchial tongues.

X. The Gonads.

The sexes are separate in the Enteropneusta. The gonads are simple or branched sacs of various shapes which project into the body cavity of the trunk, towards which, however, they are completely closed. They form on each side a conspicuous longitudinal row in the genital region of the trunk, which, however, is not sharply demarcated from the branchial region in front of it nor from the hepatic region behind it. At the posterior end of each row of gonads, a constant formation of new gonads takes place.

The gonadial sacs open outward through simple efferent ducts and genital pores, which always lie dorsally in the submedian line close to, but on the outer side of, the branchial pores (Fig. 458).

These gonads, which open laterally to the branchial pores, form the row of **principal gonads**, and their pores are the **primary principal pores**.

A certain agreement in the number of the gonadial pores with that of the branchial pores is sometimes found.

The arrangement of the gonads may become complicated.

A. One and the same gonadial sac may open outward through **accessory pores**, which lie either medianly, or laterally, to the principal pore.

Such accessory pores are found in *Schizocardium brasiliense* and *Glandiceps talaboti*, in the latter in great numbers.

B. **Accessory gonads** may occur in addition to the principal gonads, opening outward through **secondary genital pores**.

In *Balanoglossus Kupfferi*, such accessory gonads form a complete row running parallel with the principal row, along its median side. The same is the case in *Glandiceps talaboti*, although here the accessory row is not quite complete. In *Balanoglossus canadensis*, both principal and accessory gonads occur, there being several rows of each. The pores of all the gonads lie in the submedian lines, which are free from muscle, and are in this case widened into broad streaks.

When accessory gonads occur in species of *Ptychodera* (e.g. *Pt. aurantiaca*, *bahamensis*, *erythrea*) their pores always lie laterally to the principal pores.

Structure of the gonads.—The gonads consist (1) of a wall turned to the coelomic cavity and belonging to it, constructed of a tessellated epithelium and fine muscle fibres, and (2) of a massive inner germinal layer, consisting of germinal cells and covering or follicle cells; this layer is continued into the epithelium of the efferent ducts.

Between these two layers lies (3) a limiting membrane, in which a rich capillary network may be developed, or else the membrane is divided into its two lamellæ by a continuous slit-like blood sinus.

The **origin of the gonads** is not yet certainly known. They were formerly held to be derived from the ectoderm, but the most recent researches seem to show that they arise as local accumulations of the mesenchyme cells which occupy the blastocœl. In any case the connection of the gonads with the body epithelium by means of the ducts is secondary. They originally lie isolated between this epithelium and the parietal layer of the cœlom.

XI. Ontogeny.

The development of the Enteropneusta is sometimes connected with metamorphosis, a pelagic larva, the **Tornaria larva**, being developed. This larva in many respects recalls the *Bipinnaria* larva of the *Asteroids*, and was at first considered to be an Echinoderm larva. In other cases development is abbreviated, and is indeed almost direct, for though a free larva develops from the fertilised egg, it lives at the bottom of the sea, and shows no signs of many of the most important characters of *Tornaria*.

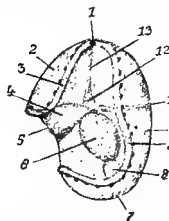

FIG. 465.—Very young specimen of *Tornaria Krohni*, from the side (after Spengel). 1, Apical plate with eyes; 2, preoral area; 3, preoral ciliated ring; 4, oesophagus; 5, mouth; 6, stomach; 7, anus; 8, hind-gut; 9, postoral ciliated ring; 10, postoral area; 11, proboscis pore; 12, proboscis; 13, muscle to apical plate.

A. Structure and Metamorphosis of the *Tornaria* larva.

The egg segmentation and gastrula are unknown.

1. **Outer organisation.**—The youngest larval stages observed are almost egg-shaped (Fig. 465). At the **anterior pole** there is a **pair of brown eye-spots**, at the **posterior** the **anal aperture**, and in the middle of the **ventral side** the **long transverse mouth**. The thin transparent integument is thickened only in the region of two **ciliated rings**, which border, in a manner soon to be described, a somewhat deepened **oral area**, at whose centre the mouth lies. The ciliated rings are strictly bilaterally symmetrical. A **preoral ciliated ring** runs from the anterior ventral edge of the oral area forwards and upwards on each side to the frontal region, where the eyes lie, and marks off a **preoral area**. A second ciliated ring runs back on each side, almost longitudinally, from the frontal region, then bends round on to the ventral side, and here, behind the mouth, passes into the corresponding ciliated band of the other side of the body.

This **postoral ciliated ring** forms the dorsal and posterior boundary to the oral area, and marks off a **postoral area**, which comprises the dorsal and posterior (anal) regions of the larval body. The preoral and postoral ciliated rings unite for a very short distance at the apical pole. The oral area enclosed within these two rings has the form of a transverse ventral saddle, drawn out on each side towards the apex.

The next remarkable change which is externally visible is the appearance of a ciliated ring at right angles to the principal axis. This surrounds the posterior part of the postoral area, and is the **principal ciliated ring** (Fig. 466, 9). The postoral area is by it divided into an anterior and a posterior region. The posterior region is the anal area, with the anus at its centre. In the anterior region, a dorsal area can be distinguished from a ventral zone. Behind the principal ciliated ring, a second weaker ciliated anal ring may appear (Fig. 466, 8).

During the further transformations which take place in the larva, the **anal area** which is bordered by the greatly developed principal ciliated ring remains almost unaltered, while the oral area, pushing out before it the preoral and the postoral rings, sends symmetrical extensions (Fig. 466) into the pre- and postoral regions, as follows :—

From the anterior and lateral tips of the oral region which stretch to near the apical pole, two extensions, one on each side, run posteriorly and ventrally into the preoral area (13), two more posteriorly and dorsally into that region of the postoral area which was above distinguished as the dorsal area (2).

In this way the larva, seen from the apical pole, has temporarily a four-rayed appearance.

From the lateral and dorsal regions of the oral area, two extensions invade a postoral area dorsally (4). From the posterior lateral edges, two inconspicuous

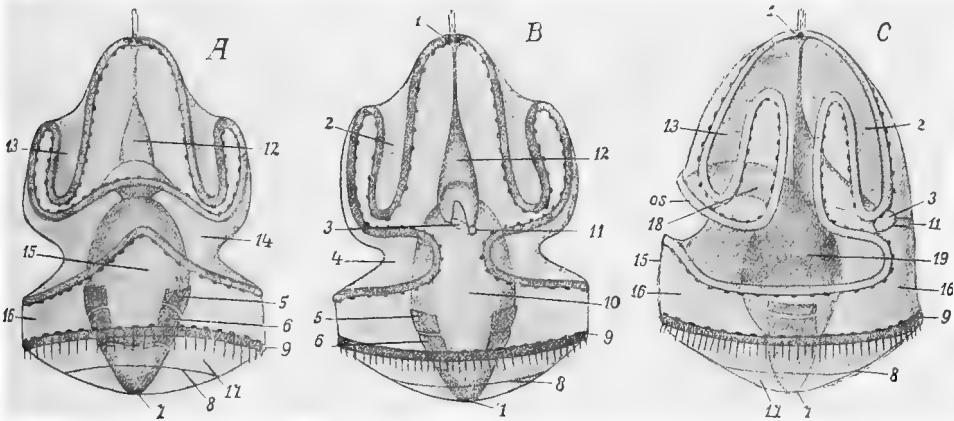

FIG. 466.—A, B, C, *Tornaria Mülleri* (?). A, From the ventral side; B, from the dorsal side; C, in profile (after Spengel). 1, Apical plate, with the eyes and apical tuft; 2, anterior dorsal lobes of the oral area; 3, "heart vesicle"; 4, posterior dorsal lobe of the oral area; 5, collar coelom; 6, trunk coelom; 7, anus; 8, secondary anal ciliated ring; 9, principal anal ciliated ring; 10, postoral area; 11, proboscis pore; 12, proboscidal coelom (water sac); 13, anterior ventral lobe of the oral area, 14, oral area; 15, ventral "saddle"; 16, ventral zone of the postoral area; 17, anal area; 18, oesophagus; 19, stomach-intestine.

extensions may spread posteriorly. The ventral zone, however, bulges forwards ventrally towards the oral area (15).

These changes bring about the peculiar indented course of the preoral and postoral ciliated rings, shown in the figures.

The ciliated rings may even become still more folded. Such folding reaches the highest degree in *Tornaria Grenacheri*, hardly 1 cm. long, in which the anterior ventral and the anterior dorsal extensions of the oral area bulge out at the cilia-carrying edge to form numerous long, narrow, freely projecting accessory lobes, resembling tentacles.

In the frontal region, on the **apical eye-bearing plate**, which here becomes differentiated, a tuft of delicate immobile cilia develops early.

The larva swims in such a way that the anterior or apical pole is directed upward and the anal pole downward.

The **metamorphosis** of the *Tornaria* larva into the young Enteropneustan is accompanied by the following external processes :—

The body lengthens and its preoral section becomes produced into the proboscis, at whose tip the eyes are still long visible, until they degenerate together with the apical plate and tuft.

The preoral and postoral ciliated rings degenerate, but the whole body becomes covered with cilia.

The principal ciliated ring (Fig. 467) persists for some time, eventually, *i.e.* when the anal area has increased in length, surrounding the body about half way between the mouth and anus. A circular furrow between it and the base of the proboscis is the first indication of the posterior boundary of the collar region.

The whole ectoderm of the oral area degenerates during metamorphosis, the body epithelium proceeding exclusively from the ectoderm of the preoral, postoral, and anal areas, which increases in thickness. This phenomenon, together with the lengthening of the larva, causes a very marked diminution in the transverse section of the body, an essential accompaniment of which is the approximation of the larval integument to the parietal walls of the coelomic vesicles.

2. **Anatomical.**—The **apical plate** of the *Tornaria* larva, which completely degenerates later, consists of a dorsal and a ventral half. Below the surface of the specially thick dorsal half there is a **layer of nerve fibres**.

The centre of the apical plate is formed by a small group of long narrow **sensory cells** carrying delicate immobile **cilia** (sensory hairs).

The two eyes which are embedded in the apical plate are **optic pits**, whose floors are formed by cells which are **pigmented** at their bases (**retinal cells**?). The optic pit is filled with a clear **substance**, which is a continuation of the cuticle covering the apical plate, and is called the **lens**. The apertures of the two pits diverge anteriorly and laterally. Round them in the apical plate there is a deeper layer of elements, which are considered to be **ganglion cells**.

The **alimentary canal**.—Even the youngest larvæ observed showed the division of the alimentary canal into **oesophagus, mid-gut or stomach, and hind-gut**, which is characteristic of all the larval stages.

The **oesophagus** ascends vertically. It is a flattened tube provided with a circular musculature, its thickened dorsal and ventral walls being ciliated.

The **stomach** is a large egg-shaped sac, whose axis lies horizontally, and into whose anterior pole the oesophagus enters. The epithelial cells of the sac are at first low, but they lengthen at a later stage. The originally thin-skinned stomach develops in this way a thick wall, which is probably non-ciliated except at two points. A ciliated cushion is found ventrally, at the entrance to the stomach, and the efferent aperture is surrounded by long hairs, which perhaps act as a fish-trap apparatus.

The **hind-gut**, in the youngest larvæ, is an almost cylindrical tube with thin walls. At a later stage its anterior part becomes swelled up, so that the hind-gut as a whole becomes funnel-shaped or conical. As, however, the aperture communicating with the stomach remains small, the wall of the hind-gut is applied over a considerable area to the posterior wall of the stomach. The aperture lies at the centre of this area. Immediately in front of the anal aperture there is a circle of cells provided with cilia.

Formation of the gills.—The formation of the first pair of gills takes place shortly before or after metamorphosis. Two lateral cæca arise at the posterior end of the oesophagus, grow out towards the integument, and break out laterally and dorsally through the external branchial pores. The oesophageal apertures of these branchial diverticula are at first round, later they become U-shaped, by the lateral dorsal intestinal wall growing out into the diverticulum. This outgrowth is the rudiment of the **branchial tongue**.

In *Tornaria Agassizi*, it was observed that the pores of the second pair of gills arise earlier than those of the first.

In other cases, the new pairs of gills always form behind the last produced. During the process, the growing œsophagus, the posterior part of which is now the branchial intestine, passes from a vertical to a horizontal position.

Even in the adult animal, new gill-pouches are constantly being formed at the posterior end of the branchial region. The course of development is always the same as that of the first gills in the larva.

The **collar canals, with their pores**, develop shortly before the rudiments of the second pair of gills arise, most probably as outgrowths of the anterior wall of the first gill-pouch, near its external pore. These outgrowths run forwards towards the collar cœlom.

The first rudiment of the **proboscidal diverticulum** of the buccal cavity has been observed in *Tornaria Agassizi*, as a small bulging of the anterior wall of the larval œsophagus directed anteriorly, and lying immediately above the mouth.

The **proboscidal cœlom**.—The rudiment of the proboscidal cœlom has not as yet been observed with as much certainty as could be desired. According to one observer, it arises as an outgrowth of the intestine at the boundary between the œsophagus and the stomach.

In the youngest stages which have been closely observed, the proboscidal cœlom (the so-called water sac of the larva) is an almost cylindrical tube lined with tessellated epithelium, the inner half of which is slightly widened. This tube becomes attached by its inner end to the anterior wall of the œsophagus, near the point at which the latter opens into the stomach. Here it sends two processes (the reins) to right and left on to the lateral walls of the œsophagus, on which it appears to ride. From the œsophagus, the tube, traversing the blastocœl, ascends almost vertically. Shortly before it reaches the dorsal ectodermal wall, it is continued into a short internally ciliated tube, the epithelium of which suddenly changes its character. This short tube, lined with cylindrical epithelium, is the rudiment of the **proboscidal canal**, and the pore to which it leads is the **proboscis pore**.

The proboscidal cœlom is further attached to the apical plate by means of a strand in the manner illustrated in Fig. 466; the strand consists of contractile fibres surrounded by a nucleated envelope, a continuation of the wall of the water sac. The contractile fibres of this strand are continued on to the tips or **reins** of the water sac, which grasp the œsophagus between them.

The further fate of the water sac, briefly stated, is as follows. It swells up, and soon changes from a tube into a vesicle, the greater part of the wall of which, during metamorphosis, becomes applied, as **parietal wall of the proboscidal cœlom**, to the body epithelium of the anterior or proboscidal section of the body, the **muscular apical strand** becoming shorter and shorter, and finally altogether disappearing.

The manner in which the epithelial walls of the water sac become differentiated into the **proboscidal musculature** cannot here be described.

"**Heart vesicle**."—Authorities differ as to the first rudiments of this organ. In the youngest stage investigated by the most recent observers, it is a small cellular structure with an internal cavity lying so close to the ectoderm that it may be either ectodermal or mesenchymatous. It appears to the right, in front of and near the proboscis pore. The body becomes a hollow vesicle, leaves the ectoderm, sinks below the surface, and becomes applied to the right side of the water sac. Transverse muscle fibres develop on its ventral wall. The water sac then forms posterior outgrowths, which grow round the "heart vesicle" on its right dorsal and ventral sides. The two dorsal posterior and the ventral posterior sections

of the proboscidal cœlom thus come into existence. The "heart vesicle" on its lower side, however, always remains separated from the dorsal wall of the ventral posterior outgrowth of the water sac by a space, into which the proboscidal diverticulum of the buccal cavity grows from behind, but in such a way that between it (the diverticulum) and the superimposed "heart vesicle" a space remains, which appears to become filled with blood at an early stage. This is the **central blood sinus of the proboscis**.

The cœlomic sacs of the collar and trunk.—These two pairs of cœlomic sacs appear, in *Tornaria*, to have a common rudiment in the following way. The edge formed by the anterior wall of the hind-gut, bending round backwards into its lateral walls, is produced anteriorly to right and left as hollow sacs, or in other cases

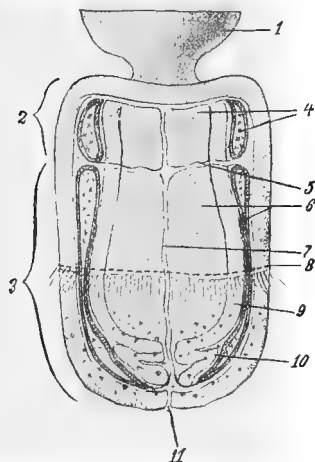

FIG. 467.—Collar and trunk of an *Enteropneustan* (*Tornaria Krohni*) immediately after metamorphosis, from the ventral side (after Spengel). 1, Proboscis; 2, collar; 3, trunk; 4, collar cœlom; 5, septum between the collar and the trunk; 6, trunk cœlom; 7, ventral mesentery; 8, principal ciliated ring; 9, wall of the mid-gut; 10, wall of the hind-gut; 11, anus.

as a pair of solid bilaminar plates. These become applied to the stomach, but are on the other hand separated by a large space from the ectoderm. These two sacs or plates become constricted from their matrix, the hind-gut, and grow round the stomach dorsally and ventrally. In each, apparently, an anterior portion becomes constricted off. This anterior pair of sacs or plates is the rudiment of the **collar cœlomic sacs**, the posterior, which only secondarily extend backwards along the sides of the hind gut, is the rudiment of the **trunk cœlomic sacs** (Fig. 467). These two cœloms are therefore enterocœls. Where the first rudiments of the cœloms are solid bilaminar plates, a space soon arises in them by the separation of the two laminae. These small spaces, whether present from the first, or formed later, begin to increase in size at the end of the larval period. The two pairs of cœlomic rudiments become vesicular.

The outer wall becomes applied to the body epithelium as the transverse section of the growing larva decreases during metamorphosis in the way already described, and forms the **dermomuscular tube**. The inner wall lies upon the intestine, and represents the **visceral layer of the cœlomic sac**. The **dorsal and ventral mesenteries** are formed where the right and left trunk cœlomic sacs and the right and left collar cœlomic sacs, in surrounding the intestine, come in contact dorsally and ventrally in the median plane.

These processes, of course, go hand in hand with a progressive reduction of the blastocœl, which contains a number (small at first, but increasing later) of mesenchyme cells of unknown origin. The remains of the segmentation cavity represent the **blood vascular system**.

Nervous system.—Shortly before the conclusion of metamorphosis, the two **longitudinal nerve trunks** arise as local differentiations of the body epithelium, below the surface of which a layer of nerve fibres forms. The **collar cord**, also, at first lies superficially in the integument, and is nothing more than the collar portion of the dorsal epithelial longitudinal cord. This part only sinks below the surface at a later stage. According to recent observers, the process recalls the sinking in and constriction of the neural tube in Vertebrates.

Gonads.—The development of the gonads has already been sufficiently described above, p. 586.

B. The almost Direct Development of the *Balanoglossus Kowalevskii*.

We can only select a few of the principal points in this development for description. **Segmentation** is total and equal, and leads to the formation of a **cœloblastula**, out of which, by invagination, a **cœlogastrula** is produced. This latter becomes covered with cilia, and a ciliated ring forms round the blastopore, which diminishes in size and finally closes; this ring corresponds with the principal ciliated ring of the *Tornaria* larva. At this stage the larva leaves the egg to live at the bottom of the sea, without showing any trace of the form, or of the characteristic ciliated rings, of *Tornaria*.

The differentiations which take place in the archenteron are important. Its anterior part becomes constricted off as a semilunar vesicle lying transversely. This takes up the whole of the most anterior part of the blastocœl and becomes the **proboscidal cœlom**, which thus, according to these observations, is an enterocœl. Two pairs of lateral outgrowths become constricted off from the rest of the archenteron, the anterior being the rudiment of the **collar cœlom**, and the posterior that of the **trunk cœlom**.

The blastocœl is small from the first.

The **mouth** is said to arise by the simple breaking through of the intestine outwards, and the **anus** in a similar way, in the place of the original blastopore. Thus the whole of the intestinal wall is of an endodermal origin.

The developmental processes in *B. Kowalevskii* cannot here be further described: we refer the reader to the account of the formation of the organs in the *Tornaria* larva, given above.

XII. Phylogeny.

The systematic position of the Enteropneustan must still, or rather again, be considered as altogether uncertain. In any case, the Enteropneusta are not closely related to any single large division of the animal kingdom. Special affinities with the Chordata, the Echinodermata, and the Nemertines have been long suggested, and in quite recent times also with Cephalodiscus and Rhabdopleura.

A. The relation of the Enteropneusta to the Chordata has been maintained on the following grounds:—

1. The Chordata and the Enteropneusta show a very far-reaching and extraordinary agreement in their gills. This agreement holds good even in details (branchial tongues, branchial skeleton, synapticulæ) if the gills of *Amphioxus* are taken for comparison.

2. The proboscidal diverticulum of the Enteropneusta is, in structure and origin, comparable with the chorda of the Chordata.

3. The proboscidal skeleton of the Enteropneusta corresponds with the sheath of the chorda.

4. The body cavities in the two groups are of enterocœlomic origin; the proboscidal cœlom corresponds with the anterior unpaired mesoderm vesicle of *Amphioxus*.

5. The collar cord of *Balanoglossus* corresponds with the dorsal cord of the Chordata, and arises in the same way as the neural tube of Vertebrates, by sinking in and covering over.

The most recent researches have, however, yielded results unfavourable to this assumed homology.

1. The great similarity of the Enteropneustan gills to those of *Amphioxus* in finer structure remains, but the detailed comparison of point with point makes a real homology doubtful, and seems to oblige us to consider the resemblance as at the most a very remarkable case of convergence.

Further, the following considerations must also be taken into account. The gills of *Amphioxus* arise ontogenetically as segmental structures, while those of the Enteropneusta, although standing in a longitudinal row, belong to the unsegmented trunk.

The gills of the Chordata receive their blood from the ventral vascular trunk, those of the Enteropneusta from the dorsal trunk.

Should it be proved that the larval œsophagus of the Enteropneusta proceeds from an ectodermal invagination, and is a stomodæum, then the gills of the Enteropneusta would lie in an ectodermal intestinal region, in contradistinction to those of the Vertebrata, which belong to an endodermal intestinal region.

2. The proboscidal diverticulum is a preoral outgrowth of the wall of the buccal cavity, and is lined with epithelium. It does not thus agree with the tissue of the noto-chord. It is further very questionable whether the buccal cavity, and, with it, the diverticulum are endodermal formations. The proboscidal diverticulum lies **below** the continuation of the dorsal blood vascular trunk (below the central blood sinus of the proboscis); the chorda of Vertebrates, on the contrary, lies **above** the dorsal blood vascular trunk (aorta). No homology between the two is possible.

3. The proboscidal skeleton, as a thickened limiting membrane, could at the most be compared only with the inner cuticular sheath of the chorda.

4. The body cavity is an enterocœl, in many different divisions of the animal kingdom (either constantly or exceptionally) other than the Enteropneusta and the Chordata. The cœlomic vesicles (mesoderm vesicles, primitive vertebræ) of the Vertebrata show a segmental arrangement, corresponding with the metamerism of the other organs, while in the Enteropneusta no such arrangement exists.

5. The collar cord of the Enteropneusta is only the anterior continuation of the dorsal nerve cord of the trunk. It does not sink below the surface until all its parts are formed. The corresponding ventral nerve cord of the Enteropneusta does not exist anywhere in the Chordata.

The following further points must be emphasised.

The gonads of *Amphioxus* arise segmentally from the endothelium of the body cavity, while the rows of gonads in the Enteropneusta lie in an unsegmented region. The first origin of the gonads of the Enteropneusta is, indeed, unknown, but their rudiments are found in the blastocœl very early. The manner in which the genital products are ejected in the two groups is altogether different.

In the Chordata, the blood in the dorsal vessel flows from before backward, in the ventral from behind forward; the reverse is the case in the Enteropneusta.

A comparison of the two collar pores in the Enteropneusta with the most anterior pair of nephridia in *Amphioxus* could only be of value were the development of these organs known. In all probability the former are of ectodermal and the latter of mesodermal origin.

There is nothing we know of in the Chordata comparable with the *Tornaria* larva.

These considerations render any relationship between the Enteropneusta and the Chordata, at least at present, highly improbable.

B. The relationship between the Enteropneusta and the Nemertina is so very problematical that it cannot here be discussed.

C. **Relation of the Enteropneusta with the Annelida.**—The attempt to bring the Enteropneusta and the Annelida into even a distant genetic relationship is

supported chiefly upon a comparison of larval forms. The following characteristics of the Trochophoran and the Tornarian larvæ have been pointed out.

The neural plate, the apical sensory organs, and the muscles which become attached to the neural plate correspond in the two. The divisions of the intestine also agree, that is, if the fore-gut of the *Tornaria* is an ectodermal stomodæum, and the hind-gut a proctodæum. The two pairs of coelomic sacs are comparable with the two anterior pairs of mesoderm vesicles.

The comparison of the ciliated bands presents difficulties. Three ciliated rings, a preoral (surrounding the apical area with the neural plate), a postoral, and a preanal, are typically ascribed to *Trochophora*, the last of which is supposed to correspond with the principal ciliated ring of *Tornaria*, while the preoral and the postoral rings of *Trochophora* are wanting in *Tornaria*. And it is argued that the absence of these rings in *Tornaria* has led to the specialisation of the preanal as the principal ciliated ring.

On the other hand the preoral ciliated ring of *Tornaria* cannot be compared with the preoral ring of *Trochophora*, because it does not surround the apical plate. This latter lies, on the contrary, outside the frontal area, at the opposite end of the oral region to the mouth; the preoral ring passes in front of it.

Compared with the principal ciliated ring, the pre- and postoral rings are, perhaps, of small morphological significance, since they are wanting in the non-pelagic larva of *Balanoglossus Kowalevskii*, whereas the principal ring occurs in it.

In a comparison of the *Tornaria* with the *Trochophora* larva, the great importance of the following differences must not be overlooked.

1. *Trochophora* possesses typically one pair of primitive kidneys, which are wanting in *Tornaria*.

2. *Tornaria* has a preoral coelom, which is absent in the *Trochophora* larva.

If now we turn to the organisation of the adult animals for light as to this question of the relationship between the Annelida and the Enteropneusta, we find immediately that insurmountable difficulties stand in the way of any close comparison. Only in the blood vascular system is any fundamental agreement found. The blood in the dorsal and ventral longitudinal vessels has the same course in both groups. But, on the other hand, a comparison of the nervous system of the Enteropneusta with that of the Annelida encounters difficulties similar to those found in comparing it with that of the Vertebrata. The gills in the two groups are altogether heterogeneous. The typical Annelidan kidneys are wanting in the Enteropneusta, for the collar pores, which are probably of ectoblastic origin, can hardly be regarded as a pair of nephridia.

Thus the relationship of the Enteropneusta to the Annelida appears at the best to be extremely distant.

D. The relation of the Enteropneusta to the Echinodermata.—This relationship is claimed on the ground of the agreement existing between the larval forms. The similarity of the *Tornaria*, especially with the *Bipinnaria* larva of the *Asteroidea*, is, indeed, so striking that the first observer of *Tornaria* expected for certain that it would develop into an Echinoderm.

A closer comparison yields the following results:

1. If we place the *Tornaria* and the *Bipinnaria* similarly with regard to the position of the mouth and the anus, a striking agreement in the conformation of the regions of the body and in the ciliated rings bordering them is observed (Fig. 468). In both we find a separate preoral ciliated ring in the same position, bordering a preoral area. In both we can distinguish, lying behind this, a deepened oral area with the mouth in its ventral centre. The postoral ciliated ring of the *Tornaria* corresponds with the large circumoral ring of the *Bipinnaria*.

The region of the body lying behind this occupies in both a large part of the dorsal posterior side of the body; in it lies the anus.

2. Whereas, in *Tornaria*, in the postoral area of the body, a large ciliated ring bounds an anal area, such a ring is wanting in *Bipinnaria*.

3. The apical plate with the two eyes and the tuft, which is so sharply marked in *Tornaria*, is wanting in the developed *Bipinnaria*. Too great a significance must not now, however, be attributed to this fact, since something like a neural plate (an ectodermal thickening with long cilia) has been observed in the quite young larvæ of *Asteroids* and *Echinoids*, and a neural plate with a layer of nerve fibres, ganglion cells, and ciliated tuft, although without eyes, has been demonstrated in the apical region of the *Antedon* larva.

4. The intestine of *Tornaria* shows the same divisions as are found in that of the Echinoderm larvæ, viz.: œsophagus, stomach-intestine, and hind-gut. Whether, however, these three sections correspond with one another in the two

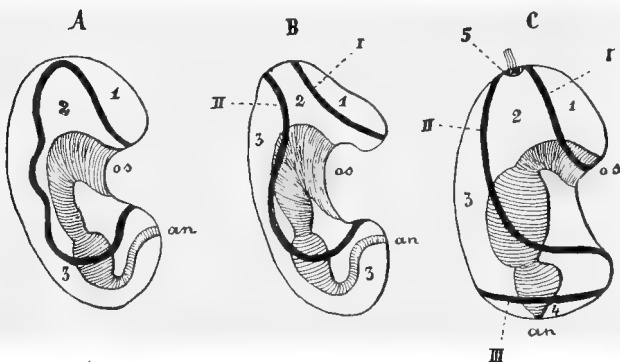

FIG. 468.—A, B, C, *Auricularia*, *Bipinnaria*, and *Tornaria* (Enteropneustan larva), from the right side, diagrammatic. 1, Preoral area; 2, oral area; 3, postoral area; 4, anal area; I, preoral; II, circumoral; III, anal or principal ciliated ring; 5, neural plate; os, mouth; an, anus.

groups must remain uncertain so long as the origin of the œsophagus and hind-gut is not definitely ascertained. In this matter the Echinoderms are in the same position as the Enteropneusta.

The œsophagus, in the Echinoderms, is sometimes described as an ectodermal stomodæum, sometimes as a section of the archenteron. The latter, according to the most recent investigations, is the case, *e.g.*, in the *Holothurioidea*, and the former in *Antedon* and others. In this case the œsophagus, even within the Echinodermata, is not an homologous structure! In the case of the Enteropneusta, in the interest of other views, doubt has been thrown upon the statement that the larval œsophagus is a part of the archenteron.

The hind-gut in the Echinodermata is, by all authorities, considered to be endodermal. The same was affirmed of the hind-gut of the Enteropneusta, but this has recently been strongly doubted.

5. The condition of the cœlom in the two larval forms would show great agreement if two pairs of cœlomic sacs can really be attributed typically to the Echinoderm larva, a point which recent research makes more and more probable, and if also the endodermal origin of the cœlomic vesicles of the Enteropneusta could be proved.

It would then be evident that the two anterior cœlomic sacs of the Echinoderm larvæ (the left of which is the hydrocœl) correspond with the two cœlomic sacs of

the collar of the Enteropneusta, and the two posterior sacs of the former with the two trunk cœlomic sacs of the latter. The two anterior sacs are in communication with the exterior through the collar pores; this communication (hydropore, water pore) in the Echinodermata is usually limited to the left anterior sac, *i.e.* to the left hydrocœl vesicle, but occasionally in *Asteroids*—a matter of great importance—appears on the right side as well.

From these considerations, it seems that the prospect of establishing a fundamental agreement in structure between the Enteropneustan larva and that of the Echinodermata is very hopeful. This relationship between the Enteropneusta and the Echinodermata seems to rest upon more solid ground than do any of the others which have been attributed to either of these two groups.

At the same time any attempt to compare adult Echinoderms with adult Enteropneusta is at present completely futile. The Echinoderms and Enteropneusta could, as far as we can see, only be genetically connected through some common racial form far back in their phylogeny—a form which corresponded with the Tornarian and the Dipleurulan larvæ.

Further, before we can feel any certainty on these questions of affinity, new and more exact ontogenetic researches must be made. The origin of the proboscidal cœlomic vesicle of the Enteropneusta has to be established, as has also that of the "heart or proboscis vesicle." Attention must be directed to the question as to whether a preoral section of the body corresponding with the proboscis of the Enteropneusta is present (if only as a rudiment) in the Echinoderm larvæ, as for instance in the preoral section of the body in the *Antedon* larva (?), or in the larval organs of *Asterina* and other *Asteroids* (?). With reference to the "heart vesicle" we are reminded of the statement that a "pulsating vesicle" occurs, apparently not of enterocœlomic origin, in Echinoderm larvæ. This has to be confirmed.

The Relationship of the Enteropneusta to Cephalodiscus and Rhabdopleura will be considered in the Appendage to this chapter.

Literature.

- Alex. Agassiz.** *The history of Balanoglossus and Tornaria.* *Mem. Amer. Acad. of Arts and Sc.* Vol. IX. 1873.
- W. Bateson.** *The early stages in the development of Balanoglossus.* *Quart. Journ. Microsc. Sc. (N.S.).* Vol. XXIV. 1884.
- *The later stages in the development of Balanoglossus Kowalevskii, with a suggestion on the affinities of the Enteropneusta.* *Quart. Journ. Microsc. Sc. (N.S.).* Vol. XXV., Suppl. 1885.
- *Continued account of the later stages in the development of Balanoglossus Kowalevskii and on the morphology of the Enteropneusta.* *Quart. Journ. Microsc. Sc. (N.S.).* Vol. XXVI. 1886.
- *The ancestry of the Chordata.* *Quart. Journ. Microsc. Sc. (N.S.).* Vol. XXVI. 1886.
- Gilbert C. Bourne.** *On a Tornaria found in British Seas.* *Journ. Mar. Biol. Assoc. (2).* Vol. I. 1889.
- R. Köhler.** *Recherches anatomiques sur une nouvelle espèce de Balanoglossus.* *Bull. Soc. Sc. Nancy (2).* Tome VIII. 1886. An almost identical work in *Internat. Monatsschr. Anat. Hist.* 3 Bd. 1886.
- A. Kowalevsky.** *Anatomie des Balanoglossus delle Chiaje.* *Mem. Acad. Imp. Sc. St. Pétersbourg (7).* Tome X. 1867.
- A. Krohn.** *Beobachtungen über Echinodermenlarven.* *Arch. f. Anat., Physiol. u. wissenschaft. Med.* 1854.

- A. F. Marion. *Études zoologiques sur deux espèces d'Entéropeustes*. Arch. Zool. génér. et expér. (2). Tome IV. 1886.
- E. Metschnikoff. *Untersuchungen über die Metamorphose einiger Seethiere*. 1. Ueber *Tornaria*. Zeitschr. f. wiss. Zool. 20 Bd. 1870.
- T. H. Morgan. *Growth and metamorphosis of Tornaria*. Journ. Morph. V. 1892. — *The Development of Balanoglossus*. Journ. Morph. Vol. IX. 1894.
- Joh. Müller. *Ueber die Larven und die Metamorphose der Echinodermen*. Part 2. Akad. d. Wissensch. 1848. Berlin, 1850.
- Wladimir Schimkewitsch. *The Fauna of the White Sea: Balanoglossus Mereschkovskii Wagner*. St. Petersburg, 1889. (In Russian.)
- J. W. Spengel. *Die Entéropeusten*. Fauna and Flora des Golfes von Neapel. 18 Monographie. Berlin, 1893. The most important recent work.
- W. F. R. Weldon. *Preliminary note on a Balanoglossus larva from the Bahamas*. Proceed. Roy. Soc. London. Vol. XLII. 1887.
- R. v. Willemoes-Suhm. *Biologische Beobachtungen über niedere Meeresthiere*. 4. Ueber *Balanoglossus Kupfferi* aus dem Oercsund. Zeitschr. f. wissensch. Zool. 21 Bd. 1871.
- A. Willey. *Amphioxus and the ancestry of the Vertebrates*. 1894.

Appendage to the Enteropneusta.

Cephalodiseus and Rhabdopleura.

I. Cephalodiseus (Figs. 469-471).

The body is about 1 mm. long, almost bean-shaped, bilaterally symmetrical; it is rounded posteriorly and anteriorly flat, with a slight backward slope. The most important organs which can be distinguished externally are found in this anterior sloping surface, while in the whole of the rest of the body only one organ appears, viz. a cylindrical stalk or pedicle, which rises from the ventral side of the rounded posterior end of the body.

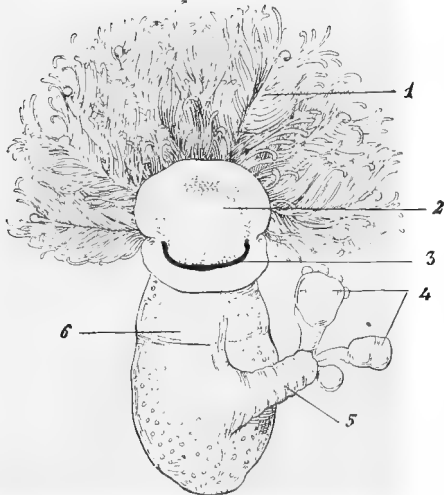

FIG. 469.—*Cephalodiscus dodecalophus*, from the ventral side (after McIntosh). 1, Tentacles; 2, buccal shield=proboscis; 3, mouth; 4, buds; 5, pedicle; 6, trunk.

slope mentioned above, the inter-stomatal region. The median

line between the mouth and anus is the **inter-stomatal middle line**.

In the inter-stomatal region or in its immediate vicinity lie the following parts of the body: (1) the preoral buccal shield with its two pores; (2), the central nervous system; (3), the twelve feathered tentacles; (4), the apertures of the two oviducts; (5), the postoral

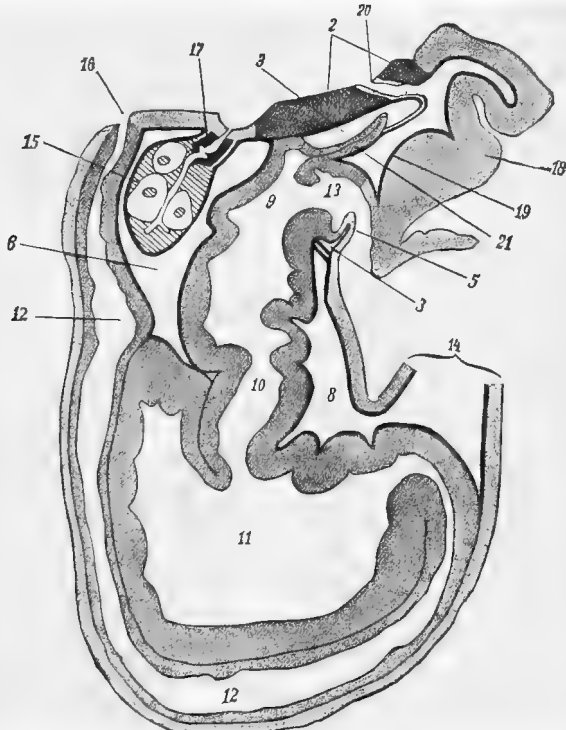

FIG. 470.—Median section through *Cephalodiscus dodecalophus* somewhat near the median plane (after Harmer). 2, Nervous system; 3, anterior paired coelom (collar coelom); 5, fold of the anterior trunk region; 8, paired trunk coelom; 9, pharynx; 10, oesophagus; 11, stomach-intestine; 12, hind-gut; 13, buccal cavity; 14, pedicle; 15, ovary; 16, anus; 17, oviduct; 18, buccal shield; 19, coelom of the same=proboscidal coelom; 20, one of the proboscis pores; 21, anterior diverticulum (proboscidal diverticulum) of the pharynx.

lamella; (6), the two postoral pores of the body cavity; (7), the two gill-slits (Figs. 470, 471).

The buccal shield, which is comparable with the proboscis of the **Enteropneusta**, is a plate, which projects downwards from the inter-stomatal region immediately in front of the mouth by means of a rather short stalk, in such a way that its free surface, the epithelium of which is enormously thickened, faces ventrally (Fig. 470, 18).

The **central nervous system** lies in the hypodermis, almost at

the centre of the inter-stomatal region. If we describe the mouth as lying posteriorly and ventrally to the stalk of the buccal shield, the central nervous system lies exactly opposite, that is, posteriorly and dorsally to the same structure.

Twelve tentacles rise dorsally at the base of the stalk of the buccal shield, six to the right and six to the left of the central nervous system. The nervous system extends into the dorsal hypodermis of these tentacles (Fig. 471). The tentacles are large, are feathered on both sides like the feathers of birds, and are knobbed at their free ends.

Two pores, placed symmetrically to the inter-stomatal median line, break through the most anterior part of the central nervous system. There is thus open communication between the body cavity of the buccal shield (the proboscis) and the exterior (proboscis pores).

Between the central nervous system and the anus there is on each side an aperture. These two apertures belong to the oviducts.

Outside of the inter-stomatal region, but in its immediate proximity, the following parts are found.

Immediately behind the mouth, covered by the oral disc, a thin lamella hangs ventrally and laterally down from the body like an apron; this is the **postoral lamella** (Fig. 471, 5). In the posterior angle formed by this lamella with the body, a pore is found on each side (collar pore).

These pores lead into the paired middle body cavity, of which we shall speak later. Immediately behind these pores, and like them over-arched by the lateral folds of the postoral lamella, two **branchial pores** lead from without into the pharyngeal section of the intestinal canal.

Musculature.—From near the mouth, longitudinal muscle fibres run back along the ventral side, and enter the pedicle. Muscles are

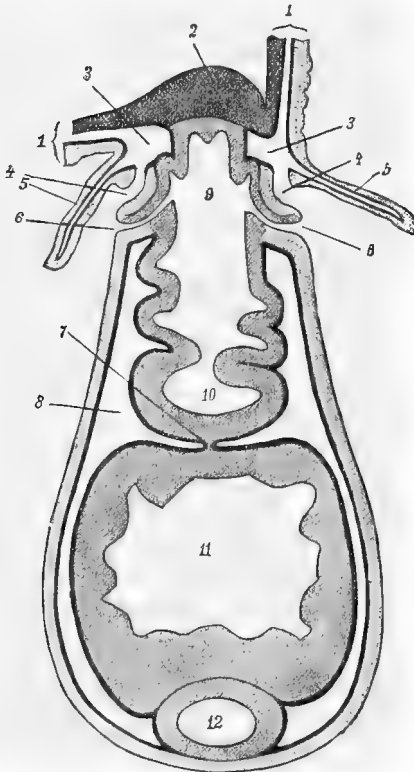

FIG. 471.—Horizontal section through *Cephalodiscus* (after Harmer). 1, Tentacles; 2, nervous system; 3, anterior paired body cavity (collar coelom); 4, collar pore; 5, folds of the anterior trunk region, the postoral lamella; 6, branchial pores; 7, mesentery; 8, paired trunk coelom; 9, pharynx; 10, oesophagus; 11, stomach; 12, hind gut.

also found in the stalk of the buccal shield, which radiate out from the stalk into the shield.

Body cavity.—In a young bud, the body appears to be divided into three sections (anterior, middle, and posterior) by two circular furrows. Each of these three sections possesses a separate body cavity. The most anterior section, out of which the buccal shield proceeds, has an **unpaired body cavity**, into which a short intestinal diverticulum enters from the middle section. The body cavity in both the middle and posterior sections is **paired**, the two lateral halves being separated by mesenteries. The boundary between the middle and posterior sections, the latter of which becomes the greater part of the body cavity in the adult, becomes more or less indistinct. The body cavity of the middle section is retained in the adult in the postoral lamella and in the region of the central nervous system and of the feathered tentacles, into which it is continued. The body cavity of the posterior section in the adult contains the whole of the alimentary canal and the ovaries, these organs almost entirely filling it. It is continued into the pedicle.

The **alimentary canal** forms a loop in the body, with a ventral section which runs backwards and into which the mouth leads, and a dorsal section running forwards and opening anteriorly through the anus. The mouth leads first into the "**pharynx**," which communicates with the exterior by means of the two **gill-slits** mentioned above. A thin **diverticulum** runs out anteriorly from the pharynx below the nervous system into the stalk of the oral disc. The pharynx is followed first by an **oesophagus** and then by a very spacious **stomach** or **stomach intestine**, which occupies by far the greater part of the body cavity. At the point where the pedicle joins the body, the stomach passes over into a narrower section of the intestine, which, immediately behind the stomach, ascends, and then, bending forward, runs along the dorsal side as the hind-gut to the anus.

Genital organs.—Male genital organs have not been observed. The **female** organs consist of two **ovaries**, lying in the anterior part of the body; they are continued into two strongly pigmented **oviducts**, which open outward through the apertures already mentioned (Fig. 470, 17).

Reproduction.—Besides multiplying sexually by means of eggs, *Cephalodiscus* also reproduces itself asexually by **gemmation**. The buds always form on the pedicle, near to its free end. Almost all adult individuals have from 1 to 3 buds.

Many individuals of *Cephalodiscus* live together in a ramifying and anastomosing system of tubes secreted by themselves, these tubes having occasional apertures. The animals, throughout life, when not disturbed, remain in the immediate vicinity of these apertures, through which they protrude their unfolded crowns of tentacles.

C. dodecalophus, the only known representative of the genus, was found in the Magellan Straits at a depth of 245 fathoms.

Systematic position.—*Cephalodiscus* shows in the following points a remarkable agreement with the *Enteropneusta*.

1. The body falls into three sections (distinct even in the young bud), one preoral and two postoral. The preoral section, the so-called buccal shield, corresponds with the proboscis, the middle section with the collar, and the larger posterior section and the pedicle with the trunk of the *Enteropneusta*.

2. These sections correspond with special sections of the cœlom, an unpaired cœlom in the buccal shield, and two pairs of cœloms in the body proper. We recognise here the unpaired proboscidal cœlom and the paired collar and trunk cœloms of the *Enteropneusta*.

3. The pores of the cœlom of the buccal shield correspond with the proboscis pores of the *Enteropneusta* proper, which are also often two in number.

4. The pores of the pair of cœloms in the anterior body correspond with the collar-pores.

5. *Cephalodiscus* and the *Enteropneusta* have gill-slits, the former having one and the latter many pairs.

6. The anterior diverticulum of the buccal cavity corresponds with the proboscidal diverticulum of the *Enteropneusta*.

7. The central nervous system corresponds with the collar cord (which, however, in this case is not sunk below the skin) of the *Enteropneusta* and with its immediate continuation on to the base of the proboscis.

The differences existing between *Cephalodiscus* and the *Enteropneusta* may well be attributed, at least in part, to the tubicolous, half-sedentary manner of life of the former. These are: (1) the anterior position of the anus, and the consequent looped course of the alimentary canal; (2) the general crowding together of the most important external organs (apart from the pedicle or stalk) at the most anterior part of the body; (3) the presence of a tentacular crown, consisting of twelve feathered tentacles; (4) the presence of the pedicle or stalk; ¹ (5) the occurrence of asexual reproduction by means of gemmation; (6) the small number of gill-slits and genital organs; (7) the form of the body in general and especially that of the proboscis; (8) the absence of a blood vascular system.

II. *Rhabdopleura*.

This form, which was formerly classed with the *Bryozoa*,² is no doubt somewhat nearly related to *Cephalodiscus*, but is further removed than the latter from the *Enteropneusta*.

¹ An apparently homologous structure is, however, figured by Bateson on a young *Balanoglossus Kovalevskii*.

² In the first volume of this book, indeed, *Rhabdopleura* appears among the *Bryozoa*.

This animal forms colonies by gemmation. Each individual consists of a body and a contractile stalk, both of which are enclosed in a horny tube. This tube is supine at first but rises erect later. It is secreted in successive rings by the buccal shield. The tentacles can be protruded through the aperture of the tube,

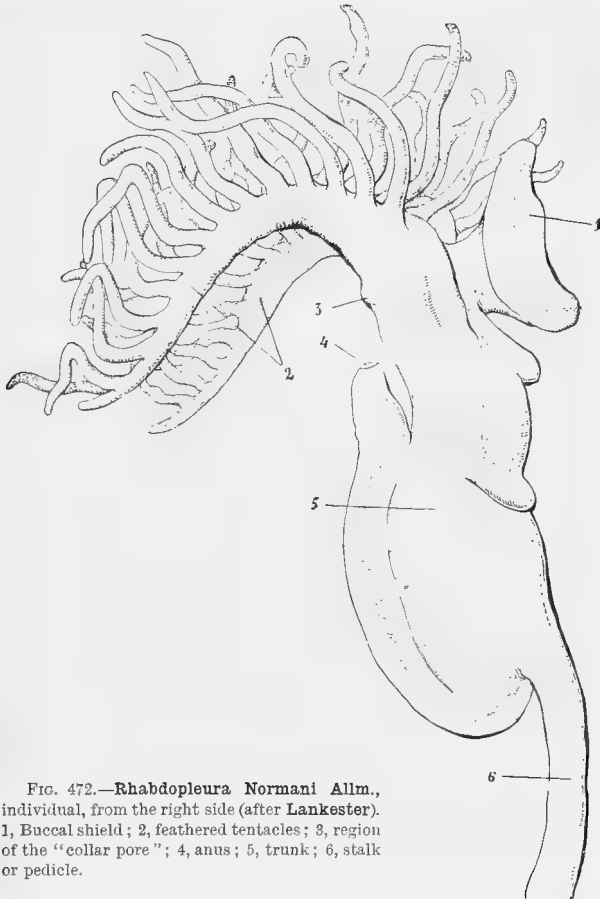

FIG. 472.—*Rhabdopleura Normani* Allm., individual, from the right side (after Lankester). 1, Buccal shield; 2, feathery tentacles; 3, region of the "collar pore"; 4, anus; 5, trunk; 6, stalk or pedicle.

the body being withdrawn again into the tube by means of the stalk. All these tubes are lateral branches of a creeping basal tube which spreads out and branches on the substratum, and appears to be divided into chambers by septa.

The stalks of the individuals enter this radical tube, and are continued in it as thin strands covered with cuticle, which in traversing it perforate the septa.

The axis of each individual stalk is formed by a strand of tissue

somewhat of the consistency of cartilage. Similar skeletal pieces support the tentacles and their branches.

Some insight into the chief anatomical features of the individuals will be gained from the figures (Figs. 472, 473). The principal differences between *Rhabdopleura* and *Cephalodiscus* are: (1) the gill-slits are wanting in the former; (2) there are only two feathered tentacles; (3) the proboscis pores, *i.e.* the pores of the coelom of the buccal shield, are wanting.

The genital organs are still imperfectly known. In some specimens a testicle tube, which runs longitudinally and asymmetrically along one side of the body, and bulges out the body wall, has been demonstrated: this tube opens out near the anus. *Rhabdopleura*, like *Cephalodiscus*, is a deep-sea form.

Further research is needed before we can establish the exact relationship of *Cephalodiscus* and *Rhabdopleura* to the *Bryozoa*.

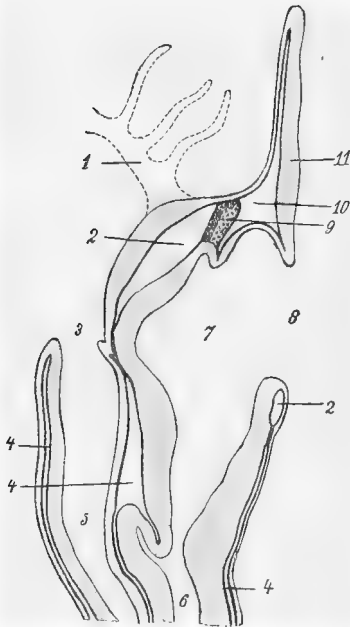

FIG. 473.—*Rhabdopleura Normani*, median longitudinal section, diagrammatic (after Fowler). 1, Tentacle of one side, indicated by dotted lines; 2, anterior paired coelom (collar coelom); 3, anus; 4, posterior paired or trunk coelom; 5, hind-gut; 6, mid-gut; 7, buccal cavity; 8, mouth; 9, anterior diverticulum of the buccal cavity (proboscidal diverticulum); 10, coelom of the buccal shield (proboscidal coelom); 11, buccal shield.

Literature.

- G. J. Allmann.** *On Rhabdopleura, a new form of Polyzoa, from deep-sea dredging in Shetland.* *Quart. Journ. Microsc. Sc.* Vol. IX. 1869.
- G. Herbert Fowler.** *The morphology of Rhabdopleura Normani Allm.* *Festschrift zum Siebenzigsten Geburtstag R. Leuckert's.* 1892.
- Sidney F. Harmer.** *Appendix to M'Intosh: Report on Cephalodiscus dodecalophus M'Intosh.* *Rep. Voy. of the "Challenger," Zool.* Vol. XX. 1887.
- E. R. Lankester.** *A contribution to the anatomy of Rhabdopleura.* *Quart. Journ. Microsc. Sc.* Vol. XXIV. 1884.
- W. C. M'Intosh.** *Report on Cephalodiscus dodecalophus M'Intosh, a new type of the Polyzoa, procured on the voyage of H.M.S. "Challenger."* *Rep. Voyage "Challenger," Zool.* Vol. XX. 1887.
- G. O. Sars.** *On Rhabdopleura mirabilis.* *Quart. Journ. Microsc. Sc.* Vol. XIV. 1874.

INDEX

Numbers in *Italics* give Systematic Position. Numbers in Black Type refer to Figures

- | | |
|------------------------------------------------------------------------------------------------------------------------------------------------------------------------------------------------------------------------------------------------------------------------------------------------------------------------------------------------------------------------------------------------------------------------------------------------------------------------------------------------------------------------------------------------------------------------------------------------------------------------------------------------------------------------------------------------------------------------------------------------------------------------------------------------------------------------------------------------------------------------------------------------------------------------------------------------------------------------------------------------------------------------------------------------------------------------------------------------------------------------------------------------------------------------------------------------------------------------------------------------------------------------------------------------------------------------------------------------------------------------------------------------------------------------------------------------------------------------------------------------------|-------------------------------------------------------------------------------------------------------------------------------------------------------------------------------------------------------------------------------------------------------------------------------------------------------------------------------------------------------------------------------------------------------------------------------------------------------------------------------------------------------------------------------------------------------------------------------------------------------------------------------------------------------------------------------------------------------------------------------------------------------------------------------------------------------------------------------------------------------------------------------------------------------------------------------------------------------------------------------------------------------------------------------------------------------------------------------------------------------------------------------------------------------------------------------------------------------------------------------------------------------------------------------------------------------------------------------------------------------------------------------------------------------------|
| <p>Amph. = Amphineura
 Ast. = Asteroidea
 Blast. = Blastoidea
 Crin. = Crinoidea
 Cyst. = Cystidea
 Echin. = Echinodermata
 Echinoid. = Echinoidea</p> <p><i>ABATUS cavernosus</i>, apical system, 324
 <i>Abranchia</i>, 12
 <i>Acanthaster</i>, 299
 ,, <i>echinaster</i>, 421
 ,, <i>Ellisii</i>, 421
 <i>Acanthochiton</i>, 165
 <i>Acanthodoris</i>, 13
 <i>Acanthology</i>, 387
 <i>Acanthotrochus mirabilis</i>, "wheel," 337
 <i>Acephala</i>, 14, 177
 <i>Acera</i>, 10
 <i>Aceste</i>, 293
 <i>Acetabula</i> (Moll.), 117; (Echinoid.), 390
 <i>Aciculidae</i>, 6
 <i>Acmaea</i> (= <i>Tectura</i>), 5
 <i>Acmaeidae</i>, 5
 <i>Acrocidaris</i>, 290
 <i>Acrocrinida</i>, 308
 <i>Acrocrinus</i>, 309
 <i>Actæon</i>, 110
 <i>Actæonidae</i>, 10
 <i>Actinocrinida</i>, 307
 <i>Actinocrinus</i>, 307
 ,, <i>proboscidalis</i>, apical system,
 329
 ,, <i>verneuillianus</i>, 423
 <i>Actinocucumis</i>, 338
 <i>Actinometra</i>, 313; food grooves, diagr.,
 366
 ,, <i>strota</i>, 365
 <i>Actinopoda</i>, 285; oral region, section, 428
 <i>Adambulacral ossicles</i>, 352; radii, 316
 <i>Adetes</i>, 293
 <i>Adradii</i>, 316</p> | <p>Ent. = Enteropneusta
 Gastr. = Gastropoda
 Hol. = Holothuroidea
 Lam. = Lamellibranchia
 Moll. = Mollusca
 Oph. = Ophiuroidea</p> <p><i>Eolidia</i>, 13
 <i>Eolidiidae</i>, 13
 <i>Eolis</i>, alimentary canal, 192
 ,, <i>rufibranchialis</i>, 12
 <i>Erope</i>, 293
 <i>Esthetes</i>, 166
 <i>Etheria</i>, 62
 <i>Agaricocrinus</i>, 307
 <i>Agassizia</i>, 293
 <i>Agassizocrinus</i>, 304
 <i>Agelacrinus</i>, 313
 ,, <i>cinnamatis</i>, 313
 <i>Aglossa</i>, 14, 177
 <i>Amalia</i>, 76
 <i>Ambitus</i>, 338
 <i>Amblypygus</i>, 345
 <i>Ambulacra</i>, 339
 <i>Ambulacral brush</i> (Echinoid.), 433; gills
 (Echinoid.), 433; ossicles, 352; radii,
 316
 <i>Ammonitidea</i>, 22
 <i>Amnion</i>, 523
 <i>Amœbocytes</i> (Moll.) 200; (Echin.), 415
 <i>Amphiaster</i>, 297
 <i>Amphidromus</i>, 160
 <i>Amphineura</i>, 2
 <i>Amphipeplea</i>, 8
 ,, <i>leuconensis</i>, 8
 <i>Amphisphyra</i>, 46
 <i>Amphisternal test</i>, 349
 <i>Amphiura</i>, 300
 ,, <i>magellanica</i>, 495
 ,, <i>squamata</i>, apical system, 327;
 stone canal, 422</p> |
|------------------------------------------------------------------------------------------------------------------------------------------------------------------------------------------------------------------------------------------------------------------------------------------------------------------------------------------------------------------------------------------------------------------------------------------------------------------------------------------------------------------------------------------------------------------------------------------------------------------------------------------------------------------------------------------------------------------------------------------------------------------------------------------------------------------------------------------------------------------------------------------------------------------------------------------------------------------------------------------------------------------------------------------------------------------------------------------------------------------------------------------------------------------------------------------------------------------------------------------------------------------------------------------------------------------------------------------------------------------------------------------------------------------------------------------------------------------------------------------------------|-------------------------------------------------------------------------------------------------------------------------------------------------------------------------------------------------------------------------------------------------------------------------------------------------------------------------------------------------------------------------------------------------------------------------------------------------------------------------------------------------------------------------------------------------------------------------------------------------------------------------------------------------------------------------------------------------------------------------------------------------------------------------------------------------------------------------------------------------------------------------------------------------------------------------------------------------------------------------------------------------------------------------------------------------------------------------------------------------------------------------------------------------------------------------------------------------------------------------------------------------------------------------------------------------------------------------------------------------------------------------------------------------------------|

- Amphiuridae*, 300
Amphoracrinus, 307
 Ampullæ, madreporic, 420
 ,, tentacle, 430
Ampullaria, 100
 ,, (*Lunistes*), *Boltemana*, shell, 161
 ,, (*Ceratodes*), *chiquitensis*, 161
 ,, *crocistoma*, 161
 ,, *Grœana*, 161
 ,, *purpurea*, 161
 ,, (*Ceratodes*), *rotula*, 161
 ,, *Srainsoni*, 161
Ampullarida, 6
Ananchytida, 293
Anapta, 466
Anaspida, 10
Anatina, 21
Anatinide, 21
 Anchylosis (Crin.), 378
Ancula, 13
Ancyloceras stage, 68
Ancylus, 8
Ankyroderma, 287
 Annulus, 126
Anochanus, 503
Anodonta, 17; circulation, 207; gills, 95; larva, 264; section, 221
 ,, *cygnæa*, 34
Anomia, 15; shell, 63
Anomiidae, 14
Antedon, 313; embryo and larva, 510, 534-543
Antedon incisa, 312; larva, apical system, 318
 ,, *phalangium*, young stage, 375
 ,, *rosaceus*, 378
 ,, *tuberculosa*, 297
Antedonidae, 373
Anthenea, 296
Anthencidae, 296
 Antispadix, 116
 Aorta, 198, 202
Apetala, 293
Apiocrinidae, 310
Apiocrinus, 310
Aplacophora, 3
Aplustridae, 110
Aplysia, 10, 78; nervous system, 140
Aplysiella, 181
Aplysiidae, 10
 Apophyses (Chiton), 39; (Echin.), 350
 Aptychi (Ceph.), 71
Arachnoides, 293
Arbacia, 290, 291
Arbaciidae, 290
Arca, 15
 ,, *barbatu*, eye, 175
 ,, *Noœ*, 206
Archæocularidae, 289
Archæocidaris (= *Echinocrinus*), 289
Archaster, 296
Archasterida, 296
Archiacia, 295
Archidoris, 13
Architeuthioglossa, 5
Arcidae, 15
 Arcus (Echinoid.), 400
 Argentea (Ceph.), 197
Argonauta, 24, 24; gonads, female, 230; nervous system, 148
 ,, *argo*, male, 243
Ariom, 8
 ,, *ater*, 9
Ariophanta, 8
Aristocystis, 313
 Aristotle, lantern of, 400-403
 Articulamentum, 39
Articulata, 309
Ascocystis, 313
Ascoglossa, 11
Asiphoniada, 44
Aspergyllum (*Brechites*), 21, 20
 ,, *dichotomum*, 66
Aspidobranchia, 4
Aspidochiron, 285; organisation, 477
Aspidodiadema, 290
Aspidodiademata, 290
Aspidosoma, 295
Astartiidae, 50
Asteracanthion glacialis, pedicellariæ, 395
 ,, *rubens*, madreporic plate, 421
 ,, " pedicellariæ, 395
Asterias, 299
 ,, *acutispina*, 506
 ,, *atlantica*, 506
 ,, *calamaria*, 506
 ,, *capensis*, 421
 ,, *microdiscus*, 506
 ,, *polyplax*, 421
 ,, *rubens*, 507
 ,, *spirabilis*, 503
 ,, *sticantha*, arm, 396
 ,, (*Stollasterias*), *volcellata*, arm, 396
 ,, *tenuispina*, 421
 ,, *vulgaris*, 507
Asteriida, 299
Asterina, 297
 ,, *gibbosa*, circular canal, etc., 425; ontogeny, 525-531
 ,, *Wega*, 506
Asterinidae, 297
Asterodiscus, 297
Asteroidea, 295-299; alimentary canal, etc., 484; arm, section, 411; optic cushion, section, 468; oral skeleton, 352; pedicellariæ, 395; stone canal, section, 421; water vascular system, 463
Asteropsis, 297
Asthenosoma, 290
 ,, *urens*, spine, 390; test, 472; viscera, 443
Astrochele, 301
Astroclon, 301

- Astrocnida*, 301
Astrocninida, 315
Astrocrinus, 315
 " *Bennici*, 315
Astrogomphus, 301
Astrogonium, 296
Astropecten aurantiacus, branchial skeleton, 351
Astropectinidae, 296
Astrophytida, 301
Astrophyton, 301
 " *Lincki*, 301
Astroporpa, 301
Astropyga, 290
Astroschema, 301
Astrotoma, 301
Atelecrinus, 313
Atelestocrinus, 304
Atlantu, 90, 109
 " *Peronii*, 7
Atlantidae, 6
Atys, 46
Auricula, 350, 402
Auricularia, 506, 507, 508, 511, 512, 513, 514
 " of *Synapta*, 512, 514
Auriculidae, 8
Avicula, 17
Aviculidae, 17
 Axial organ (= ovoid gland), 437, 445, 446
Azygobranchia, 5

 BACULITES stage, 68
Balanocrinus, 313
Balanoglossus, 562
 " *canadensis*, 565
 " *Kovalevskii*, 562; branchial skeleton, 580
 " *Kupfferi*, 571
 " *Merschkovskii*, 571
Barrandeocrinidae, 309
Barrandeocrinus, 309
 Barrel-shaped larvæ (Echin.), 514
Barycrinus, 304
 Basals, 318
 Basibrachial cartilage (Ceph.), 126
 Basipterygial cartilage (Ceph.), 127
Basonmotophora, 8
Bathybiaster, 296
Bathycrinidae, 304
Bathycrinus Aldrichianus, axial canals, 378
Bathydoris, 13
Batocrinus, 307
 " *pyriformis*, 307
 Baur's vesicles, 467
Belemnites, 24; shell section, 69
Belemnitidae, 24
Belemnocrinus, 304
Belemnoteuthis, 24
Bellerophonitidae, 5
Belosepia, 24
 " shell section, 69

Benthaster, 298
Benthodytes, 285
Berghia, 13
Bipinnaria larva, 507; dorsal aspect, 528
Bivalva, 14
Bivium, 325, 347, 407
Blastoidea, 314
Blanueria, 109
 Bojanus, organ of, 215, 221
Bornellidae, 13
Bothriocidaris, 289
Bothriocidaroida, 289
Botyocrinus, 304
Bourgueticrinidae, 310
Bourgueticrinus, 311
Brachiolaria larva, 508
Branchiopneusta, 78
Brechites (Aspergillum), 21, 20
Brisinga, 299
Brisingida, 299
Brissopsis, 293
Brissus, 293
 Buccal shields (Oph.), 336; plates (Echinoid.), 344
Buccinidae, 6
Buccinum, 160
Bulininus, 8
Bulimulidae, 8, 9
Bulinus, 8
 " *oblongus*, 75
 " *perversus*, 160
Bulla, 10
 " *hydatidis*, nervous system, 140
Bullidae, 10
Bulloidea (Cephalaspidae), 110
Bursæ (Oph.), 494
Byssus, 112-115, 114

CALAMOCRINUS, 310
Calamus, 69
 Calcareous cells, 190
Calceocrinus, 304
Calliaster, 296
Cullicrinus, 309
Callocystis, 332
 Callum, 64
Calymne, 293
Calyptrea, 108
Calyptreidae, 6
Calyx, 319
Camerata, 306
Canaliculata, 310
Cancellariidae, 6
Cypriinidae, 18
Capulidae, 6
Cardiacea, 18
Cardiaster, 293
Cardiidae, 18
Cardita, 17
Carditidae, 17
Cardium, 18
 " *edule*, nervous system, 144; tuberculatum, 18

- Carina (Echinoid.), 401
Carinaria, 90, 109
Carolia, 63
Caryocrinus, 307
Caryocrinus, 313
 " *ornatus*, apical capsule, 332
Cassidaria tyrrhena, 163
Cassidiida, 6
Cassiduloidea, 293
Cassidulus, 293
 " *pacificus*, perisome, 348
Cassis sulcosa, 6
Catillocrinus, 304
Catopygus, 293
Caulina, 287
Cavolinia, 11
 " *tridentata*, 91
Cavoliniida, 11; diagram, 80
 Centrodorsal, 375
Centrostephanus longispinus, pedicellariæ, 397
Cephalaspidae (*Bulloidea*), 10
 Cephalic cartilage (Gastr.), 126; cone, 104; disc, 103
Cephalodiscus dodecalophus, 596; sections, 597, 598
Cephalophora, 3, 177
Cephalopoda, 21-25; eye, development, 171; embryo, 116; gonad, female, 230; male, 231; ink-bag, 197; heart, 199; retinal cells, 173
 Cerata, 98
Ceratodes (see *Ampullaria*), 161
Cerithiida, 6
Cidaris, 290; spine of, 389
 " *canaliculata*, 502
 " *hystrix*, peristome, 344
 " *membranipora*, 502
 " *nutri*, 502
 " *papillata*, oral area, 345
 " *tribuloides*, surface of test, 389
Cidaroida, 290; apophyses, 350
Cionella, 75
Cirrhoteuthida, 24
Cirrhoteuthis, 54; shell of, 127
Cirrobranchia, 12
Chataster, 298
Chætoderma, 3, 88
Chætodermatida, 3
Chætodermatina, 3
Chætodermida, 3
Chama, 18
Chamacca, 51
 Chambered sinus, 446
Chamida, 18
Chenopida, 6
Chiasma nervorum brachialium (Crin.), 377, 460
 Chiastoneury, 135, 136, 137
Chirodota, 288
 " *rotifera*, 402
Chiroteuthis, 24
Chiton, 3, 2; spine, 40; sections, 40, 212;
- ctenidium, 85, 87; heart, 199; eye, section, 167; ovary, 227; nephridial and genital systems, 217
Chiton cajetanus, 165
 " *lævis*, 88, 165
 " *Pallasii*, 82
 " *Pollii*, 165; development, 249
 " *rubicundus*, 129
 " *sinulus*, 165; nervous system, 130
Chitonellus, 3; section, 41
Chitonida, 2; gills, 87
Chlamys, 17
Choanomphalus Maucki, 160
Choristes, 108
 Chromatophores, 53
Chromodoris, 13
Cionella, 75
Cladohepatica, 13
Clausilia, 8
Clavagella, 21
Clavagellida, 21
Clavulæ (Echinoid.), 391
Cleiocrius, 309
Cleodora, 30
Clio, 11
 " *striata*, anatomy, 190
 Clione, 90
Clionida, 11
Clionopsida, 11
Clionopsis, 90
Clypeaster, 291, 292
 " *rosaceus*, apical system, 322
Clypeastrida, 291
Clypeastroida, 291; system of plates, 346
Clypeus, 293
Cnemidaster, 298
 " *Wyvilli*, 297
Codaster, 315; ambulacrum section, 383
 " *bilobatus*, 314
Codasterida, 315
Codechinus, 290
Cœlopleurus, 290
Collyrites, 283
 " *elliptica*, apical system, 325
Collyritida, 293
Colochirus, 287
 " *cucumis*, calcareous body, 337
Colombellinida, 6
 Columella, 123
 Columellar muscle, 120-123
 Columna (Crin.), 373
 Columnals, 373
 Columnar layer of shell (Moll.), 57
Comatulida, 313
 Conchyolin, 26, 57
Conida, 6
Conoclypeus, 291
Coralliophila, 183
Coralliophilhida, 183
Corbicula, 17
Corbis, 93
Corbula, 19

- Corethraster*, 298
Corium (Moll.), 39; (Echin.), 414
Corona, 339
Coronaster, 299
Corpus epitheliale, 171
Corylocrinus, 332
Coryptella, 13
Costals (Crin.), 371
Cranchia, 24
Crassatella, 49
Crassatellidae, 17
Crenella, 115
Crepidulidae, 138
Cribrella, 299
 " *secradiatoria*, 506
Crinoidea, 302-316; arm, 372; arm, section, 413; ovarian pinnule, section, 500
Crioceras stage, 68
Crista acustica, 169
Cromyocrinus, 304
Crossaster, 298
Crotalocrinidae, 308
Crotalocrinus, 308
 " *pulcher*, 373
 " *rugosus*, arm disc, 372
Cryptoblastus, 315
Cryptochiton, 41
Cryptodon Moseleyi, 50
Cryptoschisma, 315
Cryptozonia, 297
Crystalline stylet, 191
Ctenidium, 84, 85
Ctenodiscus, 296
 " *procurator*, 296
Ctenopidae, 102
Cucumaria, 287
 " *crocea*, 502
 " *crucifera*, cruciform body, 337
 " *doliolum*, section, 517
 " *frondosa*, 488
 " *Lacazii*, 464
 " *laevigata*, 502
 " *longipeda*, "stool," 337
 " *minuta*, 502
 " *planci*, 287
Culcita, 297
Cultellus, 19
Cupressocrinus, 304
Cuspidaria, 21
Cuspidaridae, 21
Cuttlefish (= *Cephalopoda*), 21
Cuvierian organs (Hol.), 488
Cyathocrinidae, 304
Cyathocrinus, 304; apical system, 329
 " *longimanus*, 304, 364
Cyclus, 81
 " *cornea*, development, 262, 263
Cyclophoridae, 5
Cyclophorus, 100
Cyclostoma, 100
 " *elegans*, nervous system, 139;
 " *radula*, 182
Cyclostomidae, 6
Cylichna, 46
Cymbulia, 11; larva, 257
Cymbulidae, 11
Cymbulioopsis, 11
Cyphosoma, 290
Cyphosomatidae, 290
Cypraea, 5
Cypraeidae, 5
Cyrena, 17
Cyrenidae, 17
Cyrtoceras group, 68
Cystechinus, 293
 " *vesica*, gonads, 499
Cystidea, 313
Cystoblastus, 313
 " *Leuchtenbergi*, 312; apical side, 332
Cystocidaris (= *Echinocystites*), 289
Cystocidaroida, 289
Cystocrinoidea, 313
Cystoid stage, 544
Cytherea (*Meretrici*), 18
 " *chione*, shell, 63
DARDEBARDIA (*Helicophanta*), 9
 " *brevipes*, 9
 " *rufa*, intestine, section, 39; nephridia, 220;
 " *pallial* organs, 76, 77
 " *saulcyi*, 76
Decadocrinidae, 304
Decadocrinus, 304
Decapoda, 24
Deima, 285
Deimatidae, 285
Delphinulidae, 170
Deltoid plates (Blast.), 331; (Crin.), 364
Dendrochirota, 287
Dendrocrinidae, 304
Dendrocrinus, 304
Dendronotidae, 13
Dentalium, 13, 33; shell, 59, 156
 " *entale*, 113, 159; alimentary canal, 193; larva, 258; ontogeny of, 258
Dermatobranchus, 48
Devibranchaea, 11
Dextral twist (Gastr.), 56, 60, 160
Diadema, 290
 " *setosum*, 392; compound eye, 469
Diadematae, 290
Diadematoidea, 290
 " *apophyses*, 350
Dialyneurous nervous system (Gastr.), 138
Diaphragm (Ceph.), 127; cartilage, 127
Diavula, 13
Dibranchia, 24; eye development, 171;
 " *musculature*, 127; shells, sections, 69
Diceras, 18
Dichocrinus, 308
Dicyclic base (Crin.), 328
Dicyclic, 304

- Diffuse liver (Gastr.), 192
Dignopora, 8
Dimerocrinus, 367
Dimyaria, 14, 124; shell, 63
Diolocardia, 4, 30
Dipleurula larva, 546
Diplopodia, 290
Discoloris, 13
Discoidea, 291
Distichals (Crin.), 371
Docoglossa, 5
Dolabella, 10
Doliidae, 6
Dolium, 102
Donacida, 18
Donax, 18
Dondersia, 3
 ,, *batyulensis*, 251
 ,, *flavens*, 184
Dondersiidae, 3
Dorididae cryptobranchiata, 13
 ,, *phanerobranchiata*, 13
Doridiida, 10
Doridium, 46
Doridopsidae, 13
Doridopsis, 214
Doris, respiratory and circulatory organs, 98
Dorocidaris papillata, 388
Dorsal axis (Blast.), 331; cartilage (Ceph.), 127
Dorycrinus, 307
Dosidicus, 69
Dotinidae, 13
Dreissensia polymorpha, gills, 94
Dreissensiiida, 17
Dysaster, 293
Dytaster, 296
- ECHINASTER**, 299
 ,, *sepositus*, 483
Echinasteridae, 299
Echinidae, 290
Echinobrissus, 293
Echinocardium, 293
 ,, *flavescens*, 398
Echinocardaris, 290
 ,, *nigra*, ambulacrum, 393
 ,, *pustulosa*, 291
Echinoconus, 293
Echinocorys, 293
Echinocrepis, 295
Echinocrinus (*Archæocidaris*), 289
Echinocyamus, 291
 ,, *pusillus*, gastrula, 520; Pluteus larva and young, 520-524; tentacle, section, 464
Echinocystis (*Cystocidaris*), 289
Echinodermata, alimentary canal, 475; representatives of principal divisions, 316
Echinodiscus, 293
Echinodiscus biforis, 424
Echinocercinus, 313
 ,, *armatus*, 333
Echinoidea, 288-295; endocyclic, 322; exocyclic, 322; larva, 509; organisation of regular, 419; pedicellariæ, 397; Pluteus, 520-524; radial region, section, 410
Echinolampas, 293
Echinometra, 290
Echinometridæ, 290
Echinoneidæ, 293
Echinoneus, 293
Echinopsis, 290
Echinospatagus, 293
Echinosphæra, 386
Echinothrice, 290
Echinothuria, 290
Echinothuridae, 290
Echinus, 290; apical system, 318; masticatory apparatus, 401
 ,, *acutus*, 398
 ,, *melø*, 398
Edriaster, 387
Elvocrinus, 315
Elasipoda, 285
Eledone, 24
 ,, *moschata*, secondary body cavity, diagram, 214
Eleutheroerinus, 315
 ,, *Cassedayi*, apical side, 331; oral side, 383
Elyidia, 285
 ,, *glacialis*, 467
Elpidiidae, 285
Elysiadæ, 12
Emarginula, 4; shell, 59, 156
Embryonic cone, 257
Enallocrinus, 308
Encope, 293
 ,, *Valenciennesi*, system of plates, 346
Encrinus, 304; axial canals, 378
 ,, *ulviformis*, 304
Endoceratidæ, 67
Endogastric coil (Gastr.), 67, 68, 159
Enoploleuthis, 127; musculature, 127
Ensis, 19
Enteropneusta, 561-596; branchial region, 567, 580; larvæ, 586-590, 594; proboscis, section, 583
Entocolax Ludwigii, 246, 247
Entoconcha, 183
 ,, *mirabilis*, 247, 248
Entovalva, 229
Eolampas, 293
Eolis Drummondii, 183
Epineural canal, 449
Epipodial lobes (Ceph.), 38
Epipodium, 106
Episternum, 349
Epistroma, 349
Eretmocrinus, 307

- Erisocrinus*, 372
Erycina, 17
Erycinida, 17
Eusteroidea, 296
Eucalyptocrinida, 309
Eucalyptocrinus, 309
Euchelonicus, 308
Eucystoidea, 313
Eudocrinus, 313
Euechinoida, 290
 „ *diadematoidea*, 469
Eulamellibranchia, 17; gills, 92
Eulina, 183
Eulinida, 6
Eumargrita, 108
Eupachyricrus, 372
Euplocamus, 13
Euryale, 301
Euryale, 301
 Euthyneurous condition (Gastr.), 133, 158
 Exogastric coil (Gastr.), 159
Erygyra, 62
Estracrinus, 313

FACELLINA, 13
Falces (Echinoid.), 400
Farina, 293
Fascioles (semites), 349
Ferdina, 326
 Ferment cells, 190
Fibularia, 291
Fibulariidae, 291
Filibranchia, 14; gills, 92
 Fins (Ceph.), 54; (Oph.), 392
Fiona, 13
Firola coronata, 7
Firoloides, 90
Fissurella, 4; ctenidium, 85; shell, 59.
 156
Fissurellida, 4
Fistulana, 64
Fistulata, 303
Flabellina, 13
 Fleming's cells, 162
 Floscelle, 317
 Foramen basale (Echinoid.), 400; exter-
 num (Echinoid.), 400
Forbesocrinus, 309; dorsal cup, 369
 Fork pieces (Blast.), 331; (Echinoid.), 400,
 401
 Funnel (Ceph. = siphon), 265; ciliated
 (Echin.), 437
Fusidae, 6

GALATEA, 17
Galeomma, 17
Galeopygus, 322
Galvina, 13
Ganeria, 297
Gasteropteridae, 10
Gasteropteron Meckelii, 10; genital organs,
 233
Gastrochaena, 65

Gastrocoma, 304
Gastropoda, 3-13; hypothetical primitive,
 150, 151; racial form, 159; sections,
 47, 110; shell, 59, 156
Genicopatagus, 293
 Genital plates (Echinoid.), 321; stolon
 (Crin.), 446
Gilbertocrinus (= *Ollacrinus*), 306
 „ *tuberculosis*, system of
 plates, 367
 Gills, adaptive, 97; anal, 97
Gissocrinus, 304
Gladius, 69
Glandiceps, 562
 „ *Hacksii*, 570
 „ *talabotti*, 570
Glandina, 104
 Glands—
 „ albuminous (Gastr.), 232
 „ anal (Gastr.), 177
 „ blood-making (Ceph.), 97
 „ byssus (Lam.), 112
 „ calcareous (Gastr.), 42
 „ digestive, 190-195
 „ digitate (Gastr.), 237
 „ goblet (Echin.), 415
 „ granular (Echin.), 415
 „ hermaphrodite (Gastr.), 235
 „ hypobranchial, 101
 „ labial (Gastr.), 111, 178
 „ Leiblein's (Gastr.), 188
 „ lime (Gastr.), 99
 „ lymph (= ovoid) (Echin.), 445
 „ mucous (Gastr.), 42
 „ nephridial (Gastr.), 219
 „ nidamental, 233, 241
 „ oviduct (Ceph.), 241
 „ ovoid (= lymph) (Echin.), 437,
 444
 „ pedal, 106, 111
 „ pericardial (Keber's organ), 214,
 215
 „ pigment (Gastr.), 42
 „ poison (Gastr.), 188
 „ purple (Gastr.), 74, 101
 „ prostatic (Gastr.), 233
 „ salivary, 184-187
 „ shell (Gastr.), 237; larval, 253
 „ slime (Gastr.), 237
 „ stalk (Echin.), 399
 „ sugar (Amph.), 187
 Glandular pedicellariæ (Echin.), 398
Glaucus, 13
Gleba, 11
Glochidium, larva, 264; *parasiticum*, 263
 Glomerulus (Ent.), 582
Glossophora, 177
Glycymerida, 19
Glycymeris, 19
Glyphocyphus, 290
Glyptaster, 306
Glyptasteridae, 306
Glyptocrinus, 307

- Glyptosphaerites*, 313
Goniaster, 296
Goniodoris, 13
Goniatopygus, 290
Gorgonocephalus, 301
Granatoblustidae, 315
Granatocrinus, 315
 " *Norwadi*, 314
Graphocrinus, 304
Gryphaa, 62
Gymnasteria, 297
 " *carinifera*, pedicellariae, 395
Gymnasteriada, 297
Gymnosomata (Pteropoda), 11
Gyrocerus, group, 68
- HÆMOCYANINE**, 200
Hæmoglobin, 200
Hæmolymph, 200
Haliacea, 6
Haliotidae, 4
Haliotis, gills, 90, 121; shell, 59, 156
Haliopsis, 90
Hamites, stage, 68
Haplocrinus, 303
 " *mespiliformis*, 303, 334
Harpidae, 6
 Hectocotylisation, 118, 242
Helcion, 108
Helicaster, 299
Helicasteridae, 299
Helicarian, 8
Helicidae, 8
Helicinidae, 5
Helicophanta (Daudebardia), 45
Helictes, 160
Helix, 8; anatomy, 236; alimentary canal, 186; circulatory system, 204; sections, 99, 100, 104, 181; shell, 123
 " *aspersa*, 75
 " *Gibbsreghtii*, 183
 " *pomatia*, 9; nervous system, 142; shell, 60
 " *Waltoni*, 258
Hemiasiter, 293
 " *cavernosus*, 480
Hemicidaris, 299
Hemicidaridae, 290
Hemicosmites, 332
Hemieuryale, 300
Hemipatagus, 293
Hemipholis, 327
 " *cardifera*, disc section, 435
Hemipneustes, 293
Hermæida, 12
Hera, 13
Herpetocrinus, 304
Heteroblastus, 315
Heterocrinus, 304
Heterolampas, 293
Heteromyaria, 15, 124
Heteropoda, 6
- Hexacrinidae*, 308
Hexacrinus, 308
 Hinge (Lam.), 61
Hipponycidae, 6
Hipponyx, 108
Hippopus, 18
Hippurites (Rudistes), 62
Hippuritidae, 18
Histiolenchitis, 54
Holaster, 293
 " *suborbicularis*, apical system, 324
Holactypoida, 290
Holactypus, 290
 " *depressus*, apical system, 322
Holohepatica, 12
Holopida, 304
Holopus Rangyi, 305
Holostomata, 44
Holothuria, 285, 316
 " *impatiens*, 464
 " *Murrayi*, "stool," 337
 " *tubulosa*, organisation, 451
Holothuriadae, 285-288; calcareous bodies, 337; ciliated rings, 515; diagram, section, 407; œsophagus of dendrochirote, 404; oral region of actinopod, 428; organisation of aspidochirotan, 477; radial region, section, 409; stone canal, etc. 418
Homalonyx, 45
Homocrinus, 304
 Hood (Ceph.), 37
 Hook sacs (Gastr.), 180
Hyalina, 76
Hyocrinus, 304
Hydrocrinus, 372
Hydrobiida, 6
 Hydrocœl, 511
Hydrocœnida, 5
 Hydrospire (Blast.), 382
Hymenaster, 298
 " *calatus*, 298
 " *nobilis*, 298
 " *pellucidus*, apical side, 503
Hyocrinida, 304
Hyocrinus Bethellianus, 305, 335
Hypaluster, 296
Hypobranchiaca, 98
Hypocrinus, 304
Hypoplax, 64
- IANTHINA**, 108
Ianthinidae, 184
Ichthyocrinida, 309
Ichthyocrinoida, 308
Ichthyocrinus, 309
Idalia, 13
Idiosepium, 24
Ilyaster, 296
Ilyodæmon, 418
Inadunata, 303
 " *fistulata*, 303, 363

- Imbricula larviformis*, 303, 363
 Infrabasals, 318
 Ink-bag (Ceph.), 177, 196; morphology, 197
Inoceramus, 17
Integripallista, shell, 63
 Interambulacra, 339
 Interambulacral radii, 316
 Interdistichals, 363
 Internodes, 374
 Interpalms, 363
 Interradii, 316
 Intersecundibrachs, 363
 Intertibrachs, 363
Iocrinus, 304
Irpa, 418
Irrigulares, 315
Isaster, 293
Isomyaria, 124

 JANUS, 13; nervous system, 141
Jouannetia, 19
 „ *Cumingii*, 19
Juglandocrinus, 332

 KEBER'S organ (red-brown organ), 215
Kellya, 17
Kentadoris, 13
Kleinia brzonica, apical system, 342
Kolya, 285
 K llicker's canals (Ceph.), 168

 LABIAL palps (Gastr.), 104; (Lam.), 105
Labidiaster, 299
Labidolomas, 491
 Labrum (Echinoid.), 348
Lacuna, 108
Lactungone, 285
Laganida, 291
Laganum, 291
 „ *depressum*, apical system, 323
Lamellarida, 6
Lamellibranchiata, 14-21; byssus, 114; diagrams, 50; heart, 199; shell, 59, 62, 156
 Lancelet plates (Blast.), 380
Lanistes (see *Ampullaria*), 161
Larviformia, 303
Lasaea, 17
 Lateral organs (Gastr.), 165
Lecythocrinus, 304
Leda, 14
Leptida, 5
Leptocentrus, 289
Leptomenia, 13
 „ *hystrix*, 132
Leptocochus, 183
Lepton, 17
Leptoplychaster korymbosus, 503
Leskiida, 295
Leuconia, 109
 Ligament (Lam.), 61
Lima, 105

Limacidae, 8
Limacina helicina, anatomy, 189
 „ *Lesuerii*, 11
 „ *retroversa*, 160
Limaculida, 11; diagram, 80
Limapontida, 12
Limas, 8; vascular system, 204
Limida, 53
Limnæa, 8
 „ *abyssicola*, 100
 „ *stagnalis*, genital organs, 235
Limnæidae, 8
Linckia, 298
 „ *multifora*, 244
Linckiiida, 298
Linthia, 293
Lipocephala, 101, 177
Lithodomus, 15
Litiopida, 108
Littorinida, 6
Lituities, 68
Lobiger, 12
Loligo, 24; gonad, male, 231; nervous system, 148
 „ *vulgaris*, 23
Loligopsis, 24; shell, section, 69
Lomaxulida, 13
 Lov n, law of, 341-344
Loxania, 293
Lucina Pennsylvanica, shell, 63
Lucinacea, 50
Lucinidae, 17
Luidia, 296
 Lunula, 341
Lutrarida, 51
Lutariida, 19
Lyonsia Norvegica, 51
Lyonsiida, 21

 MACTRA, 18
Mactridae, 18
 Macula, 168
 „ *acustica*, 168
 Madreporite, 321, 416-423
Magilus, 183
Malletia, 49
Malleus, 17
 Mantle, 26; cavity, 26
Margarita Groenlandica, 4
Margaritana (Unio) Margaritifera, 17
Margaraster, 297
Marginalida, 6
Mariacrinus, 307
Marionia, 13
Marseniadae, 225
Marsupia, 347
Marsupiocrinus, 308
 „ *calatus*, tegmen calycis, 369
Marsupites, 304
 „ *ornatus*, apical system, 329
Martesia, 65
 Megalæsthetes, 166

- Megistoacrinus*, 307
Melampus, 109
Melenida, 6
Melagrina, 17
 „ *margaritifera*, 17
Melibe, 13
Mellita, 293
 „ *testudinata*, 293
Melocrinidae, 307
Melocrinus, 307
 „ *typus*, 307
Melonites, 289
 „ *multiopora*, apical system, 340
Melonitidae, 289
Membrana limitans, 173
Mrona ventricosa, apical system, 323
Mercetia (*Cytherea*), 18
 Meridosternal test, 349
Mesites, 313; ambulacrum, section, 386
Mesoblastus, 315
Mesodesmatida, 18
Mesoplax, 64
Mesorchium, 230
Metablastus, 315
Metacrinus, 313
 „ *angulatus*, tegmen calycis, 365
 „ *Murrayi*, 311
Metaplex, 64
Metapodium, 106
Metrodora, 298
Micraesthetes, 166
Micraster, 293
 „ *coranguinum*, apical system, 324
Millericrinus, 310
Milneria, 49
Minaster, 296
Mithrodia, 299
Mitra, 101
Mitrida, 6
Mudiola, 15
Mudiolaria, 15
Moira, 503
 Mollusc, hypothetical primitive, 26
Molpulia, 287
 „ *chilensis*, 488
Molpadiidae, 287
 Monocyclic base (*Crin.*), 328
Monocyclica, 303
Monopnopora, 8
Monomyaria, 14, 124; shell, 64
Monopleurida, 18
Monotocardia, 5; diagram, 31; gills, 90
Montacuta, 93
Muelleria (*Moll.*), 124
Muelleriaca, 124
Muelleridae, 124
Mülleria (*Echin.*), 285
Murex, 101
 „ *truncatus*, alimentary canal, 189
Muricida, 6
Mutela, 17
Mutlina, 51
Mya, 19
Myacca, 18
Myala, 64
Myiidae, 19
Myochama, 51
Myopsida, 24
Myriolochus, 288
 „ *Rinkii*, 246
Mytilido, 15
Mytilus edulis, 15
Myxaster, 298
 NACELLA, 108
 Nacreous layer of shell, 57
Narica, 108
Naricida, 107
Natantia, 10
Natica Josephina, 107; swelling of foot, 119
Naticida, 6
Nautiloidea, 22
Nautilus, 22; eye, 169; diagram, 37; gonads, 230; nervous system, 145, 146; pallial complex, 82; tentacles, 117
 „ *Pompilius*, 22
Nautilus group, 68
Nectria, 296
 Needham's (spermatophoral) pouch, 238
Necrinoida, 303
Nemomenia, 3
Nemouida, 3
Nemouina, 3
Nephropneusta, 78
Neptunia contraria, 160
Neritacea, 4
Neritida, 5
Neritina, 5
Neritopsida, 5
Notæum, 10
Notarchus, 10
 „ *punctatus*, nervous system, 141
Notaspida, 10
Notobranchia, 90
Notobranchiida, 11
 Nuchal plate, 126
Nucleoblastida, 315
Nucula, 14; ctenidia, 85
 „ *nuculus*, 14
Nuculida, 14
Nulibranchia, 12
 OCTOPODA, 24
Octopulida, 24
Octopus, 24; anatomy, 147; nervous system, 148
 „ *vulgaris*, 25; gonad, female, 231; male, 239
 Ocular plates (*Echinoid.*), 321; (*Ast.*) 354
 Odontoblasts, 183
 Odontophore, 336
Oigopsida, 24
Oligopygus, 293
Oliva, 30

- Olivula*, 6
Ollucrinus (see *Gilbertocrinus*)
Ommastrephes, 24; gonad, female, 230;
 shell, section, 69
Ommatophore, 102
Ommatostrephes, 24; nervous system, 148
Oncidiella, 46
Oncidiida, 8
Oncidium, 44, 104
 .. *celticum*, genital organs, 235;
 larva, 256
Onciophanta mutabilis, rod, 237
Onychoteuthis, 24
Operculum, 31
Ophiacantha, 300
 .. *marsupialis*, 495; *vivipara*,
 495
Ophiactis, 300
 .. *Mülleri*, 506
 .. *poa*, 300
 .. *Savigny*, 506
 .. *virens*, 498; disc, section, 426
Ophiarachna incrassata, vertebral ossicles,
 356
Ophiaster Germani, 421
Ophioceramis, 327
Ophiocnida, 300
 .. *sexradia*, 506
Ophiocoma, 300
 .. *pumila*, 506
 .. *Valencia*, 506;
Ophiocreas, 301
Ophioderma (= *Ophiura*), 495
Ophiodiaster, 298
 .. *diplax*, regeneration of arms,
 505
Ophioglypha, 300; bursa, 495, 496; disc,
 section, 497
 .. *albida*, stomach, 494
 .. *hecaetis*, 495
 .. *lacertosa*, ovary, section, 497
Ophioglyphidae, 300
Ophiohelus umbella, arm joint, 357
Ophiomastis, 327
Ophiomitra exigua, 327
Ophiomusium, 300
 .. *validum*, apical system, 327
Ophiomyxa, 300
 .. *vivipara*, 495
Ophiomyxide, 300
Ophiomeris, 422
Ophioplacus, 422
Ophiopleron elegans, brachial joints, 391
Ophiopya longispinus, oral skeleton, 359
Ophiopyrgus, 327
Ophiothela dividua, 506
 .. *isidicola*, 506
Ophiotholia, 392
Ophiothrix, 300
 .. *fragilis*, ambulacral tentacle,
 section, 466; nervous sys-
 tem, 456
Ophiozona, 300
- Ophiura*, 300
Ophiura, 300
Ophiuroidea, 299-301; arm, section, 412;
 arm, joint, 357; disc, section, 486;
 Pluteus, 533; nervous system, 456;
 ring sinus, 496
Opisthobranchia, 10, 33; heart, 199
Opisthopneumonia, 76
Oral angle plates, 358
 .. lobes (Lam.), 105
Orocystis Helmackeri, 313
Orophucrinus, 315
 .. *stelliformis*, 314
Orphmurgus, 418
Orthoceras group, 68
Orthopsis, 299
Oscavivus, 10
Osphradium, 84, 162-164
Ostracoteuthis, shell, section, 69
Ostrea, 17
 .. *edulis*, anatomy, 16
Ostreidae, 17
Owenia, 24
Oxygyrus, 108
Oxynoe, 12
Oxynoidea, 12
- PALÆASTER*, 295
Palæasteroidea, 295
Palæarchinoidea, 288
Palæarchinus, 289
 .. *elegans*, 289
Palæobrius, 293
Palæocoma, 295
Palæocrinoidea, 303
Palæopneustes, 293
 .. *Murrayi*, 294
Palæostoma, 295
Palæotropus, 429
Pallial cavity, 26; line, 64, 124; sinus,
 64, 124
Palliata (= *Tectibranchia*), 46
Pallium, 26
Palmars (Crin.), 371
Palmipes, 297
Paludina, ctenidium, 85
 .. *vivipara*, circulatory system,
 203; development, 252, 254,
 255
Paludinida, 5
Pancreas (Ceph.), 196
Pandorida, 21
Pannychia, 235
Papulae, 439
Paractinopoda, 288
Paramenia impeza, 216
 .. *pallifera*, 184
Parameniidae, 3
Parapodia, 106
Parachaster, 296
Parasalenia, 290
Parasica (*Tremoctopus*) *catenulata*, 230
Parelpidia, 418

- Parmophorus* (*Scutum*), 5
Patella, 72; nephridia, 218; nervous system, 138; section, 188
 vulgata, 4
Patellida, 5
Patinella, 108
Paxillæ, 391, 503
Pecten, 17; eye, 174
 Jacobeus, 16
Pectinibranchia, 5
Pectinidæ, 16
Pectinura, 300
Pectunculus, 15; eye, 175
Pedicellariæ, 393-399
Pedicellaster, 299
Pedicellasterida, 299
Pedina, 290
Pedipes, 109
Pelagothuria natatrix, 285, 286
Pelagothuridæ, 285
Pelanechinus, 290
Pelecypoda, 14
Pelmatozoa, 302-315
Peltastes, 290
Peltella palliolum, 9
Peltidæ, 10
Pen (Ceph.), 69
Peneagone, 285
Pentaceros, 297
 turritus, oral skeleton, 473
Pentacerotidæ, 296
Pentacrinidæ, 313
Pentacrinus, 313
 decorus, 377; calyx, section, 382
Pentactæa, larva, 548
Pentactula, 516
Pentagonaster, 296
Pentagonasteridæ, 296
Pentephyllum, 315
Pentremites, 315, 314; anubulacrum, section, 382; apical system, 330; organisation, 380
Pentremitidæ, 315
Pentremitidæ, 315
Perclis, 11
Periechocrinus, 307
Periostracum, 58
Periscoechinoidea, 289
Peristome, 339
Perna, 17
 Ephippium, shell, 64
Peronella orbicularis, 424
Peronia (Moll.), 45; (Ech.), 290
Perradii, 316
Petalodium, 347
Petricola, 52
Petriculida, 18
Phænoschisma, 315
Phanerozonia, 296
Pharus, 51, 115
Philine, 46
Philiidæ, 10
Philonezidæ, 24
Philonezis, 24
 (Octopus) carence, hectocotylistation, 243
Pholadacea, 19
Pholadidæ, 19
Pholadidea, 19
Pholadomyidæ, 51
Pholas, 19
 ductylus, valve, 67
Phormosoma, 290
Phorus ecutus, 5
Phragmocone, 68
Phyllidiidæ, 13
Phyllirhoë, genital organs, 238
 bucephalum, 12
Phyllirhoïdæ, 13
Phyllobranchidæ, 12
Phylloides, 347
Phyllophorus, 287
 urna, 502
Physa, 8
 fiminalis, 8
Physocercinus, 307
Pinna, 17
Pinnules (Crin.), 371; (Blast.), 381
Pirocystis, 336
Pisidium, 17
Pisocrinus, 304
Placobranchidæ, 12
Placophora, 2
Placuna, 15
Planaxidæ, 8
Planorbis, 8, 58
Plastidogenic organ, 445
Plastron (Echinoid.), 348
Plates, included, 340; isolated, 340; half, 340; primary, 340
Platycrinidæ, 307
Platycrinus triacantadactylis, 308
 tuberosus, tegmen, 335
Platydoris, 13
Plesiocidaroida, 289
Plesiospatangidæ, 293
Pleurae, 182
Pleurobranchæa, 10
 Meckelii, genital organs, 237
Pleurobranchia, 47
Pleurobranchidæ, 10
Pleurobranchus, 18
 aurantiacus, 10
Pleuroleurida, 13
Pleurophyllidia lineata, 13
Pleurophyllidiidæ, 13
Pleurotomaria, 5; shell, 59, 156
Pleurotomaridæ, 5
Pleurotomidæ, 6
Pliodon Spekei, 125
Pluteus, larva, 508, 509, 522
Putonaster, 296
Pneumoderma, 11, 79
Pneumodermatidæ, 11

- Podocidaris*, 290
Podocyst, 258
 Polian vesicles, 416, 423
Polycera, 13
Polyplacophora, 2
Polytremaria, 5; shell, 59, 156
Pompholyx solida, 160
 Porcelainous layer of shell, 57
Porcellanaster, 296
Porcellanasteridae, 296
 Pore rhombs (Cyst.), 384
Porocrinus, 313
Poromya, 51
Poromyidae, 21
 Postpalmars (Crin.), 371
Poteriocrinus, 304
Pourtalesia, 295
 ,, *Jeffreysi*, 295; apical system, 325
Pourtalesiidae, 295
Præputium, 235
 Prismatic layer of shell, 57
Proboscidifera holostomata, 6
 ,, *siphonostomata*, 6
Promachocrinus, 313
Proneomenia, 3
 ,, *Sluiteri*, 3; nervous system, 132; sections, 42
 ,, *vagans*, 184
Proneomeniidae, 3
 Proostracum, 68
 Propodium, 106
Prosobranchia, 4; gills, 90; heart, 199;
 proboscis, 179; sections, 110; snout,
 section, 181; tentacles, 102
Prosoplax, 64
Prostata, 233
Protobranchia, 14; gills, 92
Protocrinus, 313
 ,, *oviformis*, 312
Prunocystis, 332
Prymnadetes, 293
Prymnodesmia, 293
Psammobia, 18
Psammobiidae, 18
Pseudarchaster, 296
Pseudoconch, 47
Pseudolamellibranchia, 15
Pseudomelanida, 6
Pseudomonocyclic Crinoids, 329
Psolus, 287
 ,, *ephippifer*, 287
Psychropotes, 235
 ,, *longicauda*, 285
Psychropotidae, 235
Pteraster, 298
Pterasteridae, 298
Pterasterinae, 503
Pterobranchia, 13
Pterocera, 107
Pteropoda, 10; larva, 257
 ,, *gymnosomata*, 11
 ,, *thecosomata*, 11
Pterobranchæida, 6
Pterotrachea, 109
 ,, auditory organ, 168
 ,, (*Firola*) *coronata*, 7
Ptychodera, 562
 ,, *aurantiaca*, 585
 ,, *bahamensis*, 585
 ,, *clavigera*, 570
 ,, *erythroa*, 585
 ,, *minuta*, 562; branchial region,
 section, 562; head region,
 section, 566, 568; cœlom,
 diagrams, 576
Pulmonata, 8, 32; eye, 170; radula, 183;
 renal ducts, diagram, 75
Pupa, 8
Pupidae, 8
Purpura, 101
Purpuridae, 6
Pygaster, 291
Pygurus, 293
Pyramidellidae, 6
 Pyriform vessel (Gastr.), 220
Pyrula, 44
 ,, *tuba*, 73
Pythonaster, 298

 RACHIAL teeth, 182
Rachiglossa, 6
 Radial shields, 362
 Radials, 318
Radiolitidae, 18
 Radula, 177, 180-183
 Red-brown organ (Keber's organ), 215
Regulares, 315
Reptantia, 10
Requienia, 18
Retaster, 298
 Rete mirabile (Hol.), 452
Retiocrinidae, 306
Retiocrinus, 306
Rhabdopleura, 600-602
 ,, *Normani*, 601; section,
 602
Rhachiglossa, 6
 Rhinophore, 48, 103
Rhipidocrinus, 306
Rhipidoglossa, 4
Rhizochilus, 183
Rhizocrinus, 311
 ,, *lofotensis*, 335; axial canals,
 378; stone canal, 423
 ,, *Rawsoni*, 335
Rhodocrinidae, 306
Rhodocrinus, 306
Rhodope Veranii, 281
Rhopalodina, 287
 ,, derivation of, 408
Rimula, 43
Ringiculidae, 46
Rissoidea, 108
Rizzolia, 13
Rossia, 24

- Rostellaria*, 102
 „ *rectirostris*, 6
Rostrifera, 6
 Rostrum (Ceph.), 68; (Gastr.), 102
Rotula, 293
 Rotulæ (Echinoid.), 400
Rudistes (*Hippurites*), 62
 Ruff (Gastr.), 107

SACCULI (Crin.), diagram, **490**
Salenia, 290; apical system, **319**
Salenioid, 290
Savicara, 19
Sæurgus, 243
Scalariidae, 6
Scaphander, 64
Scaphandridæ, 10
Scaphites stage, 68
Scaphopoda, 13
Schizaster, 293
 „ *canaliferus*, pedicellariæ, **397**
 „ *lacunosus*, **294**
Schizobolus, 315
Schizocardium, 562
 „ *brasiliense*, gills, section,
 569
 Schizogony, 505
 Schwammerdam's vesicle, 233
Scissurella, 5
Scotoplax, 418
Scribicularia piperata, **52**
Scribiculariidae, 51
Scurria, 5
 Scuta buccalia, 360
 Scutella adorata, 360
Scutella, 293
 „ *sexforis*, **292**
Scutellida, 291
Scutum (*Pæromorphus*), 4
Scyllarid, 13
Scytaster, 326
 Sea urchins (= *Echinoid.*), 316
Semiproboscifera, 6
 Semites (= fascioles), 349
 Semper's organ, 166
Sepia, 224; alimentary canal, **189**; body
 cavity, **213**; cephalic cartilage,
126; ctenidium, **85**; diagram, **36**;
 gill, **96**; gonad, male, **231**; onto-
 geny, **266**, **267**; nervous system,
148; renal sacs, **213**; shell, sec-
 tion, **69**; spermatophore, **242**
 „ *aculeata*, shell, **70**
 „ *affinialis*, circulatory system, **209**;
 eye, **172**; genital organs, female,
240; genital organs, male, **239**;
 renal sacs, **224**
 „ *Savigniana*, **83**
Sepiadarium, 24
Sepioida, 24; nervous system, **148**
Sepioidæ, 54
Sepiotentis, 24
Septibranchia, 21; gills, **92**

Sickles = radii (Echinoid.), 400
Silenia Sarsii, 21
Siliqua, 115
 Sinistral twist (Gastr.), 56, **60**, 160
Sinypallata, shell, **63**
 Siphon (Ceph.), 37; = accessory intestine
 (Echinoid.), 481; (Gastr.), 43; (Lam.),
 exhalent, 49; (Lam.), inhalent, 49
Siphoniata, 44
Siphonodentarium, 13
 Siphonoplax, 64
Siphonostomata, 44
 Siphuncle (Ceph.), 37
Solarida, 6
Solasteridae, 298
Solen, 19
Solenida, 19
Solenocurtus, 19
Solenogastres, 3
Solenogastrida, section, **212**
Solenomya, 91
Solenomyiidae, 14
Solenopoda, 228
 Spadix, 116
Spatagocystis, 295
Spatangidae, 293
Spatangoida, 293; ambulacral brush,
 section, **433**
Spatangoidea, larva, **509**
Spatangomorphia, 293
Spatangus, 293
 „ *purpureus*, apical system, **324**;
 oral region, section, **441**
 Spengel's organ, 84
 Spermatophore, 241, 242
Sphærechinus, 290
 „ *granularis*, pedicellariæ, **397**,
 398
 Sphæridia (Echinoid.) 392; section, **392**
Sphærium, 17
Sphæronis, 336
 Spiculum amoris, 237
 Spiracles (Blast.), 382
Spirula, 24; shell, section, **69**
 „ *prototypus*, **23**
Spirulida, 24
Spirulirostra, 24; shell, section, **69**
Spongyllide, 53
Spondylus, 62
Spongiobranchæa, 11
Spongylocentrotus, 290
 Star-fish (= *Asteroidea*), 316
Steganobranchia, 12
Steganocrinus, 307
Stelidiocrinus, 307
Stellaster, 296
Stelleriæda (= *Asteroidea*), 295
Stenoglossa, 6
Stereosmata, 290
 Sternum, 348
 Stewart's organs (Echinoid.), 442
Stichaster, 298
 „ *albulus*, 506

- Stichasterida*, 298
Stichopus, 285
 " *japonicus*, rod and supporting plate, 337
Stilifer Linckia, sections, 245, 246
Stolasterias (= *Asterias rosellata*), 396
Stomatida, 5
 Stone canal, 416-423
 Streptoneurous condition (Gastr.), 133, 158
Streptosomata, 290
Strombida, 6
Strombus, 102
Strongylocentrotus lividus, 398
Strobocrius, 307
 " *regalis*, apical border, 368
Struthiolarida, 6
Stylomatophora, 8
Submarginula, 89
Submytilacea, 17
Succinea, 8
Synbathocrius, 304
Synapta, 288; young, 516; auditory vesicle, section, 467
 " *digitata*, 288; larva and young, 511
 " *inhalans*, calcareous body, 337
 " *ritata*, 470
 Synapticula, 567
Synaptida, 288; ciliated urn, 438
 Synostosis (Crin.), 376
 Syzygy (Crin.), 376

TÆNIOGLOSSA, 6
Talarocrius, 308
Tapes, 18
 Tapetum lucidum, 175
Tarocrius, 309
 " *multibranchiatus*, 310
Tectibranchia (= *Palliatia*), 10; section, 110
Tectura (= *Acmta*), 5
 Teeth (Ast.), 473; (Echin.), 400, 401; pharyngeal (Gastr.), 180
 Tegmen calycis, 302, 369
 Tegmentum, 39
Teliocrius, 307
Tellina, 18
Tellinacea, 18
Tellinida, 18
Tenuopleurida, 290
Tenuopleurus, 290
Terebra, 102
Terebrida, 6
Teredina, 65
Teredinida, 21
Teredo, 21
 " *nacalis*, 20; development, 259, 260
Tergipes, 13
 Terminal plates (Ast.), 354
Tistaella, 8, pallial organs, 77
 " *haliotidea*, 9, 44, 45

Teslacellida, 8
Tethyaclitida, 13
Tethys, 13
Tetrabranchia, 22
Thammatocrius, 309
 " *renovatus*, 310
Thecosomata (Pteropoda), 11
Thecia, 287
Thracia, 21
Thyca, 183
 " *ectocantha*, 244-246; sections, 244, 246
Thyone, 287
 " *chilensis*, 417
Thysanocenthis, 24
Tiarechians, 289
 " *princeps*, 289; 319
 Tiedemann's bodies, 416-424
Titisania, 4
Tornaria larca, 507
 " *Agassizi*, 589
 " *Grancheri*, 587
 " *Krohnii*, 586, 590
 " *Mülleri*, 587
Tornatunida, 46
Torus angularis (Oph.), 361
Tosia, 326
Toviglossa, 6
Tocopucastes, 290; masticatory apparatus, 402
 " *drachhiensis*, apical system, 320; system of plates, 341
Tremoctopus, 24
 " *violaceus*, 196
Trichaster, 301
 " *deyans*, 394
 Tricuspid body (Lam.), 194
Tridacna, 18
Tridacnida, 18
Triforis, 160
Trigonia, 15
Trigoniida, 15
Triopa, 13
 Triploblastica, 545
Tripanostus, 290
Tribonia, 13
Tritonaiada, 13
Tritoniida, 6
 Trivium, 325, 347, 407
Trochida, 5
Trochophora, 253, 260
Trochostoma, 287
Trochus, gills, 90
Troostoblastula, 315
Troostocrius, 315
Truncatellida, 6
 Tubercle, 388
Turbellulida, 6
Turbinida, 5
Turbo, 166
 Turgescence, 118
Turritile stage, 68
Turritella, 30

- Turritellida*, 6
Tylaster, 297
Tylobina, 10

U**INTACRINUS**, 309
Umbrella, 10
Umbrellider, 10
Uncini, 182
Unio, 17
 „ *Margaritiferus* (*Margaritana*), **17**,
 35
 „ *pinctorum*, 17
Unionida, 17
Unionina, 50
Uniphora, 299
Urechinus, 293
Urns, ciliated, 437
Utriculus, 180

V**AGINULIDÆ**, 8
Vaginulus, 45
Valvaster, 299
Valvulider, 6
Veliger, larva, 1, 257
Velum, 250
Veneracea, 18
Venericardia, 17
Venerida, 18
Venus, 18

Vermetida, 6
Vermetus, 108, 248
Vertebral ossicles (Oph.), 356
Verticordiida, 51
Vitrina, 8
Valutida, 6
Vulsella, 17

W**ACHSMUTH** and Springer's rule, diagram,
374
Wandering cells (amoebocytes) (Echin.),
415
Water lung (Hol.), 487; pore (Scaph.),
221; pores (Crin.), 377

X**ENOCRINUS**, 306
Xenophorida, 6
Xylophaga, 21

Y**OLDA**, 14
Ypsilothuria, 409

Z**EUGOBRANCHIA**, 4
Zonites, 8
Zoroaster, 298
 „ *fulgens*, apical system, **326**
Zoroasterida, 298
Zygoneury, 137

THE END

BOOKS ON ANATOMY AND PHYSIOLOGY.

- ELEMENTS OF THE COMPARATIVE ANATOMY OF VERTEBRATES. Adapted from the German of Prof. ROBERT WIEDERSHEIM. By W. NEWTON PARKER, Professor of Biology in the University College of South Wales and Monmouthshire. With additions by the Author and Translator. 270 Woodcuts. Medium 8vo. 12s. 6d.
- THE STRUCTURE OF MAN. By Prof. R. WIEDERSHEIM. Translated by H. M. BERNARD and G. B. HOWES. 8vo. 8s. net.
- A TEXT-BOOK OF COMPARATIVE ANATOMY. By Prof. ARNOLD LANG. With Preface to the English Translation by Prof. Dr. ERNST HAECKEL. Translated into English by HENRY M. BERNARD, M.A. Cantab., and MATILDA BERNARD. Vol. I. 8vo. 17s. net.
- LESSONS IN ELEMENTARY ANATOMY. By ST. GEORGE MIVART, F.R.S., Author of "The Genesis of Species." Fcap. 8vo. 6s. 6d.
- TEXT-BOOK OF ANATOMY AND PHYSIOLOGY FOR NURSES. Compiled by DIANA CLIFFORD KIMBER, Graduate of Bellevue Training School. 8vo. 10s. net.
- A COURSE OF INSTRUCTION IN ZOOTOMY. Vertebrata. By T. JEFFERY PARKER, F.R.S., Professor of Biology in the University of Otago, New Zealand. With Illustrations. Crown 8vo. 8s. 6d.
- AN INTRODUCTION TO THE OSTEOLOGY OF THE MAMMALIA. being the Substance of the Course of Lectures delivered at the Royal College of Surgeons of England in 1870. By Sir WILLIAM HENRY FLOWER, F.R.S. Illustrated. Third Edition. Revised with the assistance of HANS GADOW, Ph.D. Crown 8vo. 10s. 6d.
- THE MYOLOGY OF THE RAVEN (*Corvus corax Sinuatus*). A Guide to the Study of the Muscular System in Birds. By R. W. SHUFELDT, of the Smithsonian Institute, Washington, U.S.A. With Illustrations. 8vo. 13s. net.
- A TEXT-BOOK OF PHYSIOLOGY. By MICHAEL FOSTER, M.D., F.R.S., Professor of Physiology in the University of Cambridge, and Fellow of Trinity College, Cambridge. Illustrated. 8vo.
- Part I. Comprising Book I. Blood—The Tissues of Movement, the Vascular Mechanism. Sixth Edition. 10s. 6d.
- Part II. Comprising Book II. The Tissues of Chemical Action, with their Respective Mechanisms—Nutrition. Sixth Edition. 10s. 6d.
- Part III. The Central Nervous System. Sixth Edition. 7s. 6d.
- Part IV. Comprising the remainder of Book III. The Senses and some Special Muscular Mechanisms; and Book IV. The Tissues and Mechanism of Reproduction. Fifth Edition. 10s. 6d.
- THE CHEMICAL BASIS OF THE ANIMAL BODY. An Appendix to Foster's "Text-Book of Physiology." By A. SHERIDAN LEA, M.A., D.Sc., F.R.S., University Lecturer in Physiology in the University of Cambridge. Fifth Edition. 8vo. 7s. 6d.
- PHYSIOLOGY. By MICHAEL FOSTER, M.D., F.R.S. With Illustrations. Pott 8vo. 1s. [Science Primers.]

MACMILLAN AND CO., LTD., LONDON.

BOOKS ON PHYSIOLOGY AND EMBRYOLOGY.

A COURSE OF ELEMENTARY PRACTICAL PHYSIOLOGY AND HISTOLOGY. By Prof. MICHAEL FOSTER, M.D., F.R.S., and J. N. LANGLEY, F.R.S., Fellow of Trinity College, Cambridge. Sixth Edition. Crown 8vo. 7s. 6d.

LESSONS IN ELEMENTARY PHYSIOLOGY. By T. H. HUXLEY, F.R.S. With numerous Illustrations. Fourth Edition. Pott 8vo. 4s. 6d.

QUESTIONS ON HUXLEY'S LESSONS IN ELEMENTARY PHYSIOLOGY. For the Use of Schools. By THOMAS ALCOCK, M.D. Fifth Edition. Pott 8vo. 1s. 6d.

A TEXT-BOOK OF THE PHYSIOLOGICAL CHEMISTRY OF THE ANIMAL BODY. Including an Account of the Chemical Changes occurring in Disease. By ARTHUR GANGE, M.D., F.R.S., Emeritus Professor of Physiology in the Owens College, Victoria University, Manchester, etc. 8vo. Vol. I. 18s. Vol. II. 18s.

A TREATISE ON COMPARATIVE EMBRYOLOGY. By F. M. BALFOUR, M.A., F.R.S., Fellow and Lecturer of Trinity College, Cambridge. In two Vols. Second Edition. Medium 8vo. Vol. I. 18s. Vol. II. 21s.

THE ELEMENTS OF EMBRYOLOGY. By Prof. MICHAEL FOSTER, M.D., F.R.S., and the late F. M. BALFOUR, F.R.S., Professor of Animal Morphology in the University of Cambridge. Second Edition, revised. Edited by A. SEDGWICK, M.A., Fellow and Assistant Lecturer of Trinity College, Cambridge, and W. HEAPE, M.A., late Demonstrator in the Morphological Laboratory of the University of Cambridge. Illustrated. Crown 8vo. 10s. 6d.

LESSONS IN ELEMENTARY BIOLOGY. By T. JEFFERY PARKER, F.R.S., Professor of Biology in the University of Otago, New Zealand. Illustrated. Second Edition. Crown 8vo. 10s. 6d.

A COURSE OF PRACTICAL INSTRUCTION IN ELEMENTARY BIOLOGY. By T. H. HUXLEY, F.R.S., assisted by H. N. MARTIN, F.R.S., Professor of Biology in the Johns Hopkins University, U.S.A. Third Edition, revised and extended by G. B. HOWES, Assistant Professor, Royal College of Science, and D. H. SCOTT, Ph.D. With a Preface by T. H. HUXLEY, F.R.S. Crown 8vo. 10s. 6d.

AN ATLAS OF PRACTICAL ELEMENTARY BIOLOGY. By G. B. HOWES, Assistant Professor, Royal College of Science, Lecturer on Comparative Anatomy, St. George's Medical School, London. With a Preface by T. H. HUXLEY, F.R.S. Medium 4to. 14s.

MACMILLAN AND CO., LTD., LONDON.

