

MANN
SF
531
.7
.R66
1913
no.13

CORNELL UNIVERSITY LIBRARY



3 1924 068 962 343

WINTERING BEES

By E. R. ROOT

G. W. Heppeler



Cornell University Library

The original of this book is in
the Cornell University Library.

There are no known copyright restrictions in
the United States on the use of the text.

<http://www.archive.org/details/cu31924068962343>

Wintering Bees

An Exhaustive Treatise
of the Subject Covering
both the Outdoor and
Indoor Methods

C. W. Eppler

By E. R. ROOT

Published by
THE A. I. ROOT CO.
Medina, Ohio

PREFACE.

The matter for this booklet is taken from the article on wintering, in the author's larger work, the A B C and X Y Z of Bee Culture. Some new matter, however, has been added, covering the subject of feeding and brood-rearing in mid-winter while the bees are in the cellar. A new chapter on the importance of windbreaks has also been added. The author now believes that a suitable form of windbreak for outdoor bees is a vital and important element in successful wintering, and has, therefore, given this phase of the matter the consideration it deserves, in this little work.

Medina, Ohio, Sept. 1, 1913.

E. R. Root.

WINTERING BEES

TWO METHODS OF WINTERING BEES.

There are two methods in vogue. One is called the indoor and the other the outdoor plan. Which one the reader shall use depends entirely on the locality. Where the winters are extremely cold, with *continuous* freezing weather prevailing through the cold months of December, January, February, and March, without warm days intervening, the indoor or cellar plan of wintering bees is the one usually followed. However, in such climates some prefer wintering in tement hives where anywhere from four to ten colonies can be accommodated. In other places, say fifty or one hundred miles south of the great lakes, or where there is an occasional warm day, say one or two a month when bees may fly, the outdoor method of wintering in double-walled hives, or in single-walled hives with winter cases, is the plan generally in vogue. Throughout the Southern States the plain single-walled hives are warm enough without extra protection.

Indoor wintering in the colder localities does not require double-walled hives or winter cases; but when bees are set out in the spring, some protection should be provided.

Although cellar wintering requires less expensive hives, it involves more skill—especially so if the cellar or winter repository does not afford all the favorable conditions. Just what these are will be referred to later. While the outdoor method, on the other hand, demands double-walled hives, winter cases, or something to protect the hives on their summer stands, and a shielded location protected from the

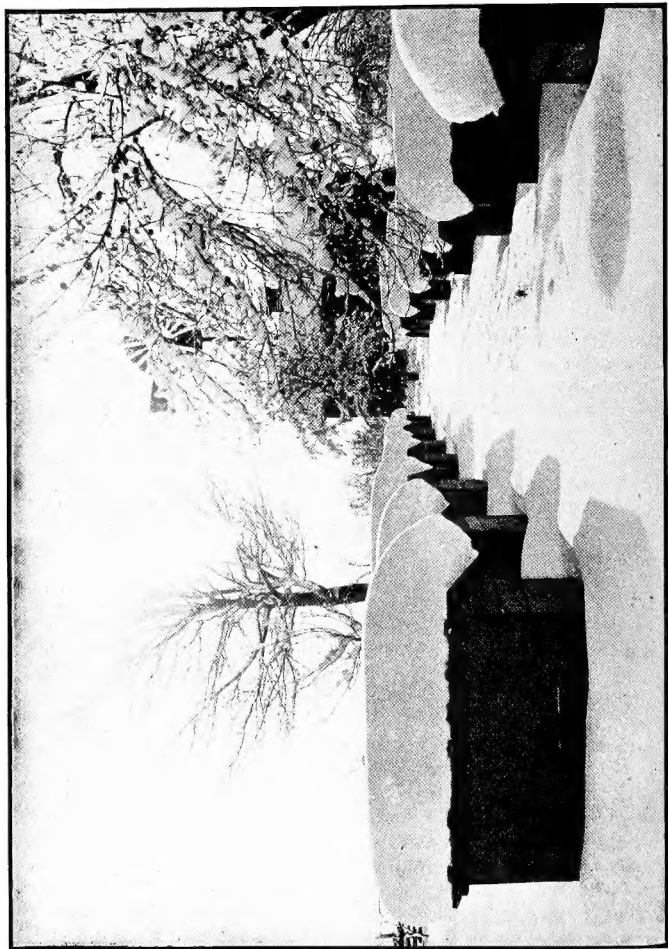

Outdoor wintering at the apiary of F. J. Miller, of London, Ont., Canada.

prevailing winds, it does not require that degree of skill made necessary when the bees are confined in the cellar. Therefore, the majority of beginners, especially where the climate is not severe, are advised to winter outdoors. But it is important to observe right here that the spot where the bees are kept must be sheltered from prevailing winds.

With either the indoor or outdoor plan it is fair to state that, after a very severe winter in which the mercury plays below the zero-point for weeks at a time, and when spring is very late, with a warm spell followed by a very severe cold one, losses are likely to be heavy, even among the most experienced beekeepers. But these losses can to a very great extent be minimized, even in bad years, provided one makes a study of his locality, regarding the average weather conditions that prevail. It will, therefore, be the object of this booklet to set forth as nearly as possible some of the difficulties to be encountered, so that the reader may intelligently undertake the problem. It is well to state, though, that the very severe winters referred to do not occur more than once in 10 or 20 years, when for some reason the whole year seems to be thrown entirely out of balance; but at all other times, if one follows carefully the directions here given his losses will not exceed ten per cent, and he may keep them down as low as two per cent. Indeed, some have wintered their bees winter after winter with a loss not exceeding five per cent, if we throw out of calculation the one year in ten which proves abnormally severe.

OUTDOOR WINTERING.

This is the simpler plan for most beginners, and the principles involved help to lay the foundation for the more difficult problem of indoor or cellar wintering. The prime requisite for both methods of wintering is a large force of young bees reared during the latter part of summer or early fall. A colony made up of old wornout bees with very few young, no matter how strong, will be almost sure to succumb before spring, or reach such a weakened condition as to become practically worthless for the following seasons. As

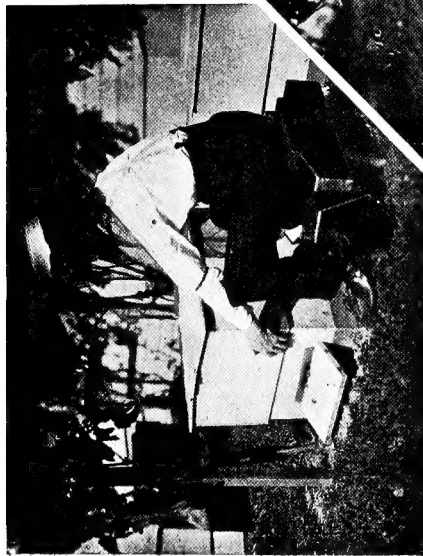

FIG. 2.—A deep telescoping cover to set over the packing-trays for out-door wintered colonies is preferable.

FIG. 3.—The top packing consists of a tray filled with planer shavings.

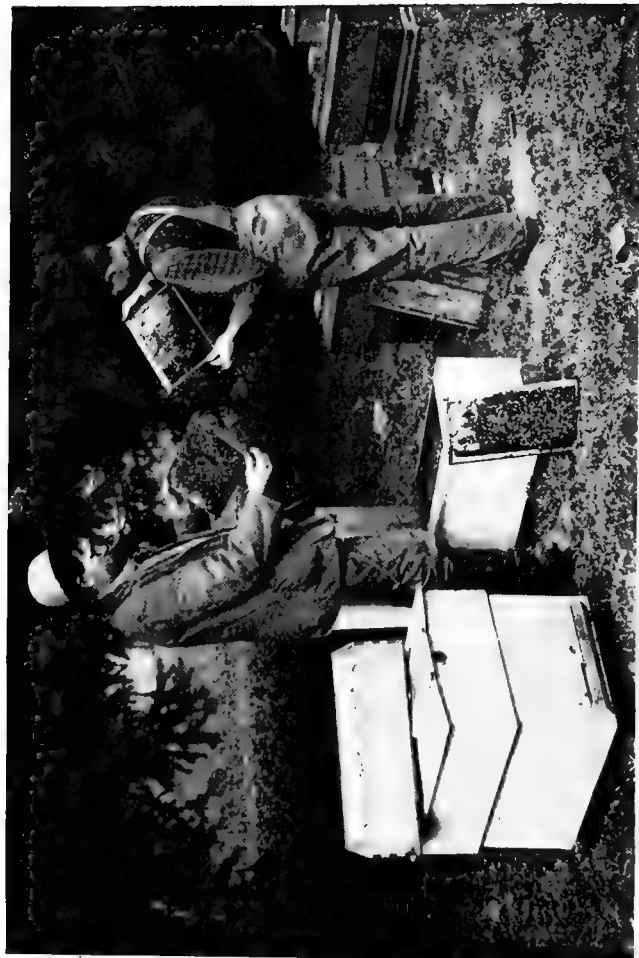



FIG. 5.—Manner of pouring in feed from a common watering-pot into a Doolittle division-board feeder. After sufficient syrup is given, the feeder is removed, the combs are shoved over, a division-board inserted, and hive closed for winter.



FIG. 4.—The super-cover is made of $\frac{3}{4}$ lumber, tin-bound at the ends. This is put on the hive, and covered with the tray shown in Fig. 3.



Examining colony in double-walled chaff hive; chaff-tray containing pac king-material is shown at the left.

a general rule, in the Northern States brood-rearing ceases right after the honey-flow. This is perfectly normal where there is no late summer or fall pasturage like buckwheat; but during the latter part of August and the early part of September, brood-rearing should begin again; and unless there are natural sources of nectar the bees will require feeding with thin syrup given in small quantities daily to stimulate. This stimulative feeding should be continued long enough to get a lot of brood in the hive so there will be a strong force of young bees to go into winter quarters. In many localities colonies will be able to gather enough nectar daily to supply themselves with young bees without any special feeding. So far the scheme of raising a large force of young bees is an important requisite for either method of wintering, but especially important where bees are wintered outdoors subjected to extremes of temperature requiring a large consumption of stores in order to keep up necessary heat.

It is unwise to attempt to winter bees outdoors in single-walled hives north of 40 degrees north latitude. While the colonies may come through after a fashion, the shock of the exposure will be so great that they probably will not be good for much to gather honey. It is also highly important that the hives be protected from high winds, and that the walls surrounding the hive be double and warm. Colonies in double-walled hives out in the open, and where there is a strong windsweep, may not survive, while those in single-walled hives screened by buildings, woods, or dense shrubbery, may winter well. To say the least, it would appear that protection from the prevailing winds is just as important as having the walls of the hives double. Special double-walled hives are manufactured, having the space between filled with chaff, planer-shavings, leaves, or other suitable material. The cover or roof should also be double so that the heat of the cluster will not too readily radiate away, thus causing a great consumption of stores in order to keep up the necessary animal heat; for it should be remembered that, the warmer and better protected the cluster, the less honey they

require to eat. It is desirable to have the bees, so far as possible, enter a quiet state of sleep, or semi-hibernation, that practically amounts to a condition of suspended animation. But an extremely cold spell will make it necessary for this cluster to unfold and consume its stores in order to keep up the temperature. When, therefore, a colony is so poorly protected that it has to overeat in order to keep warm, the bees will become distended, and dysentery or purging is almost sure to follow. This occurring in mid-winter or early spring means the death of the colony, as there is no cure for it but warm weather.

A hive having double walls well packed with a warm cushion on top, and a good cover, makes about as good a winter home as it is possible to construct. A tray containing chaff, planing-mill shavings, or forest leaves resting under the telescope cover keeps the top warm. A large cushion may be used instead but it is not so good.

The extra packing and double walls not only save in the consumption of stores, but eliminate to a great extent winter losses.

WINTER CASES FOR SINGLE-WALLED HIVES.

Because double-walled hives are somewhat expensive, many beekeepers start with single-thickness hives, intending to winter, perhaps, indoors. How shall they be prepared and yet give as good results, practically, as can be obtained from the more expensive double-thickness hives? Very good outside winter cases are obtainable from supply manufacturers, large enough to telescope down over the hive. The cover of the single-walled hive, if it projects over, as most of them do, should be removed, and what is known as a thin super-cover—that is, a thin board of the same width and length as the hive, substituted. Several folds of newspaper, old carpeting, or any other suitable material, should be laid crosswise and lengthwise over the top of the hive. Enough of them should be put on so that, when the winter case is put on, it will telescope over, crowding the folds of newspaper or other packing material neatly around the inner

hive. The illustration herewith given will give some idea of the scheme here proposed.

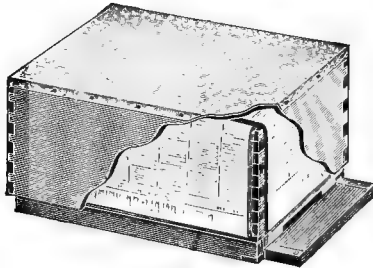

Telescope cap.

Another plan, and possibly just as good, embodying the same principle, but more laborious and cheaper, may be employed. Instead of having a winter case made of wood, the protection is made up of a large square of medium-weight manilla or roofing paper, laid on top of folds of newspaper as before directed, and then neatly folded down on the sides and ends as one would do up a package, and tied with a string as shown in the following illustration. It will also be important not to make the mistake of making the folds come down over the end of the hive in such a way that they will catch and hold water. In the next illustration the method of wrapping and tacking the paper is shown. If one uses manilla paper it would, perhaps, be well to cover it with a coat of grease, or, better still, linseed oil. In the spring one can examine his bees by loosening the bowknot of the string, lifting off the paper cover, and finally the packing under it. After examination, the paper can be readjusted as before, with the packing material underneath.

In cold localities this packing should not be less than two inches thick. If one can not secure enough newspapers perhaps he can contrive some scheme for using old carpeting or grain-sacks, especially such as are unfit for any other pur-

pose. He can usually obtain quite a quantity of these by going to the farmer or miller; and he may (and probably will) receive free all he can take away.

In selecting a roofing-paper for the purpose, avoid the heavy grades, as they are expensive, and do not fold readily; and, when folded, they will break on removing the string.



A winter case made of second-hand wrapping-paper as used at Medina.

A greased manila paper, about like flour-sacking, gives very good results; any paper which will stand weather, and yet fold up flat again in summer after the cold winter and spring are over, will answer. The next two illustrations show a better arrangement—paper wrapping, a cushion, and, last of all, a wooden case to telescope over the whole.

Some use, instead of the string to fasten the paper down, strips of wood tacked on. These hold the paper close against

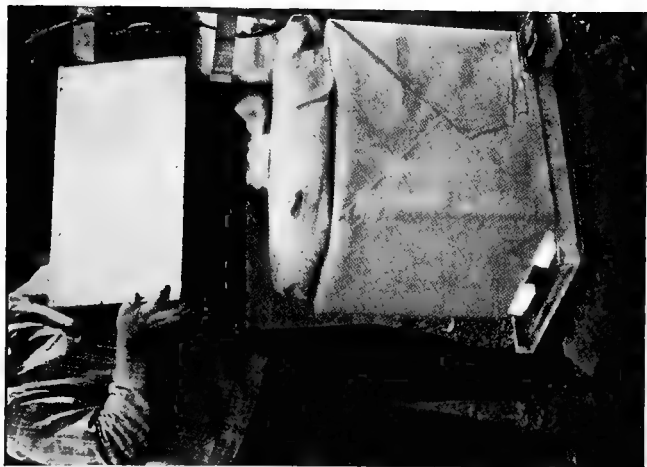

Paper winter case with chaff cushion placed on top.

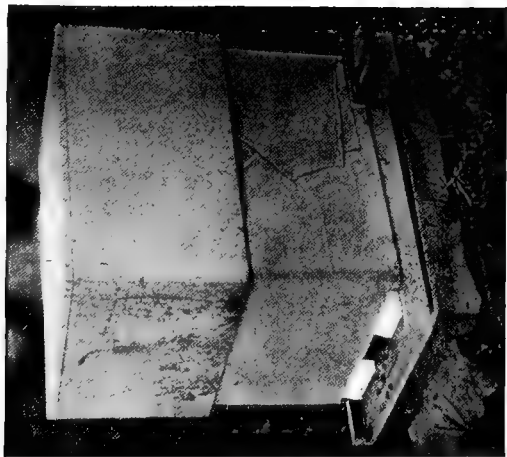

Combination paper and wooden winter case.

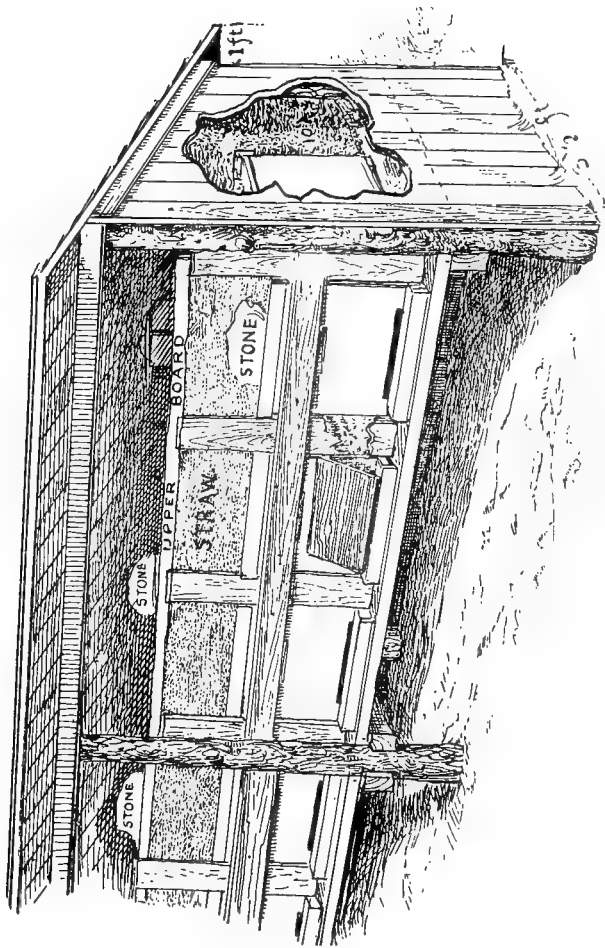

W. T. Davison's method of packing bees in straw for outdoor wintering.

the hive in a way the string does not. This is important, as it keeps out the cold.

Another method of protecting the single-walled hives is to get some old drygoods-boxes. Pile straw on top of the hives, then push the large box back over the hive. But as these boxes are of such varieties of shapes and sizes they are not usually very satisfactory; and, besides, they do not shed rain unless covered with roofing-paper.

Another scheme is to put the hives in a row under a shed, leaving the point of least exposure in front. Where there



Townsend's method of protecting hives after setting out in the spring.

is no protection of the buildings or trees to screen in the apiary, a shed with the back to the prevailing winds is a great help. Under such a shed straw is then packed in between the hives and in the rear, after which it is covered with boards to shed water.

WINTERING BEES IN TENEMENT HIVES.

A tenement hive, as its name indicates, is one large winter case capable of housing anywhere from two to a dozen colonies in single-walled hives. It is usually composed of

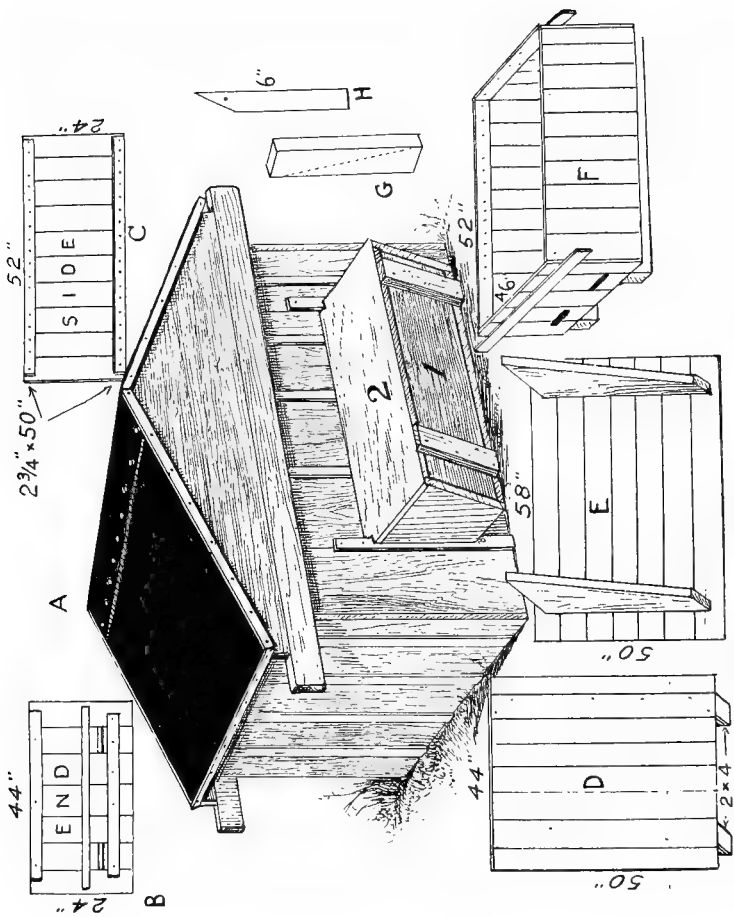

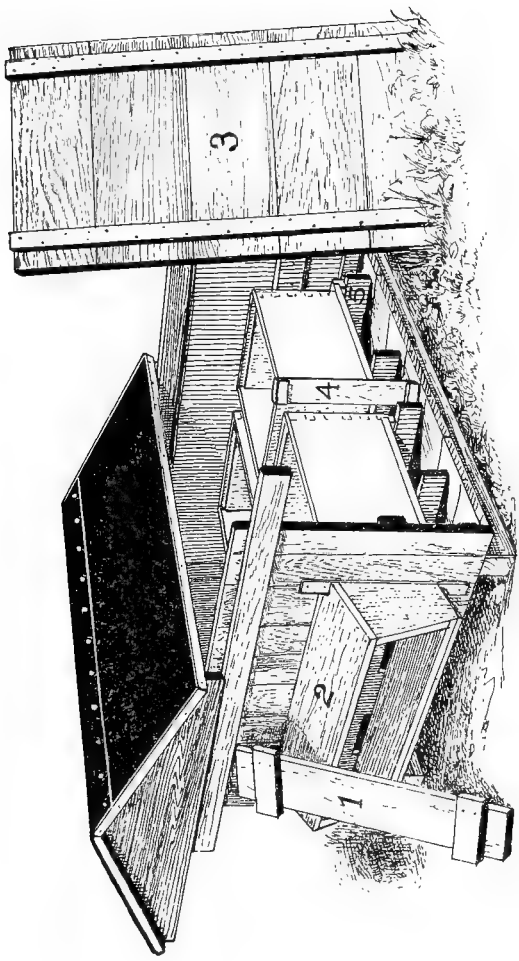

Bartlett's winter case for holding four ten-frame colonies; lower illustration showing interior.

large cleated panels made of cheap lumber for the sides and ends, and with a roof of like material covered with roofing paper. The whole is held together at the intersecting corners by means of Van Deusen hive-clamps, or hooks and eyes or screws. When the bees are unpacked in the spring the panels are removed and laid away until the following September or October, when they are brought into use again.

The tenement hive finds its advocates and users in colder climates—that is, climates where the ordinary double-walled hives do not give quite enough protection, and where cellar wintering generally prevails. But indoor wintering has its disadvantages, as we will show a little later. Many cellars are poorly adapted for keeping bees over winter. Special repositories for the purpose are expensive; and even when the best conditions are provided it requires a good deal of skill to bring the bees through successfully from fall to spring. And this is not all. The cellar plan of wintering requires the moving of the bees in and out of the cellar, and more or less attention during the winter to provide for the varying degrees of temperature and the necessary ventilation. Mr. R. F. Holtermann, for example, whose bee-cellar is shown a little later on, gives the following reasons why he abandoned his \$1000 bee-cellar, described further on, and has now adopted the tenement-hive scheme of wintering.

When wintering in the above-named cellar my method was to remove the bees from the cellar and place them on stands. They were next taken to clover pasture, sometimes a distance of thirty miles. Next they were taken to buckwheat, and finally returned to the bee-yard in connection with the cellar.

By this method the hives and bees were unprotected during the spring, also in the autumn, until placed in winter quarters about Nov. 20. I was also compelled to be on hand when the cold weather began to moderate in spring, and there was always a good deal of anxiety as to the best time to set out, sometimes to find that, owing to conditions of weather, many bees had perished in their first flight, and others had drifted to the disadvantage of weaker stocks.

There are various styles of tenement hives. One of the simplest and best is the Bartlett. The cut renders the mode of construction so plain that further description will be unnecessary except to say that the several panels are held together by means of wood screws. The four hives are plac-

ed in contact with each other (for the purpose of conserving the heat of the clusters) when the space between the group of hives and the winter case is filled with packing material, consisting of planer shavings, forest leaves, straw, or chaff. Mr. R. F. Holtermann uses a tenement made out of cheap half-inch boards, and he thus describes it:

As I now winter the bees shown in the illustrations in connection with this article, four twelve-frame Langstroth hives are wintered in an outer case; two hives are placed in the case side by side, and another two also side by side, but back to back with the first pair. This makes two sides of each hive have the best of winter protection—namely, the protection of other hives warm with bees.

The cases consist of a platform of half-inch boards nailed upon three cleats 1 x 4 inches, the two at each end being on edge, to give strength. The three cleats extend half an inch beyond the side of the platform, and are so arranged that the two at the ends project half their thickness beyond the ends of the floor-boards.

By this construction the half-inch siding lumber may extend down past the floor, and rest upon the half-inch projections all around, protecting all from lodging water and snow. The sides and ends of the case are made of tongue-and-groove material, $\frac{1}{2}$ inch thick, 32 inches high, and therefore make a case deep enough to hold an extracting-super on top of the hive. This half-inch stuff is kept together and strengthened by a cleat on the inside, 1 x 2 inches, and half an inch shorter than the side or end is high, namely, $22\frac{1}{2}$ inches. These cleats come even with the top of the case, but are $\frac{1}{2}$ inch short at the bottom, the object being to allow the side or end to extend the half-inch below the top of the platform, and rest on the end of the bottom cleats, as mentioned.

The cover of the case is made of half-inch material nailed at the ends to 1 x $2\frac{1}{2}$ -inch cleats. These latter cleats extend down over the case. They strengthen the cover; and if the locality is windy they can be fastened to the case by means of hooks. The lumber is covered with roofing-paper, nailed to the wood part of the cover, and made water-tight by the judicious use of roofing cement. The cases, from the above description, will be seen to have a perfectly level or flat cover. They can be made to shed water by slightly raising one side of the case.

The bees go in and out through the case by means of $\frac{3}{8}$ -inch round holes. Three are recommended, but I will confess I have found that size of entrance inadequate in the spring before removing from the case, as I leave the bees packed sometimes until clover is opening, having many supers on before removing from the case.

The case is set on blocks 8 to 12 inches high, one at each corner. This takes them above water and ice which may lie or form on the ground. There are no supports for the center cleat, as this is held up to the case by means of galvanized iron straps 6 x 1 inch, binding it to the siding. Considering the tendency to settle and heave, it would be practically impossible to support the case evenly at six points, and by using the above device it is unnecessary.

Mr. G. C. Greiner goes one step further, in that he winters five hives in a tenement.

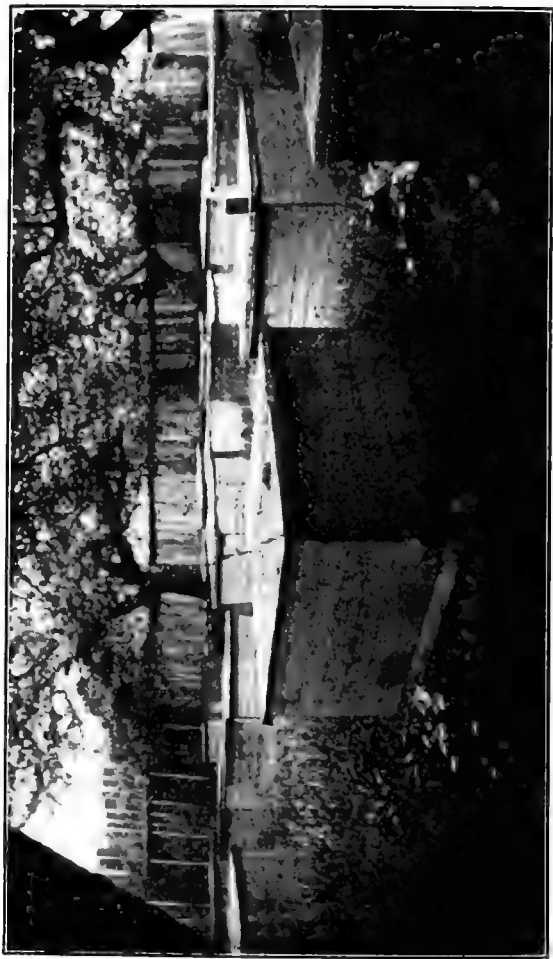

View of one of the Holtermann yards; the colonies are often left in these tenements until clover-bloom.

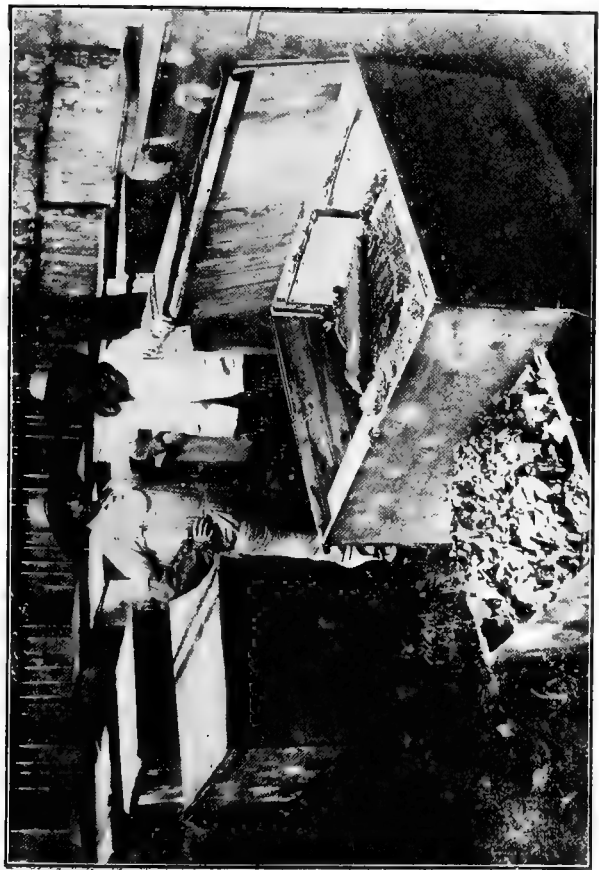

The cover of Holtermann's tenement hive removed, and leaves taken out to show the hive underneath.

All the tenement hives here shown are made up of cheap lumber. The panels are cleated, and held together by hooks or screws. As soon as the winter is over, and settled warm weather has come, the packing is removed and the panels taken down and laid away for the season. The Greiner method of wintering contemplates the plan of removing the

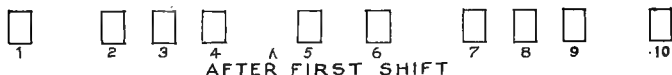
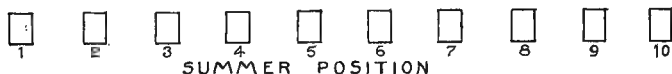

Greiner's arrangement of hives before and after putting in winter-cases.

hives from their summer position to the winter position, so that they can be covered by the tenement sheds. The method of making that shift Mr. Greiner explains as follows:

To explain fully the proper way of moving bees successfully—that is, without any loss of bees—I refer the reader to the accompanying drawing. The upper row shows ten colonies as I work them for extracted honey during the season. They are equally spaced with two feet in the clear between the hives.

The second row shows the same hives after the first shift is made. The four hives, 2, 4, 7, 9, are moved their width toward the center hives

3 and 8. After two or three days (and, of course, I mean flying days), when these shifted colonies have again become accustomed to their new location, the end hives of each section of five, represented by the figures 1, 5, 6, 10, may then be slightly moved toward their respective centers. Under no consideration should these latter be shifted at the same time when the first shift, Fig. 2, is made. That would bring their new stand too near the stands of those just moved, so that more or less mixing up would be encouraged.

The third row shows the ten colonies in position ready for the sheds. If carefully managed, and if the shifting has been done according to the hints here given, they should arrive at these places without the loss of a single bee.

This form of tenement, however, we do not regard as quite the equal of the Bartlett or the Holtermann. Relatively it has a greater amount of exposed surface to the colony. Then we believe it to be an advantage to place the hives in *tight contact* in order that the bees may borrow warmth from each other. Mr. Holtermann and Mr. Bartlett, if we are not mistaken, keep their hives running all summer in groups of four a few inches apart. This avoids all shifting from one season to another, and yet allows the owner to have one side and one end as a means of approach in handling. When it comes time to put the bees into winter quarters, there is no lifting nor shifting, except to place the hives in direct contact, when they are ready to pack for winter.

It is our opinion that the average beginner in the colder climates will succeed better with the tenement plan of wintering than he would with the most up-to-date bee-cellar.

THE IMPORTANCE OF WINDBREAKS.

In various places leading up to this, we have mentioned the importance of windbreaks to screen the hives from a strong windsweep. For instance, a bad location for wintering bees outdoors is on top of a hill with a clear stretch of country for a mile or two in the direction of the prevailing winds. Although the bees may be nicely housed in double-walled hives, the high winds during cold and chilly weather may and probably will have a disastrous effect on the bees. Many of them, lured out by a bright sunshine on certain days, will be caught by a chilling blast. They will drop on to the ground; and unless there is a change in the tempera-

ture or the wind for a few days they will never come back. On the other hand, a yard screened in by farm buildings, by a growth of woods or dense shrubbery, will be able to withstand the cold much better. While the bees may fly out on bright sunny days, experience shows that they quickly seek the protected inclosure where their hives are, and soon enter.

Likewise there are certain spots in an apiary where some hives are exposed to a long windsweep, while others are in a more protected position. Observation covering a period of years has shown that the latter winter much better than the former.

Again, it has been shown that colonies in single-walled hives may winter comparatively well in a sheltered location, while those in double-walled hives out in the open air will die. To say the least, the matter of protection and the matter of prevailing winds are of vital importance in outdoor wintering.

Windbreaks of woods or dense shrubbery ten or twelve feet high are better than high board fences. Farm buildings like barns and sheds at least twelve or fifteen feet high afford excellent screens. The objection to a high board fence is that the wind strikes it and glances upward, when it is caught by the blast of air from overhead. It may then dive downward and strike the third or fourth row of hives from the fence. Repeated observation has shown that this row of bees may die when other rows winter comparatively well. In the case of woods or shrubbery the wind can not glance upward and dive downward. The blast filters through, and by the time it penetrates the inner inclosure its force is broken.

It therefore is of the greatest importance in locating an apiary to find a spot that is protected, not only in winter but in early spring and late fall, and even in summer weather. We had one apiary located on a side hill and another in the open. The side-hill bees faced the south. During a cold spell in fruit bloom the last-named bees worked freely on the blossoms, while in the yard exposed to the windsweep there was nothing doing. The side-hill bees continued to

rear brood, while the exposed bees brought every thing to a standstill.

IMPORTANCE OF LETTING BEES FORM A WINTER NEST.

What do we mean by "winter nests"? We mean a space of empty brood-cells in one or more combs, such space approximating the form of a hemisphere in ordinary Langstroth brood-nests. These empty cells surrounded by sealed stores constitute the winter nest where the bees cluster when conditions are ideal. As the stores are consumed, the number of empty cells increases either backward or forward, but always upward. As a general thing we find the ball of bees located near the front of the hive and regularly over the entrance. As the stores are consumed they move upward and backward; but the cluster in no case extends over the sealed honey when the bees can have their own sweet will.

Very often a well-meaning A B C scholar finds three or four combs in the center of the hive, having a space of empty cells as large as the hand spread out. He thinks this is all wrong and will remove the combs containing such spaces, and put in their place *solid combs of honey*. What has he done? He has compelled the bees to cluster upon sealed honey. The cluster is broken up into slabs approximately $\frac{3}{8}$ inch thick, each slab of bees separated by approximately an inch of solid honey. Instead of having one solid cluster separated by only the midrib of the combs, he has made a series of clusters, each within itself trying to maintain its own body heat but at a very great disadvantage.

Let us illustrate: Two people on a cold winter's night require less bed clothing than one person would in the same bed. Now, then, suppose that, instead of having those two bed-fellows separated from each other by only their night clothing, we have a slab of metal or even wood between them. If they are compelled to place their warm bodies in contact with that cold surface they lose a great deal of their

body heat because the cold surfaces carry away (that is, dissipate) the warmth.

We have exactly that condition when we insert combs of sealed honey into a bunch of bees. We compel them to divide up into four or five clusters. The result is, that colonies tampered with in this manner perish or come out in the spring very weak because of their inability to maintain the requisite temperature. Where outside bees become stiff with cold they can not long endure that condition.

If a colony is fed gradually during October and November they will form this winter nest. If, however, they are on the verge of starvation and they are fed 30 lbs. in a single night toward the last end of the fall, or when it is quite cold, they do not have the opportunity of forming this nest. They will carry the syrup down while it is hot; then for a few days after that, if it is so they can fly, or, rather, so the cluster can move freely about the brood-nest, they may or may not rearrange the stores. The cluster, when it actually forms up for winter, will be practically one homogeneous mass of bees separated by only thin cell walls and the midribs of the combs.

If anybody doubts that bees try to have a winter nest, let him break into several clusters of bees when the temperature is down to about 5 above zero, in an outdoor colony. We have done this repeatedly. If the arrangement of combs has not been disturbed in the fall, we will probably find the bees tightly jammed into the cells. And, again, we will often discover, as we go over our colonies in the late winter or early spring, that some of them have actually starved to death. In all such cases we will see dead bees tightly packed in the cells of the winter nest, and a solid mass of bees between the several spaces between the combs. Starvation is often due to the fact that cold weather has continued so long without a let-up that the bees are left high and dry, so to speak, in the center of the winter nest. They actually starve, notwithstanding that sealed honey is within two inches of the cluster. The long-continued cold has given them no opportunity to warm up and shift the cluster over

in contact with the sealed honey. We have seen this condition almost every winter in our yard.

Still again, we have often found dead colonies where some of our newer men in the bee-yard had disturbed the combs, putting a solid comb of honey right down through the center of the winter nest. This made two bunches of bees; and both, being too small, died.

When it comes to indoor wintering, especially where the cellar temperature does not go below 45 F., a winter nest is not so vitally necessary. But if the temperature goes down below 45, then the absence of a winter nest may mean the death of a colony.

Nature has worked out this problem of wintering bees; and when we tamper with her plans we tamper with our pocketbook. While we can do certain things contrary to nature, we can not interfere with her plan in the arrangement of the combs.

NON-POROUS COVERS OR ABSORBING CUSHIONS OVER THE CLUSTER OF BEES.

There has been considerable discussion in the bee-journals over the question of whether there should be loose porous absorbing-cushions or other material placed above the cluster of bees so that the moisture from a cluster can pass up into the packing, or whether, on the other hand, the top of the hive should have a thin board or super cover on top. In the milder climates it seems to be pretty well proven that the wood cover over the bees brings the bees through in better shape. In the colder climates, such as Northern Michigan, Canada, Northern Wisconsin, Minnesota, and Northern New York, a porous covering seems to have somewhat the preference, although we find advocates of the solid-cover principle in these localities. If there is danger of the entrance becoming closed by deep snows or ice for weeks at a time, upward ventilation through porous packing would probably be safer, for bees must have air.

When the top of the hive is closed tight, the moisture from the bees collects on the under side of the cover, drips down, and passes out at the entrance. The absorbing cushions, on the other hand, in our climate often become damp and soggy before spring. When in that condition they will sometimes freeze; and, so far from being a protection, they are a positive detriment. But where the climate is cold and dry, the temperature going down to 10 or 20 below zero, the absorbing cushions will be less damp than in a milder climate subject to more or less humidity on account of moist or rainy weather. When absorbing cushions are used, there must be a space of at least one inch over the top of the packing. In addition, there should be ventilating-holes so that the moisture can escape. But these holes should be so situated as to prevent rain or snow from blowing in.

When non-porous covers are used, it takes less packing than when the absorbing plan is employed; but the entrances must be kept clear. If one has not decided which scheme to adopt, we suggest that he try the two side by side. We have tried sheets of glass the exact size of the tops of the hives. These are imbedded in putty, making a tight sealing between the glass and the hive. The packing material is then placed on top. We have wintered most successfully anywhere from one to a dozen colonies, during successive winters, under these sealed glass covers—not because there was any merit in the glass, but because we could better observe conditions. We could never see that this moisture that collects and drops at the corners ever did any harm.

BEST KIND OF PACKING MATERIAL.

Wheat or oat chaff, preferably the former, has been recommended as being the best material to use; but since the advent of new methods of separating the chaff from the wheat by means of a suction-fan, it is not now easy to obtain the chaff. We now recommend dry forest-leaves, plenty of them, or planer-shavings. Cut straw does very well. In milder climates, two thicknesses of old carpeting or burlap sacking will do. In colder climates we could use

not less than six inches of packing. If the absorbing scheme is used, eight inches will be better.

SIZE OF ENTRANCES.

It has been shown that the entrance should be reduced down so as not to be larger than $\frac{3}{8}$ x 8 inches; and in the case of some of the smaller colonies it would be better to have the openings $\frac{3}{8}$ x 3 or 4 inches. In all cases of outdoor wintering it is important to keep these entrances clear, and it may, therefore, be necessary to rake out the dead bees now and then which may accumulate; for should the entrance become clogged the death of the colony must follow.

WINTER STORES—QUALITY AND QUANTITY.

We have now considered the inclosure, or the hives themselves, for holding a colony for outdoor wintering. Something should be said about the quality and quantity of the stores. It is fair to say that bees outdoors consume nearly twice as much as those indoors; but it is argued, on the other hand, that while the former consume this larger proportion of food they keep stronger numerically and will be in better condition at harvest time than those wintered indoors on half the amount. The opinion of the beekeeping world is somewhat divided on this whole question; but certain it is that he who winters outdoors should provide twice the amount of stores, or at least see that his colonies, after the main brood-rearing has ceased, have from 20 to 25 lbs. of sealed stores. The beginner will need to weigh up his combs for the first colony or two, to be able to estimate approximately the stores of other colonies.

As a general thing an eight-frame colony should be crowded on six combs, and a ten on an eight. The division-board must be shoved up close to the frames, and empty space, if any, filled with leaves or other packing material. It is desirable that bees have stores given to them at least a month before they go into their winter sleep, so they may have a

winter nest around which will be sealed stores within easy reach. As to quality, there is nothing better than pure granulated-sugar syrup, although any good first-class table honey, if well ripened, will give as good results. Many beekeepers pursue the policy of extracting all the honey and feeding sugar syrup. At the present price of sugar and honey one can afford to do this; and, moreover, the very act of feeding will stimulate rearing young bees. This in itself is worth all its costs.

Although a colony has sufficient stores by the middle or latter part of August it may run considerably short by the first of November, especially if a fall flow induces brood-rearing. In any case it is well to go over the colonies just prior to the final preparation for winter, and make sure they do not run short. This is very important as many a colony has been lost through starvation when their owner supposed they had enough to last till spring.

BEES FLYING OUT ON CHILLY OR COLD DAYS AND APPARENTLY DYING ON THE GROUND.

In a late winter or early spring, bees will very often fly out on a bright day, whether it is very warm or not. They alight on the ground or some object, become chilled, and apparently die. Cases are on record where bees have flown out, alighted on the ground, become stiff and cold, and were apparently dead. There was one instance in particular of this kind where thousands of bees had flown out and lay on the ground apparently never to return. A cold rain set in and then it began to freeze, followed by some snow. This freezing weather lasted for a couple of days. This was followed by warm sunshine, when, wonderful to relate, those dead(?) bees came to life, took wing, and flew back to their hives. Other authentic reports, showing something similar to this have been sent in. It seems almost unbelievable, but the facts are, that bees can fly out, alight in the snow, chill through, and seem to be dead. If the snow is not too deep it melts away so that the bodies of the bees can become

warmed up, when they will often revive; they always revive, if it is warm enough, and they have not been chilled too long.

Beekeepers have written in at many different times, fearing that their bees had flown out in late fall, and, becoming chilled on the ground, were utterly lost; but when a warm day comes on a little later, these bees, if it has not been too cold, will return to their hives.

Old Dame Nature seems to have made some wonderful provisions to preserve bee-life. We are therefore constrained to believe that bees can stand, under some conditions, chilling cold for some days without killing them.

WINTERING IN CELLARS OR SPECIAL REPOSITORIES.

In discussing methods for wintering bees outdoors, we have already given some principles that apply to cellar wintering. In the first place, we may say that bees do not require more than 10 or 15 lbs. of stores per colony, although it is an advantage to have more, because it is difficult to feed bees in the spring. With a strong force of young bees and good stores we are well equipped to winter bees in the cellar, provided we have reasonable control of temperature and means for ventilation. Before we go into the general subject of cellar wintering it is, perhaps, important to specify two or three

IMPORTANT REQUISITES FOR A GOOD BEE-CELLAR.

First is the *control of temperature*. The ideal temperature is about 45 degrees F. It may go up to 50 or it may go down to 40; where possible the extreme should not exceed these figures. A greater variation early in the winter does less harm than later. As the winter approaches spring it becomes increasingly important that the temperature be held as nearly as possible at 45. When we say 45 we mean the reading of a *tested* thermometer. Cheap thermometers are often worthless for cellar use. If the temperature goes too high the windows should be opened at night—never in

day time—to let in air, and closed just before daylight. If it becomes too cold, so the temperature goes down below 40, or near freezing, artificial heat must be used. To that end a small stove connected with a chimney may be used to advantage. Build just enough fire to raise the temperature to 45 or a little more. As a general thing it will not be necessary to have a stove; for enough bees in the cellar will keep up the temperature by their own body heat. If a repository during the winter can not be kept cool enough by opening the windows at night, and closing them in the morning, it goes to show very plainly that the beekeeper should adopt outdoor wintering, as his climate is not cold enough to keep a cool cellar. A cellar that has a tendency to be too warm most of the time is a very poor place in which to winter bees. But one where the temperature can be kept uniformly at 45, not varying more than two or three degrees through the day, will not require so much ventilation as when the range is greater. Such a cellar must be mainly under ground, and should have double doors to shut out frost, as well as double windows, if any. A uniform temperature of 50, with plenty of ventilation to the cellar, will give equally good if not better results.

It is important that the cellar be kept dark at all times; and by *dark* we mean absolutely so, without any light penetrating anywhere.

It is important, also, that the cellar be reasonably dry, although bees have wintered fairly well in damp cellars. If it is damp, the bottom muddy, and the temperature down much below 45, the effect on bees will not be satisfactory.

VENTILATION.

The question of air change depends almost entirely on the temperature of the cellar and its control. If the mercury can be kept uniformly at 45 throughout the entire winter with not more than two or three degrees variation it may be said that very little ventilation of the cellar will be needed; but if it has a tendency to go to 50 or more, then down, and especially if the bees begin to roar, showing uneasiness,

then it is *very* important to let in large quantities of fresh air by opening the cellar-windows at night, or through sub-earth ventilators, as used by some. But if windows are opened they must be closed before daylight in order to shut out light. Some have found it better to let fresh air into an outer cellar and from there into the inner cellar where the bees are. It has been argued that air directly from outdoors has a tendency to stir up the bees; yet we have not found it so. Our experience is that, when bees are uneasy by being too warm, it is also because the air is foul. The obvious remedy is to let in cool air from the outside to reduce the temperature, and at the same time supply fresh oxygen.

Cellars should be large in proportion to the number of bees kept in them. A room 12 by 12, and 7 feet deep, will winter 50 colonies much better than it will 100. Ten colonies will come through in better condition than 50. The reason of this is simply a question of pure air. In some cases one may have access to a larger cellar that opens up into other compartments. If these compartments are not used, leave the doors open so that the air of the entire cellar can be available for the bees. A bee-cellar only 10 by 10, 7 feet deep, should not be used to winter more than 100 colonies, and will give better results with 50. A larger number may, of course, be crowded in, and will winter properly if enough ventilation can be given both day and night, keeping the temperature down to about 45.

SUB-EARTH VENTILATORS.

The sub-ventilator should be from four to six inches in diameter, made of glazed tile, about 100 feet long, and from four to six feet below the surface of the ground. The outer end is brought to the surface of the ground, and the inner opens near the bottom of the cellar. Cold air entering the ventilator is warmed in passing under ground and until it enters the cellar, not only supplies the latter with pure air, but at the same time raises its temperature several degrees.

SPECIAL REPOSITORIES OR A CELLAR UNDER THE HOUSE.

The ordinary cellar under a dwelling-house often affords excellent conditions for wintering bees. Where a furnace is used it should be shut off from the bee part by means of a brick wall having a door. Should the bee-cellar get too cold the temperature can be raised by opening the door leading into the furnace-room. When too warm, one can open an outside window; or, perhaps, better still, swing wide the cellar-door leading into the furnace-room, and thence, when tempered, into the bee-room. Hives properly shaded to shut out the direct rays of light will permit the doors left open day and night. If the temperature in the bee part can thus be maintained approximately at 45, the conditions for wintering will be ideal, for a perfect bee-cellar is one where the temperature can be held at about 45, and fresh air admitted every hour of the day. But if opening the cellar-door reduces the temperature that is otherwise uniformly at 45, or causes it to rise, it would be better to keep the bee-cellar closed—not because the ventilation does harm, but because the change of temperature does. House cellars are very often too small, perhaps lack room to put in bees and vegetables. And right here let us say it is a bad practice to put bees and garden truck together in the same room. They should be kept separate.

Objection has been raised that the noise overhead in the house cellar disturbs bees; but no absolute proof has been adduced to show this. We have had some excellent results in wintering in a bee-cellar under a machine-shop where rumbling machinery every now and then was accompanied by the bumping of heavy castings. We have never been able to discover that this noise interfered with good wintering in that cellar.

But where a house cellar is damp, too small, too cold, too warm, or too something else, it may be well to construct a special repository for the bees. This should be located in a side-hill if possible. A little later on we give illustrations of cellars used by some extensive beekeepers; also other schemes of ventilation.

ARRANGEMENT OF HIVES IN A BEE-CELLAR.

They may be piled up one on top of another in such a way that any one can be removed without disturbing more than the one or two above it. The reason for this will be apparent later. Strong colonies should be put in first, and placed on a 2 x 4 scantling. On top of these may then be placed the weaker ones. This has no special advantage except the convenience of having the heavy ones at the bottom and the light ones on top. The entrances of the hives should be left about the same as they were during the late fall— $\frac{3}{8}$ deep by 8 inches wide. Some consider it essential to remove the bottom of the hives entirely. Others consider it good practice to have a deep space under the frames by raising the hive off the bottom in front and supporting it there by a couple of blocks. But some disastrous results in wintering seem to show *us*, at least, that too much bottom ventilation is bad unless the cellar is kept at a temperature of about 60 *and thoroughly ventilated*. The bee is essentially a warm-blooded animal. We have uniformly secured the best results with a reasonably small entrance, or one about the size used during the fall or late spring. The larger the colony, of course the larger the entrance that will be required. In the case of a strong populous colony we would have the entrance $\frac{3}{8}$ deep by the full width of the hive. The colonies of medium strength should have the entrance reduced accordingly.

INSPECTING THE BEES DURING MID-WINTER; AND DEAD BEES ON THE CELLAR BOTTOM.

Experience has proven that, when the temperature is maintained at 45 degrees, very little attention need be paid to the bees, especially in the fore part of the winter. But during the last month or two of confinement the bees require watching more carefully; for if they get to roaring many of them will be lost. It then becomes necessary to make frequent examination to determine the temperature and the quality of the air. It will also be found, perhaps, that a

good many dead bees will be found on the cellar bottom. While this is not necessarily a cause for alarm, it is not as it should be. If the cellar and temperature are right there will be very few dead bees, but if they accumulate their dead bodies should not be allowed to stench the living bees, but should be swept up perhaps every two or three weeks and removed.

A disposition to roar should be met by more ventilation, and at the same time the temperature should be reduced. If all the colonies in the cellar should become uneasy during mid-winter it is evident that something must be done at once or the whole lot of bees will be lost. They ought not to become uneasy until late in the spring. If they can not be quieted by infusion of fresh air it may be best to give the uneasy colonies a flight on the first warm day by setting them outdoors and letting them stay there for 24 hours or until they can clean themselves. Dysentery or diarrhea in the bee-cellar is generally the result of too much cold air or too high a temperature, either of which will induce too large a consumption of stores; and where bees are not able to void their feces, the intestines become distended, resulting in purging. A colony so affected should be removed as soon as a warm day comes.

WHEN TO PUT BEES IN THE CELLAR, AND WHEN TO TAKE THEM OUT.

This is a question that depends entirely on locality. Most bees go into the cellar in the Northern States anywhere from the last of November until the first of January; but usually it is advisable to have all bees in before Christmas. As to when the bees should be taken out of the cellar, authorities differ. Some set them out in March, and then put on winter cases. Others believe it is better policy to keep bees in late or until the last cold weather is past, and then set them out. We would advise taking the golden mean, waiting until the time natural pollen comes, or, in our locality, soft maples bloom. But when bees are uneasy in the cellar it is advised to set them out earlier than otherwise.

TIME OF DAY TO TAKE BEES OUT.

The usual plan for taking bees from a cellar in the spring is to wait until fairly settled warm weather has come, and then on some warm bright day all the colonies are removed at once. The great trouble with this method is that the bees are likely to become badly mixed, owing to their eager flight without carefully marking the location. This results in a bad state of affairs, and should be avoided.

Another method followed to some extent is to put some of the colonies out during an evening when all appearances indicate that it will be warm and bright the next day. A third of them, perhaps, are taken out, and these fly quite well the next day. The next evening another third is removed, and the last third the night following. The great trouble with this plan is that the bees removed first get to flying well and then start to rob colonies taken out later, thus making a fearful uproar.

Mr. E. W. Alexander, in *Gleanings in Bee Culture*, page 286, Vol. XXXIV., gave a plan open to none of these objections. In his own words it is as follows:

“First, get every thing all ready for a big job, and watch the weather closely, especially after a few nice days, for it is quite changeable at this time of the year. Then when the wind gets around in the east, and it commences to become overcast with heavy clouds, and has every appearance of bad weather for the morrow, we commence about sundown and carry out all our bees—yes, even if it takes not only all night but into the next day; and if it commences to rain before we are done, all the better, for we don't want any to try to fly until they have been out two or three days if we can help it. By this time they will have become nice and quiet; and when a fair day arrives they will commence to fly, only a few at a time, and get their location marked, so there will be no mixing up or robbing, because they all have their first fly together. Then when the day is over we find by examining our hives that nearly every one has apparently retained all its bees.”

SHALL WE PUT THE COLONIES BACK ON THE OLD STANDS IN SPRING?

There is this advantage in putting the colonies back on the stands occupied the previous season: Mr. H. R. Boardman letters each row in his apiary, and numbers every hive, each body and bottom-board bearing the number and the letter of its respective position. In the spring, in carrying bees out he is able to deposit his hive right where it was the preceding fall. "C6," we will say, is to go directly to the C row, and on arrival it is replaced on bottom No. 6. Mr. Boardman does not attach very much importance to bees being put back upon their old stands; though if he can, just as conveniently, he prefers doing so, because some old bees will go back to where they were the previous fall.

CARRIERS FOR HIVES.

A wheeled vehicle is not as good for moving bees in and out of a cellar as some sort of carrier. There are several good ones, and we here show a few.



For hives without projections a pair of U-shaped wires bent to form a sort of bail answers nicely. The bottom hooks catch on to the bottom of the hive as shown.

Dr. Miller uses a rope as seen in the next cut. Of course, it can be used only when the hives are cleated at the ends.

Where hives are carried any distance, and help is scarce, the yoke can be used. One man can carry two heavy hives

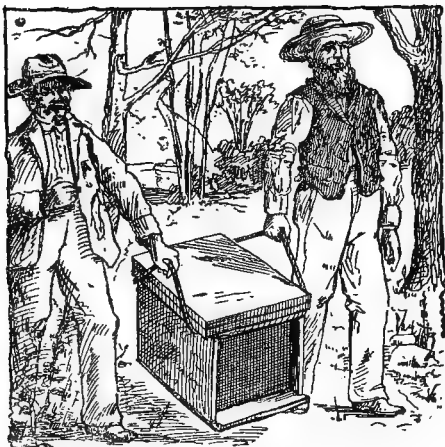

Miller's rope carrier.

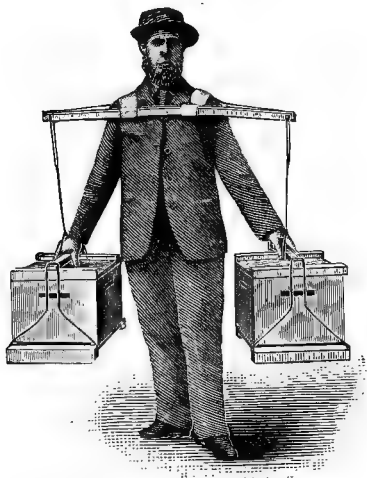

McFarland's neckyoke for carrying.

quite easily, descend cellar-steps, and go through doors. The only objection is the rigging, and loading and unloading.

The particular form of hive-carrier preferred by many is the one described by Mr. G. C. Greiner and several others in *Gleanings in Bee Culture*. This is presented in the following illustrations.

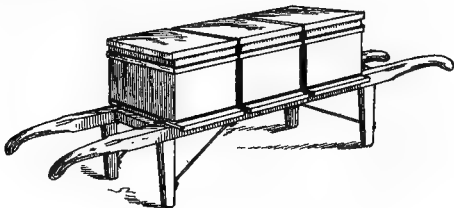

Greiner's hive-carrier.

Two men can easily carry as many as five hives in this way. Where the cellar is located some little distance from the apiary we believe this to be the most convenient method yet devised.

Instead of constructing a regular hive-carrier as shown, it is possible to get along quite well by the use of two poles. See illustrations, this page. These should be about two inches square and six or eight feet long. They are placed on the ground in a parallel position, and as many hives placed on them as can be carried; perhaps three hives would be all that could be managed easily with the poles. It is much more satisfactory, however, to have the poles nailed together with a framework, making a regular hive-carrier.

A FEW CONCLUDING FACTS ON INDOOR WINTERING WELL TO BEAR IN MIND.

1. Too low a temperature (below 40 Fahr. if long continued) in a bee-cellar will kill bees.
2. An excess of dampness in a cellar does no harm, necessarily, providing that the temperature is high enough, not lower than 45 or 50,



Carrying hives on two poles.

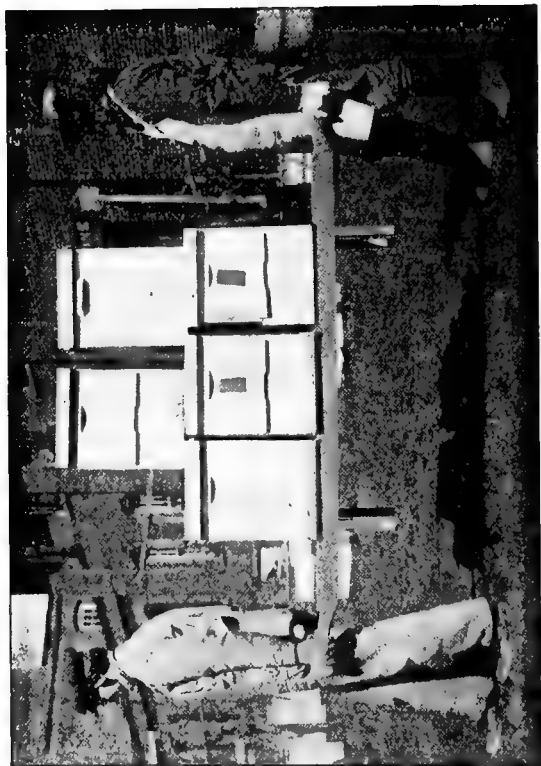

Carrying hives from the cellar at "The Home of the Honeybees."

3. A low temperature, lower than 40 Fahr., and an excess of dampness, is a very bad combination, and will kill bees almost invariably. A high temperature, above 45, *but little or no ventilation*, will cause the bees to be uneasy. If the temperature is above 45 there should always be some ventilation. It should be continuous rather than intermittent at night, but better intermittent than no ventilation.

4. Bees can be wintered in a cellar without much ventilation, providing the temperature is held uniformly between 43 and 45, but they will winter much better if there is some fresh air.

5. A cellar may be too dry, for bees in a cellar require a little moisture. If there is no moisture, possibly a wet sponge should be put in front of the entrances of some colonies.

6. Ideal conditions are, a nearly uniform temperature of 45 Fahr., a slight amount of moisture, *continuous* ventilation, and absolute darkness.

7. A very bad combination is a constantly varying temperature that goes down nearly to the freezing-point and then rises sometimes to 50 and 60 degrees. Such a variation is almost sure to cause disastrous losses before spring.

8. A high temperature, between 60 and 70, requires a great deal more ventilation than a temperature of 45. The higher the thermometer the more fresh air there should be. Too much can not be given when the thermometer shows 65 degrees.

9. The statement has gone out that bees do not need ventilation in a bee cellar. Fair results are sometimes secured with only the air that percolates through the walls when the mercury can be maintained at 45 degrees, or within two or three degrees of it; but far better results are obtained when there are continuous infusions of fresh air through ventilators or doors or windows.

10. Occasional disturbance from the beekeeper entering the cellar does no harm.

11. Where the conditions in a cellar are such that there will be anywhere from three to four or even six inches of dead bees on the cellar bottom in the spring we should say that the owner of that cellar ought to investigate and ascertain the trouble. No matter if he does bring his colonies through alive, it could hardly be said that he is wintering his bees successfully. An ideal cellar is one that will bring the colonies through the winter in practically the same strength as when they went into winter quarters. We have seen a good many cellars where all the dead bees that would fly out on to the cellar bottom would not in the spring make a coalhodful to the hundred colonies. We have wintered bees at Medina time and time again in one of our cellars so successfully that one could walk across from one end of the cellar to the other in the spring and scarcely step on a single dead bee. Do not let any beekeeper get it into his head that these old bees are superannuated and would die anyway. In any cellar where the conditions are such that there will be two or three inches of dead bees on the cellar bottom in the spring, there is something wrong.

12. Honey-dew or very inferior or an unpalatable or poorly ripened honey may cause dysentery before spring, even when all the other conditions are ideal.

13. Pollen in the combs does little or no harm. The old theory that pollen was the cause of much of our winter losses is now an exploded myth.

14. The size of entrances will depend upon the character of the cellar.

15. Shutting bees in the hives with wire cloth is usually attended with uneasiness; and, unless removed, there will be severe mortality.

HOW AND WHAT TO FEED BEES DURING MID-WINTER.

It is advisable to avoid feeding any syrup during mid-winter, because it has a tendency to stir up the bees, causing

them to consume too largely of their stores; and, as they can not take a cleansing flight, dysentery is likely to follow. Moreover, the feeding of a single colony in a cellar is apt to stir up, by its roar, the other colonies near it.

When an outdoor colony is running short it should be given a comb of sealed stores. To avoid disturbing the winter nest this should be given directly on top of the brood-frames laid upon a couple of sticks. On top of the comb should be placed two other strips and then the packing-material. A comb may be given in the same way in the cellar, but it would be more practicable to take out an empty frame and put the one containing the stores in its place.

If one does not have any combs of honey he may give rock candy, provided it has not been scorched or burned, or any kind of bee candy.* If the candy is the same as that used in queen-cages, or what is called Good candy, it should be put in shallow trays like paper or wooden pie-plates, so that, in case it becomes soft, it will not run down over the combs, thus daubing the bees, and ultimately destroying the colony. There is always danger that a soft candy may do this, and hence we advise a hard candy. We have discovered that the use of a little honey makes a better candy. But do not use too much. One pound or a pound and a half of honey to 20 lbs. of sugar will be about the right proportion. It is very important that the mixture be not heated to a higher temperature than 280; and for this purpose a candy-thermometer should be used.

It is a nice art to make hard candy, and perhaps some would not care to undertake it. One or two reports seem to show that loaf sugar may be laid on top of the frames. In winter there would be enough dampness to keep the sugar moist. For summer feeding it would have to be dampened perhaps.

* I have become satisfied that a candy is safer than a syrup for *winter feeding*, especially by the novice. In fact, I am so sure of that and of its greater economy in material, in bee life, and manual labor, that I doubt if I ever again use much syrup. Soft sugar for stimulating and candy for cold weather. Even though soft sugar be safe for winter it takes too much labor to adjust feeders and bees. An inverted feeder of candy on top is instantaneous and economical.—A. C. M.

It has been argued by some that bees should not be fed in the cellar during midwinter, as it will be sure to kill them. But this has not proved to be true when candy is given. Some weak colonies put into the cellar, fed with hard candy, as here explained, have reared brood during all winter, and have come out in the spring very much stronger than when they went into winter quarters. The feeding of *liquid* syrup, however, might and probably would have a disastrous effect.

BEE-CELLARS VARIOUSLY CONSTRUCTED.

Having stated the general principles of cellar-wintering, we give views and descriptions of some of those used by men who are very successful in wintering.

Mr. N. D. West, of Middleburgh, N. Y., has been very successful in wintering bees in ordinary cellars under dwelling-houses. He prefers to have the bee-room separated from the outside door by another room, possibly a vegetable-room, so that the temperature may be controlled more easily. The door between the two rooms may be left open most of the time, although it can be closed when necessary. An outside ventilator is used through an opening in one of the windows. A wooden box is made 8 inches square and about 2 feet long. This extends through the window, and the outer end is built up so that the whole ventilator assumes the form of an elbow. The outer opening, which may be about 3 feet from the ground, is then covered in such a way as to keep out the rain and snow, but still allow space for foul or warm air to escape from the bee-room. Any openings that would admit light are closed so as to make the room dark and warm. Mr. West thinks it is advisable to have a spring of running water in one corner, if possible, that the temperature may be kept constant.

In placing his hives in the cellar, he does not take off the bottom-boards. He makes a platform about four inches above the cellar-floor, and puts one row of hives on this with the back ends resting on a 2 x 5, so that they are four inches higher than the front ends. The next row of hives is placed

on top of this row, although set back just a little so that the tiers will not fall over. As will be seen, all the hives will be so placed with the entrances at least four inches lower than the back ends of the hives, so that any dead bees may be easily cleaned out. See illustration.



How N. D. West arranges his hives in the cellar.

Harry Lathrop, of Bridgeport, Wisconsin, uses a stone bee-cellar built in a side hill. There are two rooms in the cellar, or, more properly speaking, a main room for the bees and a smaller one used as a vestibule. He thinks that, in some cases, it is advisable to have a stove in the vestibule. If there is a small opening at the top of the vestibule leading into the bee-room, and another opening at the bottom, artificial heat will cause a circulation. The air can be kept fresh by opening the outside door at intervals. An oil-stove should

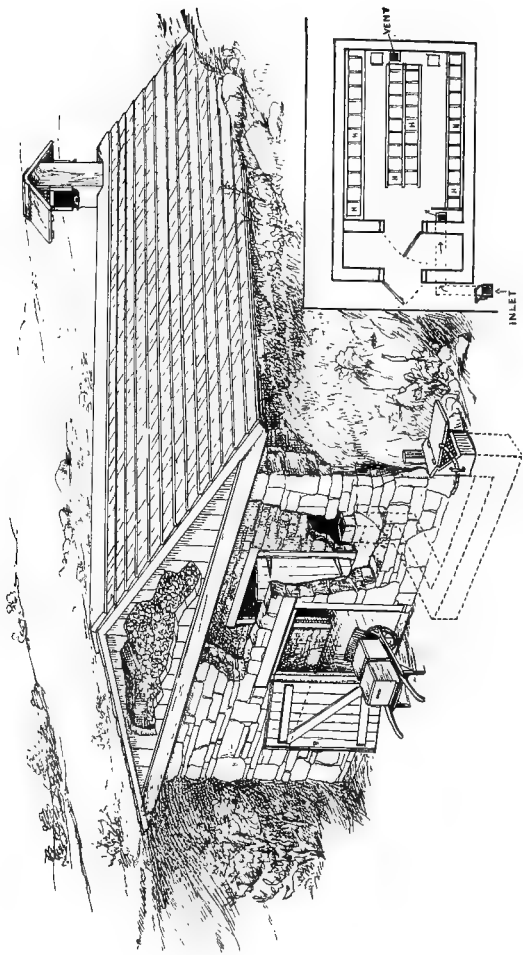

Hatch bee-cellar—dimensions of (ventilator) inlet, 6 x 8 inches; outlet, 8 x 10 inches.

not be used, ordinarily, for the resulting bad air will be worse for the bees than the cold.

With a properly constructed bee-cellar, there should be no need of artificial heat; but, nevertheless, it is best to have the cellar so arranged that a stove can be used if necessary.

The illustration given here at the bottom shows Mr. C. A. Hatch's plan for a bee-cellar. It will be seen that the beeroom is almost entirely under the ground. The space between the ceiling and the roof is filled with leaves.

Mr. Hatch thinks it is advisable to have a cellar near the apiary, and built in a side hill if possible. If the entrance is on the level it is very easy to wheel colonies in and out. He believes that a cellar 12 by 16 feet, inside measure, would be ample for 100 colonies in ten-frame hives, or for 120 colonies in eight-frame hives.

An important point connected with the Hatch bee-cellar is the double entrance, or vestibule. In this way the temperature can be regulated very easily. A temperature of 45 degrees Fahrenheit is considered ideal, but it is probable that a rise or drop of five degrees does no great harm unless continued more than 24 hours. Mr. Hatch agrees with Mr. France in thinking that the three essentials for safe wintering are good feed, proper temperature, and young bees.

HOLTERMANN'S BEE-CELLAR.

One of the largest bee-cellars, as well as one of the best designed, is owned by Mr. R. F. Holtermann, of Brantford, Ont., Canada, an extensive beekeeper of that province. The cellar is made wholly of concrete, and, what is of particular interest to beekeepers, has a scheme of ventilation that is almost ideal. It is not only theoretically perfect, but practically gives results in wintering that can scarcely be surpassed.

The authors have seen this cellar, and, notwithstanding there were about 500 powerful colonies in it at the time, there was perfect quiet and apparently perfect wintering. The temperature was about 43, and the air was pure and



Hull's bee-cellar, built in a side-hill; capacity 200 colonies. ●



Rear view of Hull's bee-cellar.

sweet. Scarcely any dead bees were found on the cellar bottom.

The bottom illustration on next page shows how his big twelve-frame colonies are piled up, having the ordinary entrance and a honey-board on top.

The sub-earth ventilator, in the diagram opposite, extends under the ground several hundred feet away from the building where it comes to the surface. At the other end it passes under the floor of the cellar, then, up into a small room in which is placed a stove. From this compartment or room the air is distributed all around the cellar by means of a square wooden pipe suspended from the ceiling. Foul air is taken out at the bottom of the cellar by means of flues reaching down from the roof of the building to within a foot of the cellar floor. The upper story of the building is filled with hives and supers, being, in fact, the place where general shopwork connected with the yard is done.

Right here we can do no better than to give Mr. Holtermann's description.

DESCRIPTION OF THE CELLAR.

The bee-house is of concrete—even to the chimney. This has a cowl on top, which veers its back to the wind to assist in getting a draft. On each side of the chimney is a box ventilator projecting through the peak of the roof. This is 12 in. square, with a slide to regulate the amount of air passing through. These shafts enter the cellar at the ceiling above, and are for warm weather. The building is 50 ft. long by 25 wide. The cellar walls are below the level of the ground, in order to get a more uniform temperature from the earth, and less liability for moisture to condense on its walls.

The cellar-ceiling, to secure uniformity of temperature and prevent condensation, has, as seen in the perpendicular-elevation plan, Fig. 2, G, a tongue-and-groove floor; C, E, felt paper; D, air-space; C, tongue-and-groove floor; F, floor of the cellar, is concrete. The only openings from the outside into the cellar are seen in Fig. 1. From B to A are two glazed waterlime-jointed tiling, coming above ground just outside of the bee-house at B B, the wall going down 8 ft. into the ground; then passing under the cellar-wall and floor, entering the cellar at points A, A. Then there is a stairway, C, which is covered by two doors at the level of the ground, and again closed from the cellar by two doors. Through these doors the bees are brought in and out.

D is a 12-inch glazed pipe with waterlime joints 8 ft. under ground. This enters the cellar in the compartment E, a coal stove standing over this opening. In this compartment, if the air is not sufficiently tempered by its passage under the ground it can be warmed before it passes into the cellar.

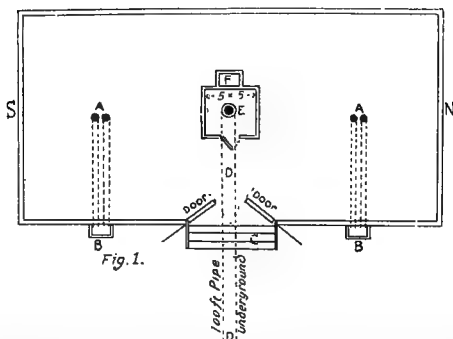

Ground plan of cellar. Inner compartment E has solid concrete walls extending to ceiling. Opening E communicates with a sub-earth ventilator, D. When in-rushing air is too cold a fire is built in the stove, tempering the air; then it passes upward to the ceiling, and into the square-box wooden flues shown at D D D D, in Fig. 3, where it is distributed to every point in the cellar.

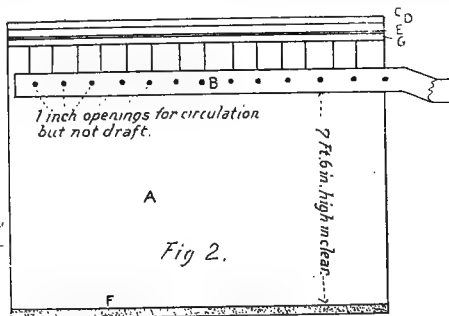

Perpendicular elevation of bee-cellar, showing the square-box ventilating-flue with its one-inch holes as shown in diagram 3.

In Fig. 3 the system of distributing fresh air is shown. The illustration is not quite correct as to the central compartment, however. B is supposed to be the same central compartment as E in Fig. 1, and the distance between it and the west wall should be greater. At the top of this compartment, on the west side, are pipes, D, D, D, which carry the fresh air to the north and south end of the cellar, E E respectively being the north and south ends. From there through many one-inch openings (see arrows also, in B, Fig. 2, and the method of turning the corner of the wall), the fresh air is evenly distributed through the cellar and carried off in a more or less foul condition through openings in the bottom of chimney F, in Fig. 1, and at ventilators F F, in Fig. 3, said ventilators showing through the roof on either side of the chimney shown in the exterior half-tone view of the cellar.

I have a curtain this winter on the north, south, and west walls, and find it assists in equalizing the temperature. This winter I have had more or less air passing through all the air passages, yet have kept up a sufficiently high temperature half the time without a fire.

Two years ago I darkened all the windows in the bee-house above, and partially opened a trap-door which leads by means of a stairway alongside of the center compartment to the cellar floor. This, however, gave too rapid variations in temperature and was abandoned. During the last strong gale, with the wind reaching a velocity of over 60 miles an hour, within 24 hours a change from 59 to 12 degrees was experienced; while there was a variation of only 2½ degrees in the cellar without any alteration of the ventilating dampers.

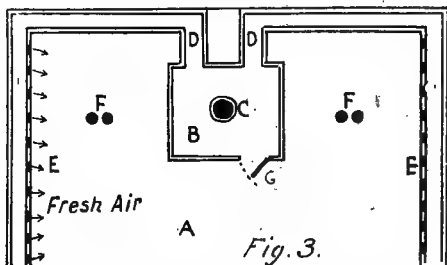

Horizontal plan showing scheme of ventilation. Room B has solid concrete walls to prevent danger from fire from the stove at C. Under the stove is the sub-earth ventilator opening that supplies fresh air, which, if too cold, is warmed and then forced through the distributing-flues D D D, which are perforated by one-inch holes. The flues D D are closed at the ends, and all air must pass out at the holes indicated by the arrows. F F are ventilators carrying foul air and moisture by means of flues extending through the roof.

A few pages back we explained that Mr. Holtermann is not now using this bee-cellar. The reason for this is not because he could not winter successfully, but rather because

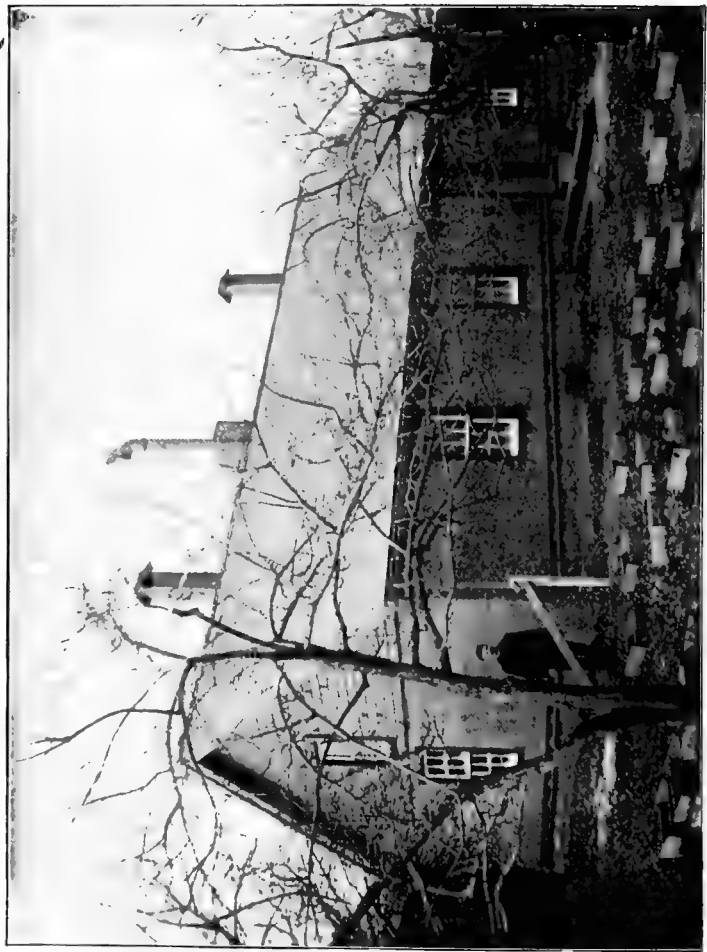

Holtermann's concrete be-cellar and workshop.



Interior view looking down the aisles of the Holtermann beehive.

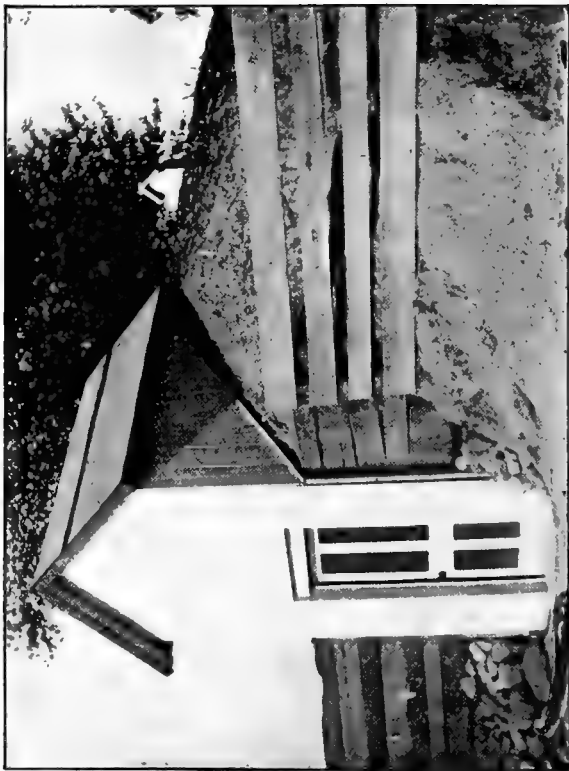

Davison's concrete beehive.

he was away from home all winter. He was compelled to adopt a method that would permit him to put the bees into winter quarters in October, and leave them there without further attention until the following spring. See what he has to say on the subject a few pages back.

But in view of the fact that the Holtermann cellar is the most elaborate and best-appointed bee-cellar that was ever constructed in this country or Canada, we preserve its description with illustrations because there are doubtless some who may be compelled to winter indoors where even the tenement plan of outdoor wintering would not be adequate to protect the bees from the severe cold that might prevail in the locality.

WINTERING BEES IN CLAMPS.

In parts of the country where the soil is sandy and porous, bees are often wintered in trenches dug in the ground. These are about 18 inches deep, large enough to hold two rows of ten hives each. The hives are set upon 2 x 4's to keep them off the ground. Three of these are used, one at each side and one in the middle, with the flat or wide side down. The bottoms are removed from the hives, and the covers raised half an inch or so to provide upward ventilation. About 18 inches of straw is thrown over the hives, and then the dirt is shoveled on. The engravings shown on next page illustrate the plan as practiced by E. D. Townsend, of Remus, Michigan. The first engraving shows the dirt partly shoveled away and some of the hives removed. The next illustration shows all of the hives removed in the spring from the pits or clamps, and set on their summer stands. It would seem as though there ought to be some provision made for ventilation; but when it is remembered that the soil is sandy and very porous, it is seen that this is not necessary. This plan can not be made use of in a location where the soil is composed largely of clay. Mr. Townsend thinks that it is well to have surface drains along each side of the pits to carry off any water that may come that way.



Wintering colonies in clamps or trenches dug in the ground.—From *Beekeepers' Review*.

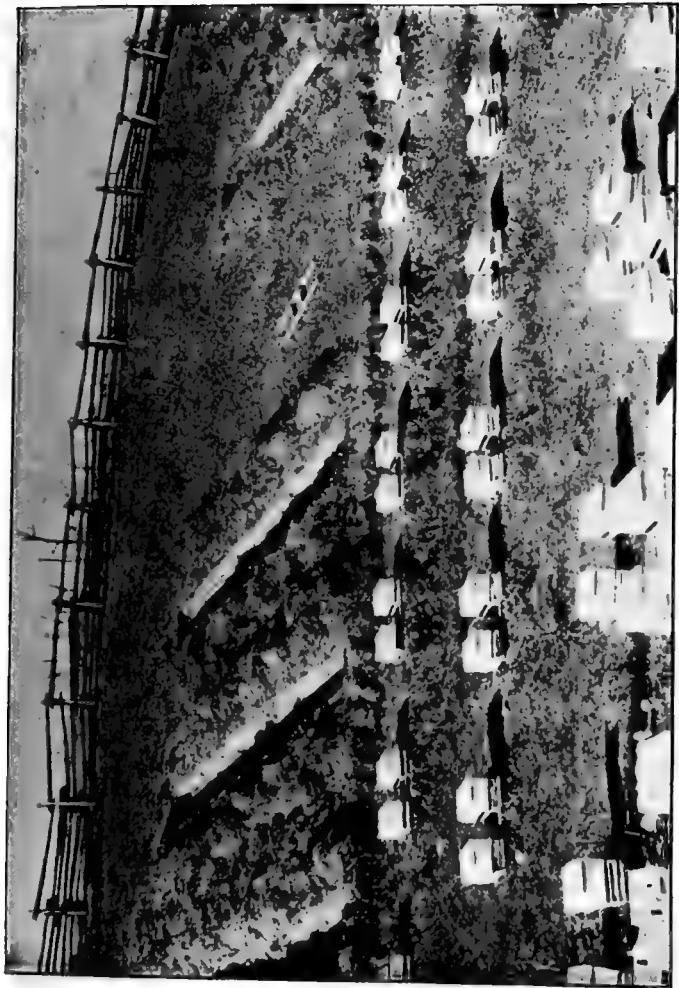

Colonies just removed from the trenches in the spring.—From *Beekeeper's Review*.

DO BEES HIBERNATE?

We have spoken of the quiescent state or sleep into which bees enter when the wintering conditions are ideal. In this period of semi-hibernation the bees seem merely to exist. With no activity the consumption of stores is very light. As the reader may wish to pursue this subject a little further we have thought best to take it up to help solve some of the wintering problems, and, perhaps, lead to some good results from an economic point of view.

Hibernation was exploited about 30 years ago, when it was generally decided, and rightly, too, that bees do not hibernate in the ordinary sense of the term (see *American Bee Journal* for 1885). But they do enter a quiescent state when the temperature has been lowered; and this state is somewhat analogous to the torpor experienced by some animals in a state of true hibernation, during which no food is taken, and respiration is considerably reduced. Dr. Marshall Hall has stated that "respiration is inversely as the degree of irritability of the muscular fiber." If the respiration is reduced without this irritability being increased, death results from asphyxia. Hibernation is usually induced by cold, and the animal under its influence attains nearly the temperature of the surrounding atmosphere, yet can not resist *any* amount of cold, although its capacity for doing so varies according to the animal. Some animals bury themselves in holes, like snakes and frogs; others, like the bear, crawl under a pile of leaves and brush where they are still further covered with snow. Thus buried they will go all winter without food or water; but there is a waste of tissue. Fish may be encased in ice and still live, it is said. A lively frog may be dropped into a pail of water four or five inches deep, and exposed to a freezing temperature. Indeed, there may be a thin coating of ice formed over the animal. The next morning, that frog, though stiff and cold, can be warmed up into activity, but to freeze solid will kill the creature.

Flies, as is well known, will secrete themselves in window-frames and other hiding places, subject to cold atmosphere,

for weeks at a time, and yet revive on exposure to warmth. As is well known, also, ants have been repeatedly dug out of logs, frozen solid—in fact, fairly enveloped in frost; yet on exposure to warmth they will come to. Some hibernators can endure a freezing temperature, while others, like the bear, woodchuck, and the like, can not. Other very interesting incidents may be taken from natural history; but the purpose of this article is to consider whether bees go into a quiescent state that *approaches* hibernation, in which there is low respiration and a small consumption of stores.

Two or three years ago we put a number of cages of bees with some queens (laying the cages down on cakes of ice) in a refrigerator. The bees were chilled to absolute stiffness. Every day we would take out a cage, and each time the bees would revive, including the queen. This thing was continued for several days, and yet the bees would “come to” each time.

The strange part of it was, that the queens went on laying normally when put back in the hives, instead of laying drone eggs as we expected. Just what the temperature to which these bees were subjected was we can not say—probably something below 40 and something above 35, for the doors of the refrigerator were frequently opened, and the ice was constantly melting.

During one winter, when a very cold snap came on—the temperature going down to zero—we put out some cages of bees, exposing them to the cold wind, which was then blowing a pretty good gale, when the temperature was 5 above zero. We had expected that the bees possibly might be able to survive the shock for a number of hours, and yet revive; but 20 minutes of zero freezing was sufficient to kill them outright. If we had taken the bees and gradually acclimatized them to the cold, first subjecting them to 40, then to 35, and gradually down to the zero point, they would possibly have withstood the shock.

When the weather warmed up a little we took several cages of bees and buried them in the snow, leaving with them a thermometer so that we might know the absolute

temperature. We went out and got a cage of bees about every two or three hours, and we found that we could revive them without difficulty; but at the end of 24 hours the bees, when they "came to," seemed somewhat the worse for the experience. The temperature in the snow played around the 32 mark. But the experiments conducted during the summer would seem to show that bees might stand a temperature of 38 for a number of days.

We know it to be a fact that the bees on the outside of the ball or cluster, in an out-door-wintered colony, will often be chilled stiff while those inside have almost a blood temperature. It has occurred to us that, during very severe weather, the outside bees may be gradually replaced by those within the cluster; for we know the bees are in constant movement. Experiments show that a starved bee will not stand as much cold as one that is well filled. Beekeepers who have had any experience in wintering outdoors know how repeatedly they have taken clusters of bees that seemed to be frozen stiff, yet when warmed up before a good fire would revive and appear as lively as ever.

In view of the experiments we have thus far conducted, it would appear that bees might be able to stand a temperature of 40, or slightly below that, for a number of days; but if a warm spell does not come within a week, or less, those bees in their chilled condition may starve to death. But if it warms up, the cluster will unfold and the bees take food, and so be ready for another "freeze." The authors have repeatedly seen clusters of bees, after a zero spell, lasting a couple of weeks, that were stone dead; but the honey had been eaten from all around them within a radius of an inch or more. If a zero spell of weather continues more than a week or ten days, we always find some of the weaker colonies frozen to death in the spring.

There are some interesting phenomena in connection with chilled bees—their quiescent sleep, their low respiration, their light consumption of stores—that simulate a condition of semi-hibernation. The bees when in a chilled condition can go only a few days without food, while a bear, a true

hibernator, may go all winter. When the temperature of a bee-cellar goes up to 50 or 60 the bees are active. Their respiration is normal. They must have ventilation, or die in large numbers. If we can maintain a temperature down to 45, with slight variation, there is a state of sleep where the respiration is very low, food consumption slight, and consequently not much fresh air is needed, or not more than what will percolate through the walls of the repository.

There is a practical side to this matter; for if we can induce semi-hibernation or torpor we cut down the consumption of stores.

WINTERING IN THE SOUTHERN STATES.

The directions so far given apply particularly to localities that are subject to zero weather at times, that have more or less of snow, during the greater portion of the year, a large amount of frost in the ground, extending down perhaps two feet.

Where bees can fly almost every day in the year, and for ten months are able to gather a little honey or pollen, outdoor wintering in single-walled hives is recommended. Double-walled hives would do no harm, and would, during the coldest of the weather, save considerable brood. The added expense for the extra walls and packing will be offset by the saving in brood and bees. While we recommend single hives for the southern portions of our country, and for some parts of the West, we always urge that the same be located in an inclosure of trees, a tight high board fence, a hedge, or any thing in the way of buildings that will break the prevailing winds. To establish windbreaks is one of the most important requisites in either the northern or southern portions of the country.

While no great skill is needed to winter bees in such localities as are found in Florida, South Carolina, Texas, Louisiana, Georgia, Alabama, and Southern California, yet one must be careful to see that his bees do not run short of stores, as it seems to be a generally acknowledged fact that bees wintered in the South consume much more stores, ac-

ording to the size of the colony, than in the North. Those in cold climates are compelled to contract into a very small ball for the purpose of concentrating the animal heat; and while in that condition they are in a semi-dormant state, and consume a comparatively small quantity of food. On the other hand, bees in the South, especially in the warmest portions, can have access to all parts of the hive, rear more or less brood, and, as a consequence, when natural flora does not secrete nectar they are liable to run short of stores, and starve. To the Southlander let us urge that the greatest danger is starvation, and the next greatest is more or less of robbing during a dearth of honey. Indeed, all things considered, we believe Southern bees require more watching than those of the North.

In localities like Virginia, Tennessee, and other States lying in about the same latitude, it might be advisable to use double-walled hives; yet we know that the majority of beekeepers in that latitude winter their bees successfully in single-walled hives; but we believe it is the general practice to place on top of the hive a super containing chaff, leaves, planer-shavings, or some good warm packing-material; moreover, when the colony is not very strong it is advisable to place a chaff division-board on each side of the cluster. In all cases there should not be given a larger cubic capacity than the bees can comfortably fill, spread out as they usually are on a day when the temperature is not below 70 F.

In Colorado it is customary to winter in single-walled hives. A shallow cap or tray containing a few inches of packing is placed on the top of the hive. Very often, for further protection, a sort of shed or roof, with its back to the prevailing winds, is built over a row of hives. The Colorado beekeepers are troubled with sandstorms and fierce piercing winds; while the temperature may go down below zero, it is not likely to remain so for more than a few hours, when one extreme will change to a temperature of 60 or 70 F., and the bees flying. For such conditions double-walled hives and an excess of packing-material have been found to be not at all necessary.

