

How *to* Attract Wild Birds About *the* Home

By NIEL MORROW LADD

President of the Greenwich Bird Protective Society, Inc.

With an Introduction by CHARLES D. LANIER

TO WHICH IS ADDED

THE FIRST ANNUAL REPORT
of the GREENWICH BIRD PRO-
TECTIVE SOCIETY, INC.

40 Illustrations, Mostly Photographs

PRICE THIRTY-FIVE CENTS



Cornell University
Library

The original of this book is in
the Cornell University Library.

There are no known copyright restrictions in
the United States on the use of the text.

<http://www.archive.org/details/cu31924084882202>



Putting Out Suet

How to Attract Wild Birds About the Home

By NIEL MORROW LADD
*President of the Greenwich Bird
Protective Society*

With an Introduction by
CHARLES D. LANIER

40 Illustrations, Mostly from Photographs Taken by the Author

To Which is Added

THE FIRST ANNUAL REPORT
of the GREENWICH BIRD PRO-
TECTIVE SOCIETY, INC.



Published by
THE GREENWICH BIRD PROTECTIVE SOCIETY, INC.
Greenwich, Conn.
1915

ORNITH
QL
676
.5
L28X
1915

Copyright 1915
By NIEL MORROW LADD

KOZLAY PRESS
BROOKLYN

Introduction

MEN of forty, recalling their childhood, remember that boys then had only one idea when they found a bird's nest—to take the eggs out. If a bird were striking in colors or variety, or for any reason, its distinction was only an added incentive to kill it if possible. Men of forty have seen the wild pigeon, but see it no more. They can scarcely find now one pair of the brilliant, graceful and confiding wood ducks in the romantic haunts where there were hundreds. The handsome cardinal, with his cheery winter whistle, has practically disappeared in many localities where its flashes of color were the commonest sights. In the thousand lovely swales and birch edges of Southern New England the woodcock is now a rare bird save in the few days of migratory "flights," and then there is only a small fraction of the former abundance.

The elegant and beautiful brown thrashers, our glorious "sandy mocking bird," nesting too conveniently low for cats and prying human eyes, had, a few years ago, almost disappeared from hundreds of thickets and fence foliage where the boys who are now men of forty could rely on finding them. The dramatic swoops and booms of the nighthawk, beating the coverts of the evening air and sweeping innumerable insects into his curious mouth, open from ear to ear, can be missed through a whole September now; the writer remembers upwards of 200 being bagged in a single sunset "shoot" in Virginia, in his boyhood. Scores of delicate and interesting small bird neighbors, bent only on adding beauty to the world and doing each his bit in ridding us of ugly insect pests, seemed, a few years ago, to be headed toward the fate of the wild pigeon.

But no one has noticed, in this process of bird destruction, any diminution in caterpillars and the scores of varieties of plant-destroying bugs. There has been no lack of tree and plant devouring insect pests of a hundred kinds. Indeed, while anything like a bug census is obviously impracticable, the same general observation which showed us that the birds were decreasing was equally convincing as to the increase, with equal steps, of noxious insects and their ravages.

This is the bad side of it. The good side of it is that today your boy of twelve has an absolutely different attitude toward bird life from your attitude when you were that age. He knows more about birds than you did, but when he sees a nest of eggs the last thing he thinks of is breaking it up. He begins to worry about red squirrels and cats and blacksnakes, and instead of adding the treasure trove to his egg collection, or smashing the outfit from pure savage instinct—which came to him honestly enough from his hunting ancestors, even though it is high time to change it—he gets his fun from spying on the parent birds feeding the youngsters, and his triumph from seeing the fledglings safely start their flight out into the world.

This is a very wonderful transformation in human habits, to have come about in so short a time. It is not true of all boys, or, in many localities as yet, of any boys. But it is so true of hundreds of thousands of youngsters all over America, and so many oldsters, too, have found a new and fine enthusiasm in actively studying and helping bird life that it is fair to say Americans have in a single generation changed from bird enemies to bird friends.

Writers and naturalists like John Burroughs, Ernest Thompson Seton, Dallas Lore Sharp, Frank Chapman and a score of others have had a chief part in revolutionizing man's manners toward the birds. They have stimulated the imagination and have made study and knowledge easy and attractive. They have furnished every community with a smaller or greater number of bird students and nature lovers.

To make their work count for as much as possible, to organize for big practical results the new enthusiasm for helping bird life, it is absolutely necessary that there should be efficient community endeavor through local societies such as the very successful Meriden Association, and the lusty, if young, Greenwich Bird Protective Society. This first year book of the Greenwich association of bird lovers, which owes its existence and its zest chiefly to the extraordinary and admirable devotion of its president, Mr. Niel Morrow Ladd, is a handbook as well as a year book, and should be a convenient and invaluable guide for anyone who wishes really to do something with any sentiment or convictions he may have acquired as to the beauty, poetry and economic value of the charming feathered creatures about our village and country homes.

C. D. L.

How to Attract and Protect Our Native Birds

IN the following pages the writer has endeavored to present in condensed form the methods which may be used to increase bird life about one's home.

While the list of winter birds is small when compared to the number which arrive in the spring, this season is the best time to commence making one's ground attractive to them. The most timid become brave when hungry, visiting the neighborhood of houses in search of food. At such times they become wonderfully tame, often eating from one's hand.

It is taken for granted that those who read these suggestions are already aware of the economic importance of bird life. For several years past, books, newspapers and magazines, as well as Government Bulletins, have emphasized the necessity of a nation wide conservation of our birds, as a means to lessen the annual loss of \$800,000,000 from insect pests and weeds. It might be well, however, to sketch briefly what the presence of the winter birds will mean to you.

As digestion is so rapid, birds are compelled to keep constantly on the lookout for their chosen food, whether it be an insect or weed seed diet.

A failure of the local food supply forces birds to move to other localities or starve. Therefore, in the winter time, when all kinds from natural sources are scarce, one can attract birds to a given district by furnishing a constant supply of artificial food.

While no substitute we can offer will be as eagerly sought as that which nature supplies, winter feeding tides the birds over the days when ice or snow renders their natural food inaccessible.

For every minute a bird stays at your feeding device, it spends an hour digging out hibernating insects, insect eggs, grubs, beetles, etc., from beneath bark or from decayed tree trunks or branches. If the bird be a seed eater, most of his time will be spent seeking those of noxious weeds.

If your suet and seed attracts many birds, you may be



Downy Woodpecker at Suet



Whitebreasted Nuthatch Eating Peanuts

sure that your garden, orchard, woods and fields will be more productive the following summer, as the result of the destruction of countless thousands of their insect and weed enemies.

Winter Protection.

Birds need protection from the winds of winter. A barren, wind-swept country, boasts of few birds, whereas any protected hillside with a southern exposure, overgrown with bushes, vines and evergreens, will be fairly alive with birds in the middle of winter.

One always finds birds roosting in pine, spruce and hemlock windbreaks. They do not fear low temperatures provided they find enough to eat, and shelter from biting winter winds.

Preferably, a device which combines protection with a place for food, should be selected. Where possible, choose the south side of your house for your feeding table and window lunch counter.

DEVICES FOR WINTER FEEDING.

Putting Out Suet.

Beef or mutton suet is the cheapest and best food for insect eating birds. It is heat producing, nourishing and does not spoil.

Take a piece weighing about a pound and tie to a branch with string, criss-crossing the cord, so that the larger birds will not demolish it the first day. A better way is to tack a square of half-inch wire netting over a large piece of suet, as in the illustration. By this method none is wasted, and replenishing the supply is made easy. Select the south side of any tree or post, as it is then better protected from the force of prevailing winter storms.

The following birds are attracted by suet, certain species eating more than others: Downey woodpeckers, nuthatches, chickadees, flickers, blue jays, crows, myrtle warblers, brown creepers, hairy woodpeckers, starlings, tree sparrows, juncos, and some others. The illustration shows unroasted peanuts strung on wire which are relished by many birds.

Suet Holder.

For convenience when replenishing the supply, a suet



Weather Vane Feeding Table Made by the Society

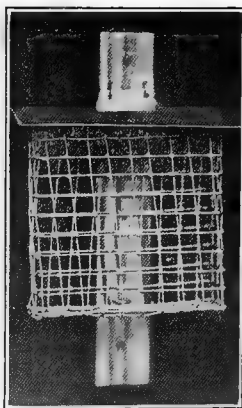

Suet Holder, with Cover, made by the Society



Seed Hopper

holder has its advantages. They may be made of half-inch mesh wire, or crocheted netting tacked to a board. The one in the illustration has a zinc cover which protects contents from sleet and snow.

Suet should be distributed throughout orchards as a means to attract many of the species mentioned above, which are particularly active destroyers of fruit tree enemies. For example: The chickadee eats the eggs of the coddling moth and tent caterpillar. Attach suet holders at least five feet up so that hunting cats cannot spring upon your unsuspecting bird guests.

Seed Hopper.

This automatic seed hopper is easily made, or can be purchased from the Society. Nailed to a post or tree, it will

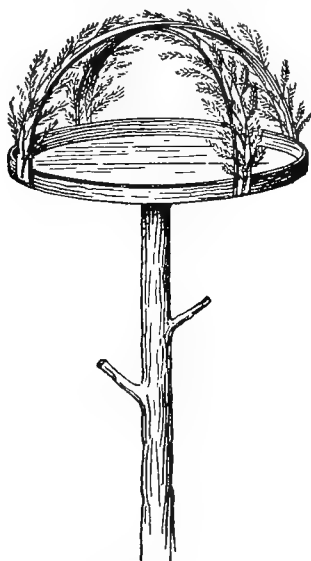

Feeding Table

furnish the weed seed eating birds with food at such times as snow covers their natural supply.

The following birds will visit the hopper: Chickadees, nuthatches, juncos, song sparrows, tree sparrows, goldfinches, purple finches, blue jays, and sometimes meadow larks and quail.

Fill with sunflower seeds, Japanese millet, hemp, canary, buckwheat and other grains.

Weather Vane Feeding Table

This weather vane feeding table on a post set into the ground, always swings with the wind, so that the food is protected from rain and snow. A glass window lights the interior, thereby overcoming the timidity of the wildest birds.

This style of feeding table affords protection from the wind, often being used as a night roost. All the species mentioned above will visit this table.

Besides the suet and grain listed before, add crushed dog biscuit, meat scraps, doughnuts, bread crumbs, and any kind of broken nuts. Grit may be furnished, as birds often find it impossible to get sufficient for their needs when the ground is deep with snow.

This type of feeding device is particularly adapted to situations far removed from dwellings. They can be made larger than the dimensions given, so that when once supplied with food will need no further attention for several weeks.

If placed near one's house, they afford much entertainment for both adults and children.

Dried elderberries, bay berries and other wild fruits are eagerly sought by the birds.

Having once played host to the winter birds, and had them return again and again for the dainties of the feeding table, it is safe to assume that you will want them to come still closer to your window.

Suspended Lunch Counter.

The suspended lunch counter is the medium to use in overcoming their natural timidity. From a nearby tree stretch a heavy wire (size No. 8 is furnished with the car) to the sill of a second story window, one facing south preferred. The car, supplied with food, is allowed to touch the tree. Once the birds have discovered this new feeding place, it should be drawn nearer each day, until the birds fly fearlessly to the window shelf.

Cutting down the variety of food on the stationary feeding devices will increase your bird patrons at the suspended lunch counter.

Neither the window shelf nor the suspended lunch counter are essentially part of scientific bird attraction or protection, but they help to stimulate greater interest in this subject, particularly among boys and girls.

The foregoing suggestions have proven successful in all parts of the country. There is no magic in attracting the winter birds about the home, but one cardinal rule must never be broken. Having once established friendly relations with the birds by furnishing them with food, one is obligated to guar-

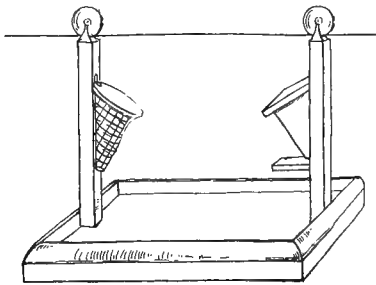

Suspended Lunch Counter Made by the Society

antee them a constant supply, so that in bad weather they will always find sufficient to tide them over until they again have access to that which nature furnishes.

Window Feeding Shelf.

A simple form of window shelf, as shown in the illustration, consists of a wide board tacked to the sill. A narrow moulding prevents the seed from being scattered by the wind. A small evergreen or branches of bayberry help to attract the birds, besides affording places to tie the suet, strings of cranberries or peanuts.

Nearly all the species listed before have taken food from similar window shelves.

Improved Window Shelf

What might be termed a de luxe feeding device is a copy of the one noted at the home of Mr. Ernest Harold Baynes in Meriden, N. H. It is best described as an inverted bay window, extending into the room about twelve inches. The



Juncos at Window Shelf, showing "Birds' Christmas Tree"



Mocking Bird on Suspended Lunch Counter, January 15th

floor of wood extends a foot outside the building, affording ample space to entertain many birds at one time.

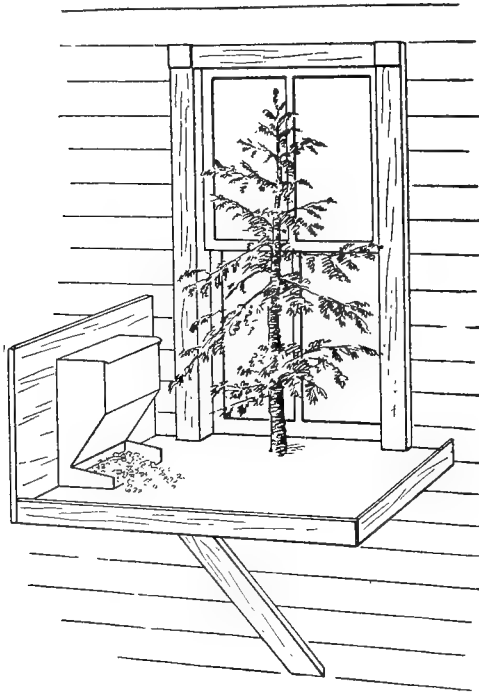

Easily Constructed Window Feeding Shelf

It is made to fit snugly into the frame when the lower sash is raised. The side toward the room should be hinged

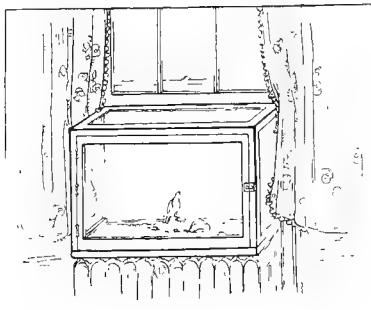

Improved Window Shelf

so as to enable one to ventilate the room, as well as to give access to the suspended lunch counter just described.

Mr. Baynes, in his recent book, "Wild Bird Guests," mentions seeing his window box often filled with "blue jays, pine grosbeaks, redpolls, crossbills, chickadees, while many other birds have come in smaller numbers."

The owner of a window shelf can cultivate the most intimate relationship with some of his feathered pensioners. A little patience, plus a choice morsel, such as a walnut meat, or perhaps sunflower seeds, will overcome their distrust and enable one to enjoy the experience of feeding birds from the hand.

Food House.

This idea, borrowed from Baron von Berlepsch, has proven satisfactory wherever tried. The one in the illustration is five feet square, eight feet high at the peak. Being a

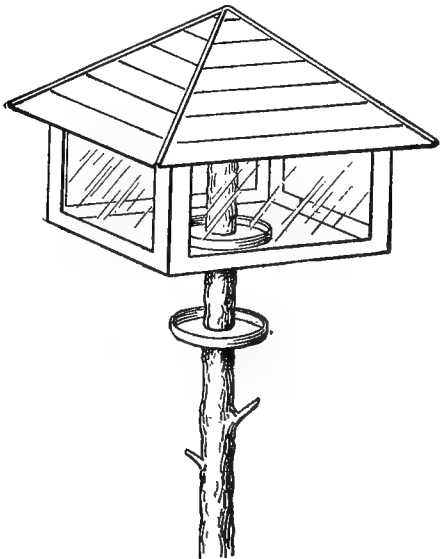

Food House and Shelter on Post

permanent feeding place, as well as one affording protection, it is best to locate it amongst evergreens, or in a sheltered position.

The interior is lighted through the glass windows, which extend on all sides about a foot below the eaves. This sash

also serves as a windbreak, preventing the food on the platform on a level with their lower edge from being scattered by the wind. The birds are first attracted by food placed on the

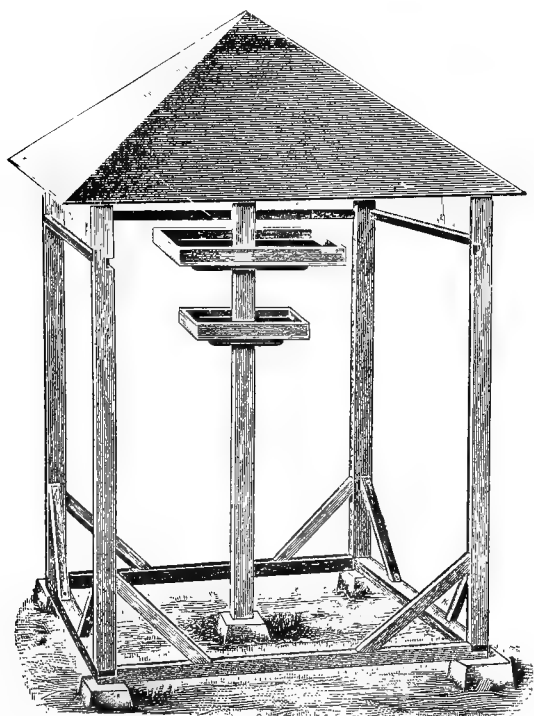

Berlepsch Food House. Glass is omitted to show construction.

small shelf about two feet above the ground, the use of which is discontinued once the birds have found the upper one.

On large estates, several of these food houses, furnished with automatic self-feeding hoppers, would be the means of saving the lives of hundreds of birds at a minimum of cost and effort. Particularly desirable when country homes are left in charge of caretakers.

Quail Shelters.

Among our so-called game birds, or those species which have been hunted by tens of thousands of gunners for generations, are several whose economic value as insect destroyers far outweighs that of many of the birds which are now protected in all states by the Federal Migratory Bird Law.

Space permits only the consideration of one specie—quail—known to all of us as “Bob White.”

Quail are permanent residents, seldom moving more than a mile or two from the locality in which they are hatched. In summer they destroy 150 kinds of insects, while during the winter they eat 126 kinds of weed seeds.

Ice storms and heavy snows often thin their ranks by starvation. Straw tepees, such as shown in the illustration, afford them needed shelter, as well as places in which to scatter buckwheat. A covey of quail in a vegetable garden means better crops and less work for the gardener. Quail have no bad habits.

Nesting Boxes to Attract Birds.

The cutting out of dead standing timber and ridding fruit trees of decayed branches has robbed members of the woodpecker family of the places they would choose for a nest.

The species which will use bird houses are listed below, in the excerpt from Farmers’ Bulletin, “How to Attract Birds,” as prepared and published by the Biological Survey.

DIMENSIONS OF NESTING BOXES FOR VARIOUS SPECIES OF BIRDS

Species	Floor of Cavity	Depth of Cavity	Entrance above floor	Diameter of Entrance	Height above ground
	<i>Inches</i>	<i>Inches</i>	<i>Inches</i>	<i>Inches</i>	<i>Feet</i>
Bluebird	5 by 5	8	6	1½	5 to 10
Robin	6 by 8	8	*	*	6 to 15
Chicadee	4 by 4	8 to 10	8	1½	6 to 15
Tufted Titmouse	4 by 4	8 to 10	8	1½	6 to 15
White-breasted Nuthatch	4 by 4	8 to 10	8	1½	12 to 20
House Wren	4 by 4	6 to 8	1 to 6	¾	6 to 10
Bewick Wren	4 by 4	6 to 8	1 to 6	1	6 to 10
Carolina Wren	4 by 4	6 to 8	1 to 6	1½	6 to 10
Dipper	6 by 6	6	1	3	1 to 3
Violet-green Swallow	5 by 5	6	1 to 6	1½	10 to 15
Tree Swallow	5 by 5	6	1 to 6	1½	10 to 15
Barn Swallow	6 by 6	6	*	*	8 to 12
Martin	6 by 6	6	1	2½	15 to 20
Song Sparrow	6 by 6	6	+	+	1 to 3
House Finch	6 by 6	6	4	2	8 to 12
Phoebe	6 by 6	6	*	*	8 to 12
Crested Flycatcher	6 by 6	8 to 10	8	2	8 to 20
Flicker	7 by 7	16 to 18	16	2½	6 to 20
Red-headed Woodpecker	6 by 6	12 to 15	12	2	12 to 20
Golden-fronted Woodpecker	6 by 6	12 to 15	12	2	12 to 20
Hairy Woodpecker	6 by 6	12 to 15	12	1½	12 to 20
Downy Woodpecker	4 by 4	8 to 10	8	1¼	6 to 20
Screech Owl	8 by 8	12 to 15	12	3	10 to 30
Sparrow Hawk	8 by 8	12 to 15	12	3	10 to 30
Saw-whet Owl	6 by 6	10 to 12	10	2½	12 to 20
Barn Owl	10 by 18	15 to 18	4	6	12 to 18
Wood Duck	10 by 18	10 to 15	3	6	4 to 20

* One or more sides open. † All sides open

From Farmers’ Bulletin, “Bird Houses and How to Build Them”

The location of nesting boxes is as important as their construction. Bear in mind that artificial nest sites are an effort on our part to imitate a decayed branch or dead tree, such as woodpeckers choose. To put nesting boxes in deep shade would not conform to natural situations, which are always exposed to sunlight.

It is conceded by many, as well as being the writer's experience, that nesting boxes on posts or poles are the ones most likely to be occupied.

Blue Bird Boxes.

Blue bird's boxes are simply made, provided they conform to the dimensions given above. Place on posts in the

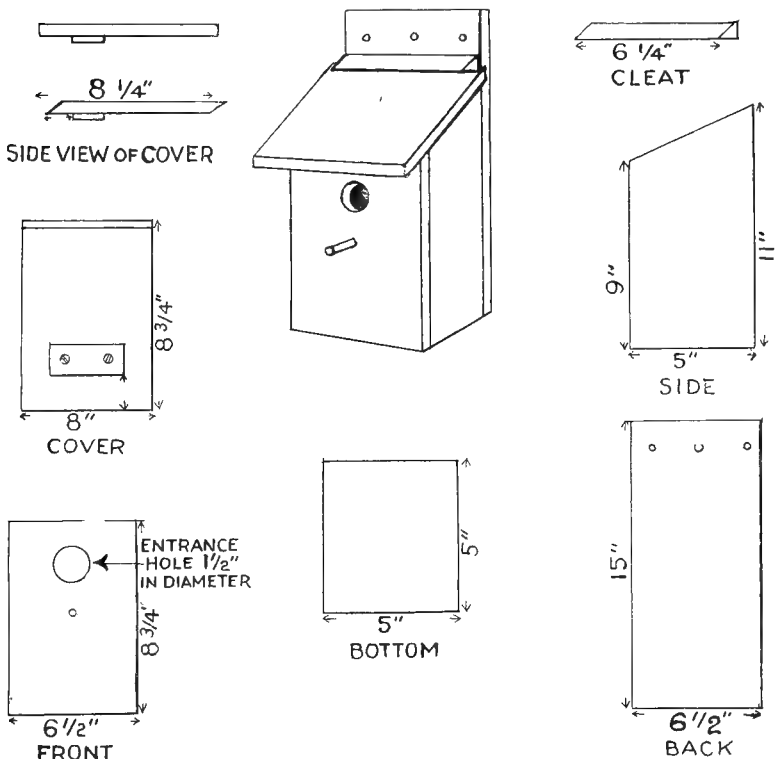

Plan for Blue Bird Boxes

garden, or in exposed situations in orchards.

All nesting boxes should be made with removable covers.



Blue Bird on Home-made Box

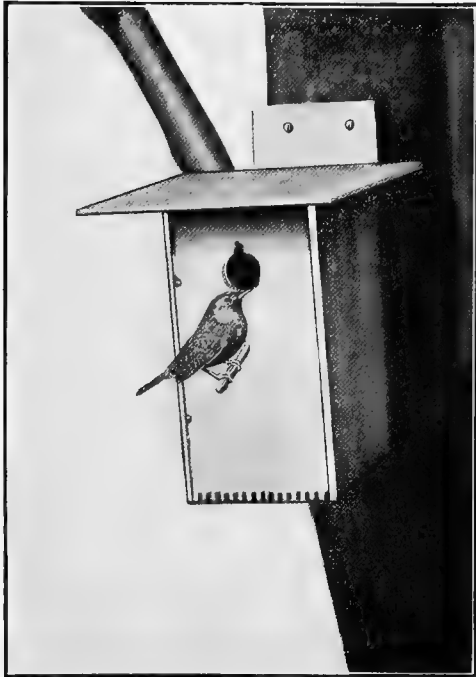

Wren Nesting in Home-made Box

Access must be had to remove old nests, and in districts where the brown tail moth is prevalent, to remove the cocoons of this and the gypsy moth.

Nesting Boxes for Wrens.

Nearly any kind of a box will be occupied by the common house wren. An inch in diameter entrance hole prevents English sparrows from taking possession. This specie delights in helping to keep down garden pests, 98 per cent. of its food consisting of insects.

Late fall is a good time to put out nesting boxes, as they will have lost their newness and odor of paint by the time the birds arrive in the spring. Winter birds often use them in which to spend the night.

Nesting Boxes for Woodpeckers.

To attract members of the woodpecker family, the surest results come from the use of Berlepsch houses. Invented by Baron von Berlepsch of Germany, the world's greatest conservationist, these nesting boxes are exact replicas of the cavities drilled by the woodpeckers themselves. They vary in

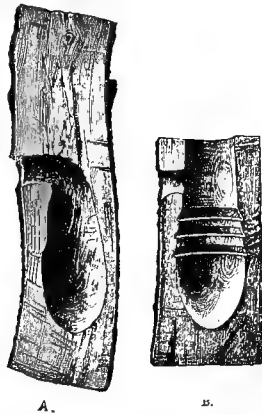

(A) Natural Cavity and (B) Berlepsch Box Compared

size to meet the requirements of each specie, from the smallest, for the wren, to the largest size, for the wood duck.

The illustration shows a comparison of a natural cavity with the one made by special machinery, imported from Germany by the Audubon Bird House Company, at Meriden, N. H.

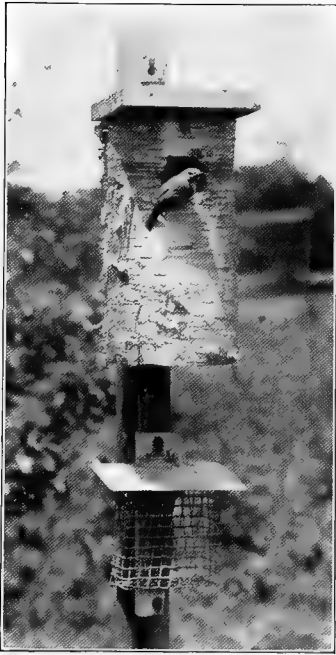

Wren on Berlepsch Box—Suet Holder
Below



Tree Swallow Nesting in Berlepsch Box on Post



Wren Box Made by the Society

For those who want to make their own nesting boxes, the illustrations taken from Farmers' Bulletin, "Bird Houses and How to Make Them," by Ned Dearborn, give full details for their construction. Smaller ones may be made to comply

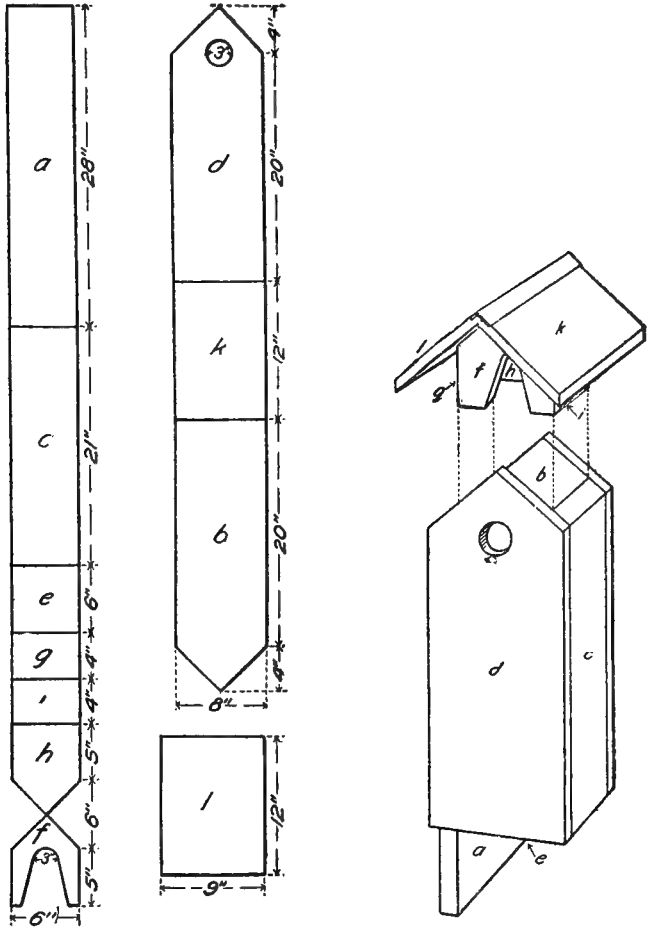

Flicker Box with Specifications

with the dimensions given in the table, for tree swallows, downey woodpeckers, etc.

Woodpeckers differ from the blue bird, tree swallow,



Nesting Boxes on Posts Attract Birds



**The Only Purple Martin Colony in Greenwich is
in the Writer's Garden**

wren, nuthatches, etc., by taking in no material to make a nest. The chips and sawdust left after excavating act as a bed for their eggs. Therefore houses put up to attract them must contain at least an inch of sawdust.

All nesting boxes, except those made from logs with the bark on, should be painted. A dark green or brown is preferred.

Purple Martin Colony Houses.

The only specie which will live in colonies or use nesting boxes with two or more compartments is the purple martin. This bird, once common throughout the country, is found only in certain localities to-day. Its scarcity is attributed to the presence of English sparrows, which occupy martin

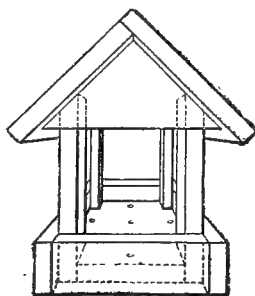

Nest Shelter for Robins, Cat Birds, and Others—to be Placed in Shrubbery on Post

houses long before their rightful owners arrive from the South. The German starling, which is increasing in numbers very rapidly, is proving detrimental to established martin colonies. The latter intruder can be kept out by making the entrance $1\frac{5}{8}$ inches in diameter, with a half-inch hole directly above to admit light. English sparrows can be kept out by covering the entrance holes from the end of August until the following April. If, notwithstanding this attention, English sparrows succeed in building their nests, a shotgun is the quickest solution. Martin houses should be placed on poles at least fifteen feet high, away from trees and buildings.



Downy Woodpecker at Suet



Bluebird Feeding Young. Berlepsch House on Post.

Phoebes will occupy four inch square shelves put up under the eaves of buildings.

Barn and cave swallows will often build their mud nests on narrow cleats fastened in like situations.

Robins will occupy open shelves, as will catbirds and brown thrashers, if placed in shrubbery.

The devices described, while they will help increase the bird life about one's home, there remains much to do to make one's place attractive to nesting birds.

Planting to Attract Birds

Modern landscape gardening makes little provision for nest-hunting birds. Tangled roadside thickets are cut down to be supplanted by evergreens or thinly planted shrubbery, or perhaps by a wall or wire fence.

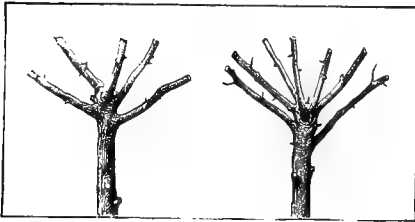

One-Year-Old Whorls Recently Pruned



Old Whorls Recently Pruned

Briery patches overgrown with wild grape and other vines are eliminated to make room for great stretches of closely cropped lawn. Little thought is given to the need of quiet, secluded spots where birds can build their nests and rear their young free from inquisitive young people and safe from their many enemies.

No suggestions that can be made will help to increase the bird population as much as an area planted with shrubs and trees which will offer secure nest sites. Once planted, it must be left severely alone, save to prune to stimulate denser growth and the creation of whorls of stems or branches.

Proper pruning is clearly shown in the illustrations. Tying stems of shrubs increases the number of saddles or



Robin Using Nest Shelter in Pergola



Barn Swallows Nested Under Porch at Mr. Geo F. Doninick, Jr.'s Home

whorls which birds seek when nest building. This simple expedient need not stop at one's own boundary line, but can be done to nearby roadside undergrowth, resulting in a marked increase in the birds about one's home.

If we would protect ground nesting birds, as bobolinks, meadow larks and quail, grass in the nesting field should not be cut during the breeding season.

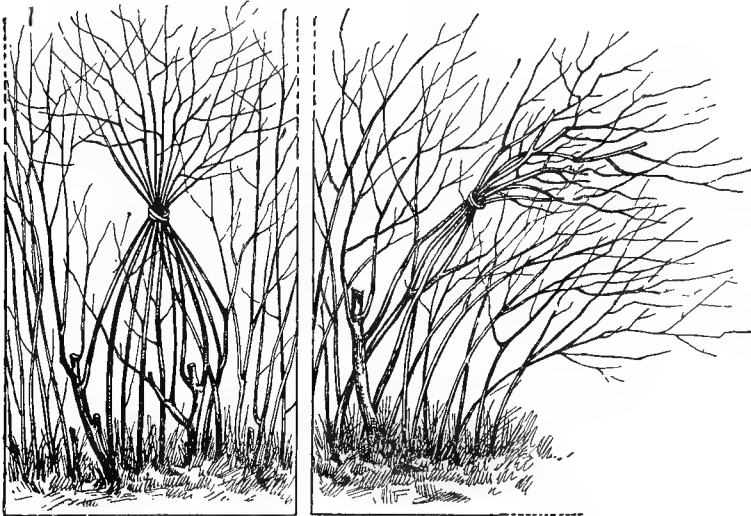

Bushes Tied Up to Provide Nesting-Places

White spruce, Douglas spruce, Scotch pine and cedars offer excellent nest sites. Japanese barberry, Washington thorns and others of this family, as well as gooseberries and blackberries, when properly pruned, make cat-proof refuges. Poplars, when severely cut back, afford excellent nest sites.



Goldfinch on Bird Bath

Selected List of Trees and Shrubs, the Fruit of Which Birds Like.

(From Baynes' "Wild Bird Guests.")

Common Name.	Scientific Name.	Fruiting Season.
†Hackberry	<i>Celtis occidentalis</i>	Sept. through winter
*Flowerly dogwood	<i>Cornus florida</i>	August-December
†White thorn	<i>Crataegus Arnoldiana</i>	August-September
†American holly	<i>Ilex opaca</i>	October through winter
*White mulberry	<i>Morus alba</i>	June-August
*Red mulberry	<i>Morus rubra</i>	June-August
*Bird cherry	<i>Prunus pennsylvanica</i>	June-October
*Cargent's cherry	<i>Prunus sargentii</i>	June
*Sand cherry	<i>Prunus pumila</i>	June-August
*Black cherry	<i>Prunus serotina</i>	July-November
*Choke cherry	<i>Prunus virginiana</i>	July-August
†Red cedar	<i>Juniperus virginiana</i>	Throughout the year
†Common juniper	<i>Juniperus communis</i>	Throughout the year
†Shad bush	<i>Amelanchier canadensis</i>	June-October
†Spice bush	<i>Benzoin aestivale</i>	August-November
Most of the cornels		
†Huckleberry	<i>Gaylussacia ca cata</i>	July-September
†Black alder	<i>Ilex verticillata</i>	July through the winter
†Bayberry	<i>Myrica carolinensis</i>	July-May
*Fragrant sumac	<i>Rhus canadensis</i>	July-September
*Dwarf sumac	<i>Rhus copallina</i>	Throughout the year
*Poison sumac	<i>Rhus vernix</i>	August through winter
†Prickly gooseberry	<i>Ribes Cynosbati</i>	June-September
†Black currant	<i>Ribes floridum</i>	August-September
†Wild rose	<i>Rosa humiles</i>	August through winter
*Wild blackberry	<i>Rubus Allegheniensis</i>	July-September
*Highbush blackberry	<i>Rubus frondosus</i>	July-August
*Highbush blueberry	<i>Vaccinium corymbosum</i>	June-September
†Highbush cranberry	<i>Virburnum Opulus</i>	July-April
Vines.		
†Virginia creeper	<i>Psedera quinquefolia</i>	September-February
†Fox grape	<i>Vitis Labrusca</i>	August-October

The fruits marked with an asterisk (*) are eaten by thirty or more kinds of birds. Those with a dagger (†) by ten or more species.

Bird Baths.

In districts where a natural supply is lacking, it is of the greatest importance that the birds be furnished with water, both for bathing and drinking purposes.

It matters little the form of a bath so long as it is shallow. Many ornate fountains and pools fall short of their object by being too deep. The depth should vary from one to three inches, with a rough bottom to insure a safe footing. Ordinary flower pot saucers will suffice, but larger receptacles are to be preferred, requiring less labor in keeping the bath filled.

Properly made concrete bird baths can now be bought for little money. All gardens have some corner in which a

bird bath may be placed to advantage where its feathered patrons will prove a constant source of entertainment.

Bird Enemies.

In this chapter no account will be taken of the destruction of bird life by the elements, nor the toll taken by the natural enemies of the smaller birds by hawks, owls, shrikes, crows, bluejays and weasels. After one has become interested in bird protection, he will naturally seek further information upon the subject.

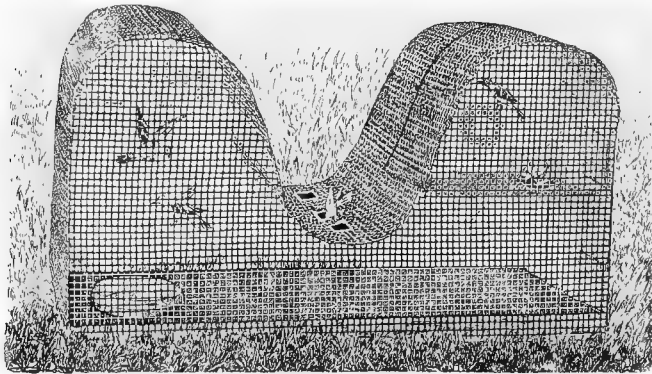

Sparrow Trap made by Greenwich Bird Protective Society

The presence of English sparrows, homeless cats and red squirrels are the handicaps which confront those who are trying to bring back the birds. The Biological Survey advocates the destruction of the former and further states that our native birds have no greater enemy than the cat.

Unfortunately the English sparrow, rightly named "The rat of the air," is wary of traps, and as they nest in out-of-the-way places, raising four broods yearly, half-hearted campaigns to destroy their nests and eggs do little to lessen their numbers.

Not content to usurp the boxes put out for more desirable tenants, English sparrows drive away species which build their nests in the open.

Traps, poison and shooting have been used by the writer for the past four years, with a total score of 7,000 sparrows. The notable increase of bird life in the territory in question, the writer attributes to his persistent persecution of this pest.

The sparrow trap in the illustration has proven very effective when placed in chicken yards. The birds go through cone-shaped entrance holes in the lowest point of the top, attracted by a generous supply of small mixed grains scattered on the floor of the trap. Unable to escape, they find their way to a smaller chamber, from which they are readily removed by hand. Native birds accidentally caught are easily released. Best results are obtained by keeping living sparrows in the trap as decoys. Food and water being supplied, the captive sparrows suffer no hardship.

Poisoned grain, having so many elements of danger, will not be discussed here, the reader being referred to Farmers' Bulletin 493, "The English Sparrow as a Pest," copies of which can be secured by writing to the Department of Agriculture at Washington.

Shooting accomplishes great results when done as follows: Feed small grains from a long narrow trough on the ground for several days until hundreds of sparrows from the surrounding neighborhood flock to it the moment the food is put out. A shotgun so placed to sweep the length of the trough will kill dozens at each shot. The gun can easily be secured in place and the trigger released by a long string.

To those who naturally object to recommend the above methods to young people, will find that English sparrows may be kept in check by the simple expedient of removing the eggs. It is better to wait until the full clutch of five is laid before destroying them. It is said that persistent robbing of their nests will discourage nesting pairs so that they will desert the neighborhood.

There is no doubt but were a community desirous of cleaning out the pest, but that it could be done at little cost.

Nothing discourages beginners as quickly as this continuous war against English sparrows, but it were better to put up no bird houses than to permit them to help increase this pest.

The Cat Problem.

Not until one has turned his attention to the problems confronting the conservationist does he realize the havoc wrought by homeless cats. This does not, however, absolve the pet cat, whose case will be considered separately.



Hunting the Prey



The Capture



Devouring the Victim These Photographs taken at 4 a. m. in June, 1914

Cats are subject to tuberculosis and diphtheria, they carry and transmit bubonic plague, as well as the foot and mouth disease. It is quite possible that the epidemic of measles in Greenwich some months back can be traced to the cat, which could easily elude the most careful quarantine.

Authenticated cases of true hydrophobia have been traced to the bite of a pet cat.

The writer personally knows of a family which treated an ailment of a pet cat, only to learn that the disease was true cancer. The condition of mind of members of that family can be better imagined than described as they await the appearance of the signs of that dreaded disease upon their own bodies.

The heartless cruelty of thoughtless persons who bring a cat with them from the city and desert it when returning at the end of their stay in the country, should be universally condemned. So with those who, owning surplus cats, take them to the outskirts of their own township and then set them adrift. An ounce of chloroform or drowning would be the merciful thing to do.

Deserted cats, forced to gain a living, are the kind that kill annually millions of valuable insect eating birds. Brooding, feeding and roosting adults with uncountable nestlings are needlessly slaughtered to no purpose.

In the near future wide awake communities will come to realize that cats should be licensed. Such a law imposes no hardship on the individual, while it serves to protect the public at large.

The problem of the house cat is difficult to approach, and still more difficult to solve. A love of cats being more general than a love of birds, cat owners are up in arms the moment the object of their affections (?) is attacked. Realizing the hopelessness of converting one already prejudiced in favor of cats, the writer will offer the following testimony, trusting it will be read and remembered:

Well fed cats hunt birds, because hunting is a characteristic of their specie. Most birds are killed during the nesting season, which is from June to August, inclusive, than all the rest of the year. From 3 to 8 A. M. are the hours cats hunt both nestlings and fledglings.

The writer has not needed to go far for his facts. A cer-



Robin's Nest in Crotch of Poplar

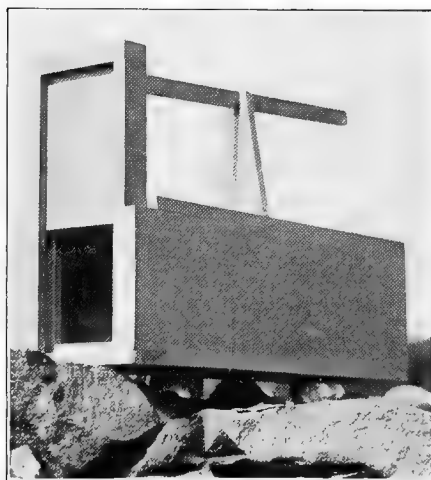

Cat Trap Made by the Society

tain cat in the household of the writer, although burdened with six bells of various sizes, was photographed one morning at 4 o'clock in the act of killing and mauling a fledgling cat-bird. This same cat, sleek and fat, brought to our veranda during the past nesting season, **twenty-eight** birds, none of which it ate.

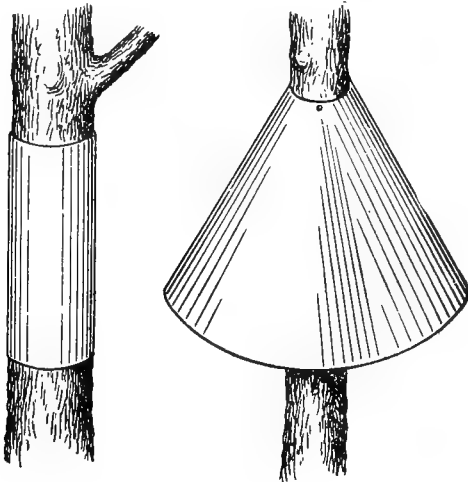

Cat Guards for Trees and Posts Holding Nesting Boxes

If a well nourished cat establishes such a record, is not the estimate of fifty birds per cat per year, made by Prof. Forbush, a reasonable one. The same authority estimates that 7,000,000 birds are killed annually by cats in New England alone.

The statement made that we need cats to keep down rats and mice is only a half truth. The writer has taken pains to note that households owning cats still depend largely upon rat and mouse traps.

Bells on cats may give warning to adult birds, but do not lessen the killing of young birds. Confine your cat during the nesting time. At least keep it indoors at night if you would protect the birds.

In localities overrun with half-starved tramp cats, the cat trap in the illustration will prove effective. The cat enters, attracted by the bait, which should be grisly beef, preferably half broiled. The batit is impaled on a nail at the back of the

trap, reached through a small door at the rear; over the point of this nail is caught a loop of wire running from the cross-arms, which in turn holds the door up when the trap is baited and set. The slightest attempt on the part of the cat to remove the meat, removes the wire loop which allows the door to fall.

To kill the cat a sponge saturated with an ounce of chloroform is inserted through the small rear door, and in half an hour's time the trap is ready to be reset.

Red squirrels, destroyers of both eggs and young birds, can best be kept in check with a gun. They are not protected by law and their destruction is recommended by the Biological Survey as well as other authorities on bird life conservation.

Concluding these suggestions of methods to be used to attract the birds about the home, the writer, desiring to give credit to the pioneers of conservation from which he has drawn his information from time to time, refers the reader to the following list of publications relating to this subject:

List of Publications Relating to Bird Life Conservation.

- Methods of Attracting Birds. By Gilbert H. Trafton.
- Our Vanishing Bird Life. By Dr. William T. Hornaday.
- How to Attract and Protect Wild Birds. By Martin Hieseman.
- Useful Birds and Their Protection. By Edward H. Forbush.
- Wild Bird Guests. By Ernest Harold Baynes.
- Wild Life Conservation in Theory and Practice. By Dr. William T. Hornaday and F. C. Walcott.
- The Propagation of Wild Birds. By Herbert K. Job.

Pamphlets.

- The Cat: What Shall We Do With It? By M. S. and L. A. Lacey.
- The English Sparrow as a Pest. By Ned Dearborn. Farmers' Bulletin No. 493.
- Some Common Birds in Their Relation to Agriculture. By F. E. L. Beal. Farmers' Bulletin No. 630.
- Bird Houses, and How to Make Them. By Ned Dearborn. Farmers' Bulletin No. 609.
- How to Attract Birds in the Northeastern States. By W. L. McAtee. Farmers' Bulletin No. 621.
- The Economic Value of Birds to the State. By Frank M. Chapman. Second Report of the Meriden Bird Club, Meriden, N. H.
- Report of the Brush Hill Bird Club, Milton, Mass.

First Annual Report
Greenwich Bird Protective
Society, Inc.

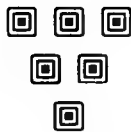

1915

The Greenwich Bird Protective Society, Inc.

NIEL MORROW LADD	ALDEN TWACHTMAN
PRESIDENT	VICE-PRESIDENT
E. A. WOOD	CHESTER MONTGOMERY
TREASURER	SECRETARY
RAYMOND B. THOMPSON	
GENERAL MANAGER	

Board of Governors

ROGER S. BALDWIN	MORTON C. NICHOLS
H. S. FISHER	R. V. PELL
F. B. HIGHET	W. B. SEWELL
A. S. HOUGHTON	FRANK SPIEKERMAN
GEORGE W. HUBBELL, JR.	D. GRAHAME SMYTHE
C. D. LANIER	RAYMOND B. THOMPSON
NIEL MORROW LADD	ALDEN TWACHTMAN
CHESTER MONTGOMERY	E. C. WILLS
W. E. MARBLE	E. A. WOOD

Executive Committee

ROGER S. BALDWIN	NIEL MORROW LADD
C. D. LANIER	RAYMOND B. THOMPSON
F. B. HIGHET	

What the Greenwich Bird Protective Society Has Accomplished in a Year's Time

On an evening in April, 1914, several men interested in the preservation of our native game birds, met at the Country Club, with the object of forming a Society in Greenwich for the protection of both game and insectivorous birds.

Within a month's time the Greenwich Bird Protective Society had been formed, and duly incorporated; Officers and Board of Governors elected, and this town had taken its first step towards becoming "the bird town of New England."

The sole object of our Society being to make the town attractive to bird life, the co-operation of every resident was earnestly solicited. To acquaint the townspeople with the aims of our Society, an illustrated circular was printed, outlining its plans, as well as emphasizing the great economic importance of bird life. Extracts from Government reports were included, to show that any increase in our bird life meant a lessening of the annual loss of \$800,000,000 due to insect pests and weeds. The circular closed with an invitation to every man, woman and child to help attract and protect the birds.

Hundreds of these circulars were sent by mail, many distributed by local storekeepers, while copies were posted on bulletin boards of all the clubs.

The prompt response to our appeal for members was very gratifying. Applications came pouring in, accompanied with ten cents, one, two, ten and twenty-five dollars, representing respectively, Junior, Associate, Active and Life Memberships and Patrons.

To create active participation in our contemplated conservation plans, hundreds of circulars were distributed, entitled, "Twelve Ways to Help the Birds about Greenwich." Every member received a number to distribute among their friends and neighbors; storekeepers enclosed them in packages; bundles of them were hung about the Town Hall and Public Library. A special printing on heavy cardboard was



Large Weather Vane Feeding Table on the Property of the Greenwich Water Company

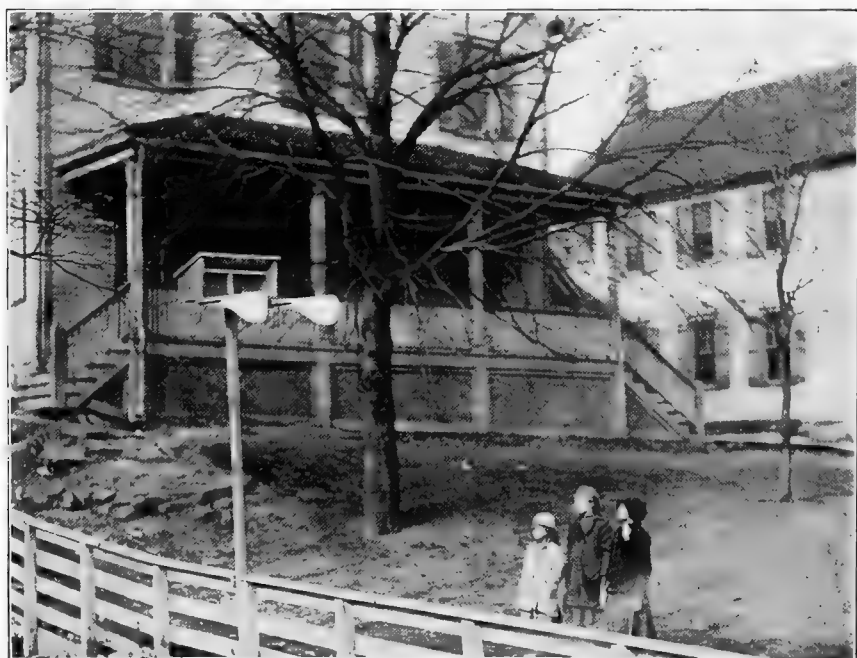

One of the Weather Vane Feeding Tables Presented by the Society to the Schools in Greenwich

sent to the schools, which were tacked upon the walls of every classroom.

This circular recommended planting trees, shrubs, vines and plants, the fruit of which attract birds. It emphasized the importance of bathing and drinking places, as well as advocating the destruction of the homeless house cat.

At the request of the Society, the local storekeepers laid in a stock of books relating to birds, and methods to attract and protect them. The Public Library was presented with books upon these subjects for the use of those unable to buy the works suggested in the circulars.

Inasmuch as our Society was the first of its kind in Greenwich, it was natural that our efforts towards conservation would be confronted with an indifference on the part of many residents, due, in a measure, to their ignorance of the role birds play in ridding all growing things of their insect enemies. To reach a population of 15,000 persons, scattered over a territory of about 81 square miles, called either for an expensive advertising campaign, or persisted effort over a long period. A slim treasury demanded the latter course.

One of the methods used to stimulate interest in this work was a series of informal bird talks by the writer before the public and private schools, the Farmers' Club and several general audiences. At these talks the writer showed his lantern slides made from photographs taken about Greenwich. These pictures, aside from their local interest, showed how to feed the winter birds, how to make and place nesting boxes and bird baths; in fact, how to make one's home grounds attractive to bird life.

By the Autumn of 1914 our Society had engaged the services of a bird warden, who had the authority of a constable. When the hunting season opened, and 300 local licensed gunners started out in quest of the pitifully few quail, grouse, ducks, rabbits and squirrels the county afforded, our bird warden was instrumental in stopping many unwelcome hunters from shooting on lands posted against trespassing. The task, however, proved too great for one man, so that the coming hunting season of 1915 will find ten bird wardens engaged for several weeks, to protect the property of owners who prefer quail on their lawns to quail on toast.



Straw Quail Shelter and Feeding Stations Put Out by Bird Warden and Boy Scouts

Before snow and ice threatened the lives of our resident winter birds and those that visit us from farther north, our Society had arranged to manufacture and sell feeding devices of various kinds. Weather vane feeding tables, seed hoppers, suet holders, suspended lunch counters, wren and blue bird nesting boxes, as well as English sparrow traps and cat traps. Prices on these articles were less than those asked by well-known manufacturers.

Mr. J. B. MacArdle, when approached by the writer, readily agreed to display these devices in his store window. Surprised by their ready sale and the interest shown in the subject, he soon decided to add nesting boxes and feeding devices to his stock, laying in the products of several well-known concerns. Mr. MacArdle has agreed, however, to offer no nesting boxes which do not have the approval of our Society. His contribution to the cause of bird protection consists in making his prices on hemp, buckwheat, sunflower seed, etc., somewhat below the regular prices.

During the winter of 1914-15 our bird warden, assisted by the Boy Scouts, erected 75 quail shelters and feeding stations, keeping them supplied with buckwheat throughout the winter. On Easter morning, after a snowfall of eight inches, the writer saw twelve meadow larks eating buckwheat at one of these feeding stations. Suet and small grain were also distributed for the insectivorous and weed seed eating birds.

Nearly every school has been presented by our Society with a weather vane feeding table, which is supplied with food from the lunch boxes of the school children. Besides the stations maintained by our Society, at least 60 were sustained by members on their home grounds.

The Greenwich Water Company, recognizing the value of bird life to the community at large, has permitted our Society to establish feeding stations on their watershed of 600 acres. As this great area is posted against trespassing, as well as patrolled by employees of the Water Company, it can easily be made a bird refuge to the great benefit of the people of Greenwich.

Since January, 1915, the Greenwich News and Graphic has opened its columns to the Society. Every Tuesday's issue contains a column devoted to "Greenwich Bird Notes."

This has enabled the writer to bring before thousands of residents the aims of our Society and its successes to date.

Members should avail themselves of this opportunity to stimulate others in the profitable recreation of attracting birds, by describing their personal experiments about their own homes. "Greenwich Bird Notes" should be a clearing house of all bird gossip, from Port Chester to the Stamford line.

Aware of the fact that the children of to-day are the bird protectors of the future, plans are being made to secure the actual co-operation of the 4,000 school children in Greenwich.

The competitions open to the boys and girls of the town which will form part of the Bird Exhibit on Bird Day to be held September 29th, will do much to stimulate interest in the work of our Society.

Junior members (boys and girls under 14 years) are given a button bearing the picture of a robin around which is printed the name of our Society.

Summing up the results of a year of systematic bird protection in Greenwich, one finds that over 2,000 nesting boxes of various kinds await the coming of bird tenants. Several hundred of these are the scientifically correct Berlephsh type.

Over thirty-five martin houses, from a simple eight-room house to one containing sixty rooms, have been erected; dozens of bird baths are to be found scattered among the gardens of the town.

At least 100 feeding stations were in operation last winter, with a likely increase for the coming season.

Thousands of English sparrows have been killed, and as many nests and eggs destroyed by those who dislike the former method of lessening this menace to our native birds.

Starling nests have been taken from nesting boxes, put up for more desirable species, but no other effort by the Society has been made to lessen their numbers. Until the Biological Survey has published its findings regarding this doubtful importation, our Society will take no stand in the matter.

The problem of lessening the number of homeless cats has not been solved by our Society. Aside from the manufacture and sale of about twenty-five cat traps, we have made no progress.

Individual members have eliminated a total of approximately two hundred. The estate of one member, which is particularly rich in bird life, has had two cat traps in operation, with a total catch of 47 in a year's time.

A sentiment, however, in favor of a local license for cats is growing stronger daily.

The present membership of about 235 is smaller than it should be. Doubtless, the general conditions of the past year should be taken into consideration when measuring the success of this movement for better protection for our birds.

With a view to encourage neighboring towns to join with us in this conservation work, the writer would bring this fact to their attention. Whatever has been accomplished has been done by busy men. With but one or two exceptions, all make daily trips to their places of business in New York City. Judging from reports of similar societies, the one in Greenwich has not been as fortunate as they in having assistance from high schools or colleges or retired business or professional men whose hobbies lean in the direction of bird protection.

NIEL MORROW LADD.

Communications from Members Addressed to the President

"You know I have a great appreciation of the work of the Greenwich Bird Protective Society, and am aiming with its help to make my place here a bird sanctuary. Among the species lately noted is the redheaded woodpecker. I hope it is back to stay. The pair here are the first I have seen in Connecticut during fifteen years' observation."

ERNEST THOMPSON SETON.

"In the last year it has been necessary to spray our trees only twice, while during previous years we have sprayed them as many as four times. This change, I believe, has been brought about by the fact, through the efforts of your Society, we have more birds than in previous years."

EDWARD B. CLOSE.

"Our grounds are so small that we have little information to give regarding the birds, although there has been a much greater variety this summer than last.

"The suet holders were constantly emptied last winter, but the feeding table was not used at all.

"The mulberry trees have been a great attraction to all the birds."

MARY W. HOYT.

"I do feel that the work which the Greenwich Bird Society is doing is having a marked effect upon our bird life—for the variety and number of birds are increasing, both in the winter and summer months.

"From my observations their presence is making its influence felt in the reduction of insects which have, in other years, infested our trees.

"I have never felt willing to catch and poison the English sparrows, which, as we all know, drive our native birds away. but I have destroyed their nests and disturbed them after dark in their roosting places by playing the hose upon them. This method has a very wholesome effect in ridding our immediate surroundings of this troublesome little bird."

W. B. TUBBY.

"Our birds have certainly been on the increase this year, although the impudence and tenacity of the English sparrows make it very discouraging work. The sparrows filled practically all the bird houses with litter, and in spite of all our efforts have reduced the number of nestings very much. I have had very little success with traps and have finally decided that a small double-barreled shotgun is the best exterminator.

"There is no question but what the commendable work of the Greenwich Society has helped the situation all over town. Our greatest need at present is a systematic effort against English sparrows and cats."

H. J. FISHER.

"The bird life this summer at 'Cabinwood' has been noticeably greater, both in numbers of individuals as well as species. While most of the commoner birds nested here,

scarlet tanagers, Baltimore orioles and bluebirds were unusually abundant.

"What, perhaps, brought the birds more prominently to our notice this summer was our new bird pool, made from a natural basin in a great rock close by the house.

"On one occasion two scarlet tanagers and four bluebirds bathed together. Another time seven bluebirds filled the pool. Robins, phoebes, bluebirds, bluejays, chipping sparrows and goldfinches were noted, with the probability that many others visited the pool in our absence.

"Many humming birds were seen, but the nest of but one located.

"Phoebes built their nests on shelves placed for them under the eaves. Nuthatches and bluebirds occupied Berlepsch houses.

"Unfortunately, flying squirrels took possession of a number of Berlepsch boxes, early in the spring, which prevented woodpeckers and others from using them.

"Additional Berlepsch nesting boxes have been ordered to replace those damaged by squirrels. To lessen the annoyance from field mice, which often take possession of boxes as soon as the first brood has left, especially when boxes are placed within six feet of the ground, all of the new ones will be located much higher than usual.

"Quail have been unusually abundant. A nest containing eleven eggs was found while mowing within seventy five yards of the house. Although further work was stopped and the nest left as found, the birds deserted it.

"Scotch pines seem to be favorite places for catbirds, goldfinches, robins and chipping sparrows to nest. Chewinks nested in the Japanese barberry.

"A snake about to devour nesting catbirds was discovered in time and killed. Our attention was attracted by the noisy alarm given by the parent birds.

"A starling killed a bluebird on her nest in a Berlepsch box.

"A cat trap like the one made by our Society has caught forty-five cats up to date. We attribute the increasing bird life to our crusade against bird-hunting cats.



Bird Pool on Mr. Raymond B. Thompson's Estate



Feeding Devices on Mr. Raymond B. Thompson's Estate

"Our trees and shrubbery have been noticeably free from insects, due to the birds, especially wrens. At least a dozen wren boxes were occupied about the house and grounds."

RAYMOND B. THOMPSON.

"I am an enthusiastic follower of the rod and gun, and may take a shot at ducks in their migration to the South. I have not yet satisfied myself that the German starling, so called, is as bad as he is said to be. (They are scarce this year, though.) However, whenever from my own observations I find him so, I will turn against him, as I have done against the English sparrow.

"I have watched the English sparrow closely since I championed his cause before you and Mr. Baldwin, in the Stanwich Hall at a Farmers' Club meeting last spring. I now believe the mischief he does offsets the good. English sparrows ate my transplanted seedling cabbage plants; transplanted Celosia plants; every shoot from a 25 foot row of sweet peas, and about the same of garden peas, and never left the wheat field from the time the grain began to ripen until I had it in the barn.

"They rested on the hay carrier track and infested the poultry houses, where feeding was easy. I have destroyed many old and young sparrows, besides their eggs and nests. However, I have not seen them destroy another bird's nest or dispossess a bluebird. In fact, in a dead tree trunk, a bluebird and a sparrow occupied cavities on opposite sides, their young making their flight the same week.

"At the request of the late Charles T. Wills I have been feeding and protecting quail, partridge and small birds for the past six or more years. Mr. Wills furnished the grain and I the suet and meat diet, and I believe that the many large flocks of quail now in evidence can be traced directly to the few birds fed and protected on this place. The Hungarian partridge now spreading out, can be traced to the ten pairs which Mr. Wills bought and had liberated about five years ago. While harvesting our wheat this past July we started a pair of old birds with nineteen young ones, only able to fly about fifty feet.

"I suggested to Messrs. C. S. and E. C. Wills to-day that

they offer to your Society the use of these farms as an additional bird sanctuary. Birds having been fed and protected here for several years, they are sure to return again next winter.

“Chipping sparrows have never been more plentiful. Nuthatches, creepers, warblers, woodpeckers (various), flickers, bluebirds, American goldfinches, Baltimore orioles, orchard orioles, scarlet tanagers and wrens were common, while whip-poor-wills and nighthawks have been more in evidence than at any time during my nine years' stay.”

ALEX. COUSTON.

“I suppose it is too late to join the ranks of those singing the praises of bird protection, and I have nothing of special value to say.

“I am glad to feel, however, that no society has had to ‘rouse my interest’ in bird preservation. John Burroughs did that when I was a young girl in Minnesota, though long before that we had built wren houses wherever we made our own homes. My earliest recollection is a sad one—more significantly sad that I could know, when at the age of six, I mourned over the dead body of a passenger pidgeon, that my brother had shot in Indiana.

“In Greenwich (in 1905, I think), I fed the first starlings that braved the winter, though I had a presentiment of trouble for the native birds, for the starlings ate my suet in such enormous bites that I had to protect the chickadees and woodpeckers by hanging a special suet strip on an upright limb where the starlings could not perch.

“In Riverside the same family of downey woodpeckers have lived with us, winter and summer, for eight years. Robins nest in both porches, a catbird in a bush honeysuckle, song sparrows in the rose covered terrace, flickers, jays chipping sparrows, wrens, everything common and homelike, over all the acre, except the English sparrow.

“My cat never molests birds, nor allows another cat on the place. All winter there is suet in half a dozen places, and scattered feed under the south windows. Seven seasons of this have not ‘pauperized’ my bird neighbors, as the eighth winter showed. During the open winter (1914-'15), hardly a

bird except downeys came to my lunch table; but in the spring they returned in force to safe nesting sites within easy reach of the fresh filled bath tubs, and the bird population of Hillacre has reached high water mark this summer."

ANN DENNIS BURSCH.

How We Brought the Birds to "Casa Mia"

Four years ago the writer could identify few of the common birds, had never put up nesting boxes or fed birds in the winter time. This introduction is written to correct a general impression that success in bird study and attracting them about one's home calls for years of study and constant effort.

Aside from Sundays, holidays and the usual summer vacation, the writer has not been able to devote other time to bird study. A summary, therefore, of what he has accomplished may be of interest to those similarly placed.

Diligent search four years ago resulted in finding but twelve nests on the same area which this summer contained at least seventy-five. My recollection is that but four species were represented in the twelve nests, which have increased to twenty species this year.

Several types of nesting boxes were put up; the best results were had from Berlepsch boxes, purchased from the Audubon Bird House Company of Meriden, N. H. The martin house, one of twenty compartments, was made by Jacobs Bird House Company, Waynesburge, Pa., which the writer considers the best procurable.

Although well planted with trees and shrubs, the area under consideration lacks thick tangled growth of any kind. Of the ten acres, at least seven consist of closely cropped lawns and grass. To increase available nest sites, the stems of shrubs were tied, as suggested by Baron Von Berlepsch.

With the notable exception of the cat of the household, all stray felines were eliminated. The cat trap manufactured by the Society gave very satisfactory service.

Seven thousand English sparrows have been destroyed within the past four years, traps accounting for at least 6,000. Starlings and English sparrows have been kept from nesting boxes, but in a few instances a few occupied cavities made by flickers and downey woodpeckers.



These Chipping Sparrow Nestlings were Killed by a Cat



The following twenty-one species nested and reared their young during the summer just past:

Purple martin, tree swallow, flicker, bluebird, wren, chimney swift, robin, Baltimore oriole, orchard oriole, catbird, purple grackle, yellow warbler, brown thrasher, Northern yellow throat, bobolink, meadowlark, chipping sparrow, song sparrow, gold finch, English sparrow and starling.

Immediately outside the land under discussion the king bird, redwinged blackbird, downey woodpecker and pewee nested.

The only nest to my knowledge that contained a cowbird was destroyed by a cat.

During the summer of 1914 an albino cowbird was reared on the place by a pair of song sparrows.

For two winters, 1912 and 1913, a mocking bird visited our window lunch counter from January to March 15th.

The following species have also visited the same window shelf: Chickadees, downey woodpeckers, white breasted nuthatches, song sparrows, tree sparrows, starlings, juncos.

Purple finches and white throated sparrows have frequently visited our weather vane feeding table. Chickadees took sunflower seed from the hand at the window shelf.

No planting to furnish food and shelter for the birds has been done until now. This August over thirty evergreens were planted and later about 200 shrubs selected for their fruit will be set out.

The writer has come to the conclusion that birds will occupy boxes or posts exposed to nearly full sun, more readily than when they are placed on trees. He intends to try the experiment of placing partly decayed tree trunks eight feet above ground in situations close to growing trees, but not completely shaded by them, with a view of attracting downy woodpeckers and chickadees. For the latter's use a hole will be bored one and one-fourth inches in diameter as an invitation to complete the excavation to suit themselves.

This brief account shows what can be accomplished in a locality lacking woods and open country from which to draw the birds. To emphasize how quickly they discover a protected area, the writer would add that none of his immediate neighbors are engaged in this delightful pastime of attracting birds about the home.

Niel Morrow Ladd.

Greenwich Bird Day

September 29, 1915

AS this Year Book is being prepared with a view of disposing of a number of copies to those who attend the two performances of "Sanctuary, a Bird Masque," by Percy MacKaye, to be given on Bird Day, September 29th, no account other than the program for that day can be included. For the benefit of The Fairhope League and to awaken a greater interest in the cause of bird protection in Greenwich, the following elaborate program has been arranged for Bird Day.

2:30 P. M.—"Sanctuary," a Bird Masque, by Percy MacKaye, to be given by the Sanctuary Players on the grounds at Rosemary Hall.

4:00 P. M.—Lecture by Ernest Harold Baynes, entitled "How to Attract the Birds about the Home." Illustrated with Lantern Slides.

To be followed with Moving Pictures—
"The Egret Hunters."

The Court of the Birds

On view both afternoon and evening—a full description of which is given on other pages.

8:00 P. M.—Moving Pictures of "The Egret Hunters."

8:15 P. M.—"Sanctuary," as in the afternoon.

At the conclusion of "Sanctuary" a reception will be given the "Guests of Honor," followed by Refreshments and Ball.

Afternoon Prices \$1 Evening Prices \$3

Upwards of 120 men and women comprise the several committees working to make Bird Day a success from every viewpoint. The part of the program which pertains more particularly to bird protection will be the "Court of Birds." Great effort will be made to interest the boys and girls of the town, as will be seen by the generous prizes offered in the competitions.

THE COURT OF THE BIRDS.

One of the chief features of Bird Day will be the exhibit of bird houses, devices for winter feeding, bird baths, life histories of insect pests and their bird enemies, English sparrow traps and cat traps, and others implements of bird lovers.

A collection of colored lantern slides illustrating the conservation work of the Greenwich Bird Protective Society.

Leaflets and circulars telling how to attract and protect our native birds will be furnished for free distribution; also recently published books pertaining to this subject will be on sale at regular prices. Many other objects of interest, such as birds' nests, wild fruits which birds like, photographs, etc., will add to the educational value of "The Court of the Birds."

The Committee is also arranging competitions in connection with this exhibit:

Class 1. Adult Competitions.

Class 2. Junior Competitions.

All entries must be the work of the contestant. Name and address of contestant must be attached to each article entered.

Class 1.

Adult competitions open to all citizens of Greenwich over eighteen years old.

Lot 1.—Drawings, Paintings, Posters, etc.

1. Entries in this class may consist of sketches, water colors, crayon drawings, posters, bronzes or carvings.
2. They must depict or suggest birds or bird life in an attractive manner.
3. Awards will be determined by faithfulness to nature, attractiveness and artistic value.

First prize, \$5.00. Second prize, \$2.50. Third prize, Baynes' "Wild Bird Guests."

Lot 2.—Photographs.

1. Collection of photographs must contain six pictures or more of varying sizes or enlargements.
2. They must depict a natural phase of birds' life, such as perching, feeding or nesting, or they may show bird houses, nests or bird baths.
3. Not more than two photographs of birds' nests or bird houses should be in any one collection.

4. Any collection may include one photograph of a plant, shrub or tree especially attractive to birds.
5. Each photograph must be endorsed with the name of the subject, locality and any other data adding interest or value.
First prize, \$5.00. Second prize, \$2.50

Class 2.—Junior Competitions.

This class is open to boys and girls under eighteen years.

Compositions.

1. Each composition shall be an original record of personal observation of the life history and habits and characteristics of an individual bird or group of birds belonging to the following divisions:
 - (a) Weed seed eating birds, such as dove, sparrow, finch or lark;
 - (b) Insect eating, such as thrush, swallow, woodpecker or quail;
 - (c) Rodent destroying, such as owl, hawk or shrike.
2. Each essay must emphasize the economic value of the division selected.
3. Each must contain not less than 300 words nor more than 500 words.
4. Each composition must be accompanied by the name, age and address of the writer.
5. Essays will be judged by the following points: (a) originality, (b) accuracy of observation, (c) clearness of description, (d) interest of narrative and sympathy with the bird subject, (e) literary quality.
First prize, \$5.00. Second prize, \$3.00. Third prize, \$2.00.

Lot 2.—Bird Houses.

1. Any number of houses may be submitted.
2. They must be the work of the exhibitor, from his original designs.
3. Each must specify for which kind of bird it is intended, such as wren, swallow, bluebird, etc.
4. Directions as to suitable location and proper attachment for use must accompany each house.
5. Houses will be judged on the following points: Attractiveness, workmanship, suitability to birds' needs.
First prize, \$5.00. Second prize, \$3.00. Third prize, \$2.00. Fourth prize, \$1.00.

It is understood by contestants that all bird houses entered in competition shall become the property of the Greenwich Bird Protective Society, which will put them up throughout the township where they can be seen from the highroads.

BIRDS OBSERVED AT GREENWICH, CONN.

By Geo. W. Hubbell, Jr.

Birds marked * have been found nesting in Greenwich.
Those marked † have been found in the nesting season.

Horned Grebe	†Osprey
*Pied-billed Grebe	Short-eared Owl (dead body)
Loon	*Barred Owl
†Herring Gull	*Screech Owl
†Laughing Gull	Snowy Owl (reported 3 winters)
Common Tern	*Yellow-billed Cuckoo
American Merganser	*Black-billed Cuckoo
Redbreasted Merganser	*Belted Kingfisher
Mallard	†Hairy Woodpecker
*Black Duck	*Downy Woodpecker
Greater Scaupe Duck	Yellow-bellied Sapsucker
Lesser Scaupe Duck	Red-headed Woodpecker (reported nesting)
American Golden-Eye	*Northern Flicker
Bufflehead	†Whip-poor-will
Old Squaw	Night Hawk
White-winged Scoter	*Chimney Swift
Surf Scoter	*Ruby-throated Humming Bird
Canada Goose	*Kingbird
American Bittern	Arkansas Kingbird
Great Blue Heron	*Crested Flycatcher
*Little Green Heron	Phoebe
*Black-crowned Night Heron	Olive-sided Flycatcher
*American Woodcock	*Wood Pewee
Wilson's Snipe	Yellow-bellied Flycatcher
Semipalmated Sandpiper	Acadian Flycatcher
Solitary Sandpiper	Alder Flycatcher
*Spotted Sandpiper	*Least Flycatcher
Killdeer	*Blue Jay
*Bob White	*Crow
*Ruffed Grouse	*Starling
*Mourning Dove (rare, formerly abundant)	*Bobolink
†Marsh Hawk	*Cowbird
Sharp-shinned Hawk	*Red-winged Blackbird
*Cooper's Hawk	*Meadow Lark
Goshawk	*Orchard Oriole
†Red-tailed Hawk	*Baltimore Oriole
*Red-shouldered Hawk	Rusty Blackbird
*Broad-winged Hawk	*Purple Grackle
Rough-legged Hawk	Purple Finch
Bald Eagle	*English Sparrow
Pigeon Hawk	American Crossbill
†Sparrow Hawk	Redpoll

Birds Observed at Greenwich, Conn.—Continued

- | | |
|--|---|
| <ul style="list-style-type: none"> *Goldfinch Pine Siskin *Veener Sparrow Ipswich Sparrow †Grasshopper Sparrow †Seaside Sparrow White-throated Sparrow Tree Sparrow *Chipping Sparrow *Field Sparrow Slate-colored Junco *Song Sparrow Swamp Sparrow Fox Sparrow *Towhee Cardinal (dead body) *Rose-breasted Grosbeak *Indioo Bunting *Scarlet Tanager *Purple Martin *Cliff Swallow *Barn Swallow Tree Swallow (reported nesting) †Bank Swallow †Rough-winged Swallow †Cedar Waxwing Northern Shrike *Red-eyed Vireo *Warbling Vireo *Yellow-throated Vireo Blue-headed Vireo *White-eyed Vireo Black and White Warbler Worm-eating Warbler *Blue-winged Warbler Tennessee Warbler Northern Parula Warbler *Yellow Warbler Black-throated Blue Warbler | <ul style="list-style-type: none"> Myrtle Warbler Magnolia Warbler *Chestnut-sided Warbler Bay-breasted Warbler Black-poll Warbler Blackburnian Warbler Black-throated Green Warbler Pine Warbler Yellow Palm Warbler *Oven Bird Water Thrush *Louisiana Water Thrush *Maryland Yellowthroat *Yellow-breasted Chat *Hooded Warbler Wilson's Warbler Canadian Warbler *Redstart Mocking Bird *Catbird *Brown Thrush *House Wren Winter Wren †Long-billed Marsh Wren Brown Creeper *White-breasted Nuthatch Red-breasted Nuthatch *Chickadee Golden-crowned Kinglet Ruby-crowned Kinglet *Wood Thrush *Veery Gray-cheeked Thrush Olive-backed Thrush Hermit Thrush *Robin *Bluebird <li style="text-align: center;">Total, 160 species. |
|--|---|

Treasurer's Report

Annual dues.....	\$336.90	
Life members and patrons.....	485.00	
Sale of feeding devices, nesting boxes, etc.	359.23	
Sale of tickets for lecture....	172.60	
Subscriptions received for warden's salary	120.00	
	\$1,473.73	
Postage, stationery, circulars and leaflets.	\$215.10	
Warden's salary and horse.	283.00	
One-third cost of horse....	33.33	
Material and labor for feeding devices, nesting boxes, etc....	389.12	
Incorporating fee ..	13.50	
Buttons for Junior Members....	19.16	
Grain, etc., for winter feeding.....	24.00	
Expenses for two lectures.....	93.40	
Balance in bank.	332.02	
Amounts due ...	71.10	
	\$1,473.73	

E. A. WOOD,

Sept. 15, 1915.

Treasurer.

No account is taken of weathervane feeding tables presented to the schools, or devices used by our bird warden for winter feeding.

About \$100 worth of completed devices remain unsold

The following gentlemen have contributed to a special fund to be used wholly for protecting and feeding quail and other game birds :

Messrs. Roger Baldwin	John French
W. D. Baldwin	C. D. Lanier
R. C. Bolling	Niel Morrow Ladd
John N. Chapman	Tyler L. Redfield
E. C. Converse	Percy A. Rockefeller
A. L. Dommerich	William G. Rockefeller
Henry J. Fisher	Raymond B. Thompson

CONSTITUTION AND BY-LAWS
OF THE
Greenwich Bird Protective Society
(Incorporated)

ARTICLE I.

Name.

The name of the organization shall be The Greenwich Bird Protective Society, Incorporated.

ARTICLE II.

Objects.

The objects of this Society shall be the increase and protection of our native game and non-game birds, the stimulation of interest in bird life, and the gradual establishment of a model bird sanctuary.

ARTICLE III.

Membership.

Section 1. The membership of this Society shall consist of Associate Members, Active Members, Junior Members, Life Members, Patrons and Benefactors.

Section 2. Any person in sympathy with the objects of this Society, whether a resident of the town or not, may become an Associate Member by paying the prescribed dues.

Section 3. Any resident of the town of Greenwich may become an Active Member of this Society on election by the Executive Committee and payment of the prescribed dues.

Section 4. Any child under fourteen years of age may become a Junior Member of this Society on the payment of the prescribed dues for Junior Members.

Section 5. Any person in sympathy with the objects of this Society may become a Life Member, Patron, or Benefactor upon payment of the prescribed fee and upon election by the Executive Committee.

Section 6. The dues of an Associate Member shall be One Dollar, payable annually. The dues of an Active Member shall be Two Dollars, payable annually. The fee of a Life Member shall be Ten Dollars, payable at one time. The fee of a Patron shall be Twenty-five Dollars, payable at one time. The fee of a Benefactor shall be Five Hundred Dollars. The dues of a Junior Member shall be Ten Cents, payable annually.

Section 7. The voting power shall be limited to Active Members, Life Members, Patrons and Benefactors.

Section 8. A member may be expelled from the Society upon the written recommendation of any officer, by the majority vote of the members of the Executive Committee present at any meeting, provided notice of such action, with the reasons therefor, be presented to the member and to the Executive Committee at least one week before the meeting. Such member shall have the privilege to appear and to be heard by the Executive Committee.

ARTICLE IV

Government.

Section 1. The governing body of this Society shall consist of a Board of Governors of twenty one (21) persons, divided into three groups of seven (7) each, who shall have the general management and control of the affairs, funds and property of the Society. The tenure of office of the Governors shall be three (3) years, but only seven (7) Governors' terms can expire by limitation in any one year. At the Organization Meeting of the Board of Governors, the terms and groups of Governors shall be fixed, so that their terms shall be respectively for one, two or three years. Thereafter, at each Annual Meeting of the Society, seven (7) new Governors shall be elected by ballot of the majority of the Active Members present, due notice of such meeting having been given to all Active Members.

ARTICLE V

Amendments.

Amendments or alterations to the Constitution may be made by a two-thirds vote of the Active Members at any

Annual or Special Meeting, either in person or by written proxy, provided written notice of the proposed change shall have been furnished to the Secretary at least fifteen (15) days before the Meeting at which it is proposed to consider them; and the Secretary shall cause the same to be distributed to the Active Members at least seven (7) days before the Meeting.

ARTICLE VI.

By-Laws.

The Board of Governors shall have power to make and amend the By-Laws of the Society.

ARTICLE I.

Members.

Every applicant for membership other than Associate or Junior Member shall personally sign an application and must be proposed by a member and seconded by at least one member of the Society in good standing. At least one week before their election, the names of each applicant shall be forwarded to the Secretary. All applicants must receive the affirmative votes of five-sevenths of a quorum of the Board of Governors, but six adverse votes shall reject any candidate.

ARTICLE II.

Officers.

Section 1. The Board of Governors shall elect at its Annual Meeting, from its own members, by ballot and a majority vote, a President, four Vice-Presidents, a Secretary, a Treasurer, a General Manager, and five persons as a Committee on Membership.

Section 2. There shall be an Executive Committee, to consist of a President, General Manager and three Governors, to be appointed by the Board of Governors.

Section 3. Vacancies in the Board of Governors or in the Executive Committee shall be filled by the Governors at any special or regular meeting, and the person so elected shall serve for the balance of the unexpired term.

Section 4. At the Governors' Meeting next preceding the Annual Meeting of the Society, the Governors shall appoint

three (3) members, who shall present a list of candidates to be voted upon at the Annual Meeting, to serve on the Board of Governors in place of those whose terms shall expire. When the nominated committee shall have selected such a list, it shall deliver the same to the Secretary of the Society, who shall cause the same to be printed in at least one newspaper published in the Town of Greenwich, not less than ten (10) days before the date of the Annual Meeting.

Section 5. The Executive Committee shall have the power to appoint such standing or special committees as they, in their judgment, deem necessary and proper for carrying out the objects of this Society. The chairman of each of such committees shall be a member on the Board of Governors, and the balance of the committee may be taken from the general membership of the Society.

ARTICLE III. Duties of Officers.

Section 1. The duties of Officers shall be such as pertain to their respective offices in similar societies. The President shall be ex officio Chairman of the Board of Governors and of the Executive Committee.

Section 2. The Vice-Presidents shall perform the duties of the President, in his absence, in the order of seniority in office.

Section 3. The Secretary shall record the proceedings of the Society, of its Board of Governors and its Executive Committee, in books to be kept for that purpose; shall have charge of the records of the Society and of its publications; shall conduct the correspondence of the Society, and keep a record thereof; shall inform Members, Governors and Officers of their election; shall give notice of all meetings; shall inform Governors and Officers of all matters requiring their attention, and shall send to the Treasurer the names and addresses of all new members.

Section 4. The Treasurer shall receive all moneys of the Society, and shall deposit them in the name of the Society in such depositories as shall be approved by the Board of Governors; shall send to the Secretary, at least once a month, the names and addresses of all new members who have paid their

dues; shall furnish, at the request of the Executive Committee, a statement of the financial condition of the Society, and shall submit a financial statement to the Members at the Annual Meeting of the Society. He shall sign all checks and disburse the funds of the Society under the direction of the Board of Governors.

Section 5. The General Manager shall have general oversight of all the activities planned by the Society for carrying on its work as indicated in Article II of the Constitution.

ARTICLE IV.

Meetings.

Section 1. There shall be a regular meeting of the Society on the last Tuesday of February and on the last Tuesday of August. The last Tuesday of August shall be the date of the Annual Meeting. Notice of such regular meetings shall be published in at least one newspaper published in the town of Greenwich, and not less than ten (10) days prior to the date of the Annual Meeting.

Section 2. A notice of the Annual Meeting shall be mailed to each member not less than ten (10) days prior to such meeting.

Section 3. A special meeting may be called at any time on three (3) days' notice by the President of the Society, by the General Manager, or on a written application signed by three (3) members of the Executive Committee, or by fifteen (15) Active Members of the Society.

Section 4. Nine (9) members shall constitute a quorum at any meeting of the Society.

Section 5. Meetings of the Executive Committee may be held at such times as may be appointed by the President, or in his absence by the Secretary, and two (2) days' notice of each meeting shall be given. Three (3) members shall constitute a quorum.

Section 6. Meetings of the Board of Governors may be held at such times as may be appointed by the President, in his absence by the Secretary, and upon two (2) days' notice. Five (5) members constitute a quorum.

Members of the Greenwich Bird Protective Society

Patrons.

De Silver, Mrs. Carl H. Lauder, Jr., George
Everard, Mrs. Mary W.

Life Members.

Anderson, Mrs. A. A.	Johnston, Albert W.
Alexandre, Mrs. J. J., Stamford, Ct.	Ladd, Niel Morrow
Baldwin, Roger S.	Lanøeloth, Mrs. Jacob
Bolling, Mrs. R. C.	Lanier, Charles D.
Boyden, Wilson G.	Lincoln, Frederick W.
Chamberlain, Robert L.	Lockwood, Mrs. L. V.
Converse, E. C.	Look, Mrs. David M.
Cooper, A. Gardiner	McKinney, Miss Ethelyn
Decker, William F.	Nichols, Mrs. W. G., Rye, N. Y.
Dominick, Jr., George F.	Pauli, Mrs. Hermann
Doremus, F. S.	Pomeroy, Theodore L.
Edgar, Dr. J. Clifton	Rockefeller, Mrs. William G.
Fisher, Henry J.	Rosemary Hall (The)
French, John	Sargent, John
Greeff, Eno	Schierenberg, A.
Hamlin, Herbert W.	Schwarz, Henry F.
Harmon, Mrs. Clifford	Slawson, George L.
Highet, Frank B.	Smythe, D. Grahame
Hooker, E. H.	Spiekermann, Frank
Hooker, Mrs. E. H.	Thompson, Mrs. Helen A.
	Wood, E. A.

Active Members.

Adams, Jr., Mrs. H. H.	Clark, N. M.
Andrews, E. C.	Close, E. B.
Baker, Robert B.	Cowles, Russell A.
Barton, Nelson E.	Dominick, Jr., Mrs. Geo. F.
Baldwin, Mrs. Roger S.	Edwards, Duncan
Bennett, Mrs. Walter	Edwards, Mrs. Duncan
Bennett, Mrs. Walter M.	Fennessy, J. H.
Bird, E. Dimon	Field, Francis L.
Blake, Edward M.	Finch, W. E.
Brayton, H. R.	Folsom, Harry C.
Brush, Hamilton	Flinn, W. A.
Bordeaux, R. L.	Fitch, Miss Katherine E.
Bowen, Mrs. H. S.	Gibson, D. Walter
Buhler, Conrad	Gotthold, Mrs. Frederick
Bursch, Mrs. Frederick	Gotthold, Frederick
Camman, H. L.	Hoeninghaus, Fritz W.
Charman, Edwin N.	Hoggeson, Mrs. William J.

Members of the Greenwich Bird Protective Society—Continued

Active Members—Continued

Holden, Mrs. D. J.	Poucher, Frank C.
Houghton, A. S.	Powel, De Veaux
Hubbell, Jr., Geo. W.	Reynolds, Mrs. John L.
Huyler, Coulter D.	Ritch, Mrs. Wm. T.
Kelly, E. J., New York City	Robert, E. E.
Ladd, Mrs. Niel Morrow	Rockefeller, Godfrey
Leary, Miss Marie J.	Rockefeller, William
Lyons, W. F.	Rosenfeld, George
Macy, Nelson	Rowland, George
Maddison, W. H.	Rowland, Mrs. Grace Hubbell
Maples, James C., Portchester, N. Y.	Ruutz-Rees, Mrs. Janet
Maples, Miss Anna C., Portchester, N. Y.	Scott, Mrs. W. E. D.
Marble, W. E.	Seton, Ernest Thompson
Marble, Mrs. W. E.	Sewell, W. B.
McArdle, J. B.	Shoemaker, Henry W.
Mead, Edgar T.	Smith, F. St. George
Miller, Miss Bertha S.	Squier, W. C.
Monks, Richard A.	Sutton, Thomas G.
Montgomery, Chester	Thompson, Raymond B.
Moore, Eugene M.	Todd, Arthur S.
Morris, E. W.	Tuttle, F. B.
Newell, E. R.	Twachtman, Alden
Nichols, Morton C.	Temple, William H.
Nutting, A. J.	Talbot, William R.
Palmer, George B.	Tubby, W. B.
Palmer, F. T.	Thorp, Frank
Pell, R. J.	Thorp, Mrs. Frank
Pierce, Mrs. C. T.	Wills, E. C.
Pouch, Mrs. E. D.	Wertheim, Mrs. Maurice
	Wright, Miss Clara
	Zabriskie, Mrs. Alonzo

Associate Members.

Babst, E. D.	Dunton, Henry K., New York City
Banks, Miss Jessie	Dommerich, Mrs. A. L.
Bemis, Mrs. E. T.	Dominick, S. F.
Bouchelle, Miss Mary E.	Hoggson, MacLean
Butler, Mrs. A. W., Mt. Kisco, N. Y.	Hoyt, Miss Ida C.
Carson, Rev. Frank M.	Hoyt, Miss Mary W.
Carter, Charles H.	Hoyt, Mrs. John H.
Chapman, Mrs. John D.	Hubbard, Frank, New York City
Chapman, John D.	Hyde, Dr. F. C.
Ccuston, Alex.	Keen, Frank H.
Dell, Miss Beatrice	Mead, Charler N.
	Newton, Mrs. Charles P.

Members of Greenwich Bird Protective Society—Continued

Associate Members — Continued

Northrop, Mrs. Elizabeth	Stokes, Mrs. I. N. Phelps Stokes
Pynchon, George M.	Talbot, Mrs. S. C.
Pynchon, Mrs. George M.	Talbot, Miss Mary
Richardson, Albert L.	Talbot, Miss Susan
Rowland, Mrs. George	Ticknor, Caleb,
Shoemaker, Mrs. Henry W.	Great Barrington, Mass.
Stokes, I. N. Phelps	Walsh, Miss Emily G.

Junior Members.

Adams, Jr., Miss C. C.	Hooker, Miss Barbara
Adams, Jr., Miss Helen R.	Hooker, Miss Adelaide
Adams, Jr., Miss L. L.	Hooker, Miss Helen
Adams, Jr., Miss Mary	Huyler, Master
Anderson, Miss Bettie M.	Huyler, Miss Margaret
Brookfield, Miss Adele	Look, Master Samuel
Bolling, Miss Anna T.	Look, Miss Lydia
Bolling, Master R. Carter	Marble, 2nd, Master W. E.
Child, Miss Harriet	Palmer, Miss Florence K.
Child, Miss Elizabeth	Pouch, Miss Mary A.
Domminick, Jr., Miss Antoinette P.	Quackenbush, Miss Virginia
Domminick, Jr., Miss Lucy W.	Quackenbush, Master Gilbert
Domminick, 3rd, Master George F.	Richardson, Miss Elizabeth
DuBois, Master John D.	Rockefeller, Miss Almira
DuBois, Miss Marion S.	Rockefeller, Master Sterling
DuBois, Miss Dorothy	Rockefeller, Master Stillman
DuBois, Miss Nancy G.	Ruutz-Rees, Master Roland
Edwards, Miss Elizabeth	Rosenfeld, Miss Marjorie H.
Edwards, Miss Susan	Sargent, Miss Jean
Edwards, Miss Margaret	Slawson, Master G. Clarke
Edwards, Jr., Master Duncan	St. John, Master Orson
Gallaway, Miss Isabelle	St. John, Miss Louise
Gallaway, Miss Marion	St. John, Miss Margaret
Gibson, Miss Sallie	Stokes, Miss Helen
Harkness, Miss Mary	Talbot, Master John
Hartley, R. Wakeman	Young Miss Josephine
Hooker, Miss B. F.	

In Memorium

Seymour Hyde

Jacob Langeloth

James McCutcheon

Charles T. Wills



Price List of Articles

Manufactured and Sold by The
Greenwich Bird Protective Society



Bluebird Nesting Boxes, well-made, painted, easily cleaned	\$.75
Wren Nesting Boxes, well-made, painted, easily cleaned75
Wren Nesting Boxes, stained50
Cat Trap, well-made, painted, practical	3.50
Sparrow Trap, strongly made of half-inch galvanized wire-cloth, wooden bottom, painted	4.00
Suet Holder, made of half-inch galvanized wire-cloth25
Self-feeding Seed Hopper, well-made, paint- ed	1.00
Weather Vane Feeding Table, practical, well- made, painted, with 8-foot pole	4.00
Suspended Lunch Counter, contains suet holder and seed hopper, strongly made, with 50 feet of No. 8 galvanized wire	2.50

Prices are Net Carriage Extra

All articles made by the Society, as well as Berlepsch nesting boxes and other devices, can be seen at J. B. McArdle, the florist, on Greenwich Avenue. Orders sent direct to him will be promptly filled.

